

AGame™

Assembly Instructions & User's Manual

Rosemead Metal Playset

Style #: YSLAGOG0006

Model #: MSC-3782-BM

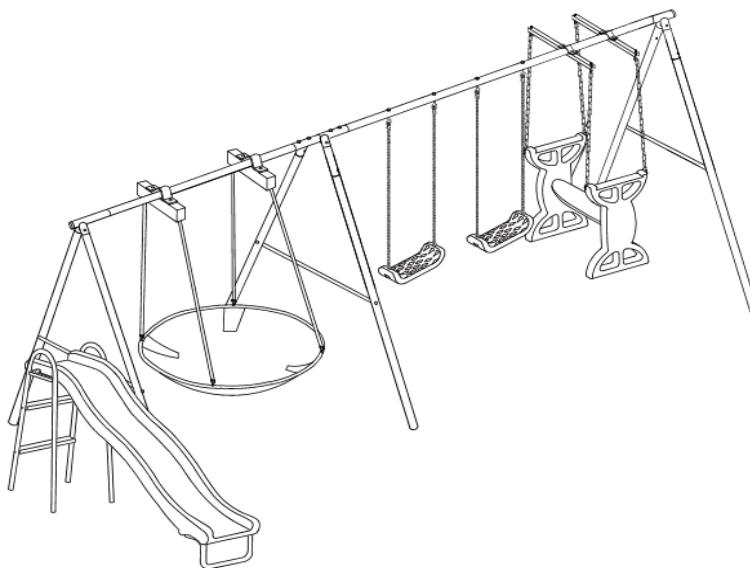

Please keep this instruction manual for future reference

For Customer Service please call 1-866-370-2131 or visit www.sportspowerltd.net

Monday – Friday 9:00 AM – 5:00 PM Eastern Time

-----OR-----

Customer Service: (888) 922-2336

7:00 am to 12:00 am CST (daily)

Live Chat at: www.academy.com

Email: customerservice@academy.com

(Made in China)

Dear Valued Customer,

Congratulations on your Sportspower play set purchase! Please read and completely understand the contents of this owner's manual. This manual contains specific instructions and warnings that must be followed to prevent injuries. This play set is for residential use only. This play set is NOT intended for public or commercial use. The warranty will be voided if the play set is used in a commercial application.

The product is designed for use by children between the ages of 3-8. Children must NOT play on this set until it is properly assembled and inspected by an adult. Adult supervision is required at all times while children are playing on the equipment. Do not allow children under six (6) years old to be near during the assembly of this product due to choking hazards of small parts.

The equipment must be installed on level ground. Uneven ground must be leveled prior to installation. Installation on sloping or uneven ground will put stress on the joints, causing the unit to become loose and unstable which may result in serious injuries. You must ensure there are no obstructions or structures (e.g. electrical wires, branches, house, fence, garage, etc) within six (6) feet from the equipment.

The Consumer Product Safety Commission's Outdoor Home Playground Safety Handbook recommends to install and maintain the playground equipment over at least 9 inches of wood chips, mulch or shredded rubber (for equipment up to 8 feet high) or sand or pea gravel (for equipment no more than 5 feet high) as shock absorbing material. Dirt and grass, which are the most prevalent surfaces under home playground equipment, do not adequately protect children from serious head injuries. Install protective surfacing at least six feet in all directions from play equipment. For swings, the surface should extend, in back and front, twice the height of the suspending bar. Do not install your play set over hard surface, e.g. asphalt, concrete, packed earth, tile or brick floor. Please refer to extracts from the CONSUMER PRODUCT SAFETY COMMISSION'S OUTDOOR HOME PLAYGROUND SAFETY HANDBOOK contained in this manual for further details. Do not allow children to use the product during windy or wet weather conditions. You should consult a local contractor about ways to anchor the product in your location.

The equipment must be checked before each use and maintained regularly. This includes, but is not limited to inspecting the play set for cracks, excess wear, missing parts, loose connections and for overall integrity. When the equipment shows any signs of weakness or damage, you must stop using the play set immediately, properly store the set or restrict access by users until the condition is resolved.

Your product is warranted against defects in material and workmanship. Extended warranty is also offered to those customers registering their products at www.sportspowerltd.net within 14 days from the date of purchase. Please refer to our warranty policy at the back of this manual for details.

If you experience any problems with your product, do not return to the store. For customer service, please call 1-866-370-2131 Monday-Friday 9:00am-5:00pm Eastern Time. If you are unable to reach us at this number for any reason, please visit www.sportspowerltd.net.

Table of Contents

Important Warnings and Instructions.....	3-6
Important Consumer Information Sheet.....	7
Anchoring.....	8-9
Care and Maintenance Checklist.....	10
Complete Product View.....	11
Tools.....	12
Parts and Hardware List.....	13-17
Assembly and Installation Instructions.....	18-33
Warranty Information.....	34

Note: Before beginning assembly of product, make sure all parts are present. Compare parts with package content list and hardware contents. If any part is missing or damaged do not attempt to assemble the unit. Contact customer service for replacement parts.

Important Warnings and Instructions

WARNING

READ ALL INSTRUCTIONS BEFORE ASSEMBLING OR USING THIS EQUIPMENT

AGE LIMIT

- This product is designed to be used by up to seven (7) children between the ages of 3 to 8. Maximum user weight is 100 pounds (45.4kg) each with a combined maximum weight of 700 pounds (317.5kg).
- The play set is designed for children over three (3) years of age. Use by smaller children can result in entrapment.
- On-site adult supervision is required at all times for children of all ages.
- Do not allow use by children with any physical condition that may affect his/her ability to use this equipment safely.

BEFORE YOU BEGIN

- Carefully read all instructions in this manual before assembling and using this product.
- The unit must be assembled by adults. Heavy duty working gloves must be worn to avoid injuries during assembly.
- Children must not use the equipment until it is properly assembled and anchored.
- Adult supervision is required during the use of this equipment at all times.
- Unpack all parts. Take a complete inventory of all parts and hardware using the parts and hardware lists in the following pages. If any parts are missing, do not return to the store. Please call customer service toll-free number listed on the cover page for assistance. Store the product back in the original box and do not begin to install until all parts are obtained.

LOCATION OF PLAY SET

- The equipment must be placed more than six (6) feet (1.8 meter) from any structures or obstructions, including but not limited to buildings, fence, garage, trees, laundry lines, electrical wires. Children can be seriously injured running or swinging into obstacles.
- The play set must be installed on level ground. Uneven ground must be leveled prior to installation. Installation on sloping or uneven ground will put stress on the joints, causing the unit to become loose and unstable which may result in serious injuries.
- Remove any tripping hazards from the safe play area, such as roots, tree stumps, rocks, landscaping, sprinkler heads, railroad ties, plumbing and electrical connections.

Important Warnings and Instructions

Do not install your play set over hard surface, e.g. asphalt, concrete, packed earth, tile or brick floor. A fall onto a hard surface can result in serious injury or death to the user. The following is a list of recommended ground covers from the Consumer Product Safety Commission:

<u>SUGGESTED MATERIAL</u>	<u>UNCOMPRESSED DEPTH</u>
Double Shredded Bark Mulch	9"
Uniform Wood Chips	12"
Fine Gravel	12"
Fine Sand	12"

The Consumer Product Safety Commission's Outdoor Home Playground Safety Handbook recommend to install and maintain the playground equipment over at least 9 inches of wood chips, mulch or shredded rubber (for equipment up to 8 feet high) or sand or pea gravel (for equipment no more than 5 feet high) as shock absorbing material. Dirt and grass, which are the most prevalent surfaces under home playground equipment, do not adequately protect children from serious head injuries. Install protective surfacing at least six feet in all directions from play equipment. For swings, the surface should extend, in back and front, twice the height of the suspending bar. You should consult a local contractor about ways to secure the product in your location. Do not install your play set over hard surface, e.g. asphalt, concrete, packed earth, tile or brick floor. Please refer to the CONSUMER PRODUCT SAFETY COMMISSION'S OUTDOOR HOME PLAYGROUND SAFETY HANDBOOK for detailed guidelines to prevent injuries from falls and other hazards on public and home playgrounds.

WARNINGS ON ANCHORING

It is highly recommended the product be anchored into the ground to prevent movement and to make the swing set more stable during use.

Some consumers want an anchoring system that allows the product to be moved to different locations. Other consumers want to keep their swing set in a permanent location.

There are different types and different methods of anchoring this product. Sportspower does not make a specific anchoring recommendation as each consumers need and conditions can vary.

It is highly recommended that you seek the opinion from a local licensed contractor on the best way to secure the swing set in your location. The best way to anchor a product is to create a concrete footing and use that as a base for an anchor. Whatever method you prefer for your location, an anchoring system for this product should be used at all times.

WEATHER CONDITIONS

- DO NOT use this equipment if the swing seat, slide or any parts are wet. Use the play set only when the parts are clean and dry. If the equipment is wet, the user could slip and suffer injuries.
- Please be aware of weather conditions when using the equipment. If it is too windy, users could lose control and suffer injuries. The playground equipment must be properly anchored, stored away or restricted from use during inclement weather such as heavy winds or severe weather storms. You should consult a local contractor about ways to anchor the product in your location.

PLAY SUPERVISION

- DO NOT allow more than one child to play on the individual swing or slide component at any one time. The maximum user limit for the flying saucer and glide ride is two persons.
- DO NOT allow children to stand on the slide, swing seats, flying saucer or glide ride.
- DO NOT allow children to walk too close to moving parts. ALWAYS keep a safe distance to avoid being struck by other children while playing on swings, slides, trampolines etc.

Important Warnings and Instructions

Observing the following statements and warnings reduces the likelihood of serious or fatal injury.

- DO NOT allow children to twist the swing chains or ropes, or loop them over the top support bar as this may reduce the strength of the chain or rope.
- DO NOT swing empty seats as this may cause injuries.
- ALWAYS guide children to sit in the center of swinging parts, with their full weight placed in the seat center and holding on to the swing chains.
- DO NOT allow children to jump off the equipment while it is in motion. ALWAYS come to a full stop before dismounting.
- ALWAYS dress children appropriately for proper play, e.g. wear well-fitted rubber sole shoes, and remove loose or sharp items such as jewelry, hair accessories, scarves which may become entangled in the equipment or cause injuries.
- ALWAYS make sure children remove their bike or other sports helmets before playing on the playground.
- DO NOT allow children to slide down the slide head first.
- DO NOT allow children to climb onto swing or jump to/from different play areas of the equipment.
- ALWAYS return safely to the ground before approaching another play area.
- DO NOT allow children to climb on structural parts (e.g. legs, top bar). These are structural components and are not designed for play.
- ALWAYS check the slide or other parts exposed to the body for extreme heat from the sun before allowing children to use the equipment.
- DO NOT allow children to use the equipment in a manner other than intended.
- ALWAYS prevent access and secure from any unauthorized use when there is no adult supervision.
- DO NOT allow pets or other animals near the equipment to prevent damage or injuries.
- On-site adult supervision for children of all ages is recommended

INSPECTION PRIOR TO EACH USE OR DAILY INSPECTION

- DO NOT use the equipment if any bolts or nuts are missing or loose. ALWAYS check to ensure the equipment and all parts are well secured and stable before each use.
- ALWAYS clear the play area of any rocks, sharp objects, or any materials that could be potentially hazardous to users.
- DO NOT attach items to the equipment that are not specifically designed for use with the equipment, including, but not limited to, jump ropes, clothesline, pet leashes, cables and chains as they may cause choke hazards.
- The steel and plastic parts used in your product are subject to normal wear. Gradual deterioration of the material will occur, the speed of which will depend on the level of exposure to UV rays, airborne pollution, outdoor weather conditions such as rain and wind and the amount of use. You must inspect the equipment prior to every use. This includes, but is not limited to inspecting the set for cracks, excess wear, missing parts, loose connections, and for overall integrity. When the set shows any signs of weakness, you must stop using the play set immediately, properly store the set or restrict access by users until the condition is resolved.
- Verify that the suspended climbing ropes, chain or cable are secured at both ends and tightened, so that there is no loose ropes, chain or cable hanging that can result in choking hazard.

When conducting inspections, it is recommended that you use the Suggested General Maintenance Checklist and Routine Inspection and Maintenance Issues checklists provided by the US Consumer Product Safety Commission, a copy of which is contained in this user manual.

Important Warnings and Instructions

CARE & MAINTENANCE INSTRUCTIONS

- Inspect all nuts and bolts twice monthly during the usage season for tightness and tighten as required. It is particularly important that this procedure is followed at the beginning of each season.
- Oil all metallic moving parts monthly during the usage period.
- Sand rusted areas on metal tubing and repaint using a nonlead-based paint meeting the requirements of Title 16 CFR Part 1303.
- Check swing seats, ropes, cables and chains monthly during usage season for deterioration. Replacements should be made in accordance with the manufacturer's instructions.
- Check all coverings for bolts and sharp edges twice monthly during usage season to be certain that they are in place and replace when necessary. It is especially important to do this at the beginning of each new season.
- Do not use when the temperature drops below 32 degrees F (0 degrees C); remove and store the plastic swing seats and slides indoors.
- Owners shall be responsible for maintaining the legibility of the warning labels.

Important Consumer Information Sheet

The Consumer Product Safety Commission estimates there are more than 200,000 playground related injuries involving children each year. Injuries involving this hazard pattern tend to be among the most serious of all playground injuries and have the potential to be fatal, particularly when the injury is to the head. The surface under and around playground equipment can be a major factor in determining the injury-causing potential of a fall. It is self evident that a fall onto a shock absorbing surface is less likely to cause a serious injury than a fall onto a hard surface. Playground equipment should never be placed on hard surfaces such as concrete or asphalt and while grass may appear to be acceptable it may quickly turn to hard packed earth in areas of high traffic. Shredded bark, mulch, wood chips, fine sand or fine gravel are considered to be acceptable shock absorbing surface when installed and maintained at a sufficient depth under and around playground equipment. Table below lists the maximum height from which a child would not be expected to sustain a life-threatening head injury in a fall onto four different loose-fill surfacing materials if they are installed and maintained at depths of 6" (15.3 CM), 9" (22.9 CM), and 12" (30.5 CM).

FALL HEIGHT IN FEET FROM WHICH A LIFE THREATENING HEAD INJURY WOULD NOT BE EXPECTED			
TYPE OF MATERIAL	6" (15.3 CM) DEPTH	9" (22.9 CM) DEPTH	12" (30.5 CM) DEPTH
Double Shredded Bark Mulch	6" (15.3 CM)	10" (25.4 CM)	11" (27.9 CM)
Wood Chips	6" (15.3 CM)	7" (17.8 CM)	12" (30.5 CM)
Fine Sand	5" (12.7 CM)	5" (12.7 CM)	9" (22.9 CM)
Fine Gravel	6" (15.3 CM)	7" (17.8 CM)	10" (25.4 CM)

However, it should be recognized that all injuries due to falls cannot be prevented no matter what surfacing material is used. We recommend that a shock absorbing material should extend a minimum of 6ft in all directions from the perimeter of stationary equipment such as climbers and slides. However, because children may deliberately jump from a moving swing, the shock absorbing material should extend in the front and rear of a swing a minimum distance of 2 times the height of the pivot point measured from a point directly beneath the pivot on the supporting structure.

This information is intended to assist in comparing the relative shock-absorbing properties of various materials. No particular material is recommended over another. However, each material is only effective when Properly maintained. Materials should be checked periodically and replenished to maintain correct depth as determined necessary for your equipment. The choice of a material depends on the type and height of the playground equipment, the availability of the material in your area and its cost.

Note: The maximum fall height for this product is 6 feet. The minimum ground clearance between the bottom of the suspended plays and the playing or ground service must be 8 inches.

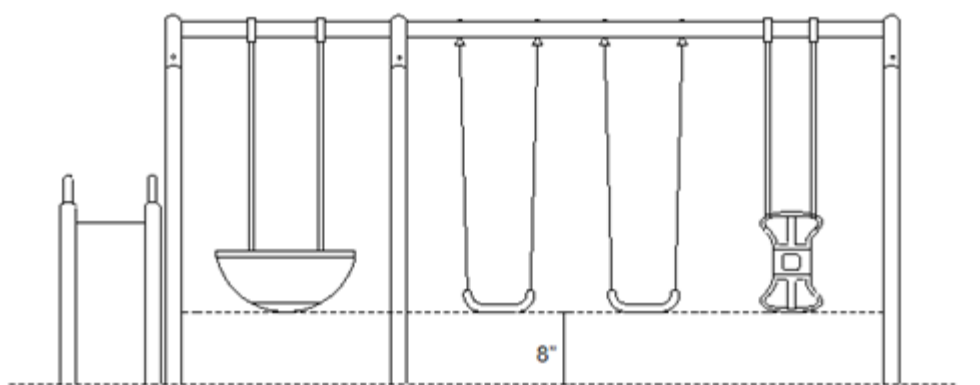

This information has been extracted from the CPSC publication on "Playground Safety". You can obtain more information by sending a postcard to the: Office of public Affairs, U.S. Consumer Product Safety Commission Washington, D.C. 20207

Anchoring

(NOTE: ANCHORS ARE NOT INCLUDED-MUST BE PURCHASED SEPARATELY)

There are different ways of anchoring the equipment, depending on the type of ground on which the equipment is to be installed. Make sure that all anchors are below ground level to prevent tripping.

You should consult your local contractor to decide the most appropriate way to anchor the equipment in your location.

The following anchoring options may be considered:

Corkscrew Anchoring (Corkscrew Anchors not included)

- If your soil is hard (clay, etc.), the corkscrew method may be suitable.
- Be sure that the swing set is located on level ground.
- Twist the corkscrew anchor into the ground until only the end with the hook is above the ground and next to the leg. Insert the hook into the bottom opening of the leg. Ensure that the hook is secured onto the leg opening.

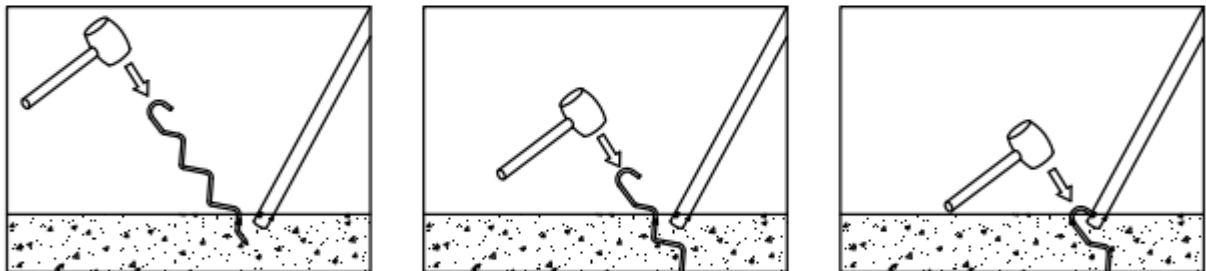

Concrete Anchoring (Materials not included)

- If the swing set is set up on grounds with sandy soil (soft) condition, it must be anchored with concrete footing (concrete not included)
- Be sure that the swing set is assembled and placed on level ground
- Dig holes around swing leg tube, as shown in drawing in the next page. As you dig deeper, enlarge the diameter of the hole to fix the cement
- Place 2 inches of brick or gravel underneath the leg, as shown in drawing in the next page
- Use about 45 lb. of concrete per leg
- Cover the concrete with dirt and protective surface material
- Allow 6-7 days for the concrete to dry properly

Anchoring

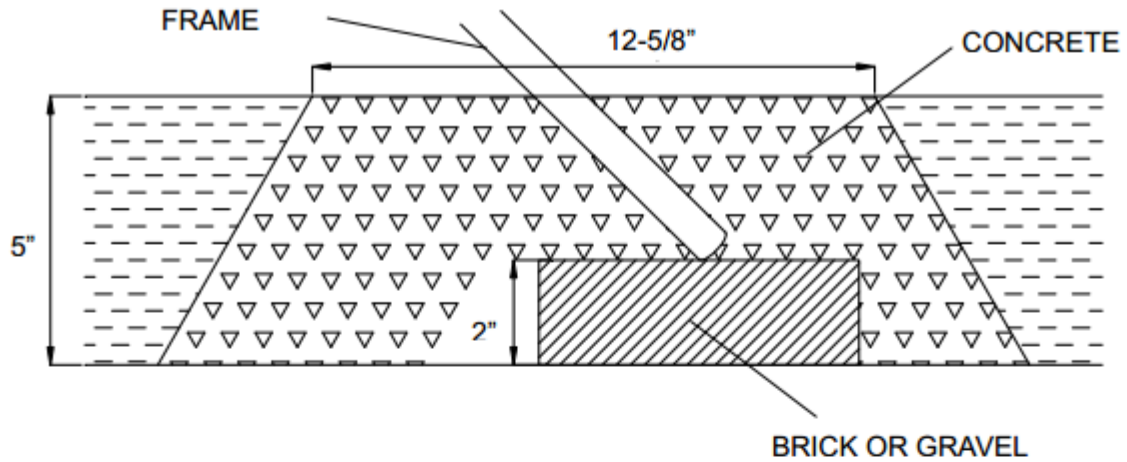

Note: The maximum fall height for this product is 6 feet. The minimum ground clearance between the bottom of the suspended plays and the playing or ground surface must be 8 inches.

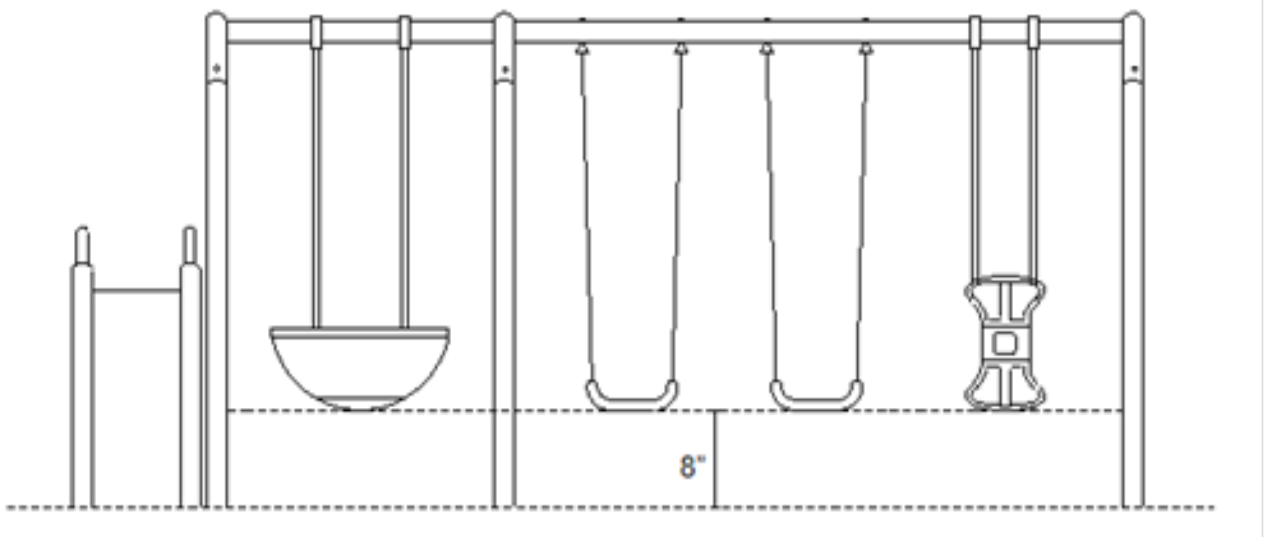

⚠ WARNING

Please properly anchor the swing set to minimize the risk of injury or death. If the swing set is used without proper anchoring, it may be dangerous and may tilt over.

Care and Maintenance Checklist

AT THE BEGINNING OF EACH PLAY SEASON:

- Tighten all hardware.
- Lubricate all metallic moving parts per manufacturer's instructions.
- Check all protective coverings on bolts, pipes, edges, and corners. Replace if they are loose, cracked, or missing.
- Check all moving parts including swing seats, ropes, cables and chains for wear, rust or other deterioration. Replace as needed.
- Check metal parts for rust. If found, sand and repaint using a non-lead paint meeting the requirements of 16 CFR 1303.
- Reinstall any plastic parts, such as swing seats or any other items that were removed for the cold season.
- Rake and check depth of loose fill protective surfacing materials to prevent compaction and to maintain appropriate depth. Replace as needed.

TWICE A MONTH DURING PLAY SEASON:

- Tighten all hardware.
- Check all protective coverings on bolts, pipes, edges and corners. Replace if they are loose, cracked or missing.
- Rake and check depth of loose fill protective surfacing materials to prevent compaction and to maintain appropriate depth. Replace as needed.

ONCE A MONTH DURING PLAY SEASON:

- Lubricate all metallic moving parts per manufacturer's instructions.
- Check all moving parts including swing seats, ropes, cables and chains for wear, rust or other deterioration. Replace as needed.
- Rake and check depth of loose fill protective surfacing materials to prevent compaction and to maintain appropriate depth. Replace as needed.

AT THE END OF EACH PLAY SEASON:

- At the end of each play season or when the temperature drops below 32 degrees F (0 degrees C).
- Remove plastic swing seats and other items as specified by the manufacturer and take indoors or do not use.
- Rake and check depth of loose fill protective surfacing materials to prevent compaction and to maintain appropriate depth. Replace as needed.

As a general rule, maintenance should be performed at any time it is deemed necessary.





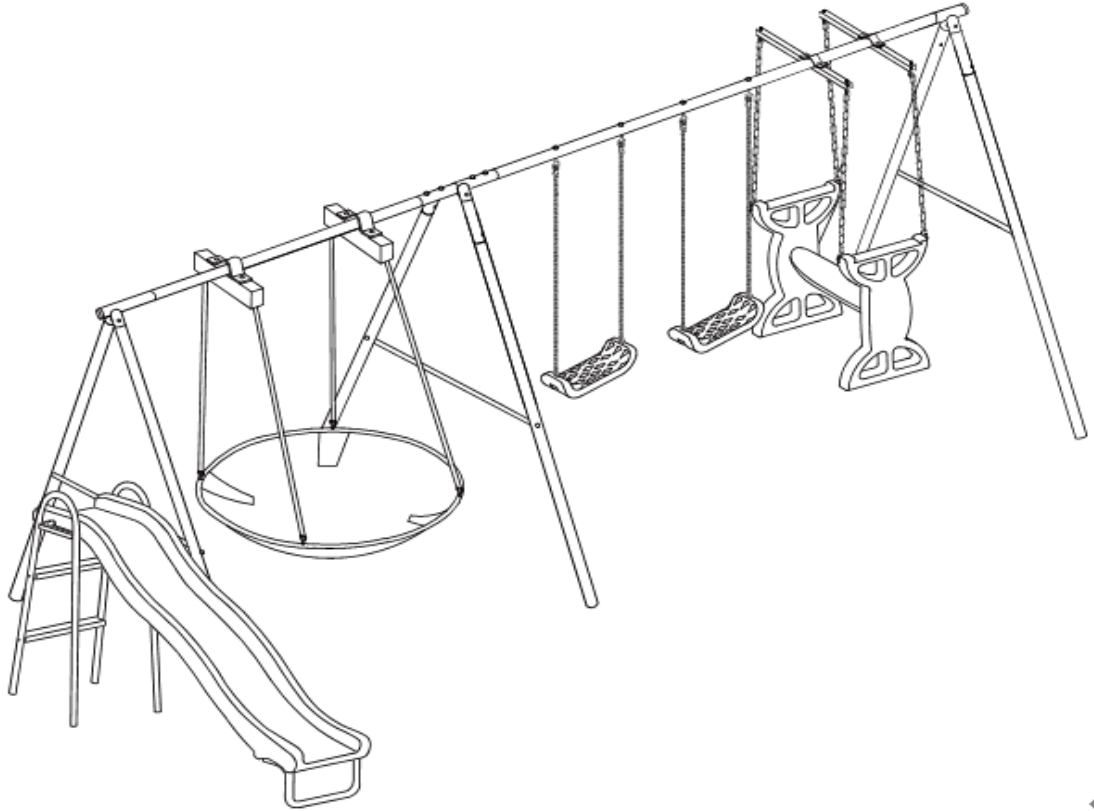

DISPOSAL INSTRUCTIONS

- Please use care when disassembling the equipment, when it is no longer in operational condition. Wear heavy duty working gloves to avoid injuries.
- Fully disassemble the entire swing and slide sets before disposal. Do not leave partially disassembled parts in areas accessible by children.
- Should you wish to recycle the steel tubing, please take the frame to your local recycling center.
- All plastic parts can be recycled, take it to your local recycling center. Do not let children play with any disassembled parts meant for disposal, such as chains, slide, tubing, bolts, nuts, screws, etc.
- All rusted parts, bolts must be properly disposed of in trash bin. Do not reuse.





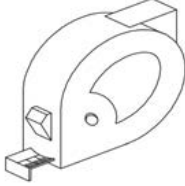

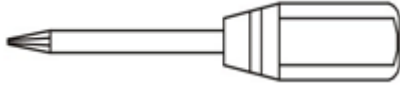
Complete Product View



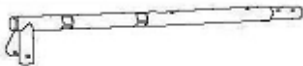
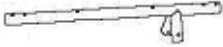

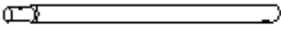

Tools Required

	Wrench (Included)	
	Big Allen Wrench (Included)	
	Wrench (Included)	
	Special Socket Wrench (Included)	
	Medium Allen Wrench (Included)	
	Tape Measure (Not Included)	
	Hammer (Not included)	
	Flat Head and Phillips Head Screwdriver (Not included)	





Parts List – Swing Set Frame

A1		LEFT TOP BAR	1
A2		MIDDLE TOP BAR	1
A3		RIGHT TOP BAR	1
A5		LEG	6
A6		CROSS BAR (WITH TWO HOLES)	2
A7		CROSS BAR (WITH FOUR HOLES)	1
C2		END CAP (PRE-ASSEMBLED)	2





Hardware – Swing Set Frame

B1		BOLT 5/16"*2.5" (8MM*64MM)	16
B3		NYLON NUT 5/16"	16
B4		PLASTIC CAP (WITH ARC WASHER)	16
B5		5/16" ARC WASHER	10
B6		5/16" WASHER	6

Parts List – Glider

L1		LEG-GLIDE RIDER	2
L2		SEAT-GLIDE RIDER	1
J2		PVC COVERED CHAIN (PRE-ASSEMBLED)	4
J3		EYE BOLT WITH ATTACHMENT BOLT (PRE-ASSEMBLED)	4
J4		EYE BOLT (PRE-ASSEMBLED)	4



Bracket - Glider

R3		BRACKET	2
R8		BRACKET CLAMP	2
L5		WASHER(5/16")	4
N3		BOLT 5/16"×83MM	4
N7		NYLON NUT 5/16"	8



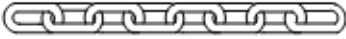

Hardware - Glider

N8		BOLT 1/4"×60MM	4
N9		BOLT 1/4"×148MM	2
N10		NYLON NUT 1/4"	6
N11		PLASTIC CAP (WITH LARGE WASHER)	8
N12		WASHER (1/4")	12







Parts List – Swing Seat

J1		PVC COVERED CHAIN (PRE-ASSEMBLED)	4
J3		EYE BOLT WITH ATTACHMENT BOLT (PRE-ASSEMBLED)	8
K1		SWING SEAT	2





Hardware – Swing Seat

J6		NYLON NUT 5/16"	8
J7		5/16" WASHER	4
J8		PLASTIC CAP (WITH ARC WASHER)	4
J9		PLASTIC CAP (WITH LARGE WASHER)	4







Parts List – Flying Saucer

R1		PVC COVERED CHAIN (PRE-ASSEMBLED)	4
R2A		LONG EYE BOLT WITH CHAIN (PRE-ASSEMBLED)	4
R2B		SHORT EYE BOLT WITH CHAIN (PRE-ASSEMBLED)	4
R3		BRACKET	2
R4		FLYING SAUCER TUBE	4
R7		FLYING SAUCER	1
R8		BRACKET CLAMP	2











Hardware – Flying Saucer

F1-1		BOLT 3/8" x 3.35" (9.5mm x 85mm)	4
F2		REINFORCING STEEL SPACER	8
F3		NYLON NUT 3/8" (9.5mm)	12
F4		ARC WASHER 3/8" (9.5mm)	4

Parts List – Slide

X1-N		SLIDE SUPPORT (WITH OPENING)	1
X2-N		SLIDE SUPPORT	1
X3-N		SLIDE LEG TUBE	2
X4-N		SLIDE TOP SUPPORT BAR	1
X5-N		SLIDE FRONT SUPPORT	1
X6		SLIDE LADDER STEPS	2
Y2		SLIDE	1

Hardware – Slide

Y1		PLASTIC CONNECTOR	2
Z1		BOLT 1/4" x 38mm	2
Z2		BOLT 1/4" x 115mm	2
Z3		SPRING WASHER (LARGE)	4
Z4		CAP NUT 1/4"	6
Z5		CAP BOLT 1/4" x 14mm	4
Z6		SPRING WASHER (MEDIUM)	20
Z7		BOLT 1/4" x 75mm	2
Z8		BOLT 1/4" x 36mm	4
Z9		BOLT 1/4" x 46mm	4

Assembly Instructions

STEP 1 – Assemble Top Bar of Swing Set Frame

- Connect A1, A2 and A3; secure with B1, B5, B4 and B3.

Note: Please make sure that concave holes face down and round holes face up.

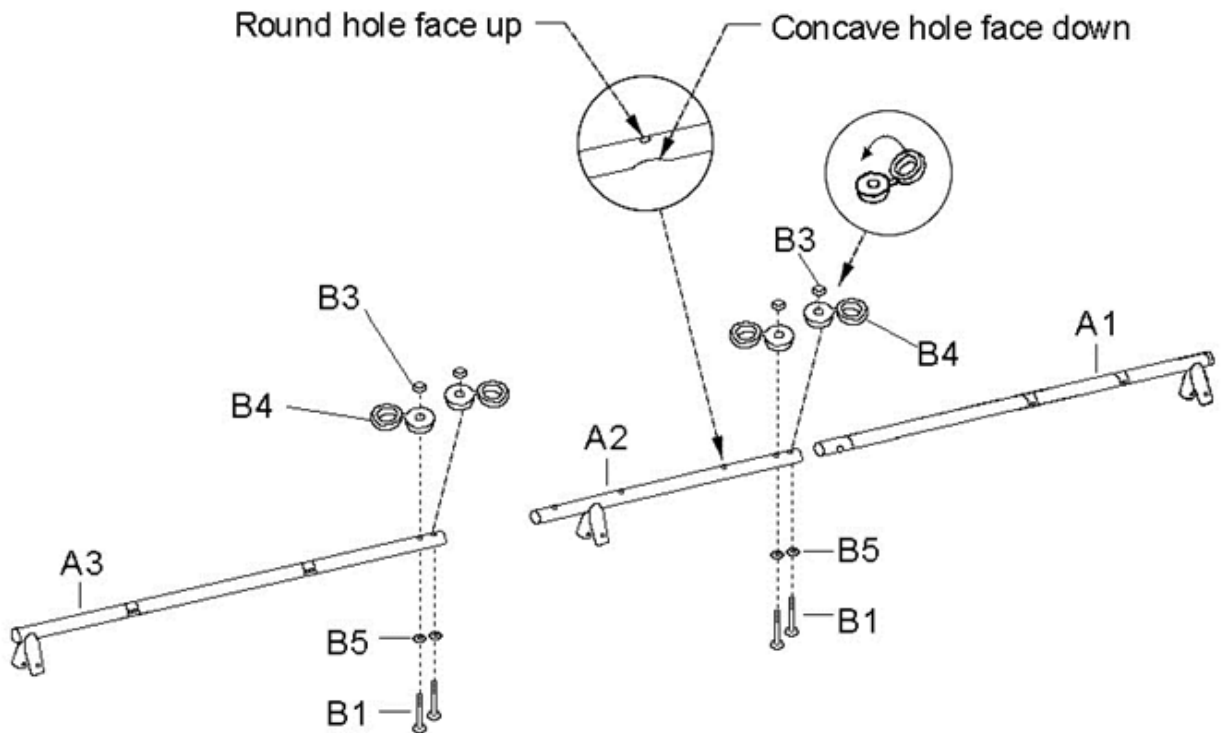

Assembly Instructions

Step 2 – Assemble Support Legs of Swing Set Frame

- Insert small end of A5 into the sockets at the end of A3.
- Align the holes and secure using B1, B5, B4 and B3.
- Repeat the same process for all six legs:

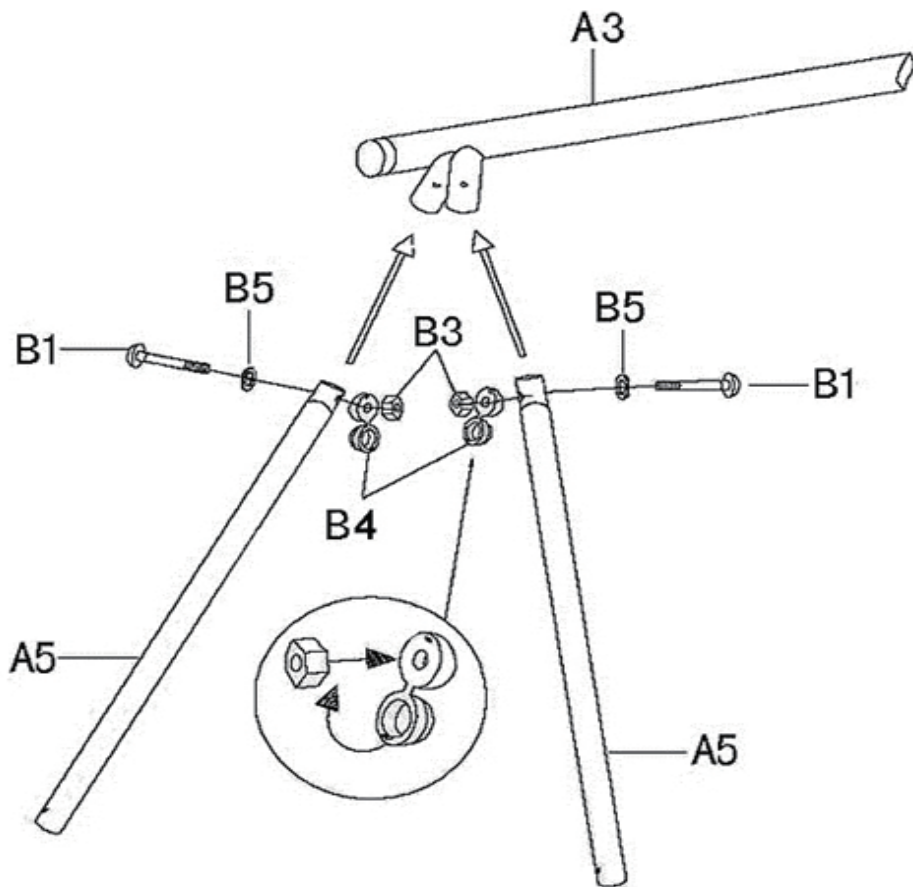

Assembly Instructions

STEP 3 – Assemble Cross Bar to Support Legs

- Attach A7 to A5. Secure using B1, B6, B4 and B3.

IMPORTANT: A7 will be used for connection to the slide in later steps. Please ensure the two extra holes are positioned towards the front of the swing set (i.e. where the slide will go down). This is important to avoid risk of entrapment.

- Repeat the same process for attaching A6 to the other support legs.

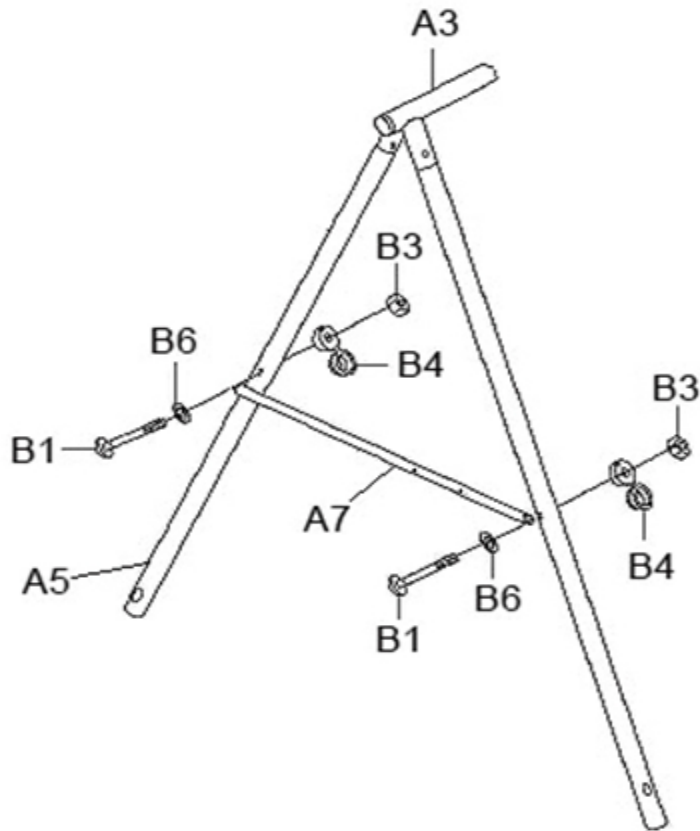

Assembly Instructions

STEP 4 –Assemble Bracket for Glide Ride

- Attach R8 and R3 to A1; secure using N3, L5, N11 and N7 as shown.
- Use special socket wrench and screwdriver to tighten.

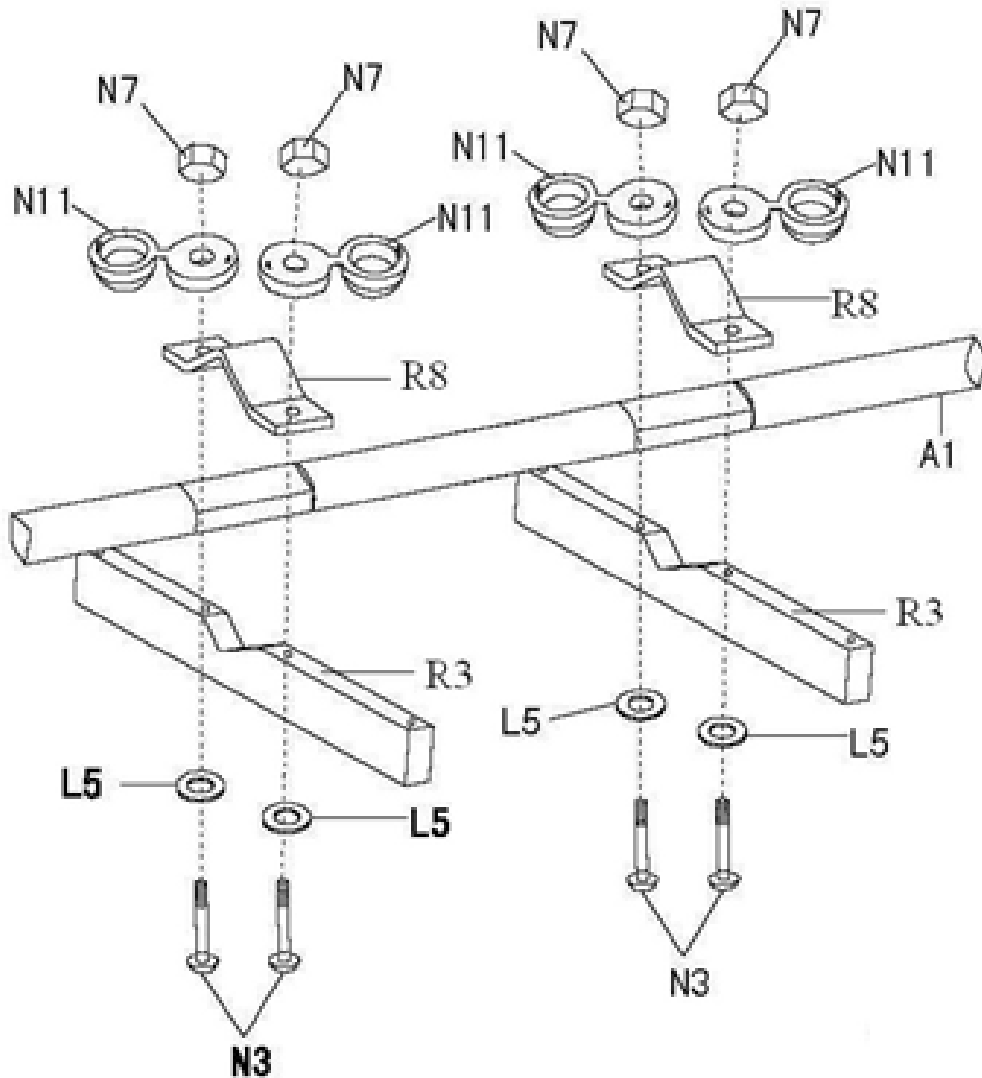

Assembly Instructions

STEP 5 – Assemble Chains to Bracket for Glide Ride

- Insert J3 into holes on R3 and secure with N7, N11.
- Repeat the same process for all four chains.

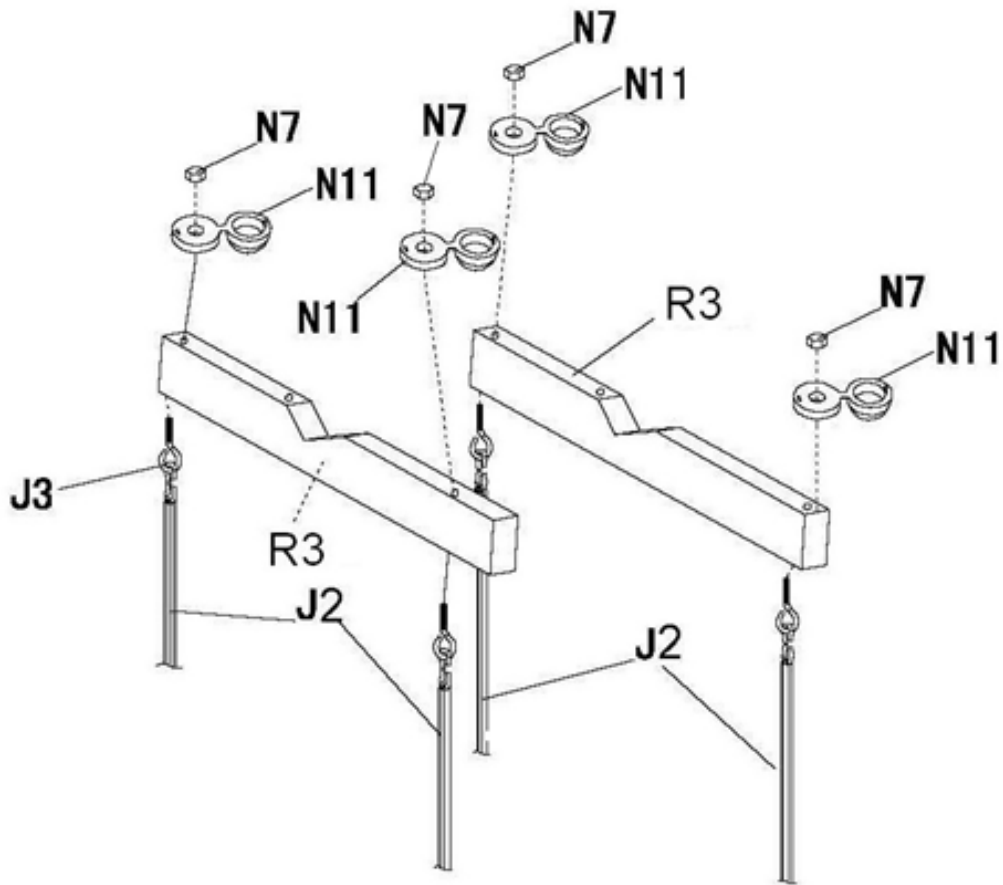

Assembly Instructions

STEP 6 –Assemble Glide Ride

- Place L2 between L1 and secure with N9, N12 (2) and N10 as shown.

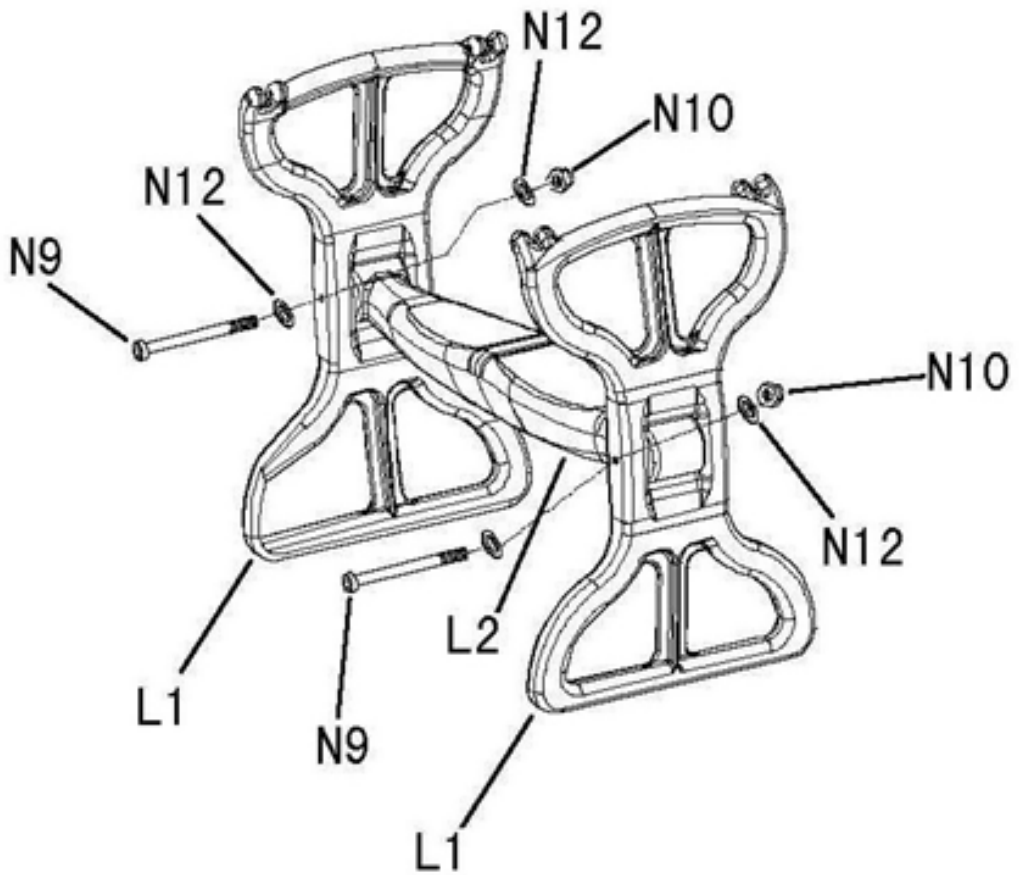

Assembly Instructions

STEP 7 –Connect Chain to Glide Ride

- Insert J2 hook end into holes on L1.
- Secure with N8, N12 (2) and N10 as shown.
- Repeat the same process for all four chains.

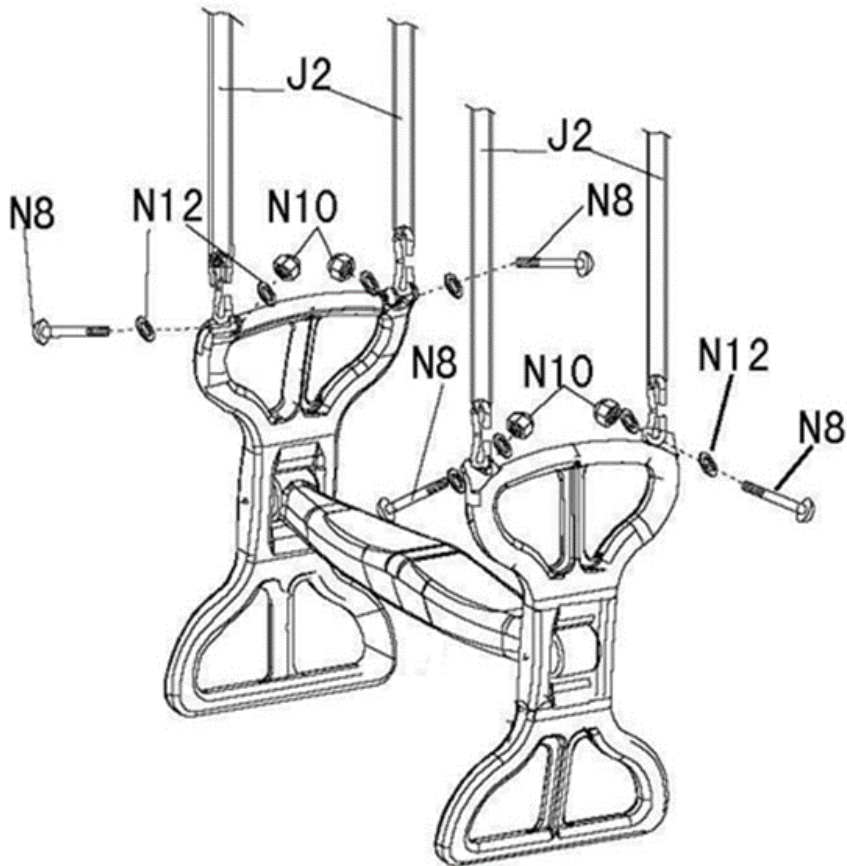

Assembly Instructions

STEP 8 –Assemble Chain of Swing seats

- Insert J3 into holes on A1 and secure with J8, J6.
- Repeat for the two chains on A2.

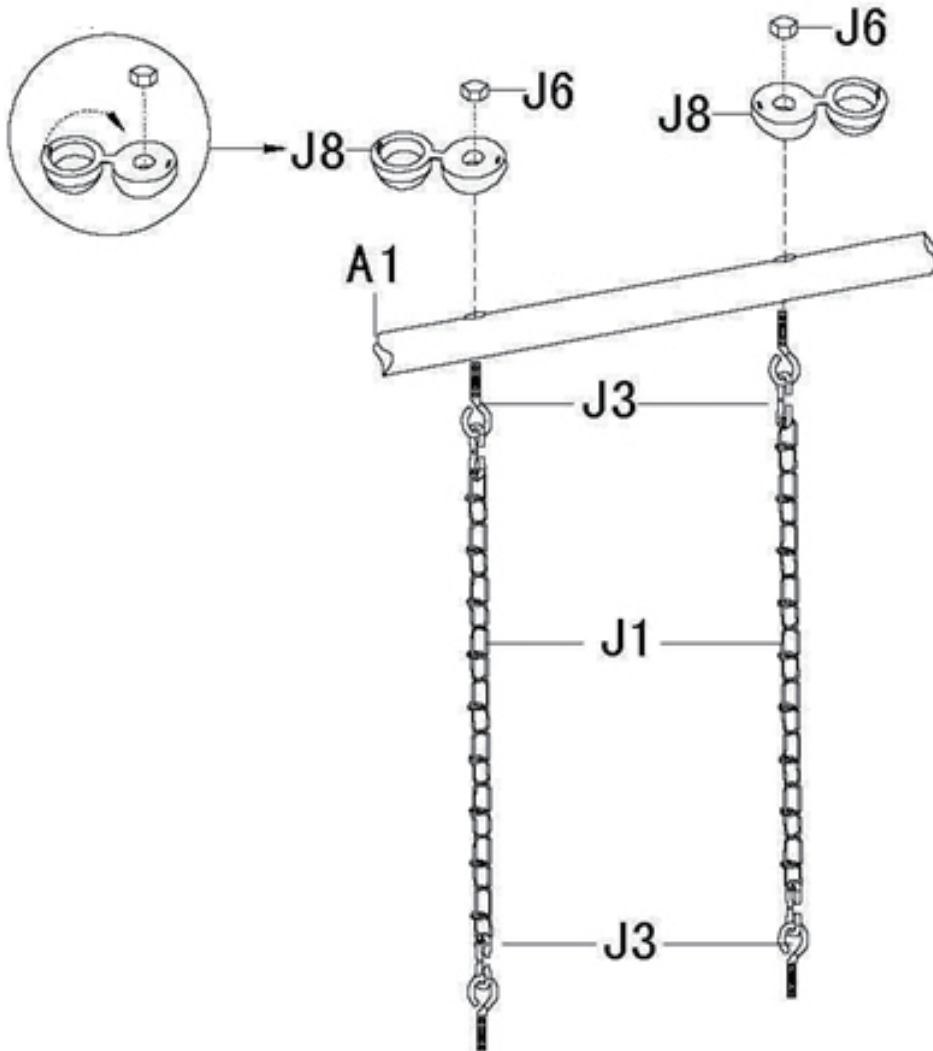

Assembly Instructions

STEP 9 –Connect chain to swing seats

- Insert J3 through K1 and secure with J7, J9 and J6.
- Repeat the same process for both swing seats.

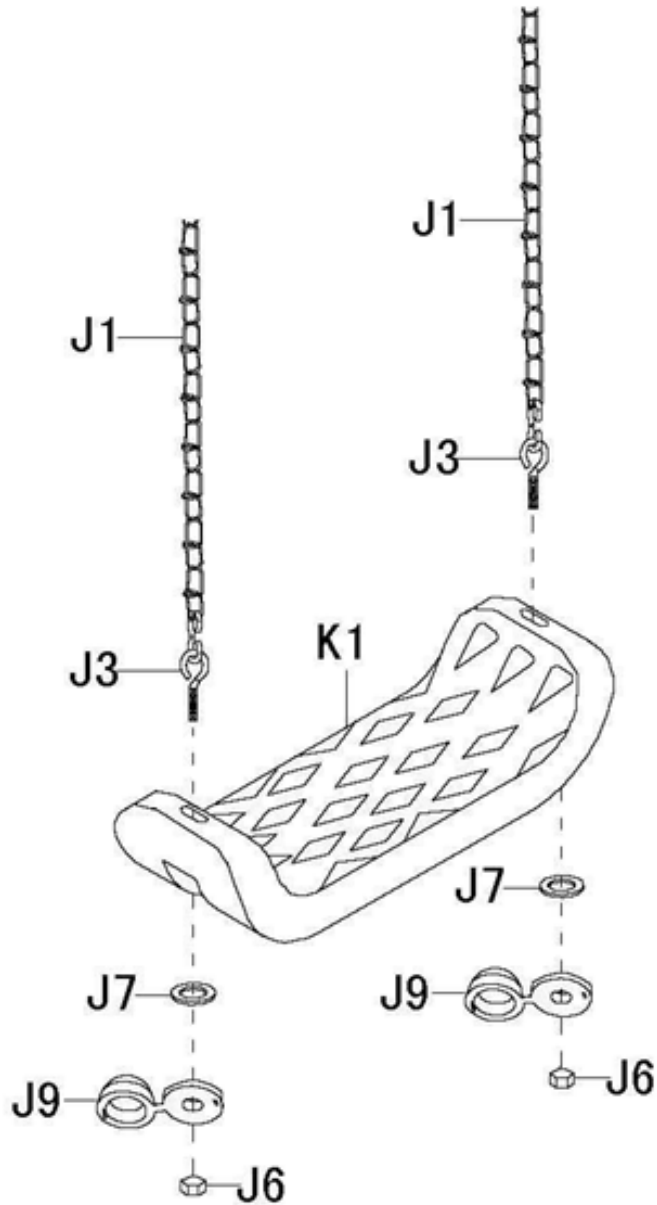

Assembly Instructions

STEP 10 – Flying Saucer Assembly

- Slide the smaller ends of R4 tubes into the pockets of Flying Saucer (R7) with the round holes facing down. Connect the four tubes together and align the holes.
- Connect the chain (R1) to the flying saucer by inserting R2B (shorter screw); secure with F4 and F3 as shown below.

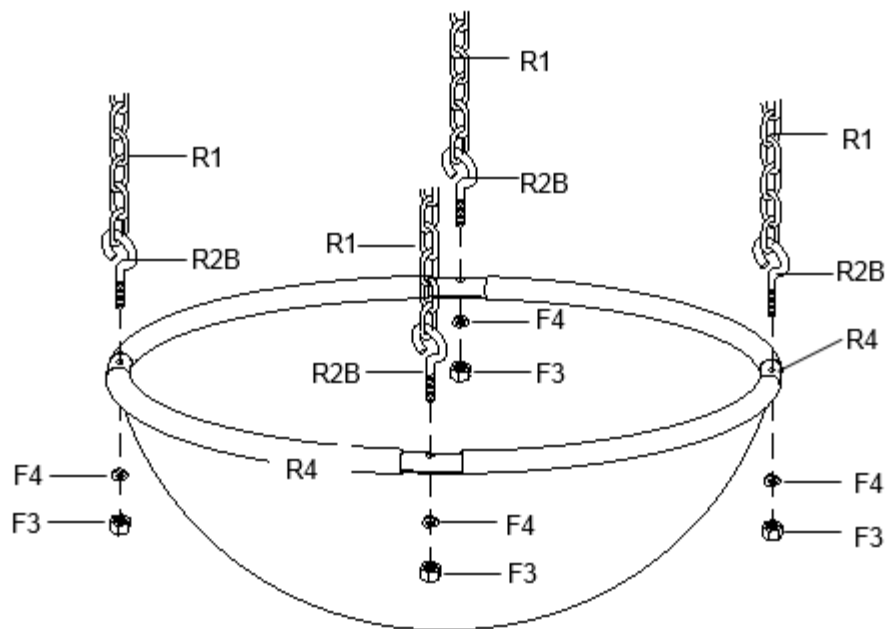
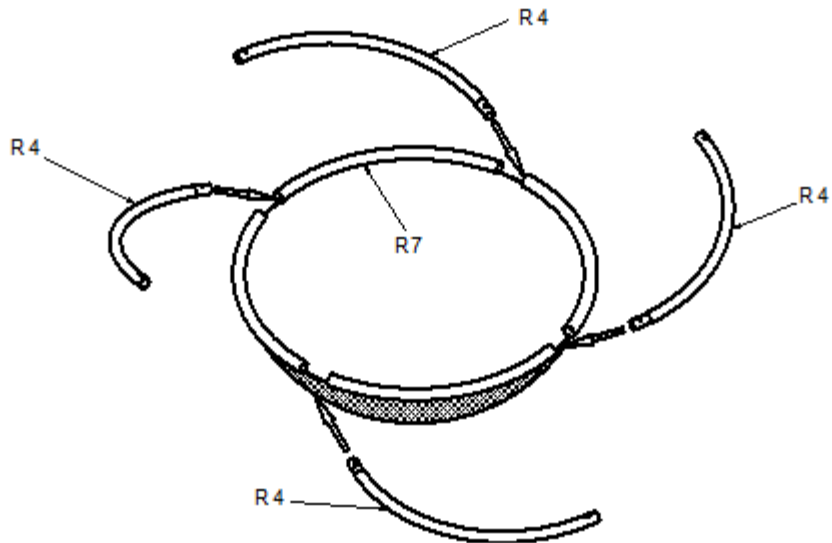

Assembly Instructions

STEP 11 – Attach Flying Saucer to Swing Set Frame

- Attach R8 and R3 to the top bar A3 using F1-1, F2 and F3 as shown in Diagram A.
- Insert R2A (pre-assembled with R1) into R3 and secure with F2 and F3 as shown in Diagram B.

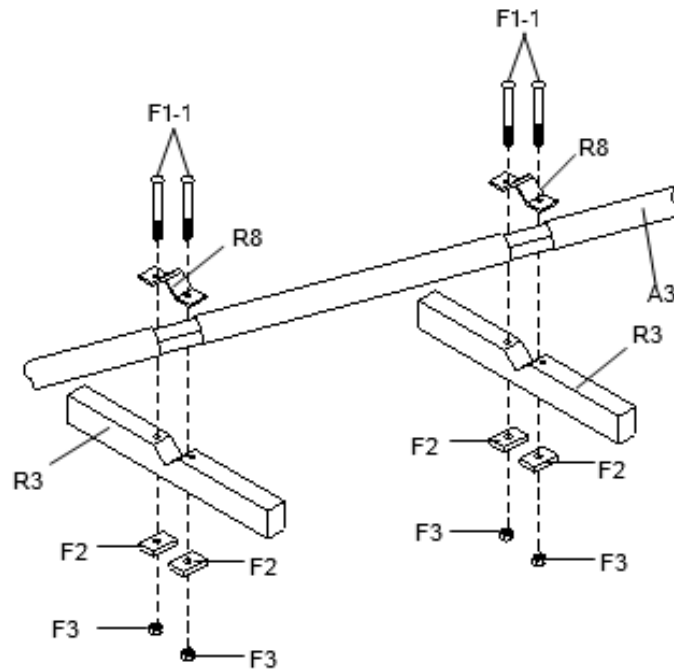

DIAGRAM A

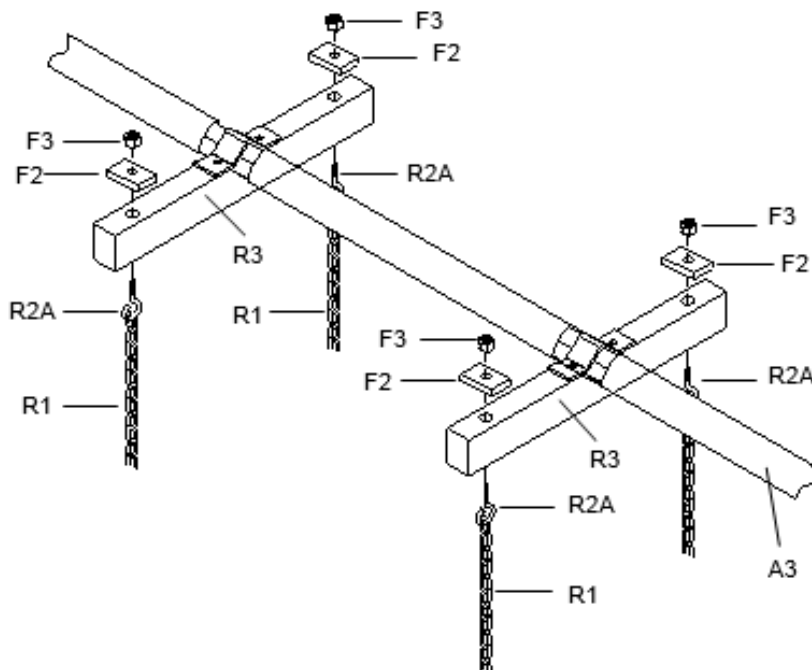

DIAGRAM B

Assembly Instructions

STEP 12 - Slide Assembly

- Insert Slide Front Support (X5-N) into Slide (Y2) and secure with Z9 and Z6.
- Connect (X4-N) into Slide (Y2) as shown in diagram below.

Bolt holes face up

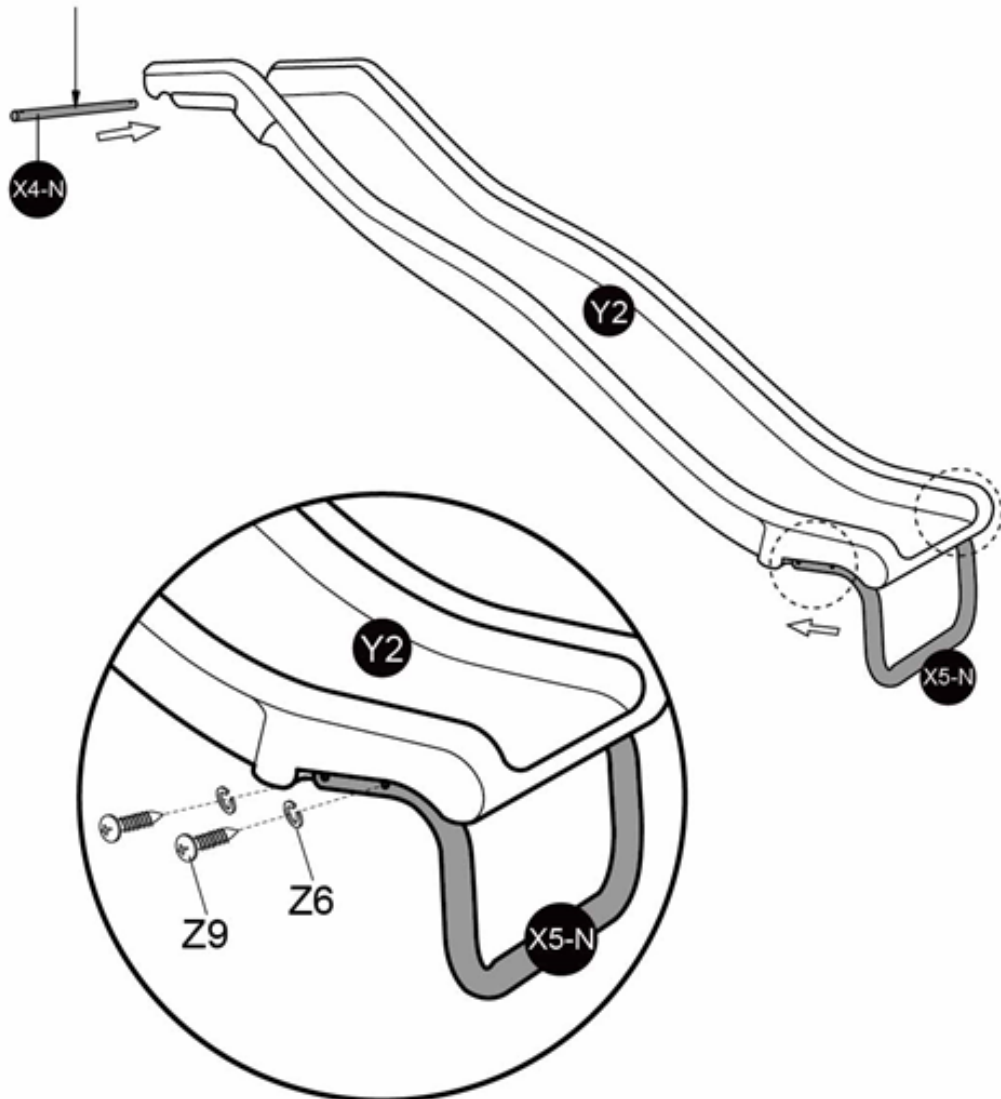

Assembly Instructions

STEP 13 - Slide Assembly (continued)

- Connect Slide Ladder Steps (X6) to Slide Supports (X1-N and X2-N). Secure both sides using Z8, Z6 and Z4 as shown in diagram below.
- Insert Slide Leg Tube (X3-N) into X1-N and X2-N as shown. Align the holes and hold in position.

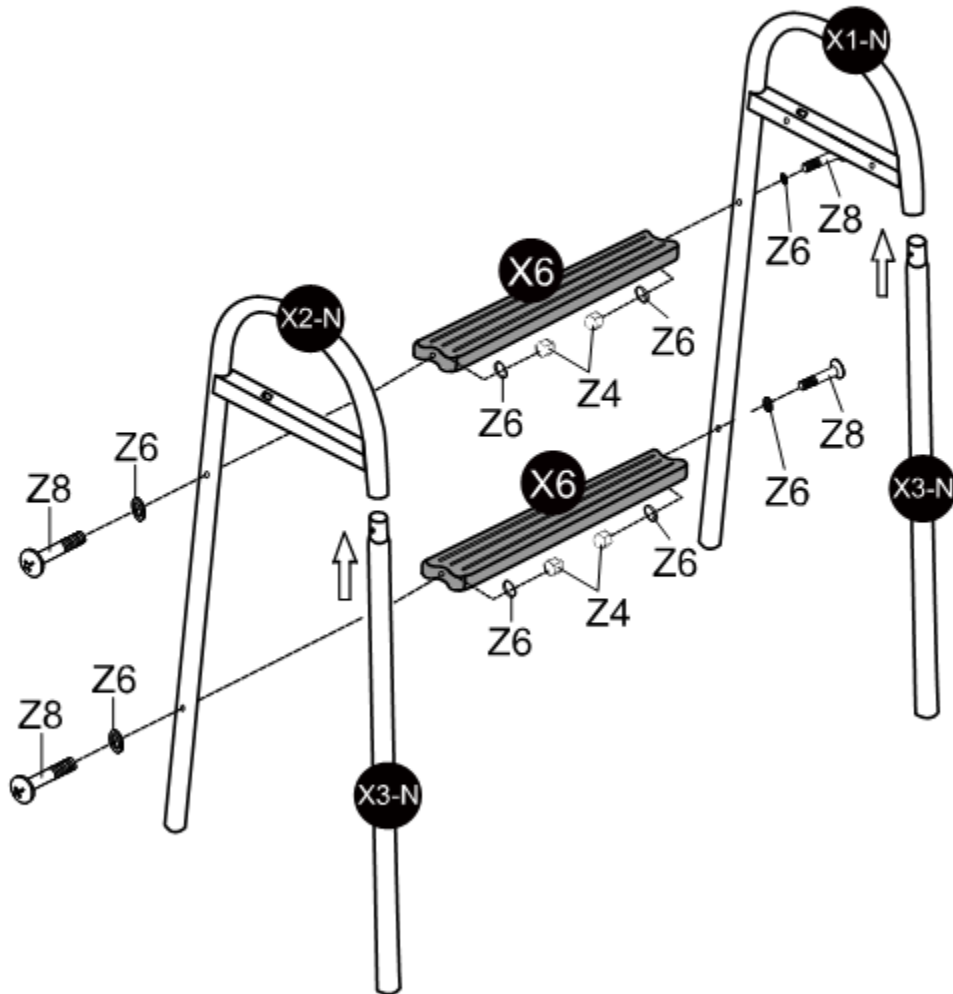

Assembly Instructions

STEP 14 – Slide Assembly (continued)

- Secure X4-N to the ladder using Z1, Z3, Z6 and Z5 as shown in DIAGRAM A.
- Place Slide (Y2) onto the assembled step ladder and secure both sides to the leg tubes using Z2, Z6, Z6 and Z4 as shown in DIAGRAM B.

DIAGRAM A

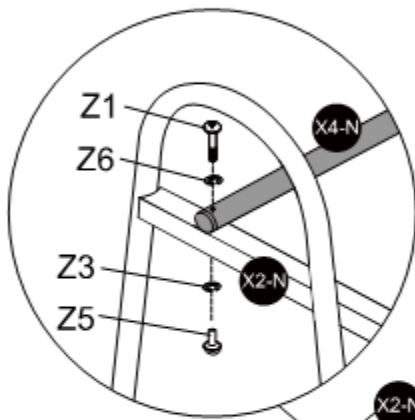
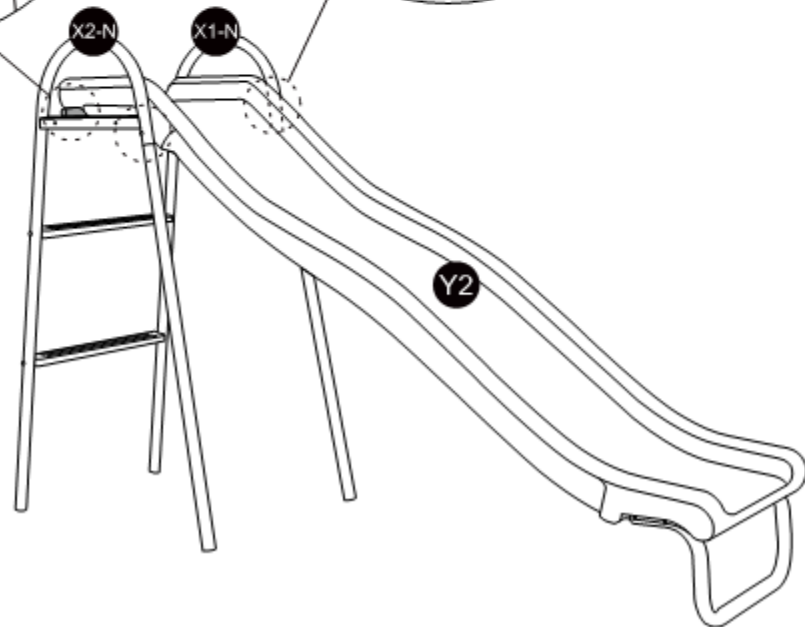
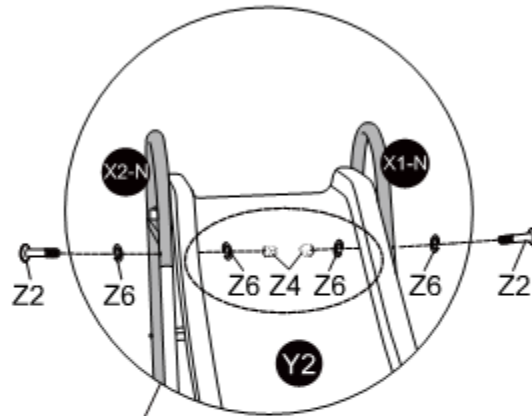

DIAGRAM B



Assembly Instructions

STEP 15 – Slide Assembly (continued)

- Connect the assembled slide to the swing set frame. Place Plastic Connector (Y1) between A7 and X1-N and secure together using Z7, Z6, Z3 and Z5 as shown in diagram below.

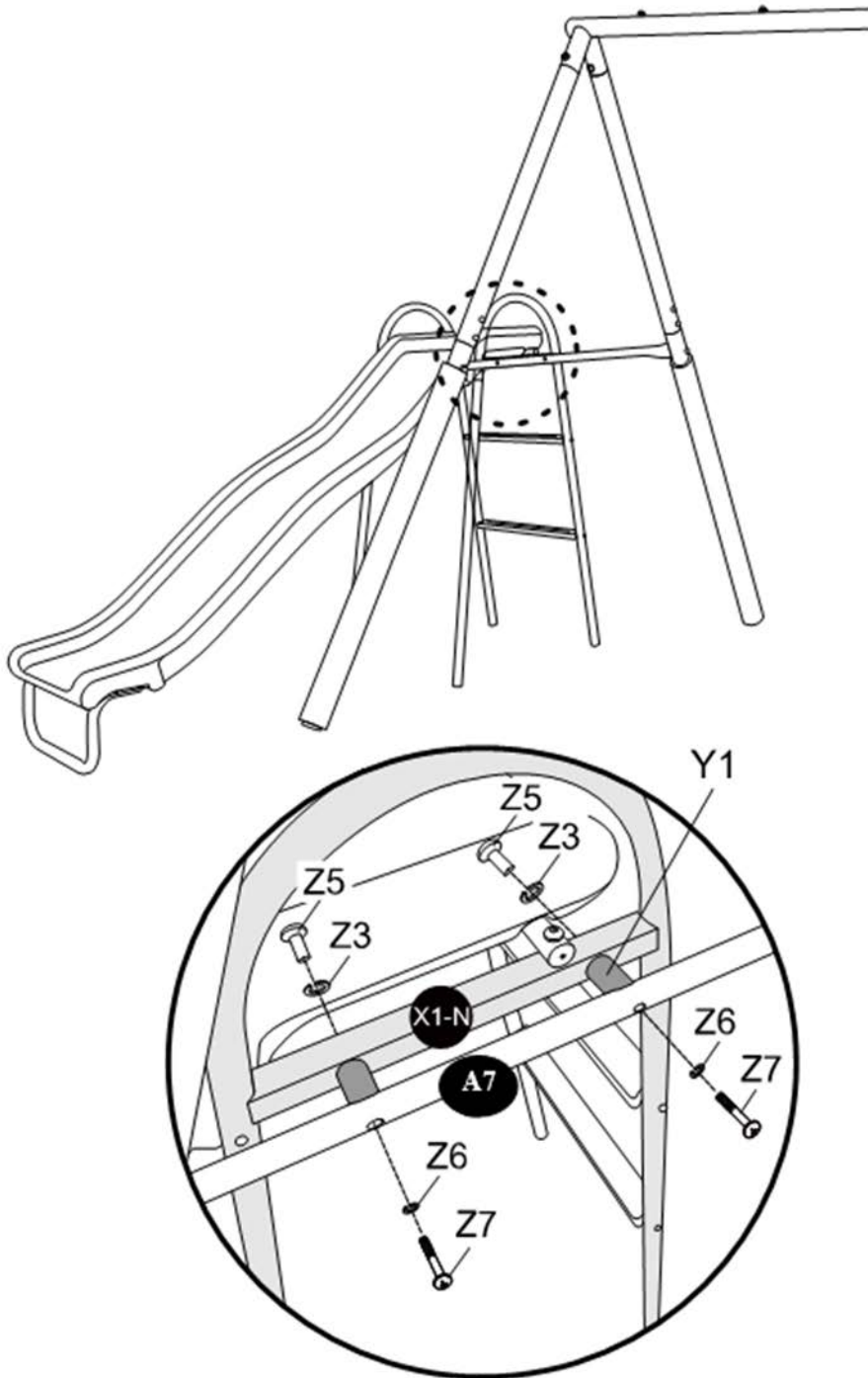

Assembly Instructions

Congratulations!

You have now completed the swing set assembly. Please make sure to thoroughly check all parts and hardware to make sure all bolts and nuts are well secured before using the playground equipment.



WARNING

Do not let children use the playground equipment until it is properly assembled and anchored.



WARNING

Please ensure the slide is attached towards the front of the swing. This is to avoid the risk of entrapment for young children.

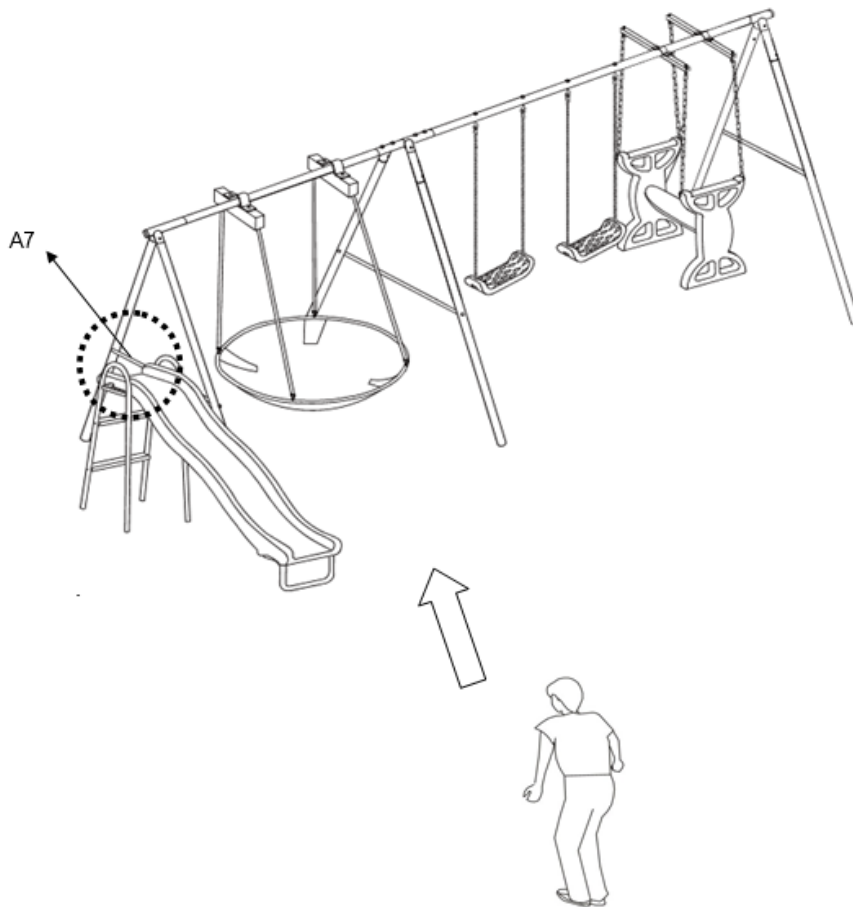

Warranty Information

Sportspower Ltd warrants its products to be free from defects in material and workmanship under normal use and service conditions for ninety (90) days after the date of purchase. Extended warranty from 90 to 180 days will be offered to those customers registering their products at www.sportspowerltd.net within 14 days from the date of purchase. The frame is warranted for 12 months after the date of purchase.

This warranty coverage extends only to the original purchaser with a receipt and is non-transferable. All products for which a warranty claim is made must be received by SPORTSPOWER'S authorized service center, freight prepaid, and accompanied by sufficient proof of purchase during the warranty period.

This limited warranty does not cover our products which: fail due to (1) normal wear; (2) abuse and neglect; (3) improper maintenance; (4) unauthorized repairs or alterations or (5) are used for commercial or other income producing purposes or (6) accidents and misuse.

All warranty repairs must be authorized by SPORTSPOWER Customer Service before repairs are made.

IMPORTANT: A missing part is not considered the same thing as a defective part or unit. If a part is missing, there is no need to return the entire unit to the store. In order to obtain fast replacement parts or service as provided by this warranty, please call the number below. Proof of purchase required.

**For Customer Service, please call 1-866-370-2131 or visit www.sportspowerltd.net
Monday - Friday 9:00 AM - 5:00 PM Eastern Time**

Sportspower Limited
Level 20, Parkview Centre, 7 Lau Li Street, Causeway Bay, Hong Kong
Corporate Office 1-800-497-6106

SP-19-MS-3782BM-ADMY-17001