



ASSESSING CREATIVITY IN COMPUTING CLASSROOMS

CREATIVE COMPUTING LAB
HARVARD GRADUATE SCHOOL OF EDUCATION
MAY 2020

TABLE OF CONTENTS

03

WELCOME

05

ACKNOWLEDGMENTS

06

CASE STUDIES

23

ASSESSMENTS

WELCOME

What do you think about when you think about computer programming?

As members of the Creative Computing Lab at the Harvard Graduate School of Education, we think about the *creative* power of programming, how programming can be used in many different ways to express ideas and solve problems. You, like so many of the wonderful educators we are privileged to work with, may also be excited about the creative potential of programming and supporting creativity in your classroom.

As computing education has become more popular in K–12 and more educators share a commitment to supporting creativity through programming, questions have surfaced about how to assess the beautiful and complex learning that is taking place in classrooms. Creative work can be incredibly diverse in process and in product, which can lead to feelings of uncertainty about assessment. However, we also know that there are K–12 teachers—across the country, around the world—who are supporting creative practice in the classroom every day and have found thoughtful and imaginative ways of assessing creative work.

The excitement for the creative power of programming and the questions about how to assess students' creative work prompted us to undertake this project, which was funded through the generous support of Google's Computer Science Education Research program. In this project, we were guided by a central question: *How do K-12 computing teachers assess creative programming work?* Our approach was simple: during the summer of 2019, we talked to 80 K–12 computing teachers across the U.S. about how they supported and assessed creative work in programming activities. In our conversations, typically between two teachers and a member of our team, teachers brought a pair of assessment examples and used those examples as the foundation for a broader discussion about creativity, programming, and assessment.

Although these 80 teachers had a shared commitment to creativity and computing, how this manifested in the classroom looked very different from teacher to teacher. These teachers worked with students of different ages and had different degrees of access to their students. Some teachers saw every student in the school for a half-hour each week; other teachers taught dedicated computing courses to the same group of 20 students every day. These teachers also had different disciplinary commitments. Some teachers integrated programming into core subjects; others integrated programming into technology courses on hardware, web design, and more. Although the contexts, access, programming languages, and types of projects varied widely, teachers expressed their commitment to helping their students see the radical and imaginative potential of programming.

Through these conversations, as well as an examination of the assessment research literature, we identified key principles that guide the assessment of creative programming activities:

Foster a classroom culture that values assessment. Assessment can feel intimidating or unproductive for students and teachers, but we heard beautiful examples of how teachers were reimagining the role of assessment in the classroom, creating opportunities for assessment to benefit the learner, the teacher, and the learning community. We heard about teachers offering feedback to students, as well as offering opportunities to resubmit work until students were satisfied with the work and the evaluation. In the case studies at the beginning of this volume, you'll read about four teachers who took multifaceted approaches to building this sort of constructive creative environment.

See student process as well as product. In addition to evaluating the final product, we also heard about teachers employing many different strategies to assess aspects of student process along the way. Teachers were studying and offering feedback on drafts leading up to the final version, as well as asking students to keep a design journal and record reflections throughout the process. In one of our classroom case studies (*Understanding Process in Erin's Classroom*), we heard how students engaged in sharing throughout the creative process, learning how to confidently present their ideas, as well as how to give and receive helpful feedback.

Understand what is creative for the student. Students are entering classrooms with a wide variety of prior programming experience, and they may want to pursue wildly different projects. We heard about teachers asking students to define their own project goals and to explain what was creative, novel, or surprising for them. In another classroom case study (*Assessing Creativity as Choice in Joshua's Classroom*), where students varied greatly in their level of comfort with the idea of creativity, the careful scaffolding of creative projects honored each learner's unique path.

Support students by incorporating feedback from multiple perspectives. Because creativity is inherently subjective, teachers talked about creating opportunities for peers to assess one another, as well as asking students to reach out to parents and family members for feedback, or bringing other authentic audiences into the classroom. In the third case study (*Multiple Perspectives on Projects in Evan's Classroom*), this feedback was used as data, providing insight on what students had learned and what supports they needed in order to grow as creators.

Scaffold opportunities for students to develop judgment of their own work. Across grade levels, we heard how teachers develop strategies for helping students learn how to assess their own work and become more independent learners, from asking students to assess themselves on a rubric before submitting their work to asking students what they might iterate on, if given more time. In the fourth case study (*Student-Designed Assessments in Jessie's Classroom*), students designed their own rubrics, which they later used to assess their projects and reflect on their learning.

Thanks to these incredible teachers who met with us and generously shared their thinking about their practice, we were able to gather more than 300 assessments, ranging from class project rubrics to examples of student project portfolios. In this document, we are sharing our understandings in two ways: (1) a collection of four case studies, and (2) a selection of 50 assessments. The case studies tell the stories of four teachers who are putting the guiding principles of creative assessment into practice in the complex, real-life contexts of their classrooms. The 50 assessments represent a curated collection of real assessments that teachers are using in their classrooms, accompanied by quotes from teachers about what the assessment of creative work entails.

As you continue to explore ways of supporting creativity in the computing classroom, we hope that this volume will serve as rich inspiration for your pedagogic imagination. We look forward to hearing from you about how you use these ideas and resources!

Sincerely,
Karen Brennan, Paulina Haduong, and Emily Veno
Creative Computing Lab
Harvard Graduate School of Education

ACKNOWLEDGMENTS

We are so grateful to the 80 teachers who were so generous with their time and thinking. Your work inspires us—thank you! Although we use pseudonyms in the remainder of this volume, we want to acknowledge the phenomenal teachers who supported this work through their thoughtful reflections and practices of supporting creative work in the computing classroom.

Abigail Mente, Alexis Cobo, Alise Braick, Allison Goldsberry, Amanda Martin, Amanda O'Mara, Amy Perez, Angela DeHart, Angie Abbott, Anne Marie Wyman, Art Simon, Barbara Peskin, Brittany Kavanaugh, Byron Gilliland, Catherine Tabor, Charlotte Bethany, Chere Guilbeau, Christopher Sweeney, Courtney Bell, Daniel Bell, Darlene Martin, David Petty, David Renton, Doug Bergman, Betsy Dillard, Eric Eisaman, Eric Toy, Eric Walters, Erica Roberts, Gloria Mathew, Greg Beutler, Ingrid Roche, Jamie Lang, Janell Miller, Jason Rushing, Jeff Durney, Jennifer Styer, Jennifer Waldron, Jim Looney, Joanne Barrett, Joe Beasley, John Bartucz, Julianne Ross-Kleinmann, Julie Moore, Kaye Rueschhoff, Kaywin Cottle, Kelly Powers, Kerri Murphy, Kevin Lenihan, Kevin Saxton, Kimberly Zern Evelt, Kirsten Fournier, Kyle Schroeder, Lara Cesco-Cancian, Laurel Pollard, Lauren Lutz-Coleman, Lauren Pruitt, Lisa Skinner, Liz Bransky, Lori Wristers, Luna Ramirez, Marcel van Baal, Meg Boyles, Mehreen Butt, Melissa Zeitz, Neil Plotnick, Nichole Niebur, Owen Peery, Patty Hicks, Quincy Tennyson, Rachel Smith, Rebekah Lang, Rob MacDonald, Ruth Farmery, Sue Tyner, Susan Ettenheim, Susan Geores, Tami Brass, Tammy Andrew, TJ Olenja

Thank you also to Chris Stephenson, Tina Ornduff, and the inaugural CS-ER cohort for your support in making this project possible.

Thank you to Angelina Berardi for support with the graphic design of this report.

Finally, thank you to our friends in the Creative Computing Lab who have supported us throughout the process, in ways large and small: Plub Limpiti, Laura Peters, Sarah Blum-Smith, Max Yurkofsky, Raquel Jimenez, and Jeff Hawson.

We are releasing this work under a Creative Commons Attribution-NonCommercial-ShareAlike 4.0 license, which means that you are completely free to use, change, and share this work, as long as you provide appropriate attribution, do not use the material for commercial purposes, and give others access to any derivative works.

Recommended citation: Brennan, K., Haduong, P., & Veno, E. (2020). *Assessing creativity in computing classrooms*. Cambridge, MA: Creative Computing Lab.

CASE STUDIES



ASSESSING CREATIVITY AS CHOICE IN JOSHUA'S CLASSROOM

"Five years ago, they were afraid to make any mistakes, and now I've got kids that are jumping into the deep end before they know how to swim."

Joshua, a K-5 teacher at a public school in the Midwest

"I think kids can be intimidated by that word."

Several years ago, Joshua's district leadership began a process of defining "creativity" and encouraging discussion between students and teachers about what it means to do and assess creative work. He noticed that many students were nervous about the idea of working creatively and being assessed on creativity. "Some kids just don't look at themselves as being creative. They say, 'I want to know the rules.' Or they get wrapped up in, 'I can't draw, so I'm not creative.' And they wrap creativity up in one construct, and don't look outside that box."

Not all of Joshua's students were hesitant to see themselves as creators. Some of them, to the contrary, relished opportunities to engage in creative projects. Joshua had concerns about how to assess both kinds of students, because he didn't want to make aesthetic and subjective judgements that might crush their self-confidence or motivation. "They are so, so proud of their work," he says. "It tugs at your heart a little bit. How do you judge that art? The process that they go through?" However, he has also observed that assessing creative work using "objective" rubrics could impose inauthentic limits on students' imaginations. "Kids tend to pigeonhole themselves into what they think they're capable of doing," says Joshua, noting instances where kids would constrain themselves and conform to the rubric specifications.

Through discussions about creativity at multiple meetings and professional development classes, Joshua and the other members of the school district curriculum committee designed tools to support an assessment strategy that took into account the varying creative dispositions of their students. They wanted to encourage fearful students to develop their creative viewpoints and embrace uncertainty, while supporting enthusiastic creators in following their interests while persevering through challenges. "The overall goal is to get them to that point where they are fearless," says Joshua, "where they are not afraid to express who they are and express their ideas." What does

CAPSTONE PROJECT PLANNING

PROJECT PLANS BY: _____

Use the prompts below to start thinking about the elements needed to develop your project.

MY PROJECT

Circle the type of project you want to create.



Game



Story



Animation



Art

Describe the project you want to create.

List the steps needed in order to create your project.

- _____
- _____
- _____
- _____
- _____
- _____
- _____
- _____
- _____

Example Steps:

- Add a backdrop
- Add a sprite
- Code the sprite to move left and right
- Code the sprite to move up and down
- Add a 2nd sprite
- Code the 2nd sprite to move randomly
- Add a score
- Add a 2nd backdrop
- Create an ending sprite

PROJECT SKETCHES

PROJECT SKETCHES BY: _____

Use the space below to draw sketches of what your project will look like!

MY PROJECT SKETCHES

What's happening? What are the important elements?

What's happening? What are the important elements?

PROJECT PLANNING. Selections from capstone project planning pages, which Joshua's students use to outline a vision for their long-term open-ended project. It includes examples of what kind of project they might create and steps they might take to get there, to further scaffold their journey to creative independence.

that look like in practice? Largely, it's about choice. When his students make choices about how to creatively demonstrate what they know and what they can do, they take ownership of their learning. Joshua uses three tactics to build a classroom environment rich in opportunities for creative choice: **scaffolded projects**, **project menus**, and **assessing independence**.

Scaffolded Projects

Eventually, each of Joshua's students are asked to make big, complex creative choices. Each of Joshua's fourth and fifth grade students completes a long-term, open-ended, and self-directed **capstone project**. "They have to plan everything," he explains, "and understand the concept of the game, the story they're telling, or the animation they're presenting." The path to these bigger creative choices, however, is a series of small ones. Joshua carefully prepares students for the capstone throughout the year, gradually incorporating more tools students know how to use and reducing constraints imposed on their projects. "I start with a **guided lesson** where I will say, 'Okay, let's all use the cat sprite, and use that sprite as our main character...and we do an activity that lends itself to a specific skill.'" These lessons are deliberately kept simple and brief, meant to reduce initial intimidation rather than impose a model for how students should create.

"What I do then," describes Joshua, "is say, 'Okay, now, checking what we've done, I want you to recreate this lesson in your own way.' So, in the last part of the day, or even the next day, they're using the same constructs, the same skill sets, and they're building their own things." During this **low-stakes project**, Joshua strives to understand

Capstone Project Menu



Mild

Create a working game in Scratch that includes the following:

- Use motion blocks to [program your main sprite](#) to move toward target sprites. [Add at least one target sprite](#) and motion blocks to make it move.



- [Create a variable](#) called score. Use a [conditional and variable to add a score](#). Remember to set score to 0 when you click the green flag.



Medium

Create a working game in Scratch that includes the following:

- [Create a variable and name it timer](#). Program a working timer to add a challenge for your players.

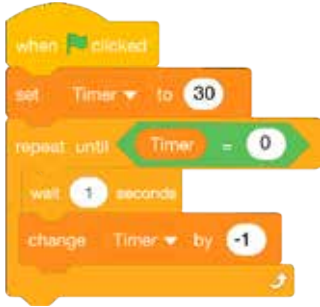

- Make one target sprite add points and another sprite subtract points.



Spicy!

- Create your own custom background or [sprite](#) using [paint editor tips](#).
- Add a [music loop](#).



- Add a [sound effect inside of a conditional](#).



- Make a background that changes to create multiple levels of your game.

CAPSTONE PROJECT MENU. This particular project menu was designed by the curriculum committee for students who wanted to make games in Scratch. More playful than a list of project requirements, menus help generate ideas and encourage Joshua's students to challenge themselves.

each student's creativity in the context of their relative unfamiliarity with the tool and process. "You'll have some kids that will find a sprite from the library, but they'll use the drawing tool to make a rainbow shirt or do something different, to add their own flair to the assignment."

When it's time for Joshua's students to tackle their capstone projects, they are familiar with a variety of concepts and are used to working creatively, thanks to the guided lessons and low-stakes projects. Joshua uses a **capstone project planning page**, developed by the district curriculum committee, to help students flesh out their ideas and envision how they might specifically put them into action. By scaffolding each step of their journey toward open-ended projects, Joshua supports his students to work towards fearlessly engaging in the creative process.

Project Menus

As students plan and create their capstone projects, Joshua wants to encourage them to demonstrate mastery of the specific tools and concepts they've learned so far. However, to support their creativity, he also avoids being overly prescriptive when telling students what to include in their final products. **Project menus**, another tool the

Creative Coding Capstone

The Rubric

Basic Project requirements:

- multiple backdrops
- multiple sprites
- contains at least 3 out of the 5:
 - variable
 - conditional
 - function
 - loop
 - event
- sound, which could include:
 - background music
 - sound effects
 - text to speech

Advanced Project requirements:

- multiple backdrops, which include:
 - original art using Scratch drawing tools
- multiple sprites, which include:
 - original art using Scratch drawing tools
 - multiple costumes
- contains at least 4 out of the 6:
 - variable
 - conditional
 - function
 - loop
 - event
 - broadcast blocks
- sound, which could include:
 - background music
 - sound effects
 - text to speech

1	2	3	4
Student is unable to complete a Basic project even with extensive assistance.	Student is able to complete a Basic Project with much assistance.	Student is able to complete a Basic Project even with minimal assistance.	Student is able to complete an Advanced Project with minimal or no assistance.

CAPSTONE RUBRIC. Instead of using a traditional rubric, Joshua assesses capstone projects using a list of "basic" and "advanced" requirements and a 1-4 scale of student independence. Students are encouraged to push themselves past the basic skills they've been taught but aren't penalized for needing support.

curriculum committee developed, help students envision directions they might take their project but don't insist they follow one particular set of steps. The language used is also different from a traditional list of requirements or categories students might see on a rubric. The "mild, medium, and spicy" framing and the title "menu" both tacitly acknowledge that different students will have different priorities and abilities when making their projects, as well as that project features are a matter of individual choice. "We talk about these things, so they see the differential," says Joshua. "And they're then able to decide what pieces they're able to put into it."

Project menus address the needs of multiple kinds of students in Joshua's classroom. Students who are fearful of open-ended assignments can use the menu to generate ideas and reassure themselves that they know how to make a creative project, while students who relish the opportunity to design their own project can give themselves structure and stay on track using the checklist.

Assessing Independence

When students have finished their capstone projects, Joshua uses a rubric framework to assess their work. Logically similar to the project menus, this rubric also centers the importance of choice in assessing creative work. Students need to use a certain number of features but can pick which make sense for their projects. In this rubric, Joshua uses a 1-4 scale not to measure the subjective qualities of the student's project, but instead their level of independence in completing it. "That level of independence is where we get our grade," says Joshua. "We are asking, 'Did you do this on your own or did you have to have lots of help and support?'"

Joshua carefully observes each student as they work on their projects to get a sense of where they are struggling and how much of each project they accomplished on their own. However, seeking out help is far from discouraged; Joshua has even implemented an emergency room-themed area in his classroom to track and support students as they face issues. "I have a **'triage board'** in my room where kids will go and write their name, and they'll say, 'I need help with a timer!'" When a student writes their name on the triage board, they add a symbol (such as a red plus sign) to indicate the level of emergency. Peers in the classroom then volunteer to help the student with their problem. Once the issue is solved, the symbol is changed to a green checkmark.

Joshua worked collaboratively with the other teachers on the district curriculum committee to design the rubric framework. "We developed some basic requirements that we thought all students should be able to do in fourth and fifth grade, and then we upped the ante a little bit with the advanced project requirements." Teachers talk openly with students about the differences between the two kinds of projects and the 1-4 independence grade. "One is where they're unable to do it, even though I'm right there, hand-feeding them the blocks they need to use. As soon as they are able to complete a basic project with minimal assistance, they go to an advanced project with minimal or no assistance." Joshua has been pleasantly surprised by the number of students who take their work in directions above and beyond the project requirements. "Last year, most of them designed their own backdrops. And that was what was interesting to me—we had a majority of kids that really wanted to showcase what they could do on their own."

While his clear lists of project options and requirements ensure that students demonstrate their knowledge and skills, Joshua supports his students' creativity by encouraging them to make increasingly complex choices throughout the process. This strategy helps every student, even those who may not have initially thought of themselves as creative, develop the capacities to create.

Reflection Questions

- When and how do I scaffold the introduction of creative work in my classroom?
- How much freedom and flexibility do my students have with the required features of their creative work?
- How can I assess student independence along with their creative work?

UNDERSTANDING PROCESS IN ERIN'S CLASSROOM

“A large part of grading creativity is to say—did you stretch yourself? Did you do more than you ever thought you could do? And do you keep wanting to do it?”

Erin, 6-12th grade teacher at a public school in the Northeast

Although students often enter her class with no coding or app development experience, Erin knows that a lack of prior programming experience doesn't mean they don't have expertise with using technology. “I start by asking, ‘What kind of apps do you like?’ If they're starting with cell phone apps or tablet apps, this is something they know how to do. It's not that they know how to do it, but they know what it should look like.”

This recognition of student viewpoints and interests is a guiding principle throughout Erin's teaching practice. To support her students' creative development, Erin's assessment strategy centers their independence and capacity to express themselves freely. She wants her students to learn not only how to create sophisticated computing projects, but also how to communicate confidently, clearly, and effectively about their design choices within those projects. Her assessment strategy, therefore, centers around careful observation of how they share, talk about, and reflect upon their work at every stage in the process.

Sharing at the Start

Erin's assessment process begins right away, in the brainstorming stage of each student's app development project. After drawing **storyboards** and a potential user interface on paper, students meet with Erin to discuss the feasibility and purpose of their design. This **check-in interview** is the basis for Erin's framework for assessment that is responsive to the individual student's creative ideas, goals, and capabilities. “They give me a parameter of what they're going to produce. How they actually do that is up to them, and that's creative. My assessment is: ‘Did you do that? Did you meet your own requirements for what you proposed you would do?’” This question, about to what extent students' initial visions align with their eventual final products, helps ground Erin in assessing open-ended student projects.

At the start of the process, Erin also uses **elevator pitches** to assess how students are able to articulate the rationale of their designs. Each student pitches their idea and storyboards to the class for two to three minutes. Then, they receive feedback from the class, carefully structured around questions Erin has prompted, such as, “Is the app presented socially useful?” After this, students reflect on the peer and teacher feedback they were given to guide iteration on their proposed design. In this way, reflection is an important part of the entire creative process in Erin's

- Meet with your instructor to discuss the feasibility of the app and if necessary make any changes in your plan.

CHECK IN WITH TEACHER

- Present a short (2-3 minute) **elevator pitch** of your project idea to the class. The pitch could follow this template: *[name of app] is a [kind of app this is] for [the people who would use it] that, unlike [similar apps] is able to [the major distinguishing feature of your app].*
- Other students should provide feedback: *Is the app presented socially useful? Why or why not?*
What is a strength of the proposed app? What suggestions do you have to improve the app?

CHECK-INS AND ELEVATOR PITCHES. At the beginning of their project process, students do individual check-ins with Erin, as well as preparing and presenting a short pitch to the rest of the class. Even early on, students practice sharing their ideas and communicating about their creative work.

classroom, rather than something students are only asked to do once they finish a project. By asking students to reflect at every stage, Erin hopes her students will continuously adjust their designs and ways of working to align with their goals and interests.

Sharing with Peers

Erin wants to make sure that students have the opportunity to communicate about their creative work more than once, in different ways, and at multiple stages of the process. Erin wanted each student to share their apps with the class but was frustrated by the logistics of typical in-class presentations. "I lose ten minutes per kid, and it takes too many days out of my classroom to have kids do presentations. So, I started out with that premise and came up with a really cool solution."

PARTS OF THE PROJECT THAT MIGHT BE HELPFUL TO THINK ABOUT:

- Clarity: Did you understand what the project is supposed to do?
- Features: What features does the project have? Does the project work as expected?
- Appeal: How engaging is the project? Is it interactive, original, sophisticated, funny, or interesting? How did you feel as you interacted with it?

RED, YELLOW, GREEN:

Add a detailed comment for each row after thoroughly thinking about the app and using it. The goal of the exercise is to help improve each other's apps and so provide constructive criticism in a manner that recognizes the developer's efforts.

<i>[RED] What is something that doesn't work or could be improved?</i>	
<i>[YELLOW] What is something that is confusing or could be done differently?</i>	
<i>[GREEN] What is something that works well or you really like about the project?</i>	

HOW TO GIVE APP FEEDBACK. The peer feedback guide Erin's students use during round robin presentations. Students give feedback on multiple projects and get feedback from multiple peers.

In what Erin calls **round robin presentations**, each student prepares a ten-minute presentation explaining and demonstrating their project. During the presentations, half of the students sit with their laptops and present, simultaneously, for one peer at a time. "I use an egg timer, and every ten minutes they switch and go on to the next one." The students watching presentations take notes and offer written critique based on the project parameters, sometimes using a **peer feedback guide** Erin has developed. After several rounds, the two groups swap, and the students who have already presented critique the other group in the same way. This way, Erin completes student presentations in only one class period.

Beyond simply saving time, round robin presentations support the student autonomy and classwide energy that Erin prioritizes in her classroom. “It activates the entire process, so there is no kid sitting in the back of the class finishing up their project, because they have a role just as much as the presenter. Throughout this whole thing, the presenter is getting continuous feedback.” During the presentations, Erin moves through the process like a student would, listening to each presentation in turn and filling out rubric assessments. “They get huge amounts of feedback and practice presenting, and I get a chance to look at every individual project with every single person in the class active.” Just as they do after the elevator pitches, Erin’s students engage in written reflection after the round robin presentations. Because of their consistent practice, by the final project documentation phase, students are used to and comfortable sharing, communicating, and reflecting about their project.

Sharing Documentation

In addition to their presentations, each student also submits **project documentation** that summarizes the purpose, attributes, and design process of their app. Erin uses these documents to assess whether and to what extent students achieved the vision they articulated during their initial conversation about the project. Of course, many students’ final projects do not necessarily have every feature they had hoped to include. This comparison between goals and eventual designs is not meant to penalize changes in creative direction or challenges that haven’t been overcome by the due date. Instead, Erin uses the documentation to get an idea of what students have learned and how they have persevered through challenges.

TEMPLATE 2– Project Template	
<p>A) Describe your project 1 Paragraph Minimum</p> <p>My app is about allowing people to move furniture around a room without having to move around. I know that my family has to move around the furniture in the room many times before finally deciding where to put everything. Afterwards, my family is very tired. This app will allow my family and others to be able to move furniture around and decide how the room will be set up before moving it.</p>	
<p>B) Reflect on your project. What problems did you have? What changes did you make? 1 Paragraph minimum.</p> <p>I had problems with having image sprites connected to a list picker on the first day of my creating app. The next day I also had trouble hiding the image sprite when the screen initializes. Later I realized I had to organize my image sprites differently. It was very hard to do this. I tried to connect the image sprites by putting the image sprites into a list. I figured out that I had to this using multiple boolean conditions and procedures to be able to do it. After I figured out how to link images sprites to a list, I then moved on to my second problem, which was figuring out how to turn image sprites invisible while, keep others visible at the same time. With more information on the concept, I was able to use another multi-part boolean condition to turn certain blocks visible and invisible. Overall This was a challenging app to make, but I eventually got through it.</p>	
Section 2D – Abstractions	
<p>Capture and paste the program code segment that contains an abstraction you developed (marked with a rectangle in section 3 below). Your abstraction should integrate mathematical and logical concepts. Explain how your abstraction helped manage the complexity of your program. <i>(Approximately 200 words)</i></p>	
<p>THESE ARE ABSTRACTIONS – Highlight 1</p> <ol style="list-style-type: none"> 1) Procedures 2) Parameters, Variables 3) Lists 4) Application program interfaces (APIs) 5) Lists and other collections can be treated as abstract data types (ADTs) in developing programs. (EK 5.5.11) 	
<p>Paste your block(s) that contain your abstraction.</p> 	<p>What type of abstraction is this? Why is it a good example of this abstraction type?</p> <p>This is a list Abstraction. This abstractions allows me to list all the colors I want in one button. It simplifies the code for me. Now the user can change the background of the canvas to one of 6 colors.</p>

PROJECT DOCUMENTATION. Student example of documentation for an app project. Combined with presentations and peer feedback, project documents help Erin get a more in-depth understanding of what students know and have learned through their design process.

Students also have space to reflect and explain their code in detail in relation to specific content mastery goals. Because Erin focuses on supporting clear and confident communication skills throughout the process, she finds that her students are ready to write about their projects with both feeling and specificity. "A really good assessment has to contain self-reflection on the part of the student," explains Erin. "It's not just me, they have to be able to assess themselves eventually."

Erin's philosophy comes from a deep desire to prepare students to be empowered creators in real-world contexts. By instilling a purpose-driven, collaborative mindset in her students, she hopes to prepare them for careers and build their confidence. "When we can engage them and make this a place they can succeed, it goes so far beyond the actual content. It basically says, 'You belong, you have a right to be here, and you have a right to expect a lot from the world. You have great skills and great ideas, and the world needs you.'"

Reflection Questions

- When and how do my students share their creative work with the class?
- How do my students engage with peers who are presenting their creative work?
- What kind of documentation can my students submit along with their creative work?

MULTIPLE PERSPECTIVES ON PROJECTS IN EVAN'S CLASSROOM

"It allows them to identify where they're weak, where they're strong, and what they learned—and it helps build confidence for the next project."

Evan, 9-12th grade teacher at a public school in the Midwest

Like many teachers, Evan has sometimes struggled to assess student creativity. "I'll grade rubrics about the knowledge I'm looking for, and the skills I'm looking for, but evaluating how a student solves a problem or showed creativity is hard," he says. "It's very difficult because it's very subjective." Evan's students work in groups on a wide range of creative projects, from programming robot birds to making favicon art to writing adventure games in Python, and these projects typically span three to eight weeks. "We are a project-based school, and my computer science class follows that model of student-driven and collaborative projects."

Even though the process is demanding, Evan believes that students benefit from receiving thoughtful critique on the subjective elements of their creative work. However, it can be difficult to convince his students to value criticism as a tool for growth, rather than as an indicator of their success or failure. "I want my assessment and feedback to be meaningful," he explains, "and I feel like some students just go straight towards the grade and say, 'Okay, I got a B,' and then they'll throw away the next two pages of written feedback I worked so hard to produce." To create a classroom culture that highly values feedback as a tool for continuous improvement, Evan strives to maximize the amount of voices students hear. "The more perspectives you can get," he says, "the more you can give meaningful feedback for the student."

Evan informs his understanding of student creative work by hearing from three kinds of voices in particular: the student, their peers, and outside audiences. At the end of every project, Evan's students engage in **self-assessment**, **peer assessment**, and **audience assessment** processes, primarily through the use of Google Forms. These three sets of perspectives help Evan understand each student's work along multiple dimensions, and these assessment processes support his students in valuing the acts of giving feedback to their peers and getting feedback from others.

Self-Assessment

Evan solicits two categories of self-assessment reflections from students about their own work: **agency reflections** and **content reflections**. Evan defines "agency," one of several school-wide learning outcomes that he is asked to assess, as "how students are making choices for themselves in their own learning." He sees the assessment of agency as directly tied to creativity. "These reflection questions break down the idea of something as subjective as

Agency Reflection

Reflect on where you best fit for this project.

Effort & Practice to Grow *
Understands how effort and practice relate to getting better at skills, improved work quality, or performance

	1	2	3	4	5	6	7	8	9	10	
Emerging	<input type="radio"/>	<input type="radio"/>	<input type="radio"/>	<input type="radio"/>	<input type="radio"/>	<input type="radio"/>	<input type="radio"/>	<input type="radio"/>	<input type="radio"/>	<input type="radio"/>	Advanced

AGENCY REFLECTION. One of five competencies in the Agency self-assessment section of a Google Form. Students were also asked to rank their "Equal Participation," "Active Participation," "Scrum Project Management," and "Challenge Seeking." Scrum is an agile process framework often used in software development, which Evan has adapted for his classroom.

creative thought by identifying and building the skills that go into creativity.” In the same questionnaire, students submit **content reflections** about their experience with the specific project and the tools and practices involved. Evan asks questions about specific pieces of content to gain an understanding of what each student perceives to be their strengths and weaknesses and to identify corresponding patterns in the class as a whole.

Content Reflection

Think back on your learning and comfort with programming python.

What, to you, was the easiest part of the project?

What to you was the hardest or most confusing part of the project?

If you had more time, what do you wish you did differently?

How did you SPECIFICALLY contribute to your team’s work?

ADVANCED: What evidence do you have in your program of you hitting “advanced” - what did you do to go above and beyond the requirements?

Identify your comfort/where you fall in the following categories.

	Strongly Agree	Agree	Neutral	Disagree	Strongly Disagree
I understand how loops work.	<input type="radio"/>	<input type="radio"/>	<input type="radio"/>	<input type="radio"/>	<input type="radio"/>
I understand if/elif/else relationships.	<input type="radio"/>	<input type="radio"/>	<input type="radio"/>	<input type="radio"/>	<input type="radio"/>
I fully understand how our code works.	<input type="radio"/>	<input type="radio"/>	<input type="radio"/>	<input type="radio"/>	<input type="radio"/>
Python so far is fairly EASY!	<input type="radio"/>	<input type="radio"/>	<input type="radio"/>	<input type="radio"/>	<input type="radio"/>
I see myself as a CODER!	<input type="radio"/>	<input type="radio"/>	<input type="radio"/>	<input type="radio"/>	<input type="radio"/>
This class challenged me to learn something new!	<input type="radio"/>	<input type="radio"/>	<input type="radio"/>	<input type="radio"/>	<input type="radio"/>
I would like to continue learning about computer science in the future.	<input type="radio"/>	<input type="radio"/>	<input type="radio"/>	<input type="radio"/>	<input type="radio"/>

CONTENT REFLECTION. In this section, students self-assess by writing responses to open-ended questions and by ranking their level of agreement with statements related to both content and mindset. In this particular form, he included some cumulative questions, since it was distributed at the end of the school year.

Evan finds that many students who typically struggle with being assessed are encouraged by the chance to assess their own agency and content understanding. “It’s a great way for students to reflect on all of the pieces of a project,” he says. “If they feel they didn’t do well on the project or it didn’t get to a deliverable product, it guides them in that process of realizing, ‘Hey, there are times when I hit a challenge, I worked with my group members, and I grew...Here’s where my weaknesses are, here’s where my opportunities for growth could come from.’”

Team Member #1: Collaboration Feedback

	Strongly Agree	Agree	Neutral	Disagree	Strongly Disagree
Team member participated in SCRUM norms and decision-making progress.	<input type="radio"/>	<input type="radio"/>	<input type="radio"/>	<input type="radio"/>	<input type="radio"/>
Team member contributed to the project in meaningful ways.	<input type="radio"/>	<input type="radio"/>	<input type="radio"/>	<input type="radio"/>	<input type="radio"/>
Team member sought help and/or offered support as needed.	<input type="radio"/>	<input type="radio"/>	<input type="radio"/>	<input type="radio"/>	<input type="radio"/>
Team member demonstrated trust, respect, and responsibility in their actions/words with the team.	<input type="radio"/>	<input type="radio"/>	<input type="radio"/>	<input type="radio"/>	<input type="radio"/>

Any Additional Comments I Should Know About Team Member #1?

Long answer text

COLLABORATION FEEDBACK. Evan asks project team members to evaluate each other according to several broad and specific collaborative skills criteria.

Peer Assessment

Evan gains the perspective of each student's peers through what is often another component of the same Google Form used for self-assessment. The **collaboration feedback** section in his group project forms helps Evan clarify his understanding of how each student contributed to the project. When responses from several peers about one student are cross-referenced with each other, as well as that student's self-assessment, a more detailed portrait of that student's work emerges.

Player Feedback!

Thanks for playing this Scratch game. What feedback can you give to the developer to make their game stronger?!

Do you agree with the following statements?

	Strongly Agree	Agree	Neutral	Disagree	Strongly Disagree
Instructions to play the game were clear.	<input type="radio"/>	<input type="radio"/>	<input type="radio"/>	<input type="radio"/>	<input type="radio"/>
The game's use of graphics was visually appealing.	<input type="radio"/>	<input type="radio"/>	<input type="radio"/>	<input type="radio"/>	<input type="radio"/>
The objective of the game was clear.	<input type="radio"/>	<input type="radio"/>	<input type="radio"/>	<input type="radio"/>	<input type="radio"/>
The user controls were simple and made sense.	<input type="radio"/>	<input type="radio"/>	<input type="radio"/>	<input type="radio"/>	<input type="radio"/>
The game was not too long, and I could easily "restart" or reset the game.	<input type="radio"/>	<input type="radio"/>	<input type="radio"/>	<input type="radio"/>	<input type="radio"/>
The game was not too challenging.	<input type="radio"/>	<input type="radio"/>	<input type="radio"/>	<input type="radio"/>	<input type="radio"/>
The game was too easy.	<input type="radio"/>	<input type="radio"/>	<input type="radio"/>	<input type="radio"/>	<input type="radio"/>
The game had a bug/error that prevented gameplay.	<input type="radio"/>	<input type="radio"/>	<input type="radio"/>	<input type="radio"/>	<input type="radio"/>
The game appears polished and finished.	<input type="radio"/>	<input type="radio"/>	<input type="radio"/>	<input type="radio"/>	<input type="radio"/>
The game was fun to play!	<input type="radio"/>	<input type="radio"/>	<input type="radio"/>	<input type="radio"/>	<input type="radio"/>

PLAYER FEEDBACK. A beta testing Google Form for Scratch games that Evan sends to volunteer students in other grades, at other schools, or who don't take computer science. Each volunteer gives feedback on one game and gives students a window into how novices and other students experience their project.

Evaluation

Did their code compile (run) - were they able to compete? *

Yes
 No

1. How much time was left on the clock when they left the game?
If they took the entire time - just please put "0"

Hrs Min Sec
_ : _ : _

2. Efficiency of Code *
How efficient was their execution of their code? Did the Finch take too long or perform unnecessary actions that were unneeded for the challenge?

Not efficient 1 2 3 4 5 Very efficient

3. Creative Approach & Problem Solving *
Disregarding efficiency, was their approach to solving the problem unique or different? Did their Finch behave/function in any manner different from the other groups (not including bugs)?

Not creative 1 2 3 4 5 Very creative/original

4. Team Spirit & Collaboration *
How well did the team work together and/or communicate during the challenge? Was the discussion mostly positive and supportive or was it otherwise?

Not collaborative 1 2 3 4 5 Very collaborative

OPTIONAL: Conversation with Group
How well could the team members articulate the principles of the following topics when asked - team strengths, team weaknesses, SCRUM, and/or paired programming.

Not strong knowledgeable 1 2 3 4 5 Very knowledgeable and strong responses

PROFESSIONAL EVALUATION. A Google Form used by visiting community members to evaluate teams of Evan's students in a robotics challenge. Because these adults were mostly programmers themselves, the language and prompts used allowed for authentic evaluation of features like code efficiency.

Audience Assessment

To supplement the perspectives of students and their peers in the classroom, Evan gathers additional project **feedback from outside audiences**. Depending on the aims of a particular project, he reaches out to a variety of potential audiences: students who are younger or older, students who don't take computer science, or adults from the community. "Sometimes it's tech engineers or programmers at local companies, and they'll give feedback on the student products," says Evan. "Audience assessment, I think, is where you have the most meaningful feedback, because it's coming from outside the classroom."

Communicating Feedback to Students

After all of the self-assessments, peer assessments, and audience critiques have been submitted, Evan faces a daunting task: making sense of all of the data. He wants to use the data not only to inform his own teaching and grading process, but also to encourage, challenge, and inspire his students moving forward. Since Evan is communicating not only his own feedback, but also the feedback from peers and outside audiences, he wants to avoid overwhelming students and strives to systematically communicate feedback.

Evan starts by using the feedback to iterate and improve on his lesson planning and teaching. "I use Google Forms because you can get real, meaningful data and it visualizes it for you," says Evan. "I'll go to the responses and look at, 'As a class, where were we strong in content? Where were we weak?' And I use that as a formative assessment for the next unit." He is enthusiastically transparent with students about this process, in the hopes that demonstrating his desire to improve his own work using feedback will help students understand the value of feedback. "We'll look at the graphs from Google Forms together and find meaning," he says. "I love sharing how I do this with students, because I am using computer science concepts to improve my evaluation." After seeing aggregated data about students' self-assessment responses, individual students often grow more willing to openly discuss their own struggles and knowledge gaps.

When he **conferences** one-on-one with students, Evan uses the feedback from the forms to set goals for the conversation. By looking at a student's self-assessment, he has a good idea of how students are feeling about specific aspects of the classroom environment and their content knowledge. "I can see exactly why a student may be behind in class. Is it because of the content or is it because of a lack of agency?" Using peer and audience assessments, he is able to frame the discussion around a rich variety of perspectives on their work, rather than centering his own opinion of their project.

Evan analyzes this data alongside their work products, other feedback, and rubrics they've received, in order to develop a holistic assessment for the student. "I take the surveys and my own in-depth rubric assessment, and, using mail merge tools, share critical feedback back in a personalized email." He compiles these emails and collections of assessments into **personalized archives** for every student so they can continue to reference them even beyond the school year. By making the feedback process about gathering information, engaging multiple perspectives, and finding opportunities for conversation, Evan supports his students in developing a healthy relationship to critique.

Reflection Questions

- Who gives feedback in my classroom?
- What kind of opportunities do my students have to give and receive feedback?
- What are the qualities of helpful feedback?

STUDENT-DESIGNED ASSESSMENTS IN JESSIE'S CLASSROOM

*"I'm looking for them to decide not only what they want to make,
but how they want me to assess it."*

Jessie, a 9-12th grade teacher at a public school in the Northeast

"Choosing how to demonstrate what they know can be a really creative process." Students in Jessie's AP Computer Science (CS A) and AP Computer Science Principles (CS P) classes are offered many such choices: about what they want to learn, what they want to make, and also how they want their work to be assessed. "I gradually do this more and more throughout the year," says Jessie. "Students, sometimes, are not used to having a lack of structure in their other classes, so it doesn't come easily to them, at least initially. But if they have the space, they will take full advantage of it, and create some awesome things. So many times, their ideas are way better than anything I could have thought of." Over the course of the year, Jessie's students learn to design effective and thoughtful rubrics for their own work through a gradual process of creative empowerment.

"In the beginning, the projects are very prescribed," says Jessie. In her courses, students begin the year by completing guided labs and projects and taking quizzes on foundational vocabulary and processes. As students build confidence and technical knowledge, they are asked to make more creative choices in customizing their projects. For example, students learning Java in Jessie's AP Computer Science course move from following step by step tutorials, to customizing a chat bot, to working on making anything they want. "We go from taking a project that they just add onto in their own way, to giving them a menu of options. And then by the end of the year, their final project is completely open-ended. They're telling me what they want to learn, how they want to show that they learned it, and how they want me to assess them because they're actually writing their own rubrics at that point."

Proposal

What will you create?

Describe how this is related to computer science.

Why did you choose this as your topic?

What potential problems or challenges do you anticipate?

PROPOSAL PROMPTS. Before designing their rubrics, Jessie's students submit proposals for their projects, which can be anything related to computer science. "I tell them, 'It has to be something you're interested in, because we're going to be doing this for a month.'"

The Rubric Design Process

Jessie finds that using student-designed assessments is more practical when project instructions are open-ended, due to the variety of what students create. “I have struggled with rubrics over the years. Finding a good rubric where, when I look at their work, and think, ‘This is a great project—it matches up with what is actually on the rubric when I assess it,’ has taken a long time,” says Jessie. “I finally have some rubrics that I’m really happy with, where I feel like the numbers bear out the grade that matches all of the effort, time, creativity and work the students put in.” For the more prescribed projects earlier in the year, she uses a **standard rubric** she designed. Students become familiar with that rubric’s structure and use the same broad template to create rubrics for their open-ended projects. In this sense, the form of Jessie’s assessments match the function: she can’t design a rubric that will apply to all of the students’ final projects, but she can use the rubric design process as a tool to both create the appropriate assessments, and teach students to take ownership and responsibility for their work.

AP CS A Coding Rubric						Points Possible:	125
Category	Weight	Beginning - 2	Developing - 3	Proficient - 4	Exemplary - 5	Your Score	Weighted Subtotal
Program specifications / correctness	15	Significant details of the specification are violated, program often exhibits incorrect behavior.	A few details of the program specification are violated, program functions incorrectly in several cases.	Minor details of the program specification are violated, program functions incorrectly in a few cases.	No errors, program always works correctly and meets the specification(s).		0
Bugs	4	Code contains 5-10 compile or runtime errors	Code contains 3-4 compile or runtime errors	Code contains 1-2 compile or runtime errors	Code compiles and runs with no errors		0
Code readability	2	Two major issues with indentation, whitespace, variable names, organization, or code comments.	At least one major issue with indentation, whitespace, variable names, organization, or code comments.	Minor issues with consistent indentation, use of whitespace, variable naming, general organization, or code comments.	No errors, code is clean, understandable, and well-organized. Variable names are appropriate. Code is commented.		0
Output readability	2	Output is difficult to read.	Output is not neatly formatted and easy to read.	Output is usually neatly formatted and easy to read	Output is always neatly formatted and easy to read.		0
Growth Mindset	2	Usually does not approach problems with a growth mindset. Does not take the initiative to solve problems as they arise.	Sometimes approaches problems with a growth mindset, but does not always take the initiative to solve problems as they arise.	Usually approaches problems with a growth mindset. Learns from mistakes, takes the initiative to fix problems as they arise.	Always approaches problems with a growth mindset, asks insightful questions, learns from mistakes, and takes the initiative to fix problems as they arise.		0
What worked well		Room for Improvement				Total Score	0
						Grade	0%
		Expectations for Student Learning					
		<input checked="" type="checkbox"/> Apply and communicate knowledge and skills across disciplines	<input type="checkbox"/> Establish a network of relationships to assist in physical and mental well being				
		<input checked="" type="checkbox"/> Demonstrate intellectual curiosity and academic growth	<input checked="" type="checkbox"/> Demonstrate caring, independence, and resilience				
		<input checked="" type="checkbox"/> Gather, assess, and analyze information to solve problems and make informed decisions	<input type="checkbox"/> Engage in behaviors that foster a commitment to lifelong wellness				
		<input checked="" type="checkbox"/> Apply problem solving skills to diverse challenges in an ever changing society	<input checked="" type="checkbox"/> Understand varying opinions, diverse beliefs and cultural differences by demonstrating respect for self and others				

STANDARD RUBRIC. Jessie uses this rubric for multiple projects throughout the year. Students become familiar with the format and are able to adapt it when creating their own rubrics.

After submitting the proposal for their open-ended projects, Jessie’s students are given a **rubric template** to customize. They don’t need to follow the template exactly. She tells her students, “If you want to have four categories instead of five, or if you want to go for more of a checklist type thing, you can do that too.” Developing their own rubrics helps students envision the specifics of what they might create. “I tell them, ‘Think about what the best version of what you’re going to make looks like, and then think about what the bare minimum version of what you’re going to make looks like. Then, fill in-between to create a continuum of quality,’” says Jessie. “That gets them thinking about what a finished project looks like, and what a ‘good one’ versus a ‘not-so-great one’ is.”

Rubric

Category	Beginning (6)	Developing (7)	Proficient (8)	Exemplary (10)

RUBRIC TEMPLATE. The structure of Jessie’s rubric template resembles her general rubric, which students grow accustomed to seeing throughout the year. Students can choose to design their own assessments based on this template or decide to create their own.

Students start working on their projects after they’ve finished designing their rubrics, but they have a short window to change their rubrics if they decide to go in a different direction with their overall project. “I set a cutoff date about three to four class periods after the original rubric was due. Usually, that is enough time for them to figure out if their original idea is just not going to work,” says Jessie. “There’s a couple of kids every year that happens to.” It’s important to Jessie that students do not change their rubrics once they’ve gotten deep into their work, since observing discrepancies between their original rubric and eventual final product is a key part of the experience for both the student and for Jessie.

“I don’t let them change it after that because I want them to have the experience of thinking about the scope of the project and how the project changes over time.” As the weeks go on, many students realize that their project might not reach the “exemplary” category on the rubric they designed—which is fine with Jessie. “They write the rubric in the beginning, and it’s all of their hopes and dreams for what they want their project to be,” says Jessie. “And then they go through the process and, very often, will realize, ‘Oh, this takes way longer than I thought.’ I tell them I’m totally okay with that because that’s how software development is in the real world. People who are project managers for ten or fifteen years make attempts to budget the time and scope of their projects, but often these change significantly as the project goes on!”

Using Student-Designed Assessments

Knowing that students’ final products may not reach the heights they had initially envisioned by the due date, Jessie incorporates additional self-assessment to supplement the student-designed rubric. “At the end, they do a reflection. They use Screencastify on their Chromebooks and talk to me, telling me what grade they would give themselves based on their original rubric.” Hearing students talk about their projects and rubrics, Jessie gains insight into not only what students created, but also what they learned during the process. For example, one student wanted to design a Chrome extension that would refresh a webpage and buy popular items as soon as they were released. He spent weeks working on it but encountered several issues that made his final product unworkable. In his **reflection video**, he described the problems and his attempts to solve them. “He really went into detail about all the things he tried to solve it,” remembers Jessie. “I think that’s a really valuable experience as well.”

Final Project Reflection

Make a screencast using screencastify and:

1. Give yourself a grade **based on the rubric you wrote**
2. Summarize the most challenging parts of the project for you
3. Describe what you learned by doing the project
4. Explain what grade you think you *deserve* and **why**. Be specific.

You may find it helpful to have your project proposal on the screen while you talk through these points. You could create a short slide deck to talk through if you wish. If your project can be demo'd on a chromebook, you might talk about these things while showing your project. **It is up to you.**

Please keep these videos under 2 minutes.

REFLECTION VIDEO PROMPTS. Jessie's students create self-assessment video reflections communicating both what they've learned through the process of making their final project, and what grade they would give themselves based on their rubrics.

Although Jessie's students are encouraged to challenge themselves to meet the standards of the rubrics they designed, their final self-assessment process embraces the complexity and nuance of assessing creative work. Ultimately the rubrics are used as a tool to help Jessie communicate with students about their projects, rather than as an all-knowing quantifier of student learning. "I don't really worry too much about the rubrics on a day-to-day basis," she says. "I'm more focused on guiding them, and asking what are you going to make and how are you going to get there? What do you know and what do you need to know? Or maybe you don't know what you need to know, but let's start doing stuff, and you'll figure it out as you go along. Assessment is something that's always in the background, but on a day-to-day basis I try to focus more on the process and the learning in the classroom, because it all feeds into whatever the ultimate assessment is."

The final assessment takes all of these assessment artifacts into account. Jessie determines the final grade each student receives by looking at their rubrics, reflection videos, and final product, putting these artifacts in conversation with each other. "If they can compellingly explain to me what they learned, and why they think they deserve an A, then I'm happy to agree with them on that," says Jessie. "My kids have been really insightful and honest. Students might say, 'I think it could be a little better, so I think it's only an A-,' or 'Maybe according to this rubric, it would be a C. But I feel like I had a really valuable experience because I learned how to do this thing I had no idea how to do. It took way longer, but I feel like that's valuable.'"

Reflection Questions

- How do I currently communicate with students about assessment?
- How do my students set expectations for themselves and their work?
- What could it look like if students designed their own assessments in my classroom?

ASSESSMENTS

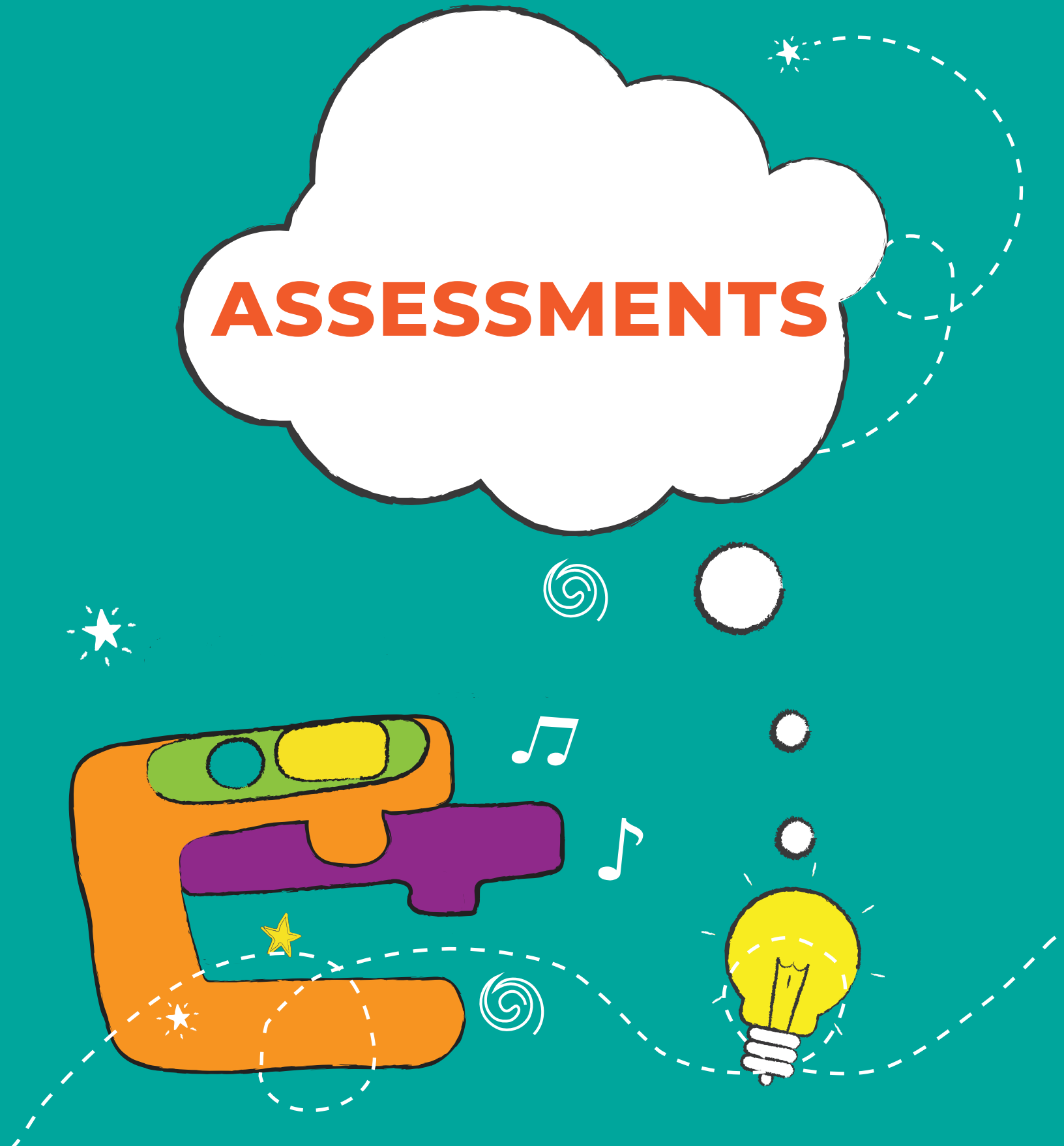
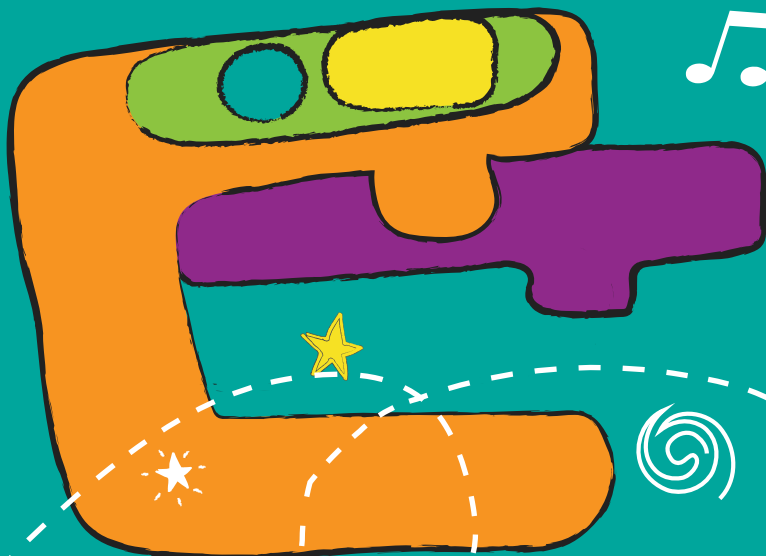

01 FAMILY SCRATCH CHALLENGE

JEREMY

“I sent this challenge home, and I didn’t expect too many students to do it. But I was getting bombarded every morning by the kids either emailing me or bringing it back saying, *Can I do another one? Can I do another one?* I think it helped the parents get an understanding of what Scratch is. You got parents engaged, you got the kids excited. It got the year to start off well.”

Family Scratch Challenge

Challenge #1

Hello, Grades 3–7 Families,

I hope this letter finds you well and enjoying the fall weather!

Your child/children have started the school year using Scratch coding during their STEAM/Computer Science classes. Like any other content area, students have a variety of understanding and interest in coding. As a teacher, my goal is to generate an interest in computer science in my students so they have a general understanding of some of the skills necessary for the 21st century. In order to build and strengthen these skills, I am creating a series of Scratch Challenges for the students to work on at home. These are not mandatory, nor will they be used for grading. The purpose is to engage students in coding outside of school and conversing about the information with family members by creating and exploring the features of Scratch. After you return the backside form, challenges will be sent out via email through the Google Classroom platform.

All students who complete and return the form on the backside will be entered into a monthly raffle. Forms are due whenever you complete the challenge. Challenges will occur every other week to start the year and will eventually become more challenging as their Scratch skills emerge.

If you have any questions, please do not hesitate to contact me at teacher@email.com. If you are on Twitter, please feel free to follow me [@TeacherTwitter](https://twitter.com/TeacherTwitter) for updates from my classes.

I look forward to working with you and your family during the school year. Thank you very much for your time!

Sincerely,

Teacher

So without further ado, I present challenge number 1... (dramatic pause) ... (turn over this page)

Family Scratch Challenge

Challenge 1: You and a Family member spend 20 - 30 minutes together using Scratch. Identify 2 things you found really cool/enjoyed and 2 things that you are unsure of and want to learn more about. That's it!

Name of Student: _____

Name of Family and relation to student: _____

Parent email address: _____

2 Cool Things:

1) _____

2) _____

2 Things We Want to Learn More About

1) _____

2) _____

* Parents, if you can get a picture of you and your child using Scratch, please email it to me.
Thanks again!

02 SCRATCH PROJECT RUBRIC

JANET

“I co-wrote this rubric for the district. If we’re having a unit in the district, in this public school, there needs to be an assessment piece. So we wrote rubrics because that’s what you do. And we populated it, thinking, *Where would we think a student is exceptional?* But we can’t only look at the rubric. Let’s look at the rubric, let’s look at the reflection journal, let’s look at the projects, let’s take notes while watching the kids.”

Student Name/Class

Scratch Project Title

Date

Project Design	Exceptional	Proficient	Developing	Beginning
Remixing	I created my own background(s) and sprite(s).	I remixed or changed both background and sprite.	I changed the cat or changed the background.	The cat was my sprite and the background was white.
Interactive	My project has many interactions and is easy to use without instructions.	My project is interactive and has clear instructions.	I am working to make it more clear how to interact with my project.	I have not yet added a way to interact with my project.
Events	I have many sequences of events in my project that all follow a logical pattern.	The sequence of events in my project follows a logical pattern.	The sequence of events in my project sometimes follows a logical pattern.	I am still organizing the sequence of events in my project.
Parallelism	In my project more than 2 things are happening at same time.	In my project 2 things are happening at same time.	I am working on figuring out how to make 2 or more things happen at the same time.	In my project only 1 thing is going on at a time.
Programming	Exceptional	Proficient	Developing	Beginning
Blocks	I used blocks from 4 or more different categories in my project.	I used blocks from 3 different categories in my project.	I used blocks from 2 different categories in my project.	I used blocks from 1 or fewer categories in my project.
Loops	In my project, I used both loops and duplicating to create repeating actions.	In my project, I only used loops to create repeating actions.	In my project, I only used duplicating to create repeating actions.	My project does not have repeating actions.
Testing & Debugging	I completely debugged my project on my own.	I completely debugged my project with some help.	I am testing and debugging, sometimes with help.	I am testing and debugging with my teacher's help.
Process	Exceptional	Proficient	Developing	Beginning
Being Iterative	I tested my scripts a few blocks at a time as I created my project.	I stopped and tested my program in random places.	I tested my scripts when reminded.	I did not test my program.
Time Management	I finished all of my design notebook questions and my Scratch project before the end of class and used the extra time to make improvements in both.	I used project time well and met all deadlines.	Sometimes I was able to meet deadlines.	I need to find new ways to complete my tasks to meet deadlines.
Reflection	In my notebook, I clearly express my thoughts in different ways about the questions I am asked. I also write my own notes. I review my notebook, and use what is there to help improve my work.	In my notebook, I clearly express my thoughts in different ways about the questions I am asked.	In my notebook, I answer the questions I am asked.	With help, I answer the questions I am asked in my notebook.

03 CAPSTONE PROJECT MENU

JOSHUA

“With this capstone project in fourth and fifth grade, we developed some basic requirements that we thought that all students should be able to do. And then we upped the ante a little bit with the advanced project requirements.”

Capstone Project Menu



Mild

Create a working game in Scratch that includes the following:

- ❑ Use motion blocks to [program your main sprite](#) to move toward target sprites. [Add at least one target sprite](#) and motion blocks to make it move.

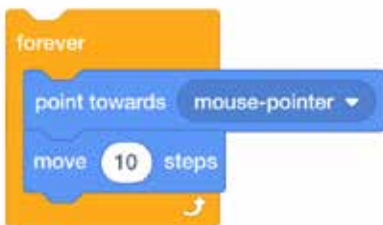

- ❑ [Create a variable](#) called score. Use a [conditional and variable to add a score](#). Remember to set score to 0 when you click the green flag.



Medium

Create a working game in Scratch that includes the following:

- ❑ [Create a variable and name it timer](#). Program a working timer to add a challenge for your players.

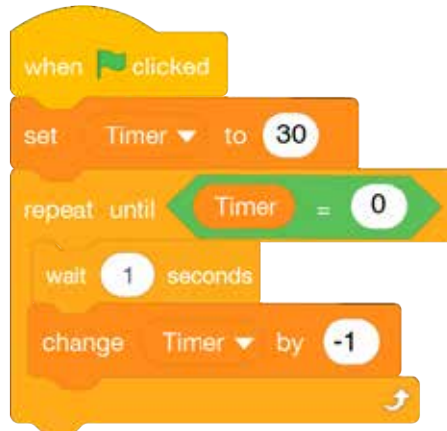

- ❑ Make one target sprite add points and another sprite subtract points.



Spicy!

- ❑ Create your own custom background or [sprite](#) using [paint editor tips](#).
- ❑ Add a [music loop](#).



- ❑ Add a [sound effect inside of a conditional](#).



- ❑ Make a background that changes to create multiple levels of your game.



04 SCRATCH PROJECT REVIEWS

JACQUELINE

"This was the students' way of assessing each other's work, which was a wonderful way because creativity breeds more creativity. So in all these instances, when they look at each other's work, they're connecting and it's another way again, because they're like, *Oh, I never would've thought of that, or, That's such a cool idea.* So many of them, after they assess each others' work, wanted to go back and do some more, given the exposure that they had to others' work. Ideas come from ideas. So, the more you expose yourself to ideas, I think the greater your 'database' of creativity could be."

Name of person who created the Scratch Project _____

Grade/Class _____

Computer Number _____

Please be thoughtful and on task/topic.

Name of reviewer (YOU)	
Compliments (What did you LIKE ?)	
Suggestions (How could it be IMPROVED ?)	
Other (Something else you'd like say?)	



Name of person who created the Scratch Project _____

Class _____

Computer Number _____

Please be thoughtful and on task/topic.

Name of reviewer (YOU)	
Compliments (What did you LIKE ?)	
Suggestions (How could it be IMPROVED ?)	
Other (Something else you'd like say?)	

05 STORYTELLING WITH SCRATCH REFLECTION

KATRINA

“One of the things I really love to read is students’ personal reflections. This is individual writing, and I love to hear how they process this. The other thing that I’m trying on my own time is to interview students and listen to how they talk about their projects. I find that the conversation is where we learn the most about their learning.”

Name : _____

STORYTELLING WITH SCRATCH
UNIT 5: ELA INTEGRATION PROJECT
SCRATCH PROJECT REFLECTION



1. What are you most **proud** of about **creating** your project?

2. What was the most challenging part of building your project? How did you **persevere** and overcome this challenge?

3. Did you have to **debug** any issues in your project? How did you spot the bug and what did you do to fix it?

4. How was telling a story in **Scratch** similar to writing a story on paper? How was it different?

5. Did you like using Scratch to publish your next chapter or scene? Why or why not?

6. How were you able to use **peer feedback** to help you modify your project?

7. Which one of these thinking skills did you use the most in your project, **Logic, Evaluation, Algorithms, Patterns, Decomposition, Abstraction**? How?

06 SELF ASSESSMENT

JERRY

“When kids are working in groups, we were really struggling with making sure the kids get the grade they deserve. So we tried to figure out ways to deal with that. I don’t want this assessment to be the be all end all—the assessment is more for me to know how they feel about the project. The kids fill out the student self-assessment first, just to see where they land, how they feel about their project. Did they give it their best? Kids can be really brutal in their self-assessment, but it’s good to get them to reflect and really tell me why.”



Student Self-Assessment Grades 3-5



Use the following scale to evaluate your performance on this project.

Empty Bowl	- I did not meet the requirements of the project.
1 Scoop	- I met some, but not all of the requirements of the project.
2 Scoops	- I met the requirements of the project
Extra Toppings	- I went beyond the requirements of the project by giving my best effort and adding something extra.

I feel like my group could not have accomplished this project without my help.

Empty Bowl 1 Scoop 2 Scoops Extra Toppings

Our project was edited for correct use of grammar and mechanics.

Empty Bowl 1 Scoop 2 Scoops Extra Toppings

I feel my project covered all of the information and answered the question that was given to me.

Empty Bowl 1 Scoop 2 Scoops Extra Toppings

I feel that I worked with my group very well and we synergized.

Empty Bowl 1 Scoop 2 Scoops Extra Toppings

I worked really hard and did my fair share for my job.

Empty Bowl 1 Scoop 2 Scoops Extra Toppings

Each student pulled their fair share in our project.

Empty Bowl 1 Scoop 2 Scoops Extra Toppings

Our project included good activities and I felt that the other students learned something from it.

Empty Bowl 1 Scoop 2 Scoops Extra Toppings

I am very proud of my project.

Empty Bowl 1 Scoop 2 Scoops Extra Toppings

The grade I would give myself for this project would be a/an _____

because _____

Someone in my group I thought did an excellent job is _____

I thought they did a great job because _____

07 CAPSTONE PROJECT FEEDBACK

JOSHUA

“I tell students that my state says we have to have an adult in the classroom. So I guess I’ll do that, because I’m taller than all of them. But I’m learning right along with them. I’ll have a kid ask me, *How do I do this?* And I’ll go, *I don’t know. Let’s figure it out. Or, Does anybody know how to make this happen?* And then you’ll have a kid that will know. You can’t be afraid of not knowing. Because you’re trying to teach these kids to be lifelong learners.”



CAPSTONE PROJECT FEEDBACK

FEEDBACK BY: _____
PROJECT BY: _____

SHARE 2 LIKES AND A REQUEST

Share **two** things you like about a classmate's project.

Share **one** way to improve their project.

	<p>My favorite part was _____ _____</p> <p>I like the way you _____ _____</p> <p>I'm excited to learn how you _____ _____</p>
	<p>What if _____ _____?</p> <p>Next time, try _____ _____</p> <p>An idea I had is _____ _____</p>

08 SCRATCH PROJECT: EXPLORER INTERVIEW RUBRIC **APRIL**

“Look at a rubric as not only a way of having point values, but also how students could push themselves to go beyond the minimum requirements. It’s a way for students to be reflective throughout their process. You could think about it in terms of being really clear how a student could meet minimum requirements, and how they could exceed it, and that might open up the possibilities for the creativity to happen naturally.”

Name: _____ #: _____ Date: _____ Homeroom: _____

Scratch Project: Explorer Interview Rubric

	4 - Exceeds Expectations	3 - Meets Expectations	2 - Working Toward Expectations	1 - Struggles to Meet Expectations
<p>Content - Interview</p>	<ul style="list-style-type: none"> <input type="checkbox"/> Included accurate information from reliable sources <input type="checkbox"/> Wrote script/interview in complete sentences, with proper grammar <input type="checkbox"/> All 5 questions focused on... <ul style="list-style-type: none"> <input type="checkbox"/> where the explorer came from <input type="checkbox"/> the purpose of his expeditions <input type="checkbox"/> the outcome and effects of the expedition(s) on the explorer, the crew, and the native people (successful or not) <input type="checkbox"/> any challenges and obstacles faced <input type="checkbox"/> Used <u>relevant</u> vocabulary from the Explorers Unit of Study (see vocabulary sheet) 	<ul style="list-style-type: none"> <input type="checkbox"/> Included accurate information from reliable sources <input type="checkbox"/> Most of script/interview was written in complete sentences, with proper grammar <input type="checkbox"/> At least 4 questions focused on... <ul style="list-style-type: none"> <input type="checkbox"/> where the explorer came from <input type="checkbox"/> the purpose of his expeditions <input type="checkbox"/> the outcome and effects of the expedition(s) on the explorer, the crew, and the native people (successful or not) <input type="checkbox"/> any challenges and obstacles faced <input type="checkbox"/> Used <u>relevant</u> vocabulary from the Explorers Unit of Study (see vocabulary sheet) 	<ul style="list-style-type: none"> <input type="checkbox"/> Included mostly accurate information from reliable sources <input type="checkbox"/> Some of script/interview was written in complete sentences, with proper grammar <input type="checkbox"/> At least 3 questions focused on... <ul style="list-style-type: none"> <input type="checkbox"/> where the explorer came from <input type="checkbox"/> the purpose of his expeditions <input type="checkbox"/> the outcome and effects of the expedition(s) on the explorer, the crew, and the native people (successful or not) <input type="checkbox"/> any challenges and obstacles faced <input type="checkbox"/> Used <u>relevant</u> vocabulary from the Explorers Unit of Study (see vocabulary sheet) 	<ul style="list-style-type: none"> <input type="checkbox"/> Information had several inaccuracies and information was not always from reliable sources <input type="checkbox"/> Some of script/interview was written in complete sentences, with proper grammar <input type="checkbox"/> At least 2 questions focused on... <ul style="list-style-type: none"> <input type="checkbox"/> where the explorer came from <input type="checkbox"/> the purpose of his expeditions <input type="checkbox"/> the outcome and effects of the expedition(s) on the explorer, the crew, and the native people (successful or not) <input type="checkbox"/> any challenges and obstacles faced <input type="checkbox"/> Used <u>relevant</u> vocabulary from the Explorers Unit of Study (see vocabulary sheet)
<p>Programming - Scratch Script</p>	<p>Created a Scratch algorithm that includes 4 or more of the following...</p> <ul style="list-style-type: none"> <input type="checkbox"/> Loops <input type="checkbox"/> Sprites with motion <input type="checkbox"/> Events 	<p>Created a Scratch algorithm that includes 3 of the following...</p> <ul style="list-style-type: none"> <input type="checkbox"/> Loops <input type="checkbox"/> Sprites with Motion <input type="checkbox"/> Events 	<p>Created a Scratch algorithm that includes 2 of the following...</p> <ul style="list-style-type: none"> <input type="checkbox"/> Loops <input type="checkbox"/> Sprites with Motion <input type="checkbox"/> Events 	<p>Created a Scratch algorithm that includes 1 of the following...</p> <ul style="list-style-type: none"> <input type="checkbox"/> Loops <input type="checkbox"/> Sprites with Motion <input type="checkbox"/> Events

	4 - Exceeds Expectations	3 - Meets Expectations	2 - Working Toward Expectations	1 - Struggles to Meet Expectations
Presentation	<input type="checkbox"/> Clear, well-paced recording with expressive speaking voice <input type="checkbox"/> Creative development of ideas <input type="checkbox"/> 2 sprites (explorer and interviewer) <input type="checkbox"/> 1 background that reflects interview and ideas	<input type="checkbox"/> Clear, well-paced recording <input type="checkbox"/> Development of ideas met outlined expectations <input type="checkbox"/> 2 sprites (explorer and interviewer) <input type="checkbox"/> 1 background that reflects interview and ideas	<input type="checkbox"/> Recording was mostly clear and well-paced <input type="checkbox"/> 2 sprites (explorer and interviewer) <input type="checkbox"/> 1 background that reflects interview and ideas	<input type="checkbox"/> Recording was not clear and well-paced <input type="checkbox"/> 2 sprites (explorer and interviewer) <input type="checkbox"/> 1 background that may not reflect interview and ideas
Collaboration	Always... <input type="checkbox"/> Worked effectively & communicated clearly with partner <input type="checkbox"/> Solved problems effectively, and tried multiple ideas to find a solution <input type="checkbox"/> Focused and used time wisely <input type="checkbox"/> Followed through with project plan	Mostly... <input type="checkbox"/> Worked effectively & communicated clearly with partner <input type="checkbox"/> Solved problems effectively, and tried multiple ideas to find a solution <input type="checkbox"/> Focused and used time wisely most of the time <input type="checkbox"/> Followed through with project plan	Sometimes... <input type="checkbox"/> Worked effectively & communicated clearly with partner <input type="checkbox"/> Solved problems effectively, and tried multiple ideas to find a solution <input type="checkbox"/> Focused and used time wisely most of the time <input type="checkbox"/> Followed through with project plan	Struggled to... <input type="checkbox"/> Work effectively & communicate clearly with partner <input type="checkbox"/> Solve problems effectively, and try multiple ideas to find a solution <input type="checkbox"/> Focus and use time wisely most of the time <input type="checkbox"/> Follow through with project plan
Independent Work	<input type="checkbox"/> Made independent contributions that exceed project expectations	<input type="checkbox"/> Made independent contributions that meet project expectations	<input type="checkbox"/> Independent contributions somewhat meet project expectations	<input type="checkbox"/> Independent contributions did not meet project expectations

Total: _____

Comments: _____

09 CLOUD ANIMATION REFLECTION

LESLIE

“I try to get students to write something out about themselves, as opposed to about clouds, because they have been learning and writing about clouds in science class. But I’m asking them to write more about what part of the technology did they find interesting. Was there a favorite part? What was the hardest part?”

Cloud Animation Portfolio Project Reflection

Artifact/Project Name: Animated Cloud

Artifact/Project Description: I used Paint to draw a background and a cloud. I programmed my cloud to move in Scratch and made a movie.

What did I learn as I worked on this project?

I learned how to use Scratch. Fill a background.

The hardest part was to make a background.

My favorite part was to do the coding.

Cloud Animation Portfolio Project Reflection

Artifact/Project Name: Animated Cloud

Artifact/Project Description: I used Paint to draw a background and a cloud. I programmed my cloud to move in Scratch and made a movie.

What did I learn as I worked on this project?

I learned how to use Scratch, and to create the cloud.

The hardest part was following all the directions.

My favorite part was coding.

Cloud Animation Portfolio Project Reflection

Artifact/Project Name: Animated Cloud

Artifact/Project Description: I used Paint to draw a background and a cloud. I programmed my cloud to move in Scratch and made a movie.

What did I learn as I worked on this project?

I learned how to do coding.

I also learned how to fill a background.
The hardest part was saving the picture to the folder.

My favorite part was coding.

Cloud Animation Portfolio Project Reflection

Artifact/Project Name: Animated Cloud

Artifact/Project Description: I used Paint to draw a background and a cloud. I programmed my cloud to move in Scratch and made a movie.

What did I learn as I worked on this project?

I learned how to make the cloud move with codes.

I also learned how to use Scratch 2.0

The hardest part was making the cloud.

My favorite part was making the cloud move.

Cloud Animation Portfolio Project Reflection

Artifact/Project Name: Animated Cloud

Artifact/Project Description: I used Paint to draw a background and a cloud. I programmed my cloud to move in Scratch and made a movie.

What did I learn as I worked on this project?

~~I learned to do coding and I learned how to make the~~

The hardest part was two shape fill

cloud bounce

My favorite part was coding

10 FOOD CHAIN ANIMATION RUBRIC

MONICA

“This rubric has allowed me a lot more flexibility on how I score them, because there’s no numbers. So it’s not like I just average. I kind of look and go, *Yes, this wasn’t as good, but these areas were good.* When I do this with my students, I star the important areas that weigh heavier. I looked at every single project, and I wrote comments in every single box. The rubric had flexibility to it.”

Name: _____ Partner: _____

Food Chain Animation Rubric		
Concerns <i>Areas that need work</i>	Criteria <i>Standards for this project</i>	Advanced <i>Evidence of Exceeding standard</i>
	Storyboard: It is easy to read, and all elements are clearly written, labeled, or drawn that another student could fully understand what would happen if a virus affected the food chain.	
	Creativity: Student clearly explored and expressed multiple ideas in a unique way.	
	Required Organisms: All the organisms from your ecosystem are in the animation.	
	Programming: Use various programming blocks to express your animation. I.E. Costume block, Change Background, Broadcast, Loop Block, Controls, Variables, and Motions	
	Labeling: Project is clearly labeled with their location	
	Initiative: Student encounters complications with a positive attitude and perseveres to problem-solve independently without needing to seek assistance.	

11

PEER FEEDBACK: STORYTELLING PROJECT

KATRINA

“We use peer feedback after every project, before they showcase their work. During the showcase, every student goes up and presents their project to the class. And before they present, they call on two people, one to give them a wish, and one to give them a star. They call on whoever they would like to question them, and they are able to get some feedback and then make changes too.”

Storytelling Project with Scratch

Names: _____

Partners' Names: _____

Project Name: _____



Scene 1:

- It is clear what my partner's book is
- There are two main sprites (characters)
- The backdrop matches the setting
- There is dialogue between the characters
- The code runs smoothly (no bugs)

Scene 2:

- The backdrop changes in scene two
- The sprites (characters) continue their dialogue
- The program switches backdrops and sprite costumes without bugs

Evaluation

- The sequence of events makes sense
- There are no bugs when I run the program
- Hide/show blocks are used for sprites that don't belong in the scenes
- The code is "cleaned-up" - there are no unused blocks

Written Feedback: *Then you can comment your feedback on their project page!



TWO STARS



WISH



12

PROJECT DESIGN PROMPTS

JEREMY

“In terms of computer science, and Scratch, assessment allows me to see what the kids are doing. I kind of just pop in as they’re working and just give them a verbal prompt, or ask, *What would happen if you did this?* Just so that I can kind of know what they’re thinking. I ask them, *What if that did this, or switched this?* Just having a conversation shows me more than what I can see on their screen.”

Project Design Prompts

Prompts	Answers
What are you creating? What will it teach or inform other people about? Explain how it will help others.	
What age level is it appropriate for?	
Explain how you will use Scratch in your project.	<i>I will use Scratch in my project by...</i>
Are you using just your computer? Yes or No? Will you need a Makey Makey?	
Do you need poster paper? Do you need cardboard?	
What other supplies (printouts, paint, crayons, etc.) will you need? If you need printouts, be sure to email, share, or send me the link to the pictures.	

13

PRACTICES REFLECTION

GINA

“They do this themselves and then at the end when I’m returning their grades I fill this out for them as well, so they know what they can work on for next time and what they did good at and how they can help someone else. Every big grade, I usually talk to each student about what they did well and what they didn’t do well, and how they can do better for the next one.”

Practices Reflection

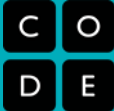

Practice	Things to Celebrate	Things to Work On
Problem Solving		
Persistence		
Creativity		
Collaboration		
Communication		

14

SCRATCH GAUNTLET

JEREMY

“I try to find things that are relevant to students, like the Avengers, or other pop culture, just so they have a little more buy in. There are six stones on the worksheet. Each stone represents, on Scratch, motion, sound, looks, event, control, and then whether their project actually works. For example, students had to have three different movements of a sprite. Once they did that, they could color in that stone.”

Scratch Gauntlet

Using Scratch, create a scene that shows something that you enjoy doing. It can be something you enjoy in school or at home. You must use the 5 categories below. Once you have successfully completed the requirement and I have checked it off, you can color in that stone. Once you have completed all 5 requirements and your scene successfully and clearly shows a scene that shows something you enjoy doing, you can color in the 6th stone and become the most powerful creative coder in the galaxy!

<u>Category</u>	<u>Color</u>	<u>Requirement</u>
Motion	Blue	Sprite must move in at least two different directions.
Looks	Purple	Sprite must change appearance at least twice.
Sound	Magenta	Scene must have at least two different sounds
Events	Yellow	Scene must have two different events that two different things (sprites, backgrounds, etc.)
Control	Orange	Scene must have at least two different control blocks

Once you've completed all requirements and your scene works:

Color the middle stone Green!

You can go for more coding power by completing the next level challenge!

15

CAPSTONE PROJECT PLANNING

JOSHUA

“The capstone project in fifth grade and fourth grade is where students really shine. They have to plan everything, from prep to understanding the concept of their game, activity, story, or mini animation movie. They have to do all of that on their own.”

CAPSTONE PROJECT PLANNING

PROJECT PLANS BY: _____

Use the prompts below to start thinking about the elements needed to develop your project.

MY PROJECT

Circle the type of project you want to create.



Game



Story



Animation



Art

Describe the project you want to create.

List the steps needed in order to create your project.

- _____
- _____
- _____
- _____
- _____
- _____
- _____
- _____
- _____
- _____

Example Steps:

- Add a backdrop
- Add a sprite
- Code the sprite to move left and right
- Code the sprite to move up and down
- Add a 2nd sprite
- Code the 2nd sprite to move randomly
- Add a score
- Add a 2nd backdrop
- Create an ending sprite

PROJECT SKETCHES

PROJECT SKETCHES BY: _____

Use the space below to draw sketches of what your project will look like!

MY PROJECT SKETCHES

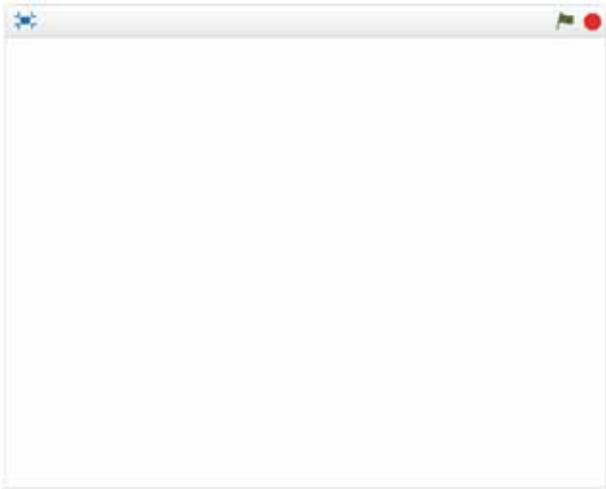

What's happening? What are the important elements?

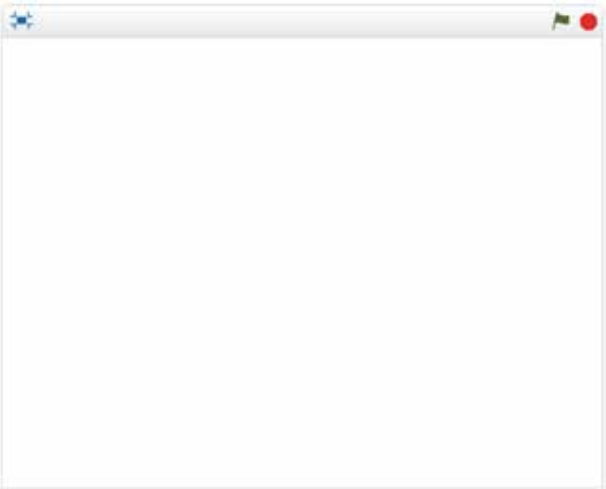

What's happening? What are the important elements?

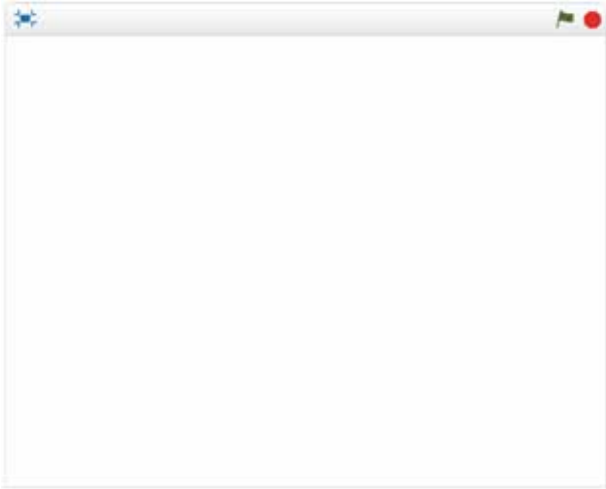

What's happening? What are the important elements?

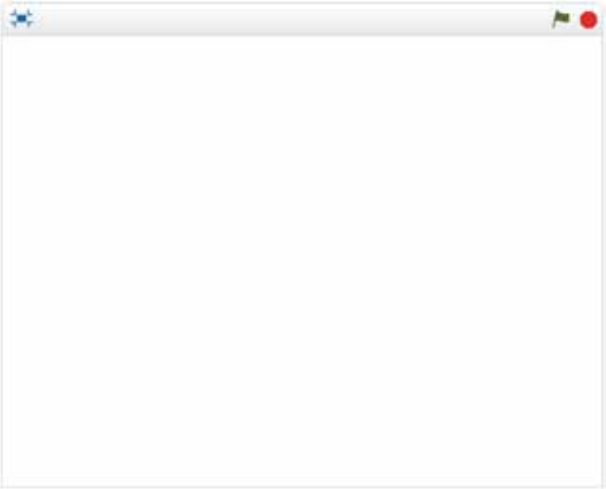

What's happening? What are the important elements?

16

TOUR GUIDE PROJECT RUBRIC

OSCAR

“I have found that nothing moves kids forward more than informal feedback in the classroom. What I like about a rubric is, I can just point to, *Oh, I don't see this thing*. Students can't say, *Oh, I didn't know you had to have that*, because it's on the list. Then they can show me where it is, if I've missed it, or if they've done something creative and it's not obvious. The actual feedback is really in the moment when they're working, like a studio class. I've never found anything better than that.”

Tour Guide Project Rubric

Student Name:

Scratch Username:

Reviewed by -		Teacher Review	
Planning document complete		Planning document complete	
Shared in About Me studio		Shared in About Me studio	
Switch backdrop blocks used		Switch backdrop blocks used	
Narrator is animated		Narrator is animated	
Mild- 3 backgrounds used		Mild- 3 backgrounds used	
Medium- 4 backgrounds used		Medium- 4 backgrounds used	
Spicy- 5 backgrounds used		Spicy- 5 backgrounds used	
Credit is given for backgrounds		Credit is given for backgrounds	
Project is initialized		Project is initialized	
Wait blocks used to sync action		Wait blocks used to sync action	
Sounds play in the project		Sounds play in the project	

Teacher Feedback:

17

SCRATCH SCAVENGER HUNT

JANET

“Assessment means a million things, like how you move a student from A to B, how you were able to give minimal criteria and students were able to achieve it. Sometimes assessment is a barrier for growth, because people feel like if they can’t assess it, they can’t teach it.”

Scratch Scavenger Hunt

Get to know other participants find a different person to sign each block on this card. Put your name on the card. The first registered student to hand in a completed card will receive a prize.

Name _____

I can remix a Scratch project	I use loops to shorten my script	I can debug simple problems
I used LEGO WeDo with Scratch	I have used operations blocks	I have a Scratch account
I made a game in Scratch	I make my own Sprites	I created 3 or more Scratch projects
I have been to a Scratch Day event	I made my own block	I have a project that moves to a new stage
I used Makey Makey with Scratch	I used video sensing blocks	Has added sound to a project

18 DESIGN BRIEF

TARA

“When I was in high school, I remember we had to solve math problems in a very specific way. If you didn’t solve those problems using those steps that your teacher taught you, you got points taken off. Even if the answer was correct. I tell my students that there are so many different ways to get to the right answer. I encourage them to think about all the different ways that they can get to that answer, and I don’t tell them how to solve that problem.”

Design Brief

Your Name: Student

Client:	My 3 year old cousin
Designer: <i>(Your Name)</i>	Student
Problem Statement: Use complete sentences to describe the problem you were asked to solve	I need to make a bubble wand for my little cousin.
Design Statement: Describe what did the client want or need to be done (Criteria). Were there any special instructions?	I am going to design a bubble wand that is a pixelated christmas tree for my little cousin.
Constraints: Describe any limitations or specific rules that you were required to follow.	None that I remember. My problem is that I don't know how to use tinkercad or how to make a bubble wand.
Deliverables: Describe the final product you produced. What were some of the redesigns? What were some of the recommendations?	I will create a 3D model of a pixelated bubble wand

19

SUB DAY SCRATCH GAME RUBRIC

BROOKE

“You’re going to have a lot of different outcomes. You have to look at what skills you’re trying to evaluate, and then grade on that, but also be open to the fact that this student is going to look different than this other student. Again, just telling them, *This looks like the skills are emerging, but the creativity is awesome. You put a lot of your own skills and your own elements. I’m not going to see another student doing exactly this.*”

Sub Day Scratch Game Rubric

Do Now: Think about your go to games when you get done with computer work early and list them out:

Task: Today you are going to be building off the coding skills we have learned over the past three weeks on various platforms. You will login to your Scratch account at Scratch.mit.edu and create a game. It can be however simple or complex you want to make it, but it does need to be **playable, have a specific goal, include a point system.**

	Developing	Proficient	Advanced
Game Function	Some game mechanics are functional, but some are not. Arrow keys or clicker may not do what was intended.	All game mechanics function. Utilizes clicker or arrow keys for actions, game responds to the appropriate function.	All game mechanics are functional. Game responds to clicker and/or arrow keys and includes additional functions.
Goal	Goal may be clear, but game does not function well enough to be able to win or goal is unclear.	Clear goal, may be simple design, possible to win.	Clear goal (how to win) and it is challenging and possible to win.
Point System	Score box may be missing or does not add points, as intended.	Score box may be in the way, but still collects points, as intended.	Score box on page is in an easy to see place and does not block the gamer from seeing game components. Score box is functional.

20 WEBSITE EVALUATION FORM

DENNIS

“You want it to be more about them holding each other accountable and learning from each other. The feedback that they get helps them be more reflective and metacognitive about themselves. This was a note to parents to sit down with their student and fill out this form with their student guiding them, and they were supposed to put on the hat of a CEO or an entrepreneur. Then, we’d have a day where the students would assess each other with a similar form, but looking at it as a client or a customer.”

Website Evaluation Form

DIRECTIONS FOR VOLUNTEER:

Dear Parent/Sibling/Friend/Older-Than-6th-Grader Volunteer: The 6th grader that handed you this form is currently finishing up their Computer Arts Rotation Course and they were given this form as a way to bring their project outside of school and into the real world, in a way. Their project consisted of the creation of a "pretend" company for which they designed and built a website component for. Your job is to take a few minutes and sit down with your student, who will take you through their website and hopefully persuade you to become a customer, client, member, etc. of their company. Please put yourself in the mindset of a potential customer and respond to the form below from that standpoint.

* Please keep in mind that the student is currently working on finishing a commercial for their company that will go on the homepage .

DIRECTIONS FOR STUDENT:

Please sit down with your Evaluator Volunteer and take them through your website. They will use your site to fill out the form below. Remember you are the CEO of your company and it is up to you to "sell" your company to your evaluator. Also don't forget that there are a couple of questions at the end directed at you, which you should fill out yourself.

DUE: Wednesday, 6/1

Email address *

Who is in charge of the company (student name)? *

Who is the evaluator? *

What do you think of the website layout? *

How it's organized, how it flows, etc.?

- Well organized
- Adequately organized
- Not well organized
- Other: _____

What do you think of the website visual "scheme"? *

The logo, the background, the colors, the fonts, etc.?

- Consistent and eye-catching
- Mostly consistent
- Random and arbitrary
- Other: _____

Did the Homepage give you a good, general idea of what the company is all about? *

- Yes
- No
- Other: _____

Did the About give you enough information about what the company does, why they exist, who is in charge, and how to find them? *

- Yes
- No
- Other: _____

Did the Ordering (etc.) page make it easy to purchase the company's products (etc.)? *

- Yes
- No
- Other: _____

Overall, how would you rate both the professionalism and uniqueness of this website? *

- Very professional and unique
- Somewhat professional and unique
- Not professional or unique
- Other: _____

As a casual visitor of this website, did it do its job of getting you interested in ordering from this company and/or purchasing their services? *

Assuming/pretending that you are the target audience/demographic for this company.

- Yes
- No
- Other: _____

What improvements or changes could be made to this website?

The student can help answer this as well.

STUDENT REFLECTION: Now that you've completed a professional website, what would you change about it if you could do it again? What would you have done differently in general during the process of making it?

STUDENT: what final grade would you give yourself on this project keeping in mind both the process of building the website and the final product?

- A
- B
- C
- D
- F
- Other: _____

21

APP INVENTOR ASSESSMENT

CASEY

“Assessment is a way of knowing whether students are getting it or if they need extra help. Some kids hear the word assessment and totally shut down. I always explain to them, *It’s not a test. It’s not a big deal, I want to know if you’re getting it. If you were here, you were doing the work, you need some credit for it, other than just turning in the project, because who knows if you worked well with a partner?*”

App Inventor Assessment

This assessment is to be done INDIVIDUALLY. You must complete every question and submit the form once you are finished.

Name: *

How many components are on this screen? *

Name the components on the screen: *



Why is it important to rename the components in your app? *



Explain in your own words what the blocks do: *



Which two components are used to play sound in App Inventor? *

- Image and Button
- Button & Layout
- Sound & Player
- Media & Player
- Other: _____

If you wanted to center your buttons on the page, what do you need? *

- Sound Button
- Horizontal or Vertical Arrangement
- Multiple Blocks
- A bigger screen

If you want to open another screen called "Directions" when Button 1 is clicked, what blocks do you use? *

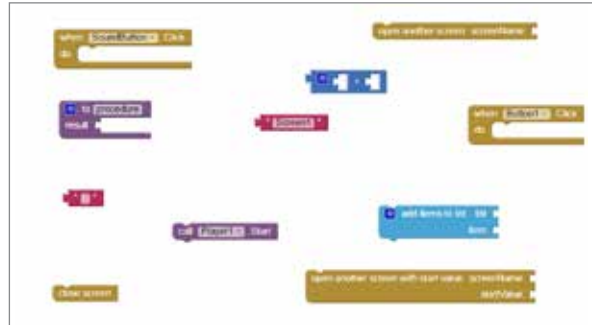

Name two file extensions for pictures that we used in class. *

- MP3 & JPG
- JPG & GIF
- JPG & PNG
- WAV & MP3
- Other: _____

Name two file extensions for sounds that we used in class. *

- MP3 & JPG
- JPG & GIF
- JPG & PNG
- WAV & MP3
- Other: _____

According to the screen below, why wouldn't the player play sound? *

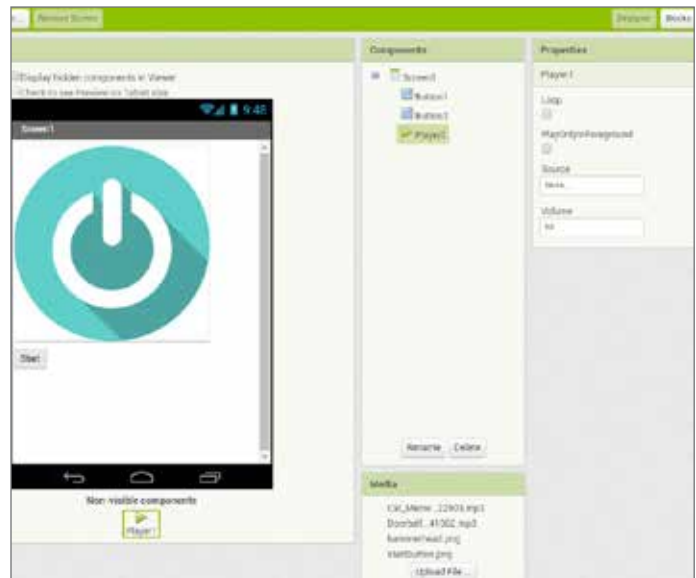

I want a button (SoundButton) to play CatPlayer when the button is clicked. What blocks do I need? *

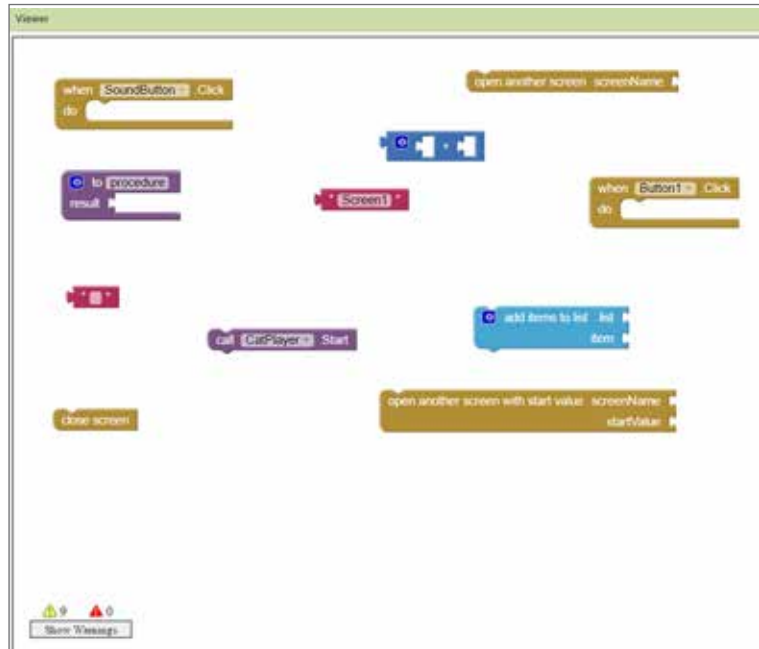

Why won't "PigScreen" open when the button is clicked? *



22 CHOOSE YOUR OWN CODING PROJECT

ADRIENNE

“Any time you’re creating something, you have constraints. Even artists, they have constraints for themselves that they’ve created, and that’s difficult to do. So I try not to push too much emphasis on, *This is what I’m grading you for*, but rather, *This is how you get enjoyment out of what we’re doing in class.*”

Choose Your Own Coding Project Self Evaluation

1. PASTE THE LINK TO YOUR CODING PROJECT DOCUMENT HERE!!!

2. Describe what you created in this project. _____

3. How does your final project compare to what you planned? What changes did you make to your plan? Why? _____

4. How well does your final project meet your planned design specifications? _____

5. How did you improve or change the project during the "Iterate" step of the Engineering Design Process? What else would you want to do, change, add, or improve? Explain. _____

6. How did you share your project with others? What went well and what didn't? What would you do differently?

7. Give two examples of peer feedback you received, positive or negative. What is your response to this feedback?

8. Evaluate your own use of the Engineering Design Process in this project: Define, Identify, Brainstorm, Prototype, Test, Iterate, and Share. Talk about what went well, and why, as well as what you struggled with, and why. Discuss what you might do differently in the future. .

9. Is there anything else I should know about your project as I consider your mastery score? Anything that is not covered in this document or your project document?

23 PROJECT RUBRIC

LINDSAY

“I’ll give students a rubric and I’ll tell them what I’m looking for and how you can get all the points for your grade, so that they know ahead of time. There’s this transparency with how their grade is being calculated. With any rubric, it doesn’t really tell the full story about every single student. So, it’s not individualized, but at the same time, if students are given parameters to meet where you want them to be, it gives a better understanding of what goals they’re hitting or standards that you want them to reach. In the eighth grade, I have a ton of students who need things that are concrete. So, I’ll talk through what they are thinking they want to include in their projects, and we’ll create a checklist together.”

Name: _____

Section: _____

Date: _____

	Exceeds Expectations (3 Points)	Meets Expectations (2 Points)	Approaches Expectations (1 Point)	No attempt
Requirements	Project exceeds the necessary expectations. Student has surpassed the following requirements: <ul style="list-style-type: none">● A stage● A sprite● 6 action commands (“dance steps”)	Student meets the following requirements: <ul style="list-style-type: none">● A stage● A sprite● 6 action commands (“dance steps”)	Project addresses only parts of the project prompt or does not accomplish the project goal.	
Creativity	Student selected a stage, sprite, and action commands that create an engaging dance performance for viewers.	Student selected a stage, sprite, and action commands that are relevant to one another and attempted to create an engaging dance performance.	Student did not select relevant elements for his or her project. Action commands may appear random.	
Use of Code	The project incorporates coding concepts introduced in the current lesson AND from previous lessons.	The project incorporates coding concepts introduced in the current lesson.	The project demonstrates gaps in knowledge or misunderstandings of concepts.	
Time Management	Student completes the project before the deadline. The student uses the remaining time to assist classmates with the project.	Student completes the project on time.	Student does not manage time well. Students does not complete the project by the timeline, and requires extra time or help in order to finish the work.	

Comments:

Lesson Grade: _____

24 DESIGN JOURNALS (EXCERPTS)

MULTIPLE TEACHERS

“Design journals definitely help me get inside students’ heads. I don’t think I could have a conversation with somebody where they would clearly lay out a picture of what they’re working on, a link to it so I could see it, and a personal reflection. But in their journals, students end up being more transparent than they realize when they write about something that gave them a hard time and how they fixed it. I say, *It’s really important to learn to document your work and your thinking, and so I grade your documentation, not your actual lab.*”

The Start of the Journey

My personal goal is to master at least the basics of animating by the end of the year.

I'm excited to learn how to make an animation, and make it look professional.

I expect to learn to master code in a way that makes my work look like a professional's work.

I have always felt like I have this need to express myself through creating something, and I really think that animating will help satisfy that urge.

Activity One

It's really enjoyable being alone in the world of Scratch, having some time alone with your own thoughts, really letting the ideas and creativity flow into your work.

I am enjoying learning how to create a funny and perhaps relatable story with only a few commands and sprites.

One thing that I am having trouble with, however, is figuring out how to get sounds and actions in sync, and thinking of a satisfactory ending to my story.

This problem was fixed using a broadcast block. When I broadcast a message, I am sending out a sort of signal. When I put a "When I receive" block, it receives that signal and then performs the next action on its script.

Activity One Challenge

In Activity One, I would like to make some people talk that are not sprites that are on the screen.

Like, a text box or something that points away from the character that is able to be seen in the story.

I would like my character to have a conversation with the people that she thinks are following her, to make it more comedic and funny.

Activity Two

In this activity, I learned how to make extended dialogue between two, and even three, characters.

Using the wait blocks, I found out how much concentration it takes to create the dialogue, using multiple say and wait blocks.

This helped my story by making one of my characters surprise two others, so that the story had an interesting twist

I also had fun experimenting with motion blocks to make one of my creatures appear to be shaking.



First Project On Turtlestich

I have been working on a pattern that includes two of the same design, but one is smaller and one is bigger.

I plan to tell everyone how I was just experimenting with the code, but with the intention of having a repeat block inside of another repeat block.

I hope that it will work, because it says that there are too many stitches and it “will get clamped.” I’ll figure it out, probably by using multiple blocks instead of one.

Plan For Special Storytelling Project

	Plan for the Day	What worked, what didn't, where to start tomorrow
Story plan	The player is in a riddle house, and must escape by figuring out riddles	that allow them to go through separate doors. Will have differing endings
Wed, Jan 10	Program the beginning (Ghosting)	I got the opening done, now I can work on the storyline. I need to figure out how to program the doorways.
Thurs, Jan 11	Program 1st and 2nd set of doors (Ask and Wait) (If then else)	I only got one set of doors. I think I want to just do 2 sets, maybe 3
Fri, Jan 12	Program 3rd and 4th set of doors (Ask and Wait) (If Then Else)	I finished the 2nd set of doors. I will do the 3rd one done, then maybe do some special effects and sounds.
Wed, Jan 17	Add in and fix extra characters along the way; Start Endings (Ghosting)	I did some backgrounds and 3rd doors. I will work on this at home, and finish the doors.
Thurs, Jan 18	Program endings (Mystery Box)	
Fri, Jan 19	Do any last minute work	

Date	What I hope to get done today	What I did	Note to self	Any other comment
Thursday, March 8	I hope to review the storyline	I helped edit this sheet and read our storyline sheet.		
Monday, March 12	I hope to figure out how we are going to code the storyline	We have began making the various backgrounds and the title page.	Don't forget about the table!	
Wednesday, March 14	I hope to start the coding and figure out how we're going to code it	I got some beginning coding done and also some backgrounds done.	Don't forget about the other sprites	The purpose of the game is to raise awareness about depression and how to help someone with it.
Thursday, March 15	I want to get at least halfway through the lunchroom scene.	I started a lot of the other people/	Don't forget about the hand!	
Friday, March 16	I want to finish the lunchroom scene today.	I only finished Bob	Speed UP!!!!	
Monday, March 19	I am finishing the 1st scene & choices. HAVE TO!!	I finished the facts		
Thursday, March 22	We have to speed up on coding today	I finished the ppl	Work at home	
Friday, March 23	It is sharing day, but we barely have things to share	They didn't like it. We'll work on it		
Monday, March 26	We want to combine our coding.	I moved to the next scene		
Wednesday, March 28	I want to check the animation	We shared, so we weren't able to work on anything		
Thursday, March 29	I'd like to complete the animation for the brick wall scene	I did the animating of the scene, and am moving on to the next one		
Monday, April 9	I want to advance SIGNIFICANTLY	I coded the bar and its moving as well as beginning the next scene		
Wednesday, April 11	I want to complete another scene	I got the transition done		
Thursday, April 12	I'm ready to do another scene	I got 2 scenes done, and I'm renaming the buttons for organization		
Friday, April 13	I want to combine scenes and get real work done today	I got a LOT done	WORK AT HOME!!	
Monday, April 16	We are looking at other's projects today.	We saw other's projects, and got good feedback		

Games For Change: Feedback One

- I agree with the feedback, however, this IS still just a preliminary stage
- They did not really like it because they couldn't understand it
- I had wondered if we would need to specify more, and my suspicions were confirmed when they said specificity was key
- I would like to work VERY HARD on the coding so that they can actually play something worthwhile instead of resorting to relying on the inspection of the coding
- I hope I can work on it over break, because I honestly don't think that we will be able to finish it in only 7 more class days

LE EPIC ANIMATION JOURNAL!!!!!!1!!!!

By

400%
SIZE

Day 1 - Peter hurts his knee

I was able to make the characters say their lines, make bump into each other, then say their lines and Thanos Kirby pops out of nowhere and say how epic this project is, then spin around and change colors as the fortnite default dance plays. I was really proud of the Kirby Thanos scene. I feel like my project is **complete** as it is and I'm done with it.

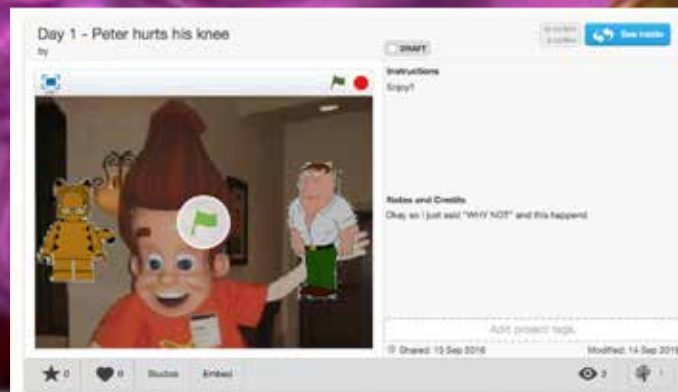

Color dodge

In this game, you have to dodge the other colors at aren't yellow. Using the color blocks, if the black dot isn't touching yellow, you lose health. Using the time blocks, when it reaches a certain amount of time, the block's speed up or it starts to shoot lasers. If I were given more time I wouldn't do much more with my project. I'm really satisfied with the final product.



Stop!

This is my microbit project. It is a game where you can choose your own path by either shaking or pressing A and B. There are 2 ending, and 3 versions for one ending. One is the bad ending in which you destroy the code. The other ending the good ending where you fix the code immediately, get tricked into fixing it, or fixing it at the last second. A challenge I faced was getting the game to continued in certain paths. But I was able to overcome it by using variable blocks. I am really satisfied with the final product and I might not want to continue it any more.

Code - <https://makecode.microbit.org/#/edit/647012a>



Answers to questions:

1. What is the point of your project?

Just to make a fun little game on the go if you are bored.

2. What was the greatest challenge that you faced and how did you deal with it?

I faced the challenge of trying to make the path ways when you do an input. But I was able to use variables to make my life easier.

3. What are you most proud of in this first building project?

Just how the game plays.

4. What would you do next if we had more time to work on this project OR what does this project make you want to build next?

Maybe make it much more neater and making the game longer.

Micro bit balance challenge BEAT!

In my project you have to tilt the micro bit in the direction the arrow points in. If you got it, you will get a check mark you would get a point. If you fail, an X would appear and you get no points. The game ends when the song is over and your points are displayed. A challenge when making the code was trying to fix a glitch when you have to point it up you don't get a point. But I figured out you had to hold the microbit, facing the ceiling when playing. Then it would be fixed. A challenge when building, was when I was trying to glue the case together without ruining the wires and microbit. But through shaking and sweating while glueing it, nothing was damaged. I would really like to make a game in unity, unreal engine or something. (Link is the title.)



EPIC FAMILY GUY! ROBUX! (loud)

In this project, you play as Peter Griffin, trying to get his robux back. You control Peter Griffin, by using the A and D keys to move left and right. As well as the spacebar to jump. I had added a win screen, a lava pit, and music. I like how the final product turned out. I think it could have a bit of work on the controls. But it's more of a problem with scratch. I would really love to find out how to make 3D games in scratch next.



Random crits are fair and balanced

In this project, you play as TF2 medic with the archimedes head. You try to avoid random crits and get that teleport bread. There's no purpose to this game. It's just a meme. A challenge I faced was dealing with all of scratch, it might seem random. But when they bounce, they always followed a pattern. So I made it more random with degree blocks. I **REALLY** want to learn how to make 3D scratch games.



25 BITSBOX CODING WORKSHEET

ROBIN

“My dream assessment would be for students to take what they learned, apply it to some sort of project that is meaningful to them, and then share it with the world, as in their family or community. That would be great. I might have a checklist that I give them about concepts or guidelines—things that I want them to show they’ve learned. I love it when I get to talk to them or they make a recording that explains the thinking behind their decisions—that’s another insight for me.”

Bitsbox Coding Worksheet

Name(s):	
----------	--

What programming language are you using to make apps?

Coffee Script

Every programming language provides a set of commands that the computer can understand. Think of commands as things you tell a dog, like “sit,” “stay,” or “roll over.” In programming, you’re doing the same thing to the computer.

What do the following commands do?

fill(“rainbow”)	
stamp(“banana”)	
text(“Peanut Butter Jelly Time”)	

What do you think of programming in Bitsbox so far? Insert the Emoji(s) that reflect how you got on today in the lesson. Please explain your reasons why.

Insert the emoji(s) here:

Explain why you chose these emojis:

26 THE CODING PROJECT

ADRIENNE

“A lot of them were very proud of the work they were doing. I gauge how successful a project is by how many times they call me over to make me look at it. Not to tell me, *I don't understand*, but, *Look at my thing. You want to play my game? Do you want to see my website? Check this out. Look at this thing I did.* That's getting those creative juices flowing. I don't make creativity obvious to them, because if I tell them, they'll be snarky and completely contrary, so I'm like, *I'm teaching you how to be creative kids in a very subversive way. Last day of school, there's the prize. You are creative. This is all the stuff you made.*”

TE Coding Project:

Steps 1-3 of the Engineering Design Process

Turn in one document for the group, but all group members need to submit. There are wide variety of coding languages with completely different applications out there and you all have a wide variety of experience with coding, from none to borderline professional. Rather than me picking something and having everyone do it, we're going to divide and conquer: You choose a coding language, learn how to use it, create a project of your choice using that language, and then present your project to the class in whichever format works best for you (presentation, website, video, app, tutorial, etc.) This planning document is due by **Monday, April 22nd at 3pm**. The final project is due **Friday, May 3rd at 3pm**. You will present your projects on Monday/Tuesday May 6 and 7th to the class in a "tech" conference format for peer review. (For 7th grade, you will be presenting your projects on Thurs/Fri, May 9/10 when you return from the field trip.)

1. What would you like to learn and then create with this project? How is what you are creating going to help you in your future career aspirations? **YOUR BIG QUESTION!** (Define)

For this project, I hope to learn to code and design a website. On this website I want to create would be a fun quiz that will take your answers to generate a music playlist for you. It would be a way to discover new music or to find music for a certain mood that you're feeling. Perhaps in the future, for my career, I can use to my skills of website coding/building to design something to promote myself for a business.

2. Why is this important to you? Why is this important to anyone besides you? (Define)

I often find myself listening to the same songs over and over. While they might be great songs, I find it fun to explore new music and genres. I know that many people experience this too, my friends are always asking me for new music recommendations. With this website, I could take suggestions from other people and my personal taste to make playlists for different genres and decades.

3. What do you already know? (Identify)

I don't know much about coding. For the coding I'm doing, which is html, I don't know anything at all. I don't know to how write code, shortcuts for writing the html or how html works.

4. What do you need to know? Ask yourself at least 3 questions or list 3 things you need to know about and where do you intend to get this information (FYI: I am not a source.) (Identify)

a. Question 1:

How do I use HTML? - <https://www.khanacademy.org/computing/computer-programming/html-css/intro-to-html/a/quick-tip-html-tags>

b. Question 2:

How do I make things clickable? -

c. Question 3:

How do I build a quiz with HTML? <https://codeactually.com/examples.html>

5. Who is the audience for this project? Why would they want something like this? (Identify)

The audience for my project are my classmates. I think that they'd want something like this because quizzes are generally fun, and although there are millions of pointless ones out there, this one generates a music playlist for you.

6. What type of project will you be presenting to show what you have learned? (Brainstorm)

To show what I've learned, I will show my completed website. Websites with html are quite complex, you have to code individual things for stuff that seem as unimportant as font size.

7. How will you present your project to others? (Presentation, website, app, tutorial, video, etc.) (Brainstorm)

I will be presenting the website. I will have someone take the quiz themselves and walk them through it. I will also explain the elements that I had to work on regarding HTML.

8. What resources or materials do you need? (Brainstorm)

I will need the information and HTML codes to use. I have found all of these on various websites. This information is crucial to coding an actual website.

9. Include sketches of what you want your project to look like and include. Include text notes if needed. (Brainstorm)

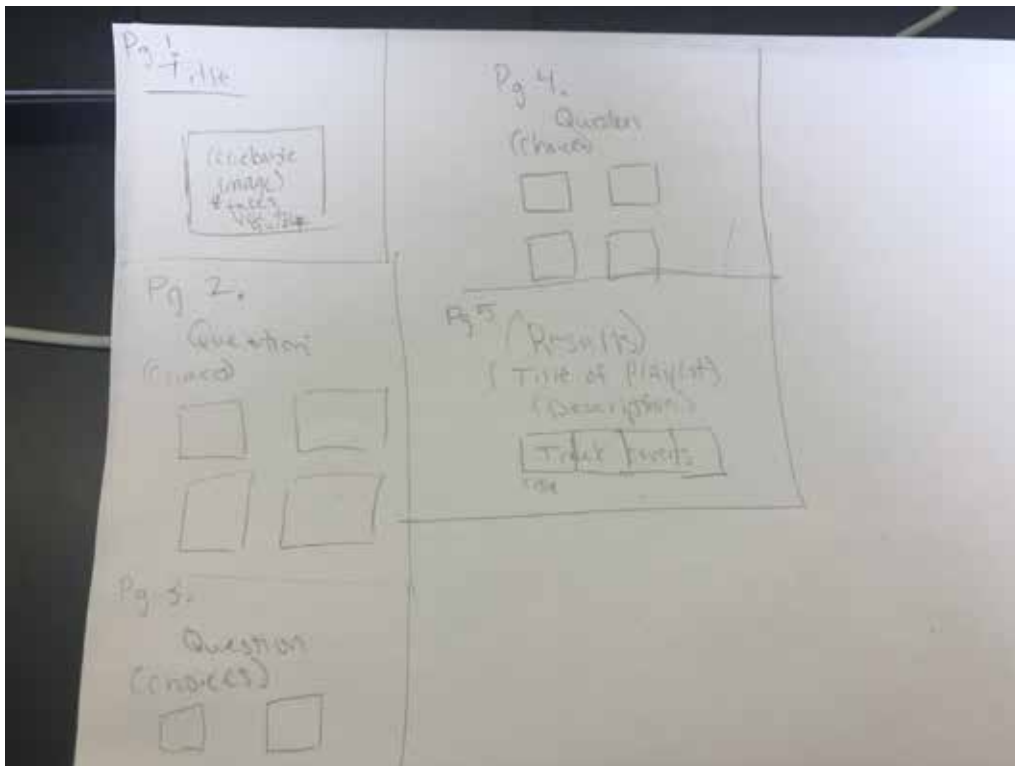

10. What can I do to assist you in completing your project? Is there something you need to learn how to do, assistance finding research, items you will need to create your project, accounts on any particular websites?

You could assist me in better understanding different tutorials I've found on the internet. I already have created an account for glitch and followed along pretty well with tutorials and things like that, so I don't see myself needing lots of guided help though.

11. For each day, write down what component of your project you will be working on. If you have more work than class time, add those to each day with either HW for homework or AD for advisory next to it. Note that C Days are 35 minutes instead of the usual 45min, D schedules are hour long.

Your project must include:

- An example of how you have applied your code (website, robot, app, game, etc.)
- The coding project template (Google Slides) completed with all of the steps of the design process explained completely and documentation of your work.
- A method of sharing how you applied the code you learned to be presented in class. (App, website, tutorial, presentation with slides, etc.)

EVERYTHING MUST BE FINISHED AND TURNED IN ON 05/05!!!

- a. D 04/16: Check in with you*
- b. D 04/17: Researching/Learning HTML*
- c. C 04/18: Researching/Learning HTML*
- d. No school 04/19:*
- e. A 04/22: Check in with you*
- f. A 04/23:*
- g. A 04/24:*
- h. 04/25 Testing No Internet*
- i. 04/26 A Testing No Internet (7th grade, we will do a fun activity this day)*
- j. A 04/29: Check in with you*
- k. A 04/30 (I'm out):*
- l. A 05/01:*
- m. A 05/02:*
- n. C 05/03: Check in with me*

27 SHARING SCRATCH PROJECTS

BRENDA

“Students might say, *I’m done*. Then I might say, *What if you added a second thing?* So, you can do little things to spur them on. I’m thinking of the word assessment as what allows me to see what they know or know how to do.”

Sharing Scratch Projects:

- Show the script
- Highlight something challenging or something you are proud of in the sprites, costumes, scripts.
Feel free to ask for ideas/troubleshooting tips, too.
- Play project
- Take questions and positives.

28 ANIMATED STORY

BROOKE

“With this rubric, teacher expectations and student expectations are at least similar. Like, we know what we’re looking for, but it is very open. There is some room for argument in that because it is so open to their own interpretation, their own creativity. I didn’t want the project to be super limited.”

Animated Story Rubric

	Emerging	Developing	Proficient	Advanced
Story	Story has foundation, but is lacking depth.	Story has at least two out of three: beginning, middle, or end. Appears incomplete, lacking essential details.	Story has beginning, middle, and end. May lack clarity.	Story has clear beginning, middle, and end. Includes conflict and resolution.
Characters	Animation includes at least one character, but is lacking depth or response to conflict/resolution.	Animation includes two characters, may appear flat or one-dimensional, may not address conflict/resolution.	Animation includes at least two fully developed characters that interact w/ each other and environment; address conflict/resolution.	Animation includes more than two fully developed, multidimensional characters, that interact with each other and environment.
Dialogue	Dialogue is minimal, blunt, or does not tie into story/make sense for the character.	Includes conversation. May not tie into story, lacks connection or depth.	Appropriate conversations for the characters, converse with each other and includes self-reflection (thought bubbles).	Appropriate to the characters, includes foreshadowing, alliteration, and/or body language to tell the story.
Coding and presentation	Animation used few of the blocking elements correctly	Animation used some of the blocking elements correctly.	Animation used most of the animation blocking elements correctly. One or more student-made elements are present	Animation used all animation blocking elements correctly, utilized student-made characters, sounds, and/or backgrounds
Timing	Animation timing is frequently too fast or slow, difficult to read dialogue/ understand story	Animation timing is awkward at some points, makes story hard to understand	Animation is timed well, but some parts were too quick or slow for understanding	Animation is timed well, so viewer can read and process what is happening in the story

29 SCRATCH SHARE AND SELF-REFLECT

JASMINE

“At the beginning of my career, everything was beautiful with little 2D cliparts, and now I’m all about just writing it by hand and handing it to my students. It’s literally handwritten and copied. But I think there’s a certain level of authenticity to the kids, that this is not meant to be a published piece. This is meant to be something that you’re reflecting with. It’s not something that we’re going to put out to the world. This is our own writing to express what we’re trying to say at this moment.”

SCRATCH SHARE AND SELF-REFLECT

NAME: _____

Project Title: _____

EXPERIENCES IN CLASSROOM / IN THE WORLD
that helped you design
YOUR PROJECT:

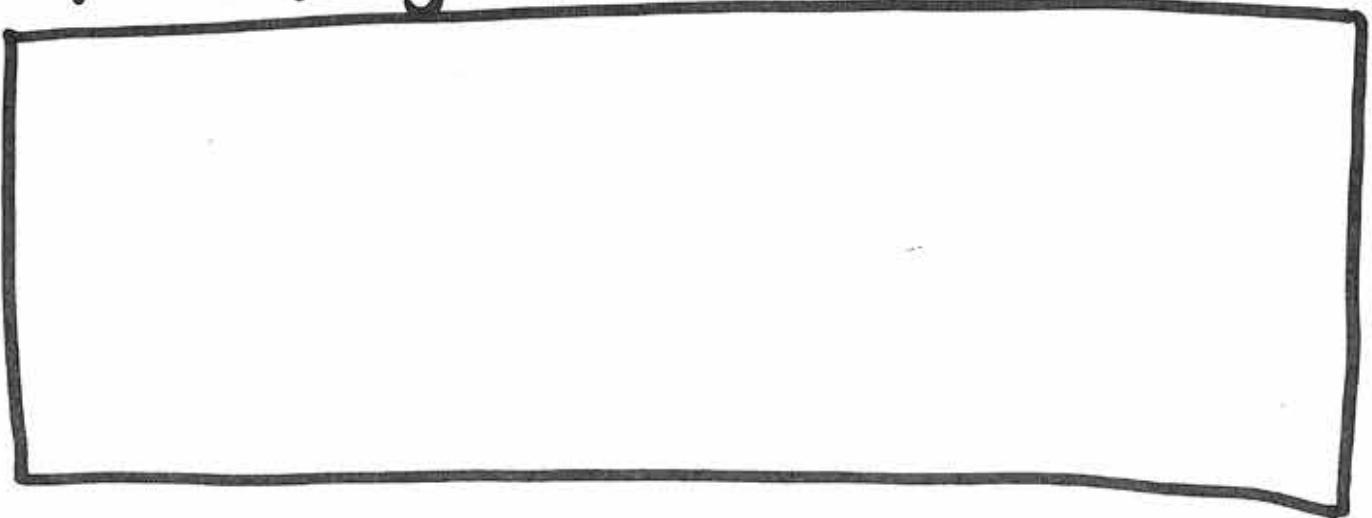

What elements of your project
do you think most closely mirror/
predict the actual motion of an
object?

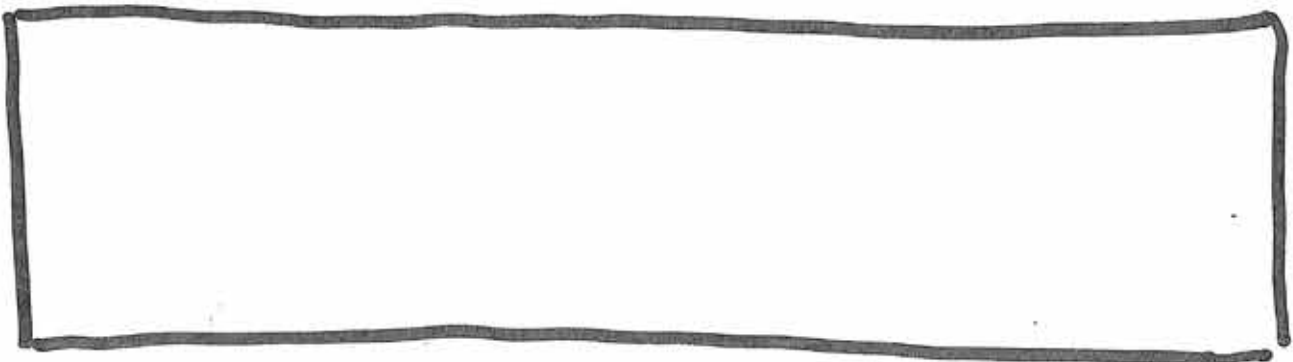

What elements of your coding project were most difficult to appear realistic to the viewer? What were your struggles?

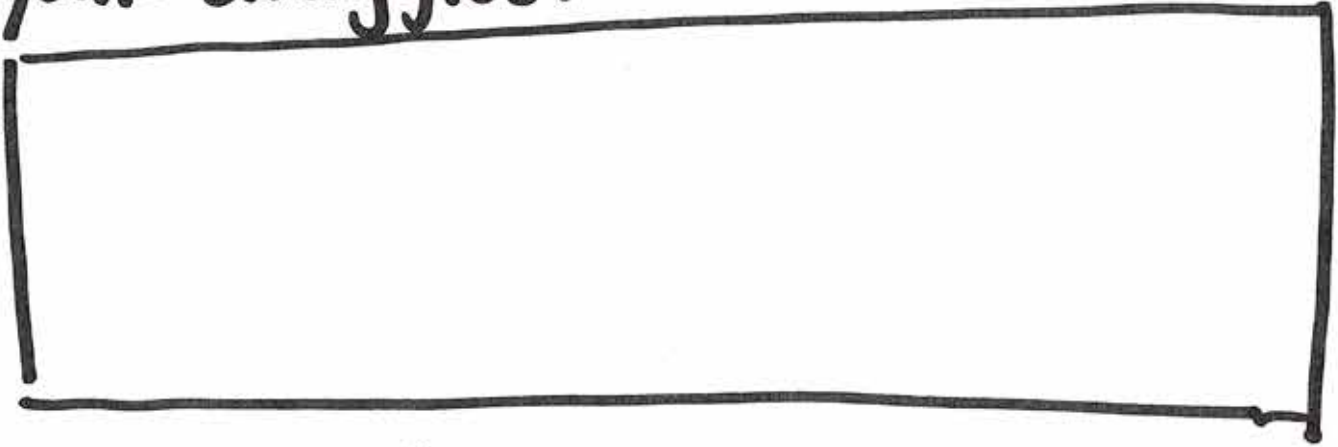

What coding blocks were most useful for you? How so?



Choose one coding block you used and explain its function.

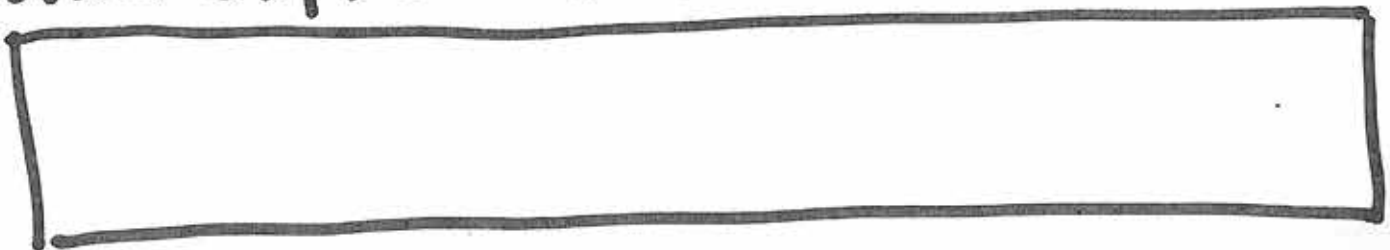

Are there any elements of your project (coding blocks, design, etc.) that you think were unique to your project? How did this make your project unique or different than your classmates?

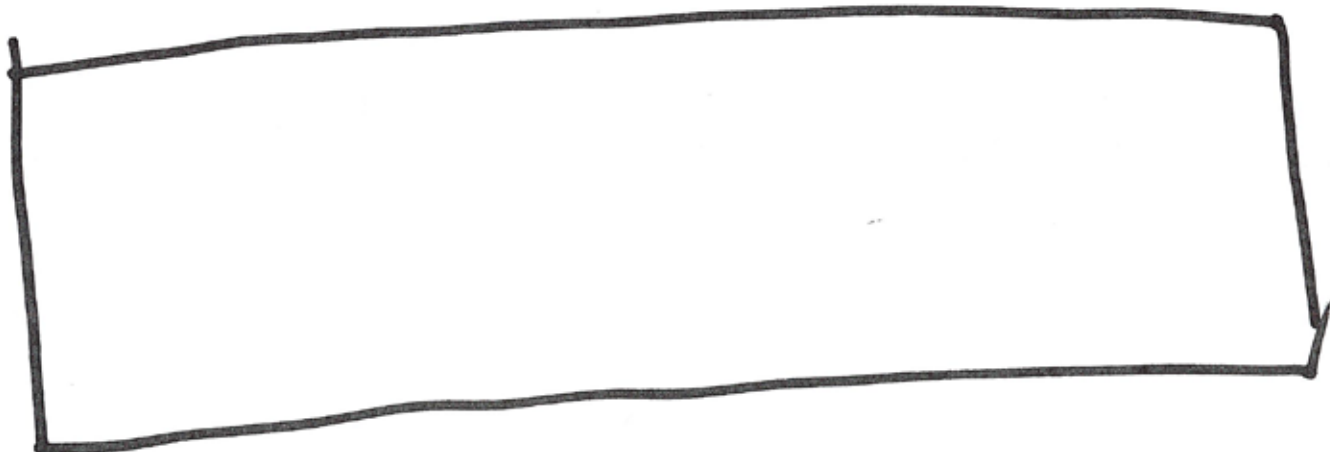

Do you think SCRATCH is a good way to show what you know about forces and motion? Why? OR Why not?

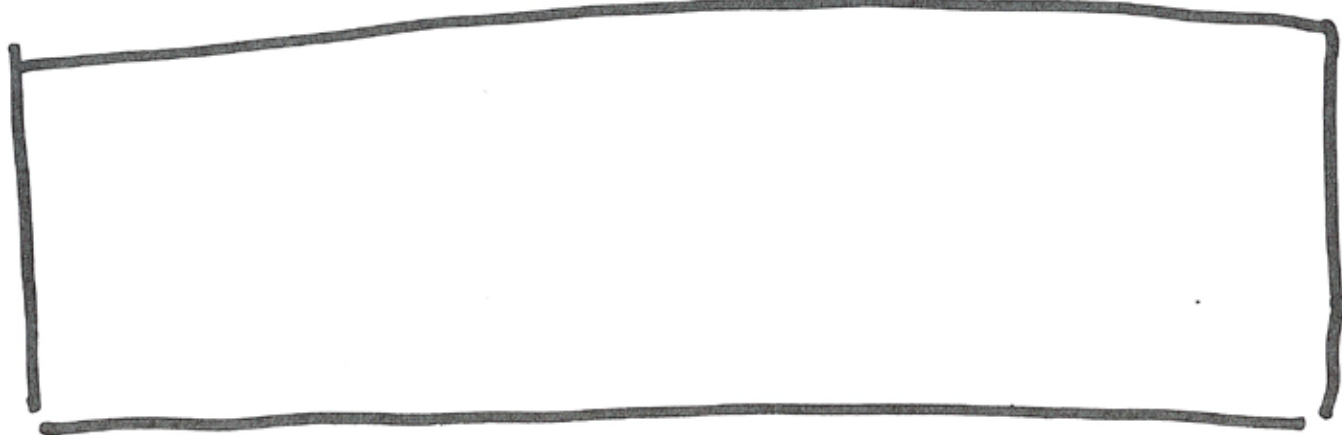

Do you think SCRATCH allows you to be CREATIVE? Why?

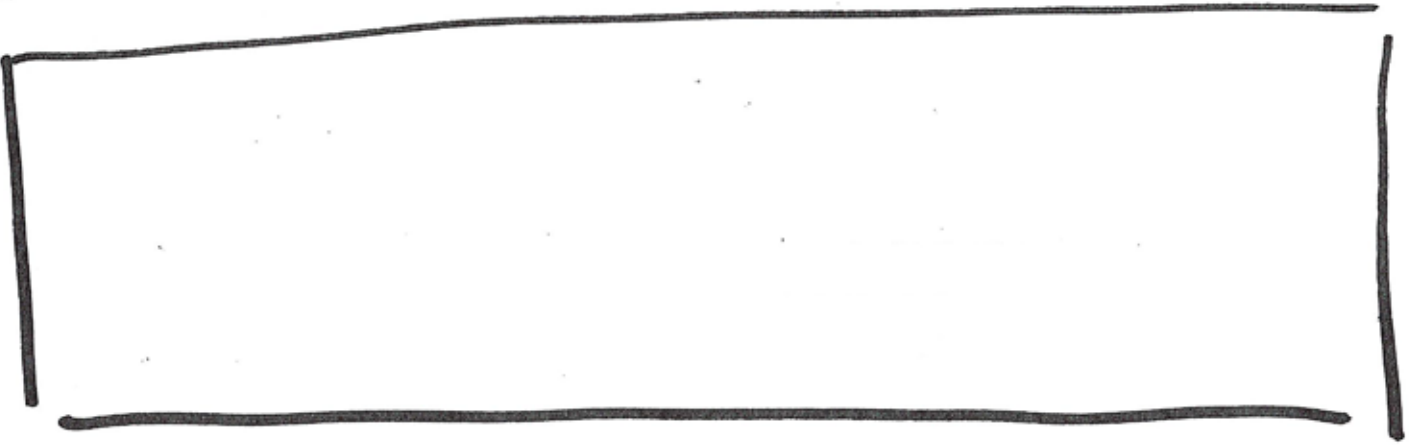

Do you enjoy using SCRATCH in science? Why?

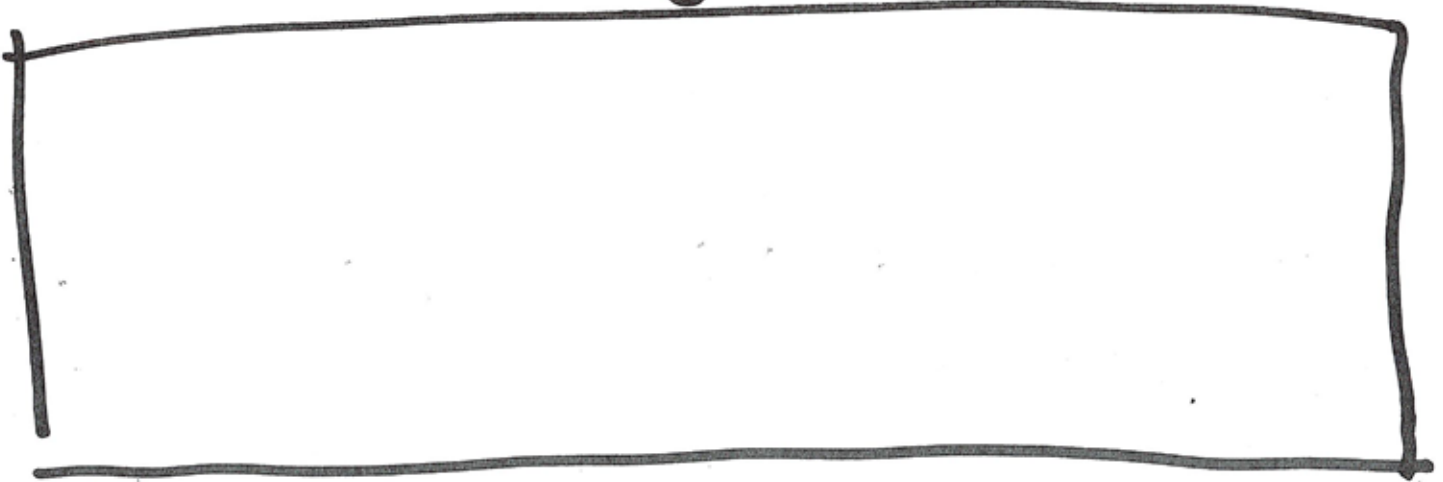

DRAW an illustration of yourself USING SCRATCH on this project and attach it to this packet!

SCRATCH SHARE AND SELF-REFLECT

NAME: Ariel D

Project Title: Ariel-Food Truck

EXPERIENCES IN CLASSROOM / IN THE WORLD
that helped you design
YOUR PROJECT:

I choose a food truck because, one: I really like food and two; a food truck has more of a fun personality to me than other stuff/cars.

Animals are the ones who listen to me and pay attention, even in the toughest of times. When every I had a bad day my pets were always there.

What elements of your project do you think most closely mirror/predict the actual motion of an object?

When my car stops near the end of the road, it's like a car and a stoplight. For a while the light is green, then red, then green again.

What elements of your coding project were most difficult to appear realistic to the viewer? What were your struggles?

When my car went down the hill it was hard to figure out what angle I needed and how to fix it. I couldn't fix it, so it looked non-realistic. The background I made was difficult, too.

What coding blocks were most useful for you? How so?

The repeat - block was most useful because then I didn't have to write all the code 2 times.

Choose one coding block you used and explain its function.

point in direction ○
to make a change in which direction it is pointing at

Are there any elements of your project (coding blocks, design, etc.) that you think were unique to your project? How did this make your project unique or different than your classmates?

I think me using a repeat block was unique because I wanted my car to seem like it was still moving even after the first time. Also I think my dino eating a bagette was pretty funny & unique.

Do you think SCRATCH is a good way to show what you know about forces and motion? Why? OR Why not

I think it is because people can have fun learning about forces and motion and coding. But then at the same time I think it's more for coding because most people want to add the fun stuff and not motion and coding

Do you think SCRATCH allows you to be CREATIVE? Why?

Yes, because there is a large variety of whatever you can do. They allow you to make your own background and spread ideas.

Do you enjoy using SCRATCH in science? Why?

YES! Yes, because it's fun expressing how many ideas I have for a project and how much blocks and sounds you can add.

DRAW an illustration of yourself using SCRATCH on this project and attach it to this packet!

30 GOAL STATEMENTS

ASHLEY

“I think goal-setting puts students in the driver’s seat, and it kind of catches them off guard a little bit. Not everybody, but I think a lot of them act like school is something happening to them, and they’re just required to be there. And they show up to a class and the teacher tells them the most important thing to learn and then how to study, and they do these tests and things like that. So, at the beginning of the year, these goals make them be accountable a little bit and have a purpose. So, *Why are you here? What are your goals for the year?*”

Goal Statements

Name: *

Your Personal Goals

What are your personal goals to achieve in web design class this year? *

What steps will you take to achieve these goals? *

Examples: try hard, ask questions, pay attention, etc.

What is the end result of successfully completing your goals? *

Example: I will be able to build a website

What other goals do you have for yourself this year? *

Examples: get job, get into college, earn good grades, try a certain sport/club, etc.

What steps will you take to achieve these goals? *

Examples: practice certain skill, stay after school, etc.

What is the end result of successfully completing your goals? *

Examples: walking across the stage and receiving a high school diploma

Class Goals

What do you think some goals should be for the entire web design class? *

What steps should we take to achieve these goals? *

What is the end result of successfully completing our goals? *

Help and Assistance

What can I do to help you reach your goals this year? *

Examples: be patient, push/encourage you, be clear, listen to you, etc.

SUBMIT

31

PYTHON BASICS WORKSHEET CRYSTAL

“For this worksheet on Python basics, they read code and write code. They can take the block of code, put it in Trinket, and figure out what the problem is or say whether it can run. But, sometimes I want them to tell me without putting it in the computer. So they have three ways: read, interpret, and then write their own code, which can demonstrate that they understand the syntax of the language.”

PYTHON ---Basics

Why does this code not work?

Fill in the blanks below describing the error(s) found.

```
num1 = input("Enter a number: ")
num2 = input("Enter another number: ")
total = num1 + num2
print("The answer is ", total)
```

Create your own code:

In Trinket.io create a new project called "Python Basics." These can be 'commented out' and used in one trinket or create *PBI, PBII, PBIII*. Cut and paste link on word doc under google classroom assignment.

1. Ask the user's first name and then ask for their last name and display the output message:

Hello [First Name] [Last Name]

2. Ask the user to enter two numbers. Add them together and display the answer as:

The total is [answer].

3. Ask the user to input their name and their age. Display the answer:

"Hi [name] you are [age] years old."

32 UGLIEST WEBSITE COMPETITION

JACK

“In peer evaluations, students are a lot more honest with each other than they are with me. So, there’s definitely information I wouldn’t get from just looking at all the projects myself. You really get a sense of whether they’re excited about their project. Honestly, that’s the thing that’s most important for me in that class. Are they getting excited about it? Are they expressing themselves? Are they taking ownership of it?”

Ugliest Website Competition

* Required

Whose website are you evaluating?

It includes an index.html file and a separate CSS file *

- Yes
- No

<html> <head> <title> <body> are all used correctly *

- Yes
- No

At least two more tags (like <h1> and <p>) are used *

- Yes
- No

At least three different fonts and colors in the CSS file are used *

- Yes
- No

At least two pictures are used *

- Yes
- No

At least two different positions, using borders, margins, positions, etc. *

- Yes
- No

At least one list AND/OR one table *

- Yes
- No

How ugly was the website? *

Actually pretty nice	1	2	3	4	5	6	7	8	9	10	Ugliest I've ever seen
	<input type="radio"/>	<input type="radio"/>	<input type="radio"/>	<input type="radio"/>	<input type="radio"/>	<input type="radio"/>	<input type="radio"/>	<input type="radio"/>	<input type="radio"/>	<input type="radio"/>	

What was the best/worst/ugliest part? *

33 PEER REVIEW TEAM MINUTES (FICTIONAL EXAMPLE)

DUSTIN

“Our seniors work in teams of three to four and create virtual reality projects. They all came up with different ones. It was definitely very creative, but the assessment of it was obviously tricky. The peer evaluation makes a difference in their grades, but it’s not the end of the world. It could make a difference between an A or a B. I think it’s a good thing, the peer evaluation, because in a good project it makes them accountable to each other.”

Example Peer Review Team Minutes

[this is a fictional example]

Team Meeting – Ken Ye Dig It

Date/Time: 03/06/2016 10:00

Location: RE217

Attendees: Gary, Umar and Lisa

Chair: Lisa

Agenda

1. Peer review of team members

Minutes

We discussed the marks to be assigned to each member of the team for peer evaluation. We came up with the following marks and justifications.

Umar – 18 out of 20

Umar led the team well and contributed to all areas of the development. In particular, he contributed to the art work in our game, producing some excellent character graphics and animations, all of which was delivered on time. He was extremely easy to work with and set clear priorities for the team and kept us on track. He had excellent communications skills in person, however his one fault was that on a couple occasions he missed a week of college and we were unable to get in touch with him. In general, the communication strategy we implemented was effective and Umar made use of it via our private Facebook group and skype when we weren't together in class. When unforeseen events occurred, Umar kept calm and helped us problem solve and find a solution. Overall Umar was a valuable teammate who led the team well.

Lisa – 20 out of 20

Lisa was an excellent teammate who was always present at every class and at every team meeting. She completed the team documentation on time and created fantastic sound effects for our game. She has excellent written communication skills and helped our team achieve very high marks for our team documentation. She also sourced suitable royalty free music for the soundtrack to our game. She was easy to work with and communicated well both in and out of class. When Gary didn't complete the coding for the game, she stepped in and took over and made sure it was completed on time. She contributed to all stages of development, completed all her tasks on time and was an effective contributor when it came to problem solving.

Gary – 12 out of 20

Gary started the project well and was enthusiastic about the project. However, his attendance and time keeping in class let him down. He did not communicate well with the team and went missing for weeks at a time. He was lead programmer and did contribute significantly to the code; however, he did not complete his assigned tasks on time. He was guilty of exaggerating his coding skills at the beginning of the project and when he was struggling with it he did not let the rest of the team know until quite late on in the project. This meant Lisa had to step in and take over the coding. Overall, we feel Gary did contribute to the project, but he only did the bare minimum at each stage and was a frustrating team mate to work with at times.

34 STUDENT PRESENTATIONS (EXCERPTS)

MULTIPLE TEACHERS

“I have kids do a lot of presentations. I use Google Classroom, and there’s a feature where you can have a Google Slides presentation, and all of the kids can be editors on one slide set. That’s shaved off a good 45 minutes of presentations, because it is really efficient. I started having these really informal presentations, where, in the beginning of a project and midway, maybe two or three times, the kids do a quick presentation. Like, *This is what our app’s going to be on. This is why we’re doing it*, and every kid’s only talking for one minute.”

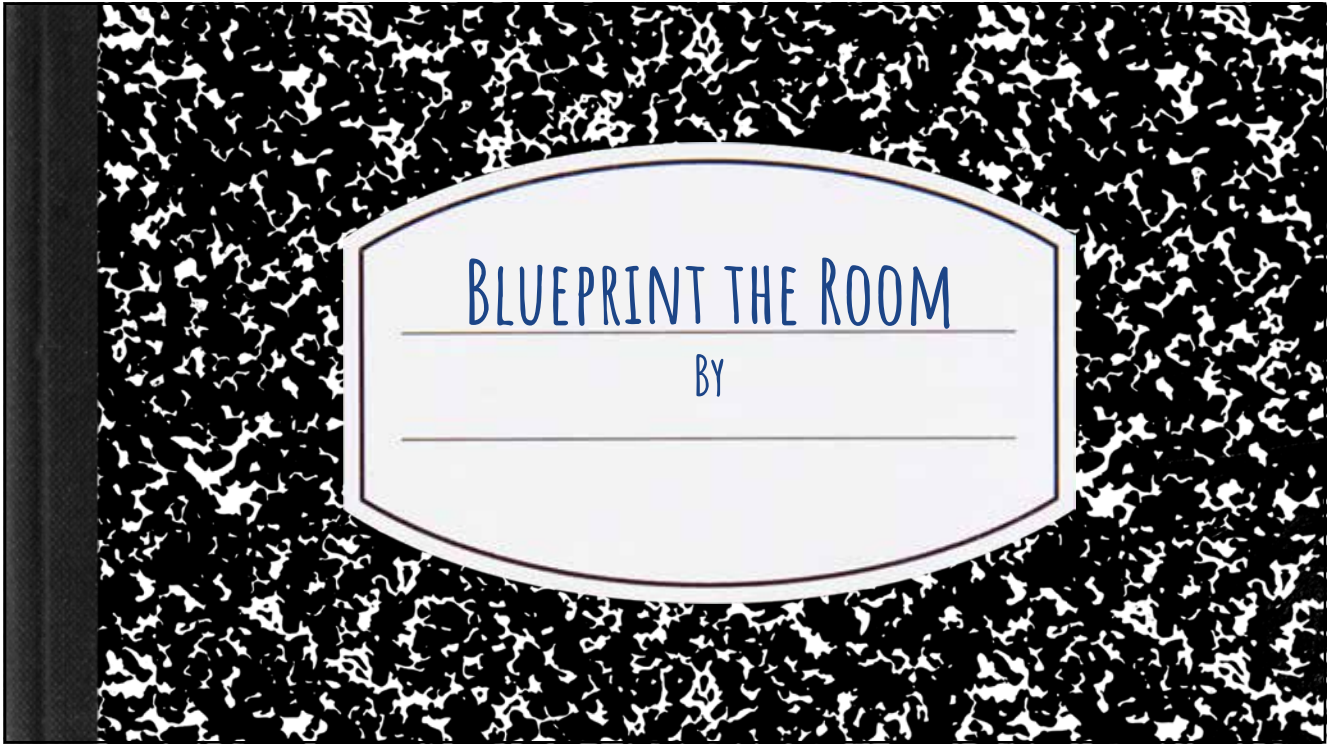

2

THE PURPOSE

Blueprint the Room is a helping app that allows the user to maneuver furniture blocks within a room without using any effort at all. The app is supposed to make decorating a room with furniture easier. It is unlike any other app.

MY SCREEN

My Screen consists of:

- A Button (Background Color)
- A Canvas
- 9 Image Sprites
- A List Picker (Add Furniture)

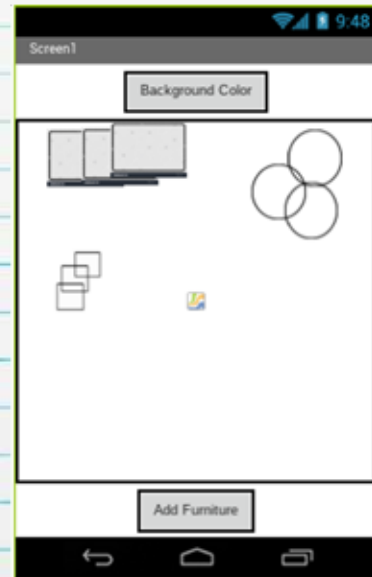

MY CODE

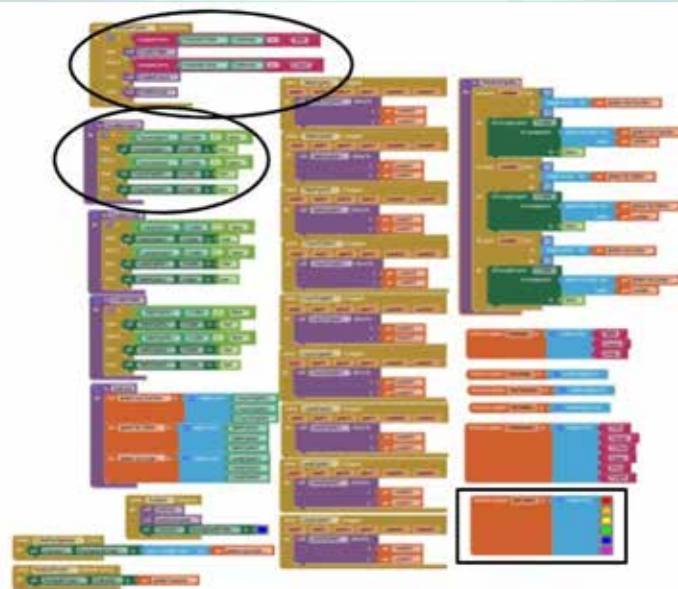

CODE EXPLANATION

These blocks set up the Color Background Button.



CODE EXPLANATION



Each of these blocks, allows for when an Image Sprite is dragged it will move with the user's finger.

MY ALGORITHM EXPLANATION

This is an algorithm. It uses boolean conditions to determine which of the two parts of an algorithm is used. In my code I used to determine which images sprites should be to be visible and invisible.

```

to EnableTable
do
  if TableSprite1.Visible == false
  then set TableSprite1.Visible to true
  else if TableSprite2.Visible == false
  then set TableSprite2.Visible to true
  else set TableSprite3.Visible to true
  
```

MY ALGORITHM EXPLANATION

This algorithm uses boolean conditions to determine which of three parts of an algorithm are used.

```

when FurniturePicker: AfterPicking
do
  if compare texts FurniturePicker.Selection == Table
  then call EnableTable
  else if compare texts FurniturePicker.Selection == Couch
  then call EnableCouch
  else call EnableLamp
  
```

In part 1, I use the block, compare text, to find the word "Table" in the Furniture Picker Selection. If the word is found then the procedure to enable table is used.

In part 2, I use the block, compare text, to find the word "Couch" in the Furniture Picker Selection. If the word is found then the procedure to enable Couch is used.

In part 3, if neither of these is chosen then the procedure to enable lamp is used.

MY ABSTRACTION EXPLANATION

This is a list Abstraction. This abstraction allows me to list all the colors I want in one button. It simplifies the code for me. Now the user can change the background of the canvas to one of 6 colors.



REFLECTION / CONCLUSION

The first thing I did was program my Background Color Button. I knew how to do this already because of other apps I have done.

After that I worked on connecting my image sprites to my list picker. That did not work. I then, tried to approach a different problem that I had.

When my app opened, you are able to see the image sprites. I wanted to make it so that they would be invisible when you opened the app. After countless tries and more learning, I was able to create my app the way I wanted it.

Overall: The two problems I had during making this app was turning sprites invisible at certain times and connecting my image sprites to my list picker.



Basketball Lights

Student A + Student B



Nerf basketball hoop project



Materials we Used

Our project is composed of an Ir sensor, Fun Keyboard, a speaker, basketball hoop and scratch code.



3

Our journey through this project



4



Along with the process...

- Cooperation
- Communication
- Patience
- Failure
- Determination
- Persistence
- Growth Mindset



Know- Want to Learn

We know that computer science is easy if you know what you are doing.

We want to know how to do challenging projects in class.

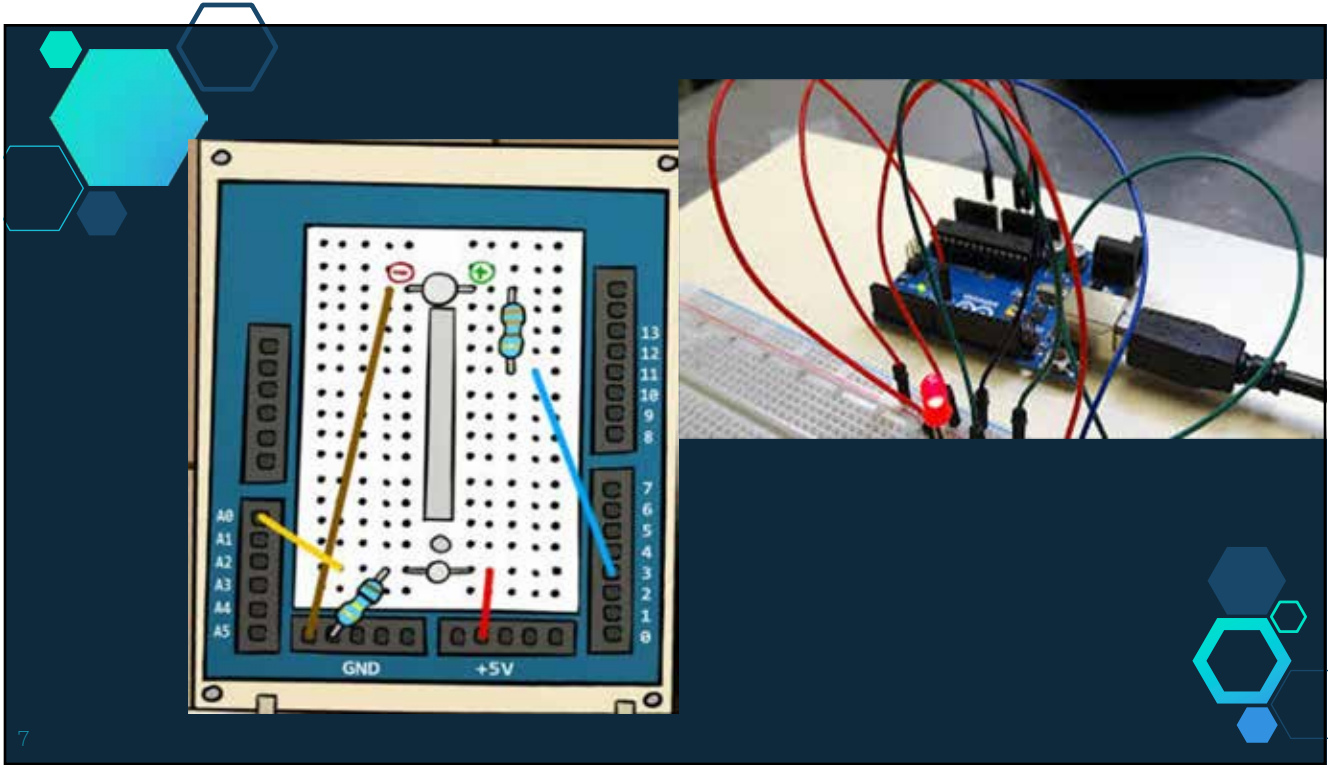

7

```

const int led=3;
const int sensor=A0;

void setup()
{
  pinMode(sensor, INPUT);
  pinMode(led, OUTPUT);
  Serial.begin(9600);
}

void loop()
{
  int sensor_value = analogRead(sensor);
  Serial.print("sensor_value=");
  Serial.println(sensor_value);
  if (sensor_value < 200) {
    digitalWrite(led, HIGH);
  } else {
    digitalWrite(led, LOW);
  }
  delay(250);
}

```

Configures pin 3 as OUTPUT.

sets LEDs ON.

sets LEDs OFF.

Prints the sensor value.

8



Learned

We learned to be specific and patient with our coding and building process.



Our Infographic



Scratch basketball code

<https://scratch.mit.edu/projects/>



35

KINETIC SCULPTURES RUBRIC

RENEE

“I think the rubric is good for seeing students’ understanding of the engineering process. The rubric asks them to annotate the code, to explain how it works. So it highlights when the students don’t understand the code. They can copy it, because I start in a model where they can copy code, develop code, and then they change it. So the rubric does highlight where students don’t really understand the code that they’re given, if they just reuse that and don’t know what it does. When developing the rubric, ensuring that there’s a fairness in terms of being able to compare different levels of creativity, or different outcomes from students, is important to consider.”

Kinetic Sculptures Creative Expression Portfolio Project

In this project you will investigate kinetic art, in particular the artwork of Arthur Ganson and Jean Tinguely. From this investigation you will design and create your own kinetic sculpture, based on a theme of your own choice. You will design and build the kinetic sculpture using Arduino hardware. You will develop the hardware design and code to control the sculpture following an iterative design process.

The purpose of the project is to provide students with:

- hands-on experience with embedded computing and digital technology.
- the ability to formulate structured algorithms and program them.
- understanding of the use of sensors and interactive algorithms.
- understanding of how computing is used in a variety of fields and applications.
- experience of examining the principles of aesthetic and conceptual elements in visual art.
- be able to find strategies for a successful and engaging art expression.
- investigate examples of art and technology collaboration especially in public domain.

The documentation for this project will include

- Artist statement
- Design
- Project development showing at least three versions of the project, with an explanation of how you used an iterative design process to improve and develop your idea
- Code, annotated to explain how it functions (to a non-technical audience)
- Evaluation

You will be graded on both the kinetic sculpture itself and the project documentation.

	Advanced	Proficient	Developing	Beginning
Artist's Statement	<p>Artist's Statement clearly:</p> <ul style="list-style-type: none"> <input type="checkbox"/> Identifies the aesthetic, personal, political, or cultural inspiration for the work <input type="checkbox"/> Explains the aesthetic, personal, political, or cultural inspiration for the work <input type="checkbox"/> Identifies and explains an artist or work that that inspired you 	<p>Artist's statement identifies the inspiration for the work; and an explanation is given but lacks detail or explanation is superficial</p>	<p>Artist's statement identifies the inspiration for the work but this is not explained</p>	<p>There is some attempt to write an Artist's Statement</p>
Design	<p>Upfront design evidence clearly shows what the product will look like and how it will function</p>	<p>Upfront design evidence clearly shows either what the product will look like or how it will function</p>	<p>There is design evidence, but this was clearly created after development or Designs do not show what the product will look like or do</p>	<p>There is some evidence of design</p>
Project Development	<p>Documentation identifies three distinct versions of the sculpture and explains how the product was developed using an iterative design process</p>	<p>Documentation describes final product and at least one intermediate stage of development and explains changes made</p>	<p>Documentation shows final product but it is not clear how design was developed into the final product</p>	<p>There is some attempt to document the development process</p>

Hardware and code	Code is developed independently Code is commented to explain how it achieves its intended goal to a non-technical audience Hardware and code are included to make the sculpture interactive	Code is developed to control movement matching that planned in design, but support may have been needed to achieve this Code is commented, but may not be understandable by a non-technical audience	Code is written to control movement but outcome does not match design There are limited comments explaining how the code works	There is some attempt to write code to control the sculpture
Evaluation	Strengths, weaknesses and areas for improvement are identified in both final product and development process	Strengths, weaknesses and areas for improvement are identified in either final product and development process	Strengths or weaknesses are identified in either the final product and development process	There is some attempt to evaluate product or process
Kinetic Sculpture	When looking or interacting with the sculpture both <input type="checkbox"/> The theme identified in the Artist's Statement is clear <input type="checkbox"/> The inspiration for the artwork can be discerned	When looking or interacting with the sculpture either <input type="checkbox"/> The theme identified in the Artist's Statement is clear <input type="checkbox"/> The inspiration for the artwork can be discerned	A kinetic sculpture is created, but it is not clear how the theme or inspiration are reflected in the final product	There is some attempt to create a kinetic sculpture

36 PEER FEEDBACK

ERIN

“After the school year ended, I went back to this particular project and I said, *What were the biggest problems?* The biggest problem was timeliness in getting them feedback, and it was the fact that I was the bottleneck. I can’t be a bottleneck for anything; kids have to know where they are as soon as they can. I have them peer assess the videos and walk around while they do it. Because they need very quick feedback.”

How To: Give App Feedback

My Name:

Feedback For:

Project Title:

PARTS OF THE PROJECT THAT MIGHT BE HELPFUL TO THINK ABOUT:

- Clarity: Did you understand what the project is supposed to do?
- Features: What features does the project have? Does the project work as expected?
- Appeal: How engaging is the project? Is it interactive, original, sophisticated, funny, or interesting? How did you feel as you interacted with it?

RED, YELLOW, GREEN:

Add a detailed comment for each row after thoroughly thinking about the app and using it. The goal of the exercise is to help improve each other's apps and so provide constructive criticism in a manner that recognizes the developer's efforts.

<i>[RED] What is something that doesn't work or could be improved?</i>	
<i>[YELLOW] What is something that is confusing or could be done differently?</i>	
<i>[GREEN] What is something that works well or you really like about the project?</i>	

37 VIRTUAL REALITY RUBRICS

DUSTIN

“The most controversial part of the rubric is the peer assessment. Ten percent of the grade was given by each team member to each other, so they had to sit as the team at the end of the project. And they had to talk it out. Although the rubric is quite simplistic, there’s a lot of explanation of what these things are and what type of things I’ll be looking at. There’s a part on the first page where I go into all the different kinds of things I’ll be looking for. I do give them a lot of written feedback. It’s constructive feedback, and I explain to them why. But I am also open to their feedback. I’m definitely not perfect, and if they had a good point about something, like if I gave them a low mark in originality of code and they could show me that it actually was original when I thought it wasn’t, then I would be willing to listen to that.”

Virtual Reality Pain Distraction Reward

Application Rubric

Create a Virtual Reality App for Windows Mixed Reality headsets for children going through cancer treatments. The experience must help distract or reward children while going through the 3 key stages of treatment: preparation, processing and reward.

Your team must implement your VR app using an appropriate game engine such as Unity or Unreal and a modern programming language, such as (C#, Java or C++). Your team must also create and source the required media assets for the app.

Implementation

Several factors will be considered in the grade given for the implementation of the working computer game, these are:

- completed functionality including in game instructions / directions and / or tutorial mode
- adherence to the stated requirements (will the app be effective at either distraction or reward?)
- originality of concept
- complexity and depth of application / experience
 - appropriate challenge/difficulty
 - replay-ability - does the app keep them coming back for me. Will they want to experience it over and over or will once be enough?
- visual impact
 - design and layout of world
 - use of sourced media (3D models, 3D animation, 2D images, sound effects, music etc)
 - use of original media (3D models, 3D animation, 2D images, sound effects, music etc)
- originality of code (A reasonable amount of original code or code that has been modified significantly)
- ease of use – is it intuitive to use or will the kids face a significant learning curve to play your game?
- properly commented code

Evaluation

In this stage, you will produce an individual evaluation report about your own performance, the quality of the final product and how effectively you have worked as a team. This can be a written report with a minimum 700-word count or a video report with a minimum 5-minute length. Your evaluation must include:

- Summary of the project
- Extent to which the solution met the original requirements and your teams' expectations
- Strengths and weaknesses of the solution
- Effectiveness of the development process (including how effectively the team worked together)
- Self-evaluation of your contribution to the team

The remaining part of your grade will be allocated by your peers (team members). Your teacher will oversee and guide the process to ensure that it is fair; however, team members will allocate the grades. The peer evaluation must be considered in relation to each student's work and contribution to the team. Reasons for the allocation of the peer grades should be recorded. An acceptable method would be by recording this in minutes for the meeting where the decisions on this are made. This must include justifications for the grades given.

Rubric Checklist

Student Name _____

Final Due Date	3/15/2019	Submission Date	
Implementation – Group grade			
Completed functionality			/10
Adherence to stated requirements			/10
Originality of concept			/10
Complexity and depth of application			/25
Visual Impact			/20
Originality of code			/10
Ease of Use			/10
Commented code			/5
Game Total			/100
Evaluation – Individual grade			
Self-evaluation			/10
Individual contribution to project (given by teacher)			/10
Peer evaluation of individual contribution to the project (assigned by peers)			/20
Evaluation Total			/40
Overall Total			/140

Peer evaluation guidelines

Letter Grade	Grade out of 20
A	18-20
B	16-17
C	14-15
D	12-13

When coming up with the peer grades, several factors should be taken into consideration, they include:

- Time keeping and attendance in class and at team meetings.
- Work ethic – Did the team mate work hard consistently throughout the project?
- Role – Did they perform their assigned role well? Did they carry out all tasks assigned to the best of their ability?
- Communication and collaboration skills – Did the team mate contribute to the decision-making process and communicate effectively with the rest of the team? If the team mate was the team leader, did they demonstrate strong leadership skills? Was the team mate easy to work with and did they contribute to a positive ethos within the team? Did they collaborate effectively on the project and keep the rest of the team informed about what they were doing?
- Problem-solving skills – Did the team mate cope well with problems and demonstrate strong problem-solving skills?
- Overall contribution – Was the team mate an effective member of the team who made a significant contribution to the overall success of the project?

These factors can also be used as a guide when self-evaluating your own performance in the evaluation report.

38 COURSE FEEDBACK

NATHAN

“At the start of the year, I ask my special ed kids, How do you learn best? Do you like the essays? Do you like multiple choice? Do you have any skills or talents that I don’t know about? I always try to start my class with that information. And at the end of the year, I want to know what I did right and what I did wrong.”

Closing Assignment - Course Feedback

The purpose of this work is to have you reflect on the lessons of the year. Please do your best to answer the questions fully and truthfully.

1: What was your favorite activity this year?

My favorite activity this year in Computer Science was when we started working with python and actually started coding, it was cool to see how what we made was the reason for us getting an answer. For example when we did a math problem it would solve it for us and it was because of what we did.

2: What types of lessons do you think work best?

In my opinion the lessons that work best are the ones where you show us how to do it so we end up having some knowledge of what's going to come.

3: Consider the most challenging assignments that you had. What would you do differently to master the problems you were experiencing?

I would just have paid more attention to what we had to do so I could've done it better.

4: Were there any lessons in particular that you did not like? What could I have done differently to make them more approachable?

Although i found most lessons difficult i liked them all but if there was one to choose from it would be when we started working with studio code because they weren't what i really expected.

5: Are there any topics that you wished we had covered in more detail? What types of things do you wished we studied?

A lot of the things that we did cover and were things i liked therefore there really aren't any things that i wish we had covered more.

6: What are some of the most surprising things that you learned this year?

I already knew that computers really are the reason that things run , but i found out even more reasons and how they make our lives so easy nowadays.

7: If someone asked you about this class, what would you tell them?

I would tell them that if they enjoy working and learning about computers than they should take it , 5 star class.

8: Finish this sentence....Computer science is the study of..... computers

9: Please add anything else you think I should know.

Great class and i liked it a lot.

39 FAVICON SELF-REFLECTION AND RUBRIC

LACEY

“There are short questions at the end to get them reflecting on the ideas of the process. What was hard, what went well, and what would they do differently if they were to do it again? I think a big part of computer science is not just coming up with this finite answer, so we start off the year right away with a pretty simple activity, and yet it’s stressing the partner work, the iterative process, and the challenges. Reflection and discussion don’t get us from point A to point B quickly, but I feel like it meets their learning needs.”

Name _____

Date _____

Favicon Self Reflection and Rubric

Rubric: Evaluate the success in creating a [favicon](#) according the following criteria.

Criteria	Yes	No	Comments
Favicon is 16 by 16 pixels			
Favicon is encoded in RGB color using at least 12-bits-per-pixel			
Favicon is an image, and not merely a pattern			

Reflection Questions

1. What went well for you when creating this favicon? What was challenging?

2. What are the potential benefits of using a greater number of bits in designing your favicon? What are the potential drawbacks?

3. Your classmate claims, "Switching my favicon from binary mode to hexadecimal mode is be an example of compression". Do you agree with classmate? Justify your response.

4. Explain what your personal favicon is a representation of and why you chose to create this particular image.

40 3RD QUARTER SURVEY

ASHLEY

“I look at their goals. So, someone said their goal is to learn how to make a web page, and they’re able to do that, even if it is not the world’s most attractive web page. They’ve learned how to do something, they’ve learned how to create something that they couldn’t create before. I think it’s good to see that they’ve got these goals and then to see where do they get with them. Do they actually reach those? For me, creativity does come down to effort. That’s a big thing. How are you going to quantify effort? How are you going to quantify it, but also make it tangible and specific for kids? I really focus on effort in assessing creativity.”

End of 3rd Quarter Survey 2018-19

Name: *

What is the most important or useful thing you learned during the 3rd quarter? *

What have you LIKED working on this quarter? *

- Harvest of the Month and other graphics
- Media queries
- Flexbox
- CSS grid
- Your personal webpage project
- Other: _____

Why did you LIKE those things? *

What have you NOT LIKED working on this quarter? *

- Harvest of the Month and other graphics
- Media queries
- Flexbox
- CSS grid
- Your personal webpage project
- Other: _____

Why did you NOT LIKE those things? *

At the beginning of the year you set goals for yourself for this class. Do you think you're making progress toward your goals? *

Why or why not? Please briefly explain.

Is there anything you think we should have spent more time on this quarter? *

If yes, please explain what. If no, just say no.

Is there anything that we've learned this quarter that is still confusing to you? *

If yes, please explain what. If no, just say no.

What else do you still need to learn and/or what are you looking forward to learning? *

What are your goals for the LAST quarter of the school year in this class? How do you plan to reach those goals? How can I help you with your goals? *

Please rate your effort for third quarter. *

- High
- Medium
- Low

Please check off what you think you need to work on: *

- Effort
- Arriving to class on time
- Listening and paying attention more
- Minimizing distractions such as your cellphone
- Trying to complete the class goals of the day
- Engaging in class more (raising hand, asking questions, helping others)
- Completing assignments
- Other: _____

I AGREE that my teacher is... *

- As helpful as possible
- Patient
- Well-prepared
- Consistent with taking the time to explain things well
- Other: _____

I think my teacher NEEDS TO WORK ON... *

- Being more helpful
- Being more patient
- Being better prepared
- Explaining things better
- Other: _____

SUBMIT

41

PROJECT REFLECTION

ANDREA

“In this project, the students created a game intended for others to play. I had the students describe the purpose of the game and then what the step-by-step process was in developing the game, or what they had to do in their code, in order for them to be able to visualize and create a solid representation of what their game would look like. Students also submitted a screenshot of what it would look like in the actual computer platform. The goal is for them to be able to explain and represent their work. It helps me understand students’ creative thinking because the student was able to show me what they had envisioned beginning with, in terms of creating a game.”

Sample Student Project #2

My program is intended to be a game, where the player is supposed to get the bat to disappear by shooting watermelons at it. The player must also try and not hit the butterfly because it's the good guy and hitting it will mean the end of the game. The first sprite, which is the bat, uses control blocks to start the game and has a script that changes the ghost effect of the bat if the watermelon touches it. It also has a motion blocks to make the bat go to random spots across the screen. The second sprite, which is the butterfly, has the same script as the bat except the ghost effect change is higher. The third sprite just follows where the mouse is pointed. The fourth sprite is set to start on top of the wand and when the mouse is clicked the watermelon will go to the clicked point.

An incremental process that occurs in this program is the size change of the bat sprite and the butterfly sprite. The bat's size will decrease every time it is hit with the watermelon. The butterfly's size however will increase every time it is hit. Now an iterative process of this program is the ghost effect of the bat and butterfly sprite. A ghost effect will be added to the sprites making it harder to see them but if the bat is hit enough times and completely disappears the game is over. A problem I had was when the watermelon touched the sprite the sprite didn't have a ghost affect change. I fixed this by adding a pause time to when the watermelon touched the sprite, this way the sprite had a moment to sense the watermelon instead of the watermelon returning to the wand immediately. The program described was an independent development.

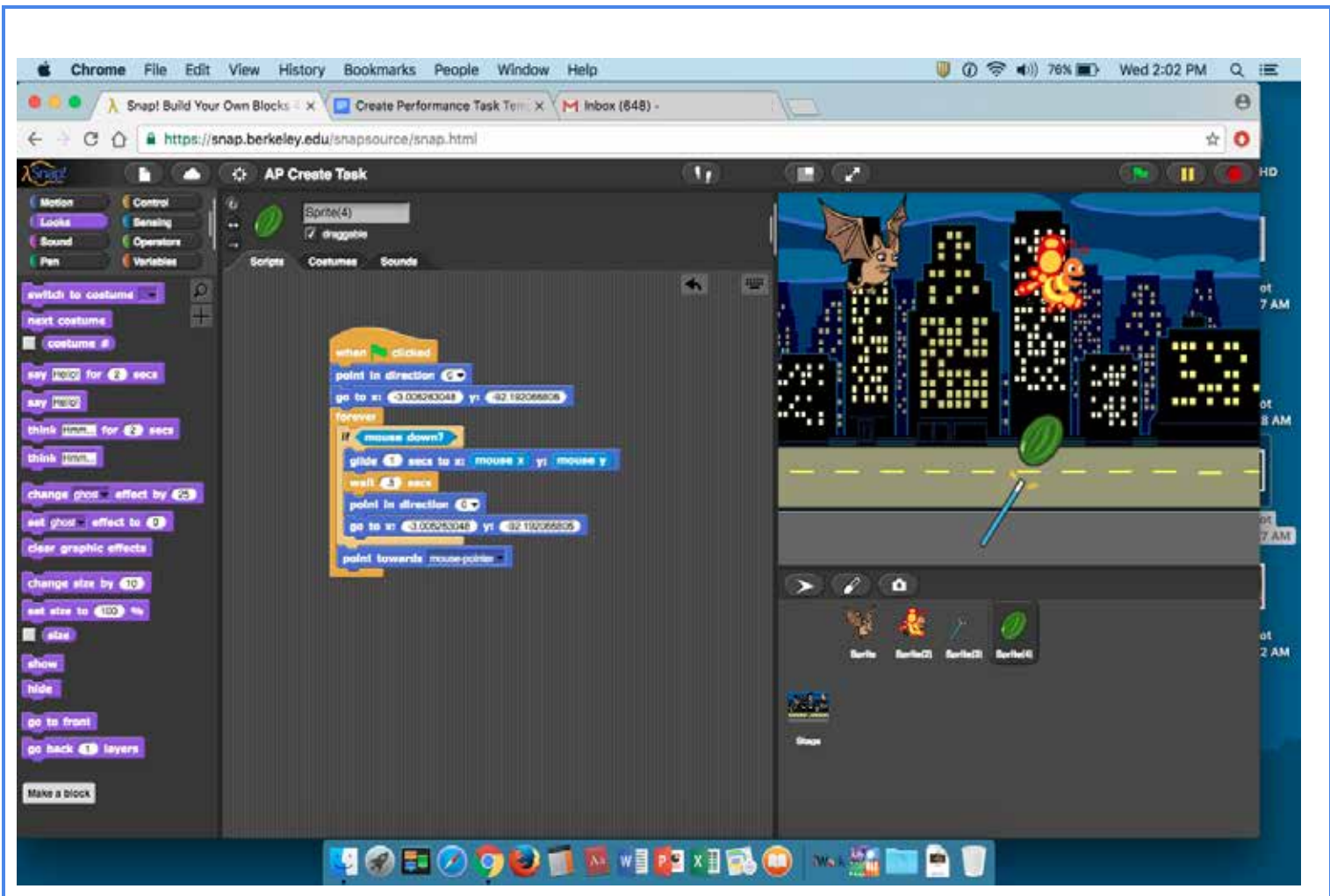

One mathematical concept used was where the sprite will appear at random spots on the screen. The algorithm picks a random number for the x and y coordinates that will allow the sprite to appear on the screen. A logical concept used was when both sprites are hit with the watermelon the sprite touching the watermelon will have a ghost affect change. The algorithm created from these concepts both work for the first and second sprite. It will make them appear at random spots constantly and it will make the game harder.

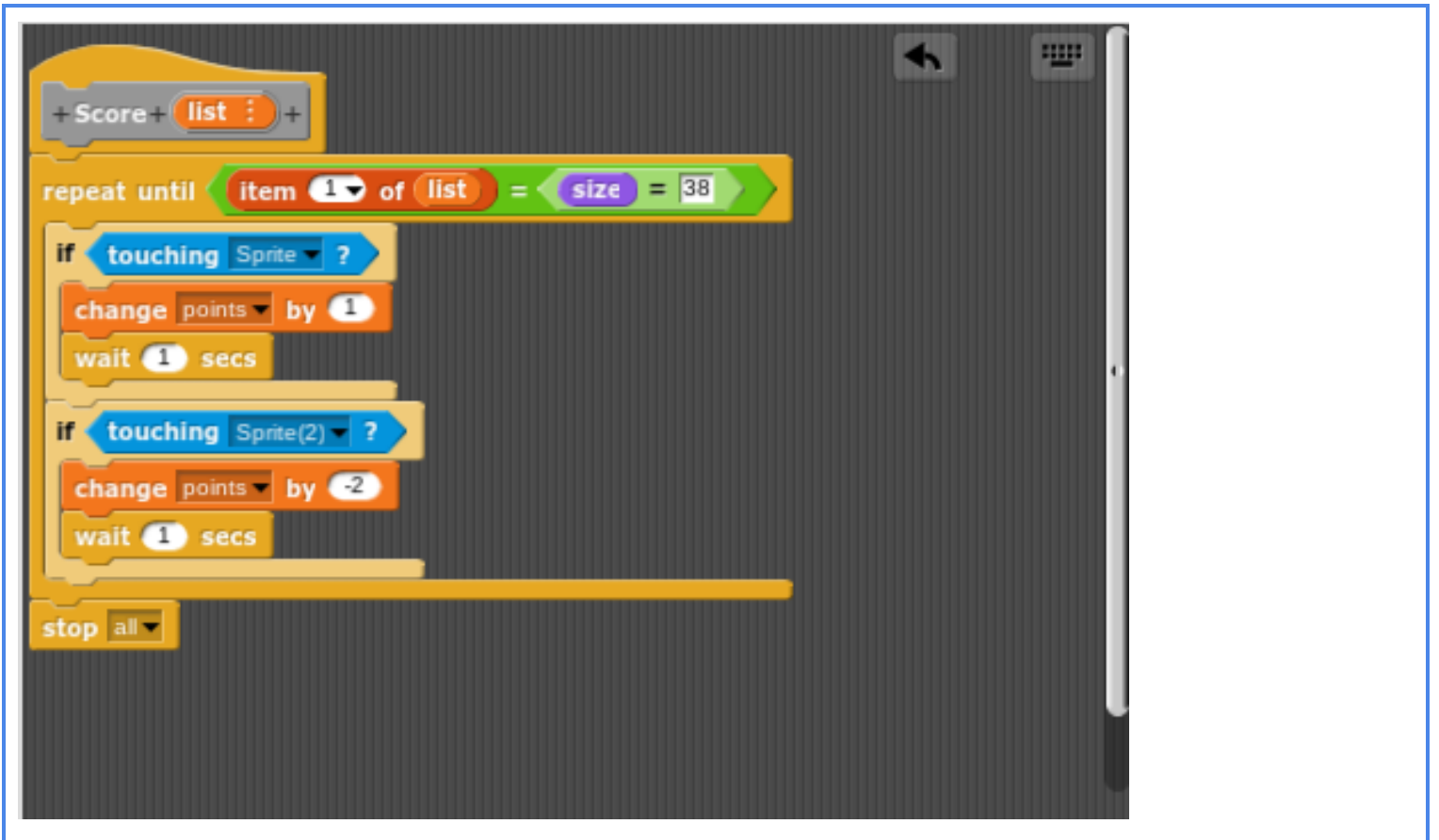

My abstraction is the point system for the program, and it also ends the game. This abstraction shows the player how well they did in the game. A higher score means they did well and a lower score means they did poorly. The abstraction also stops the game when the player gets to a certain point.

42 FINAL PROJECT

CRYSTAL

“Our culture has defined our success by a score, and I don’t think that defines who we are. I mean, I try to tell students all the time, *Some of the most creative people were not the best students in certain areas. You cannot define who you are and where you’re going by your scores.*”

FINAL PROJECT

CREATE AN ORIGINAL SCRATCH GAME:

You will **create** an original Scratch game.

****No Remix****

CRITERIA:

Game must have:

Characters - Players use an on-screen character to enter the game world. It could be an animal, a princess, a race car, or even just a simple bubble. To create a sense of danger or competition, such games usually also have enemy characters that the player has to defeat or escape from.

Objects - Games include objects, from stars and coins that boost health or scores to keys that unlock doors. Not all objects are good, some get in the player's way, sap their health, or steal their treasures. Objects can also work together to create puzzles for the player to solve.

Mechanics - These are the "verbs" in a game: actions such as running, jumping, spinning, flying, capturing objects, casting spells, and using weapons. The mechanics are the core of the game, and well-designed mechanics make a good game.

Rules - The rules of a game tell you what you're allowed and not allowed to do. For example, can you walk through walls or do they block your path? Can you stop and think or do you have to beat the clock?

World - Think about the world in which a game is played. Does the player view the game from above, from the side or from within? Does the game world have walls or boundaries that limit the player's movement or is it open like the outdoors?

Goals - Every game challenges the player to achieve some kind of goal, whether it's winning a race, conquering an enemy, beating a high score or simply surviving for as long as you can. Most games have lots of small goals, such as unlocking doors to new levels or winning new skills

Difficulty level - A game is not fun if it's too easy or too hard. Many games make the challenges easy at the start, while the player is learning and more difficult later as the player's skills improve. Getting the difficulty level just right is the key to making a great game.

Code Structures: The flow of the program and structure of the code must have properly demonstrated the effective use of a variable for keeping score, a loop for repetitive code. Additionally, nested loops to ensure animations or drawings are properly demonstrated. Lastly, what would a game be without some kind of decision to be made.

GAME IDEA GENERATOR:

Types of Game	Types of Worlds	Types of Goals
Maze	Forest	Patrolling enemies
Jumping	Space	High Score
Quiz	Underwater	Collecting Objects
Vehicle simulator	City	Life counter
Virtual pet	Castle	Time limit
Interactive story	Beach	Multiplayer

SCRATCH GAME RUBRIC:

Percentage:	0-50%	50-75%	75-99%	100%
Points	0-4 points	5-6 points	8-9 points	10 points Total= 50 points
Characters 10 points	Game has 1 - 2 sprites that don't do very much for the flow or theme.	Game has 2-3 sprites that make the game <i>entertaining but don't interact or have errors.</i>	Game has enough sprites to make game entertaining, but some don't interact.	Game has enough sprites, very entertaining, interact and play a role
Objects 10 points	Objects are present but not used and/ or errors in code when run.	Game has objects that are not necessary to game and have errors.	Game has objects that engage with the sprites but have an error.	Game has objects that engage with NO errors noted
Mechanics 10 points	Sprites and objects are inactive	Sprites and objects have some movement and have errors in code	Sprites and objects are very interactive with little to no errors.	Sprites and objects are very interactive with NO errors
World 10 points	No backgrounds	Backgrounds are not relevant to game	Very interesting world with a certain view but backgrounds lacking.	Very interesting world with relevant backgrounds.
Difficulty Level 10 points	Simplistic game. No Score, Lives, etc., kept	Mildly entertaining, not very difficult.	Challenging and entertaining game but levels are lacking flow.	Very challenging and Entertaining, Score, Lives, etc.
	0-19 points	20-29 points	30-39 points	40 points
Structures of Code: Variables, Loops, Nested Loops, If/Else,etc. 40 points	Game has minimal required Code structures and/or program does not run due to errors.	Game has a few structures of code that are not used correctly are run with 2-3 errors noted.	Game has required structures-Variable, Loops, Nested loops, and IF/Else statements with little to no errors.	Game has all required structures and no errors noted.
	0 - 9 points			10 points
Project completed and turned in on time. 10 points	Projects more than a day late will be deducted 10 points. Projects more than 2 days late will not be accepted.			Project completed and submitted on time.

43

DEMONSTRATION CHECKLIST

DUSTIN

“Assessment should become part of the learning process, not just a way to give students a grade at the end of the year. It is difficult to do, especially with a creative subject, like computer science, especially if students are creating something like a game or a virtual reality simulation—how do you grade that? Assessment does become holistic and subjective, and those are some of the big difficulties. How do you make it consistent? At some point, you do have to have some kind of rubric or checklist, because there are some things that you need to include.”

Demonstration Checklist

Student Name _____

Date			Completed
	Task		
	Teach a friend in class how to build your VR app		/20
	1. Build part of a 3D environment, which MUST include placement of at least 5 3D objects. The 5 objects can include 3D models and/or Unity 3D objects such as cubes or spheres. If you are adding Unity 3D objects then you should apply materials to them.		
	2. Add in at least 3 interactable objects (should be in addition to the objects from step 1). At least one of these objects MUST be able to be picked up or touched.		
	3. Add code so that the interactable objects do something when a collision occurs, probably between 2 of the objects. At least two separate things must happen, depending on the objects that interact with each other.		
	4. Add at least one sound effect to occur at an appropriate point in your simulation		
	5. Enable UI text to display something related to interaction in the scene.		
	6. One advanced coding task of your choosing, such as Spawning objects, Timer(s), automatically moving objects, etc. You must agree this with your teacher beforehand.		
	Be taught how to build a VR app by a friend		/10
	Teach a parent or care giver how to build your VR app		/50
	1. Build part of a 3D environment, which MUST include placement of at least 5 3D objects. The 5 objects can include 3D models and/or Unity 3D objects such as cubes or spheres. If you are adding Unity 3D objects then you should apply materials to them. (10 marks)		
	2. Add in at least 3 interactable objects (should be in addition to the objects from step 1). At least one of these objects MUST be able to be picked up or touched. (10 marks)		
	3. Add code so that the interactable objects do something when a collision occurs, probably between 2 of the objects. At least two separate things must happen, depending on the objects that interact with each other. (10 marks)		
	4. Add at least one sound effect to occur at an appropriate point in your simulation (5 marks)		
	5. Enable UI text to display something related to interaction in the scene. (5 marks)		
	6. One advanced coding task of your choosing, such as Spawning objects, Timer(s), automatically moving objects, etc. You must agree this with your teacher beforehand. (10 marks)		
	Record yourself teaching parent or care giver		/20
	Deduction for using help sheet (30 seconds or less 5 mark deduction, up to 3mins 10 marks off)		/-10
	Total	/100	

44 PROJECT TEMPLATE

ERIN

“For any project that takes place over multiple days, it’s very important that I do not leave students for too long before we touch base, just to see where they are and if they understand what they’re doing. That’s why I’m having them self-assess because I think it’s really an important skill to teach them. I need to make them participants in the process.”

TEMPLATE 2– Project Template

A) Describe your project
1 Paragraph Minimum

B) Reflect on your project. What problems did you have? What changes did you make?
1 Paragraph minimum.

Take a Snip of all of your application code.

- If you need to do it in multiple snips that's okay.
- This page will be submitted as a separate PDF with your create portfolio.

Capture and paste your entire program code in this section.

- Mark with an **oval** the segment of program code that implements the **algorithm** you created for your program that integrates other algorithms and integrates mathematical and /or logical concepts. (YOU NEED 2 OVALS)
- Mark with a **rectangle** the segment of program code that represents an **abstraction** you developed. (YOU NEED 1 RECTANGLE)
- Include comments or citations for program code that has been written by someone else.

Section 2C – Algorithms

Capture and paste the program code segment that implements an algorithm (marked with an oval in section 3 below) that is fundamental for your program to achieve its intended purpose. Your code segment must include an algorithm that integrates other algorithms and integrates mathematical and/or logical concepts. Describe how each algorithm within your selected algorithm functions independently, as well as in combination with others, to form a new algorithm that helps to achieve the intended purpose of the program. (*Approximately 200 words*)

THESE ARE ALGORITHMS

- 1) Mathematical concepts include mathematical expressions using arithmetic operators and mathematical functions. (EK 5.5.1.D)
- 2) Logical concepts include Boolean algebra and compound expressions. (EK 5.5.1E and 5.5.1F)
- 3) Iteration is the repetition of part of an algorithm until a condition is met or for a specified number of times. (EK 4.1.1D)
- 4) Selection uses a Boolean condition to determine which of two parts of an algorithm is used. (EK 4.1.1C)
- 5) Iteration is the repetition of part of an algorithm until a condition is met or for a specified number of times. (EK 4.1.1D)
- 6) Selection uses a Boolean condition to determine which of two parts of an algorithm is used. (EK 4.1.1C)

Paste your block(s) that contain your algorithm.

What type of abstraction is this?

Why is it a good example of this algorithm type?

Section 2D – Abstractions

Capture and paste the program code segment that contains an abstraction you developed (marked with a rectangle in section 3 below). Your abstraction should integrate mathematical and logical concepts. Explain how your abstraction helped manage the complexity of your program.

(Approximately 200 words)

THESE ARE ABSTRACTIONS – Highlight 1

1) Procedures

2) Parameters, Variables

3) Lists

4) Application program interfaces (APIs)

5) Lists and other collections can be treated as abstract data types (ADTs) in developing programs. (EK 5.5.11)

Paste your block(s) that contain your abstraction.

What type of abstraction is this?

Why is it a good example of this abstraction type?

45 MOD CRITIQUE

KYLIE

“The designer explains what the modifications are, and the tester answers questions about improvements to the game, and they have a conversation about the creative decisions that were made. This is a nice way to incorporate peer feedback about creativity. What I’m trying to get the students to do is to think about creative addition and the user’s experience. Bringing another person into the conversation helps them push their thinking along because they’re testing their ideas out on an actual user. It’s great to get feedback from a peer and to watch someone play your game, because that can be hard if you’re a little defensive, but it’s also very illuminating. I’ve seen really good, trusting partnerships where they’re willing to be vulnerable on both sides of receiving and giving feedback.”

Mod Critique

Player's Name: _____

Game Designer's Name: _____





Game Name: _____

1. Describe the game play and function of the original game to your player. Ask the player to test the original game and make sure he/she is facile with the game before moving on.
2. Explain the modification you intended to make in the game. Have the player test this feature specifically.
3. Questions for player:
 - How does this new feature improve game play?
 - Does the feature do anything to detract from the original game play?
 - Would the player suggest any extensions/additional features to this mod? Were any bugs found in the play testing process?

46 DESIGN RUBRIC

CHARLES

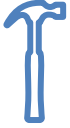
“This really isn’t a rubric, it’s more of a checklist. But if the kid is learning and they’re enjoying themselves and the assessment is successful, then they’re internalizing and learning how to code. They’re using the computer as a material. I think that’s really important. They give the rubric to me, I grade it, and give it back to them. Especially with that project, if they didn’t like their grade, they would just redo it, and then their grade would go up. It’s just a quick checklist to say, *What am I doing right? What am I doing wrong?*”

Design Rubric	UNSATISFACTORY (5 points)	COMPETENT (10 points)	PROFICIENT (15 points)	DISTINGUISHED (20 points)
Technique & Concepts 	Work lacks understanding of concepts, materials, and skills.	Work shows some understanding of concepts, materials and skills.	Work reflects understanding of concepts and materials, as well as use of skills discussed in class.	Work shows a mastery of skills and reflects a deep understanding of concepts and materials.
Habits of Mind 	Student passively attempts to fulfill assignment without much thought or exploration of possibilities. Student refuses to explore more than one idea.	Developing exploration of possible solutions and innovative thinking. Student has more than one idea but does not pursue.	Student explores multiple solutions and innovative thinking develops and expands during project.	Consistently displays willingness to try multiple solutions and ask thought provoking questions, leading to deeper, more distinctive results. Student fully explores multiple ideas and iterations
Reflection & Understanding 	Student shows little awareness of their process. The work does not demonstrate understanding of content.	Student demonstrates some self-awareness. Work shows some understanding of content, but student cannot justify all of their decisions.	Student shows self-awareness. Work demonstrates understanding of content and most decisions are conscious and justified.	Work reflects a deep understanding of the complexities of the content. Every decision is purposeful and thoughtful.
Craftsmanship 	Work is messy and craftsmanship detracts from overall presentation.	Work is somewhat messy and craftsmanship detracts somewhat from overall presentation.	Work is neat and craftsmanship is solid.	Work is impeccable and shows extreme care and thoughtfulness in its craftsmanship.
Effort 	Work is not completed in a satisfactory manner. Student shows minimal effort. Student does not use class time effectively.	Work complete but it lacks finishing touches or can be improved with a little effort. Student does just enough to meet requirements.	Completed work in an above average manner, yet more could have been done. Student needs to go one step further to achieve excellence.	Completed work with excellence and exceeded teacher expectations. Student exhibited exemplary commitment to the project.

Name _____

Score: _____

47

GROUP PLANNING GUIDE

RHONDA

“Assessments are a celebration of learning. They’re a time to show off all that you’ve learned for yourself, for your teacher, and for your peers. It’s a good thing. I want students to do as well as they can. Anytime they don’t do as well as they can, I give them a chance to retake, retest, or find other ways to prove to me what they know.”

Group Planning Guide

Choosing a topic: Before you begin make sure you’ve reviewed the submission guidelines and rubric. Then pick a scene that has the following features:

- Have several components that allow it to be broken into logical chunks (functions)
- Have repeated elements that will allow you to use loops and random values
- Use a function with a parameter (same figure but different size / color / dimensions, etc.)

<p>Scene Description What is the topic? What are the different pieces of the scene?</p> <hr/> <hr/> <hr/> <hr/> <hr/> <hr/> <hr/> <hr/> <hr/> <hr/> <hr/> <hr/>	<p>Scene Sketch Make a quick sketch of the scene. Write notes to clarify points. Use the back of this sheet if you need.</p>
--	---

Identify Top-Level Functions and Assign to Group Members

Use Top Down Design to identify the major components of your scene. Give each component a top-level function. In the Under the Sea project these were `drawAllFish()`, `drawAllSeagrass()`, `drawAllBubbles()`, etc. Then assign each function to a member of the team to program individually. They may need to further divide their component into smaller functions later.

Scene Component	Function Name	Group Member

(use back side of page if you need more)

48 GRADES EXPLAINED

ASHLEY

“I tell my students at the beginning of the year that I keep grades as invisible as possible. I want them to be focused on why they’re taking the class and what they’re going to get out of it, because my class is an elective. You’re not going to get a grade on every little thing that you do. We’re going to try to make sure you’re hitting the goals that you set for yourself. Assessment, for me, is about having them do a lot of reflection on what they’ve learned. I show to students this grade grid. I have personal conferences around grade time and say, *This is how your grade broke down.*”

Grades Explained



Effort & Progress

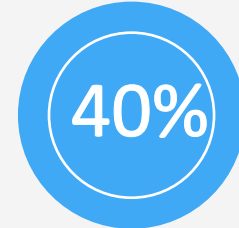
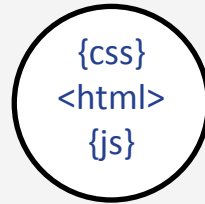

Work & Participation

Try Hard, Make Progress

60% of your grade is your EFFORT and the progress you make toward the goals you set for yourself.

**Just Try
It May Change Your Life**

Class Work and Participation



20% of your grade is completing your work and 20% is class participation, which includes speaking in class, Post-it reflections, and tweeting @ClassTwitterAccount

Coding
Programming
Games
Teach
Apps
DESIGN
LEARN

Grade Grid

Effort 60% (60 points)	Your Points	Class Work 20% (20 points)	Your Points
Your effort rating (from 1st quarter survey) <i>9-11 pts high</i> <i>6-8 pts medium</i> <i>1-5 pts low</i>		Student page on class website <i>1-4 pts</i>	
Listening when teacher or others are talking <i>6-7 pts usually/always</i> <i>4-5 pts sometimes</i> <i>1-2 pts seldom/never</i>		Harvest of the Month graphic design challenge <i>1-4 pts</i>	
Following instructions from teacher and/or on class website <i>6-7 pts usually/always</i> <i>4-5 pts sometimes</i> <i>1-2 pts seldom/never</i>		HTML Championships <i>1-4 pts</i>	
Focusing on task at hand and minimizing distractions (your phone, non-class related websites) <i>6-7 pts usually/always</i> <i>4-5 pts sometimes</i> <i>1-2 pts seldom/never</i>		Pixlr image challenges <i>1-4 pts</i>	
Asking questions when confused <i>6-7 pts usually/always</i> <i>4-5 pts sometimes</i> <i>1-2 pts seldom/never</i>		CSS Quote <i>1-4 pts</i>	
Engaging in class (raise hand, help others, ask others for help) <i>6-7 pts usually/always</i> <i>4-5 pts sometimes</i> <i>1-2 pts seldom/never</i>		Goal Progress 20% (20 points)	
Attempting to complete goals of class for the day <i>6-7 pts usually/always</i> <i>4-5 pts sometimes</i> <i>1-2 pts seldom/never</i>		Your goal self-assessment (end of 1st quarter survey) <i>1-3 pts little progress</i> <i>4-7 pts some progress</i> <i>8-10 pts good progress</i>	
Trying hard and enjoying learning something new! <i>6-7 pts usually/always</i> <i>4-5 pts sometimes</i> <i>1-2 pts seldom/never</i>		My assessment of your goal progress <i>1-3 pts little progress</i> <i>4-7 pts some progress</i> <i>8-10 pts good progress</i>	
Extra credit (1-5 pts max)			
Points total and grade			

49 GAME DESIGN RUBRIC

KENDRA

“We made the rubric as a class. I gave them an option to do three or four columns in the rubric, and I give them the game design principles in that class. They make rubrics in groups, and then we share all the groups’ work at the front of the class and people pick and choose to merge the rubric. It takes two or three days to make that. But then we use it to grade four computer games. They have a lot of freedom. It’s good because everyone agrees on the rubric, really talking about what’s important in the beginning.”

Rubric for Game Design

Objective: Develop a rubric we will use to grade each of the games you create in class.

- As a class, choose one of the templates below.
- Then, choose the standards and describe how to obtain the specific scores within each category.

Option 1:

Standard	Exceeds Expectation	Meets Expectations	Approaches Expectations	Does not Meet Expectations

Option 2:

Standard	Meets Expectations	Approaches Expectations	Does not Meet Expectations

Class A

Rubric for Game Design

Standard	Meets Expectations	Approaches Expectations	Does not Meet Expectations
Functionality	Everything works as intended and there are no loopholes or uncovered instances within the game. The game is smooth and plays well - no glitches/bugs/crashes	The game has a few issues and can be a struggle to play. There may be a couple of rules or components that are somewhat unclear or not working as intended.	The game has a lot of glitches/bugs/crashes and is unplayable according to the rules set forth.
Rules	There is a great list of rules that make sense. The game is not confusing to play, rules are understood	Rules are somewhat understandable and gameplay is at least playable. There are a good amount of rules, but the game is still somewhat confusing in how to play.	Players are lost because the rules are difficult to understand and gameplay is unplayable. The rules are unclear or don't make sense in the context of the game. There are minimal to no rules present.
Balance: Accessibility	Is welcoming to any players.	Is welcoming to some players.	Only high level players can play
Balance: Difficulty	Has some tricks up its sleeves to mess with the player, needs a strategic way to win the game	The game is moderately difficult but still easy to complete.	Not a challenge to anyone, game is too easy, not hard to beat.
Replayability/ Hook	Can play over and over despite finishing the game once. The game offers incentives to continue playing and is fun enough for players to want to play it over again, or sink more time into the game in order to earn more.	Can play at least twice before getting bored. The game is relatively replayable, or at least offers enough incentive for someone to come back to it once or twice.	Can only clear the game once and then forget about it. The game doesn't offer any incentive for players to continue playing. One play through of the game sufficiently makes players no longer want to play.
Entertainment	The game is extremely fun to play and was very well thought out. The game has entertaining content to enthrall the player. Objectively the game feels good to play and offers solid incentives of enjoyment to play.	The game is fairly fun - there are some parts that aren't very enjoyable or are too repetitive, but overall enjoyment can be found within the game.	The game is not fun, the gameplay isn't engaging and there is very little reason to play because it isn't enjoyable whatsoever.

Class B

Rubric for Game Design

Standard	Exceeds Expectation	Meets Expectation	Approaches Expectations	Does Not Meet Expectations
Functionality	Game runs with no errors, glitches, and problems.	Game runs with some problems but is replayable as is	Game runs but has too many problems, glitches and errors, or it cannot be replayed	Game does not run. Numerous problems with how the game works.
Visual Quality	Art is mindblowing to the point where it looks like real life.	Art is visually appealing	Art is of mediocre quality	Art is not visually appealing
Entertainment Value	Extremely fun and makes you want to play it over again/ Addictive	Game is fun but you probably wouldn't want to play it often.	Game has some entertainment, but more could be added to make it more engaging	Game is not fun to play at all
Goal/Storyline	Has an exceptionally creative end goal/storyline	Has a good end goal/storyline	Has an OK end goal/storyline	The end goal/storyline does not work
Difficulty of Instruction	Game rules are easy to follow. Game is easy to pick up.	Most parts of the game make sense, but some clarification is needed on the rules.	The rules are hard to follow.	Game rules are too difficult to figure out, and some parts are impossible.

50 KINETIC SCULPTURE PROJECT OVERVIEW

RENEE

“There’s no right answer to creative work. Students are looking at artists’ work, and they’re identifying their own inspiration and defining what a kinetic sculpture is to them. I think creativity is applying the CS content knowledge to any problem that they take on. It is up to students to figure out how to put together the hardware and write the code to make it work. They submit drafts as they’re going along, partly just to check in that they’re doing it, and partly to give them feedback and make sure that they’re going to get the best grade they can, by the end of the project.”

===== PROJECT OVERVIEW =====

I. INTRODUCTION & ARTIST'S STATEMENT

I decided to base my kinetic sculpture report on the similarities of Arthur Ganson's work and Jean Tinguely. I incorporated the automated and computer caused movements from Tinguely's work. I liked the idea of being able to enjoy the art the same way an audience would without my presence. Ganson's work inspired me to choose something that I see around me all the time and creating something connected to me. Specifically, Ganson's meditation #1 and the predictability of the moving gears interested me. I decided to replicate the predictability in my own product. Tinguely's sometimes colorful and world sourced machines inspired me to have a little fun with the colors of my product. Tinguely also inspired me to use recyclable items rather than 3D print the parts of my clock.

I decided to create a clock because it's something that relates to me all the time. I wake up at a certain time, move from one place to another according to time and it basically plays a large and controlling role on the world. I decided to remix a clock to demonstrated how it moves and how I wish it would move to benefit me. I wanted for once for time to move at my pace. I drew inspiration in the fun found in both Ganson and Tinguely's work.

II. DESIGN

Drawn Blueprint:

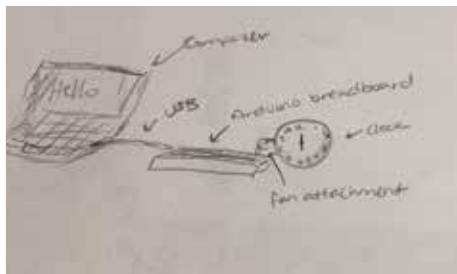

The above image depicts the blueprint I created for how I wanted my product to look.

Isometric View:

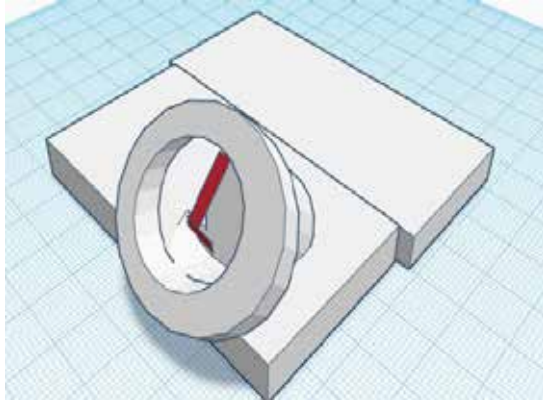

The image above depicts a tinkercad created view of the top and sides of my product.

Orthographic View:

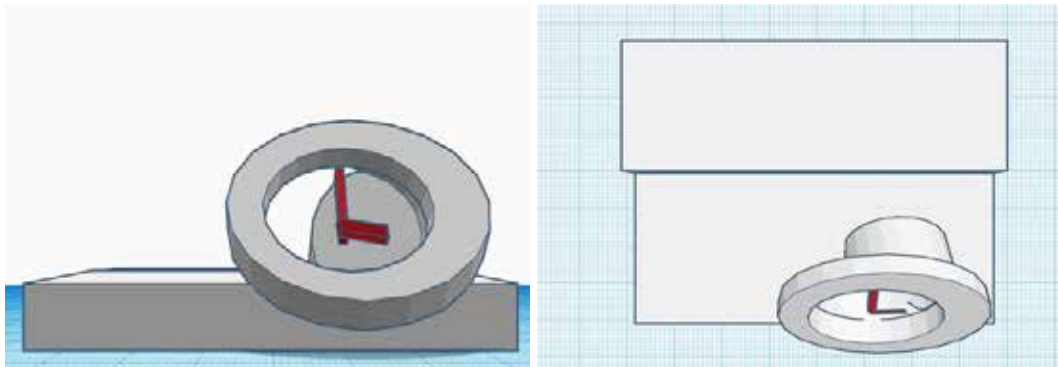

The above images depict a tinkercad created view of the the top and front of my product.

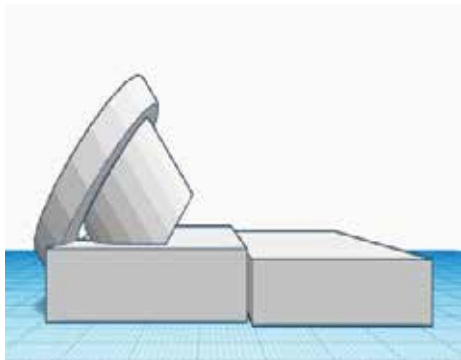

The above images depicts a tinkercad created view of the side of my product.

The above designs clearly depict a moving clock sculpture. The base of the image is simply indicating the arduino board and location of where the DC motor will be connected. Inside the ring shows the two clock hands that will be moved by the DC motor. The ring will be the base for the basic clock numbers 1 to 12.

III. PRODUCT DEVELOPMENT

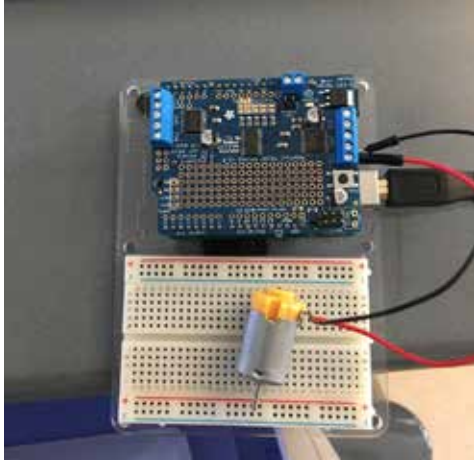

I initially envisioned to use a DC Motor because it did a full 360 degrees and I had the most experience using it. Unfortunately, it spun too fast even at the lowest speed setting and would not move slow enough for the movement of my clock to be as realistic as possible.

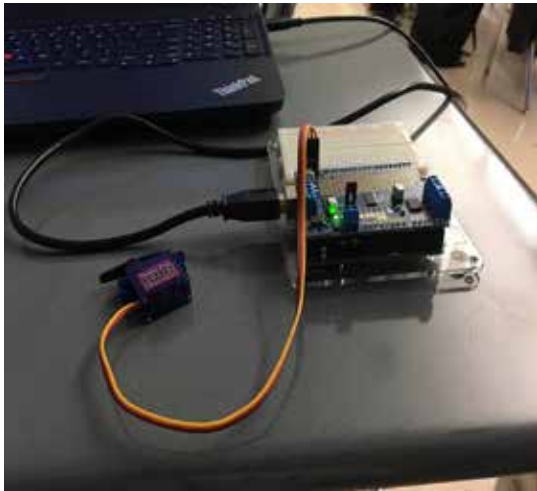

My next step was to attempt using the servo motor, but the motor did not do the full 360 motion. In addition, in order for it to move with clock hands I would need to make the clock size significantly smaller to account for the screws necessary to make the motor motion.

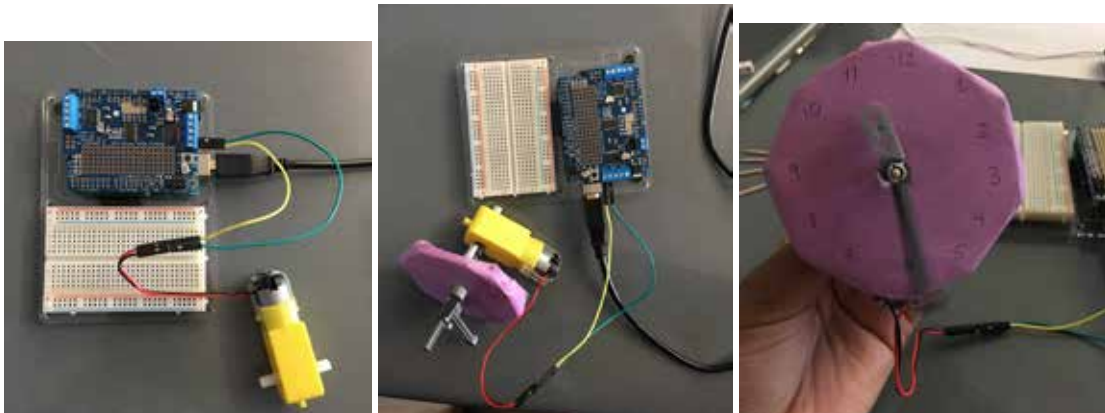

I decided to return back to using a DC motor, only using a larger and slower moving one. The bigger motor allows for the clock to sit more comfortably than the smaller motor and moves the clock hands slower. To make the actual clock I cut out a circle from foam board and covered it in construction paper. To support the clock and the hands, and minimize the movement of the clock I used a toothpick to extend the length of the motor. I then glued together two lego pieces that would act as clock hands to the toothpick. The gluing together of the clock and lego pieces ensured that the necessary parts were moving.

===== FINAL PRODUCT & CODE =====

IV. FINAL PRODUCT

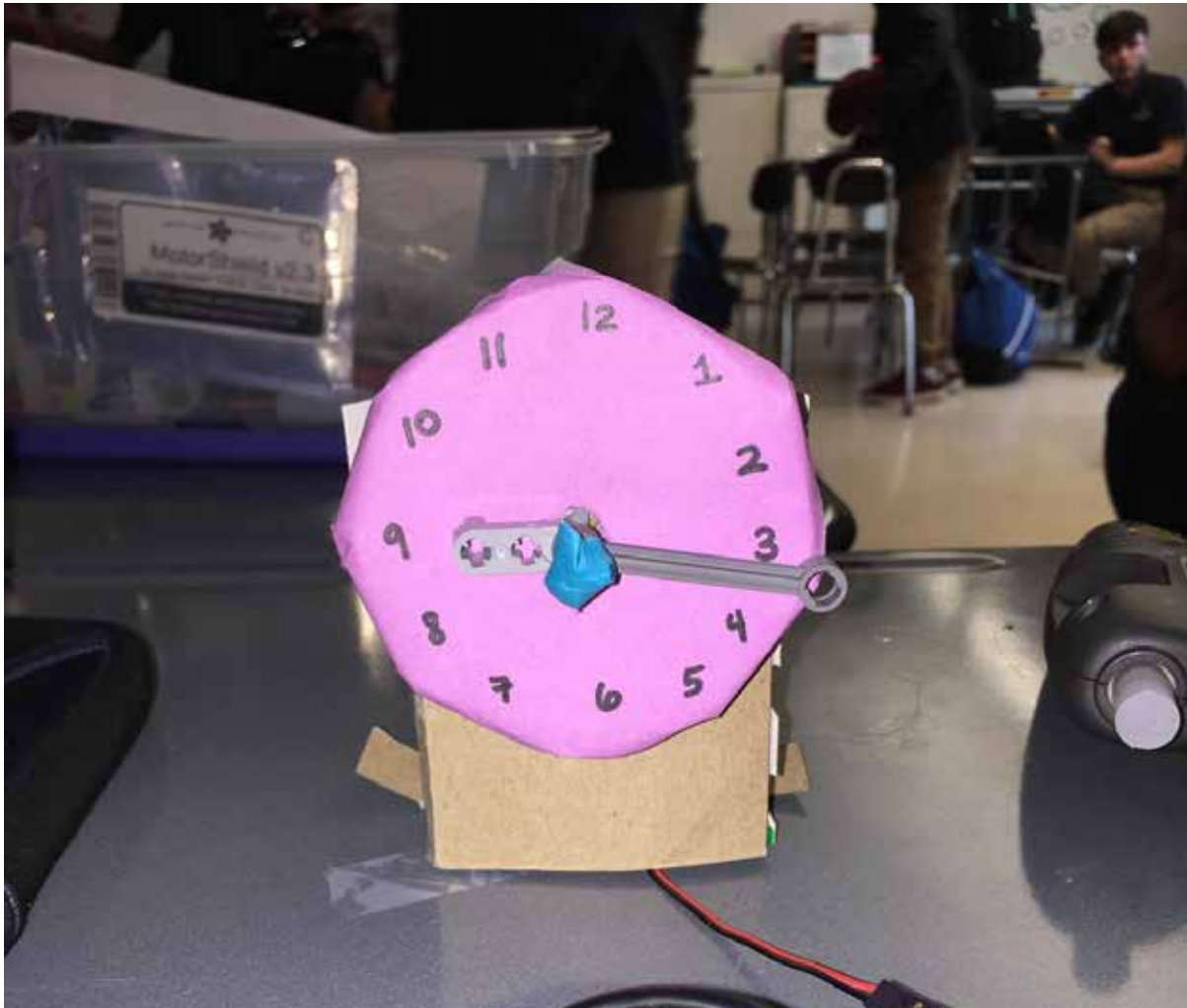

My final product is clearly inspired by Tinguely and Ganson because it is colorful, constructed of many different recyclable parts (not 3D printed) and my idea stems from the world around me.

V. CODE

```
#include <Wire.h> // call to a code library used
#include <Adafruit_MotorShield.h> // call to a code library used
Adafruit_MotorShield AFMS = Adafruit_MotorShield(); //identifying motorshield is in use
Adafruit_DCMotor *myMotor = AFMS.getMotor(1); // adds that 1 motor is attached to motor shield
void setup(){ // calls set up of code and motor
  AFMS.begin(); //begins reading through code
}
void loop(){ // makes code run in loop
```



```
myMotor-> setSpeed(1); //sets the initial speed of motor
myMotor->run(FORWARD); //makes motor move in a certain direction
for(int i=1; i<500; i++){ // increases speed of motor by 1 if the speed is less than 500
  myMotor->setSpeed(i); //sets and sends the speed of the motor
  delay(10); //delays the motion of the motor by 10ms
}
```

```
myMotor->run(BACKWARD); // code to run motor backwards
for(int i=0; i<255; i++){ //increases motor speed by 1 if the speed is less than 255
  myMotor->setSpeed(i); // sets and sends the speed of the motor
  delay(10); //delays the motion of the motor by 10ms
}
```

```
myMotor->run(RELEASE); // runs the motor and allows its motion
delay(0); // no delay of motion
}
```

===== TESTING AND EVALUATION =====

VI. TESTING

Test	Data	Expected Outcome	Actual Outcome	Changes made as a result
Normal	No User input	The clock moves forward and backward without stopping or breaking off clock attachments.	The clock moves forward and backward without stopping or breaking off clock attachments.	No changes made
Extraneous	User interferes with clock rotation	Clock handles stop and potentially come off.	Clock face moves. Clock handles stop and potentially come off.	Secure clock face with tape on the back.
Extreme	Shake product vigorously while powered	Clock attachments fall off.	Product stays intact and continues functions normally	Created a stand for product to avoid potential breakdown.

VII. PRODUCT STRENGTHS

My product is cool to look at and relatable. Many other students thought that my clock was a fun take on controlling time. My clock clearly shows the inspiration I took from Tinguely and Ganson.

VIII. PROPOSED IMPROVEMENTS

Some proposed improvements were to make the clock and parts bigger. Increasing the size of the clock and parts would make it seem like a more realistic clock. Another suggested edit was to make the stand more sturdy.



Creative Computing Lab
Harvard Graduate School of Education
creativecomputing.gse.harvard.edu