

# Atlas Copco

## Oil-free scroll compressors

Jefferson Labs.  
PN: 8153 6027 04  
Model: SF-11+ 100 FF LC 200



**SF 8+, SF 11+**

Instruction book

**Atlas Copco**



# Atlas Copco

## Oil-free scroll compressors

SF 8+, SF 11+

From following serial No. onwards: API 770 000

### Instruction book

Original instructions

### Copyright notice

Any unauthorized use or copying of the contents or any part thereof is prohibited.

This applies in particular to trademarks, model denominations, part numbers and drawings.

This instruction book is valid for CE as well as non-CE labelled machines. It meets the requirements for instructions specified by the applicable European directives as identified in the Declaration of Conformity.

2015 - 11

**No. 2920 7140 41**

Replaces No. 2920 7140 40

[www.atlascopco.com](http://www.atlascopco.com)



## Table of contents

<b>1</b>	<b>Safety precautions.....</b>	<b>5</b>
1.1	SAFETY ICONS.....	5
1.2	SAFETY PRECAUTIONS, GENERAL.....	5
1.3	SAFETY PRECAUTIONS DURING INSTALLATION.....	6
1.4	SAFETY PRECAUTIONS DURING OPERATION.....	7
1.5	SAFETY PRECAUTIONS DURING MAINTENANCE OR REPAIR.....	8
<b>2</b>	<b>General description.....</b>	<b>10</b>
2.1	GENERAL DESCRIPTION.....	10
2.2	FLOW DIAGRAM.....	14
2.3	REGULATING SYSTEM.....	16
2.4	ELECTRICAL SYSTEM.....	16
2.5	ELECTRIC DIAGRAM.....	17
2.6	TEMPERATURE PROTECTION.....	17
2.7	AIR DRYER.....	18
<b>3</b>	<b>Controller.....</b>	<b>20</b>
3.1	GENERAL.....	20
3.2	CONTROL PANEL.....	22
3.3	ICONS USED.....	23
3.4	MAIN SCREEN.....	26
3.5	CALLING UP MENUS.....	30
3.6	SHUTDOWN WARNING.....	31
3.7	SHUTDOWN.....	35
3.8	INPUTS MENU.....	35
3.9	OUTPUTS MENU.....	38
3.10	COUNTERS.....	39
3.11	CONTROL MODE SELECTION.....	40



3.12	SERVICE MENU.....	41
3.13	SETPOINT MENU.....	45
3.14	EVENT HISTORY MENU.....	47
3.15	GENERAL SETTINGS MENU.....	48
3.16	INFO MENU.....	49
3.17	WEEK TIMER MENU.....	50
3.18	TEST MENU.....	58
3.19	USER PASSWORD MENU.....	59
3.20	WEB SERVER.....	60
3.21	PROGRAMMABLE SETTINGS.....	69
<b>4</b>	<b>Installation guidelines.....</b>	<b>72</b>
4.1	DIMENSION DRAWING.....	72
4.2	INSTALLATION PROPOSAL.....	72
4.3	ELECTRICAL CONNECTIONS.....	74
4.4	PICTOGRAPHS.....	75
<b>5</b>	<b>Operating instructions.....</b>	<b>77</b>
5.1	INITIAL START-UP.....	77
5.2	STARTING.....	77
5.3	DURING OPERATION.....	78
5.4	STOPPING.....	79
5.5	TAKING OUT OF OPERATION.....	79
<b>6</b>	<b>Maintenance.....</b>	<b>80</b>
6.1	PREVENTIVE MAINTENANCE SCHEDULE.....	80
6.2	SERVICE KITS.....	82
6.3	DISPOSAL OF USED MATERIAL.....	82

<b>7</b>	<b>Adjustments and servicing procedures.....</b>	<b>83</b>
7.1	AIR FILTER.....	83
7.2	AIR COOLER.....	83
7.3	DRIVE MOTOR.....	83
7.4	SAFETY VALVE.....	84
7.5	BELT SET EXCHANGE AND TENSIONING.....	84
7.6	CLEANING THE COMPRESSOR ELEMENT.....	85
7.7	REPLACEMENT OF THE OUTLET PIPE.....	86
7.8	DRYER MAINTENANCE.....	87
<b>8</b>	<b>Problem solving.....</b>	<b>89</b>
<b>9</b>	<b>Technical data.....</b>	<b>91</b>
9.1	ELECTRIC CABLE SIZE AND FUSES.....	91
9.2	REFERENCE CONDITIONS AND LIMITATIONS.....	96
9.3	COMPRESSOR DATA.....	96
<b>10</b>	<b>Guidelines for inspection.....</b>	<b>100</b>
<b>11</b>	<b>PED (Pressure Equipment Directive).....</b>	<b>101</b>
<b>12</b>	<b>Declaration of conformity.....</b>	<b>102</b>

# 1 Safety precautions

## 1.1 Safety icons

### Explanation

	Danger to life
	Warning
	Important note

## 1.2 Safety precautions, general

### General precautions

1. The operator must employ safe working practices and observe all related work safety requirements and regulations.
2. If any of the following statements does not comply with the applicable legislation, the stricter of the two shall apply.
3. Installation, operation, maintenance and repair work must only be performed by authorized, trained, specialized personnel.
4. Never use compressed air as breathing air without prior purification in accordance with local legislation and standards.
5. Before any maintenance, repair work, adjustment or any other non-routine checks, stop the compressor, press the emergency stop button, switch off the voltage and depressurize the compressor. In addition, the power isolating switch must be opened and locked.
6. Never play with compressed air. Do not apply the air to your skin or direct an air stream at people. Never use the air to clean dirt from your clothes. When using the air to clean equipment, do so with extreme caution and wear eye protection.
7. The owner is responsible for maintaining the unit in safe operating condition. Parts and accessories shall be replaced if unsuitable for safe operation.
8. It is not allowed to walk or stand on the compressor or its components.

## 1.3 Safety precautions during installation



All responsibility for any damage or injury resulting from neglecting these precautions, or non observance of the normal caution and care required for installation, operation, maintenance and repair, even if not expressly stated, will be disclaimed by the manufacturer.

These precautions apply to machinery processing or consuming air or inert gas. Processing of any other gas requires additional safety precautions typical to the application which are not included herein.

Some precautions are general and cover several machine types and equipment; hence some statements may not apply to your machine.

### Precautions during installation

1. The machine must only be lifted using suitable equipment in accordance with local safety regulations. Loose or pivoting parts must be securely fastened before lifting. It is strictly forbidden to dwell or stay in the risk zone under a lifted load. Lifting acceleration and deceleration must be kept within safe limits. Wear a safety helmet when working in the area of overhead or lifting equipment.
2. Place the machine where the ambient air is as cool and clean as possible. If necessary, install a suction duct. Never obstruct the air inlet. Care must be taken to minimise the entry of moisture at the inlet air. Consult section Reference conditions and limitations.
3. Any blanking flanges, plugs, caps and desiccant bags must be removed before connecting the pipes.
4. Air hoses must be of correct size and suitable for the working pressure. Never use frayed, damaged or worn hoses. Distribution pipes and connections must be of the correct size and suitable for the working pressure.
5. The aspirated air must be free of flammable fumes, vapours and particles, e.g. paint solvents, that can lead to internal fire or explosion.
6. Arrange the air intake so that loose clothing worn by people cannot be sucked in.
7. Ensure that the discharge pipe from the compressor to the aftercooler or air net is free to expand under heat and that it is not in contact with or close to flammable materials.
8. No external force may be exerted on the air outlet valve. The connected pipe must be free of strain.
9. If remote control is installed, the machine must bear a clear sign stating "DANGER: This machine is remotely controlled and may start without warning".  
The operator has to make sure that the machine is stopped and that the isolating switch is open and locked before any maintenance or repair. As a further safeguard, persons switching on remotely controlled machines shall take adequate precautions to ensure that there is no one checking or working on the machine. To this end, a suitable notice shall be affixed to the start equipment.
10. Air-cooled machines must be installed in such a way that an adequate flow of cooling air is available and that the exhausted air does not recirculate to the compressor air inlet or cooling air inlet.
11. The electrical connections must correspond to the applicable codes. The machines must be earthed and protected against short circuits by fuses in all phases. A lockable power isolating switch must be installed near the compressor.
12. On machines with automatic start-stop system or if the automatic restart function after voltage failure is activated, a sign stating "This machine may start without warning" must be affixed near the instrument panel.
13. In multiple compressor systems, manual valves must be installed to isolate each compressor. Non-return valves (check valves) must not be relied upon for isolating pressure systems.
14. Never remove or tamper with the safety devices, guards or insulation fitted on the machine. Every pressure vessel or auxiliary installed outside the machine to contain air above atmospheric pressure must be protected by a pressure relieving device or devices as required.



15. Piping or other parts with a temperature in excess of 80°C (176°F) and which may be accidentally touched by personnel in normal operation must be guarded or insulated. Other high temperature piping must be clearly marked.
16. For water-cooled machines, the cooling water system installed outside the machine has to be protected by a safety device with set pressure according to the maximum cooling water inlet pressure.
17. If the ground is not level or can be subject to variable inclination, consult the manufacturer.



Also consult following safety precautions: [Safety precautions during operation](#) and [Safety precautions during maintenance](#).

## 1.4 Safety precautions during operation



All responsibility for any damage or injury resulting from neglecting these precautions, or non observance of the normal caution and care required for installation, operation, maintenance and repair, even if not expressly stated, will be disclaimed by the manufacturer.

These precautions apply to machinery processing or consuming air or inert gas. Processing of any other gas requires additional safety precautions typical to the application which are not included herein.

Some precautions are general and cover several machine types and equipment; hence some statements may not apply to your machine.

### Precautions during operation

1. Never touch any piping or components of the compressor during operation.
2. Use only the correct type and size of hose end fittings and connections. When blowing through a hose or air line, ensure that the open end is held securely. A free end will whip and may cause injury. Make sure that a hose is fully depressurized before disconnecting it.
3. Persons switching on remotely controlled machines shall take adequate precautions to ensure that there is no one checking or working on the machine. To this end, a suitable notice shall be affixed to the remote start equipment.
4. Never operate the machine when there is a possibility of taking in flammable or toxic fumes, vapors or particles.
5. Never operate the machine below or in excess of its limit ratings.
6. Keep all bodywork doors shut during operation. The doors may be opened for short periods only, e.g. to carry out routine checks. Wear ear protectors when opening a door.
7. People staying in environments or rooms where the sound pressure level reaches or exceeds 90 dB(A) shall wear ear protectors.
8. Periodically check that:
  - All guards are in place and securely fastened
  - All hoses and/or pipes inside the machine are in good condition, secure and not rubbing
  - There are no leaks
  - All fasteners are tight
  - All electrical leads are secure and in good order
  - Safety valves and other pressure relief devices are not obstructed by dirt or paint
  - Air outlet valve and air net, i.e. pipes, couplings, manifolds, valves, hoses, etc. are in good repair, free of wear or abuse
9. If warm cooling air from compressors is used in air heating systems, e.g. to warm up a working area, take precautions against air pollution and possible contamination of the breathing air.
10. Do not remove any of, or tamper with, the sound dampening material.

11. Never remove or tamper with the safety devices, guards or insulation fitted to the machine. Every pressure vessel or auxiliary installed outside the machine to contain air above atmospheric pressure shall be protected by a pressure relieving device or devices as required.
12. Be aware of possible blow off of safety valves during operation. For the location of the safety valves, consult the description in this instruction book.
13. Yearly inspect the air receiver. Minimum wall thickness as specified in the instruction book must be respected. Local regulations remain applicable if they are more strict.



Also consult following safety precautions: [Safety precautions during installation](#) and [Safety precautions during maintenance](#).

## 1.5 Safety precautions during maintenance or repair



All responsibility for any damage or injury resulting from neglecting these precautions, or non observance of the normal caution and care required for installation, operation, maintenance and repair, even if not expressly stated, will be disclaimed by the manufacturer.

These precautions apply to machinery processing or consuming air or inert gas. Processing of any other gas requires additional safety precautions typical to the application which are not included herein.

Some precautions are general and cover several machine types and equipment; hence some statements may not apply to your machine.

### Precautions during maintenance or repair

1. Always use the correct safety equipment such as safety glasses, gloves, safety shoes, etc.
2. Use only the correct tools for maintenance and repair work.
3. Use only genuine spare parts.
4. All maintenance work shall only be undertaken when the machine has cooled down.
5. A warning sign bearing a legend such as "Work in progress; do not start" shall be attached to the starting equipment.
6. Persons switching on remotely controlled machines shall take adequate precautions to ensure that there is no one checking or working on the machine. To this end, a suitable notice shall be affixed to the remote start equipment.
7. Close the compressor air outlet valve before connecting or disconnecting a pipe.
8. Before removing any pressurized component, effectively isolate the machine from all sources of pressure and relieve the entire system of pressure.
9. Never use flammable solvents or carbon tetrachloride for cleaning parts. Take safety precautions against toxic vapours of cleaning liquids.
10. Scrupulously observe cleanliness during maintenance and repair. Keep dirt away by covering the parts and exposed openings with a clean cloth, paper or tape.
11. Never weld or perform any operation involving heat near any oil system. Oil tanks must be completely purged, e.g. by steam-cleaning, before carrying out such operations. Never weld on, or in any way modify, pressure vessels.
12. Whenever there is an indication or any suspicion that an internal part of a machine is overheated, the machine shall be stopped but no inspection covers shall be opened before sufficient cooling time has elapsed to avoid spontaneous ignition of the oil vapour (if applicable) when air is admitted.
13. Never use a light source with open flame for inspecting the interior of a machine, pressure vessel, etc.
14. Make sure that no tools, loose parts or rags are left in or on the machine.

15. All regulating and safety devices shall be maintained with due care to ensure that they function properly. They may not be put out of action.
16. Before clearing the machine for use after maintenance or overhaul, check that operating pressures, temperatures and time settings are correct. Check that all control and shut-down devices are fitted and that they function correctly. If removed, check that the coupling guard of the compressor drive shaft has been reinstalled.
17. Protect the motor, air filter, electrical and regulating components, etc. to prevent moisture from entering them, e.g. when steam-cleaning.
18. Make sure that all sound-damping material, e.g. on the bodywork and in the air inlet and outlet systems of the compressor, is in good condition. If damaged, replace it by genuine material from the manufacturer to prevent the sound pressure level from increasing.
19. Never use caustic solvents which can damage materials of the air net, e.g. polycarbonate bowls.
20. **The following safety precautions are stressed when handling refrigerant:**
  - Never inhale refrigerant vapours. Check that the working area is adequately ventilated; if required, use breathing protection.
  - Always wear special gloves. In case of refrigerant contact with the skin, rinse the skin with water. If liquid refrigerant contacts the skin through clothing, never tear off or remove the latter; flush abundantly with fresh water over the clothing until all refrigerant is flushed away; then seek medical first aid.
21. Protect hands to avoid injury from hot machine parts, e.g. during draining of oil.
22. Be aware of eventual sharp edges on certain parts of the machine.



Also consult following safety precautions: [Safety precautions during installation](#) and [Safety precautions during operation](#).

## 2 General description

### 2.1 General description

#### Introduction

SF 8<sup>+</sup> and SF 11<sup>+</sup> are stationary, oil free compressors.

The sound insulating canopy contains 2 electric motor driven compressor modules. The front door panel houses the Elektronikon Graphic controller and the emergency stop button. An electric cabinet with the electric components is located behind the front panel.

The compressors are available in 2 canopy versions and can be supplied with or without integrated refrigerant air dryer. The *low canopy version* is the most compact one, while the *high canopy version* has space for up to 2 extra compressor modules (upgrade kits are available).

#### SF

**SF** is the type designation of the compressor variant without integrated dryer. On SF, the compressed air of each compressor module flows via an individual check valve to a common air cooler and leaves the compressor via the air outlet valve.

**SF Full Feature (SF FF)** compressors are SF compressors provided with a refrigerant air dryer, integrated in the bodywork. The dryer removes moisture from the compressed air by cooling the air to near freezing point and automatically draining the condensate.



SF 11<sup>+</sup> FF, low canopy version, front view

1	Elektronikon Graphic controller	S3	Emergency stop button
2	Electric cabinet		



*SF 11+ FF, high canopy version, front view*

1	Elektronikon Graphic controller	S3	Emergency stop button
2	Electric cabinet		

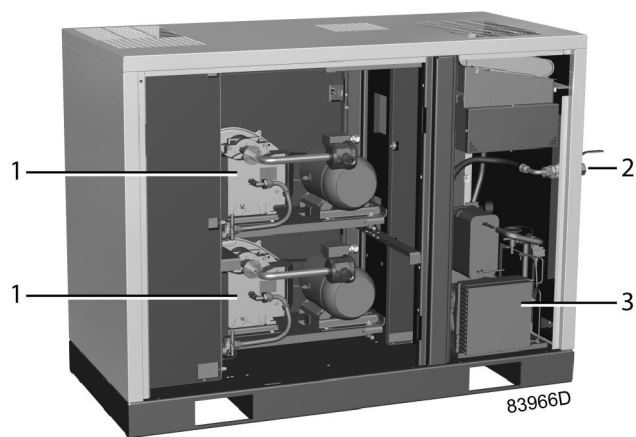

*SF 8+ FF, low canopy version, rear view*

1	Compressor module	3	Refrigerant dryer
2	Compressed air outlet valve		

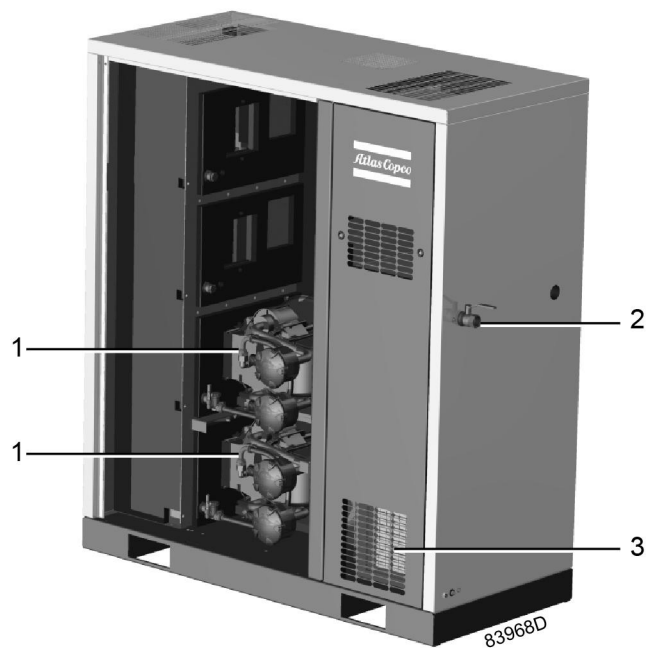

*SF 11+ FF, high canopy version, rear view*

1	Compressor module	3	Refrigerant dryer
2	Compressed air outlet valve		

### Compressor element operating principle

Each compressor element consists of a fixed scroll shaped housing and a scroll shaped rotor. Air enters the compressor element through inlet opening (1). Once the air is drawn in, the orbiting scroll (4) seals the inlet opening and forces the air into a continuously decreasing space. As scroll (4) keeps orbiting, this process of compression is constantly repeated, resulting in discharging of oil free compressed air through outlet opening (3).

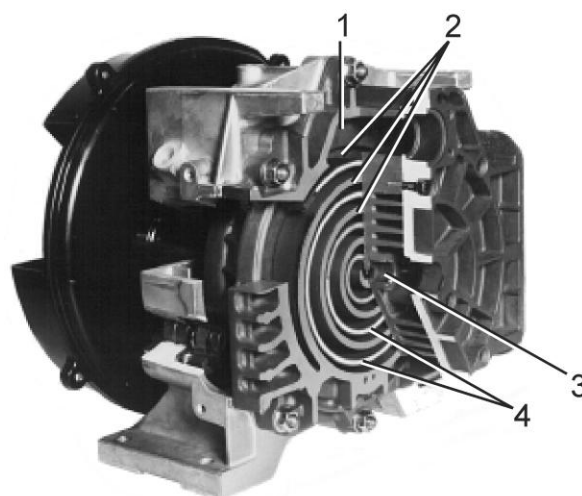

F1023

*Compressor element, typical*

1	Air inlet	3	Air outlet
2	Fixed scroll	4	Orbiting scroll

### Compressor module

The SF 8<sup>+</sup> has two 3.7 kW modules, while the SF 11<sup>+</sup> has two 5.5 kW modules.

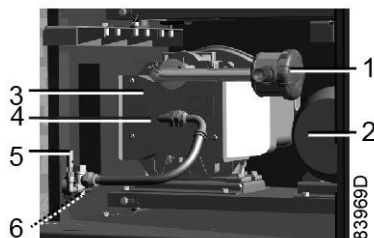

*3.7 kW compressor module*

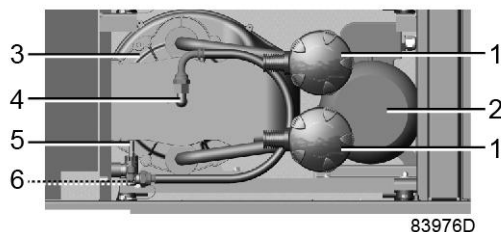

*5.5 kW compressor module*

1	Air filter	4	Compressor element air outlet
2	Motor	5	Safety valve
3	Compressor element	6	Temperature sensor

## 2.2 Flow diagram

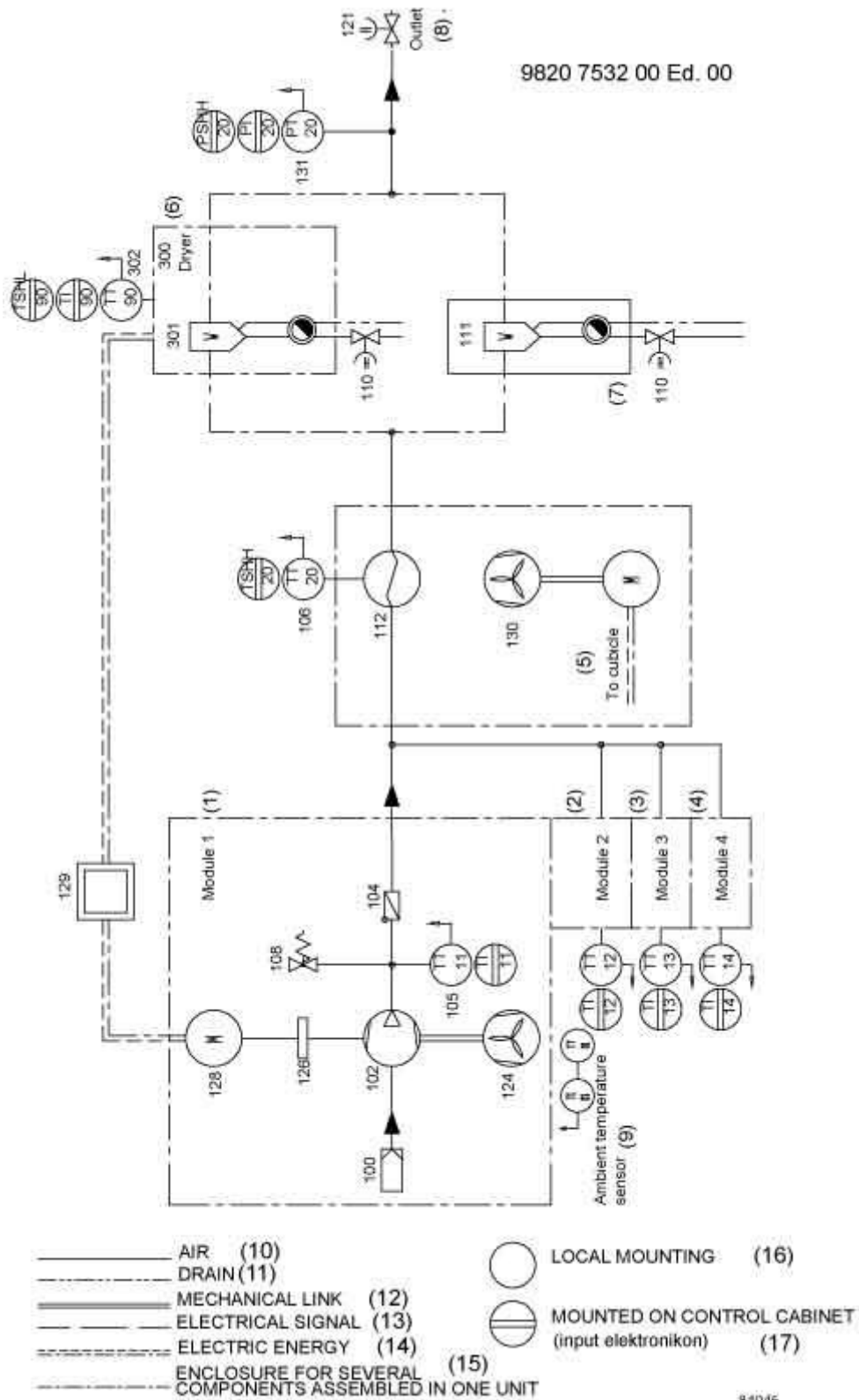

Text on image

(1)	Compressor module 1	(10)	Air
-----	---------------------	------	-----



(2)	Compressor module 2	(11)	Drain
(3)	Compressor module 3	(12)	Mechanical link
(4)	Compressor module 4	(13)	Electrical signal
(5)	To cubicle	(14)	Electric energy
(6)	Refrigerant dryer (units with dryer)	(15)	Enclosure
(7)	Water separator (units without dryer)	(16)	Local mounting
(8)	Outlet	(17)	On control cabinet
(9)	Ambient temperature sensor		

**Air flow**

Air is drawn through air filter (100) and is compressed by the compressor element (102) of each compressor module. The compressed air is discharged via the check valve (104) and a common air cooler (112).

On compressors without integrated dryer, the compressed air passes a water separator (111) and flows to the outlet valve (121).

On standard compressors with an integrated air dryer, the compressed air flows through a common refrigerant dryer (300) before reaching the outlet valve (121). For details on the operation of the dryer, see section [Refrigerant dryer](#).

**Cooling**

Each compressor element (102) is cooled by a radial fan (124), mounted on the drive shaft of the compressor element. The cooling air is blown over the compressor element via a duct.

A separate electric fan (130) provides cooling air for the common air cooler (112).

**Condensate management**

The water separator (111) on compressors without integrated dryer has an automatic condensate outlet and a manual drain valve.

On compressors with integrated dryer, the dryer is equipped with a water trap with an automatic condensate outlet and a manual drain valve.

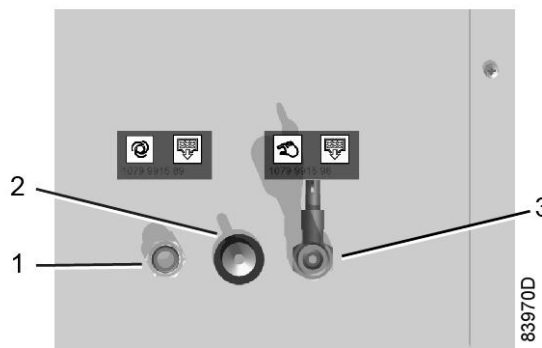

*Condensate drain connections (typical)*

1	Automatic condensate drain outlet	3	Manual condensate drain valve
2	Ambient temperature sensor		

## 2.3 Regulating system

The compressor is provided with an Elektronikon® controller module.

The controller performs following functions:

- Monitoring the pressure
- Protecting the compressor
- Monitoring components subject to service
- Automatic restart after voltage failure

For more details, please consult the sections on the controller further in this book.

## 2.4 Electrical system

### Cubicle layout

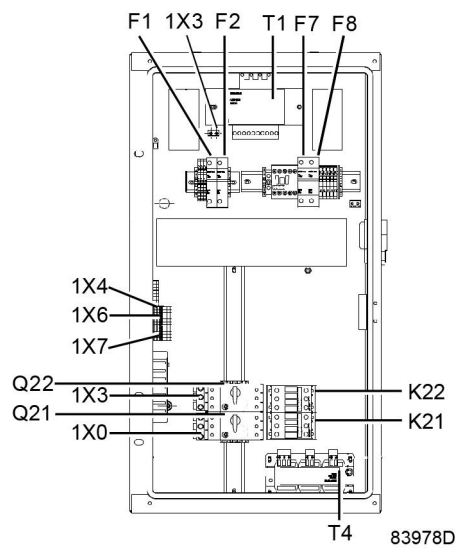

*Electrical cabinet SF 8<sup>+</sup> and SF 11<sup>+</sup>, typical*

K21, K22,...	Contactors	1X0, 4X3,...	Terminals
Q21, Q22,...	Circuit breaker	T1, T4,...	Transformer
F1, F2,...	Fuses		

## 2.5 Electric diagram

	<ul style="list-style-type: none"> <li>• The electrical installation must correspond to the applicable codes.</li> <li>• The mains supply and earthing lines must be of suitable size. See section <a href="#">Electric cable size and fuses</a>.</li> <li>• The installation must be earthed and protected by fuses in each phase.</li> <li>• An isolating switch must be installed near the compressor. Make sure that this switch is open to isolate the compressor from the mains before carrying out any connection.</li> </ul>
--	--

The complete electrical diagram is available in the electric cubicle of the compressor. For connection of the supply wires, please see section [Electrical connections](#).

## 2.6 Temperature protection

The compressor is equipped with an ambient temperature sensor. The sensor creates a warning message on the controller if the ambient temperature rises above 40 °C (104 °F). If the ambient temperature reaches 45 °C (113 °F), the compressor is stopped.

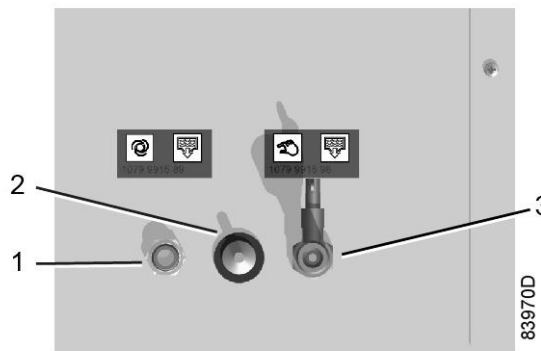

*Condensate drain connections*

1	Automatic condensate drain outlet	3	Manual condensate drain valve
2	Ambient temperature sensor		

Each compressor element is protected by a PT 1000 sensor (6) in the outlet pipe. The sensor is connected to the electronic regulator.

When the maximum temperature is exceeded, the compressor element is stopped during 2 minutes before it can restart. If this happens 2 times within a time span of 2 hours, the element will be stopped during 10 minutes. If the compressor element stops a third time within the 2 hours time span, the element will be shut down and must be reset manually.

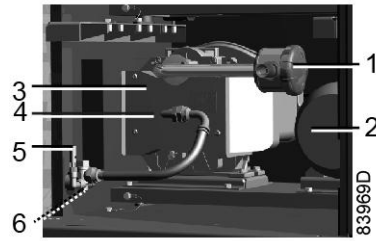

3.7 kW compressor module

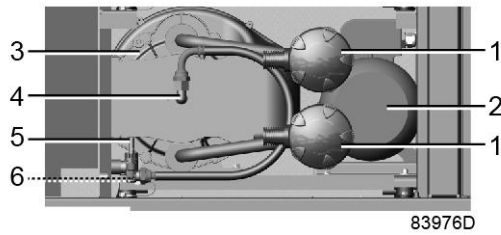

5.5 kW compressor module



When the compressor is stopped due to overheating, the compressor will not restart until the failure is acknowledged and the compressor is restarted manually. See also sections [Shutdown warning](#) and [Shutdown](#).

## 2.7 Air dryer

### Flow diagram

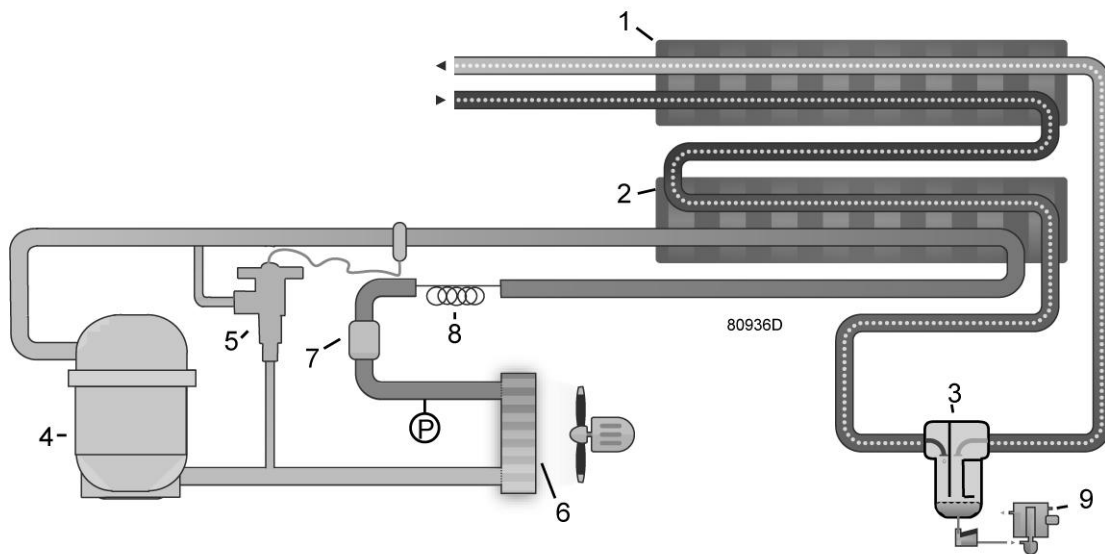

## Compressed air circuit

Compressed air enters heat exchanger (1) and is cooled by the outgoing, cold, dried air. Water in the incoming air starts to condense. The air then flows through heat exchanger/evaporator (2) where the refrigerant evaporates, causing the air to be cooled further to close to the evaporating temperature of the refrigerant. More water in the air condenses. The cold air then flows through separator (3) where all the condensate is separated from the air.

The cold, dried air flows through heat exchanger (1) where it is warmed up by the incoming air.

The condensate is automatically drained by the electronic condensate drain (9).

## Refrigerant circuit

Compressor (4) delivers hot, high-pressure refrigerant gas which flows through condenser (6) where most of the refrigerant condenses.

The liquid flows through liquid refrigerant dryer/filter (7) to capillary tube (8). The refrigerant leaves the capillary tube at evaporating pressure.

The refrigerant enters evaporator (2) where it withdraws heat from the compressed air by further evaporation at constant pressure. The heated refrigerant leaves the evaporator and is sucked in by the compressor.

The condenser (6) pressure must be kept as constant as possible to obtain stable operation. Fan control switch (P) therefore stops and starts the condenser cooling fan. If, under partial or no load, the evaporator (2) pressure drops to approximately 2.25 bar(e) (32.63 psig), the hot gas bypass valve (5) opens and hot, high-pressure gas is fed to the evaporator circuit to prevent the evaporator pressure from dropping any further.

## Automatic drain

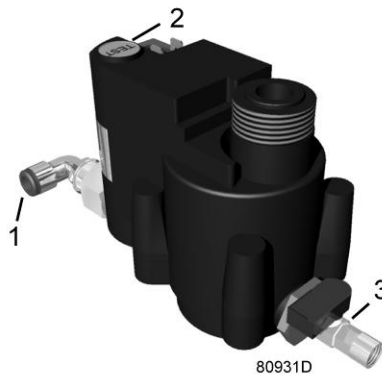

The dryers are equipped with an electronic condensate drain (EWD). The condensate from the condensate trap accumulates in a collector. When the condensate reaches a certain level, it is discharged through the drain outlet (1).

The condensate can also be drained by pressing the test button (2).

The drain filter can be cleaned by opening the manual drain valve (3), see section Preventive maintenance schedule.

## 3 Controller

### 3.1 General

#### Control panel



*Elektronikon® Graphic controller*

#### Introduction

##### The controller has following functions:

- Controlling the compressor
- Protecting the compressor
- Monitoring components subject to service
- Automatic restart after voltage failure (made inactive)

#### Automatic control of the compressor operation

The controller maintains the net pressure between programmable limits by automatically starting and stopping one or more compressor modules. A number of programmable settings, e.g. the starting and stopping pressures and the maximum allowed motor starting frequency and several other parameters are hereby taken into account.

The controller stops the compressor whenever possible to reduce the power consumption and restarts it automatically when the net pressure decreases.



A number of time based automatic start/stop commands can be programmed. Take into account that a start command will be executed (if programmed and activated), even after manually stopping the compressor.

#### Protecting the compressor

##### Shutdown

Several sensors are provided on the compressor. If one of the measured signals exceeds the programmed shutdown level, the compressor will be stopped. This will be indicated on display (1) and general alarm LED (2) will blink.

Remedy the trouble and reset the message. See also section [Inputs menu](#).



Before remedying, consult the applicable safety precautions.

### Shutdown warning / shutdown

If the compressor element temperature exceeds the factory set warning level, the compressor element will be stopped for a short time and a warning will appear on the controller display (1) and the general alarm LED (2) will light up.

In case of repetitive stops due to a too high temperature, a manual reset will be necessary before restarting the compressor.

The compressor will also be stopped when the motor is overloaded.

A warning message will also appear if, on compressors with integrated dryer, the dew point temperature is too high in relation to the ambient temperature.

### Service warning

A number of service operations are grouped (called Service Plans). Each Service Plan has a programmed time interval. If a time interval is exceeded, a message will appear on display (1) to warn the operator to carry out the service actions belonging to that Service Plan.

The running hours will be recalculated with respect to the ambient temperature. This algorithm is activated when the compressor is operated above 30 °C (86 °F) ambient.

### Automatic restart after voltage failure

The controller has a built-in function to automatically restart the compressor when the voltage is restored after voltage failure. For compressors leaving the factory, this function is made inactive. If desired, the function can be activated.

Consult the Atlas Copco Customer Centre if a change is considered (password protected function).



If the function is activated and provided the regulator was in the automatic operation mode, the compressor will automatically restart if the supply voltage to the module is restored within the programmed time interval.

## 3.2 Control panel

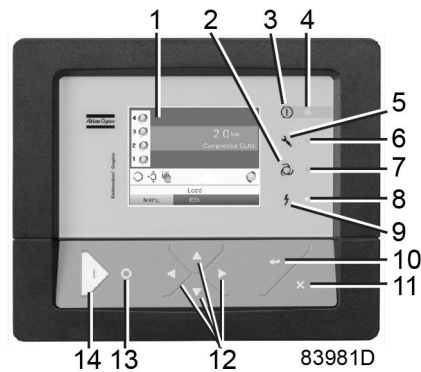

*Control panel*













### Parts and functions





Reference	Designation	Function
1	Display	Shows the compressor operating condition and a number of icons to navigate through the menu.
2	Pictograph	Automatic operation
3	Pictograph	General alarm
4	Alarm LED	Flashes in case of a shutdown, is lit in case of a warning condition.
5	Pictograph	Service
6	Service LED	Lights up if service is needed
7	Automatic operation LED	Indicates that the regulator is automatically controlling the compressor. The compressor is stopped and restarted
8	Voltage on LED	Indicates that the voltage is switched on.
9	Pictograph	Voltage
10	Enter key	Use this button to confirm the last action.
11	Escape key	Use this button to go to previous screen or to end the current action.
12	Scroll keys	Keys to scroll through the menu.
13	Stop button	Button to stop the compressor. LED (7) goes out.
14	Start button	Button to start the compressor. LED (7) lights up indicating that the controller is operative.







### 3.3 Icons used

#### Status icons





Name	Icon	Description
Stopped / Running	 57786F	When the compressor is stopped, the icon stands still. When the compressor is running, the icon is rotating.
Compressor status	 57787F	Motor stopped
	 57789F	Motor running
Machine control mode	 57790F or  59161F	Local start / stop
	 57791F	Remote start / stop
	 57792F	Network control
	 57793F	Automatic restart after voltage failure is active
	 57794F	Week timer is active
Active protection functions	 57795F	Emergency stop
	 57796F	Shutdown
	 57797F	Warning









Name	Icon	Description
Service	 57798F	Service required
Main screen display	 59162F	Value lines display icon
	 82196F	Chart display icon
General icons	 81105D	No communication / network problem
	 82418D	Not valid

**Input icons**







Icon	Description
 57798F	Pressure
 57800F	Temperature
 57801F	Digital input
 57802F	Special protection







**System icons**

Icon	Description
 57803F	Compressor element (LP, HP, ...)
 57804F	Dryer
 57805F	Fan
 57807F	Drain



Icon	Description
 57808F	Filter
 57809F	Motor
 57810F	Failure expansion module
 81105D	Network problem
 57812F	General alarm
 83982D	The compressor module is running and can be stopped
 83983D	The compressor module is stopped and is ready to start
 83984D	The compressor module is awaiting the minimum stop time to expire

**Menu icons**

Icon	Description
 57813F	Inputs
 57814F	Outputs
 57812F	Alarms (Warnings, shutdowns)
 57815F	Counters
 57816F or  82641D	Test
 57817F	Settings

Icon	Description
 57798F	Service
 57818F	Event history (saved data)
 57819F	Access key / User password
 57792F	Network
 57820F	Setpoint
 57867F	Info

**Navigation arrows**

Icon	Description
 57821F	Up
 57822F	Down

**3.4 Main screen**

**Control panel**

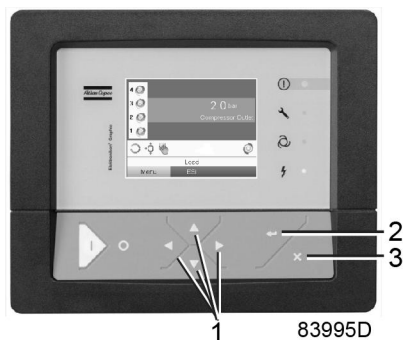

1	Scroll keys
2	Enter key
3	Escape key

### Function

The Main screen is the screen that is shown automatically when the voltage is switched on and one of the keys is pushed. It is switched off automatically after a few minutes when no keys are pushed.

Typically, 6 different main screen views can be chosen:

1. Two value lines
2. Four value lines
3. Chart (High resolution)
4. Chart (Medium resolution)
5. Chart (Low resolution)
6. Scroll animation

### Two and four value lines screens

This type of Main screen shows the value of 2 or 4 parameters (see section [Inputs menu](#)).



*Typical Main screen (2 value lines)*

### Text on image

(1)	Compressor Outlet
(2)	Ambient Air
(3)	Load, Shutdown, ... (text varies upon the compressors actual condition)
(4)	Menu

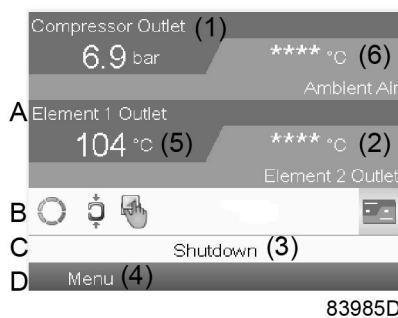

*Typical Main screen (4 value lines), fixed speed compressors*

### Text on image

(1)	Compressor Outlet
-----	-------------------

(2)	Element 2 Outlet
(3)	Off, Shutdown,... (text varies upon the compressors actual condition
(4)	Menu
(5)	Element 1 Outlet
(6)	Ambient Air

- **Section A** shows information regarding the compressor operation (e.g. the outlet pressure, the ambient temperature or the temperature at one of the compressor element outlets).
- **Section B** shows Status icons. Following icon types are shown in this field:
  - Fixed icons  
These icons are always shown in the main screen and cannot be selected by the cursor (e.g. Compressor stopped or running).
  - Optional icons  
These icons are only shown if their corresponding function is activated (e.g. week timer, automatic restart after voltage failure , etc.)
  - Pop up icons  
These icons pop up if an abnormal condition occurs (warnings, shutdowns, service,...)  
To call up more information about the icons shown, select the icon concerned using the scroll keys and press the enter key.
- **Section C** is called the Status bar  
This bar shows the text that corresponds to the selected icon.
- **Section D** shows the Action buttons. Depending on the situation, these buttons are used:
  - To call up or program settings
  - To reset a motor overload, service message or emergency stop
  - To have access to all data collected by the regulator

The function of the buttons depends on the displayed menu. The most common functions are:

Designation	Function
Menu	To go to the menu
Modify	To modify programmable settings
Reset	To reset a timer or message

To activate an action button, highlight the button by using the Scroll keys and press the Enter key.  
To go back to the previous menu, press the Escape key.

**Chart views**

Instead of viewing values, it is also possible to view a graph of one of the input signals (see section [Inputs menu](#)) in function of the time.



59166D

When Chart (High Resolution) is selected, the chart shows the variation of the selected input (in this case the pressure) per minute. Also the instantaneous value is displayed. The screen shows the last 4 minutes. The switch button (icon) for selecting other screens is changed into a small Chart and is highlighted (active).

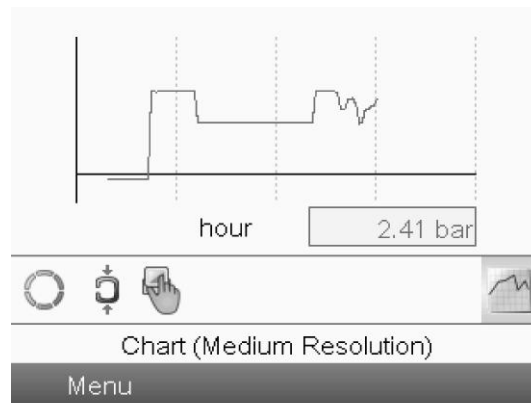

59167D

When the Chart (Medium Resolution) is selected, the chart shows the variation of the selected input per hour. The screen shows the last 4 hours.

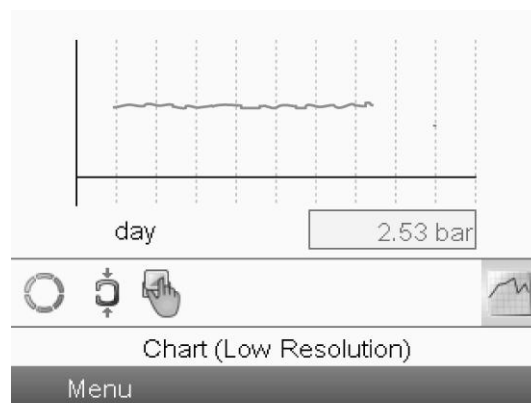

59168D

When the Chart (Low Resolution) is selected, the chart shows the variation of the selected input per day. The screen shows the evolution over the last 10 days.

### Selection of a main screen view

To change between the different screen layouts, select the far right icon in the control icons line (see value lines display icon or chart display icon in section [Icons used](#)) and press the Enter key. A screen similar to the one below opens:

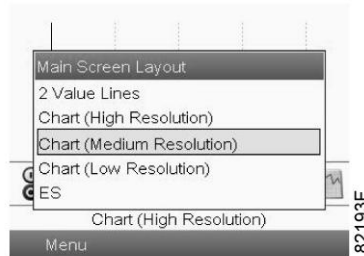

Select the layout required and press the Enter key. See also section [Inputs menu](#).

## 3.5 Calling up menus

### Control panel

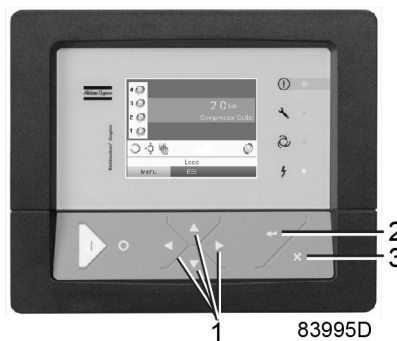

1	Scroll keys
2	Enter key
3	Escape key

### Procedure

When the voltage is switched on, the [Main screen](#) is switched on automatically:



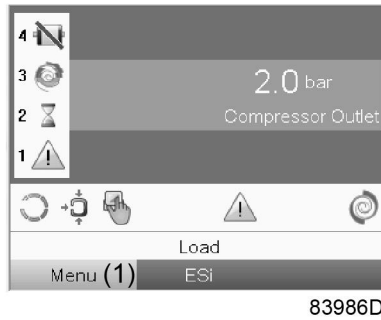

Typical Main screen (2 value lines)

- To go to the Menu screen, select action button Menu (1) by means of the Scroll keys and press the Enter key.  
Following screen appears:

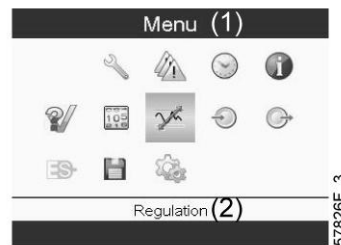

Text on image

(1)	Menu	(2)	Regulation
-----	------	-----	------------

- The menu screen shows a number of icons. Each icon indicates a menu item. By default, the Regulation icon is selected. The status bar shows the name of the menu that corresponds with the selected icon.
- Use the Scroll keys to select the required icon (see further). Pressing the Escape key returns to the Main screen.

### 3.6 Shutdown warning

#### Description

A shutdown warning will appear in the event of:

- Too high element temperature
- Too high ambient temperature
- Too high dew point temperature (on compressors with integrated refrigerant dryer)

#### High element temperature

When a compressor element temperature exceeds the warning level, the element stops during a Minimum Stop Time . It will be restarted automatically after this time has elapsed and if the temperature is below this limit.

As long as the element is stopped, an hourglass icon (1) replaces the element concerned in the main screen:

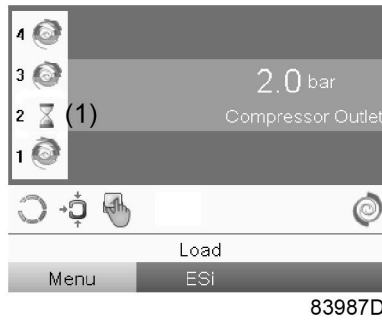

*Element 2 is stopped during a Minimum Stop Time due to a high element temperature*

If the element temperature exceeds the factory set shutdown warning repeatedly, the element will shut down, alarm LED (4) (see section [Control panel](#)) will lit and following screen will appear:

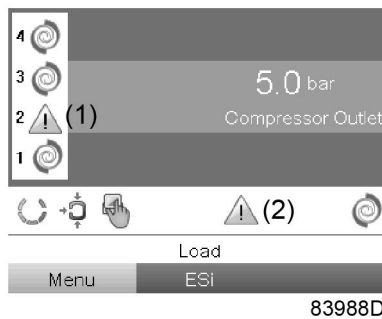

*Element 2 is shutdown due to repeatedly high element temperature warnings*

If this occurs:

1. Switch off the voltage and remedy the problem cause.
2. Switch on the voltage and reset the element manually by selecting the warning icon (or go to warning menu - elements) and press Reset:

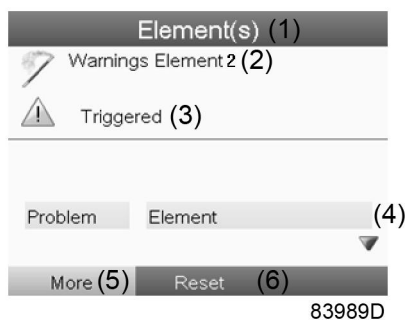

*Warning element screen (element 2 is triggered)*

Text on image

(1)	Element(s)	(4)	Problem Element
(2)	Warning Element 2	(5)	More
(3)	Triggered	(6)	Reset

Each time an element is reset manually, this will be logged in the Element Problem Reset counter:

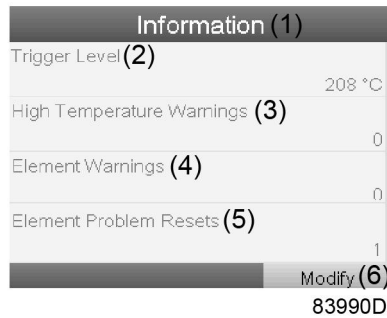

Counter screen where one element was reset manually

Text on image

(1)	Information	(4)	Element Warnings
(2)	Trigger level	(5)	Element Problem Resets
(3)	High Temperature Warnings	(6)	Modify

**High ambient temperature**

If the ambient temperature is above the factory setting (40 °C - 104 °F), a warning is triggered and a warning icon (1) is shown on the main screen:

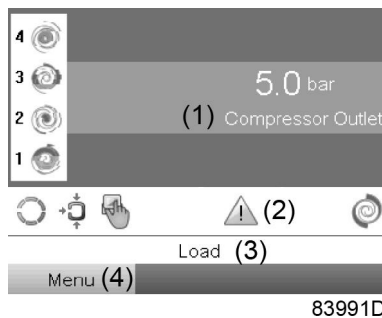

Main screen with high ambient temperature warning

Text on image

(1)	Compressor outlet (pressure)	(3)	Load
(2)	Warning icon	(4)	Menu

If this warning is triggered, the description of this warning can be found in the protection menu. Following screen is shown:

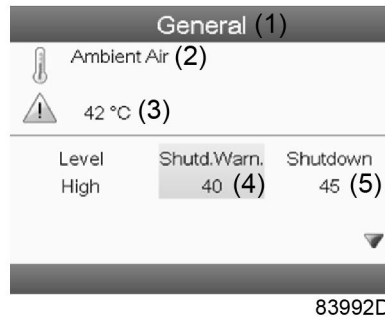

Description of high ambient alarm in the protection menu

Text on image

(1)	General	(4)	Shutd. Warn.
(2)	Ambient air	(5)	Shutdown
(3)	High temperature warning		

Dew point temperature

On compressors with integrated dryer, alarm LED (4) will be lit and the related alarm icon will be flashing if the dew point temperature exceeds the warning level:

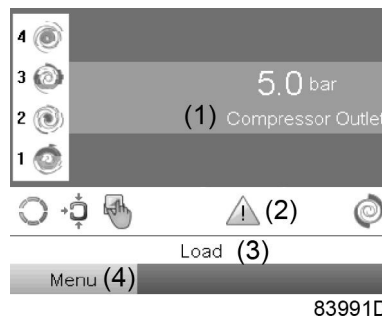

Main screen with dew point exceeding the limit

Text on image

(1)	Compressor outlet (pressure)	(3)	Load
(2)	Warning icon	(4)	Menu

Go to the Input menu to see the actual dew point temperature. Press the Stop button (13 - see section [Control panel](#)) to stop the compressor, switch off the voltage, inspect the compressor and remedy if necessary.

The warning message will disappear as soon the warning condition disappears.

### 3.7 Shutdown

#### Description

The compressor will shut down in case of:

- Too high ambient temperature
- Motor overload
- Outlet pressure sensor error

#### High ambient temperature

If the ambient temperature is above the factory set shutdown temperature (45 °C - 113 °F), the compressor will be stopped and a stop icon will be shown on the main screen of the controller:

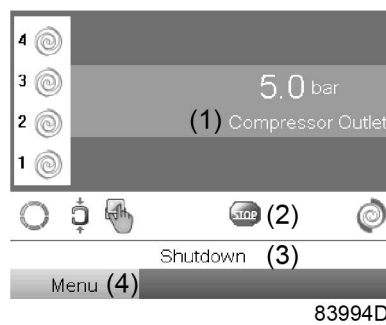

Main screen - shutdown by too high ambient temperature

Text on image

(1)	Compressor outlet	(3)	Shutdown
(2)	Stop icon	(4)	Menu

#### Motor overload

A motor overload relay protects the motor of each compressor module. The motor is shutdown if the motor current is too high.

### 3.8 Inputs menu

#### Menu icon, Inputs



#### Function

- To display the actual value of the measured data (analog inputs) and the status of the digital inputs (e.g. emergency stop contact, motor overload relay, etc.).
- To select the digital input to be shown on the chart in the main screen.

**Procedure**

Starting from the [Main screen](#),

- Move the cursor to the action button Menu and press the Enter key. Following screen appears:

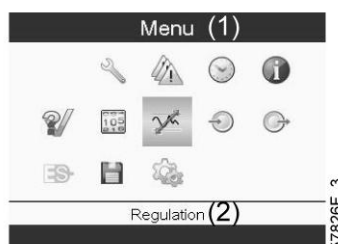

Text on image

(1)	Menu	(2)	Regulation
-----	------	-----	------------

- Using the Scroll keys, move the cursor to the Inputs icon (see above, section Menu icon).
- Press the Enter key. A screen similar to the one below appears:

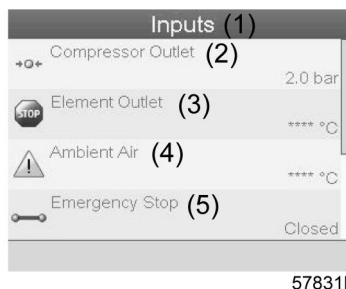

Text on image

(1)	Inputs	(4)	Ambient air
(2)	Compressor outlet	(5)	Emergency stop(Closed)
(3)	Element outlet		

- The screen shows a list of all inputs with their corresponding icons and readings.
- If an input is in warning or shutdown, the original icon is replaced by the warning or shutdown icon respectively (the Stop icon and the Warning icon in the screen shown above).

A small chart icon, shown below an item in the list means this input signal is shown on the chart at the main screen. Any analog input can be selected.

**Selecting another input signal as main chart signal**

With the Modify button active (light grey background in above screen), press the Enter button on the controller. A screen similar to the one below appears:



The first item in the list is highlighted. In this example, the Net Pressure is selected (chart icon). To change, press the Enter button again. A pop up window opens:



Press Enter again to remove this input from the chart. Another confirmation pop up opens:

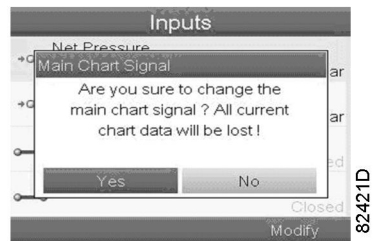

Select Yes to remove or No to quit the current action.

In a similar way, another input signal can be highlighted and selected as Main Chart signal:

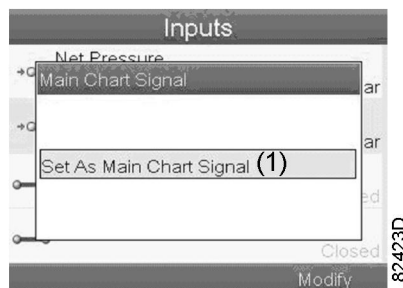

Text on image

(1)	Set As Main Chart Signal		
-----	--------------------------	--	--

### 3.9 Outputs menu

#### Menu icon, Outputs



#### Function

To call up information regarding the actual status of some outputs such as the condition of the Fan motor overload contact, the general warning contact, etc.

#### Procedure

Starting from the [Main screen](#),

- Move the cursor to the action button Menu and press the Enter key. Following screen appears:

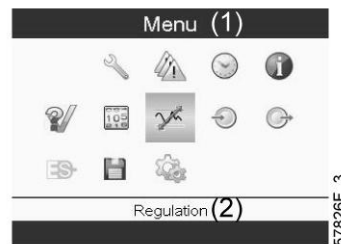

Text on image

(1)	Menu	(2)	Regulation
-----	------	-----	------------

- Using the Scroll keys, move the cursor to the outputs icon (see above).
- Press the Enter key. A screen similar to the one below appears:



*Outputs screen (typical)*



Text on image

(1)	General	(4)	General warning
(2)	General shutdown	(5)	Cabinet fan
(3)	Fan motor		

- The screen shows a list of all outputs with their corresponding icons and readings.  
If an output is in warning or shutdown, the original icon is replaced by the warning or shutdown icon respectively.

### 3.10 Counters

Menu icon, Counters



Function

To call up:

- The running hours
- The loaded hours
- The number of motor starts
- The number of hours that the regulator has been powered
- The number of load cycles

Procedure

Starting from the [Main screen](#),

- Using the Scroll keys, move the cursor to the action button Menu and press the Enter key. Following screen appears:

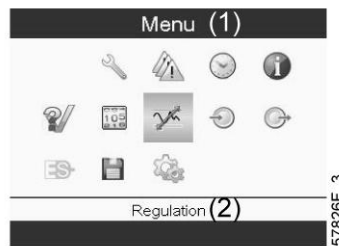

Text on image

(1)	Menu	(2)	Regulation
-----	------	-----	------------

- Using the Scroll keys, move the cursor to the Counters icon (see above).
- Press the Enter key. Following screen appears:



83997D

Text on image

(1)	Counters	(4)	Fan starts
(2)	Shutdowns element 2	(5)	Module hours
(3)	Load relay		

The screen shows a list of all counters with their actual readings.

### 3.11 Control mode selection

#### Function

To select the control mode, i.e. whether the compressor is in local control, remote control or controlled via a local area network (LAN).

#### Procedure

- Starting from the [Main screen](#), make sure action button Menu (1) is selected:



83998D

Text on image

(1)	Menu		
-----	------	--	--

- Next, use the scroll buttons to go to the control mode icon (2) and press the Enter key (see section [Icons used](#) for the meaning of the icons):



- There are 3 possibilities:
  - Local control (1)
  - Remote control (2)
  - LAN control (3)

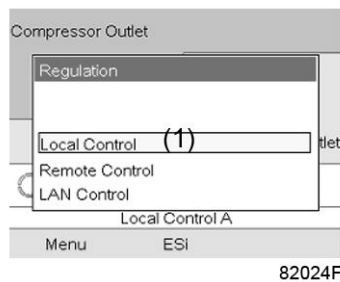
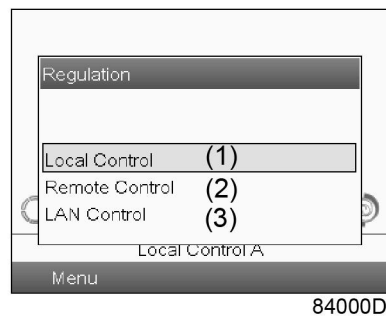

After selecting the required control mode, press the Enter key on the controller to confirm your selection. The new control mode selection is now visible on the main screen.

## 3.12 Service menu

### Menu icon, Service



### Function

- To reset the service plans which are carried out.
- To check when the next service plans are to be carried out.
- To find out which service plans were carried out in the past.
- To modify the programmed service intervals.

**Procedure**

Starting from the [Main screen](#),

- Move the cursor to the action button Menu and press the Enter key. Following screen appears:

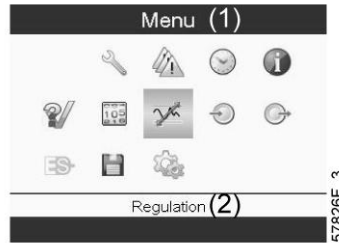

**Text on image**

(1)	Menu	(2)	Regulation
-----	------	-----	------------

- Using the Scroll keys, move the cursor to the Service icon (see above, section Menu icon).
- Press the Enter key. Following screen appears:

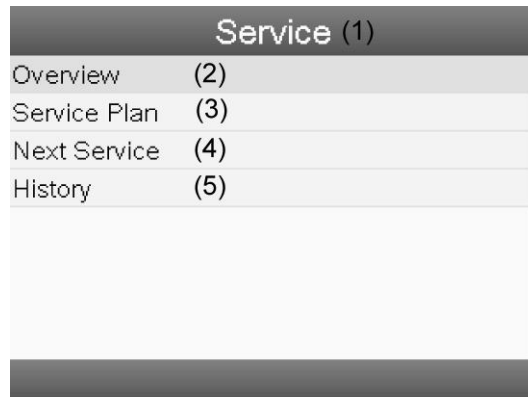

**Text on image**

(1)	Service	(4)	Next service
(2)	Overview	(5)	History
(3)	Service plan		

- Scroll through the items to select the desired item and press the Enter key to see the details as explained below.

**Overview**



**Text on image**

(1)	Overview	(3)	Real Time (hours)
(2)	Running Hours	(4)	Reset

Example for service level (A):

The figures at the left are the programmed service intervals. For Service interval A, the programmed number of running hours is 2500 hours (upper row) and the programmed number of real time hours is 8760 hours, which corresponds to one year (second row). This means that the controller will launch a service warning when either 2500 running hours or 8760 real hours are reached, whichever comes first. Note that the real time hours counter keeps counting, also when the controller is not powered.

A new algorithm is implemented for a better protection of the compressor elements. The running hours will be recalculated depending on the ambient temperature. A compressor continuously running in an ambient temperature between 30 °C (86 °F) and 35 °C (95 °F) is working in harder conditions than an element running at 20 °C (68 °F). Therefore a service done earlier (a time reduction of 30 % is applied in this temperature zone) will protect the element in a better way. In the zone between 35 °C (95 °F) and 40 °C (104 °F), the time reduction is 60 %.

The figures within the bars are the number of hours to go till the next service intervention. In the example above, the compressor was just started up, which means it still has 2500 running hours or 8305 hours to go before the next Service intervention.

**Service plans**

A number of service operations are grouped (called Level A, Level B, etc...). Each level stands for a number of service actions to be carried out at the time intervals programmed in the controller.

When a service plan interval is reached, a message will appear on the screen.

After carrying out the service actions related to the indicated levels, the timers must be reset.

From the Service menu above, select Service plan (3) and press Enter. Following screen appears:

Service Plan (1)		
Level (2)	Running(3) Hours	Real (4) Time
A	500	2190
B	2500	8760
C	5000	17520
D	5000	17520
E	10000	35040
F	10000	35040
		(5) Modify

84002D

Text on image

(1)	Service plan	(4)	Real time hours
(2)	Level	(5)	Modify
(3)	Running hours		

### Modifying a service plan

Dependant on the operating conditions, it can be necessary to modify the service intervals. To do so, use the Scroll keys to select the value to be modified. A screen similar to the one below appears:

Service Plan (1)		
Level (2)	Running(3) Hours	Real (4) Time
A	500	2190
B	2500	8760
C	5000	17520
D	5000	17520
E	10000	35040
F	10000	35040
		(5) Modify

84002D

Press the Enter key. Following screen appears:

Service Plan (1)		
Level (2)	Running (3)	Real (4)
Modify Hours		
	100000	
	4000	
	0	
E	32000	
		(5) Modify

57851F

Modify the value as required, using the ↑ or ↓ scroll key and press the Enter key to confirm.

**Note:** Running hours can be modified in steps of 100 hours, real time hours can be modified in steps of 1 hour.

### Next Service

Next Service (1)		
Level (2)	Running (3) Hours	Actual (4)
		0
A	500	

84003D

Text on image

(1)	Next service	(3)	Running hours
(2)	Level	(4)	Actual

In the example above, the A Service level is programmed at 500 running hours, of which 0 hours have passed.

### History

The History screen shows a list of all service actions done in the past, sorted by date. The date at the top is the most recent service action. To see the details of a completed service action (e.g. Service level, Running hours or Real time hours), use the Scroll keys to select the desired action and press the Enter key.

## 3.13 Setpoint menu

### Menu icon, Setpoint



### Function

It is possible to program 2 different pressure bands. This menu is also used to select the active pressure band.

### Procedure

Starting from the [Main screen](#),

- Move the cursor to the action button Menu and press the Enter key. Following screen appears:

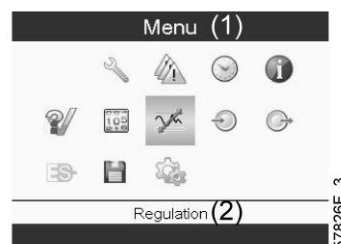

Text on image

(1)	Menu	(2)	Regulation
-----	------	-----	------------

- Using the Scroll keys, move the cursor to the Setpoint icon (see above, section Menu icon)
- Press the Enter key. Following screen appears:



Text on image

(1)	Regulation	(4)	Pressure band 2 High
(2)	Pressure band 1 High	(5)	Pressure band 2 Low
(3)	Pressure band 1 Low	(6)	Modify

- The screen shows the actual stopping and starting pressure settings for both pressure bands. To modify the settings, move the cursor to the action button Modify and press the Enter key. Following screen appears:



- The first line of the screen is highlighted. Use the Scroll keys to highlight the setting to be modified and press the Enter key. Following screen appears:

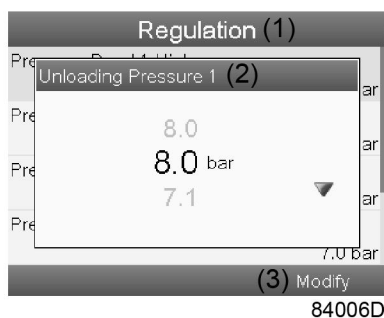

Text on image

(1)	Regulation	(2)	Stopping pressure
-----	------------	-----	-------------------



- The upper and lower limit of the setting is shown in grey, the actual setting is shown in black. Use the ↑ or ↓ key of the Scroll keys to modify the settings as required and press the Enter key to accept.

If necessary, change the other settings as required in the same way as described above.

### 3.14 Event history menu

#### Menu icon, Event History



#### Function

To call up the last shutdown and last emergency stop data.

#### Procedure

Starting from the [Main screen](#),

- Using the Scroll keys, move the cursor to the action button Menu and press the Enter key. Following screen appears:

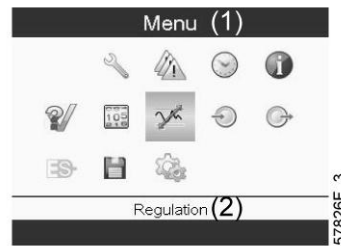

Text on image

(1)	Menu	(2)	Regulation
-----	------	-----	------------

- Using the Scroll keys, move the cursor to the Event History icon (see above).
- Press the Enter key. The list of last shutdown and emergency stop cases is shown.



*Example of Event History screen*

- Scroll through the items to select the desired shutdown or emergency stop event.
- Press the Enter key to find the date, time and other data reflecting the status of the compressor when that shutdown or emergency stop occurred.

### 3.15 General settings menu

#### Menu icon, Settings



#### Function

To display and modify a number of settings.

#### Procedure

Starting from the [Main screen](#),

- Move the cursor to the action button Menu and press the Enter key. Following screen appears:

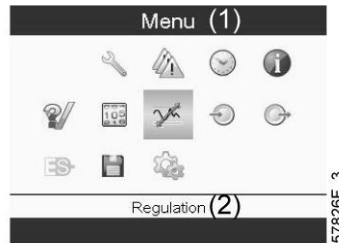

#### Text on image

(1)	Menu	(2)	Regulation
-----	------	-----	------------

- Using the Scroll keys, move the cursor to the Settings icon (see above)
- Press the Enter key. Following screen appears:



This screen shows again a number of icons. By default, the User Password icon is selected. The status bar shows the description that corresponds with the selected icon. Each icon covers one or more items , such as

- Access level
- Elements
- Dryer
- Fan
- Filter(s)
- Motor/Starter
- General
- Automatic restart after voltage failure
- Network
- Regulation

- Remote

For adapting certain parameters, a password may be necessary.

Example: Selecting the General Settings icon gives the possibility to change e.g. the language, the date, the date format, etc.:

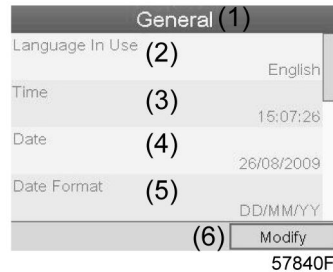

Text on image

(1)	General	(4)	Date
(2)	Language In Use	(5)	Date Format
(3)	Time	(6)	Modify

- To modify, select the Modify button using the Scroll keys and press the Enter key.
- A screen similar to the one above is shown, the first item (Language) is highlighted. Use the ↓ key of the Scroll keys to select the setting to be modified and press the Enter key.
- A pop up screen appears. Use the ↑ or ↓ key to select the required value and press the Enter key to confirm.

### 3.16 Info menu

#### Menu icon, Info



#### Function

Shows the Atlas Copco internet address.

#### Procedure

Starting from the [Main screen](#),

- Move the cursor to the action button Menu and press the Enter key. Following screen appears:

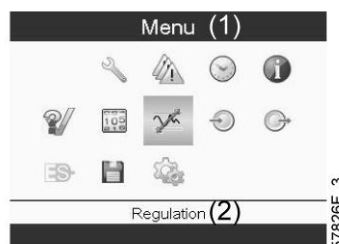

Text on image

(1)	Menu	(2)	Regulation
-----	------	-----	------------

- Using the Scroll keys, move the cursor to the Info icon (see above, section Menu icon).
- Press the Enter key. The internet address appears on the screen.

### 3.17 Week timer menu

#### Menu icon, Week timer



#### Function

- To program time based start/stop commands for the compressor.
- To program time based changeover commands for the net pressure band.
- Four different week schemes can be programmed.
- A week cycle can be programmed, a week cycle is a sequence of 10 weeks. For each week in the cycle, one of the four programmed week schemes can be chosen.



**Important remark:**

You can select different timers on one day.(up to 8 actions). It is however not possible to program 2 actions at the same time. The solution: leave at least 1 minute in between 2 actions.

Example: Start Compressor: 5.00 AM, Pressure Setpoint 2: 5.01 AM (or later).

#### Procedure

Starting from the [Main screen](#),

- Move the cursor to the action button Menu and press the Enter key. Use the Scroll buttons to select the Timer icon.

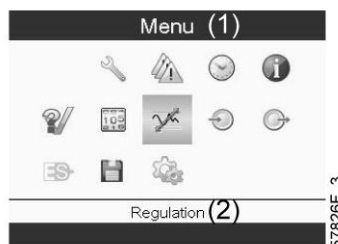

Text on image

(1)	Menu	(2)	Regulation
-----	------	-----	------------

- Press the Enter key on the controller. Following screen appears:

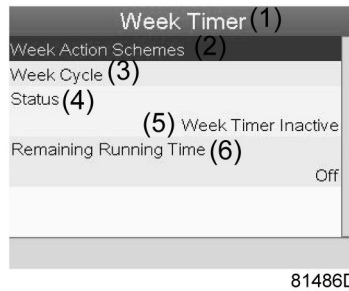

Text on image

(1)	Week Timer	(4)	Status
(2)	Week Action Schemes	(5)	Week Timer Inactive
(3)	Week Cycle	(6)	Remaining Running Time

The first item in this list is highlighted. Select the item to be adapted and press the Enter key on the controller to modify.

**Programming week schemes**

- Select Week action schemes and press Enter. A new window opens. The first item in the list is highlighted in red. Press the Enter key on the controller to modify Week Action Scheme 1.

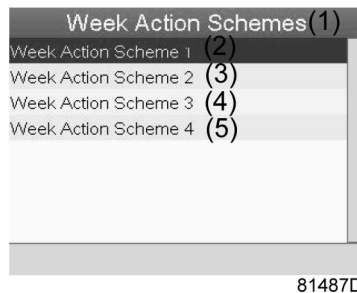

Text on image

(1)	Week Action Schemes	(4)	Week Action Scheme 3
(2)	Week Action Scheme 1	(5)	Week Action Scheme 4
(3)	Week Action Scheme 2		

- A weekly list is shown. Monday is automatically selected and highlighted in red. Press the Enter key on the controller to set an action for this day.

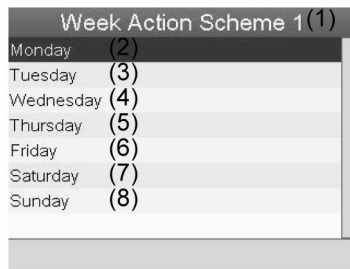

81488D

Text on image

(1)	Week Action Scheme 1	(5)	Thursday
(2)	Monday	(6)	Friday
(3)	Tuesday	(7)	Saturday
(4)	Wednesday	(8)	Sunday

- A new window opens. The Modify action button is selected. Press the enter button on the controller to create an action.

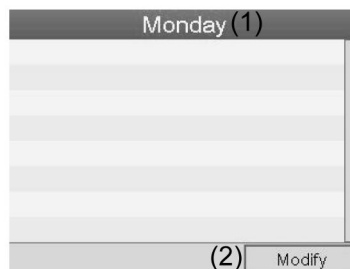

81489D

Text on image

(1)	Monday	(2)	Modify
-----	--------	-----	--------

- A new popup window opens. Select an action from this list by using the Scroll keys on the controller. When ready press the Enter key to confirm.

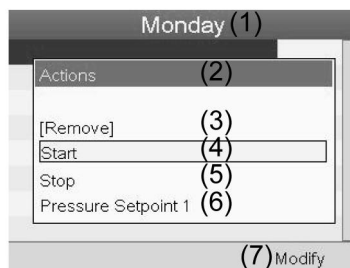

81490D

Text on image

(1)	Monday	(5)	Stop
(2)	Actions	(6)	Pressure Setpoint 1
(3)	Remove	(7)	Modify
(4)	Start		

- A new window opens. The action is now visible in the first day of the week.

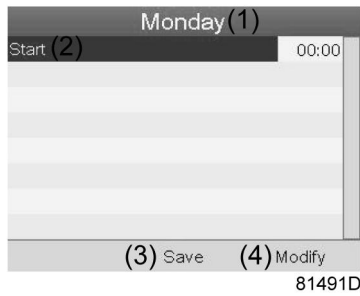

Text on image

(1)	Monday	(3)	Save
(2)	Start	(4)	Modify

- To adjust the time, use the Scroll keys on the controller and press the Enter key to confirm.

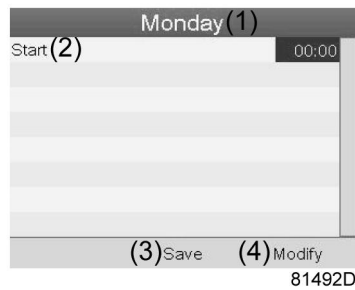

- A new pop up window opens. Use the ↑ or ↓ key of Scroll keys to modify the values of the hours. Use the ← or → Scroll keys to go to the minutes.

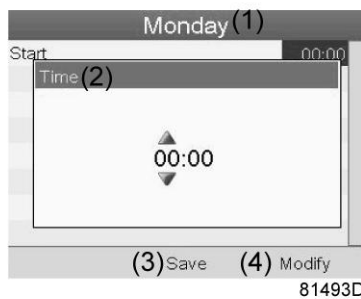

Text on image

(1)	Monday	(3)	Save
(2)	Time	(4)	Modify

- Press the Escape key on the controller. The action button Modify is selected. Use the Scroll keys to select the action Save.

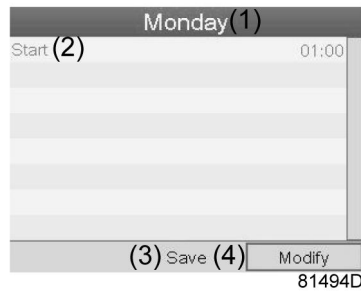

81494D

Text on image

(1)	Monday	(3)	Save
(2)	Start	(4)	Modify

- A new pop-up window opens. Use the Scroll keys on the controller to select the correct actions. Press the Enter key to confirm.

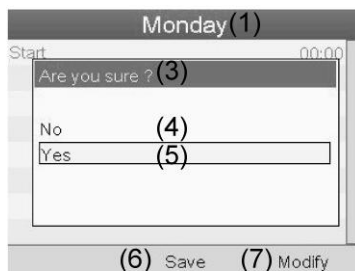

81495D

Text on image

(1)	Monday	(5)	Yes
(3)	Are you sure?	(6)	Save
(4)	No	(7)	Modify

Press the Escape key to leave this window.

- The action is shown below the day the action is planned.



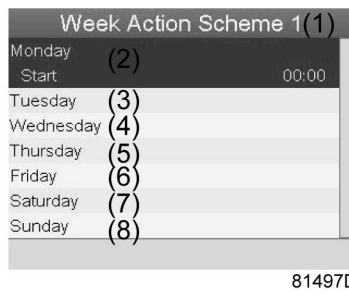

Text on image

(1)	Week Action Scheme 1	(5)	Thursday
(2)	Monday - Start	(6)	Friday
(3)	Tuesday	(7)	Saturday
(4)	Wednesday	(8)	Sunday

Press the Escape key on the controller to leave this screen.

### Programming the week cycle

A week cycle is a sequence of 10 weeks. For each week in the cycle, one of the four programmed week schemes can be chosen.

- Select Week Cycle from the main Week Timer menu list.

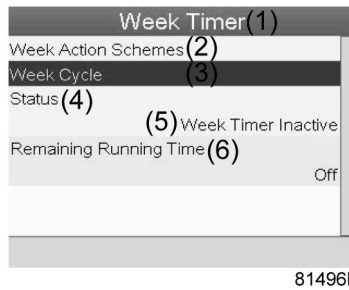

Text on image

(1)	Week Timer	(4)	Status
(2)	Week Action Schemes	(5)	Week Timer Inactive
(3)	Week Cycle	(6)	Remaining Running Time

- A list of 10 weeks is shown.

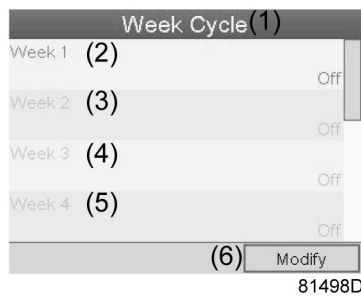

Text on image

(1)	Week Cycle	(4)	Week 3
(2)	Week 1	(5)	Week 4
(3)	Week 2	(6)	Modify

Press the Enter key twice to modify the first week.

- A new window opens. Select the action, example: Week Action Scheme 1

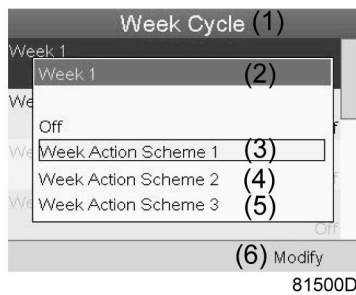

Text on image

(1)	Week Cycle	(4)	Week Action Scheme 2
(2)	Week 1	(5)	Week Action Scheme 3
(3)	Week Action Scheme 1	(6)	Modify

- Check the status of the Week Timer

Use the Escape key on the controller to go back to the main Week Timer menu. Select the status of the Week Timer.



Text on image

(1)	Week Timer	(4)	Status
(2)	Week Action Schemes	(5)	Week Timer Inactive
(3)	Week Cycle	(6)	Remaining Running Time

- A new window opens. Select Week 1 to set the Week Timer active.

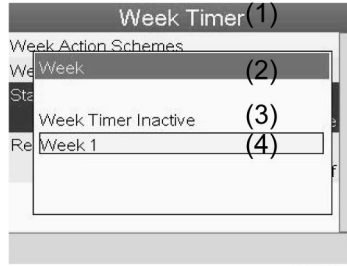

81502D

Text on image

(1)	Week Timer	(3)	Week Timer Inactive
(2)	Week	(4)	Week 1

- Press the Escape key on the controller to leave this window. The status shows that week 1 is active.

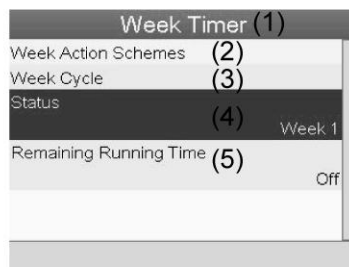

81503D

Text on image

(1)	Week Timer	(4)	Status
(2)	Week Action Schemes	(5)	Remaining Running Time
(3)	Week Cycle		

- Press the Escape key on the controller to go to the main Week Timer menu. Select Remaining Running Time from the list and press the Enter key on the controller to Modify.

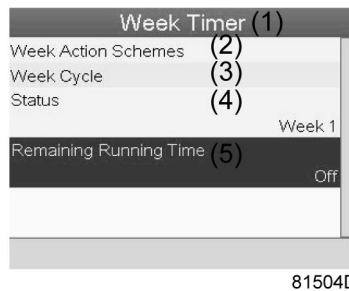

- This timer is used when the week timer is set and for certain reasons the compressor must continue working, for example, 1 hour, it can be set in this screen. This timer is prior to the Week Timer action.

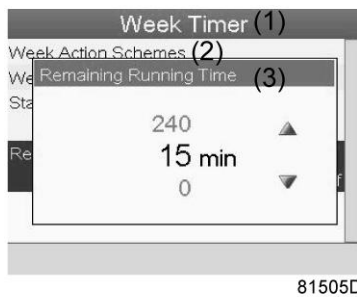

Text on image

(1)	Week Timer	(3)	Remaining Running Time
(2)	Week Action Schemes		

### 3.18 Test menu

Menu icon, Test



or



Function

- To carry out a display test, i.e. to check whether the display and LED's are still intact.

Procedure

Starting from the [Main screen](#),

- Move the cursor to the action button Menu and press the Enter key (2). Following screen appears:

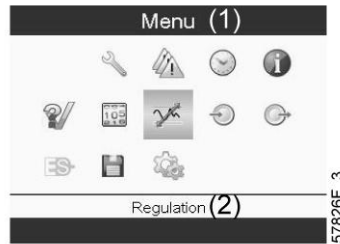

- Using the scroll keys, move the cursor to the test icon (see above)
- Press the Enter key, following screen appears:

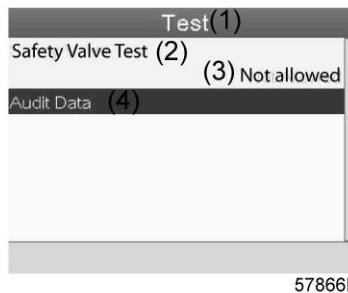

Text on image

(1)	Test	(3)	Not allowed
(2)	Safety Valve Test	(4)	Audit Data

- The safety valve test can only be performed by authorized personnel and is protected by a security code.
- Select the item display test and press the enter key. A screen is shown to inspect the display, at the same time all LED's are lit.

### 3.19 User password menu

#### Menu icon, Password



#### Function

If the password option is activated, it is impossible for not authorized persons to modify any setting.

#### Procedure

Starting from the [Main screen](#),

- Move the cursor to the action button Menu and press the Enter key. Following screen appears:

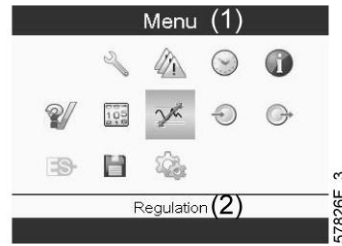

Text on image

(1)	Menu	(2)	Regulation
-----	------	-----	------------

- Using the Scroll keys, select the Settings icon (see section [General settings menu](#)).
- Press the Enter key. Following screen appears:



- Move the cursor to the Password icon (see above, section Menu icon)
- Select Modify, using the Scroll keys and press the Enter key. Next, modify the password as required.

### 3.20 Web server

The controller has a built-in web server that allows direct connection to the company network or to a dedicated PC via a local area network (LAN). This allows to consult certain data and settings via a PC instead of on the display of the controller.

#### Getting started

	<p>If the compressor is equipped with a <b>SMARTBOX</b>, the network connection of the Elektronikon is already in use. To allow the web server functionality, the network cable that is connected to the <b>SMARTBOX</b> should be unplugged and replaced by the cable of the company network.</p> <p>If both the web server functionality and <b>SMARTBOX</b> are required, please contact your local Atlas Copco Customer Centre for support.</p>
---	---

Make sure you are logged in as administrator.

- Use the internal network card from your computer or a USB to LAN adapter (see picture below).



USB to LAN adapter

- Use a UTP cable (CAT 5e) to connect to the controller (see picture below).



### Configuration of the network card (in Windows)

- Go to My Network places (1).

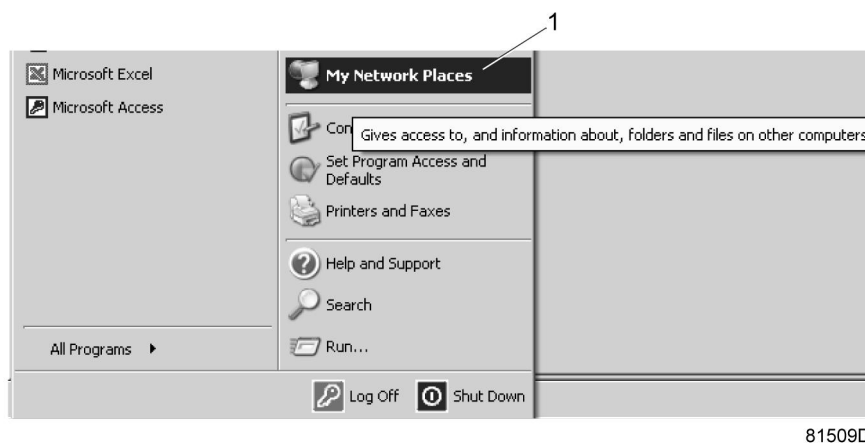

- Click on View Network connections (1).



- Select the Local Area connection (1), which is connected to the controller.

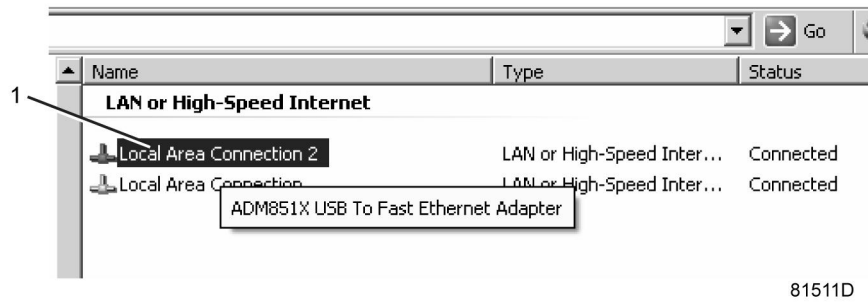

- Click with the right button and select properties (1).

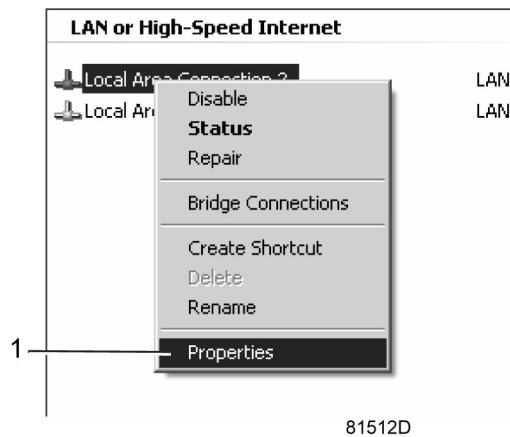

- Use the check box Internet Protocol (TCP/IP) (1) (see picture). To avoid conflicts, uncheck other properties if they are checked. After selecting TCP/IP, click on the Properties button (2) to change the settings.



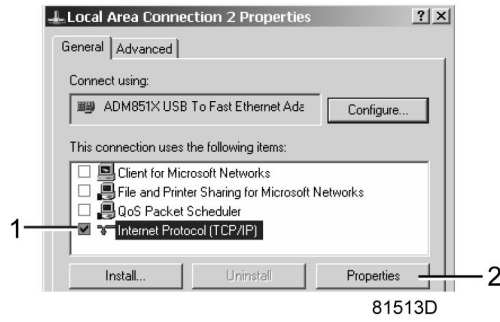

- Use the following settings:
    - IP Address 192.168.100.200
    - Subnetmask 255.255.255.0
- Click OK and close network connections.

### Configuration of the web server

#### Configure the web interface (for Internet Explorer)

- Open Internet Explorer and click on Tools - Internet options (2).

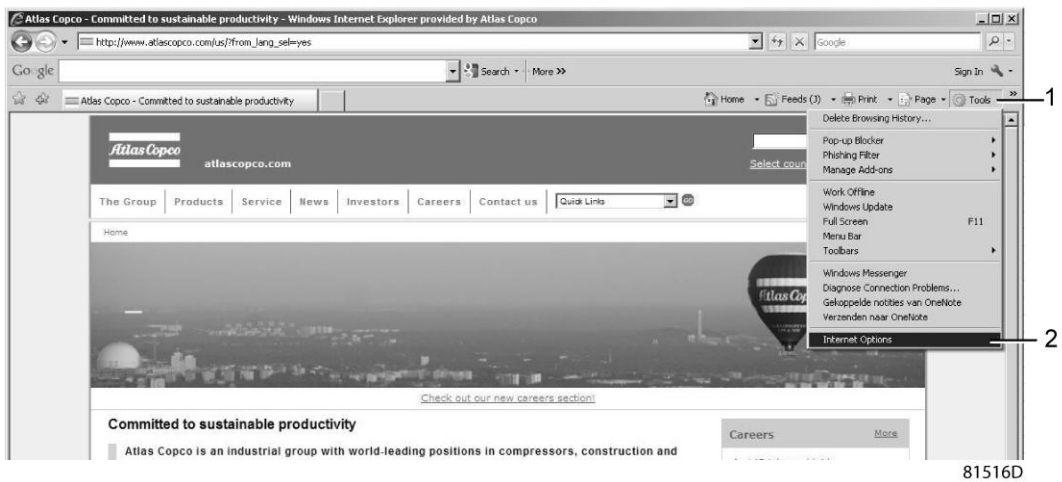

- Click on the Connections tab (1) and then click on the LAN settings button (2).

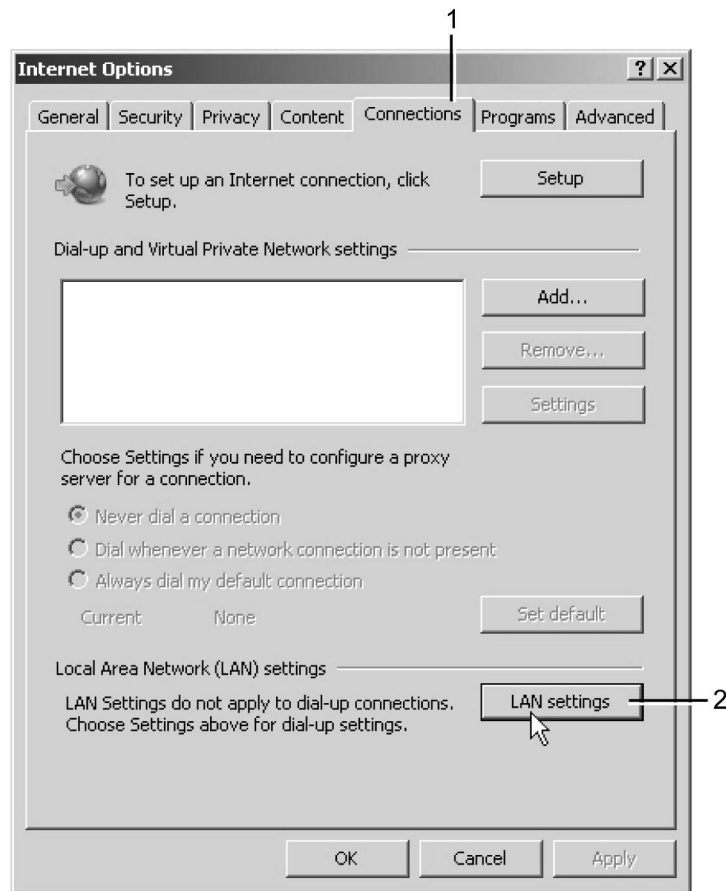

81517D

- In the Proxy server Group box, click on the Advanced button (1).

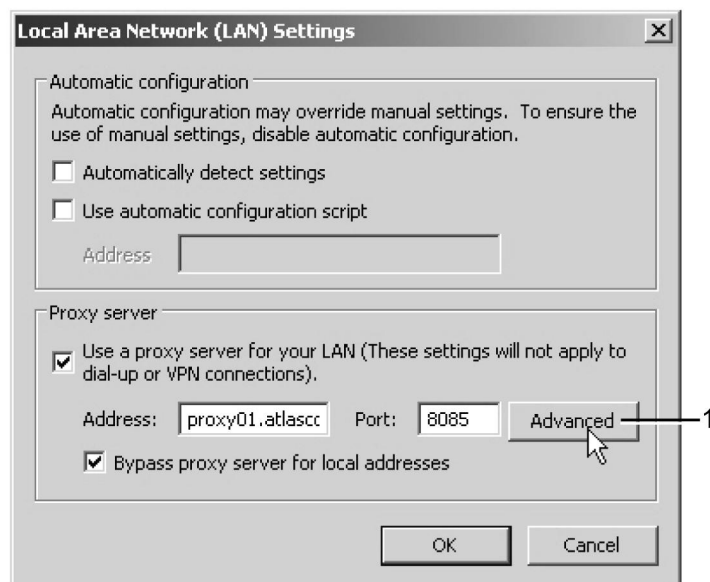

81518D

- In the Exceptions Group box, enter the IP address of your controller. Multiple IP addresses can be given but they must be separated with semicolons (;).

Example: Suppose that you already added two IP addresses (192.168.100.1 and 192.168.100.2). Now you add 192.168.100.100 and separate the 3 IP addresses by putting semicolons between them (1) (see picture).

Click OK (2) to close the window.

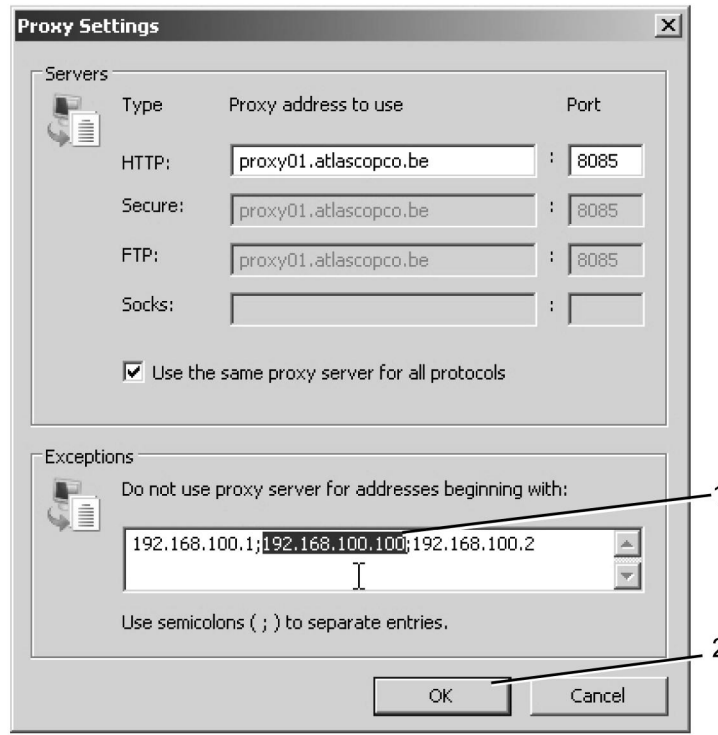

81519D

### Viewing the controller data

	All screen shots are indicative. The number of displayed fields depends on the selected options.
--	--

- Open your browser and type the IP address of the controller you want to view in your browser (in this example <http://192.168.100.100>). The interface opens:

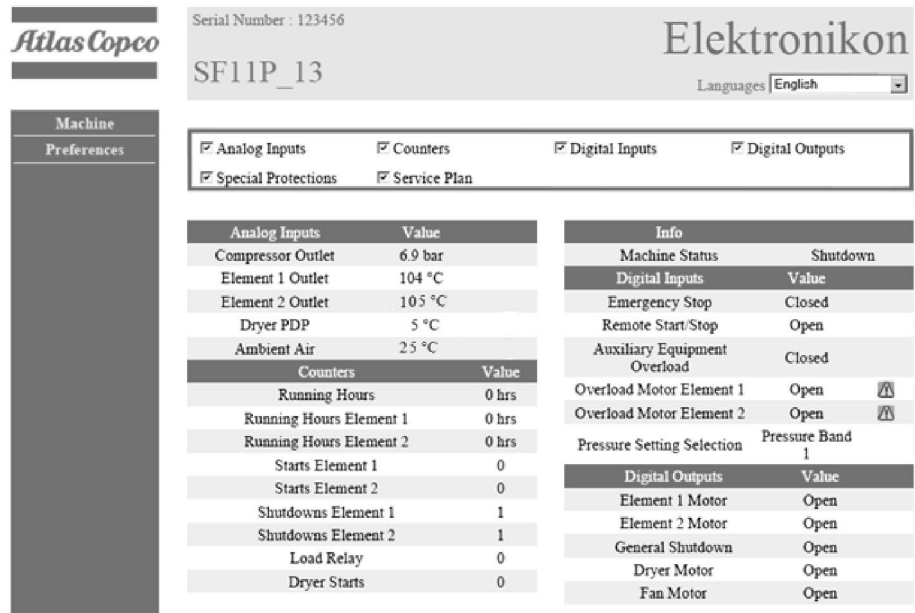

84008D

Screen shot (typical)

### Navigation and options

- The banner shows the compressor type and the language selector. In this example, three languages are available on the controller.



81521D

### Compressor settings

All compressor settings can be displayed or hidden. Put a check mark in front of each point of interest and it will be displayed. Only the machine status is fixed and can not be removed from the main screen.

#### Analog inputs

Lists all current analog input values. The measurement units can be changed in the preference button from the navigation menu.

<input checked="" type="checkbox"/> Analog Inputs	Analog Inputs	Value
	Compressor Outlet	6.9 bar
	Element 1 Outlet	104 °C
	Element 2 Outlet	96 °C
	Dryer PDP	15 °C
	Ambient Air	16 °C

84009D

### Counters

Lists all current counter values from controller and compressor.

<input checked="" type="checkbox"/> Counters	Counters	Value
	Running Hours	0 hrs
	Running Hours Element 1	0 hrs
	Running Hours Element 2	0 hrs
	Starts Element 1	0
	Starts Element 2	0
	Shutdowns Element 1	1
	Shutdowns Element 2	1
	Load Relay	0
	Dryer Starts	0
	Fan Starts	0
	Module Hours	6 hrs

84010D

### Info status

Machine status is always shown on the web interface.

Info	
Machine Status	Shutdown

84011D

### Digital inputs

Lists all Digital inputs and their status.

<input checked="" type="checkbox"/> Digital Inputs	Digital Inputs	Value
	Emergency Stop	Closed
	Remote Start/Stop	Open
	Auxiliary Equipment Overload	Closed
	Overload Motor Element 1	Open
	Overload Motor Element 2	Open
	Pressure Setting Selection	Pressure Band 1

84012D

**Digital outputs**

Lists all Digital outputs and their status.

<input checked="" type="checkbox"/> Digital Outputs	Digital Outputs	Value
	Element 1 Motor	Open
	Element 2 Motor	Open
	General Shutdown	Open
	Dryer Motor	Open
	Fan Motor	Open
	General Warning	Open
	Cabinet Fan	Open

84013D

**Special protections**

Lists all special protections of the compressor.

<input checked="" type="checkbox"/> Special Protections	Special Protections	
	Dryer Dewpoint Protection	OK
	No Valid Pressure Control	OK
	Dryer Freeze Protection	OK
	Expansion Module Communication	OK
	Warnings Element 1	OK
	Warnings Element 2	OK

84014D

**Service plan**

Displays all levels of the service plan and their status. This screen shot underneath only shows the running hours. It is also possible to show the current status of the service interval.

<input checked="" type="checkbox"/> Service Plan	Service Plan	Level
	500	A
	2190	A
	2500	B
	8760	B
	5000	C
	17520	C
	5000	D
	17520	D
	10000	E
	35040	E
	10000	F
	35040	F

84015D

### 3.21 Programmable settings

#### Compressors without built-in refrigeration dryer

		Minimum setting	Factory setting	Maximum setting
Starting pressure				
Starting pressure (8 bar compressors)	bar(e)	4	7	8
Starting pressure (8 bar compressors)	psig	58	101.5	116
Starting pressure (10 bar compressors)	bar(e)	4	9	10
Starting pressure (10 bar compressors)	psig	58	130.5	145

		Minimum setting	Factory setting	Maximum setting
Stopping pressure				
Stopping pressure (8 bar compressors)	bar(e)	4	8	8
Stopping pressure (8 bar compressors)	psig	58	116	116
Stopping pressure (10 bar compressors)	bar(e)	4	10	10
Stopping pressure (10 bar compressors)	psig	58	145	145

**Compressors with built-in refrigeration dryer**

		<b>Minimum setting</b>	<b>Factory setting</b>	<b>Maximum setting</b>
Starting pressure				
Starting pressure (8 bar compressors)	bar(e)	4	6.8	7.8
Starting pressure (8 bar compressors)	psig	58	98.6	113.1
Starting pressure (10 bar compressors)	bar(e)	4	8.8	9.8
Starting pressure (10 bar compressors)	psig	58	127.6	142.1

		<b>Minimum setting</b>	<b>Factory setting</b>	<b>Maximum setting</b>
Stopping pressure				
Stopping pressure (8 bar compressors)	bar(e)	4	7.8	7.8
Stopping pressure (8 bar compressors)	psig	58	113.1	113.1
Stopping pressure (10 bar compressors)	bar(e)	4	9.8	9.8
Stopping pressure (10 bar compressors)	psig	58	142.1	142.1

**Parameters**

		<b>Minimum setting</b>	<b>Factory setting</b>	<b>Maximum setting</b>
Allowed number of motor starts per day		72	720	720
Power recovery time (Automatic restart function)	s	60	60	3600
Restart delay	s	0	0	1200
Communication time-out	s	10	30	60

**Protections**

		<b>Minimum setting</b>	<b>Factory setting</b>	<b>Maximum setting</b>
Ambient temperature warning level	°C	0	40	40
Ambient temperature warning level	°F	32	104	104
Ambient temperature shutdown level	°C	0	45	45
Ambient temperature shutdown level	°F	32	113	113

**Service plan**

The built-in service timers will give a Service warning message after their respective pre-programmed time interval has elapsed.

Also see section Preventive maintenance schedule.

Consult Atlas Copco if a timer setting has to be changed. The intervals must not exceed the nominal intervals and must coincide logically. See section [Service menu](#).



## Terminology

Term	Explanation
ARAVF	Automatic Restart After Voltage Failure. See section <a href="#">General</a> .
Power recovery time	Is the period within which the voltage must be restored to have an automatic restart. Is accessible if the automatic restart is activated. To activate the automatic restart function, consult your supplier.
Restart delay	This parameter allows to programme that not all compressors are restarted at the same time after a power failure (ARAVF active).
Delay at shut-down signal	Is the time for which the signal must exist before the compressor is shut down. If it is required to program this setting to another value, consult your supplier.
Minimum stop time	Once the compressor has automatically stopped, it will remain stopped for the minimum stop time, whatever happens with the net air pressure. Consult your supplier if a setting lower than 20 seconds is required.
Starting / stopping pressure	The regulator does not accept inconsistent settings, e.g. if the stopping pressure is programmed at 7.0 bar(e) (101 psi(g)), the maximum limit for the starting pressure changes to 6.9 bar(e) (100 psi(g)). The recommended minimum pressure difference between starting and stopping is 0.6 bar (9 psi(g)).

## 4 Installation guidelines

### 4.1 Dimension drawing

The dimension drawings can be found on the DVD or the USB, supplied with the compressor.

Model	Dimension drawing number
SF 8+, SF 11 + Low canopy metric	9820 7462 00-01
SF 8+, SF 11 + Low canopy imperial	9820 7462 00-02
SF 8+, SF 11 + High canopy metric	9820 7502 00-01
SF 8+, SF 11 + High canopy imperial	9820 7502 00-02

Hereby a list of commonly used terms with their translation:

Text on drawings	Translation or Explanation
COOLING AIR OUTLET OF AFTERCOOLER AND DRYER	Cooling air outlet of aftercooler and dryer
COOLING AIR OUTLET OF COMPRESSOR	Cooling air outlet of the compressor
AMBIENT SENSOR	Sensor to measure the ambient temperature
CABINET VENTILATION	Ventilation outlet opening for cabinet
COMPRESSED AIR OUTLET	Compressed air outlet
ELECTRIC CABLE PASSAGE / POWER SUPPLY CABLE	Opening for power supply cable
MANUAL DRAIN	Manual drain valve
AUTOMATIC DRAIN	Automatic drain outlet
CENTER OF GRAVITY	Location of center of gravity
COOLING AIR INLET OF AFTERCOOLER AND DRYER	Cooling air inlet of aftercooler and dryer
COOLING AIR INLET OF COMPRESSOR AND CABINET	Cooling air inlet for compressor and cabinet
COMPRESSOR MOUNTING HOLES	Location of anchoring points to fixate the compressor
CENTER OF GRAVITY DIMENSIONS AND MASS	Location of the center of gravity and mass

### → 4.2 Installation proposal

#### Outdoor/altitude operation



If the compressor is installed outdoors or if the air inlet temperature can be below 0 °C (32 °F), precautions must be taken. In this case, and also if operating at high altitude, consult Atlas Copco.

### Installation proposal

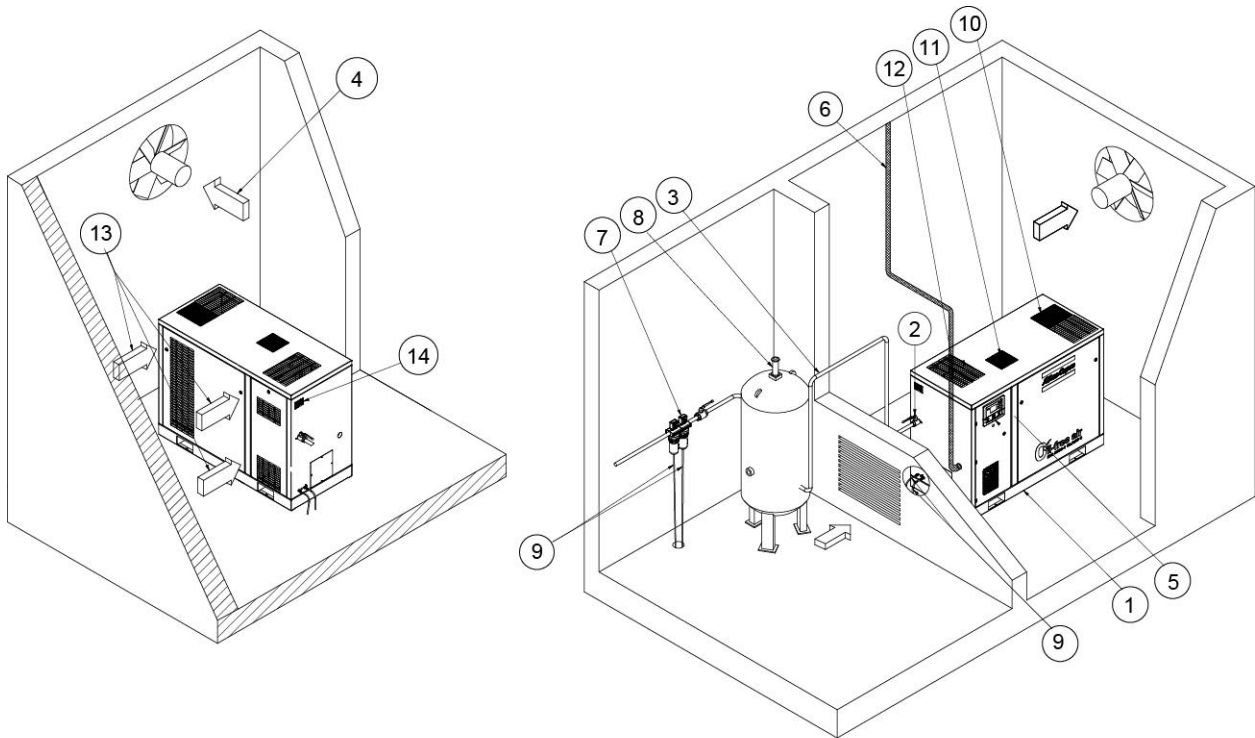

Minimum free area to be reserved for the compressor installation. (1)

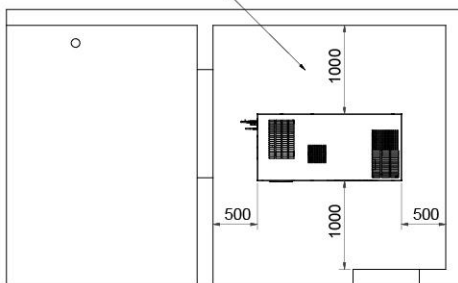

VENTILATION PROPOSALS (2)

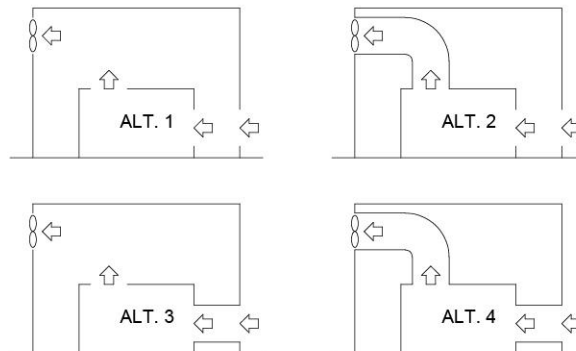

84056D

9820 7469 00 Ed. 1

Reference	Description
1	Minimum free area to be reserved for the compressor installation
2	Ventilation proposals

### Procedure

1. Install the compressor on a level floor, suitable for taking the weight of the compressor in a frost free and preferably low dust location.
2. Compressed air outlet valve.
3. Delivery pipe.

The pressure drop over the air delivery pipe can be calculated as follows:

$$\Delta p = (L \times 450 \times Q_c^{1.85}) / (d^5 \times P), \text{ with}$$

d = inner diameter of the pipe in mm

$\Delta p$  = pressure drop in bar (recommended maximum: 0.1 bar (1.5 psi))

L = length of the pipe in m

P = absolute pressure at the compressor outlet in bar

$Q_c$  = Free air delivery of the compressor in l/s

4. Ventilation: The inlet grid(s) and ventilation fan should be installed in such a way that any recirculation of hot cooling air to the inlet gratings of the compressor/dryer is avoided. The air velocity to the grid(s) has to be limited to 5 m/s (16.5 ft/s). Maximum allowable pressure drop over cooling air ducts is 50 Pa (0.12 in WC). When 50 Pa is exceeded, a ventilation fan is needed at the outlet of the cooling air ducts. The maximum air temperature at the compressor intake opening is 40° C (104 °F), the minimum is 0° C (32 °F).

Alternative 1 and 3: The required ventilation to limit the compressor room temperature can be calculated from :

$$Q_v = 0,92 N / \Delta t$$

with

$Q_v$  = required ventilation capacity in m<sup>3</sup>/s

N = nominal motor power of the compressor in kW

$\Delta t$  = temperature increase in the compressor room in °C

Alternative 2 and 4: The fan capacity should match the compressor fan capacity at a pressure head equal to the pressure drop caused by the cooling air ducts.

5. Control cubicle with monitoring panel.
6. Mains cable entry.
7. **Optional filters can be installed in the pressure line downstream the air outlet valve, e.g.:**
- A DD filter for general purpose filtration. The filter traps solid particles down to 1 micron.
  - A PD filter for filtration down to 0.01 micron. A PD filter must always be installed downstream a DD filter.
- It is recommended to provide bypass pipes and valves across the filters in order to isolate the filters during maintenance without disturbing the compressed air delivery.
8. Safety valve.
9. The drain pipes to the drain must not dip into the water.
10. Compressor cooling air outlet.
11. Ventilation outlet
12. Aftercooler and dryer cooling air outlet.
13. Data plate.

## 4.3 Electrical connections

### Attention



The electrical installation must correspond to the local codes. The mains supply and earthing lines must be of suitable size.

The installation must be earthed and protected by fuses in each phase. An isolating switch should be installed near the compressor.

**Make sure that this switch is open to isolate the compressor from the mains before carrying out any connection.**

To preserve the protection degree of the electric cubicle and to protect its components from dust from the environment, it is mandatory to use a proper cable gland when connecting the supply cable to the compressor.

### Supply cable

Consult section [Electric cable size and fuses](#) for the section of the power supply cable.

Connect the supply cable to terminals L1, L2 and L3 of terminal strip (1X0), connect the neutral conductor to terminal (N) (if applicable) and the earthing conductor to the earthing bolt (1X3).

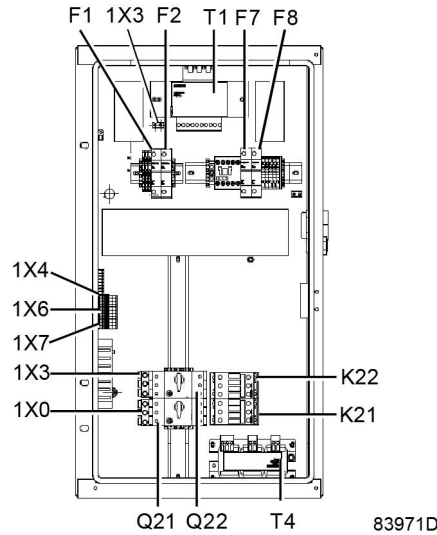

## 4.4 Pictographs

### Pictographs

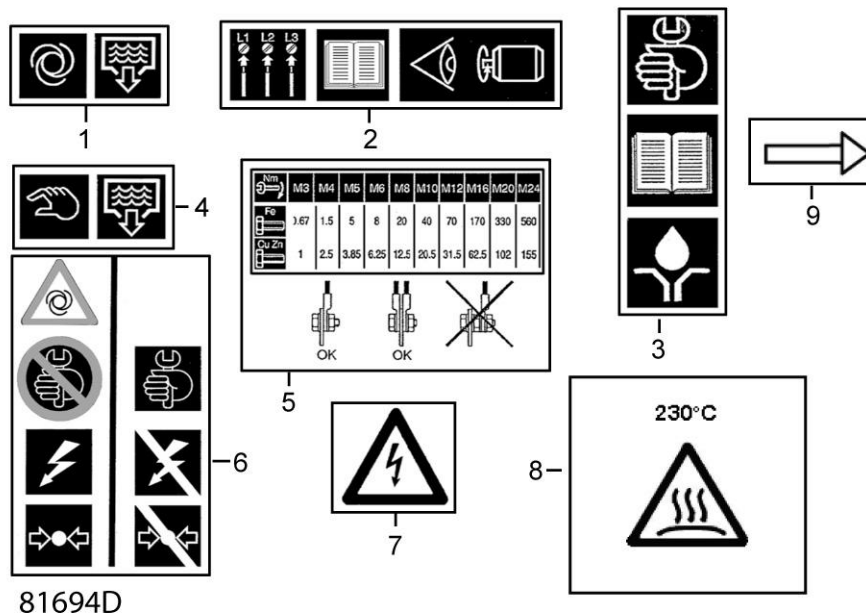

Pictographs

Reference	Designation
1	Automatic condensate drain

<b>Reference</b>	<b>Designation</b>
2	Warning: before connecting compressor electrically, consult Instruction book for motor rotation direction
3	Consult the specific instructions before greasing
4	Manual condensate drain
5	Torques for steel (Fe) or brass (CuZn) bolts
6	Switch off the voltage and depressurize the compressor before maintenance or repair
7	Warning: voltage
8	Warning: hot surface
9	Rotation direction of fan

## 5 Operating instructions

### 5.1 Initial start-up

#### Safety



The operator must apply all relevant [Safety precautions](#).

#### Initial start-up procedure

1. Remove the red painted transport brackets (2).

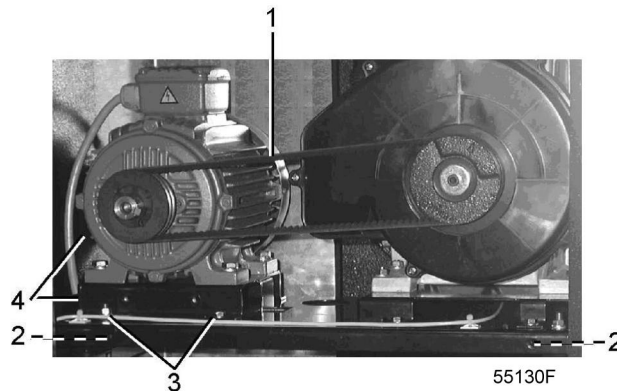

2. Check the settings of the overload relays. See section [Electric cable size and fuses](#).
3. Connect the compressor electrically. See section [Electrical connections](#).
4. Close the condensate drain valve. See chapter *Condensate management* in section [Flow diagram](#).
5. Switch on the voltage. Start and stop the compressor. On 3-phase compressors, check for correct direction of rotation (direction arrows are provided on the motors). If the rotation direction is wrong, switch off the voltage and reverse two incoming electric lines.

### 5.2 Starting

#### Procedure

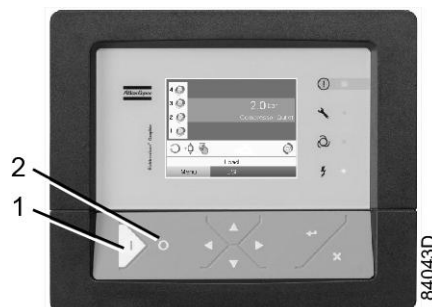

1. Open the air outlet valve. See section [Introduction](#) for its location.
2. Switch on the voltage.

3. Close all manual condensate drain valves.
4. Press the start button (1). The compressor starts running and automatic operation LED lights up.
5. The regulator will automatically stop and start the compressor modules in function of the air pressure.
6. On compressors with integrated dryer, the nominal pressure dew point will be reached after a few minutes.



The number of starts is limited to 30 starts per hour. See also section [Programmable settings](#).

## 5.3 During operation

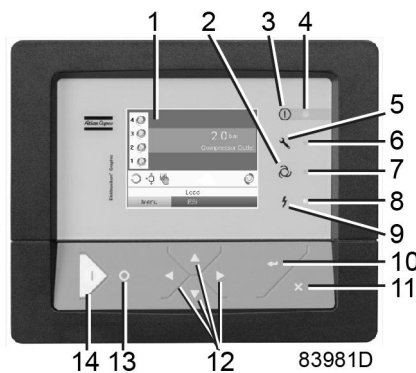

Control panel

### Procedure

1. If the automatic operation LED (3) is alight, the regulator is automatically controlling the compressor modules (starting/stopping).
2. Check the readings on the display (1). In case of a warning or shutdown condition, see section [Problem solving](#) or [Event history menu](#).
3. Check that condensate is discharged automatically from the condensate drain outlet during operation.



The dew point will deviate from nominal when the nominal conditions are exceeded. If the dew point remains too high or unstable, consult section [Problem solving](#).



## 5.4 Stopping

### Procedure

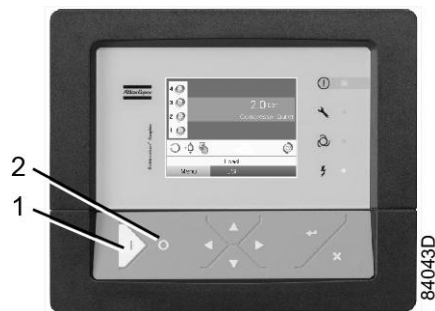

1. Press the stop button (2).
2. Close the air outlet valve. See section [Introduction](#).
3. Switch off the voltage.
4. Open the manual condensate drain valve.

## 5.5 Taking out of operation

### Procedure

1. Stop the compressor and close the air outlet valve.
2. Switch off the voltage and disconnect the compressor from the mains.
3. Depressurize the compressor. Open the condensate drain valve.
4. Shut off and depressurize the part of the air net which connected to the outlet valve. Disconnect the compressor from the air net.
5. Disconnect the condensate piping from the local condensate drain system.

## 6 Maintenance

### 6.1 Preventive maintenance schedule

#### Warning

	<p><b>Before carrying out any maintenance, repair work or adjustments, proceed as follows:</b></p> <ul style="list-style-type: none"> <li>• Stop the compressor.</li> <li>• Switch off the voltage and open the isolating switch.</li> <li>• Press the emergency stop button (S3).</li> <li>• Close the air outlet valve.</li> <li>• Depressurize the compressor by opening the manual drain valve(s).</li> </ul> <p>The operator must apply all relevant <a href="#">Safety precautions during maintenance or repair</a>.</p>
---	--

#### Warranty - Product Liability

Use only authorized parts. Any damage or malfunction caused by the use of unauthorized parts is not covered by Warranty or Product Liability.

#### General

When servicing, replace all removed gaskets, O-rings and washers.

#### Intervals

The local Customer Centre may overrule the specified maintenance schedule, especially the service intervals, depending on the environmental and operating conditions of the compressor.

	<p><b>The longer interval checks must always include the shorter interval checks.</b></p>
---	---

#### Preventive maintenance schedule

A number of service operations are grouped in plans called Service plans I, A, B or D. See the table below. A message will appear on the controller display when reaching the interval, indicating which Service plans are to be carried out. After servicing, the regulator is to be reset. For detailed information, consult section [Service menu](#).

Period (note 1)	Running hours (note 1)	Service Plan	Operation
Daily	--	--	<ul style="list-style-type: none"> <li>• Check readings on display.</li> <li>• Check if condensate is discharged during operation.</li> <li>• Drain condensate manually (when applicable).</li> <li>• On compressors with integrated dryer: check the dew point.</li> </ul>

Period (note 1)	Running hours (note 1)	Service Plan	Operation
Every 3 months (note 2)	500	--	<ul style="list-style-type: none"> <li>• Check the pressure drop over the (optional) filters .</li> <li>• Inspect the air inlet filters: check for cleanness and damage. Replace a dirty or damaged filter with a new one.</li> <li>• Check the coolers. Clean by air jet if necessary.</li> </ul>
Every 6 months	1000	--	<ul style="list-style-type: none"> <li>• Operate the safety valve.</li> <li>• Clean the compressor.</li> <li>• On compressors with integrated dryer:                             <ul style="list-style-type: none"> <li>• Brush or blow off the finned surface of the condenser.</li> <li>• Inspect and clean the electronic drain:                                     <ul style="list-style-type: none"> <li>• Functioning of the drain can be checked by pushing the TEST button of the drain.</li> <li>• Cleaning of the drain filter can be done by opening the manual drain valve during a few seconds.</li> </ul> </li> </ul> </li> </ul>
Yearly	2500	--	<ul style="list-style-type: none"> <li>• Replace the air inlet filters.</li> <li>• Test the safety valves.</li> <li>• Have temperature protection and motor overload tested.</li> <li>• Check tension and condition of the V-belts.</li> </ul>
Every 2 years	5000	A	<ul style="list-style-type: none"> <li>• Replace V-belt(s).</li> <li>• Replace the check valves.</li> </ul>
Every 2 years	5000	B	<p>8 bar and 116 psi compressors:</p> <ul style="list-style-type: none"> <li>• Clean fan (ref 124 on <a href="#">Flow diagram</a>), fan duct and element cooling fins (see note 2). See section <a href="#">Cleaning cooling fins</a>.</li> <li>• Have orbiting scroll bearing greased (see note 3).</li> </ul>
Every 2 years	5000	B	<p>10 bar and 145 psi compressors:</p> <ul style="list-style-type: none"> <li>• Replace the element outlet pipe and the plastic insert. See section <a href="#">Outlet pipe replacement</a> (3.7 kW elements only).</li> <li>• Clean fan (ref 124 on <a href="#">Flow diagram</a>), fan duct and element cooling fins (see note 2). See section <a href="#">Cleaning cooling fins</a>.</li> <li>• Have orbiting scroll bearing and pin crank bearings greased (see note 3).</li> <li>• Replace tip seals and dust seal.</li> <li>• Replace inlet seal.</li> </ul>
Every 4 years	10000	B	<p>8 bar and 116 psi compressors:</p> <ul style="list-style-type: none"> <li>• Replace the element outlet pipe and the plastic insert. See section <a href="#">Outlet pipe replacement</a> (3.7 kW elements only).</li> <li>• Clean fan (ref 124 on <a href="#">Flow diagram</a>), fan duct and element cooling fins (see note 2). See section <a href="#">Cleaning cooling fins</a>.</li> <li>• Have orbiting scroll bearing and pin crank bearings greased (see note 3).</li> <li>• Replace tip seals and dust seal.</li> <li>• Replace inlet seal.</li> </ul>

**Notes:**

1. Maintenance must be done according the number of running hours **or** according the running period, whichever comes first.
2. More frequently in a dusty environment.
3. **Important note:** Regreasing of the bearings of the compressor element must be done with **special grease**, a **special grease gun** and according a **specific procedure**.  
In high ambient conditions, the bearings must be greased more frequently: for every 5 °C (9 °F) increase above 30 °C (86 °F), the maintenance interval should be reduced with 30 %.  
**Contact your supplier for details.**  
Check more frequently if operating in a dusty atmosphere. Check for cleanness and damage. Replace a dirty or damaged filter by a new one.
4. In extremely dry conditions (relative humidity below 15 %), the tip seals and dust seals need to be replaced more frequently.

## 6.2 Service kits

### Service kits

For overhauling and for preventive maintenance, a wide range of service kits is available. Service kits comprise all parts required for servicing the component and offer the benefits of genuine parts while keeping the maintenance budget low.

Consult the Spare Parts List for part numbers.

## 6.3 Disposal of used material

Used filters or any other used material (e.g. desiccant, lubricants, cleaning rags, machine parts, etc.) must be disposed of in an environmentally friendly and safe manner, and in line with the local recommendations and environmental legislation.

Electronic components are subject to the EU Directive 2012/19/EC for Waste Electrical and Electronic Equipment (WEEE). As such, these parts must not be disposed of at a municipal waste collection point. Refer to local regulations for directions on how to dispose of this product in an environmental friendly manner.

## 7 Adjustments and servicing procedures

### 7.1 Air filter

#### Procedure

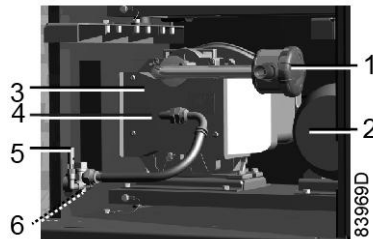

*3.7 kW compressor module*

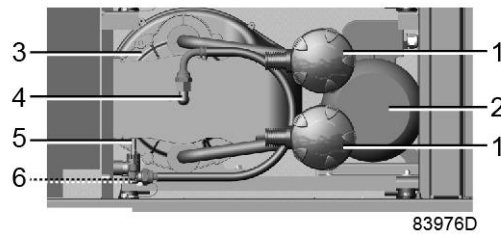

*5.5 kW compressor module*

1. Stop the compressor, close the air outlet valve and switch off the voltage.
2. Remove the filter cover (1) and the filter element. Discard damaged or clogged elements. Clean the cover.
3. Fit the new element and reinstall the filter cover.

### 7.2 Air cooler

#### Cleaning

Keep the cooler clean to maintain cooling efficiency. If necessary, remove any dirt with a fibre brush. Never use a wire brush or metal objects.

Next, clean by air jet in reverse direction of normal flow.

If it is necessary to wash the cooler with a cleansing agent, consult Atlas Copco.

### 7.3 Drive motor

#### Instructions

The motor bearings are greased for life and do not require special attention.

Keep the motor free from dust for optimal cooling.

## 7.4 Safety valve

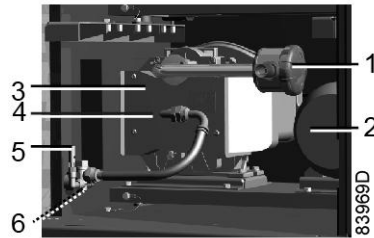

3.7 kW compressor module

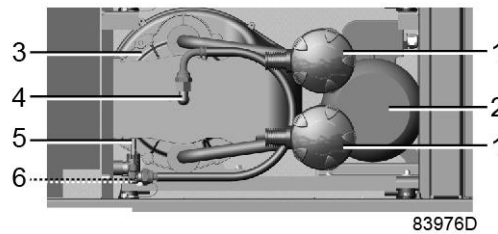

5.5 kW compressor module

### Operating

Operate the safety valve (5) by unscrewing the knurled cap one or two turns. Retighten the cap.

### Testing

The valve can be tested on a separate compressed air line.

If the safety valve does not open at the specified pressure, it must be replaced.



No adjustments are allowed. Never run the compressor without safety valve.

## 7.5 Belt set exchange and tensioning

### Important



The belts must be replaced as a set, even if only one of them seems worn. Use Atlas Copco belts only. The number of the belt set is mentioned in the Parts list.

**Procedure**

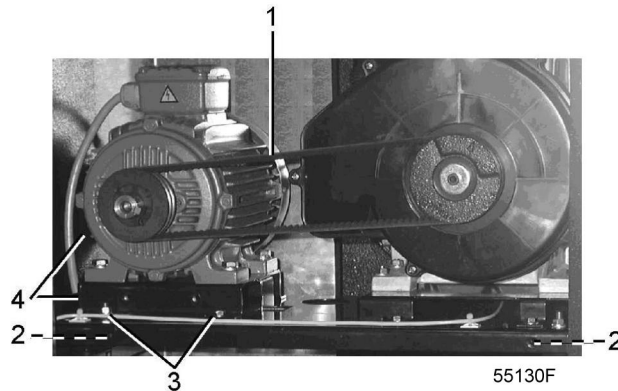

1. Loosen motor hold-down bolts (3).
2. Loosen the belt tension by screwing bolts (4) equally and take off the belts (1).
3. Install new belts.
4. Tension the belts by screwing bolts (4) equally.  
 The tension is correct if the deflection is between 5 mm and 7 mm when exerting a force of 25 N on the belt midway between the pulleys. Make sure that the pulleys remain aligned. The maximum out-of-line is:
  - Maximum parallel out-of-line: 0.5 mm
  - Maximum angular out-of-line: 0.5 degrees
5. Tighten bolts (3).
6. Check the belt tension after the first 500 running hours.

**7.6 Cleaning the compressor element**

	<ul style="list-style-type: none"> <li>• Compressor element cooling channels can be hot when the compressor has just been turned off.</li> <li>• Do not clean the cooling channels with organic solvent since this will damage the surface treatment.</li> </ul>
--	--

The purpose of cleaning the cooling channels of a scroll element is to prevent the cooling channels to silt up and as such reduce the cooling efficiency. A reduced cooling efficiency can lead towards a premature compressor element failure.

Procedure:

1. Stop the compressor and switch off the power.
2. Close the air outlet valve and depressurise the compressor.
3. Remove the fan duct:
  - Unscrew the 3 bolts (1).
  - Remove clip (2) (if applicable).

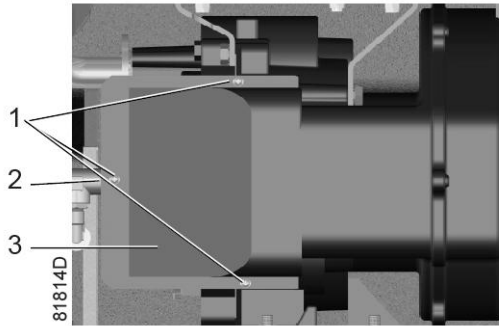

- Remove fan duct (3).
4. Clean cooling channels:
- Remove dust from the cooling channels (1) by means of air jet (see next figure).
  - Clean the fan duct (2).

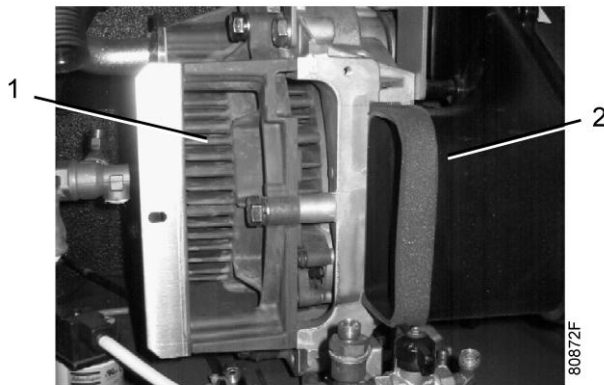

5. Reassemble the fan duct:
- Put the fan duct in place.
  - Fit the 3 bolts and the clip.

The unit is now again ready for use.

## 7.7 Replacement of the outlet pipe

(only applicable to SF 8+)

### Description

The element outlet pipe (1) of the 3.7 kW element contains a plastic insert (3). Due to the heat of the compressed air, the plastic insert can become brittle after time. Therefore it is recommended to replace the outlet pipe together with the insert when that is the case. Both parts are available as a kit (outlet pipe set). See the Spare Parts List for part number.

The outlet pipe set contains two parts:

- The plastic insert (3)
- The metal outlet pipe (1)



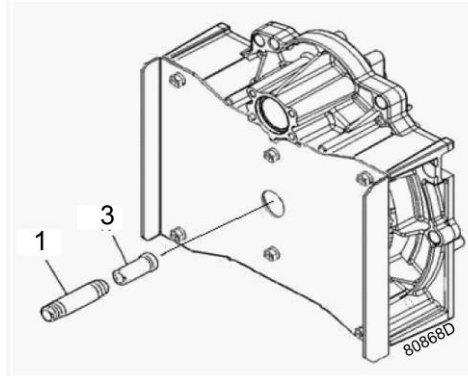

### Replacement procedure

1. Stop the compressor, depressurize and switch off the voltage.
2. Loosen coupling (3) while immobilizing nipple (2) with a wrench.

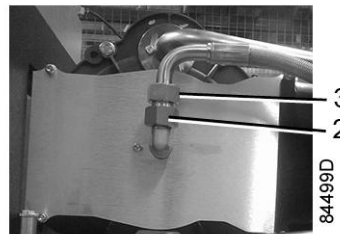

3. Remove the outlet pipe together with the nipple.
4. Fit the elbow and the nipple to the new outlet pipe and tighten. Use only PTFE tape.
5. Fit the plastic insert in place as indicated on the drawing and assemble the outlet pipe with a maximum torque of 5 Nm (3.7 lbf.ft). Maximum one extra turn (360 °) is allowed for positioning of the elbow. Do not end turning counterclockwise in order to avoid leaks. Use only PTFE tape.

**Warning:** If the outlet pipe is tightened too hard, the thread of the element can get damaged or the insert can break, resulting in overheating of the compressor element!

6. Fasten coupling (3) while holding nipple (2) with a wrench.

The outlet pipe of the 5.5 kW element does not contain an insert. In case of disassembly, please apply the same torque and procedure as described above.

## 7.8 Dryer maintenance

(only applicable to compressors with refrigerant dryer)

### Safety precautions

The dryer circuit contains refrigerant. **When handling refrigerant, all applicable Safety precautions during maintenance or repair must be observed. Specifically be aware of following points:**

- Contact of liquid refrigerant with the skin can cause freezing. Wear special gloves. If contacted with the skin, the skin should be rinsed with water. On no account may clothing be removed.
- Fluid refrigerant can also cause freezing of the eyes. Wear safety glasses.
- Avoid inhalation of refrigerant vapors. Check that the working area is adequately ventilated.

Be aware that internal components of the dryer such as the pipes can reach a temperature of up to 110°C (230°F). Therefore, wait until the dryer has cooled down before removing the side panels.

Before starting any maintenance or repair work, switch off the voltage and close the air outlet valve.

**Local legislation may stipulate that:**

- Work on the refrigerant circuit of the cooling dryer or on any equipment which influences its function must be undertaken by an authorized control body.
- The installation should be checked once a year by an authorized control body.

**General**

**The following remarks should be kept in mind:**

- Keep the dryer clean.
- Brush or blow off the finned surface of condenser regularly.

**Device settings**

The regulating and safety devices are factory adjusted to obtain optimum performance of the dryer. Do not alter the setting of any of the devices.



Connecting pressure measuring devices in the refrigerant circuit can change the amount of refrigerant in the system. This results in a less optimal working of the dryer.

## 8 Problem solving



**Before carrying out any maintenance or repair, perform following steps:**

- Stop the compressor and switch off the voltage.
- Open and lock the isolating switch to prevent an accidental start.
- Isolate the compressor by closing the outlet valve.
- Depressurize the system by opening the drain valve(s).

### Compressor

Condition	Fault	Remedy
The compressor does not start.	Pressure too high.	Compressor will start again when the pressure drops to the starting pressure.
	Loose connection.	Check all electrical connections.
Safety valve blows.	Pressure too high	Check settings and correct.
	Safety valve opens too soon.	Replace valve.
Compressor capacity or pressure below normal.	Air consumption exceeds capacity of compressor.	Check equipment connected.
	Choked air inlet filter.	Remove and check filter. Replace if necessary.
	Safety valve leaking.	Replace valve.
	Compressor element out of order.	Consult your supplier.
Compressor module overheating or compressor shutdown on high air temperature.	Insufficient compressor cooling.	Improve ventilation of compressor room. Clean compressor element fins and fan, see <a href="#">Cleaning the compressor element</a> .
	Cooling fan out of order.	Check and correct.
Condensate trap continuously discharging air and water	Automatic drain out of order	Have the drain checked. Replace as necessary

### Refrigerant dryer

For compressors with a built-in refrigerant dryer also:

Condition	Fault	Remedy
Dew point too high	Air inlet temperature too high	Check and correct; see section <a href="#">Reference conditions and limitations</a>
	Fuses blown	Check fuses and remedy the cause.
	Shortage of refrigerant	Have circuit repaired or recharged.
	Refrigerant compressor does not run	See below
	Evaporator pressure is too high	See below
	Condenser pressure is too high	See below

<b>Condition</b>	<b>Fault</b>	<b>Remedy</b>
Condenser pressure too high or too low	Fan control switch out of order	Have switch replaced
	Condenser fan motor out of order	Have fan motor inspected
	Ambient temperature too high	Improve ventilation of compressor room, see section <a href="#">Installation proposal</a>
	Condenser externally clogged	Clean condenser
Motor of refrigerant compressor stops or does not start	The internal thermal protection of the motor has tripped	Compressor will restart when the motor windings have cooled down.
	Electric power supply to refrigerant compressor interrupted	Check and correct as necessary
Evaporator pressure is too high or too low	Condenser pressure too high or too low	See above
	Shortage of refrigerant	Have circuit repaired or recharged
	Hot gas bypass valve incorrectly set or out of order	Have the valve adjusted or replaced
Condensate trap continuously discharging air and water	Automatic drain out of order	Have the drain checked. Replace as necessary
Electronic condensate drain inoperative	Drain system clogged	Clean the filter of the automatic drain by opening the manual drain valve. Check functioning of the drain by pushing the test button.

## 9 Technical data

### 9.1 Electric cable size and fuses

	<ul style="list-style-type: none"> <li>The voltage on the compressor terminals must not deviate more than 10% of the nominal voltage. It is however highly recommended to keep the voltage drop over the supply cables at nominal current below 5% of the nominal voltage (IEC 60204-1).</li> <li>If cables are grouped together with other power cables, it may be necessary to use cables of a larger size than those calculated for the standard operating conditions.</li> <li>Use the original cable entry, indicated on the dimension drawings.</li> </ul> <p><b>To preserve the IP protection degree of the electric cubicle and to protect its components from dust from the environment, it is mandatory to use a proper cable gland when connecting the supply cable to the compressor.</b></p> <ul style="list-style-type: none"> <li>Local regulations remain applicable if they are stricter than the values proposed below.</li> <li><b>Caution:</b> <ul style="list-style-type: none"> <li>Always double-check the fuse size versus the calculated cable size. If required, reduce fuse size or enlarge cable size.</li> <li>Cable length should not exceed the maximum length according to IEC 60204 table 10.</li> </ul> </li> </ul>
---	---

#### Currents and fuses

Compressor type				$I_{tot} (1)$	Max fuse (1)	$I_{tot} (2)$	Max fuse (2)	Q21/Q2 2
SF 8 <sup>+</sup>	IEC	50 Hz	230 V	28 A	32 A	31 A	35 A	15.0 A
SF 8 <sup>+</sup>	IEC	60 Hz	380 V	17 A	20 A	20 A	25 A	8.9 A
SF 8 <sup>+</sup>	IEC	50 Hz	400 V	16 A	20	18 A	25 A	8.7 A
SF 8 <sup>+</sup>	IEC	50 Hz	400 V + N	16 A	20 A	19 A	25 A	8.7 A
SF 8 <sup>+</sup>	UL/cUL	60 Hz	200 V	31 A	35 A	35 A	45 A	13.7 A
SF 8 <sup>+</sup>	UL/cUL	60 Hz	230 V	28 A	35 A	31 A	40 A	12.6 A
SF 8 <sup>+</sup>	UL/cUL	60 Hz	460 V	14 A	20 A	18 A	20 A	6.3 A
SF 8 <sup>+</sup>	UL/cUL	60 Hz	575 V	11 A	15 A	14 A	15 A	4.9 A

Compressor type				$I_{tot} (1)$	Max fuse (1)	$I_{tot} (2)$	Max fuse (2)	Q21/Q2 2
SF 11 <sup>+</sup>	IEC	50 Hz	230 V	41 A	50 A	50 A	63 A	22.3 A
SF 11 <sup>+</sup>	IEC	60 Hz	380 V	27 A	32 A	34 A	40 A	14.5 A
SF 11 <sup>+</sup>	IEC	50 Hz	400 V	24 A	25 A	30 A	32 A	12.8 A
SF 11 <sup>+</sup>	IEC	50 Hz	400 V + N	24 A	25 A	33 A	35 A	12.8 A
→ SF 11 <sup>+</sup>	UL/cUL	60 Hz	200 V	51 A	60 A	64 A	70 A	21.9 A
SF 11 <sup>+</sup>	UL/cUL	60 Hz	230 V	44 A	50 A	55 A	60 A	19.0 A
SF 11 <sup>+</sup>	UL/cUL	60 Hz	460 V	22 A	25 A	28 A	30 A	9.5 A

Compressor type				$I_{tot}$ (1)	Max fuse (1)	$I_{tot}$ (2)	Max fuse (2)	Q21/Q2 2
SF 11 <sup>+</sup>	UL/cUL	60 Hz	575 V	18 A	20 A	23 A	25 A	7.6 A

$I_{tot}$  (1): maximum current in the supply lines at maximum load and nominal voltage for compressors without integrated dryer.

Max fuse (1): maximum fuse size in case of compressors without integrated dryer.

$I_{tot}$  (2): maximum current in the supply lines at maximum load and nominal voltage for compressors with integrated dryer.

Max fuse (2): maximum fuse size in case of compressors with integrated dryer.

IEC fuses: class gL/gG

UL fuses: class K5; CSA: HRC form II

### Possible configurations

There are 3 possible cabling layouts:

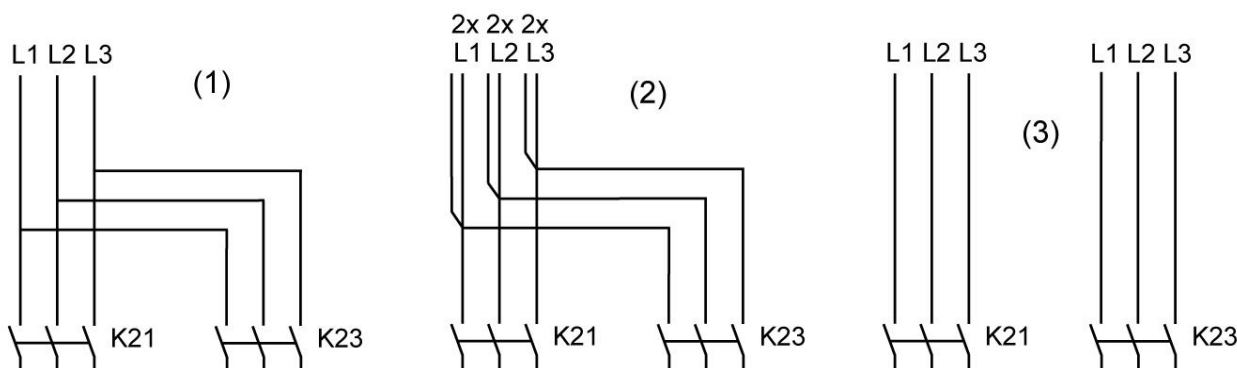

- (1): Single supply cables (for DOL variants, only K21 is used)
- (2): Parallel supply cables (for DOL variants, only K21 is used)
- (3) is only valid for Y-D versions

### Cable sizing according IEC

The tables below indicate the current carrying capacities of cables for 3 commonly used installation methods, calculated according to standard 60364-5-52 - electrical installations of buildings part 5 - selection and erection equipment and section 52 - current carrying capacities in wiring systems.

The allowed currents are valid for PVC insulated cables with three loaded copper conductors (maximum conductor temperature 70 °C).

	<p>Installation method B2 according table B.52.1. Multicore cable in conduit on a wooden wall</p>
--	---

Maximum allowed current in function of the ambient temperature for installation method B2

Cable section	Ambient temperature				
	30 °C	40 °C	45 °C	50 °C	55 °C
4 mm <sup>2</sup>	< 27 A	< 23 A	< 21 A	< 19 A	< 16 A
6 mm <sup>2</sup>	< 34 A	< 30 A	< 27 A	< 24 A	< 21 A
10 mm <sup>2</sup>	< 46 A	< 40 A	< 36 A	< 33 A	< 28 A
16 mm <sup>2</sup>	< 62 A	< 54 A	< 49 A	< 44 A	< 38 A
25 mm <sup>2</sup>	< 80 A	< 70 A	< 63 A	< 57 A	< 49 A
35 mm <sup>2</sup>	< 99 A	< 86 A	< 78 A	< 70 A	< 60 A
50 mm <sup>2</sup>	< 118 A	< 103 A	< 93 A	< 84 A	< 72 A
70 mm <sup>2</sup>	< 149 A	< 130 A	< 118 A	< 106 A	< 91 A
95 mm <sup>2</sup>	< 179 A	< 156 A	< 141 A	< 127 A	< 109 A
120 mm <sup>2</sup>	< 206 A	< 179 A	< 163 A	< 146 A	< 126 A

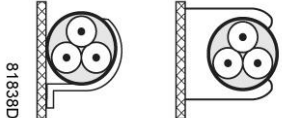

Installation method C according table B.52.1.  
Single core or multicore cable on a wooden wall

Maximum allowed current in function of the ambient temperature for installation method C

Cable section	Ambient temperature				
	30 °C	40 °C	45 °C	50 °C	55 °C
4 mm <sup>2</sup>	< 32 A	< 28 A	< 25 A	< 23 A	< 20 A
6 mm <sup>2</sup>	< 41 A	< 36 A	< 32 A	< 29 A	< 25 A
10 mm <sup>2</sup>	< 57 A	< 50 A	< 45 A	< 40 A	< 35 A
16 mm <sup>2</sup>	< 76 A	< 66 A	< 60 A	< 54 A	< 46 A
25 mm <sup>2</sup>	< 96 A	< 84 A	< 76 A	< 68 A	< 59 A
35 mm <sup>2</sup>	< 119 A	< 104 A	< 94 A	< 84 A	< 73 A
50 mm <sup>2</sup>	< 144 A	< 125 A	< 114 A	< 102 A	< 88 A
70 mm <sup>2</sup>	< 184 A	< 160 A	< 145 A	< 131 A	< 112 A
95 mm <sup>2</sup>	< 223 A	< 194 A	< 176 A	< 158 A	< 136 A
120 mm <sup>2</sup>	< 259 A	< 225 A	< 205 A	< 184 A	< 158 A

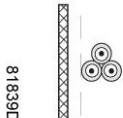

Installation method F according table B.52.1.  
Single-core cables, touching in free air  
Clearance to wall not less than one cable diameter

## Maximum allowed current in function of the ambient temperature for installation method F

Cable section	Ambient temperature				
	30 °C	40 °C	45 °C	50 °C	55 °C
25 mm <sup>2</sup>	< 110 A	< 96 A	< 87 A	< 78 A	< 67 A
35 mm <sup>2</sup>	< 137 A	< 119 A	< 108 A	< 97 A	< 84 A
50 mm <sup>2</sup>	< 167 A	< 145 A	< 132 A	< 119 A	< 102 A
70 mm <sup>2</sup>	< 216 A	< 188 A	< 171 A	< 153 A	< 132 A
95 mm <sup>2</sup>	< 264 A	< 230 A	< 209 A	< 187 A	< 161 A
120 mm <sup>2</sup>	< 308 A	< 268 A	< 243 A	< 219 A	< 188 A

**Calculation method for IEC:**

- Single supply cables (3 phases + PE - configuration (1)):
  - Add 10 % to the total current ( $I_{tot}$  from the tables)
  - Install the prescribed fuse on each cable
- Parallel supply cable (2 x 3 phases + PE - configuration (2)):
  - Add 10 % to the total current ( $I_{tot}$  from the tables) and divide by 2
  - Multiply the ampacity of the cables with 0.8 (see table A.52.17 (52-E1))
  - Install fuses of half the size of the recommended maximum fuse size on each cable.
- When using 2 x 3 phases + PE as in (3):
  - Add 10 % to the total current ( $I_{tot}$  from the tables) and divide by  $\sqrt{3}$
  - Multiply the ampacity of the cables with 0.8 (see table A.52.17 (52-E1))
  - Fuse size: the recommended maximum fuse size divided by  $\sqrt{3}$  on each cable.
- Size of the PE cable: use following rule of thumb:
  - For supply cables up to 16 mm<sup>2</sup>: same size as supply wires
  - For supply cables between 16 mm<sup>2</sup> and 35 mm<sup>2</sup>: 16 mm<sup>2</sup>
  - For supply cables larger than 35 mm<sup>2</sup>: half the size of the supply wires

Always check the voltage drop over the cable (less than 5 % of the nominal voltage is recommended)!

**Example:** For SF 11 FF 380 V 60 Hz IEC,  $I_{tot} = 30$  A, ambient temperature is 40 °C, recommended fuse: maximum 40 A

- In case of single supply cables (3 phases + PE - configuration (1)):
  - $I = 34 \text{ A} + 10 \% = 34 \times 1.1 = 37.4 \text{ A}$
  - The table for installation method B2 allows a maximum current of 30 A for a 6 mm<sup>2</sup> cable at 40 °C ambient temperature. For a cable of 10 mm<sup>2</sup>, the maximum allowed current is 40 A, which is sufficient. Therefore, use a 3 x 10 + 10 mm<sup>2</sup> cable.  
If method C is used, 6 mm<sup>2</sup> is also insufficient (maximum 36 A at 40 °C). Use a 3 x 10 + 10 mm<sup>2</sup> cable.
  - Install 40 A fuses.
- In case of parallel supply cables (2 x 3 phases + PE - configuration (2)):
  - $I = (34 \text{ A} + 10 \%) / 2 = (34 \times 1.1) / 2 = 18.7 \text{ A}$
  - For a cable of 4 mm<sup>2</sup> and installation method B2, the maximum allowed current is 23 A x 0.8 = 18.4 A at 40 °C. So take 2 parallel cables of 3 x 6 + 6 mm<sup>2</sup>.  
In case of installation method C, the maximum current of a 4 mm<sup>2</sup> cable at 40 °C is 28 A x 0.8 = 22.4 A. 2 parallel cables of 3 x 4 + 4 mm<sup>2</sup> will be sufficient.
  - Install 20 A fuses on each cable.



### Cable sizing according UL/cUL

Calculation method according UL 508A, table 28.1 column 5: allowable ampacities of insulated copper conductors (75 °C (167 °F)).

Maximum allowed current in function of the wire size (NFPA70 table 310.16)

AWG or kcmil	Maximum current
14	20 A
12	25 A
10	35A
8	50 A
6	65 A
4	85 A
3	100 A
2	115 A
1	130 A

#### Correction factors

Ambient temperature	Correction factor
21-25 °C (70-77 °F)	1.05
26-30 °C (78-86 °F)	1.00
31-35 °C (87-95 °F)	0.94
36-40 °C (96-104 °F)	0.88

#### Calculation method for UL:

- Single supply cables (3 phases + 1 PE - configuration (1)):
  - Add 25 % to the total current ( $I_{tot}$  from the tables) (see UL 508A 28.3.2: "Ampacity shall have 125 % of the full load current").
  - Install the prescribed maximum fuse on each cable
- Parallel supply cable (2 x 3 phases + 2 PE - configuration (2)):
  - Add 25 % to the total current ( $I_{tot}$  from the tables) and divide by 2
  - Multiply the ampacity of the cables with 0.8 (see UL 508A table 28.1 continued)
  - Install fuses of half the size of the recommended maximum fuse size on each cable.
- When using 2 x 3 phase + 2 PE as in (3):
  - Add 25 % to the total current ( $I_{tot}$  from the tables) and divide by  $\sqrt{3}$
  - Multiply the ampacity of the cables with 0.8 (see UL 508A table 28.1 continued)
  - Fuse size: the recommended maximum fuse size divided by  $\sqrt{3}$  on each cable.
- Size PE cable:
  - For supply cables up to AWG8: same size as the supply cables
  - For supply cables larger than AWG8: use maximum allowed ampacity of the selected supply cables and compare with value in table below (see CEC Part 1 table 17)

< 100 A: use AWG8
< 200 A: use AWG6
< 300 A: use AWG4

Always check the voltage drop over the cable (less than 5 % of the nominal voltage is recommended).

**Example of supply cable calculation:**  $I_{\text{tot}} = 28 \text{ A}$ , maximum ambient temperature is  $40^\circ\text{C}$ , recommended fuse = 40 A

- Single supply cables (3 phases + 1 PE - configuration (1)):
  - $I = 28 \text{ A} + 25 \% = 28 \times 1.25 = 35 \text{ A}$
  - For AWG8, the maximum current at  $40^\circ\text{C}$  is  $50 \text{ A} \times 0.88 = 44 \text{ A}$ , which is sufficient => use AWG8.
  - Install the prescribed maximum fuse (40 A) on each cable
- Parallel supply cable (2 x 3 phases + 2 PE - configuration (2)):
  - $I = (28 \text{ A} + 25\%)/2 = (28 \times 1.25)/2 = 17.5 \text{ A}$
  - For a AWG14, the maximum current at  $40^\circ\text{C}$  is  $20 \text{ A} \times 0.88 \times 0.8 = 14.1 \text{ A}$ , which is insufficient. For an AWG14, the maximum current is  $25 \times 0.88 \times 0.8 = 17.6 \text{ A}$ . So 2 parallel cables of 3 x AWG12 + 2 x AWG12 are sufficient.
  - Install 20 A fuses on each cable.

## 9.2 Reference conditions and limitations

### Reference conditions

Air inlet pressure (absolute)	bar	1
Air inlet pressure (absolute)	psi	14.5
Air inlet temperature	$^\circ\text{C}$	20
Air inlet temperature	$^\circ\text{F}$	68
Relative humidity	%	0
Working pressure		See section Compressor data

### Limits

Maximum working pressure		See section Compressor data
Maximum inlet temperature	$^\circ\text{C}$	40
Maximum inlet temperature	$^\circ\text{F}$	104
Minimum ambient temperature	$^\circ\text{C}$	0
Minimum ambient temperature	$^\circ\text{F}$	32

## 9.3 Compressor data



All data specified below apply under reference conditions, see section [Reference conditions and limitations](#).

## 8 bar compressors, 50 Hz

Compressor type		SF 8 <sup>+</sup>	SF 11 <sup>+</sup>
Maximum working pressure (compressors without integrated dryer)	bar(e)	8	8
Maximum working pressure (compressors without integrated dryer)	psi(g)	116	116
Maximum working pressure (compressors with integrated dryer)	bar(e)	7.75	7.75
Maximum working pressure (compressors with integrated dryer)	psi(g)	112	112
Reference working pressure (compressors without integrated dryer)	bar(e)	7	7
Reference working pressure (compressors without integrated dryer)	psi(g)	101.5	101.5
Reference working pressure (compressors with integrated dryer)	bar(e)	6.75	6.75
Reference working pressure (compressors with integrated dryer)	psi(g)	98	98
Air temperature at outlet valve (compressors without integrated dryer)	°C	28	30
Air temperature at outlet valve (compressors without integrated dryer)	°F	82	86
Air temperature at outlet valve (compressors with integrated dryer)	°C	25	25
Air temperature at outlet valve (compressors with integrated dryer)	°F	77	77
Motor shaft speed	rpm	2900	2900
Nominal motor power	kW	2 x 3.7	2 x 5.5
Nominal motor power	hp	2 x 5	2 x 7.5
Sound pressure level (compressors without integrated dryer)	dB(A)	63	63
Refrigerant type (compressors with integrated dryer)		R134a	R134a
Dew point (compressors with integrated dryer)	°C	3	3
Dew point (compressors with integrated dryer)	°F	37	37

## 10 bar compressors, 50 Hz

Compressor type		SF 8 <sup>+</sup>	SF 11 <sup>+</sup>
Maximum working pressure (compressors without integrated dryer)	bar(e)	10	10
Maximum working pressure (compressors without integrated dryer)	psi(g)	145	145
Maximum working pressure (compressors with integrated dryer)	bar(e)	9.75	9.75
Maximum working pressure (compressors with integrated dryer)	psi(g)	141	141
Reference working pressure (compressors without integrated dryer)	bar(e)	9	9
Reference working pressure (compressors without integrated dryer)	psi(g)	130.5	130.5
Reference working pressure (compressors with integrated dryer)	bar(e)	8.75	8.75
Reference working pressure (compressors with integrated dryer)	psi(g)	127	127

Compressor type		SF 8 <sup>+</sup>	SF 11 <sup>+</sup>
Air temperature at outlet valve (compressors without integrated dryer)	°C	28	30
Air temperature at outlet valve (compressors without integrated dryer)	°F	82	86
Air temperature at outlet valve (compressors with integrated dryer)	°C	25	25
Air temperature at outlet valve (compressors with integrated dryer)	°F	77	77
Motor shaft speed	rpm	2900	2900
Nominal motor power	kW	2 x 3.7	2 x 5.5
Nominal motor power	hp	2 x 5	2 x 7.5
Sound pressure level (compressors without integrated dryer)	dB(A)	63	63
Refrigerant type (compressors with integrated dryer)		R134a	R134a
Dew point (compressors with integrated dryer)	°C	3	3
Dew point (compressors with integrated dryer)	°F	37	37

**116 psi compressors, 60 Hz**

Compressor type		SF 8 <sup>+</sup>	SF 11 <sup>+</sup>
Maximum working pressure (compressors without integrated dryer)	bar(e)	8	8
Maximum working pressure (compressors without integrated dryer)	psi(g)	116	116
Maximum working pressure (compressors with integrated dryer)	bar(e)	7.75	7.75
Maximum working pressure (compressors with integrated dryer)	psi(g)	112	112
Reference working pressure (compressors without integrated dryer)	bar(e)	7	7
Reference working pressure (compressors without integrated dryer)	psi(g)	101.5	101.5
Reference working pressure (compressors with integrated dryer)	bar(e)	6.75	6.75
Reference working pressure (compressors with integrated dryer)	psi(g)	98	98
Air temperature at outlet valve (compressors without integrated dryer)	°C	28	29
Air temperature at outlet valve (compressors without integrated dryer)	°F	82	84
Air temperature at outlet valve (compressors with integrated dryer)	°C	25	25
Air temperature at outlet valve (compressors with integrated dryer)	°F	77	77
Motor shaft speed	rpm	3505	3505
Nominal motor power	kW	2 x 3.7	2 x 5.5
Nominal motor power	hp	2 x 5	2 x 7.5
Sound pressure level (compressors without integrated dryer)	dB(A)	63	63
Refrigerant type (compressors with integrated dryer)		R134a	R134a

Compressor type		SF 8 <sup>+</sup>	SF 11 <sup>+</sup>
Dew point (compressors with integrated dryer)	°C	3	3
Dew point (compressors with integrated dryer)	°F	37	37

**145 psi compressors, 60 Hz**

Compressor type		SF 8 <sup>+</sup>	SF 11 <sup>+</sup>
Maximum working pressure (compressors without integrated dryer)	bar(e)	10	10
Maximum working pressure (compressors without integrated dryer)	psi(g)	145	145
Maximum working pressure (compressors with integrated dryer)	bar(e)	9.75	9.75
Maximum working pressure (compressors with integrated dryer)	psi(g)	141	141
Reference working pressure (compressors without integrated dryer)	bar(e)	9	9
Reference working pressure (compressors without integrated dryer)	psi(g)	130.5	130.5
Reference working pressure (compressors with integrated dryer)	bar(e)	8.75	8.75
Reference working pressure (compressors with integrated dryer)	psi(g)	127	127
Air temperature at outlet valve (compressors without integrated dryer)	°C	28	30
Air temperature at outlet valve (compressors without integrated dryer)	°F	82	86
Air temperature at outlet valve (compressors with integrated dryer)	°C	25	25
Air temperature at outlet valve (compressors with integrated dryer)	°F	77	77
Motor shaft speed	rpm	3495	3495
Nominal motor power	kW	2 x 3.7	2 x 5.5
Nominal motor power	hp	2 x 5	2 x 7.5
Sound pressure level (compressors without integrated dryer)	dB(A)	63	63
Refrigerant type (compressors with integrated dryer)		R134a	R134a
Dew point (compressors with integrated dryer)	°C	3	3
Dew point (compressors with integrated dryer)	°F	37	37

## 10 Guidelines for inspection

### Guidelines

On the Declaration of Conformity / Declaration by the Manufacturer, the harmonised and/or other standards that have been used for the design are shown and/or referred to.

The Declaration of Conformity / Declaration by the Manufacturer is part of the documentation that is supplied with this compressor.

Local legal requirements and/or use outside the limits and/or conditions as specified by the manufacturer may require other inspection periods as mentioned below.

## 11 PED (Pressure Equipment Directive)

### Components subject to Pressure Equipment Directive 97/23/EC (until 20/07/2016) or 2014/68/EU (from 20/07/2016 onwards)

Components subject to 97/23/EC / 2014/68/EU Pressure Equipment Directive greater than or equal to category II:

Part number	Description	Medium	Pressure
0830 1009 17	Safety valve	Air	9.3 bar
0830 1008 49	Safety valve	Air	9.3 bar
0830 1009 18	Safety valve	Air	11.5 bar
0830 1008 35	Safety valve	Air	11 bar

Volume	P x V or P	Life cycle	PED class
NA	NA	2 x 10 <sup>6</sup>	IV
NA	NA	2 x 10 <sup>6</sup>	IV
NA	NA	2 x 10 <sup>6</sup>	IV
NA	NA	2 x 10 <sup>6</sup>	IV

#### Overall rating

The compressors conform to PED category I or smaller.

## 12 Declaration of conformity

### EC DECLARATION OF CONFORMITY

1

2 We, .....(1)....., declare under our sole responsibility, that the product

3 Machine name:

4 Machine type:

5 Serial number:

6 Which falls under the provisions of article 12.2 of the EC Directive 2006/42/EC on the approximation of the laws of the Member States relating to machinery, is in conformity with the relevant Essential Health and Safety Requirements of this directive.

The machinery complies also with the requirements of the following directives and their amendments as indicated.

7

	<b>Directive on the approximation of laws of the Member States relating to (2)</b>	<b>Harmonized and/or Technical Standards used (3)</b>	<b>Att'mnt</b>
a.			X
b.			
c.			X
d.			
e.			X

8.a The harmonized and the technical standards used are identified in the attachments hereafter

8.b .....(1)..... is authorized to compile the technical file.

9

10 **Conformity of the specification to the directives**

**Conformity of the product to the specification and by implication to the directives**

11

12 Issued by

Engineering

Manufacturing

13

14 Name

15

Signature

16

Date

84350D

*Typical example of a Declaration of Conformity document*

(1): Contact address:

Atlas Copco Airpower n.v.

P.O. Box 100

B-2610 Wilrijk (Antwerp)

Belgium

(2): Applicable directives

(3): Standards used



On the Declaration of Conformity / Declaration by the Manufacturer, the harmonized and/or other standards that have been used for the design are shown and/or referred to.

The Declaration of Conformity / Declaration by the Manufacturer is part of the documentation that is supplied with this device.





In order to be First in Mind—First in Choice® for all your quality compressed air needs, Atlas Copco delivers the products and services that help to increase your business' efficiency and profitability.

Atlas Copco's pursuit of innovation never ceases, driven by our need for reliability and efficiency. Always working with you, we are committed to providing you the customized quality air solution that is the driving force behind your business.

