

# Autodesk Inventor Nastran Editor 2020

## User's Manual

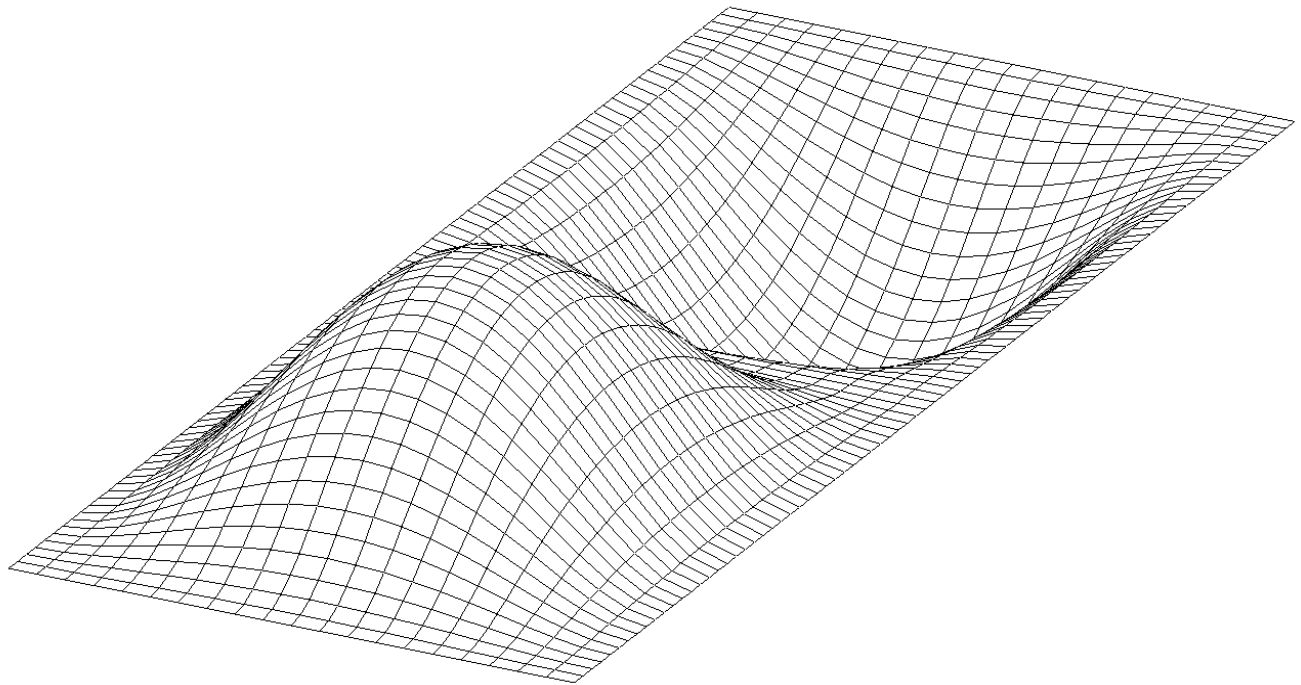

© 2019 Autodesk, Inc. All rights reserved.

**Autodesk® Inventor® Nastran® Editor 2020**

Except as otherwise permitted by Autodesk, Inc., this publication, or parts thereof, may not be reproduced in any form, by any method, for any purpose.

Certain materials included in this publication are reprinted with the permission of the copyright holder.

### **Trademarks**

The following are registered trademarks or trademarks of Autodesk, Inc., and/or its subsidiaries and/or affiliates in the USA and other countries: 123D, 3ds Max, Alias, ATC, AutoCAD LT, AutoCAD, Autodesk, the Autodesk logo, Autodesk 123D, Autodesk Homestyler, Autodesk Inventor, Autodesk MapGuide, Autodesk Streamline, AutoLISP, AutoSketch, AutoSnap, AutoTrack, Backburner, Backdraft, Beast, BIM 360, Burn, Buzzsaw, CADmep, CAiCE, CAMduct, Civil 3D, Combustion, Communication Specification, Configurator 360, Constructware, Content Explorer, Creative Bridge, Dancing Baby (image), DesignCenter, DesignKids, DesignStudio, Discreet, DWF, DWG, DWG (design/logo), DWG Extreme, DWG TrueConvert, DWG TrueView, DWGX, DXF, Ecotect, Ember, ESTmep, Evolver, FABmep, Face Robot, FBX, Fempro, Fire, Flame, Flare, Flint, ForceEffect, FormIt, Freewheel, Fusion 360, Glue, Green Building Studio, Heidi, Homestyler, HumanIK, i-drop, ImageModeler, Incinerator, Inferno, InfraWorks, InfraWorks 360, Instructables, Instructables (stylized robot design/logo), Inventor, Inventor HSM, Inventor LT, Lustre, Maya, Maya LT, MIMI, Mockup 360, Moldflow Plastics Advisers, Moldflow Plastics Insight, Moldflow, Moondust, MotionBuilder, Movimento, MPA (design/logo), MPA, MPI (design/logo), MPX (design/logo), MPX, Mudbox, Navisworks, ObjectARX, ObjectDBX, Opticore, Pixlr, Pixlr-o-matic, Productstream, Publisher 360, RasterDWG, RealDWG, ReCap, ReCap 360, Remote, Revit LT, Revit, RiverCAD, Robot, Scaleform, Showcase, Showcase 360, SketchBook, Smoke, Socialcam, Softimage, Sparks, SteeringWheels, Stitcher, Stone, StormNET, TinkerBox, ToolClip, Topobase, Toxik, TrustedDWG, T-Splines, ViewCube, Visual LISP, Visual, VRED, Wire, Wiretap, WiretapCentral, XSI.

NASTRAN® is a registered trademark of the National Aeronautics Space Administration. All other brand names, product names or trademarks belong to their respective holders.

### **Disclaimer**

THIS PUBLICATION AND THE INFORMATION CONTAINED HEREIN IS MADE AVAILABLE BY AUTODESK, INC. "AS IS." AUTODESK, INC. DISCLAIMS ALL WARRANTIES, EITHER EXPRESS OR IMPLIED, INCLUDING BUT NOT LIMITED TO ANY IMPLIED WARRANTIES OF MERCHANTABILITY OR FITNESS FOR

## TABLE OF CONTENTS

<b>1</b>	<b>Introduction .....</b>	<b>5</b>
<b>2</b>	<b>Graphical User Interface .....</b>	<b>6</b>
2.1	Message Window .....	7
2.2	Queue Window .....	7
2.3	Options View .....	8
2.4	Model/Results Tree View .....	9
2.5	Model Analysis Window .....	9
2.5.1	Model Analysis View Popup Menus .....	10
2.5.2	Nastran View .....	11
2.5.3	Analysis View .....	12
2.5.4	Errors/Warnings View .....	12
2.5.5	Result Summary View .....	13
2.5.6	Output View .....	14
2.5.7	Model/Results View .....	14
2.6	Loading and Displaying Results .....	16
2.6.1	Analysis Specific Results .....	17
2.6.2	Display of Composite Results .....	19
2.6.3	Using Dynamic Query .....	20
2.6.4	Using the Highlight Option .....	21
2.6.5	Animation Setup .....	22
2.6.6	Results Limits .....	23
<b>3</b>	<b>Customizing Analysis Options.....</b>	<b>26</b>
3.1	Integer Options.....	26
3.2	Real Options .....	26
3.3	File Options .....	27
3.4	String Options .....	27
<b>4</b>	<b>Menus .....</b>	<b>28</b>
4.1	File Menu.....	28
4.2	Edit Menu .....	28
4.3	View Menu.....	29
4.4	Analysis Menu .....	30
4.5	Setup Menu .....	30
4.5.1	Default Settings – General.....	31
4.5.2	Default Settings – Launch Behavior .....	33
4.5.3	Default Settings – Post Processing .....	35
4.5.4	Default Settings – Display Options.....	37
4.5.5	Default Settings – XY Plotting Defaults .....	41
4.5.6	Default Settings – XYZ Plotting Defaults .....	42
4.5.7	Default Settings – Report Generation .....	43
4.5.8	Default Analysis Options Menu .....	45
4.6	Window Menu .....	45
4.7	Help Menu .....	46
<b>5</b>	<b>Creating Queues.....</b>	<b>47</b>
<b>6</b>	<b>Displaying Plots .....</b>	<b>48</b>

6.1 Custom Plots .....49

6.2 Plot Formatting.....50

6.3 Deleting Plots .....51

7 Nonlinear Settings.....52

8 Toolbars .....54

8.1 Standard Toolbar.....54

8.2 Query Toolbar.....54

8.3 Graphics Toolbar.....54

8.4 Standard Views Toolbar.....54

9 Field and Column Editing .....55

9.1 Fixed Field Markers.....55

9.2 Field Helpers.....56

9.3 Column Editing.....56

10 Include File Support .....57

11 Report Generation.....58

## 1 Introduction

The Autodesk® Inventor® Nastran® Editor 2020 is an industry-unique tool that gives engineers greater control over their Nastran FEA models and results. Features such as advanced editing, context-sensitive input, and dynamic help greatly increase productivity and results reliability from the start. New advanced graphics option, which uses hardware acceleration, improves the performance for saving and loading large models, displaying and animating large results files. Real-time results are displayed through an integrated post-processor, allowing users to visualize results as they are generated during the solution sequence. These features combined make the Autodesk Inventor Nastran Editor an indispensable tool for designers and analysts alike.

## 2 Graphical User Interface

Figure 1 shows the Editor graphical user interface. Each separate Model Input File uses its own interface. The interface is split into two panes. The left pane contains the analysis options used to modify the analysis. The right pane has five tabbed “folder” windows containing the following:

- Nastran – The Model Input File (.NAS)
- Analysis – The model status displayed as the analysis progresses
- Errors/Warnings – All error and warning messages resulting from a completed analysis run
- Summary – The Result Summary File (.RSF) from a completed analysis run
- Output – The Model Results Output file (.OUT) from a completed analysis run
- Model/Results – The model displayed graphically using OpenGL

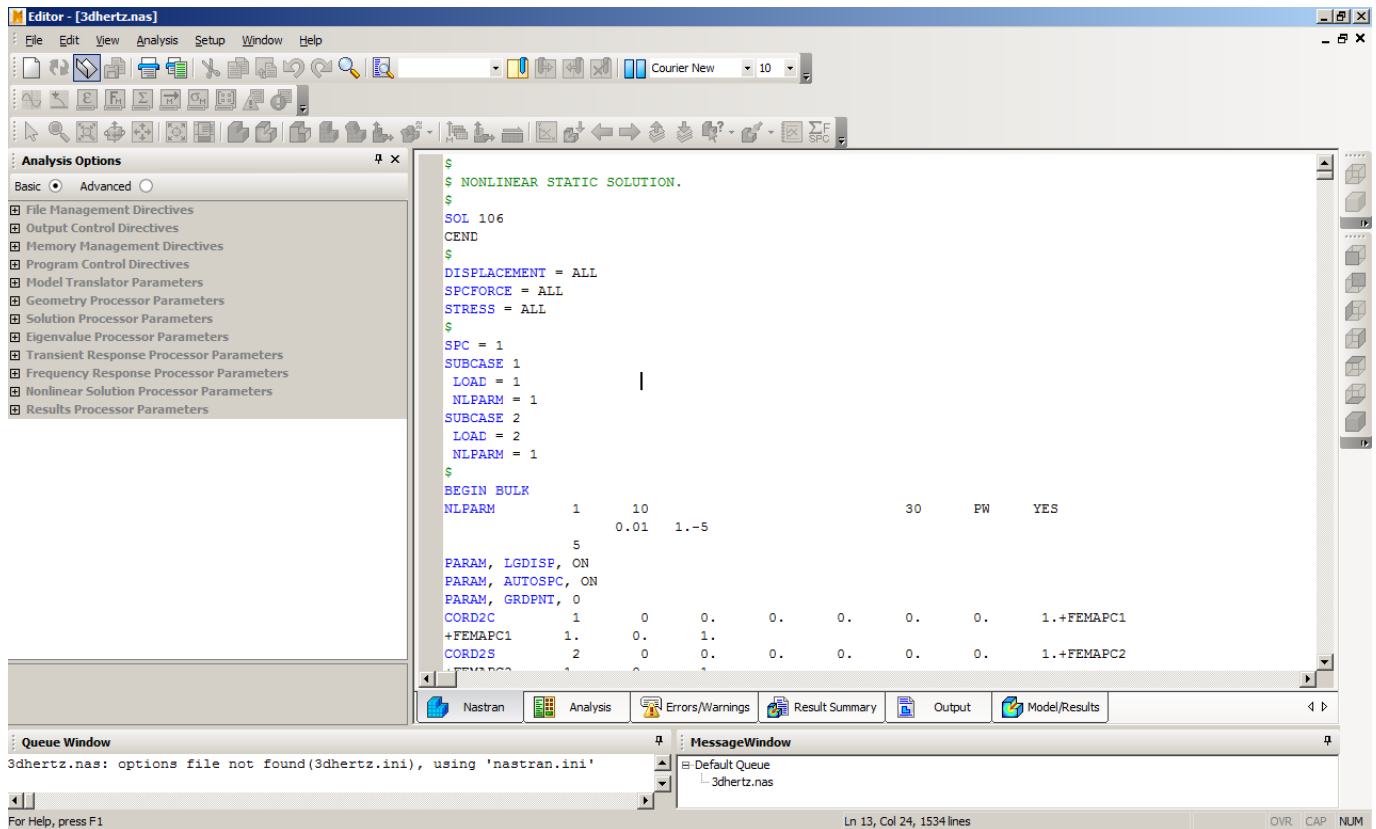

Figure 1 – Graphical User Interface

## 2.1 Message Window

The Message window is shown in Figure 2 and displays general messages from the Autodesk Inventor Nastran solver such as an analysis start/complete message, and messages concerning model initialization. This window is dockable anywhere within the Editor’s main window by clicking and dragging the title bar and positioning it near a border of the main window. It may be turned on/off using the View menu. It is automatically displayed when the first document is opened.

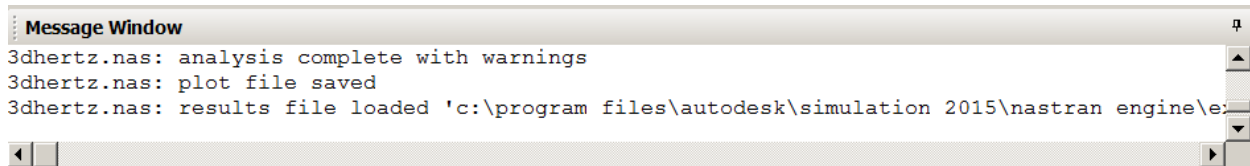

Figure 2 – Message Window

## 2.2 Queue Window

The Queue window is shown in Figure 3 and displays the name of the currently running analysis along with any queued analyses. This window is dockable within the Editor main area by clicking and dragging and positioning it near a border of the main window. It may be turned on/off using the View menu. The queue window will display automatically when a job is added to the queue.



Figure 3 – Queue Window

### 2.3 Options View

The Options view is shown in Figure 4 and enables you to view/change any and all of the analysis options. The option categories can be expanded by clicking the “+” sign and collapsed by clicking the “-“ sign. The Parameters/Directives tree is categorized into Basic and Advanced.

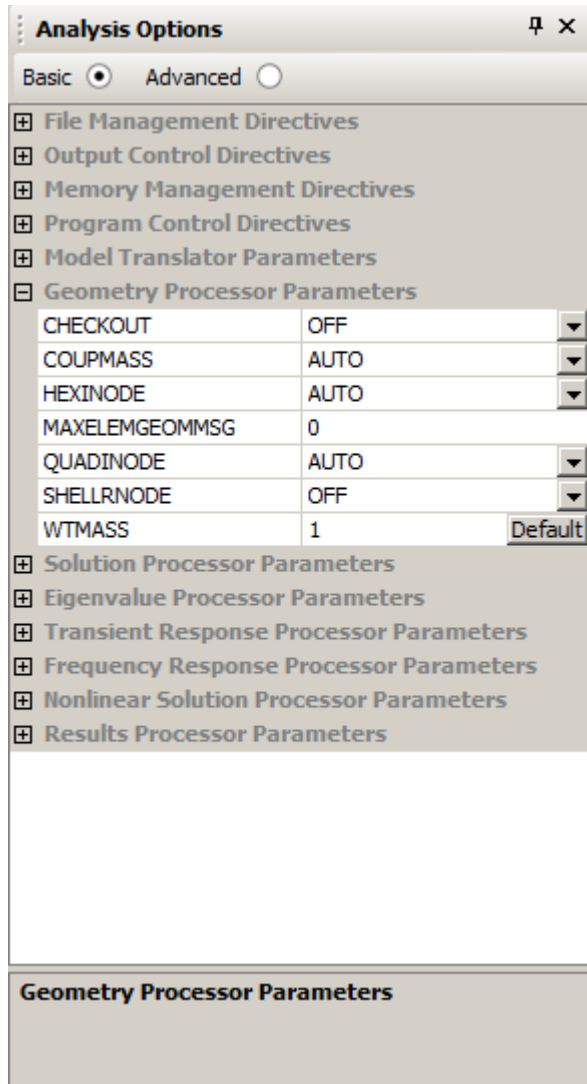

Figure 4 – Options View

**Note:** The entries in each group support context sensitive Help. To view Help, select the option and press F1. This will display the help topic for that directive.



## 2.4 Model/Results Tree View

The Model/Results Tree view is shown in Figure 5.

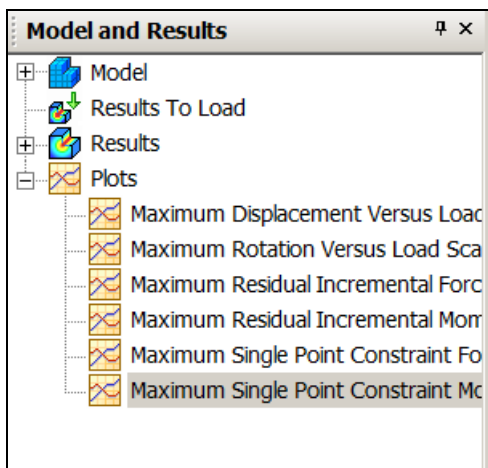

Figure 5 – Model/Results Tree View

## 2.5 Model Analysis Window

The Model Analysis window (Figure 6) contains the following:

- Nastran – The Model Input File (.NAS)
- Analysis – The model status displayed as the analysis progresses
- Errors/Warnings – All error and warning messages resulting from a completed analysis run
- Summary – The Result Summary File (.RSF) from a completed analysis run
- Output – The Model Results Output file (.OUT) from a completed analysis run
- Model/Results – The model displayed graphically using OpenGL

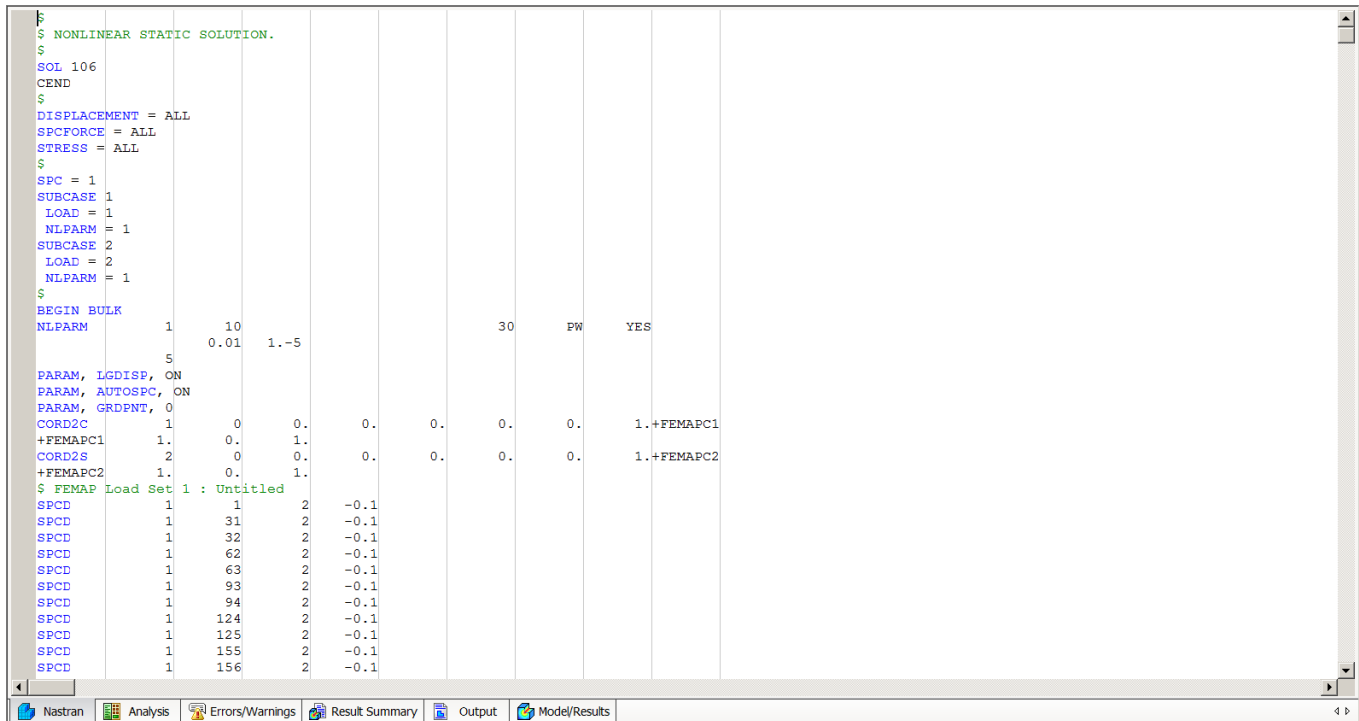

Figure 6 – Model Analysis Window

### 2.5.1 Model Analysis View Popup Menus

In the Model Analysis view, you can select any Bulk Data entry, right-click and select **Convert to Fixed Field (Narrow)**. Choosing this option will expand the entries into a fixed field (see Figure 7).

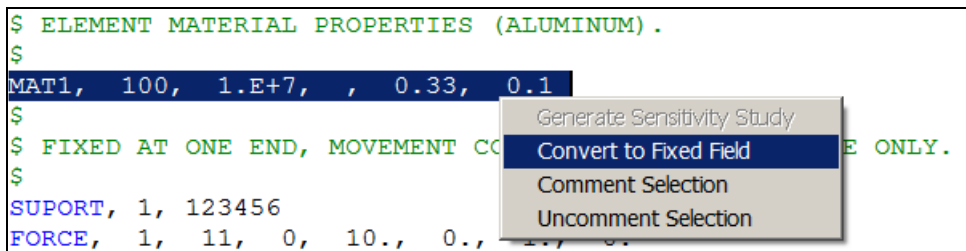
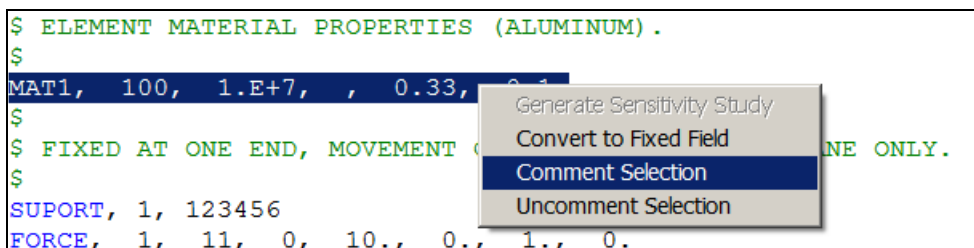
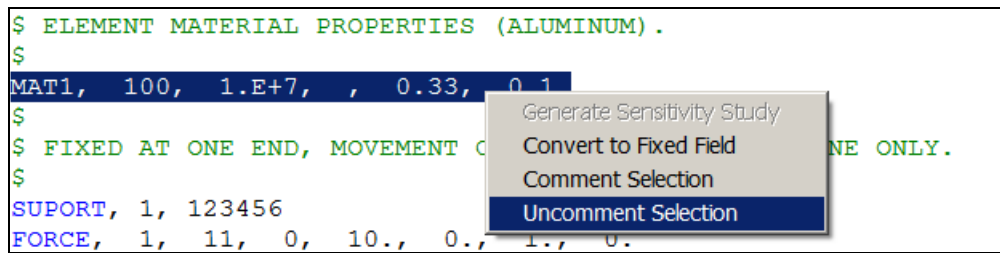

Figure 7 – Model Analysis View, Convert to Fixed Field Popup Menu

Choosing the **Comment Selection** or **Uncomment Selection** will include or exclude selected Bulk Data entry from the analysis, as shown in Figure 8.





**Figure 8 – Model Analysis View, Comment Section/Uncomment Selection Popup Menus**

To generate a sensitivity study, you must convert your Bulk Data entry to a Fixed Field format. Put your cursor on the entry and right-click as shown in Figure 9.

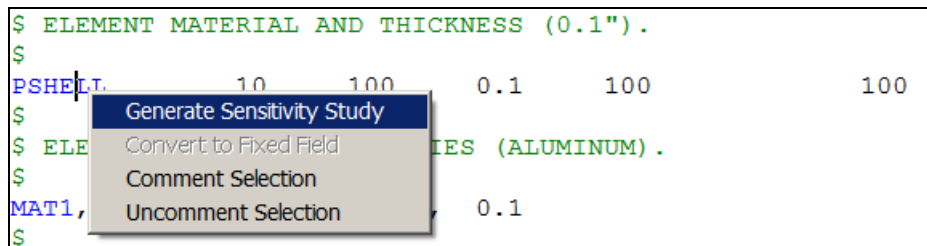

**Figure 9 – Model Analysis View, Generate PSHELL Sensitivity Study Popup Menu**

Selecting the **Generate Sensitivity Study** option will bring up a window like Figure 10. Users can enter the desired thickness minimum, maximum, and number of steps. The number of steps will determine the increment between the thickness minimum and thickness maximum. The Editor will create as many .NAS files as you have in number of steps and automatically put them in a queue.

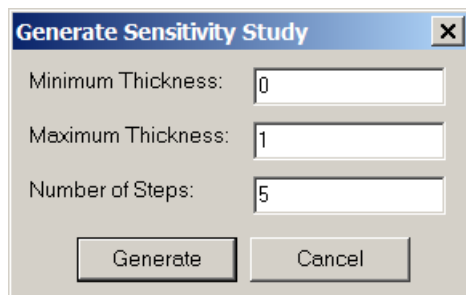

**Figure 10 – Generate PSHELL Sensitivity Study Popup Window**

### 2.5.2 Nastran View

The Nastran view is shown in Figure 6 and displays the Model Input File (.NAS) as imported from a modeling program such as Femap.

### 2.5.3 Analysis View

The Analysis view is shown in Figure 11 and displays model status during the analysis run. This view is automatically activated when an analysis is started either interactively or from the queue. Once the analysis is complete, the active view will change to the errors/warnings view. The analysis view is read-only.

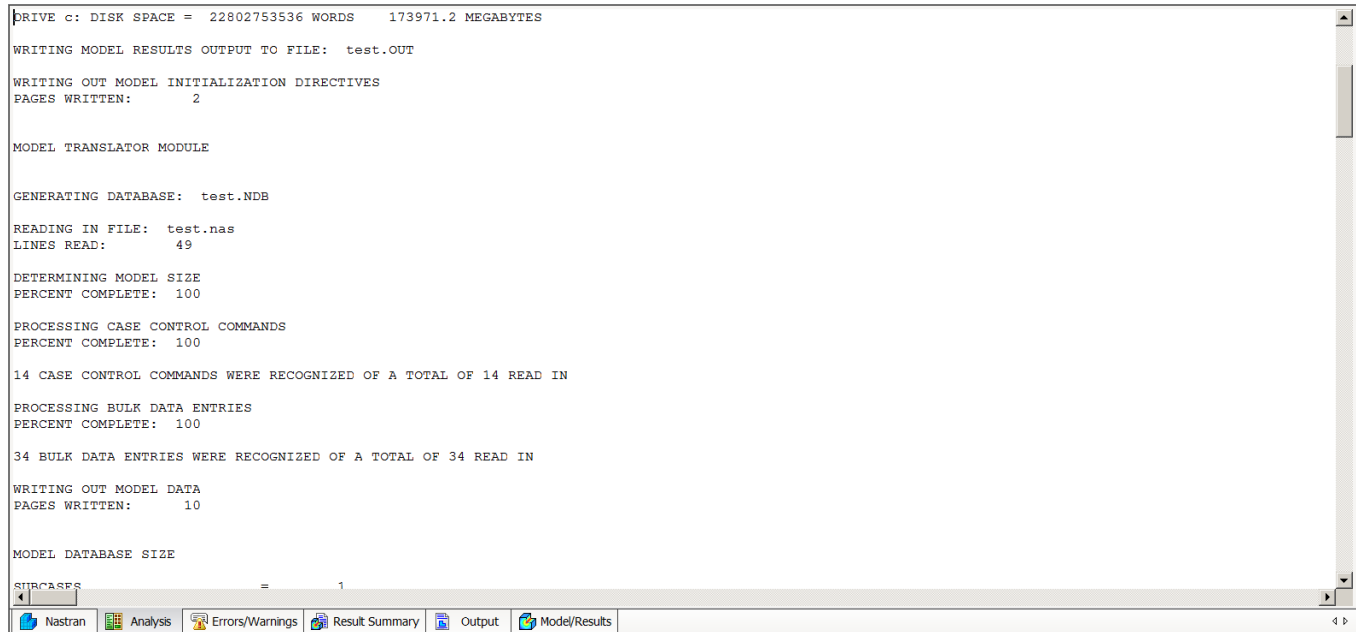

**Figure 11 – Analysis View**

### 2.5.4 Errors/Warnings View

The Errors/Warnings view is shown in Figure 12 and displays all errors and warnings that occurred during analysis. This view is made active when the analysis is complete. This is a read-only view. You can also view the description of the warnings or fatal errors by placing the cursor on the ID and pressing F1. It will bring up the Autodesk Inventor Nastran Documentation with the information about the error.

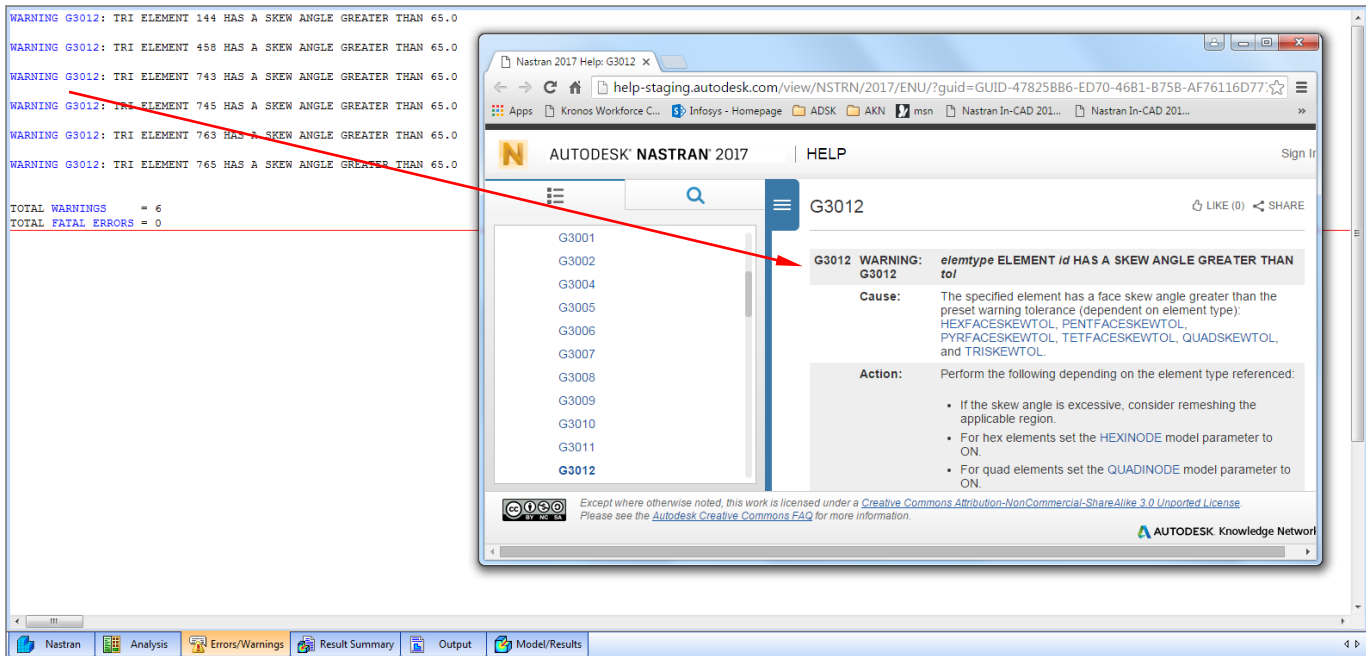

Figure 12 – Errors/Warnings View

### 2.5.5 Result Summary View

The Result Summary view is shown in Figure 13 and displays the Result Summary File (.RSF). This file is opened automatically (if it exists) when a model input file (.NAS) is opened. It is then re-opened when the analysis is complete. This is a read-only file.

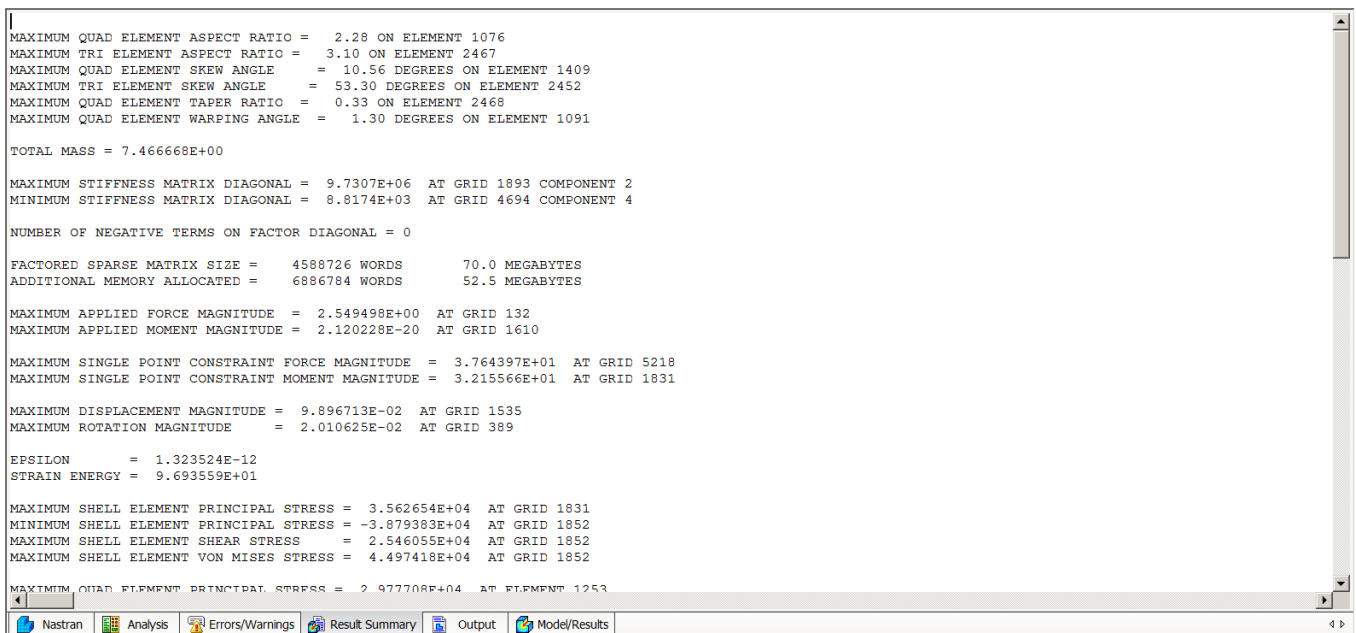
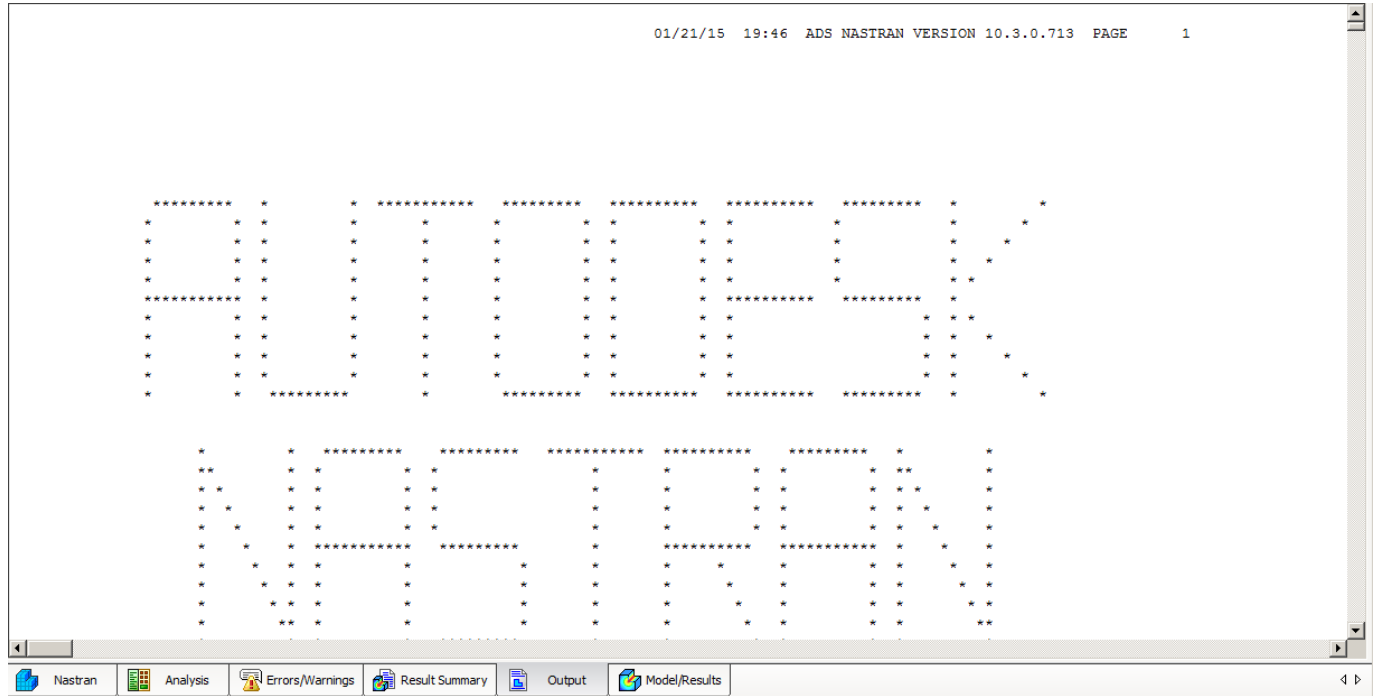

Figure 13 – Result Summary View

### 2.5.6 Output View

The Output view is shown in Figure 14 and displays the Model Results Output File (.OUT). This file is automatically opened (if it exists) when a corresponding Model Input File (.NAS) is opened. It is then re-opened when the analysis is complete. This is a read-only file.



**Figure 14 – Output View**

Within the Output window, you can right-click and perform searches as shown in Figure 15.

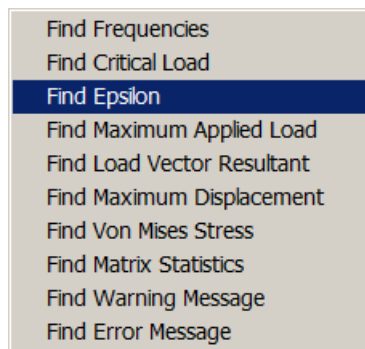

**Figure 15 – Output View, Popup Menu**

### 2.5.7 Model/Results View

The Model/Results view is shown in Figure 16 and displays the model graphically. It uses OpenGL for rendering the model. If your computer has an OpenGL capable graphics card, large models can be viewed interactively with good response.

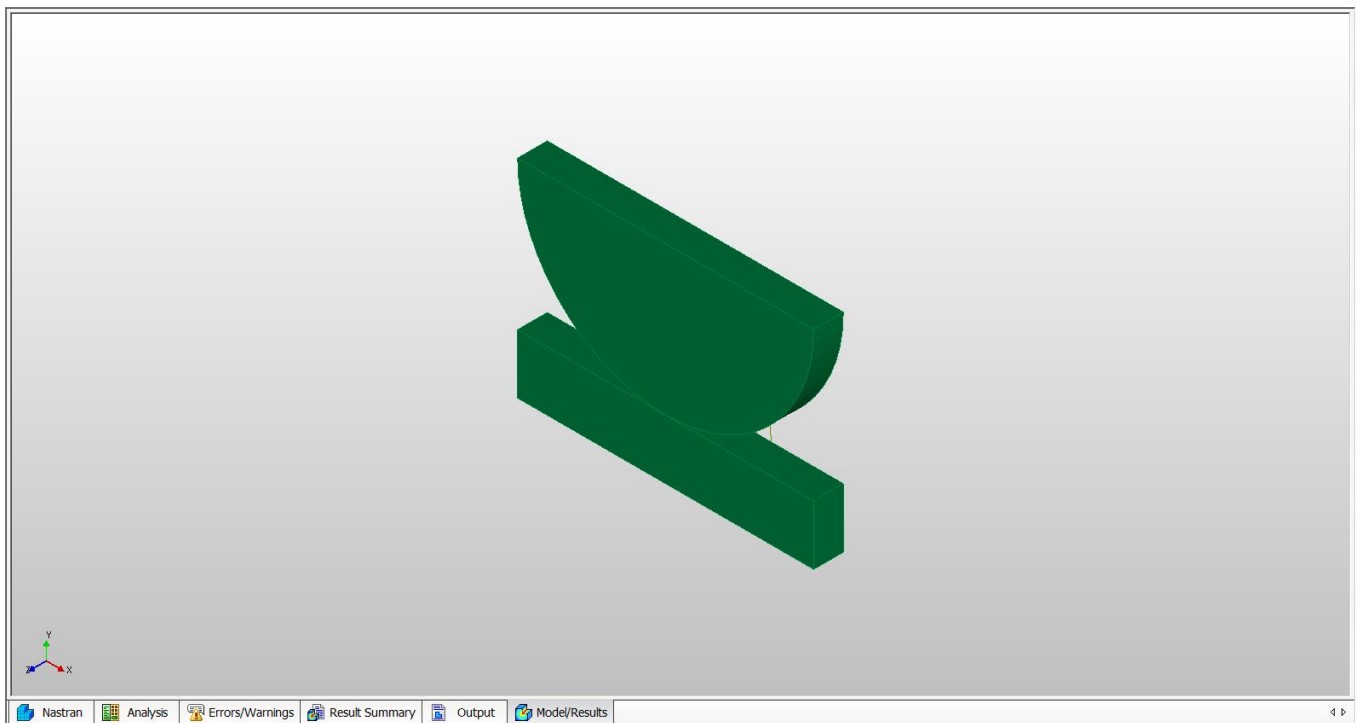

**Figure 16 – Model/Results View**

Within the Model/Results window you can right-click and choose different display options as shown in Figure 17.

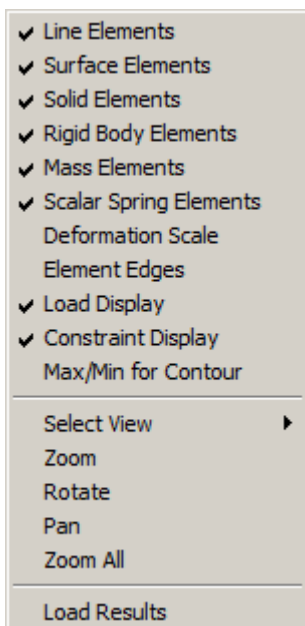

**Figure 17 – Model/Results View, Popup Menu**

By selecting **Deformation Scale** (Figure 17, above) the Set Deformation Scale option shown in Figure 18 allows the user to set a deformed scaling so that the deformations can be easily viewed. The Element Edges will show the element edge lines, allowing users to get a better idea of the mesh. These lines can be changed via the **Element Edge Color** option.

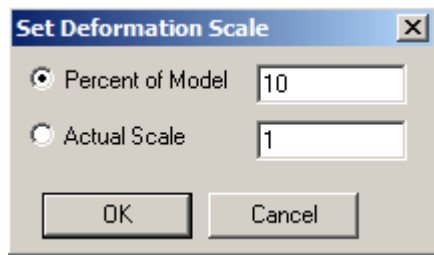

Figure 18 – Deformation Scale Settings

## 2.6 Loading and Displaying Results

After an analysis is complete, clicking on the Model/Results tab will allow the user to view a deformed and contoured display of the model. The results will be loaded immediately after a Nastran run.

Once results are loaded, right-clicking on a load vector will give you options such as using it to contour the model or deform it as shown in Figure 19. Visualizing normal vectors or certain other results are also available as appropriate to the element/analysis type. Mid-side nodes for 2D and 3D elements can now be visualized as well.

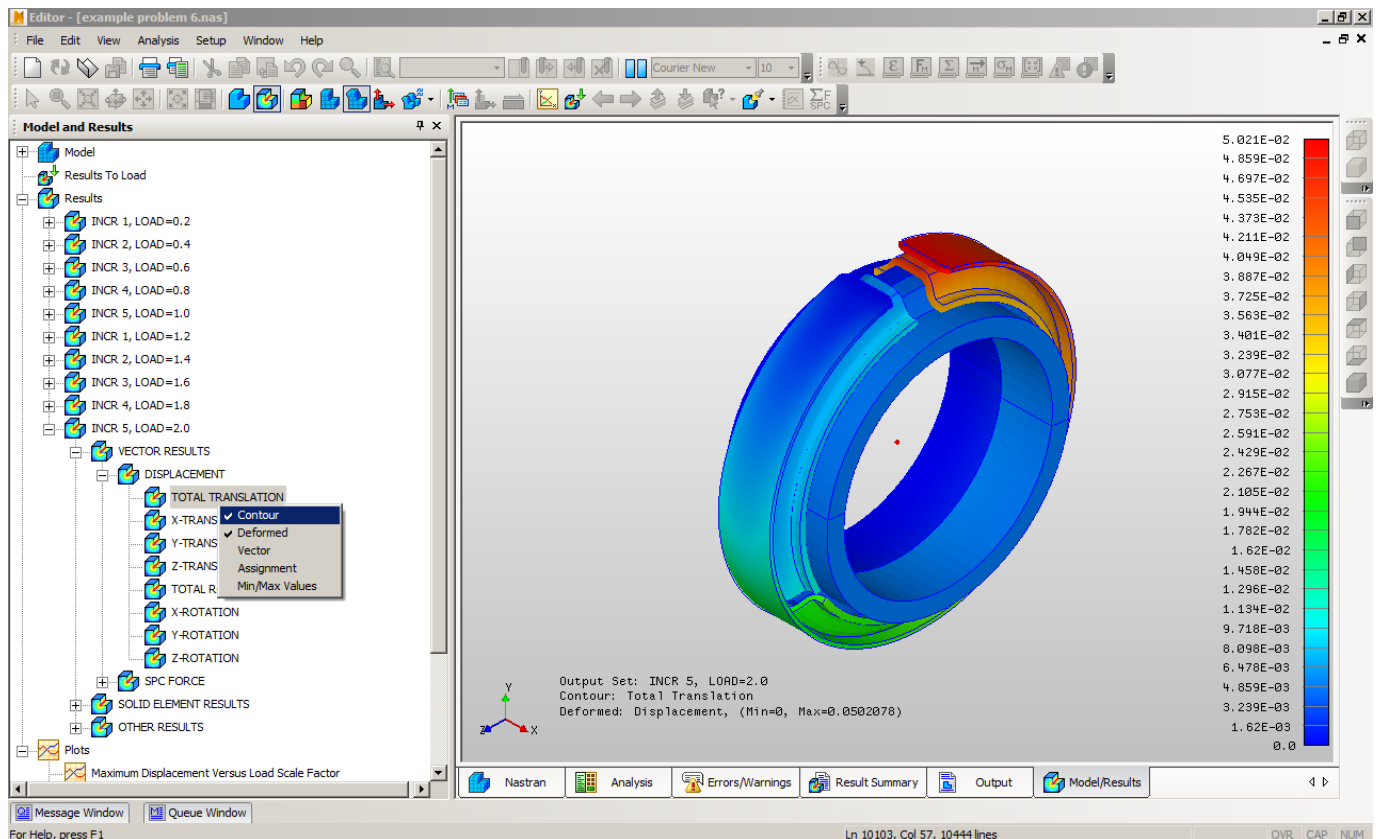

Figure 19 – Displaying Results



### 2.6.1 Analysis Specific Results

Additional Model/Results output features include support for GRID POINT STRESS and GRID POINT STRAIN, as shown in Figure 20. Note that either the Case Control GPSTRESS or GPSTRAIN must be included in the Autodesk Inventor Nastran deck.

Forces and Stresses due to contact are supported, when available per the Autodesk Inventor Nastran analysis, as shown in Figure 21.

Rod and Beam output is displayed with a specific Rod (or Beam) element selection as shown in Figure 22.

For solutions involving polar and rectangular complex data, such as SOL110-Modal Complex Eigenvalue and SOL108-Direct Frequency Response, the results tree will also provide selections for the complex outputs involving phase and real and imaginary forces (Figure 23).

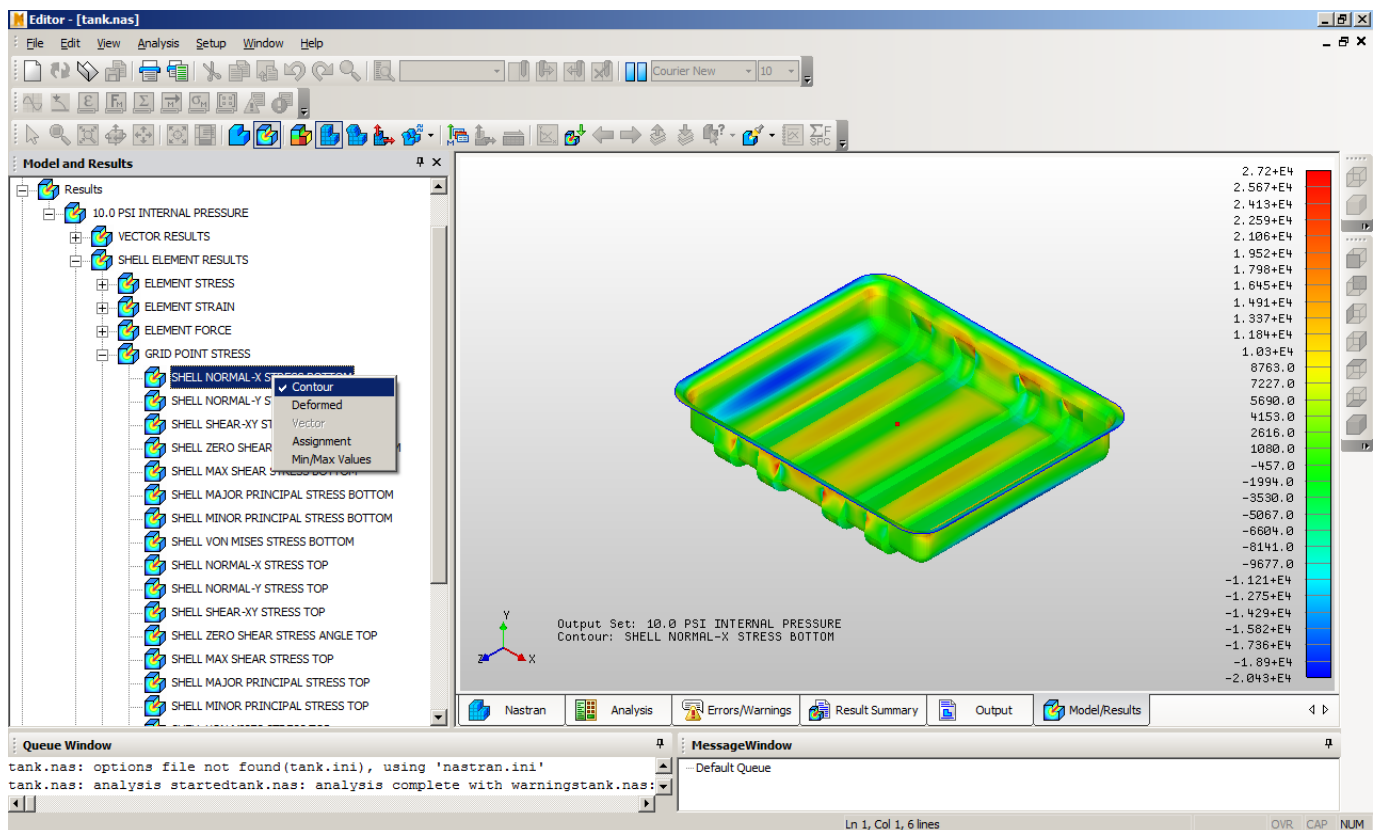

Figure 20 – Displaying GRID POINT STRESS/STRAIN Results

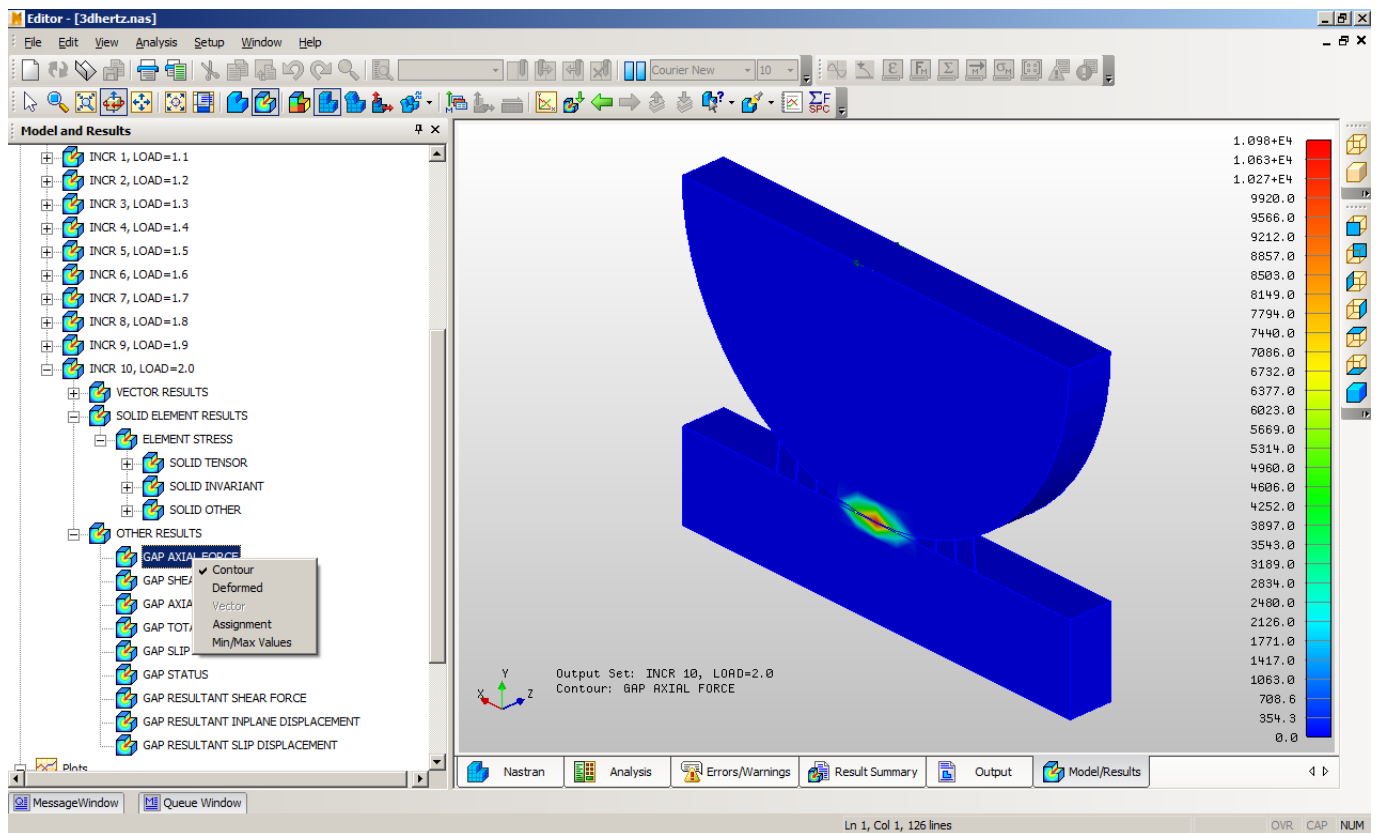

Figure 21– Displaying Contact Results

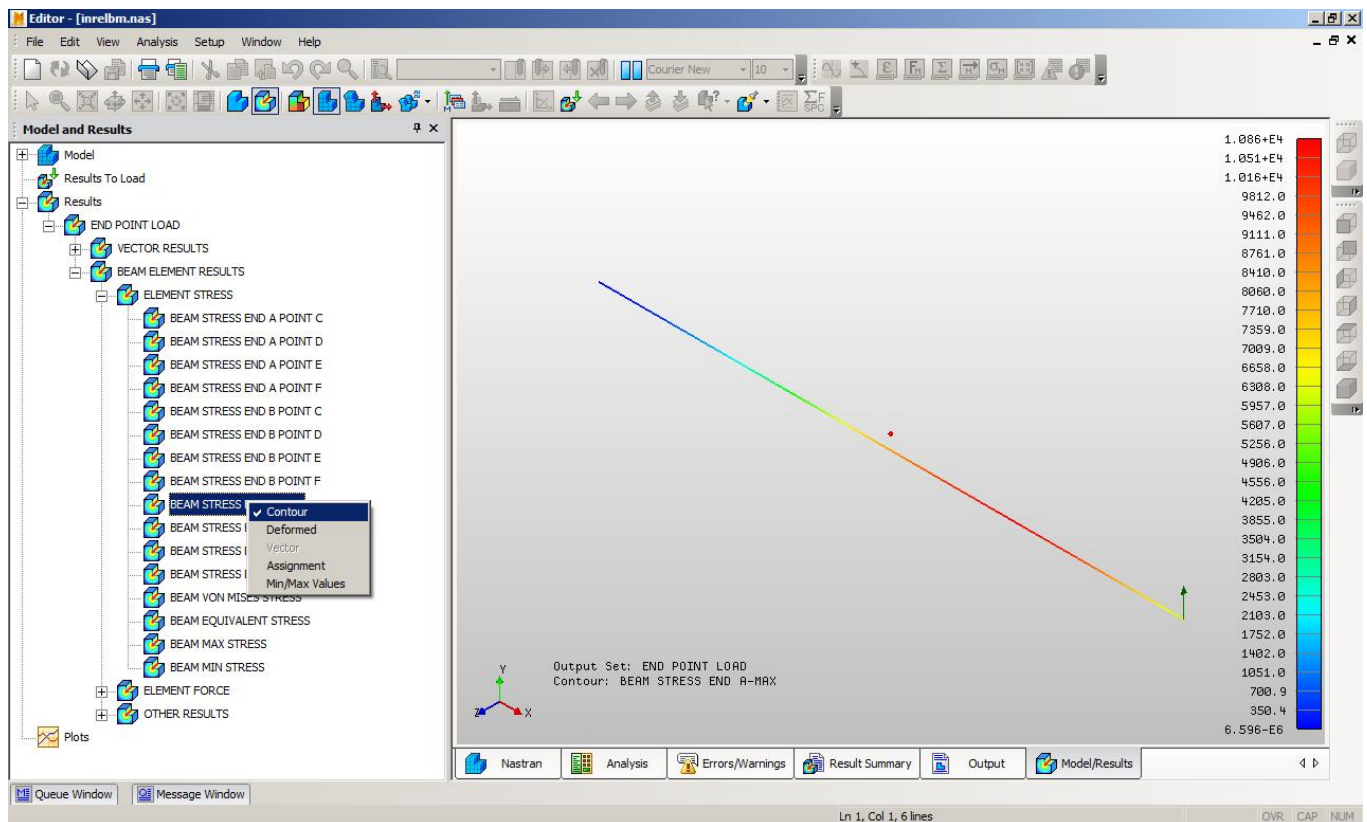

Figure 22 – Displaying Beam Element Results

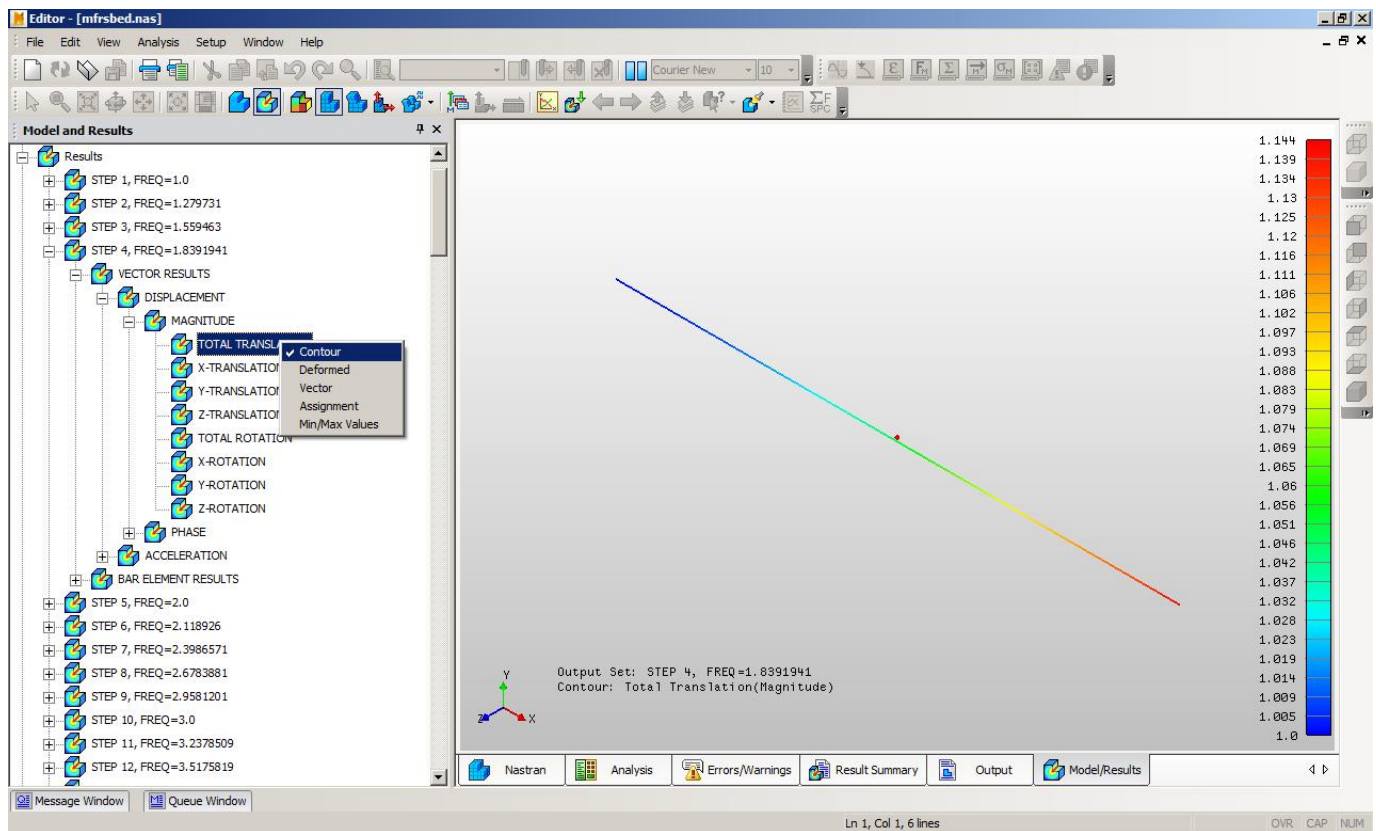

Figure 23 – Displaying Complex Results

### 2.6.2 Display of Composite Results

When working with composites shells, the user can move from ply to ply by using the **ply-up** or **ply-down** buttons as shown in Figure 24. Once a ply contour is chosen (Figure 25) the user can easily view the same contour results for the next ply(s) by selecting the ply-down (or ply-up) buttons.

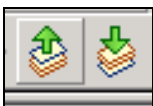

Figure 24 – Ply Output Scroll Buttons

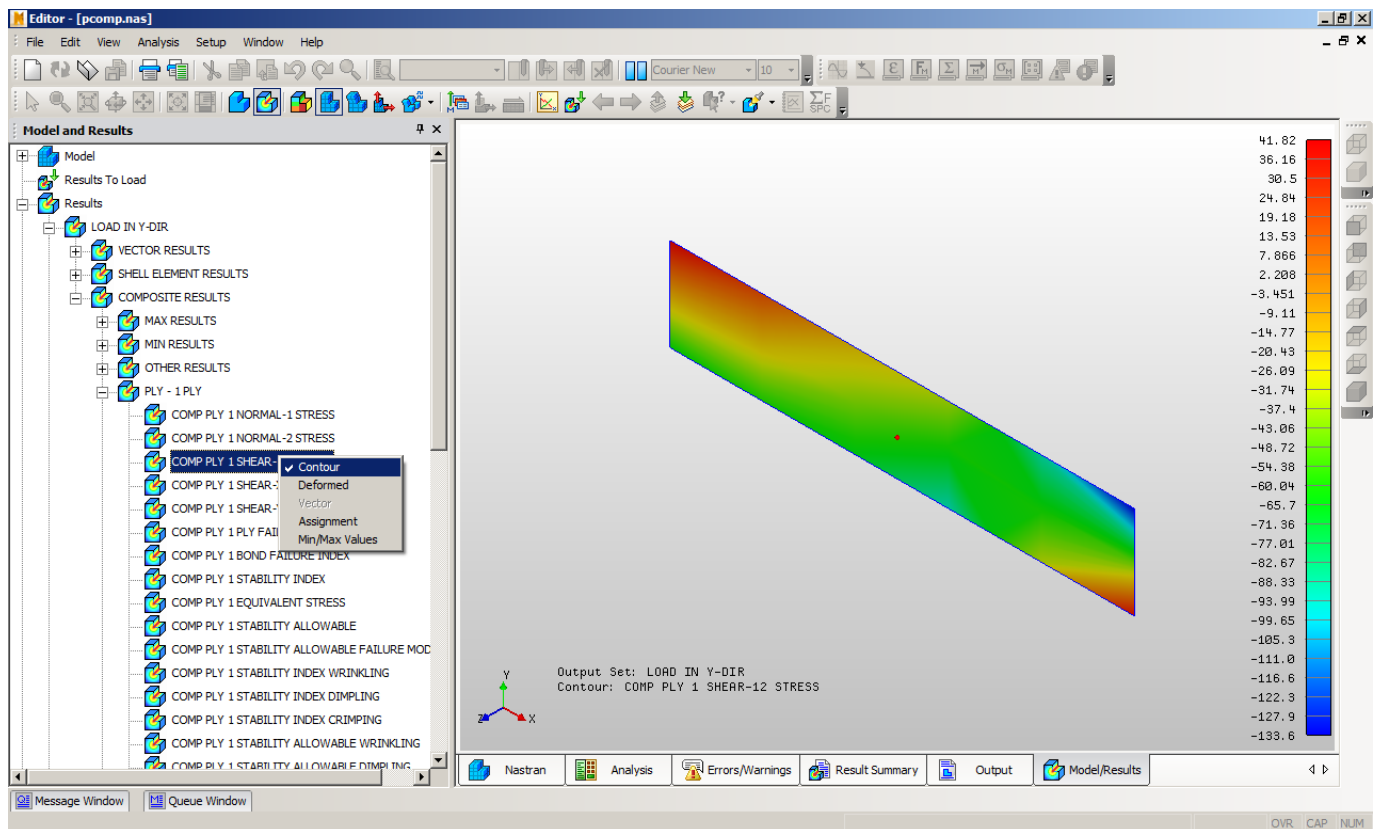

Figure 25 – Displaying Ply Results with Composite Shells

### 2.6.3 Using Dynamic Query

Dynamic query allows real-time interrogation of nodes and elements in the model. To access this feature, left-click on the down arrow in the graphics toolbar as seen below in Figure 26. You can choose to query nodes or elements (via property or material). 3D Query allows you to use the keyboard left and right arrows to drill down in the view's z-axis. Figure 27 shows an example of the data that is shown by using this query tool.

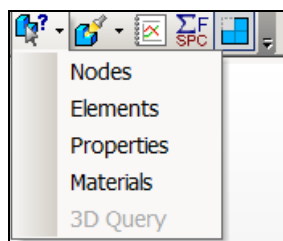

Figure 26 – Dynamic Query

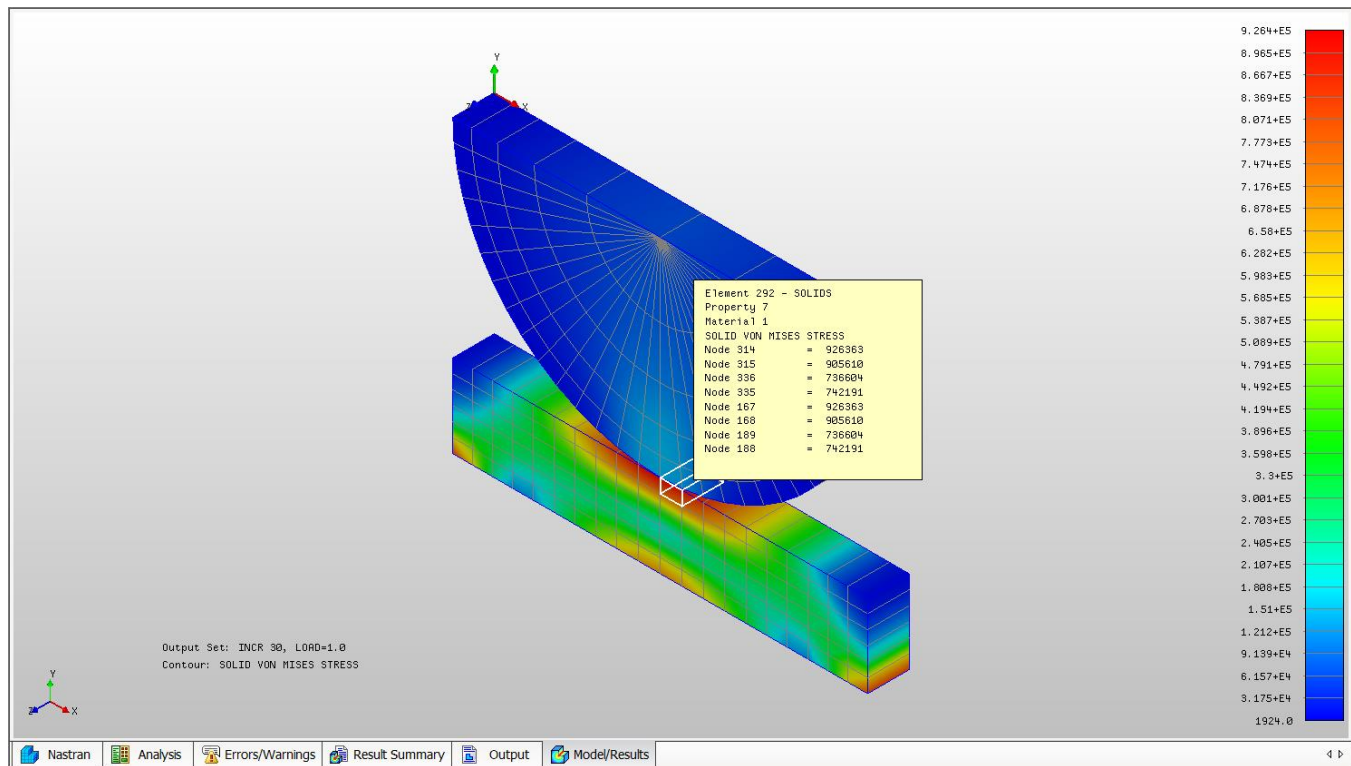

Figure 27 – Dynamic Query Popup Box

### 2.6.4 Using the Highlight Option

The highlight option on the graphics toolbar allows a set of nodes or elements to highlight on the model, in order for the user to identify their location and or properties. See Figure 28 below. Type in the Element or Node IDs in the **Entity List** and click **Add** to put them in the **Selected Entities** box as shown in Figure 29.

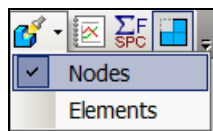

Figure 28 – Dynamic Query

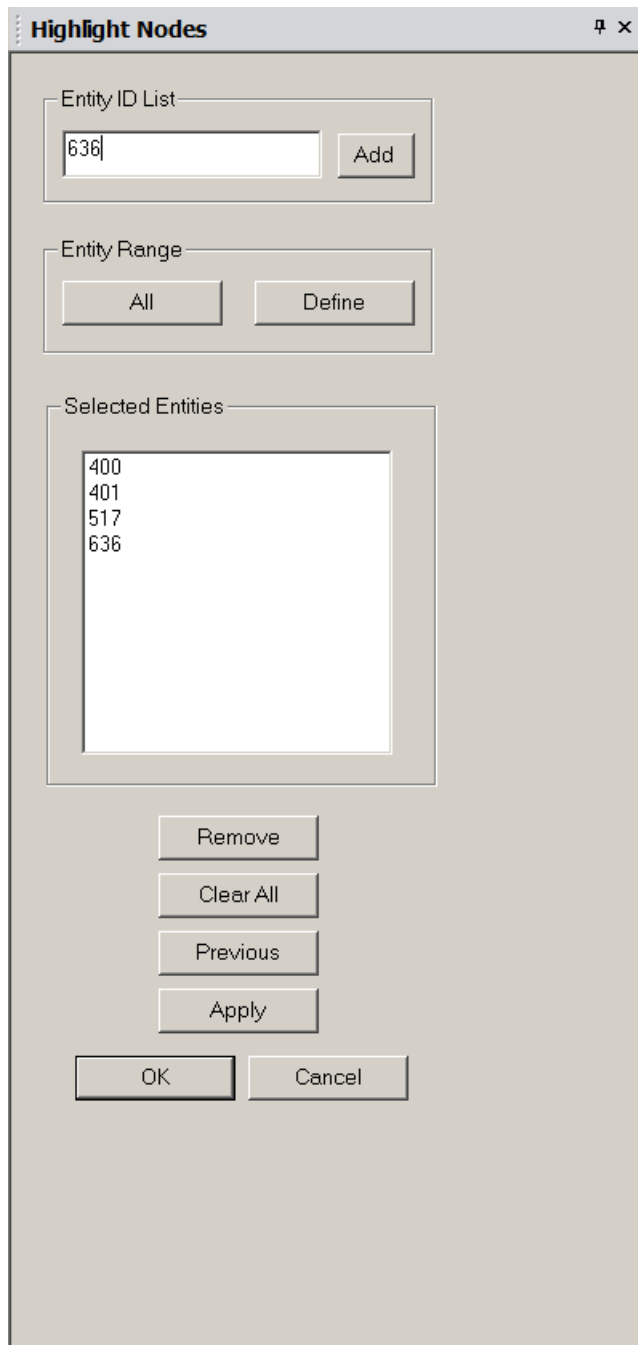

Figure 29 – Highlight Entity Selection

### 2.6.5 Animation Setup

Animations are setup using the animation icon in the graphics toolbar as seen in Figure 30. Left-click on the down arrow and select the Animation Setup option. A form as shown in Figure 31 will appear and allow for both single set and multi set animations (when multiple output results exist). For multi set animations **Number of Frames** controls how many frames will be used. The Editor will automatically interpolate between result sets, so a value for number of frames can be used that is higher than the number of increments selected. After selecting the options in the Animation Settings, you can cycle the animation on/off by clicking on the main animation icon.

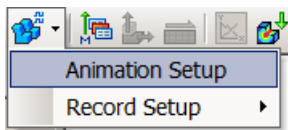

Figure 30 – Animation Setup

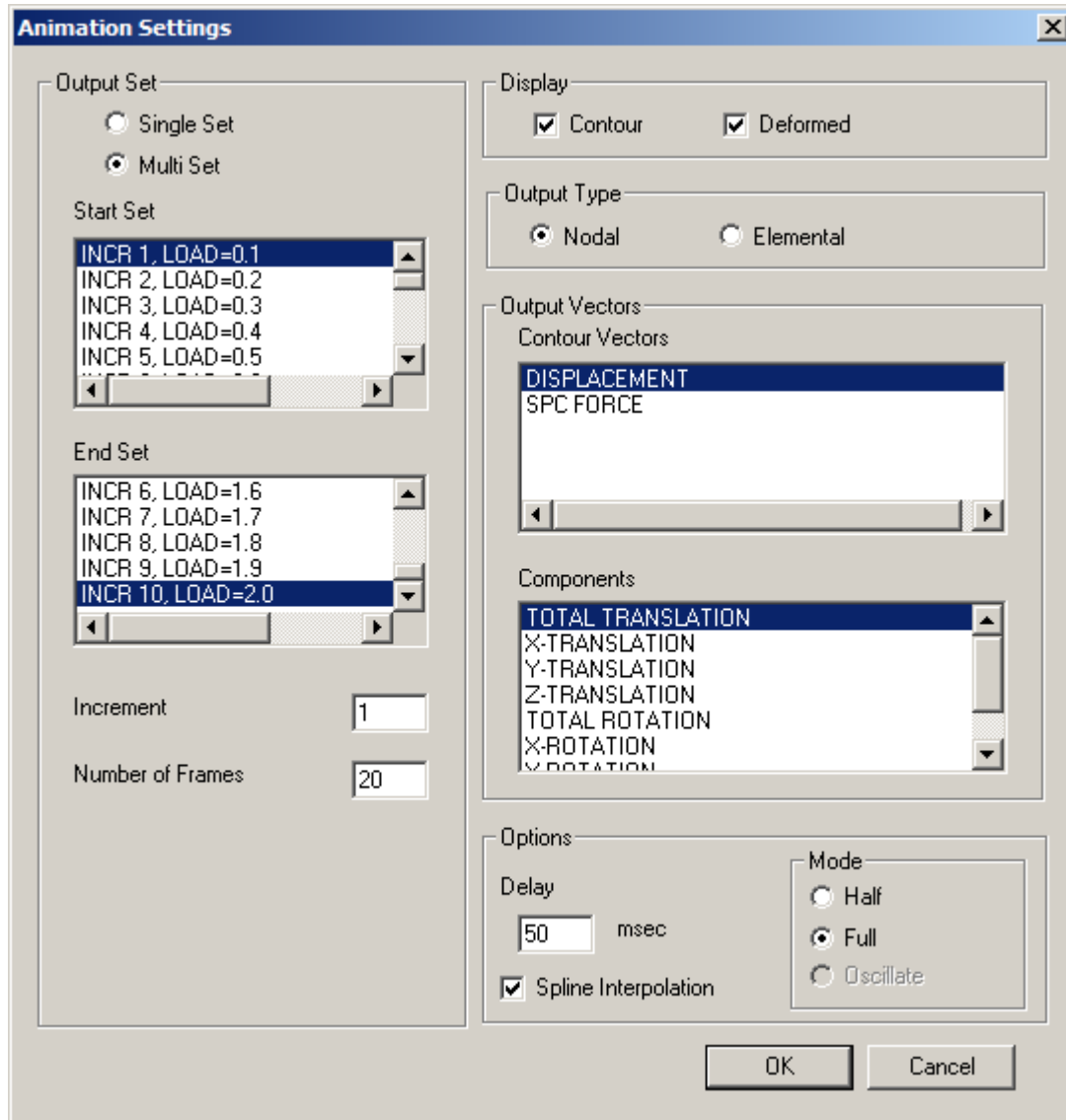

Figure 31 – Animation Settings

### 2.6.6 Results Limits

The results limits feature is generally used for linear static analysis with multiple subcases. It allows the user to define a range of subcases, and the Editor will plot the highest stress (or other vector) on an element-by-element basis. It will essentially show you a ‘worst case’ scenario of the highest stresses on the model based upon the highest results from all the subcases. The results limits feature can be accessed by the toolbar icon shown in Figure 32. After clicking on the toolbar icon, the Results Limits window will appear as in Figure 33. The **Critical Value Threshold** allows you to see how many elements (in percent) in the ‘critical’ subcase are over the value input (as shown in Figure 34).



The **Factor Threshold** option allows the user to pick a scale factor of the peak stress from all subcases (for instance if the peak stress was 1000, choosing a factor of 0.3 would set the threshold value to 300). The **Mode** area allows the user to define if the Max, Min, or Absolute Max/Min should be used to evaluate the **Threshold** value.



Figure 32 – Results Limits Toolbar Icon

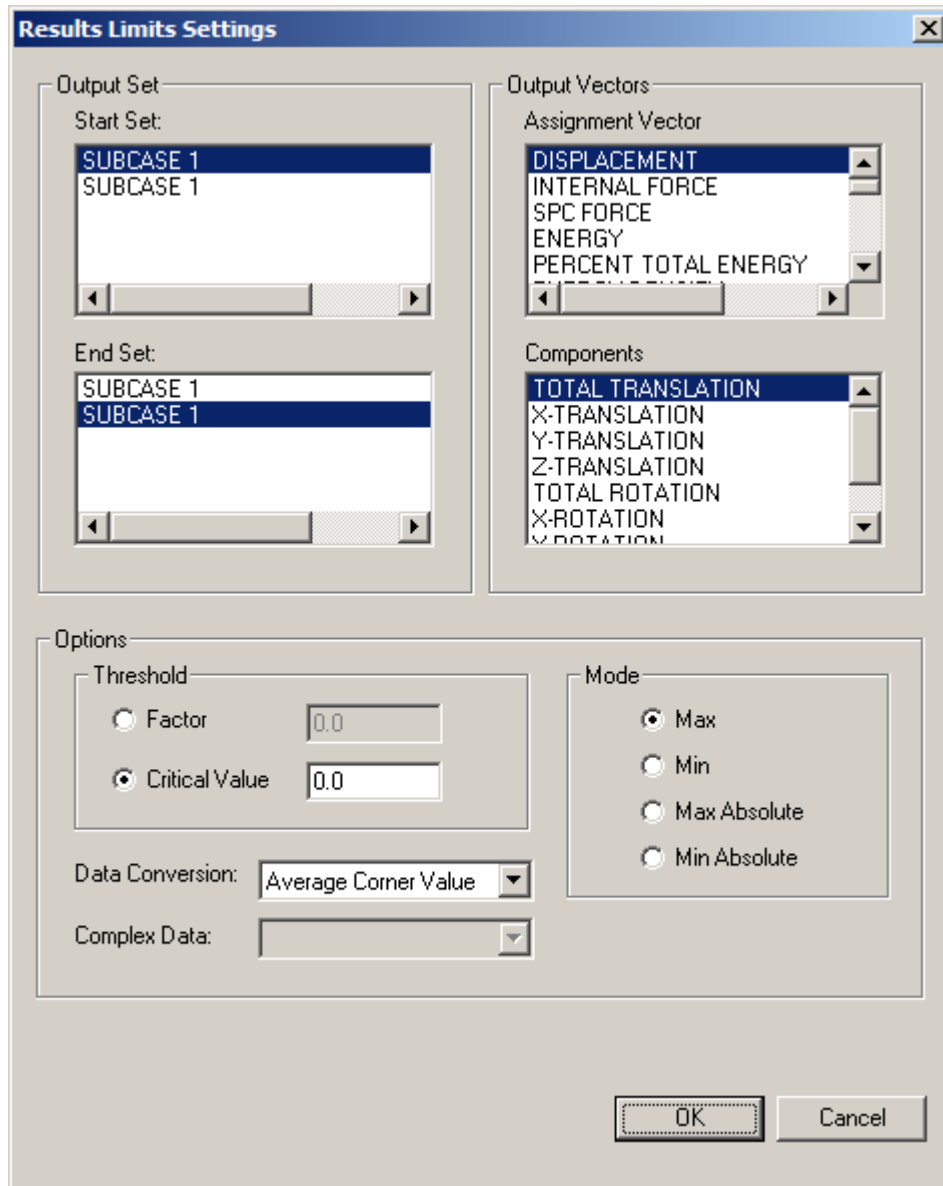

Figure 33 – Results Limits Settings



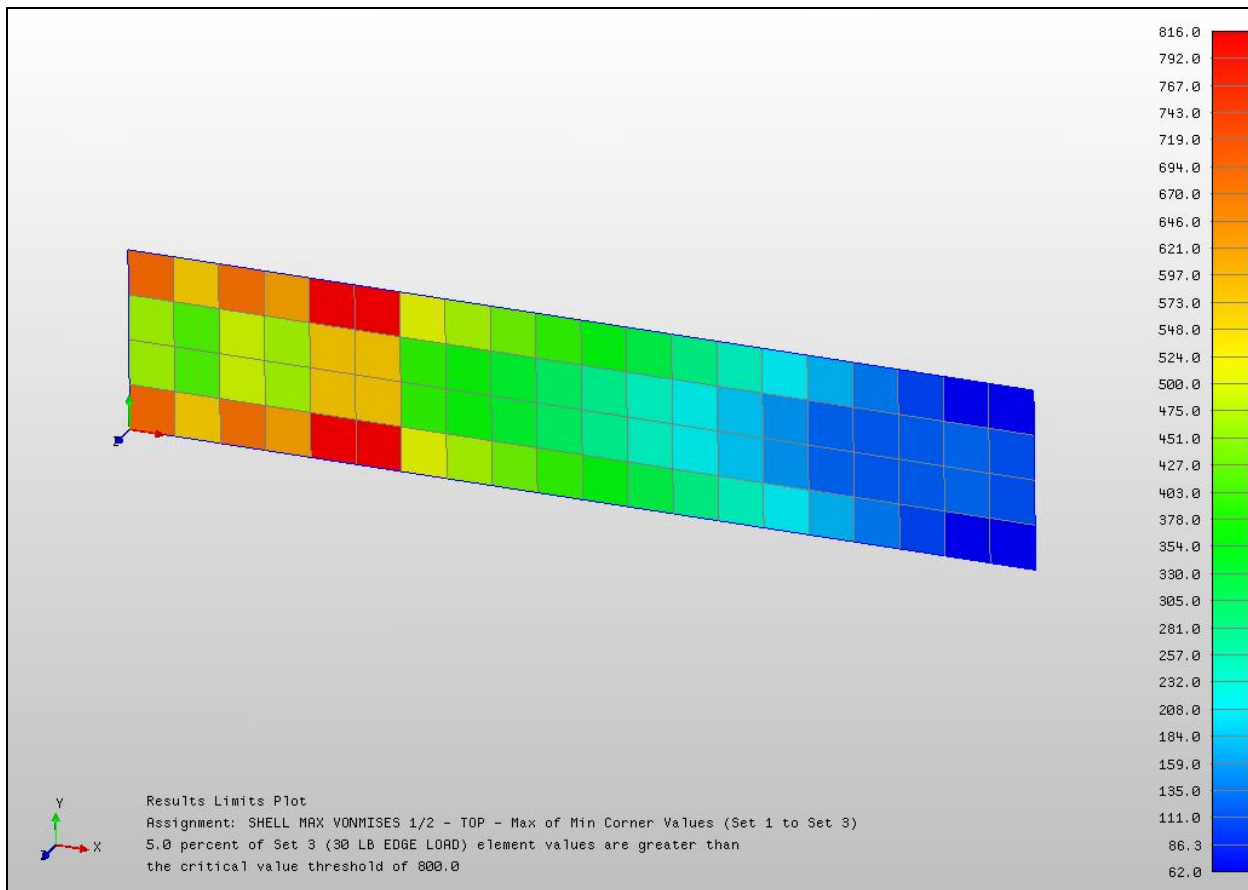

Figure 34 – Results Limits View

### 3 Customizing Analysis Options

Analysis options displayed in the Analysis Options view enables you to view/change all Autodesk Inventor Nastran model initialization directives or model parameters. The option categories can be expanded by clicking the “+” sign and collapsed by clicking the “-” sign. A dialog box will appear by double-clicking the option of interest enabling you to customize that particular option.

#### 3.1 Integer Options

The directive label is shown in the dialog title bar (see Figure 35). The directive’s minimum and maximum are displayed at the bottom of the Analysis Options dialog box and the values are restricted to these limits.

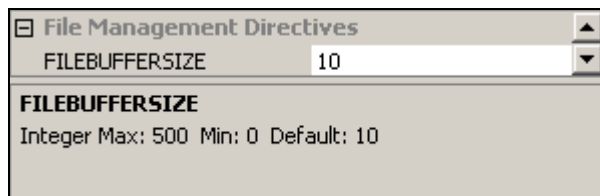

Figure 35 – Example of an Integer Option

#### 3.2 Real Options

All real directives and parameters are edited using this dialog box, which can be seen in Figure 36.

The directive label is shown in the dialog title bar. The directive’s minimum and maximum are displayed and the values are restricted to these limits. A decimal point will be automatically added if omitted.

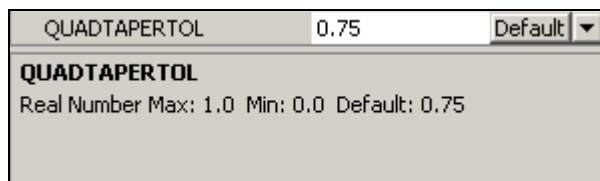

Figure 36 – Example of a Real Option

**Note:** Certain options such as **K6ROT** will have a check-box for the **AUTO** setting, as shown below in Figure 37:

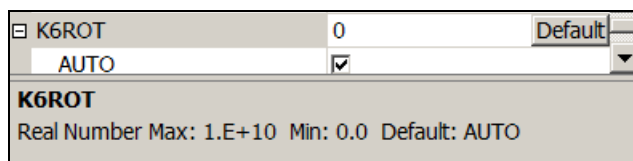

Figure 37 – Example of an Option Containing an Auto Check-box

### 3.3 File Options

All file directives are edited using this dialog box (Figure 38). When editing multiple file directives, the previously selected folder is set as the default.

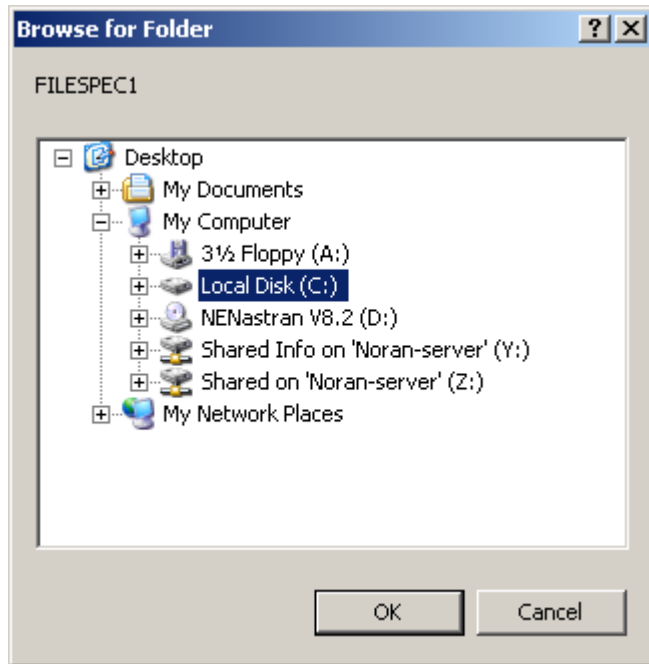

Figure 38 – Example of a File Option

### 3.4 String Options

The String Options dialog box is displayed by clicking on the drop-down menu next to the directive label. All string directives and parameters are edited using this dialog box.

The directive label is shown in the dialog title bar (see Figure 39).

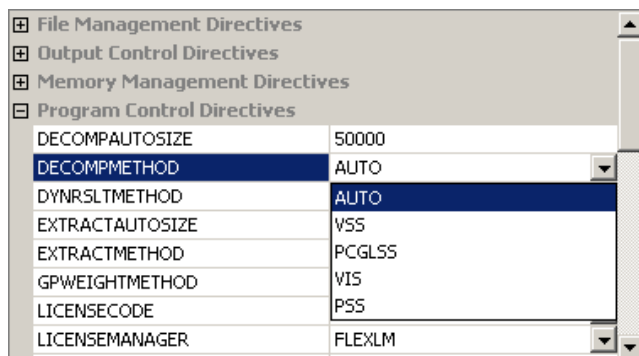

Figure 39 – Example of a String Option

## 4 Menus

This section discusses the various drop-down menus available in the Autodesk Inventor Nastran Editor.

### 4.1 File Menu

The File menu contains typical windows file menu commands as shown in Figure 40.

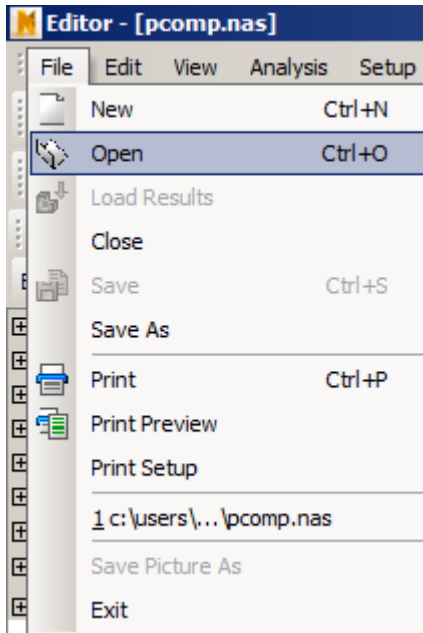

**Figure 40 – File Menu**

### 4.2 Edit Menu

The Edit menu contains typical Windows' edit menu commands as shown in Figure 41.

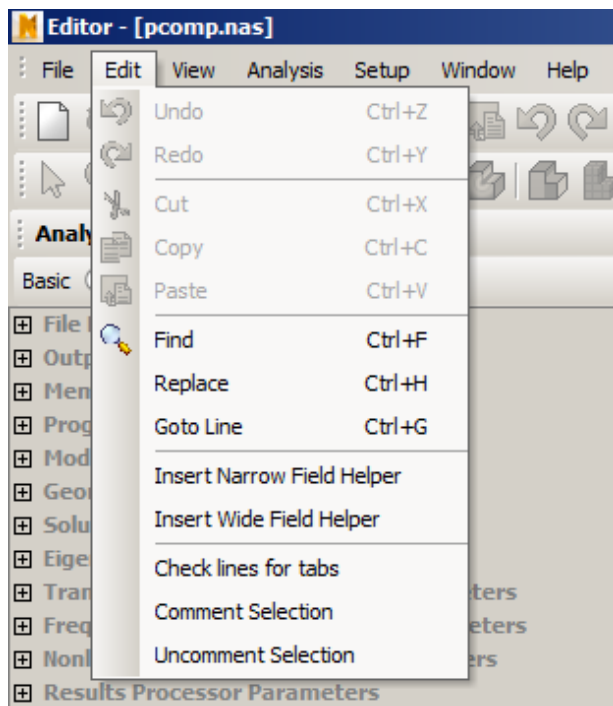

Figure 41 – Edit Menu

### 4.3 View Menu

The View menu shown in Figure 42 controls the displaying of toolbars, windows, and field markers. The **Field Marker (Narrow)** and **Field Marker (Wide)** menu items control the displaying of field markers in the Nastran view. The **Clear Messages** menu item clears the message window.

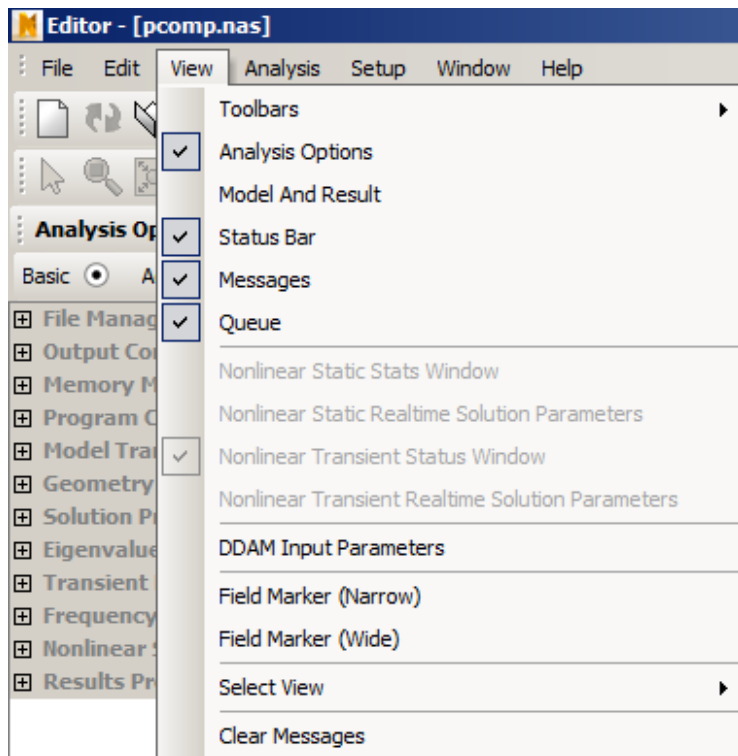

Figure 42 – View Menu

### 4.4 Analysis Menu

The Analysis menu is shown in Figure 43 and it controls analysis operations such as generating intermediate results from nonlinear analysis. The **Nonlinear Options** allows Autodesk Inventor Nastran to generate and display intermediate results during the analysis. These options must be turned ON before the analysis is started. The **Purge** menu item deletes all .DAT and .TMP files (analysis database storage files) in the folders specified by **FILESPEC1**, **FILESPEC2**, **FILESPEC3** and **FILESPEC4**. The **Reset Options** menu item reinitializes the job specific .INI file to the values in the global Nastran.INI file. The **Custom Plots** menu will plot the output of user defined nodes for nonlinear and transient analyses. The **Generate Report** menu item will invoke the automatic report generator.

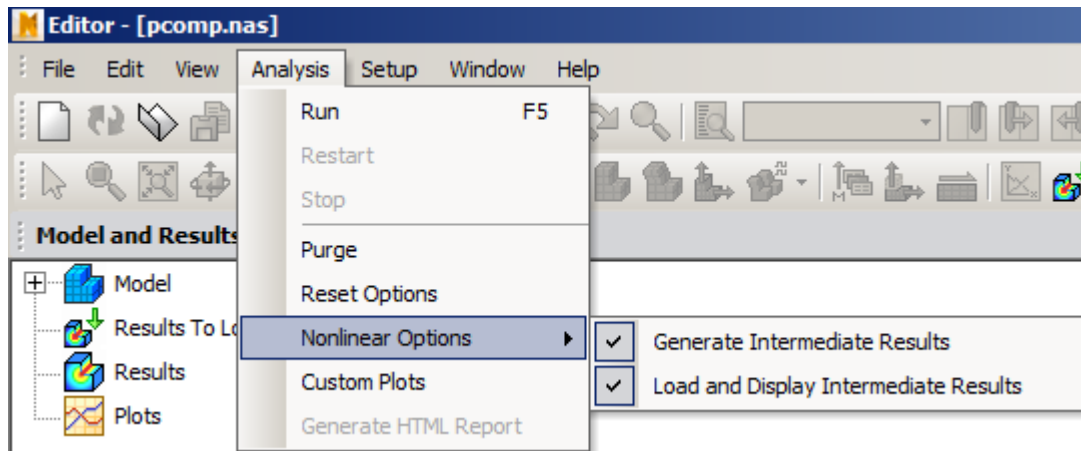

Figure 43 – Analysis Menu

### 4.5 Setup Menu

The Setup menu shown in Figure 44 contains **Default Settings** and **Default Analysis Options** menu items. The **Default Settings** menu allows you to control Editor launch behavior, and control specific Editor operations. The **Default Analysis Options** define the model initialization directives and model parameters that are associated with a new Model Input File when it is initially opened.

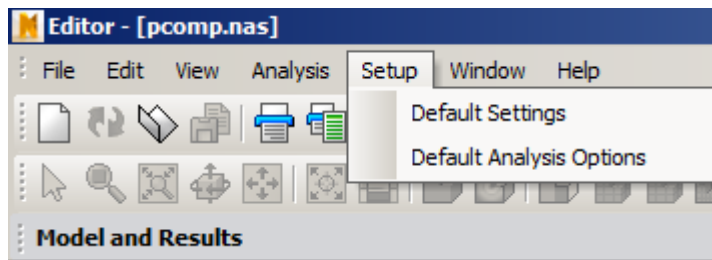

Figure 44 – Setup Menu

### 4.5.1 Default Settings – General

The **General** options are shown in Figure 45 and set the following preferences:

- The **Prompt to load ASCII input/output files over** box controls whether the Model Results Input/Output Files are loaded automatically. Input (.NAS) and Output files larger than the threshold value specified will not open automatically.
- The **Close files before running analysis** check-box controls whether the Model Input File is left loaded in memory while the analysis is run. When this box is checked the Model Input File is unloaded before the analysis is run releasing memory for Autodesk Inventor Nastran to use during the analysis.
- The **Beep when analysis is finished** check-box controls the analysis complete tone that is made when an analysis has finished.
- The **Enable file indexing** check-box controls whether bookmarks are automatically generated for warnings and errors. Note that this can slow down the Editor's performance when running large models with a large number of errors or warnings.
- The **Communication Method** section sets the communication method between the Editor and Autodesk Inventor Nastran during an analysis. The **Use Sockets** method uses the network interface (TCP/IP). The Editor chooses the first available TCP/IP port above 1024. While using this communication method you may receive a warning message if personal firewall software is set up on your computer. These messages can be safely ignored. The **Use pipes** method pipes the Autodesk Inventor Nastran status output into the input of the Editor.
- The **Analysis Priority** slider bar controls the priority of the solver when running an analysis. Setting this to low can greatly improve computer usability when multitasking, with a small increase in solution time.
- Note that the original default General Settings can be reset with the **Reset Defaults** button.

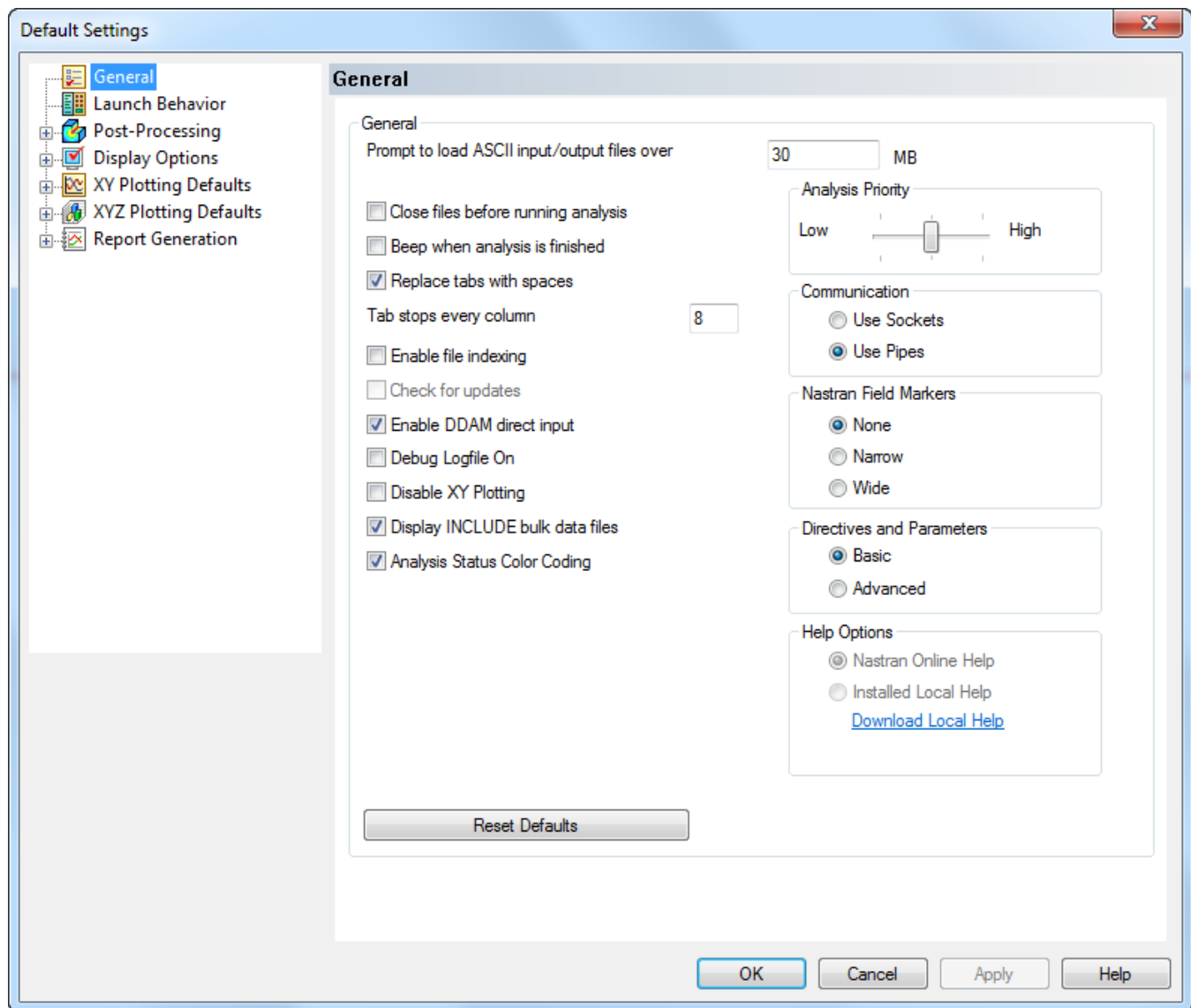

Figure 45 – Default Settings, General Form



#### 4.5.2 Default Settings – Launch Behavior

The Launch Behavior window is shown in Figure 46 and it determines what actions the Editor will take when a model input filename is specified on the Editor command line. The various options function as follows:

- When **Open model input file (.NAS)** box is checked, the Editor will open the input file supplied on the command line. When the box is unchecked the file will not be opened.
- When the **Run analysis** box is checked, the Editor will start the analysis automatically. This prevents you from changing any options for the analysis. When the box is unchecked, the analysis is not started automatically allowing you to modify the input file or change any analysis options you desire.
- The **When the analysis is finished...** section determines whether or not the Editor will exit upon completion. When **Exit the editor** is selected, the Editor will close and control will be returned back to the calling application (usually a pre/post-processor) when the **Continue** button is pressed in the Termination Status window. When **Don't exit** is selected, you can make changes to the model and re-run it if desired. Closing the Editor returns control to the calling application.
- Note that the original default Launch Behavior can be reset with the **Reset Defaults** button.

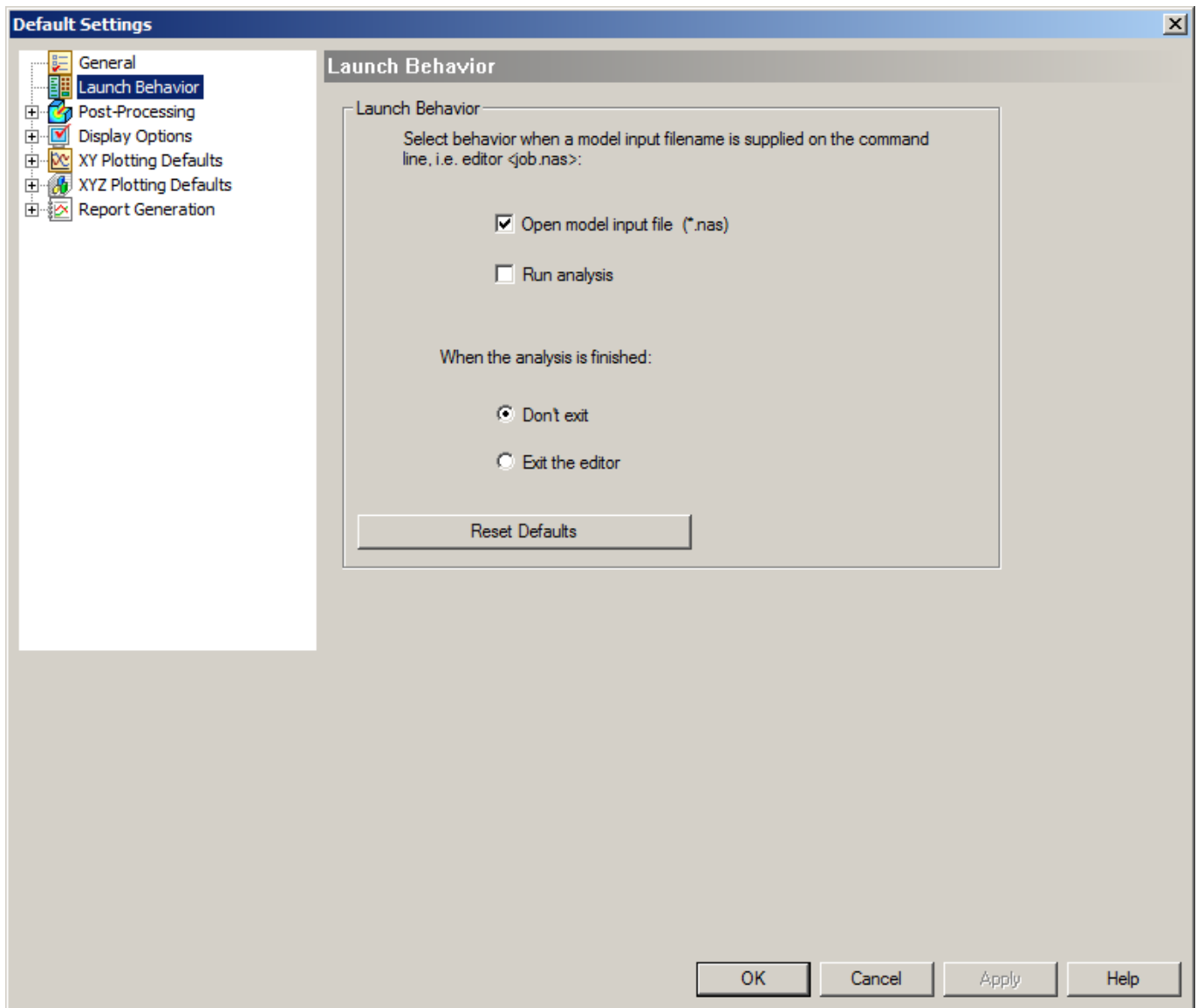

Figure 46 – Default Settings, Launch Behavior

### 4.5.3 Default Settings – Post Processing

The Post-Processing window is shown in Figure 47 and it determines the defaults for Post-Processing. The Animation Default Settings allow the default number of frames and delay to be set. The original default Post-Processing settings can be reset with the **Reset Defaults** button.

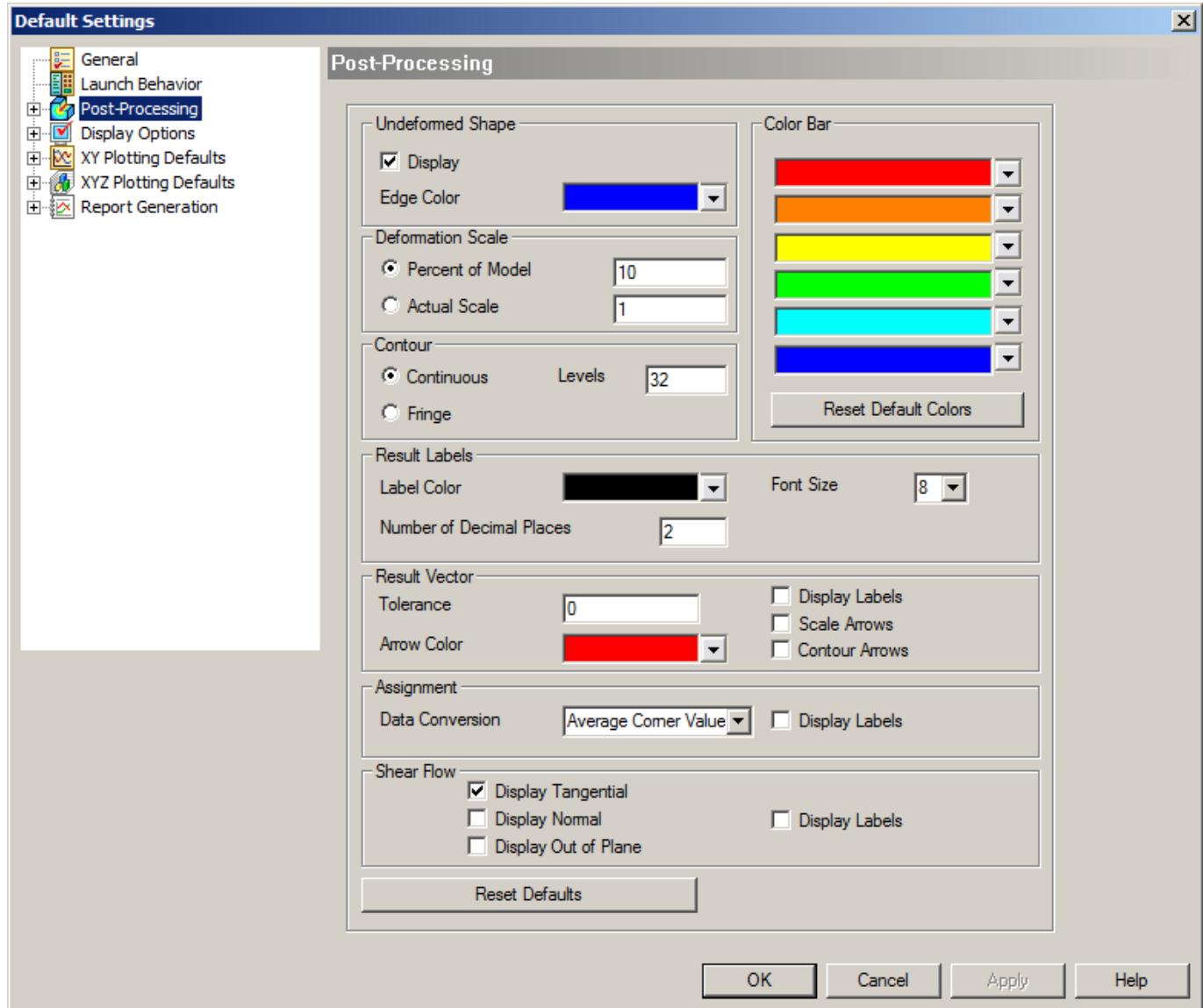

Figure 47 – Default Settings, Post-Processing

Dynamic plots are automatically generated during nonlinear static analysis when the options “Nonlinear Options/Generate Intermediate Results” and “Nonlinear Options/Load and Display Intermediate Results” are checked as shown in Figure 48.

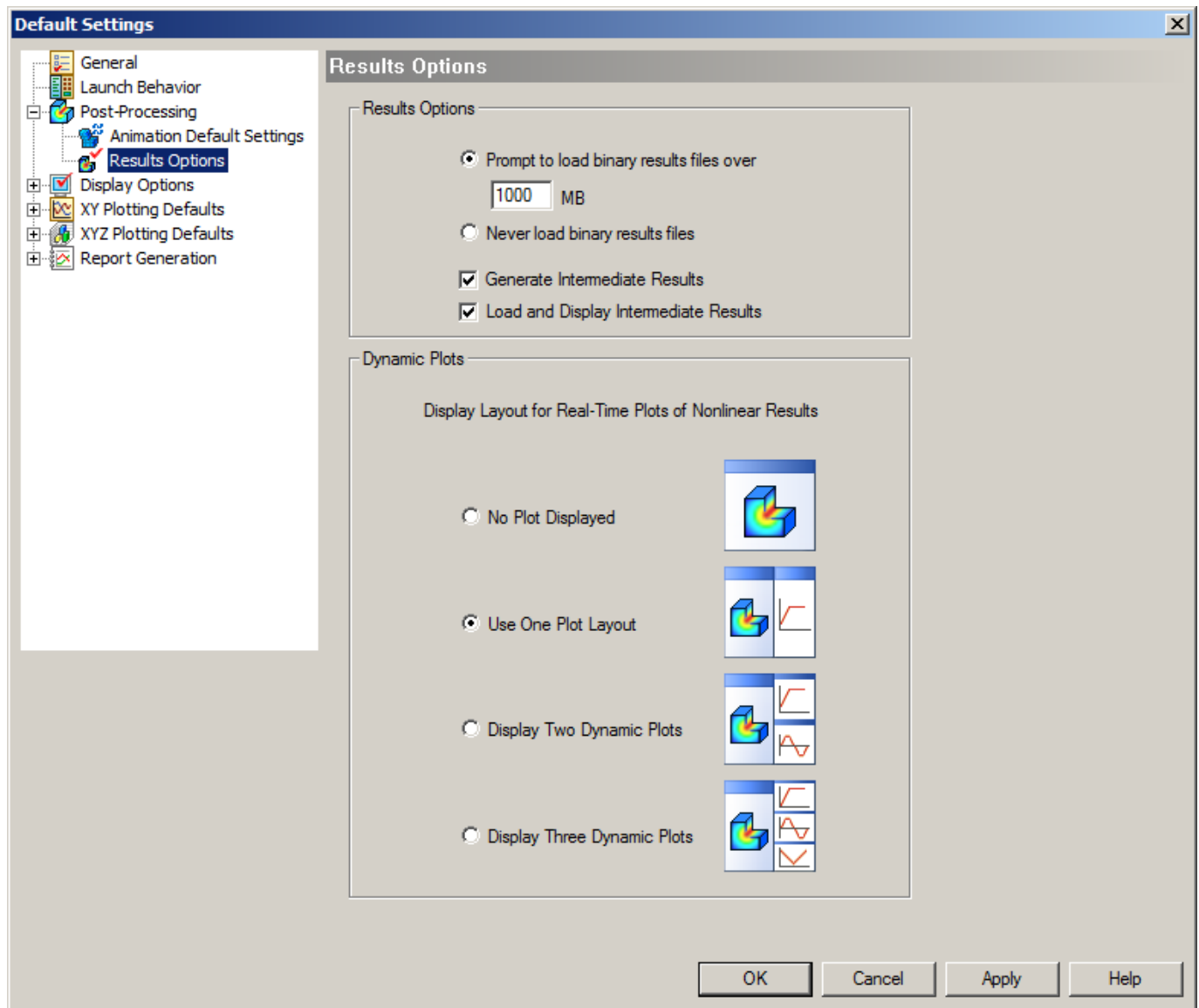

Figure 48 – Default Settings, Results Options

### 4.5.4 Default Settings – Display Options

The Display Options window is shown in Figure 4949 and it determines what entities will be shown in the Model/Results tab. The sub-branches under display options allow specific entities to be defaulted to on/off as well as their labels and colors. The original Display Option defaults can be reset with the **Reset Defaults** button.

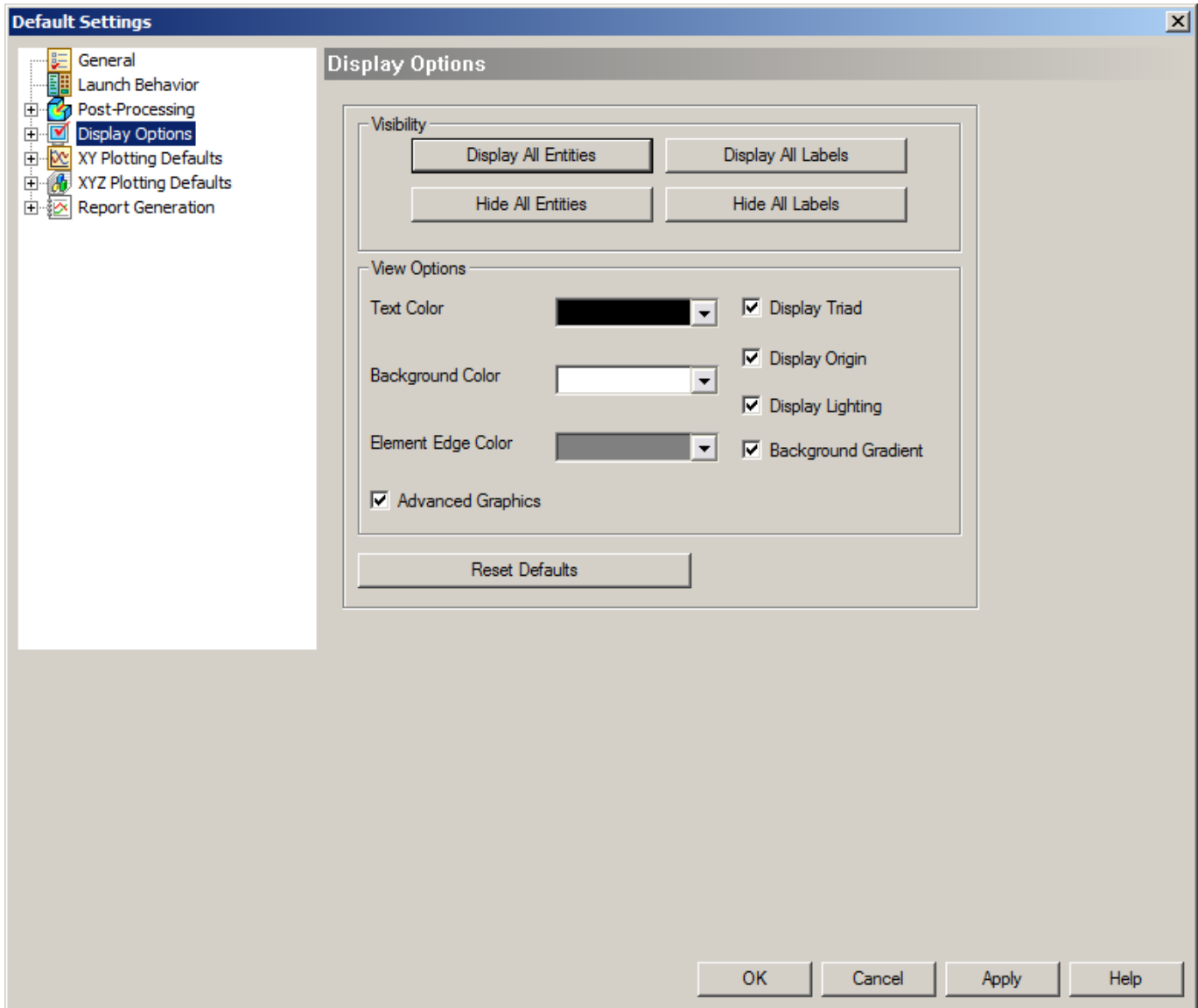

Figure 49 – Default Settings, Display Options

The Load window (Figure 500) sets up a load type and displays a load symbol at the bottom right-hand corner of the Model/Results window. The gravity load symbol is added when the GRAV card is included in the analysis as shown in Figure 51.

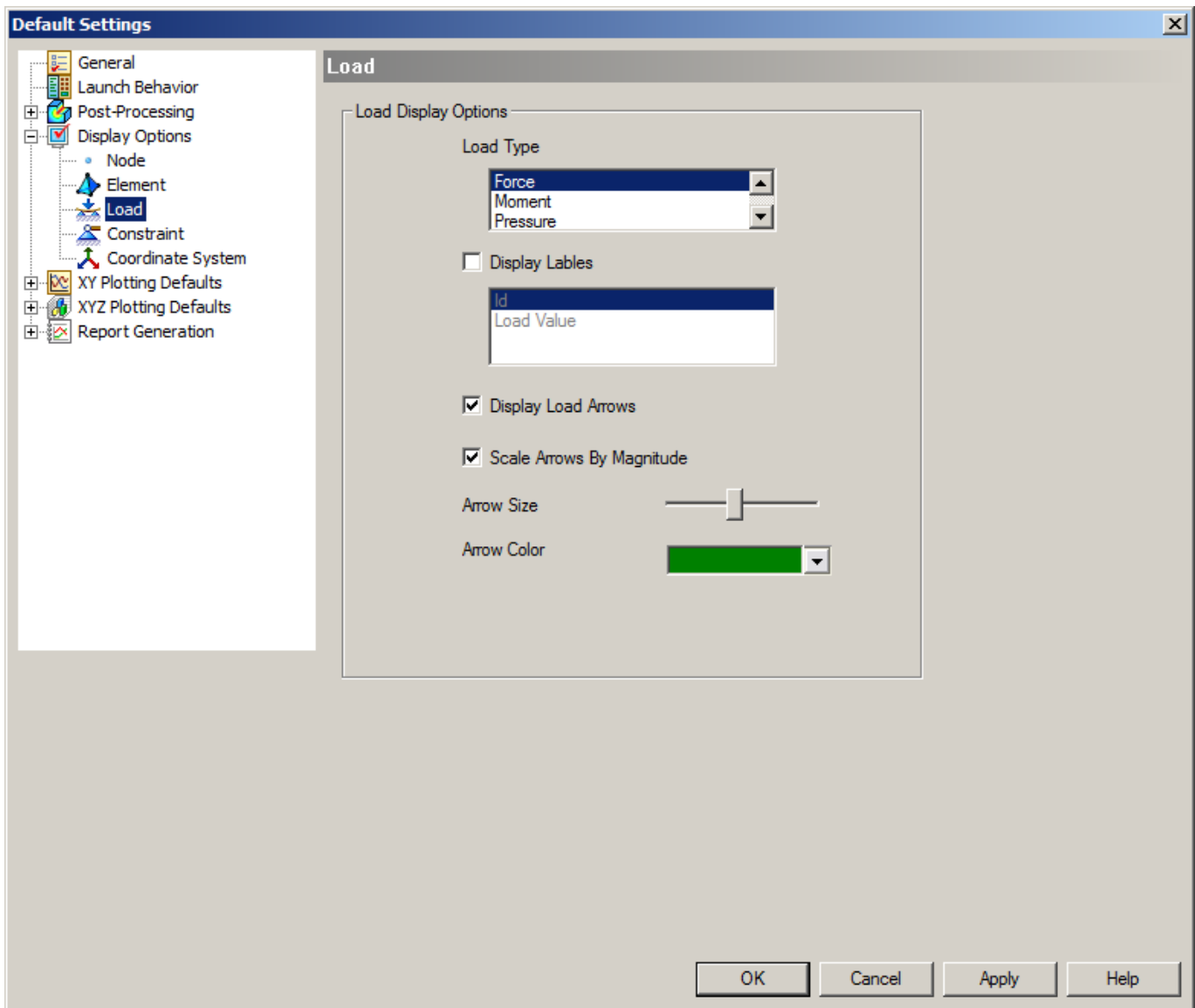

Figure 50 – Default Settings, Load

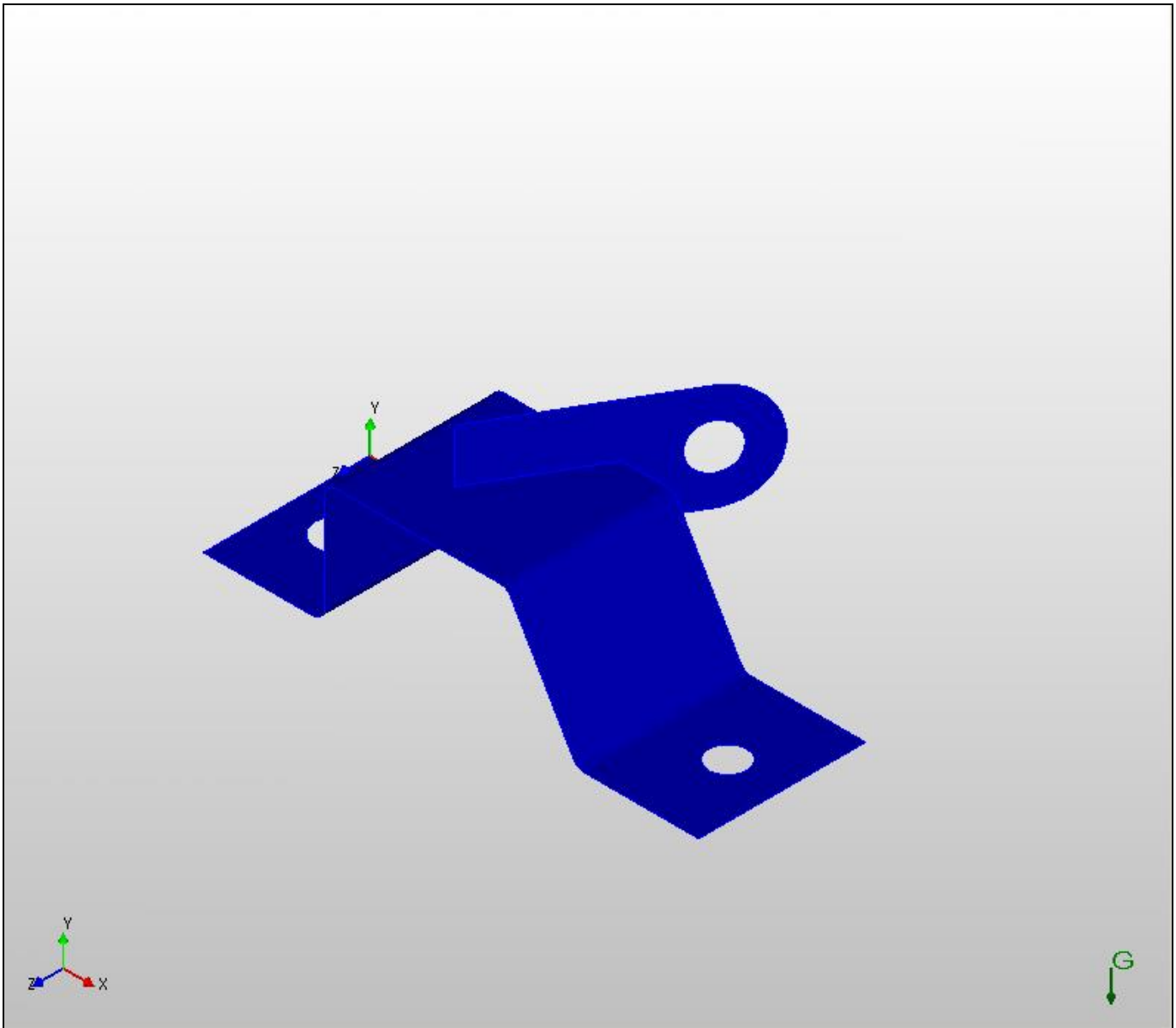

Figure 51 – Gravity Load Symbol and Arrow

Markers for maximum and minimum values on contour plots are set to transparent to view the model at all times as shown in Figure 52. The labels can be toggled on or off using the graphics view popup menu.

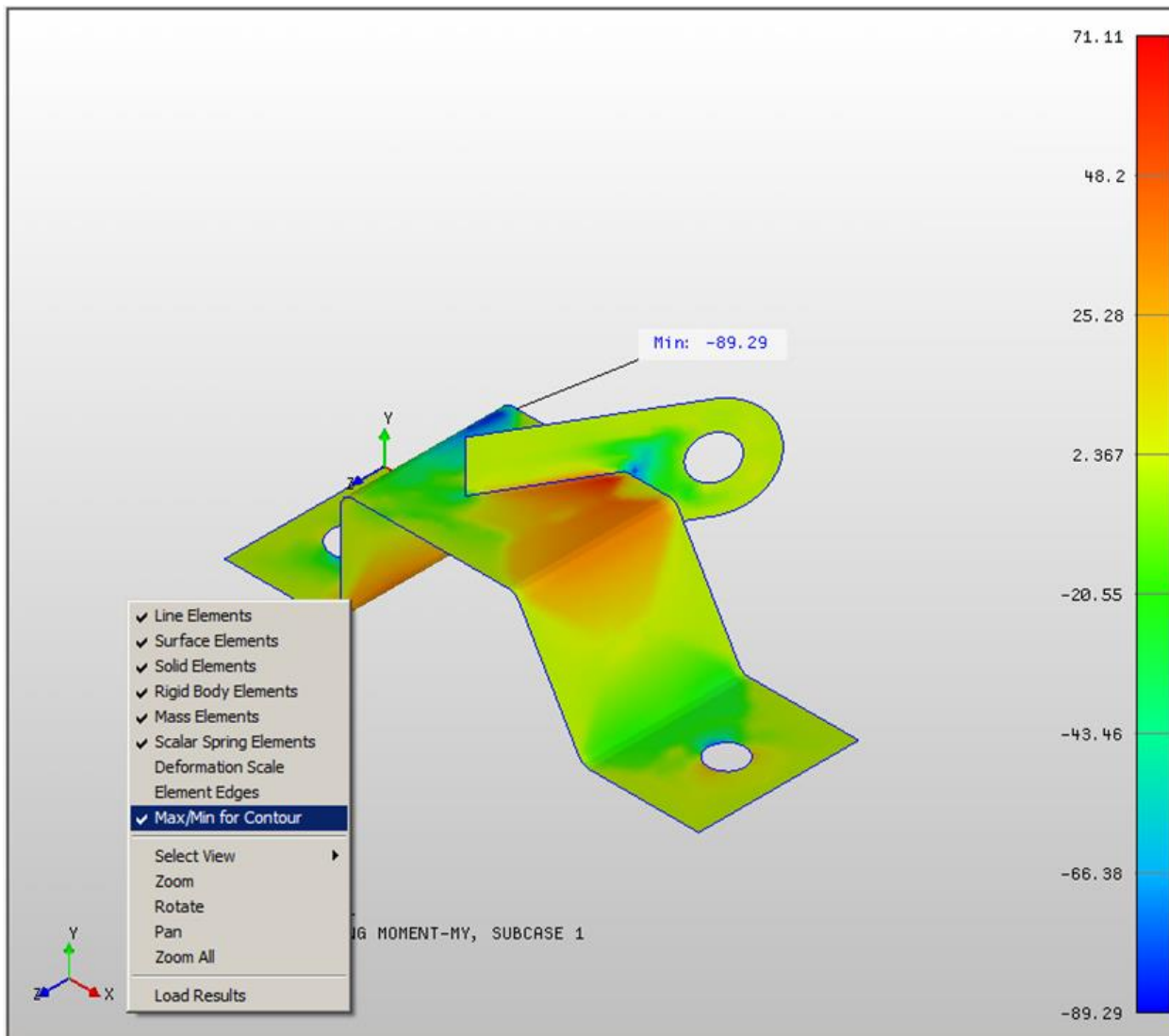

Figure 52 – Max/Min for Contour



### 4.5.5 Default Settings – XY Plotting Defaults

The XY Plotting Defaults window is shown in Figure 53 and determines the default plotting options for XY plots. The sub-branches under XY Plotting Defaults allow for different plotting styles depending upon the analysis type. The original settings for XY plots can be reset with the **Reset All XY Plot Defaults** button.

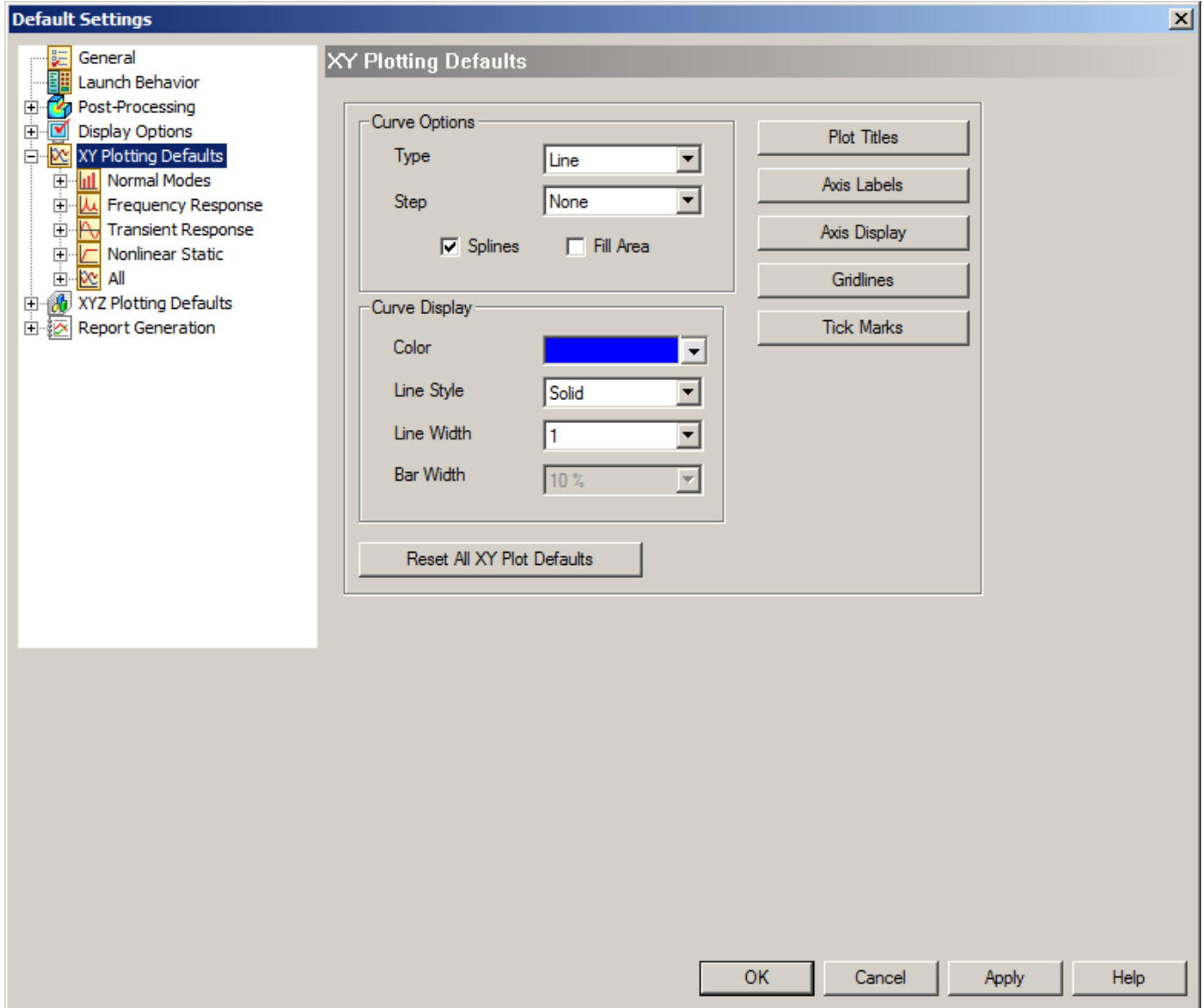

Figure 53 – Default Settings, XY Plotting Defaults

### 4.5.6 Default Settings – XYZ Plotting Defaults

The XYZ Plotting Defaults window is shown in Figure 54 and determines the default plotting options for 3-d XYZ plots. 3-d plotting is used to display MAC (Modal Assurance Criteria) and Mass Cross-Orthogonality Matrix plots. These settings also apply to Rainflow and Damage matrices. The original settings for XYZ plotting can be reset with the **Reset All XYZ Plot Defaults** button.

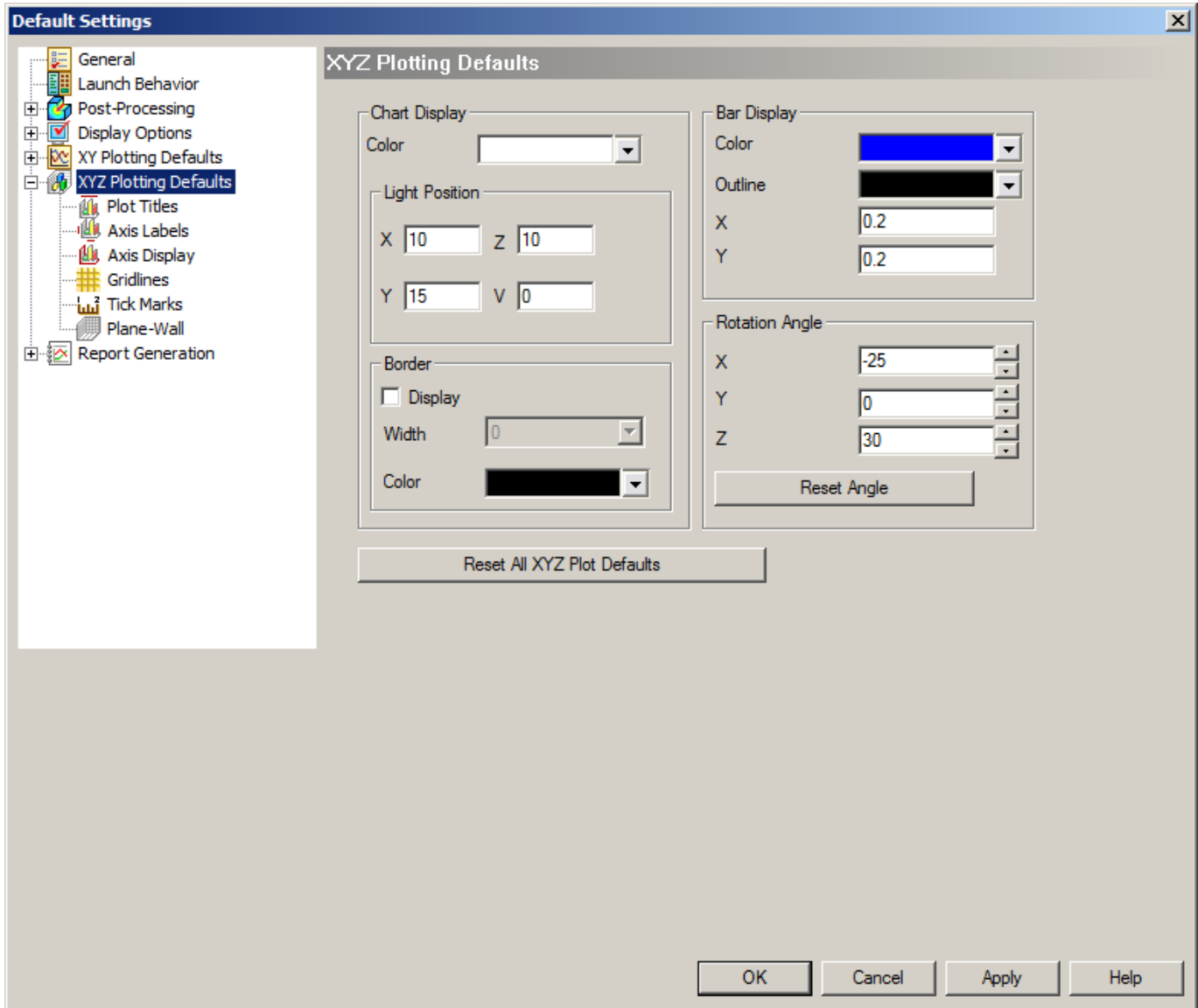

Figure 54 – Default Settings, XYZ Plotting Defaults

### 4.5.7 Default Settings – Report Generation

The Report Generation window is shown in Figure 55 and determines the default report format when running the report generator. In order to use the report generator the **Enable Report Writer** check box must be checked before the analysis is performed. Currently, only linear static analysis is supported for the report generator.

The sub-branches allow you to setup default image views and output vectors that you want included in the report. Figure 566 shows the options for the summary section of the report. An icon appears to the right of the **Capture Image 1 Settings** box showing the default image style that is being used. To change the settings, first orient the model and turn on/off the entities desired and then go into the Default Settings – Report Generation window and click on the **Capture Image 1 Settings** box to save the current view settings.

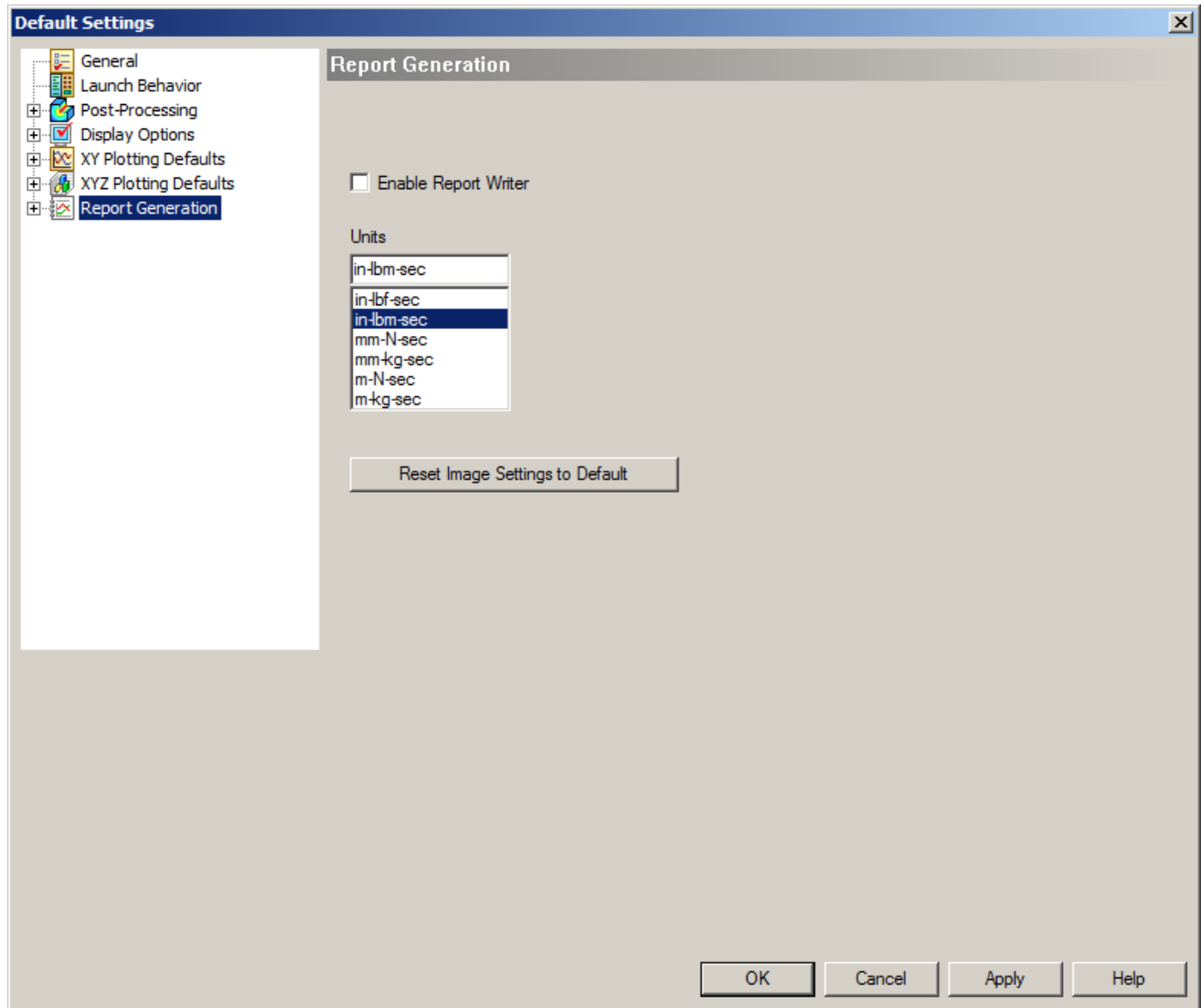

Figure 55 – Default Settings, Report Generation

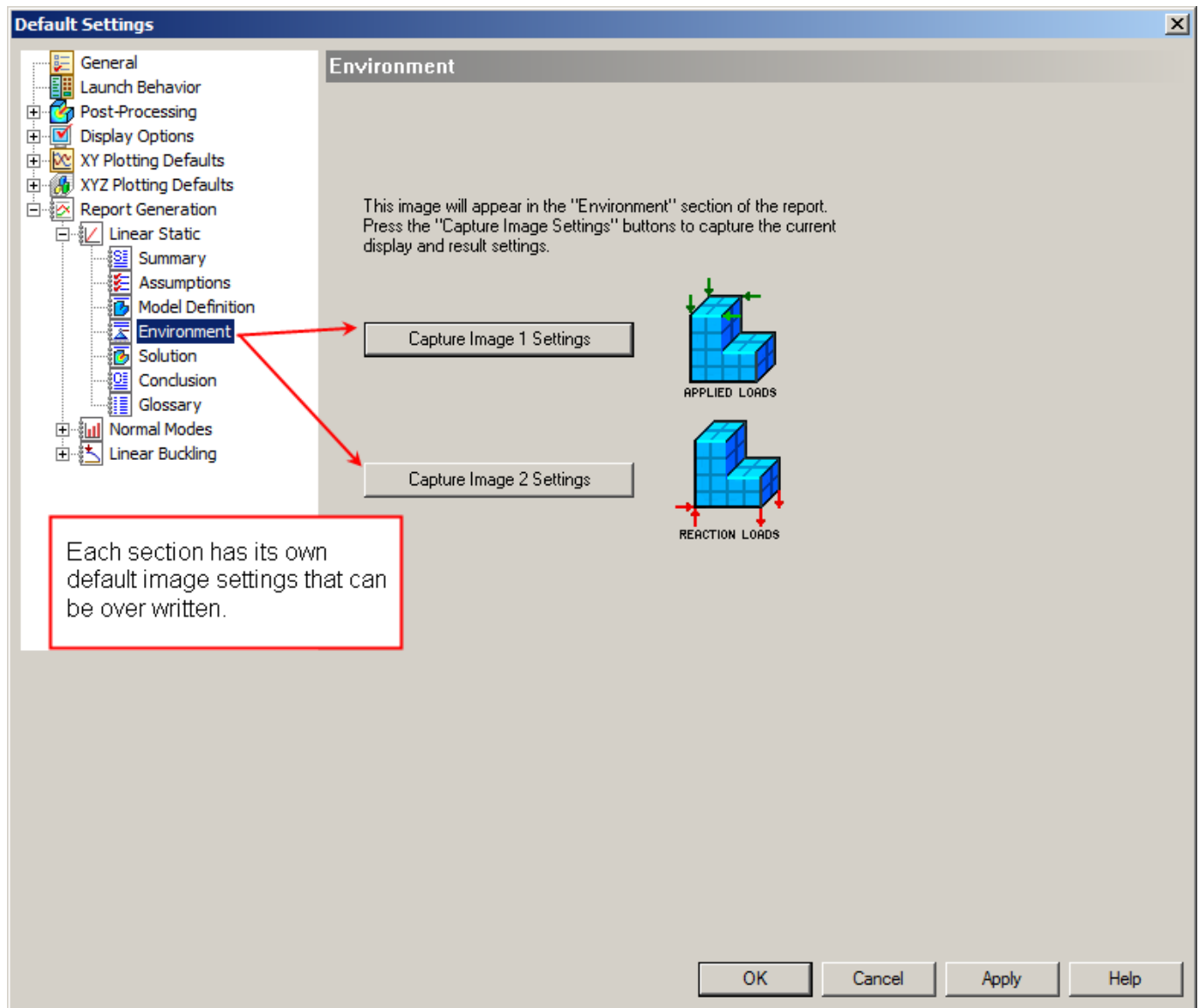

Figure 56 – Default Settings, Report Generation, Environment

### 4.5.8 Default Analysis Options Menu

The Default Options form is shown in Figure 57 and selected under the **Default Analysis Options** menu. This form sets the default options that will be used when an initialization file for an opened model input file (.NAS) does not exist. This view works just like the options view discussed in Section 2.3. The options are saved in the Nastran.INI file in the Autodesk Inventor Nastran installation folder.

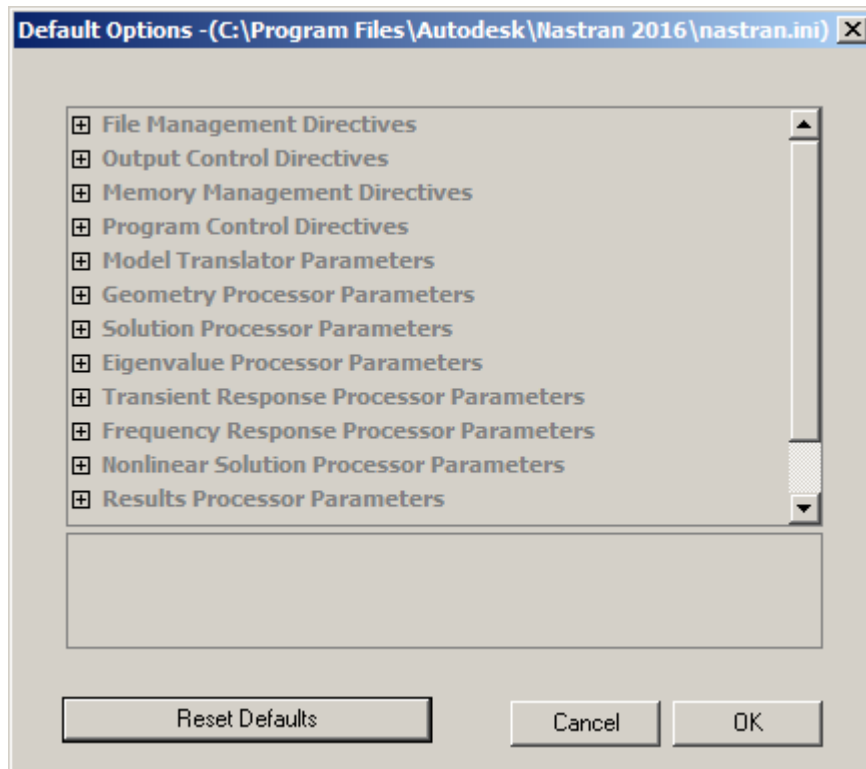

Figure 57 – Default Analysis Options Form

### 4.6 Window Menu

The Window menu shown in Figure 58 is used for basic Windows application functions such as: Cascade, Tile – Horizontally and Vertically, Close all and choosing a specific window to activate and view when multiple files are open.

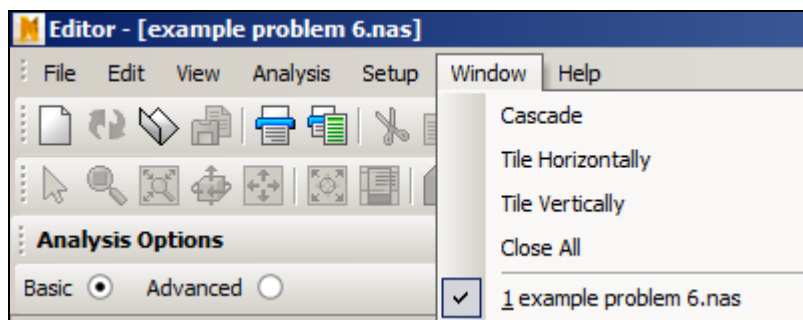

Figure 58 – Window Menu

### 4.7 Help Menu

The Help menu is shown in Figure 5959 and contains typical windows help menu items. One of the most useful is the **Nastran Help** topics item. Most of the Autodesk Inventor Nastran documentation including detailed *cause* and *action* formatted error message descriptions are available through a standard Windows Help form.

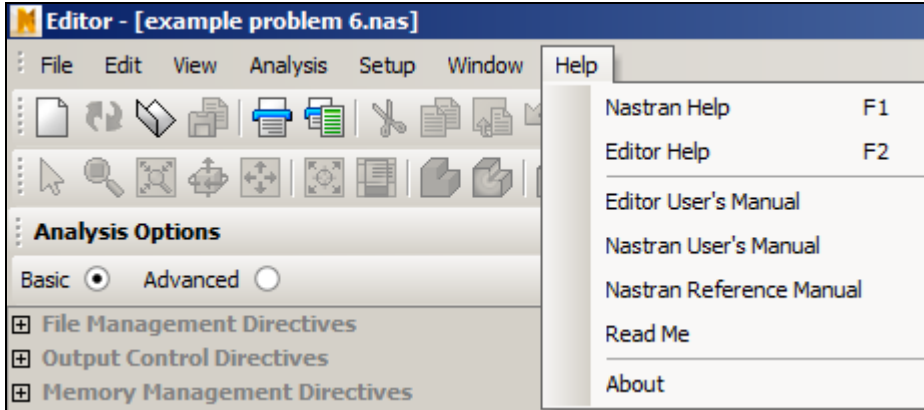

Figure 59 – Help Menu

## 5 Creating Queues

All open models are automatically added to the **Default Queue**.

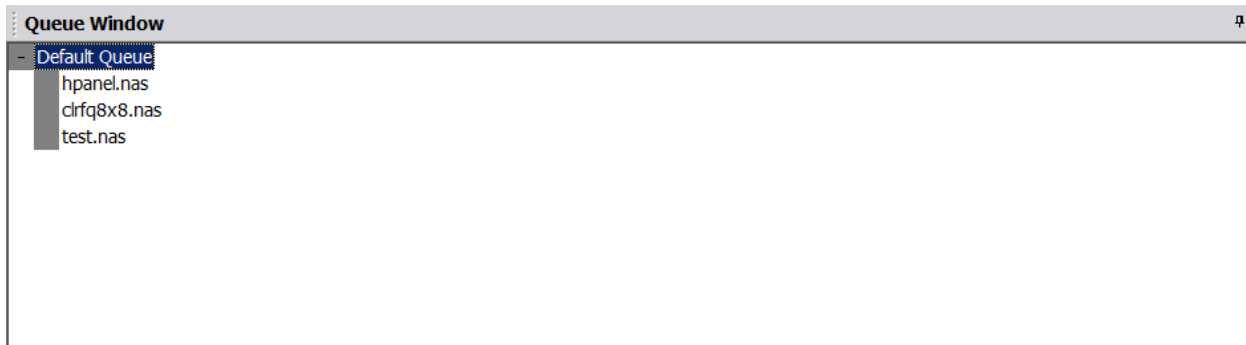

Figure 60 – Default Queue

To run the queue, right-click on Default Queue and select **Start Queue** to start the analyses.

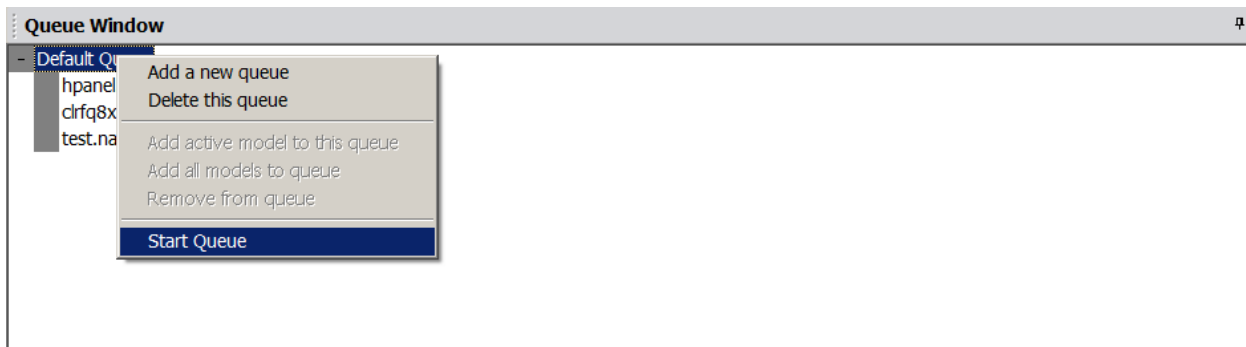

Figure 61 – Start Queue

To add a new queue, right-click on the white part of the queue window and select **Add a new queue**.

## 6 Displaying Plots

Plots can be created during a nonlinear analysis that will show maximum vector resultants vs. load factor. A plot can be displayed by either right-clicking on the plot title and selecting **Display**, or by simply double-clicking on the plot title. Only the plots with the graph icons can be displayed, as the ones without graph icons do not contain any data (see Figure 62). If you display a graph while the analysis is running, it will automatically update the graph after each increment. A sample plot is shown in Figure 63.

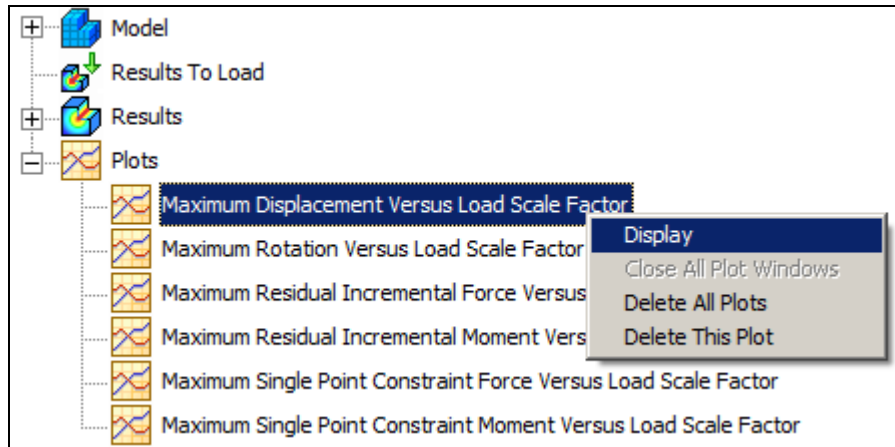

Figure 62 – Display XY Plot

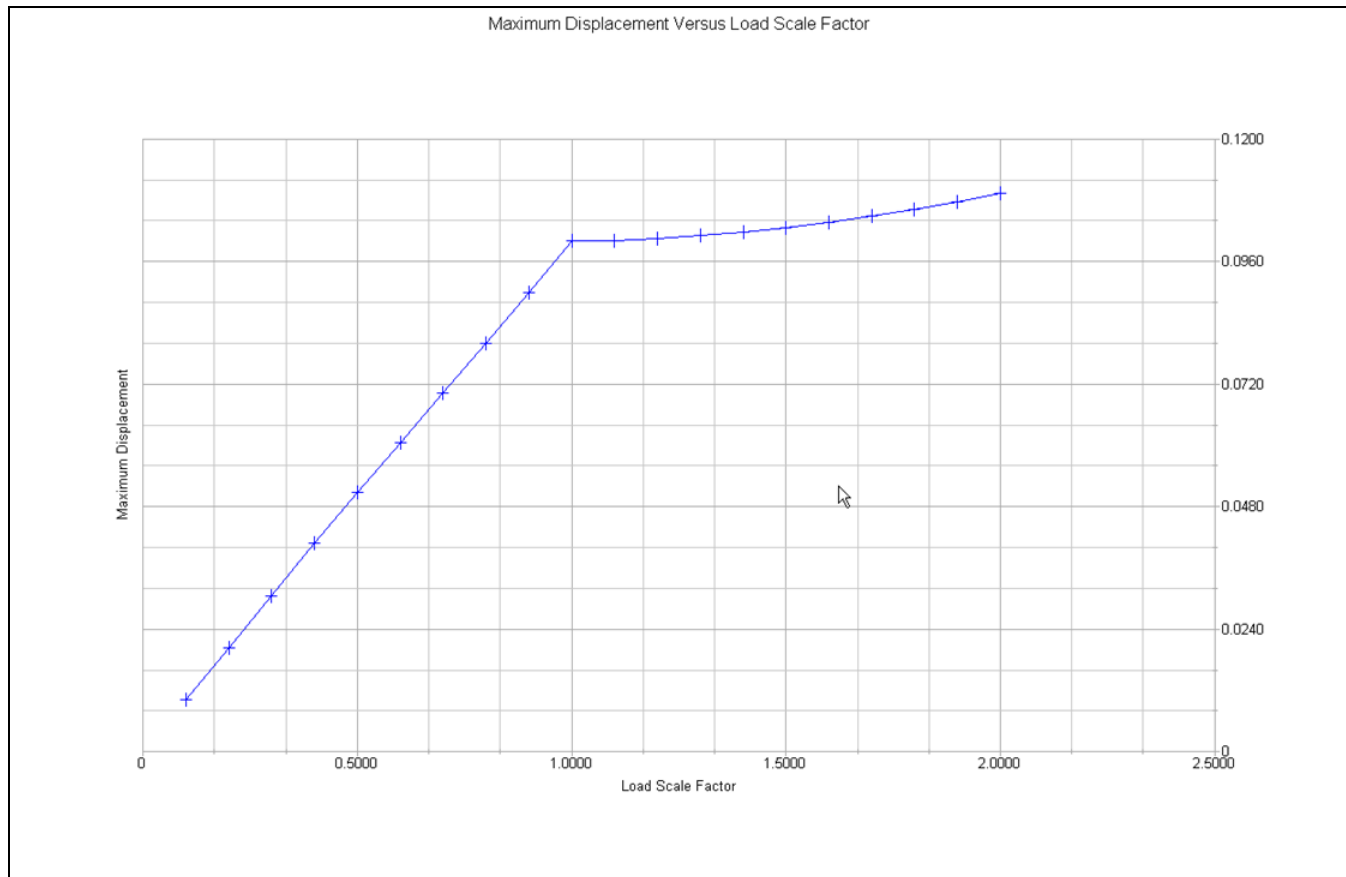

Figure 63 – Sample Plot



### 6.1 Custom Plots

Custom plotting is available through the **Analysis-Custom Plots** menu. A window will appear like the one in Figure 64. A sample entry is shown in the figure for node #1 in direction 3 (translation in Z). Multiple plots can be added by clicking **Insert Plot** after each one. When the analysis is run, the custom plots will appear in the same lower left section where the maximum vector resultants vs. load factor plots are. The custom plots (as shown in Figure 65) are accessed and work the same as the standard plots.

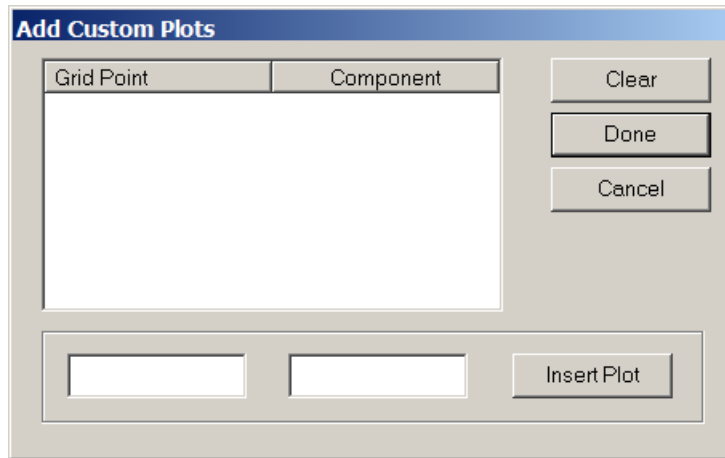

Figure 64 – Custom Plotting Options

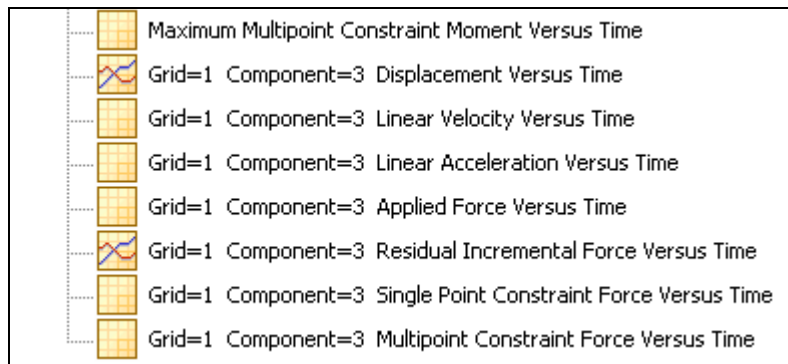

Figure 65 – Custom Plotting Options

## 6.2 Plot Formatting

A plot window can be resized and moved like any other window. In addition, multiple plots can be displayed at once. When the analysis is completed, modification of the plots is possible. To modify a plot feature simply double-click on the area you want to change. Figure 66 shows some of the plot settings the user can change such as font sizes, line thicknesses, text parameters, etc.

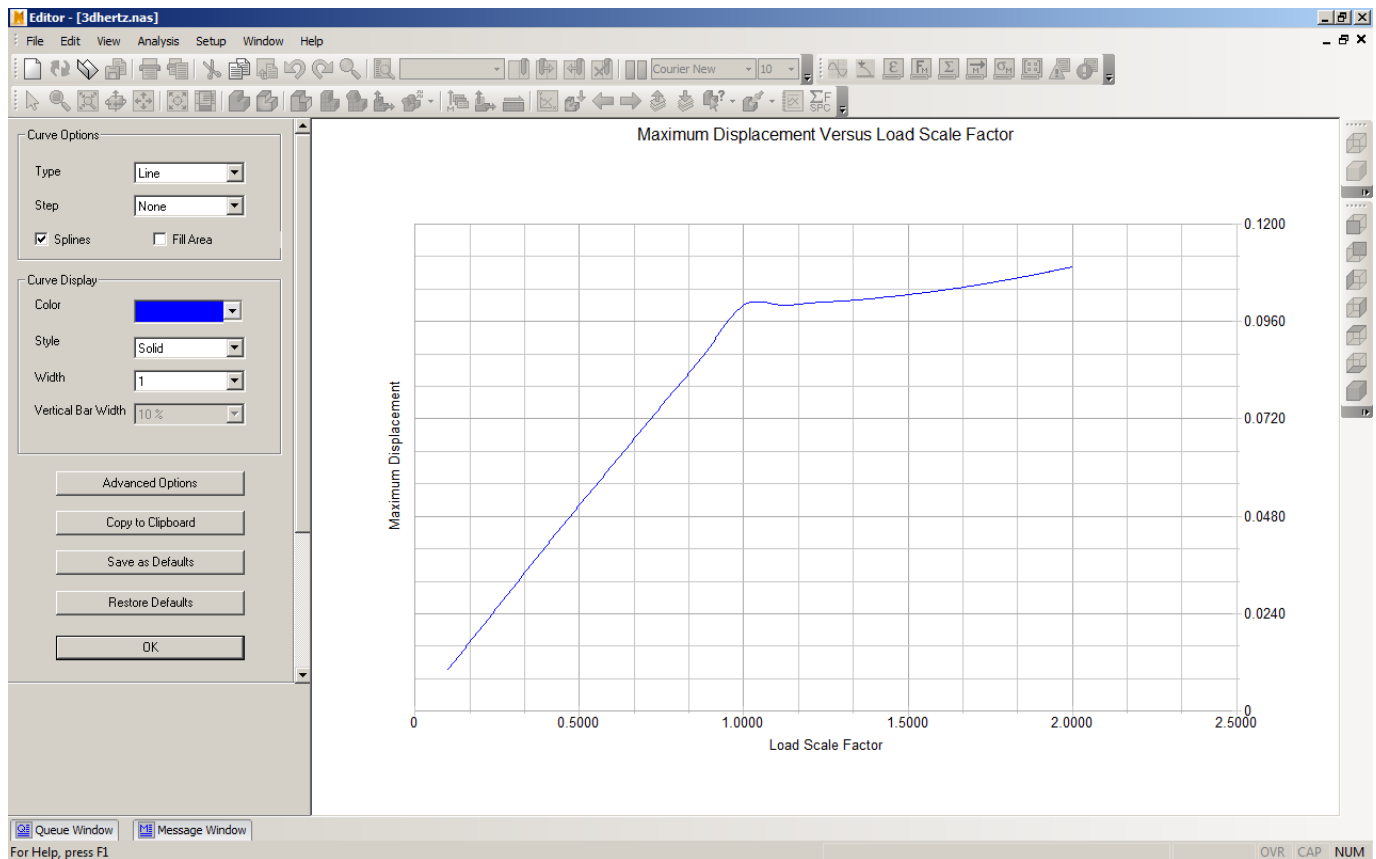

Figure 66 – Plot Formatting Option

### 6.3 Deleting Plots

Plots are deleted by right-clicking on the plot title as shown in Figure 67. From any of the plot titles, either that specific plot can be chosen for deletion, or all of the plots can be deleted at once.

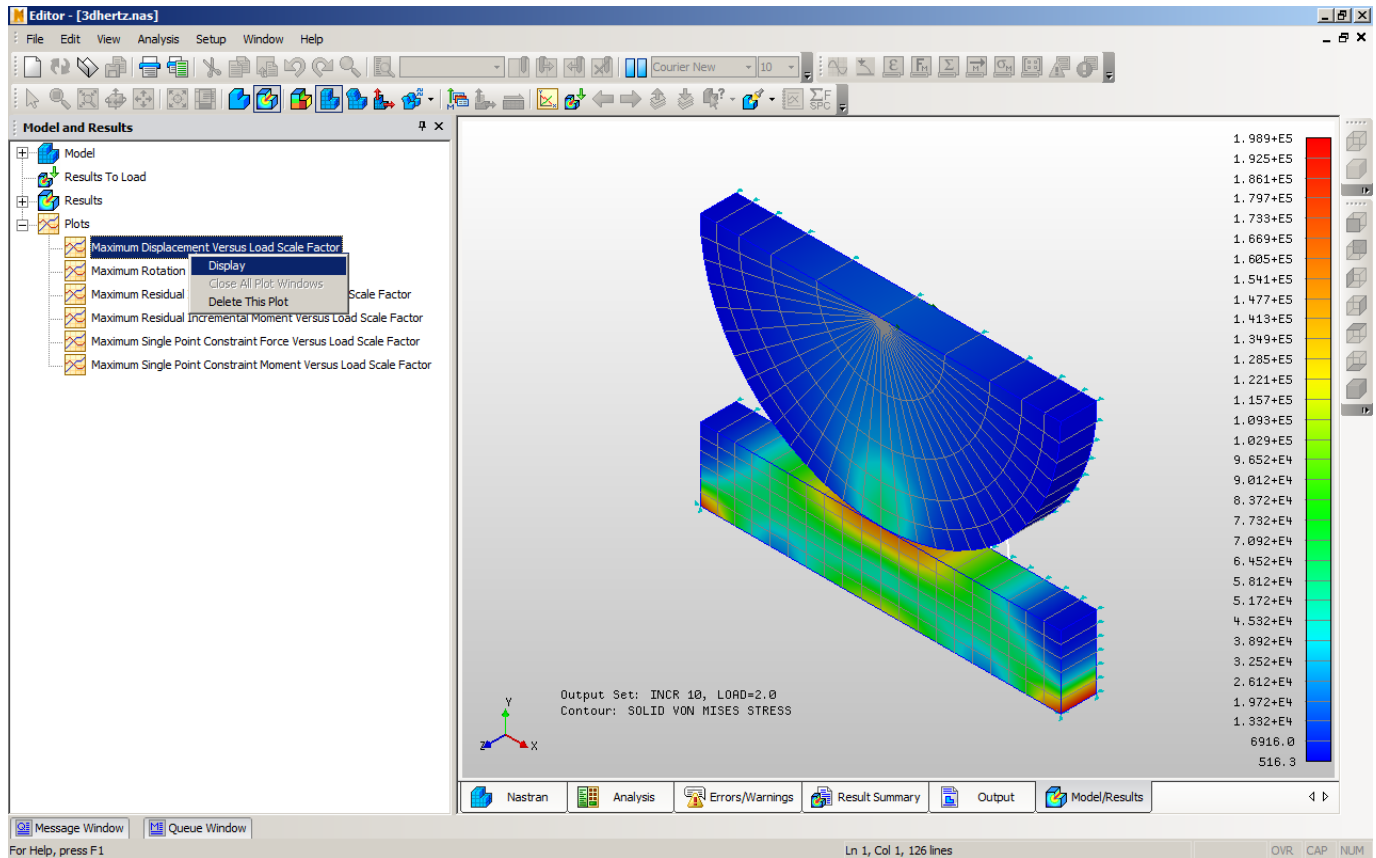
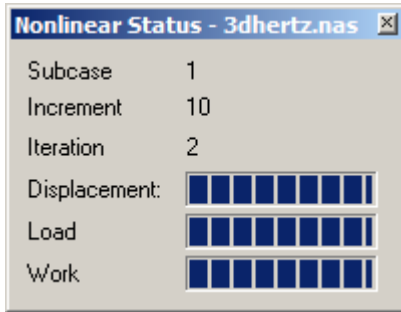

Figure 67 – Deleting Plots

## 7 Nonlinear Settings

By default, nonlinear static and transient status windows will appear when performing a nonlinear (NL) analysis (see Figure 68). The status window shows key information such as the increment/time steps and the convergence of the current increment/step. To turn it off, you can either close the window or go to View and uncheck the nonlinear static/transient status window option.



**Figure 68 – Nonlinear Status Window**

The nonlinear transient and static solution parameters (in the View menu) allow the user to modify nonlinear settings during an analysis. These menus will only become active during a nonlinear analysis. More information about the individual entries in Figure 69 can be found in the Autodesk **Nastran Solver Reference Guide** under **NLPARM** (for NL static analysis) and **TSTEPNL** (for NL transient analysis).

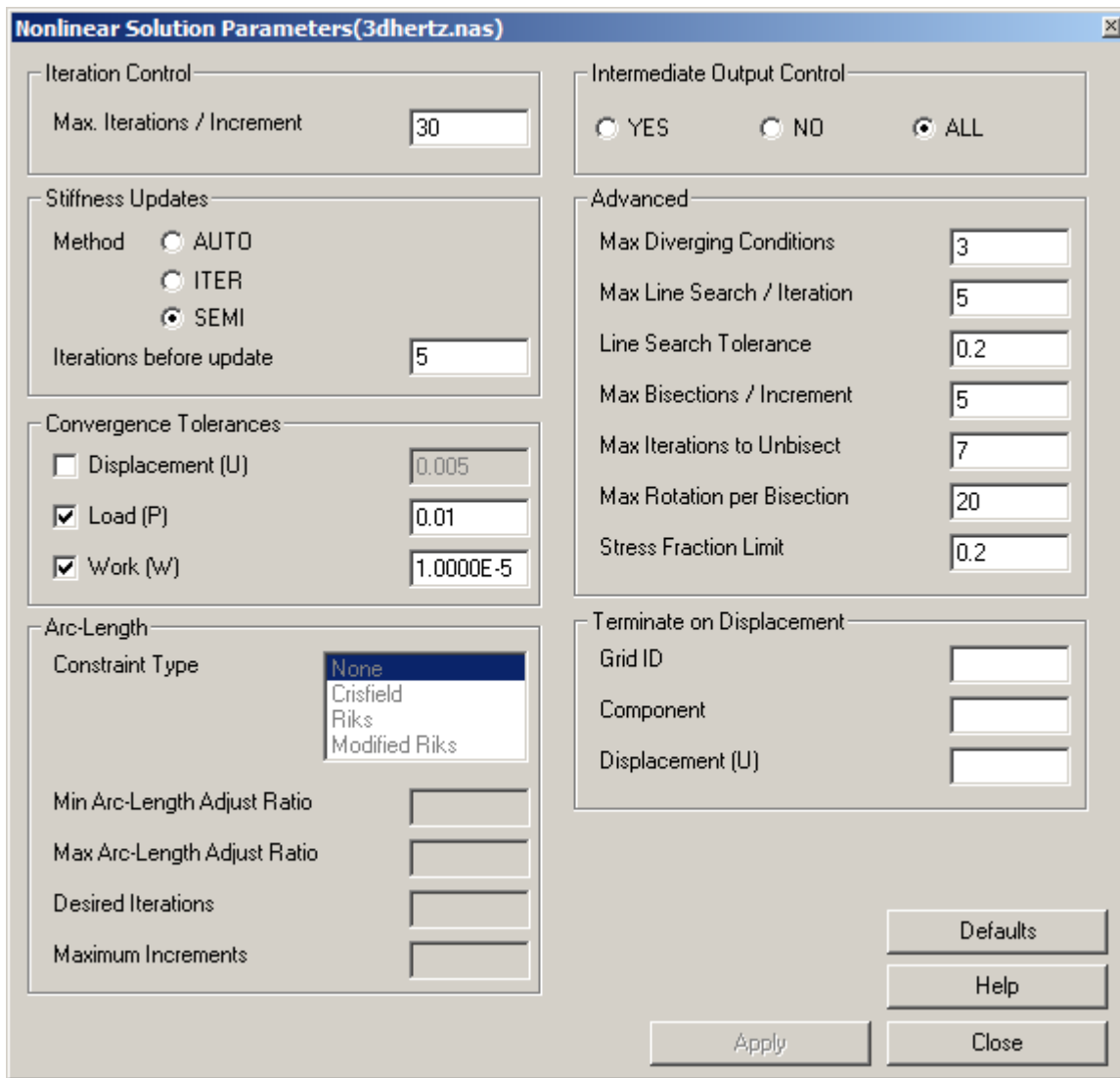

Figure 69 – Nonlinear Solution Parameters

## 8 Toolbars

Several toolbars are available to make finding information and editing data much easier with the large input and output files used in FEA.

### 8.1 Standard Toolbar

The standard toolbar is shown in Figure 70 and has the following icons: **New, Open, Save, Print, Print Preview, Cut, Copy, Paste, Undo, Redo, and Find.** The toolbar is dockable anywhere within the Editor’s main window.



Figure 70 – Standard Toolbar

### 8.2 Query Toolbar

The Query toolbar is shown in Figure 71 and is active when the output view is active. It has the following icons: **Find Frequencies, Calculate Critical Load, Find Epsilon, Find Maximum Applied Load, Find Load Vector Resultant, Find Maximum Displacement, Find Von Mises Stress, Find Matrix Statistics, Find Warning Message, and Find Error Message.** The toolbar is dockable anywhere within the Editor’s main window.

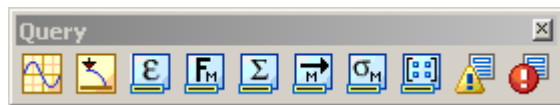

Figure 71 – Query Toolbar

### 8.3 Graphics Toolbar

The Graphics toolbar is shown in Figure 72 and is active when the Model/Results tab is active.



Figure 72 – Graphics Toolbar

### 8.4 Standard Views Toolbar

The Standard Views toolbar is shown in Figure 73 and is active when the Model/Results view is active.

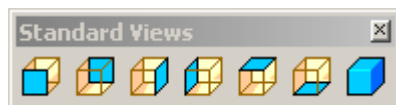

Figure 73 – Standard Views Toolbar

## 9 Field and Column Editing

The Autodesk Inventor Nastran input file can be formatted using free (comma delineated) fields or fixed 8 or 16 character fields (grid and coordinate system input only). The Editor has several tools to make editing fixed field formatted files easier. Additionally, block or column editing makes it possible to cut and paste columns of data using the same windows commands that are used with lines.

### 9.1 Fixed Field Markers

Often times when editing a fixed field Autodesk Inventor Nastran input file it is difficult to discern where the field boundaries are. The fixed field guides shown in Figure 74 help you identify these boundaries. The guides can be toggled on or off by selecting the **Field Marker (Narrow)** or **Field Marker (Wide)** menu items in the **View** menu.

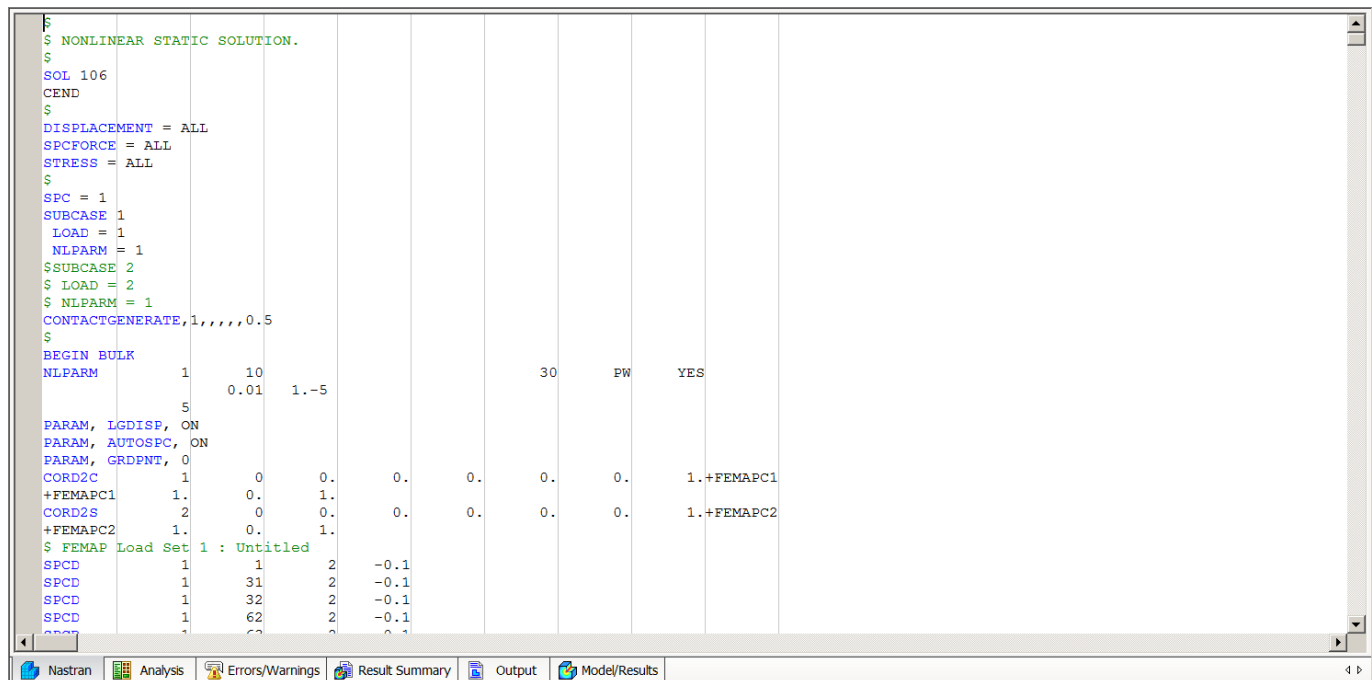

Figure 74 – Fixed Field Markers (Narrow)

### 9.2 Field Helpers

Field Helpers are lines that indicate the Autodesk Inventor Nastran fixed field boundaries and field numbers as shown in Figure 75. Field helpers are inserted using the **Edit** menu. The line is inserted at the current row number (as defined by the cursor location). Both narrow and wide field formats are supported. The line automatically starts in column 1 regardless of which column the cursor is in.

GRID	18		0.	2.	0.				
\$									
\$ FLAT PLATE MODELED WITH SHELL ELEMENTS.									
\$									
CQUADR	1	10	16	4	5	17			
CQUADR	2	10	4	10	11	5			
CQUADR	3	10	10	7	8	11			
\$-----1-----2-----3-----4-----5-----6-----7-----8-----9-----0									
CQUADR	4	10	7	13	14	8			
CQUADR	5	10	13	1	2	14			
CQUADR	6	10	17	5	6	18			
CQUADR	7	10	5	11	12	6			

Figure 75 – Field Helpers (Narrow)

### 9.3 Column Editing

The Editor supports the selection, copying and pasting of column data. To select a column of data, hold the **Alt** key and highlight the selection (see Figure 76). Once a block is selected it can be cut and pasted using the standard Windows edit commands.

\$							
\$ EDGE LOADS ON FREE END (X, Y, AND Z DIRECTIONS).							
\$							
FORCE	2	1	0	15.	0.	1.	0.
FORCE	2	2	0	30.	0.	1.	0.
FORCE	2	3	0	15.	0.	1.	0.
ENDDATA							

Figure 76 – Column Editing



## 10 Include File Support

When the check box **Display .NAS include files** is turned on (under **Setup-Default Settings-General**), the Editor will automatically load all include files into the Nastran view as shown in Figure 77. At the start and end of each include file there is a line delimiter displayed in red indicating the section for that include file. Any changes made within the delimiters will alter the include file(s) directly. When the include file feature is turned on, a *modelname\_temp.nas* file will be created that contains all the data in the master file and all include files. This is a temporary file and can safely be deleted (if desired).

```

SOL STATIC
TITLE = INSTALLATION TEST CASE
SUBTITLE = 2-D CANTILEVER BEAM -QUADR ELEMENTS -2X5 MESH

DISPLACEMENT(PUNCH) = ALL
STRESS(PUNCH) = ALL

SPC = 1
SUBCASE 1
LABEL = 60 LB EDGE LOAD IN Y-DIRECTION
LOAD = 2

BEGIN BULK

INCLUDE 'Params and BCs.nas'
INCLUDE 'Materials and Prop.nas'
INCLUDE Grids.nas
INCLUDE Elements.nas

ENDDATA
    
```

```

SOL STATIC
TITLE = INSTALLATION TEST CASE
SUBTITLE = 2-D CANTILEVER BEAM -QUADR ELEMENTS -2X5 MESH

DISPLACEMENT(PUNCH) = ALL
STRESS(PUNCH) = ALL

SPC = 1
SUBCASE 1
LABEL = 60 LB EDGE LOAD IN Y-DIRECTION
LOAD = 2

BEGIN BULK

$ ***** Begin Include File 'Params and BCs.nas'*****
$ INCLUDE 'Params and BCs.nas'
PARAM,AUTOSPC,YES
CORD2C      1      0      0.      0.      0.      0.
+NEINAC1    1.      0.      1.      0.      0.      0.
CORD2S      2      0      0.      0.      0.      0.
+NEINAC2    1.      0.      1.      0.      0.      0.
$ NEiNastran for Windows Load Set 2 : NASTRAN 2
FORCE       2      1      0      1.      0.      15.      0.
$ NEiNastran for Windows Constraint Set 1 : NASTRAN SPC 1
SPC          1      16 123456      0.
SPC          1      17 123456      0.
SPC          1      18 123456      0.

$ ***** End Include File 'Params and BCs.nas'*****
$ ***** Begin Include File 'Materials and Prop.nas'*****
$ INCLUDE 'Materials and Prop.nas'
$ NEiNastran for Windows Property 10 : Untitled
PSHELL      10      100      0.1      100      1.      100 0.83333
    
```

Figure 77 – Include File Functionality

## 11 Report Generation

The Report Generation Wizard is shown in Figure 78 and Figure 79, and is activated by going to **Analysis-Generate Report** (this can also be accessed by clicking on the report icon in the graphics toolbar). In order to use the report generator the **Enable Report Writer** check box must be checked before the analysis is performed (Under Setup-Default Settings-General). Figure 80 shows the conclusion section of the wizard that allows the user to directly type in (or paste in) the conclusion text. Currently, only linear static analysis is supported for the report generator. See Section 1.1.1 for more information on how to customize the report generator.

- The HTML report contains a summary of the analysis. Other data includes group definition, contact definition, element initial distortion summary, applied load vector resultant, reaction load vector resultant, displacement data, peak displacement component, and stress result summary of the model.
- Users can add their own conclusion and modify the default summary and glossary list.
- Default images are generated for the HTML report, or users can go to “Default Setting” to setup their own image preference.

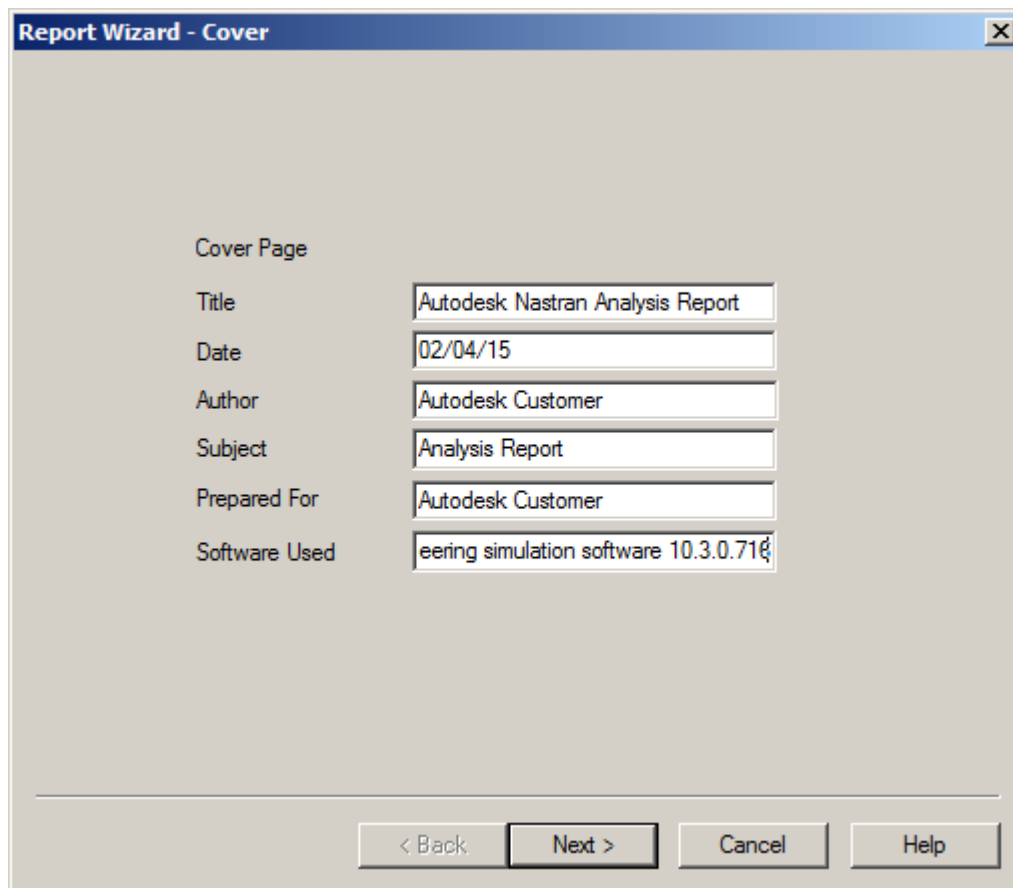

Figure 78 – Report Wizard Cover

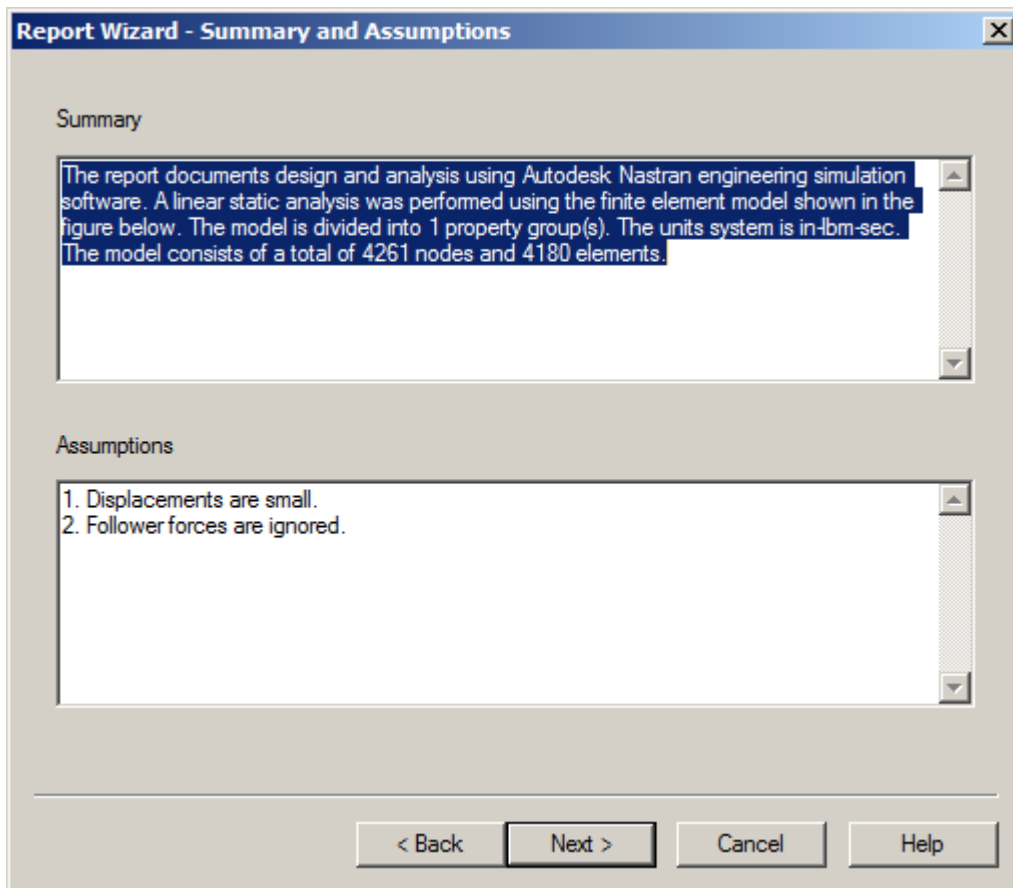

Figure 79 – Report Wizard Summary and Assumptions

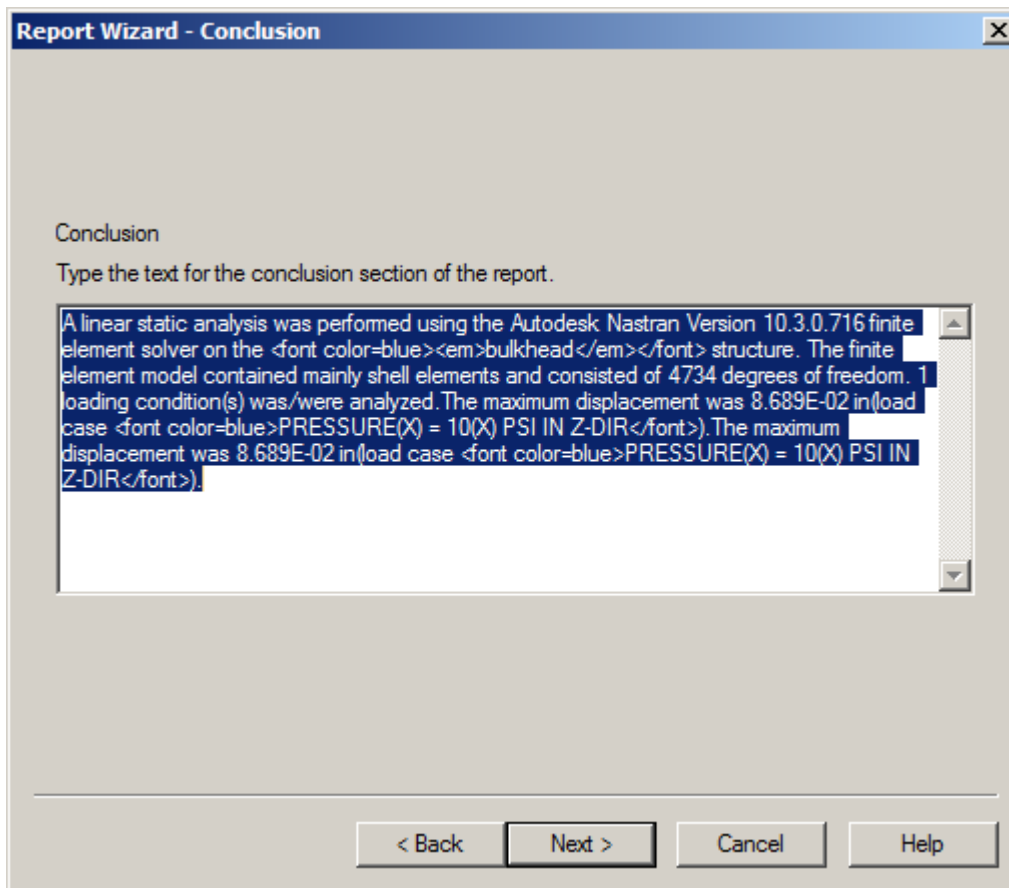

Figure 80 – Report Wizard Conclusion