

## Automatic Solar Tracking System

Mayank Kumar Lokhande

### **Abstract :**

Solar energy is very important means of expanding renewable energy resources. In this paper is described the design and construction of a microcontroller based solar panel tracking system. Solar is a nonconventional source of energy, considering this we have developed solar panels so that we can fulfill our electricity need. But due to revolution of the earth, solar source i.e. sun does not face the panel continuously hence less electricity is produced. The energy panel should face the SUN till it is present in a day. The problem above can be solved by our system by automatic tracking the solar energy. The block diagram below shows system architecture it consist of a LDR sensor senses max solar power which is being given to the Microcontroller through the ADC which digitizes the LDR output. Controller then takes the decision according to then algorithm and tilts the panel towards the direction of the max energy given by LDR with the help of DC Motor . The Motor is used to rotate the LDR to sense the max solar power. A Solar Tracker is basically a device onto which solar panels are fitted which tracks the motion of the sun across the sky ensuring that the maximum amount of sunlight strikes the panels throughout the day. After finding the sunlight, the tracker will try to navigate through the path

ensuring the best sunlight is detected. It is completely automatic and keeps the panel in front of sun until that is visible. Its active sensors constantly monitor the sunlight and rotate the panel towards the direction where the intensity of sunlight is maximum. Residential that uses solar power as their alternative power supply will bring benefits to them. The main objective of this project is to development of an automatic solar tracking system whereby the system will caused solar panels will keep aligned with the Sunlight in order to maximize in harvesting solar power. The system focuses on the controller design whereby it will caused the system is able to tracks the maximum intensity of Sunlight is hit. When the intensity of Sunlight is decreasing, this system automatically changes its direction to get maximum intensity of Sunlight. LDR light detector acts as a sensor is used to trace the coordinate of the Sunlight by detecting brightness level of Sunlight. While to rotate the appropriate position of the panel, a DC-gearred motor is used. The system is controlled by two relays as a DC-gearred motor driver and a microcontroller as a main processor. This project is covered for a single axis and is designed for low power and residential usage applications. From the hardware testing, the system is able to track and follow the Sunlight intensity in order to get maximum solar power at the output regardless motor speed.

## **Introduction :**

In last ten years, many of residentials around the world used electric solar system as a sub power at their houses. This is because solar energy is an unlimited energy resource, set to become increasingly important in the longer term, for providing electricity and heat energy to the user. Solar energy also has the potential to be the major energy supply in the future. Solar tracker is an automated solar panel that actually follows the Sun to increase the power . The sun's position in the sky varies both with equipment over any fixed position. One well-known type of solar tracker is the heliostat, a movable mirror that reflects the moving sun to a fixed location, but many other approaches are used as well. Active trackers use motors and gear trains to direct the tracker as commanded by a controller responding to the solar direction. The solar tracker can be used for several application such as solar cells, solar day-lighting system and solar thermal arrays. The solar tracker is very useful for device that needs more sunlight for higher efficiency such as solar cell. Many of the solar panels had been positioned on a fixed surface such as a roof. As sun is a moving object, this approach is not the best method. One of the solutions is to actively track the sun using a sun tracking device to move the solar panel to follow the Sun. With the Sun always facing the panel, the maximum energy can be absorbed, as the panel is operating at their greatest efficiency. The main reason for this project is to get the maximum efficiency for the solar cells. Although there are many solar

trackers in the market, the price is expensive and unaffordable because the market for solar tracker is still new and only certain countries use the solar tracker such as USA and South Korea. The large scale solar tracker that normally used is not suitable for the residential use. As a result, this project will develop a Sun tracking system specially designed for residential use for a low cost solar cell. Previous researchers and used LDR and photodiode as sensors respectively. Meanwhile and used DC motor with gear and stepper motor respectively. Those projects have disadvantages and some of the disadvantages are high cost during development, difficult to control motor speed and difficult to design because using microprocessor. The main objective for this project is to develop the sun tracking solar system model which is a device that follow the movement of the Sun regardless of motor speed. Besidesthat, it is to improve the overall electricity generation using single axis sun tracking system and also to provide the design for residential use. LDR or light dependent resistor has been chosen as the sensor because LDR is commonly used in sun tracking system. This is because LDR is sensitive to the light. The resistance of LDR will decreases with increasing incident light intensity. For the controller, AT89S52 had been chosen. This ATMEL programming will give the pulse to the driver to move the motor. For the driver, bi-directional DC motor control using relay has been used. The motor controller had been chosen because it can control the motor to rotate clockwise and counter-clockwise easily. DC geared motor also been chosen

because it has a hold torque up to 24 kg.cm and low rpm. Last but no least, LM7805 is used to convert the input voltage from the source to 5 V output because integrated circuit only need 5 V to operate.

### **Working principle of the tracker:-**

Figure shown here is the tracking device in out prototype. It is the one which follows the sun's movement through out the day and provides uninterrupted reflection to the solar panel. The sun rays will fall on the solar panel in two ways, which is, they will fall directly on the solar panel and also the reflector will reflect the incident rays on the solar panel. Suppose at the time of sun rise the sun is in extreme east the reflector will align itself in some position by which the incident rays will fall on the solar panel. Now when the earth rotates and the sun gets shifted from its earlier position the reflection of the incident rays will also change. Thus as a result the light will fall on the sensors kept on each side of the solar panel. The tracking circuit is so designed that when reflection falls on say the sensor attached to the right of the panel, the tracker will move towards the left, and visa-versa. Similar is the case when the reflection falls on the sensor attached at the top of the panel, circuit will make the tracker to move downwards. We here have tried to bring two simple principles together. One being, the normal principle of incidence and reflection on which our tracker works. And the other is the principle on which the solar panel works, which is on the incidence of the solar rays

the photovoltaic cells, will produce electricity. This both principles are combined there and as a result of which we are able to fetch nearly double the output which the panel gives normally. Precisely speaking the tracker is liable for two kinds of rotations, one is on the vertical axis and other is on the horizontal axis. The earlier is for the right-left movement of the reflection and the later is for the up-down movement of the reflector, for aligning reflection on the panel.

### **Need Of A Solar Tracker:-**

Photovoltaic's is the field of technology and research related to the application of solar cells as solar energy. Solar cells have many applications. Individual cells are used for powering small devices such as electronic calculators. Photovoltaic arrays generate a form of renewable electricity, particularly useful in situations where electrical power from the grid is unavailable such as in remote area power systems, Earth-orbiting satellites and space probes, remote radiotelephones and water pumping applications. Photovoltaic electricity is also increasingly deployed in grid-tied electrical systems. Renewable energy is rapidly gaining importance as an energy resource as fossil fuel prices fluctuate. One of the most popular renewable energy sources is solar energy. Many researches were conducted to develop some methods to increase the efficiency of Photo Voltaic systems (solar panels). One such method is to employ a solar panel tracking system. This project deals with a microcontroller based solar

panel tracking system. Solar tracking enables more energy to be generated because the solar panel is always able to maintain a perpendicular profile to the sun's rays. Development of solar panel tracking systems has been ongoing for several years now. As the sun moves across the sky during the day, it is advantageous to have the solar panels track the location of the sun, such that the panels are always perpendicular to the solar energy radiated by the sun. This will tend to maximize the amount of power absorbed by PV systems. It has been estimated that the use of a tracking system, over a fixed system, can increase the power output by 30% - 60%. The increase is significant enough to make tracking a viable proposition despite of the enhancement in system cost. It is possible to align the tracking heliostat normal to sun using electronic control by a micro controller.

**BLOCK DIAGRAM:-**

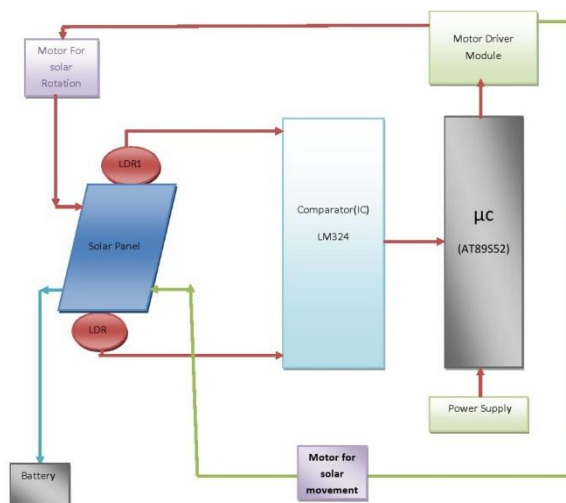

**Automatic solar tracker Components Description :-**

The major part of this electronics system is the micro controller. All the operations are controlled by it. With the help of micro controller, you can align the solar panel according to the intensity of the sunlight. Another component is the rechargeable battery which is used to store energy which is received from the panel. The purpose of the charge control is to control the charging of the battery. Micro controller unit receives the status of the battery by the charge control unit. It has two sensors, each made up of LDR. Four LDRs constitute on unit and are placed at the four corners of the panel. LDR senses the intensity of sunlight and controller receives the output. Control unit decides in which direction the panel has to be rotated to get maximum sunlight. Another unit of the sensor also consists of LDRs and used for the control of lightning load. The panel can be rotated in the desired direction by the server motor.

**Component Required :-**

Sr. Number	Component Name	Component Description	Number of Quantity
1	LDR Sensor		2
2	Diode	IN4007 (d1)	1
3	LED	3mm(1.5V & 20mA)	8
4	Electrolytic Capacitors	1000µF,10 µF(c4,c7,c6,c8)	1,4
5	Ceramic Capacitors	33pf(c1,c2)	2
6	Multilayer Capacitors	0.1 µF (c5, c9, c10, c11, c12, c13, c14, c15, c16,c17)	10
7	Resister	220Ω (r4,r3,r2,r1,r10,r39,r38)	7
8	Variable resistor	20k	2
9	Resistor Array	10k(RN2)	1
10	push to on off Switch	6 Pin (s1,S2)	2
11	Reset Switch	4 Pin(s1)	1
12	Crystal oscillator	11.0592MHz (q1)	1
13	LCD	16*2	1
14	Voltage regulator	7805 IC	1
15	Max232 IC	14 Pin(IC3)	1
16	LM293D IC	14 Pin(IC2)	1
17	(Atmel -AT89S52) IC	40 Pin (IC1)	1
18	Female Connector	Db9	1
19	Male & Female Berg Stick	Long Strips of Both	3
20	Lead acid Battery	6 volts	1
21	Solar Panel	3 watts	1
22	Motor	12 volts, 10 rpm	1
23	Wire	5m	2

## Schematic Diagram Of The Project:-

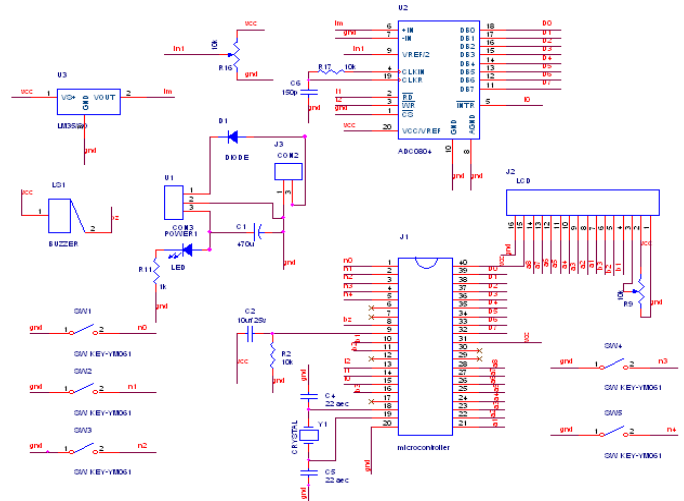

## Circuit Diagram :-

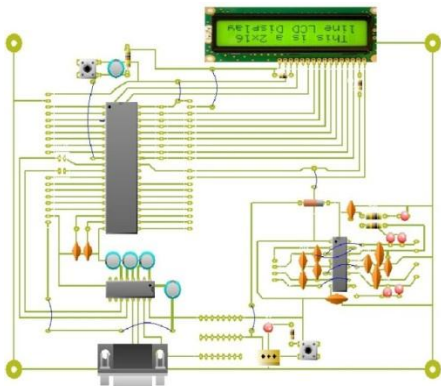

## Circuit Operation :-

In our project we have use solar panel to convert the light energy into the electrical energy. The Sun change its position throughout the day that's why we can't able to utilize the whole light energy so we have made a tracking system in which solar panel can be rotate as per the sun changes its position. We have use the Four LDR Sensor to sense the light and if the sun change its position then respective LDR Sensor sense the light and generate the highest Voltage signal and this highest voltage signal fed to the comparator IC as well as remaining sensors also give its generated voltage level to the Comparator IC. All Voltage signal of the each LDR sensor that are compared by the LM324 are fed to the microcontroller. Microcontroller receive the voltage signal from the any i/o pin of the controller and

compares the each LDR output signal to with each LDR sensor output. When the controller find the Highest voltage level of any LDR sensor gives the instruction to the motor through the motor driver circuit to rotate the solar panel on the single axis in the direction of the LDR sensor which are generating highest voltage output. so the Battery can recharge appropriately through the Solar panel and we can run the any electronic devices here we can rotate the 12 v dc fan regularly. By using external two motor and by making connection in parallel we can move the solar penal in any direction. As by rotating the solar panel in the direction of the sun we utilize the maximum energy of the sun.

### Software Required :-

**PCB Wizard :-**To design the circuit & print on printed circuit board.

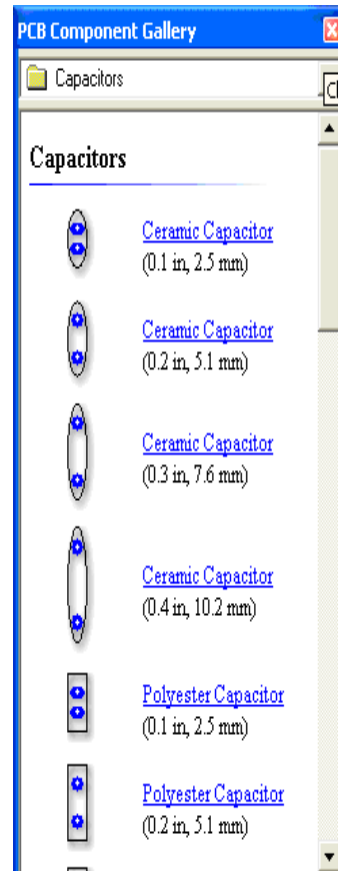
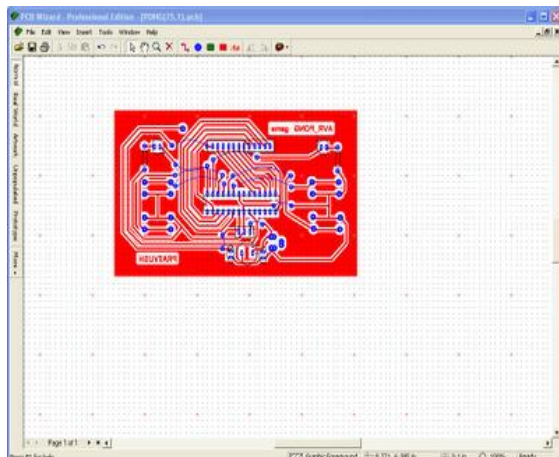

**KeilMicrovision3 :-** It is converted normal file or code into .hex file.

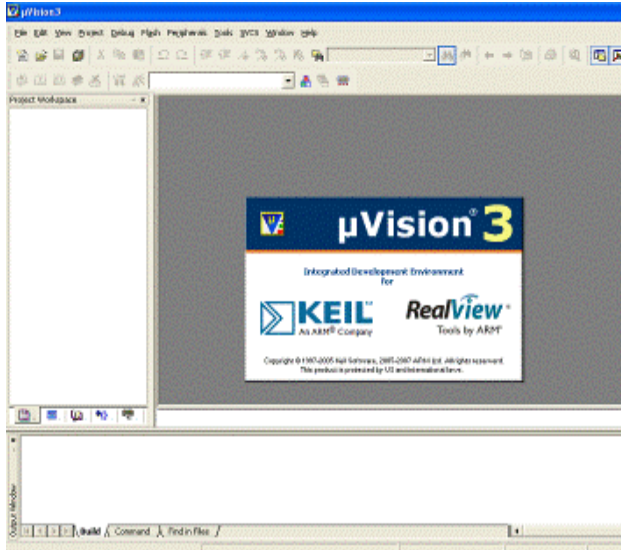

**Bootloader :-** Bootloaders are used to burn the program into the controller chip using serial communication by using ISP programmer.

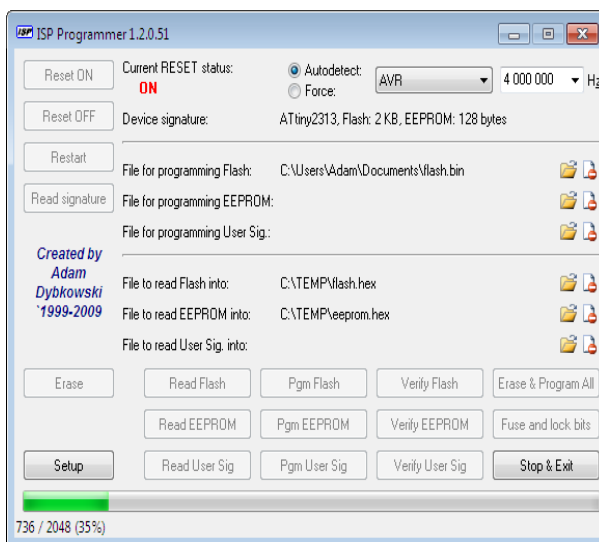

## Introduction to embedded systems :

An Embedded system is a combination of computer hardware and software, and perhaps additional mechanical or other parts, designed to perform a specific function. Embedded systems are usually a part of larger, complex system. Dedicated applications, designed to execute specific activities, are implemented and embedded in systems. These embedded applications are required to collaborate with the other components of an enclosed system. Embedded application components interact mostly with the non-human external environment. They continuously collect data from sensors or other computer components and process data within real time constraints. Embedded systems are usually associated with dedicated hardware and specific software. Embedding an application into system Application and system are closely tied together Collaborative application Dedicated H/W and specific S/W Interaction with non-human external environment Real-time systems are embedded systems.

**Methodology:-**

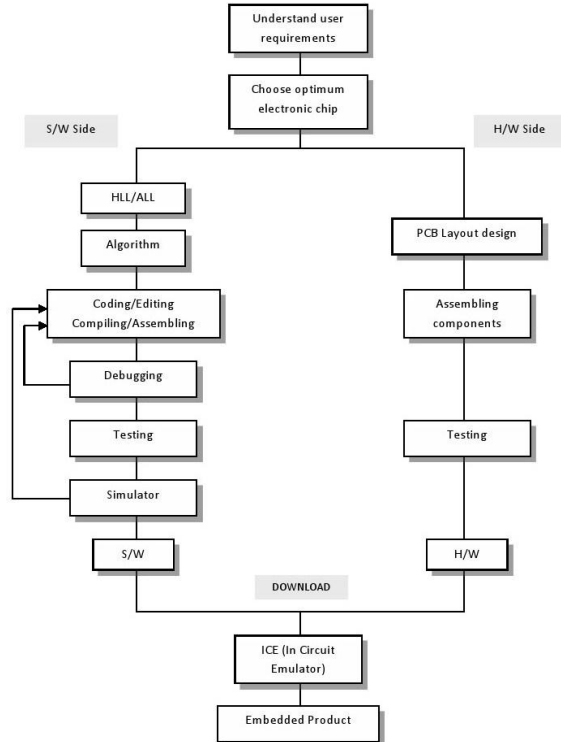

**Flowchart:-**

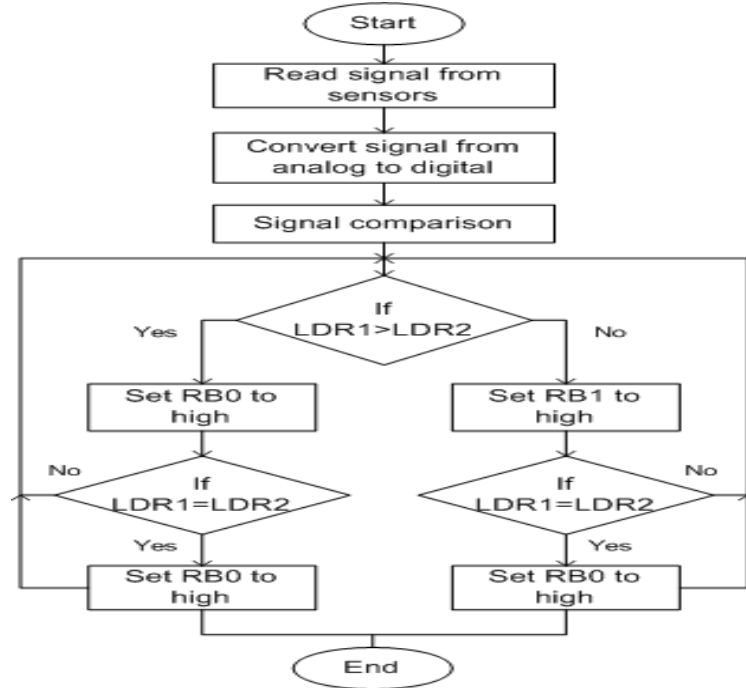

**Result & Discussion :-**

The system is focusing on the controller design. The constructed system has been tested and some data from hardware measurement have been collected and discussed. Typical solar panel has been used and the purpose only to prove the designed system is able to operate accordingly. Therefore the surrounding effects, for instance, weather condition are not seriously considered during hardware testing.

**Advantage :-**

Solar tracking systems are used to continually orient photovoltaic panels towards the sun and can help maximize your investment in your PV system. They are beneficial as the sun's position in the sky



will change gradually over the course of a day and over the seasons throughout the year. They can be used most effectively in areas with low horizons and locations that are shade free from dawn to dusk each day.

Throughout the year the tracking array will be able to utilize the wide open access to gain every available electron from the sun. This way, energy production is at an optimum and energy output is increased year round. The standalone PV home kit system is a very reliable and uncomplicated source of energy production; the panels don't move and require little maintenance. Solar tracking systems are used to continually orient photovoltaic panels towards the sun and can help maximize your investment in your PV system. They are beneficial as the sun's position in the sky will change gradually over the course of a day and over the seasons throughout the year. Advantages to using a tracker system like this will depend mainly on its placement in determining how well it will increase the effectiveness of the panels. They can be used most effectively in areas with low horizons and locations that are shade free from dawn to dusk each day. Throughout the year the tracking array will be able to utilize the wide open access to gain every available electron from the sun. This way, energy production is at an optimum and energy output is increased year round. This is especially significant throughout the summer months with its long days of sunlight available to capture and when, at many Northern latitudes, the sun rises in the northeast and sets in the northwest, no energy will be lost. For those with limited space this means that a smaller array only

needs to be installed, a huge advantage for those smaller sites with only a small area to place equipment; they will be able to produce maximum energy output but only need to utilize one of the smaller solar home systems.

#### **Disadvantage :-**

High cost during development, difficult to control motor speed and difficult to design.

By adding a solar tracking system to your solar panels, we are adding moving parts and gears which will require regular maintenance of your solar system and repair or replacement of broken parts.

If we are electronically controlled tracker stops working and you don't have a manual control, an option you can choose at the time of purchase, you can manually position your array to solar south to ensure that you will continue to capture as much solar energy as possible. Solar tracking systems do not come without their disadvantages though. The stand alone PV home kit system is a very reliable and uncomplicated source of energy production; the panels don't move and require little maintenance. By adding a solar tracking system to your solar panels, you are adding moving parts and gears which will require regular maintenance of your solar system and repair or replacement of broken parts. If you're electronically controlled tracker stops working and you don't have a manual control, an option you can choose at the time of purchase, you can manually position your array to solar south to ensure that you will continue to capture as much solar energy as possible. Secure the array into place with ropes or straps found on the

four corners of the rack and tie onto the pole or in the concrete pad. Another possible disadvantage to be aware of when purchasing a tracking solar power system, is in the way your local utility's PV Rebate Program may be set up. Many are based on the size of the PV array in your home kit and not on your PV array's production, which could mean less of a financial benefit to you. If you have a small array, such as a 3 Watt capacity, you may get less overall cost benefit than someone else with a larger array of a 4-5 Watt size capacity, even if your energy production works out higher than the person using a bigger array, due to increased sun exposure in your area. The upfront cost of purchasing a home kit with a smaller size array is less but you may receive a smaller rebate check. Many areas though, are now starting to make the move from the rated wattage system of photovoltaic home systems to the energy production based incentive program.

### **Application :-**

It controls movement in azimuthal and zenithal directions, independent of whether the requirements are for a photovoltaic (PV) or a concentrated solar power (CSP) facility. The modules or mirrors are optimally aligned with the angle of the sun's rays to constantly optimize solar energy regardless of the sun's position. These solar tracking systems have up to a one-third higher energy yield than stationary PV system — depending on the intensity of the sunlight at the installation site because the closer an installation is to the equator, the more

efficiently the PV tracking systems operate. Applications in concentrated solar power and concentrated photovoltaics require the precise tracking of solar units to focus sunlight on the target medium. Solar trackers are devices used to orient photovoltaic panels, reflectors, lenses or other optical devices toward the sun. Since the sun's position in the sky changes with the seasons and the time of day, trackers are used to align the collection system to maximize energy production. Several factors must be considered when determining the use of trackers. Some of these include: the solar technology being used, the amount of direct solar irradiation, feed-in tariffs in the region where the system is deployed, and the cost to install and maintain the trackers. Solar panels are usually set up to be in full direct sunlight at the middle of the day, facing south in the Northern Hemisphere, or facing north in the Southern Hemisphere. Therefore morning and evening sunlight hits the panels at an acute angle and reduces the total amount of electricity which can be generated each day. A solar tracker is a device onto which solar panels are fitted which tracks the motion of the sun across the sky, thus ensuring that the maximum amount of sunlight strikes the panels throughout the day. When compared to the price of the PV solar panels, the cost of a solar tracker is relatively low. We provide highly efficient, proprietary single and dual axis solar tracking systems. Our single-axis solar trackers can typically increase electricity generation by 30%, while our dual-axis

trackers can boost electricity generation by up to 40%

### **Construction :-**

Construction of this project is very easy .Just assemble the ICs, resistance and capacitors on any General-purpose PCB Put the vertical jumper on the Port1.0 & Port1.1. The actual –Size ,single –side PCB layout of the circuit is given in PCB layout.

### **Tips for assembling the project :-**

- Make the PCB Layout as given in the PCB layout diagram.
- Make the all connection on the 8051 PCB Board as given in the circuit diagram.
- Assemble and solder all the components as given in the circuit diagram.

### **Testing Procedure :-**

- Check the Continuity of the tracks on the PCB board with the help of Multimeter setting on the continuity mode.
- Check the Voltage on the all IC pins with the Multimeter by setting multimeter on the 20v dc.
- Check the serial communication on the PCB board by using serial cable with the pc by hyper terminal or using Terminal Software.

### **Actual View:-**

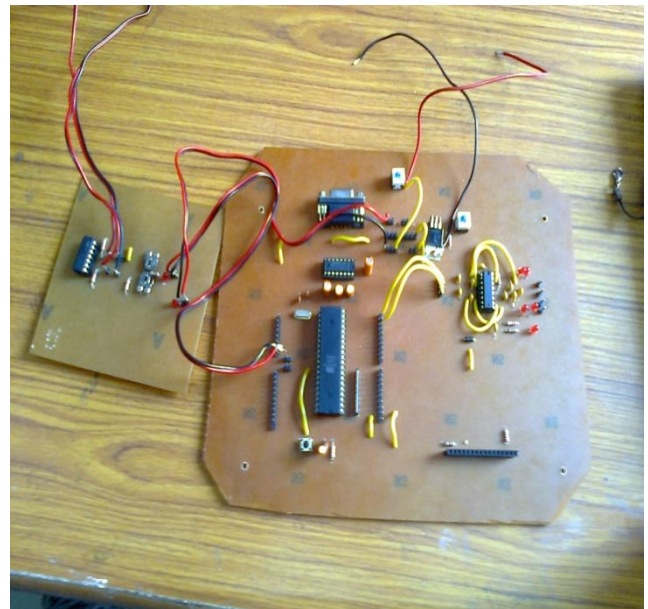

### **Conclusion :-**

Single Axis Solar Tracking System prototype model is successfully developed. The designed system is focuses on designing controller part and the main concern is to design appropriate circuits and the circuits suppose to be able to control DC-gear motor rotation direction without considering motor speed. The system is able to track and follow Sunlight intensity in order to collect maximum solar power regardless of motor speed. The unique of developed system, motor speed is not critical consideration

because the DC-g geared motor offers low output rated speed and high output rated torque. Therefore any types of DC-g geared motor can be used for this system regardless of motor speed controller unit as long as the speed and torque of the motor are following the given specification. The constructed system model can be applied in the residential area for alternative electricity generation especially for non-critical and low power appliances.

### **References :**

- ✓ *David Appleyard, "Solar Trackers: Facing the Sun", Renewable Energy World Magazine, UK: Ralph Boon, June 1, 2009.*
- ✓ *www.wikipedia.com*
- ✓ *www.electronicsforu.com*
- ✓ *www.engineergarage.com*
- ✓ *www.slideshare.net*
- ✓ *www.youtube.com*
- ✓ *www.projects8051.com*
- ✓ *www.ieeexplore.ieee.org*