

Automation Systems and Control Components

Scalable, consistent and open





Discover the unlimited possibilities of Rexroth's automation systems. They integrate all control and drive components to provide optimum automation solutions: state-of-the-art, ultra-efficient, and highly future-proof.

Contents

Expertise in automation technology	04
Automation systems – summary	08
IndraMotion MTX – CNC system for machine tools	10
IndraMotion MLD – drive-based motion logic system	22
IndraMotion MLC – controller-based motion logic system	30
IndraLogic – open PLC systems	42
Control components – summary	58
IndraWorks – engineering framework	60
IndraControl V – human-machine interfaces (HMI) and industrial PCs	80
IndraControl L – controller-based hardware	122
Inline – I/O technology in IP20	140
IndraControl S20 – I/O technology in IP20	176
IndraControl S67 – I/O technology in IP67	188
Fieldline – I/O technology in IP67	202
Interconnection technology – cables and plugs	208
Glossary	220
Standards and certificates	223

Expertise in automation technology

Discover the unlimited possibilities of Rexroth's automation systems. They integrate all control and drive components to provide optimum automation solutions: state-of-the-art, ultra-efficient, and highly future-proof.

Based on decades of experience, we developed a state of the art control platform allowing you, as a machine manufacturer, to realize your innovative machine concepts. The extensive control portfolio opens up completely new perspectives for easy, safe, and economic automation and flexible extension of your system.

We are sure you will find your preferred control solution with Rexroth. On the one hand, we offer complete automation systems and our modern controls cover all automation tasks – from a compact PLC to a flexible motion control and innovative CNC control. On the other hand, the performance and function of the drive, controller, or PC-based control systems can be adapted exactly to your individual requirements.

Design your future with the flexibility you need and configure the control solutions exactly how you require them for your applications – with systems, modules, and components from Rexroth.



Uniform engineering software for all solutions

IndraWorks now allows you to solve all of your tasks with one single software – from project planning and programming to visualization and diagnostics. Its innovative feature: IndraWorks is universally available in all of our automation systems as an integrated engineering software – you'll profit from the fast access to all functions and data of the control components and from the increased understandability of your automation solution.

Consistent PLC logic according to IEC 61131-3

Using the IndraLogic PLC runtime system in all of your automation solutions, you will be able to standardize your application programs in conformance with IEC 61131-3. With its user-friendly handling, this program system that is fully integrated in IndraWorks facilitates the creation of modularized and object-oriented applications.

Maximum flexibility with integrated motion logic

The family of open system software combines all components from Rexroth to provide integrated solutions with motion and logic control. Using IndraMotion, you can implement all of your centralized and distributed control designs, customized to your industry-specific requirements.

Scalable platforms for all control topologies

The scalable control, visualization and I/O hardware platforms allow easy, flexible and integrated automation of your applications. Combined with open communication interfaces, these hardware platforms provide automation solutions that are also sustainable in the future and allow factory automation with any degree of freedom.

Safety on board – certified integrated safety solution

The drive integrated safety technology „Safety on Board“ provides reliable personnel protection for all motion applications. With the IndraDrive family, the “Safety on Board” system, certified according to EN ISO 13849-1, Cat. 3 PL d and EN 62061 SIL 2, provides comprehensive safety

functions which you can easily integrate in your applications by simple parameterization.

sercos – Ethernet-based communication

The 3rd generation sercos meets all requirements for a future-oriented machine network – open, consistent and fast. From drives and controls to I/O peripherals, all automation components are easily combined to form an understandable and capable overall system. With real-time and innovative features, sercos the automation bus provides maximum performance and flexibility in all applications.



Automation system and control components at a glance

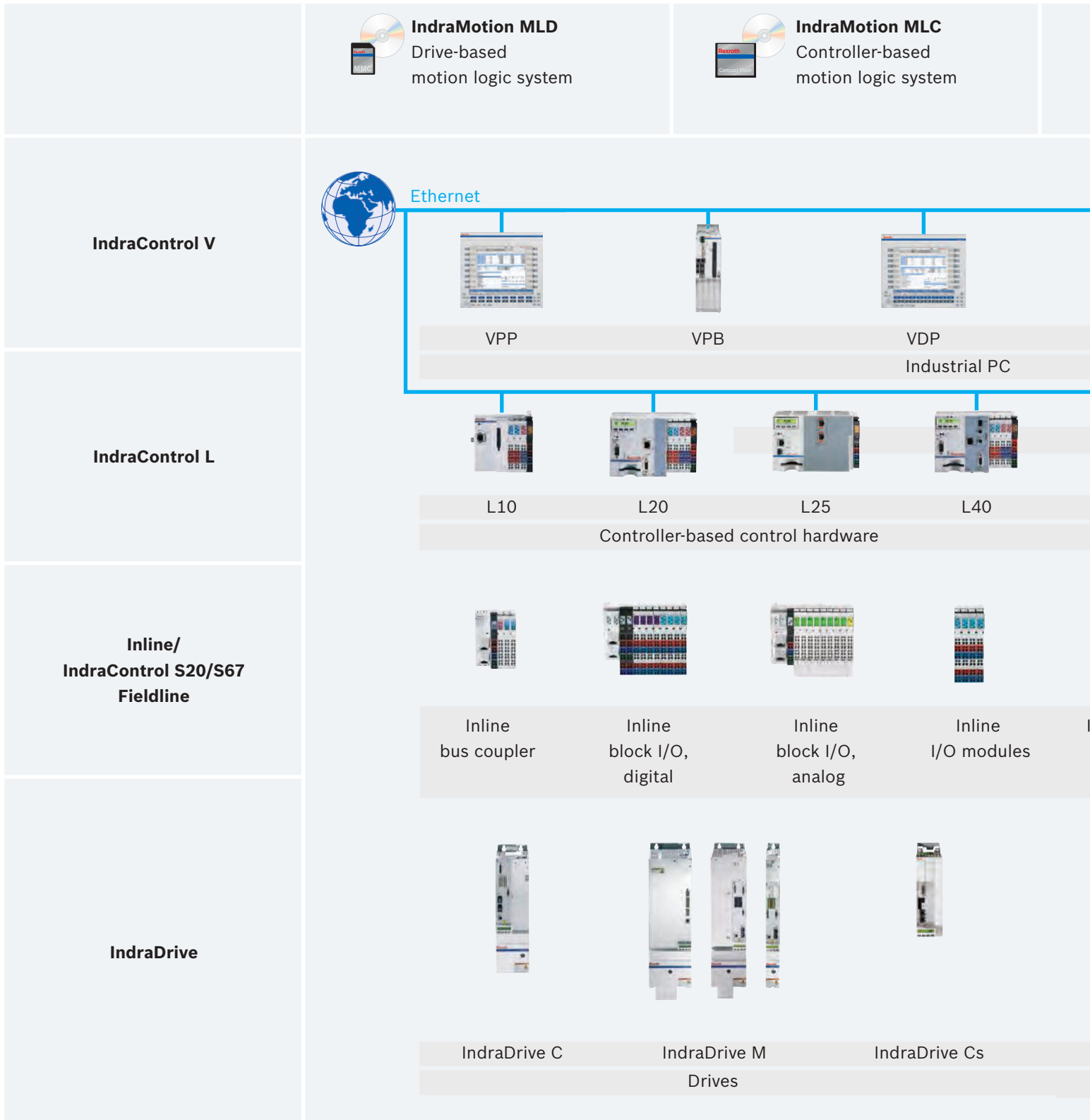

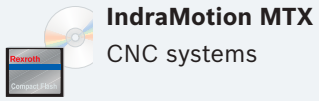



IndraMotion MTX
CNC systems

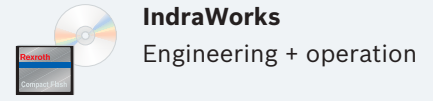

IndraLogic
PLC



IndraWorks
Engineering + operation

Engineering 



VDP40



VAM



VAK

Control panels/keyboards



VEP



VEP30

Embedded PC



VCP



VCH

Controller



L45



L65/85



Function modules

Controller-based control hardware



IndraControl S20
bus coupler



IndraControl S20
I/O modules



IndraControl S67
bus coupler



IndraControl S67
I/O modules



Fieldline M8
I/O modules

sercos
the automation bus



IndraDrive Mi
Drives



IndraDyn
Motors

Automation systems – CNC, PLC, and motion control



**IndraMotion MTX –
CNC system for machine tools**

10



**IndraMotion MLD –
drive-based motion logic system**

22



**IndraMotion MLC –
controller-based motion logic system**

30



**IndraLogic –
open PLC systems**

42



IndraMotion MTX – highly productive CNC solution for all machine tools

Rexroth IndraMotion MTX is the individually scalable CNC platform with integrated PLC for successful machining and forming applications. Excellent performance and comprehensive technology functions open new horizons for maximum productivity and flexibility.

Whether you control a standard machine or a fully automated production system – IndraMotion MTX always ensures highly dynamic processing with minimized downtimes in your application. The following system versions are available:

- ▶ IndraMotion MTX micro – the tailor-made, compact system solution for turning and milling machines
- ▶ IndraMotion MTX standard – the modular CNC control for universal machines and machining centers
- ▶ IndraMotion MTX performance – the high-performance CNC control for fast machining centers with up to 64 axes
- ▶ IndraMotion MTX advanced – the CNC control with extra power for multi-technology machining with the highest dynamics

Your benefits

- ▶ Innovative CNC kernel with comprehensive technology functions for turning, milling, drilling, grinding, bending, nibbling, punching, shape cutting and handling
- ▶ Shortest CNC cycle times, even for high-speed machining
- ▶ Minimum PLC processing times
- ▶ Open system platform
- ▶ Performance and function individually scalable
- ▶ sercos III automation bus for fast, continuous communication between control, drives, and I/O components
- ▶ Uniform operating concept for easy programming
- ▶ Flexibly configurable user interface
- ▶ Open standards for easy connection of higher-order ERP systems



IndraMotion MTX is the tailor-made CNC solution for turning, milling, drilling, grinding, bending, nibbling, punching, and shape cutting.

Open, complete, and efficient

- ▶ Highest manufacturing precision down to the nanometer range
- ▶ Modern CNC solution for excellent performance
- ▶ Shortest CNC and PLC cycle times for dynamic machining



Application examples:

IndraMotion MTX micro is the compact, powerful, and CNC cost-effective solution from Rexroth for standard turning and milling machines.

- ▶ Turning with constant cutting speed
- ▶ Rigid or non-rigid tapping
- ▶ Combined spindle/revolver axes
- ▶ Milling with 2.5D and 3D machining with up to 4 interpolating axes
- ▶ Direct programming of drawing dimensions
- ▶ Turning, drilling, and milling cycles for complete machining
- ▶ Cylinder surface and C-axis machining



The modular IndraMotion MTX system controls standard and universal machines for milling, turning, drilling, grinding, nibbling, punching, shape cutting, and bending easily, quickly, and effectively. Proven CNC functions cover a broad range of applications from highly precise and quick machining of free-form surfaces to the most-demanding grinding applications, as well as plasma, laser, or waterjet machines.

- ▶ Spline interpolation and B-spline compressor
- ▶ Nano interpolation
- ▶ 5-axis machining and 3D cutter radius compensation
- ▶ Any combination of machining technologies in one process, e.g. for turning on milling machines
- ▶ Spindle coupling and electronic transmission
- ▶ High-speed I/O in interpolator cycle
- ▶ Intelligent, hydraulic axis control and interpolation between hydraulic and electric axes
- ▶ SafeMotion for integrated safety functions

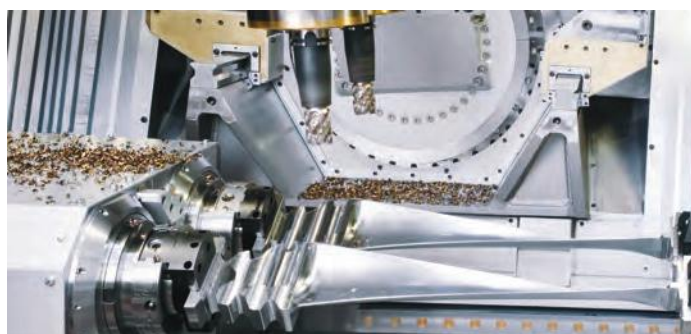

IndraMotion MTX – technical data

	MTX micro	MTX standard	MTX performance	MTX advanced
Machining technologies				
Turning	●	●	●	●
Milling	●	●	●	●
Drilling	●	●	●	●
Grinding	●	●	●	●
Nibbling, shape cutting	●	●	●	●
Forming	–	●	●	●
Axis control				
Default number of axes	3/4 ●	8 ●	8 ●	8 ●
Max. number of axes	6 ○	8 ●	64 ○	64 ○
Max. number of spindles thereof	2 ●	2 ●	32 ○	32 ○
Default number of independent channels	2 ●	2 ●	3 ●	3 ●
Max. number of independent channels	2 ●	2 ●	12 ○	12 ○
Default number of interpolating axes per channel	4 ●	4 ●	4 ●	4 ●
Max. number of interpolating axes per channel	4 ●	4 ●	8* ○	8* ○
Linear axes	●	●	●	●
Rotary axes	●	●	●	●
Endlessly turning rotary axis	●	●	●	●
Hirth axes	●	●	●	●
Spindle/C-axis switching	●	●	●	●
Max. number of gantry groups per channel	1	4 ○ 2) 6)	8 ○ 2) 3) 6)	8 ○ 2) 3) 6)
Channel-crossing axis transfer	●	●	●	●
Electronic cam	●	●	●	●
Spindle coupling via electronic transmission	●	○ 7)	○ 7)	○ 7)
Software limits	●	●	●	●
Main spindle synchronization	●	○ 1) 2)	○ 2) 2) 3)	○ 2) 2) 3)
Axis-specific jerk limitation	●	●	●	●
Integrated safety system according to EN ISO 13849-1 and EN 62061 (safe stop, safe motion)	–	□	□	□
Interpolation functions				
Linear interpolation	●	●	●	●
Linear interpolation with/without exact stop	●	●	●	●
Circular interpolation with radius and center-point programming, helical interpolation	●	●	●	●
Circular interpolation with tangential entry	●	●	●	●
Rigid tapping cycle	●	○ 1) 6)	○ 1) 6)	○ 1) 6)
Thread cutting	●	○ 1)	○ 1)	○ 1)
Cylinder surface transformation	●	●	●	●

● Default ○ Optional ■ Optional in connection with a PC □ Optional with IndraDrive

1) "Turning 1" technology package 2) "Milling 1" technology package 3) "Milling 2" technology package 4) "Turning" CNC simulation

5) "Milling" CNC simulation 6) "Shape cutting" technology package 7) "Electronic transmission" technology package

*) An export license is required for this option. Per part I C of the export list (EC Regulation) item 2D002.

	MTX micro	MTX standard	MTX performance	MTX advanced
Machining technologies				
C-axis transformation	●	●	●	●
NC block preview, look-ahead	Max. 1,000 blocks	Max. 1,000 blocks	Max. 1,000 blocks	Max. 1,000 blocks
5-axis transformation with TCP programming	–	–	○ ³⁾	○ ³⁾
Jogging with active transformation	–	–	○ ³⁾	○ ³⁾
Spline interpolation, C1 + C2, continuous cubic splines, B-splines, NURBS	●	○ ^{1) 2)}	○ ^{1) 2) 3)}	○ ^{1) 2) 3)}
Nanometer resolution	●	●	●	●
Feed functions				
Feed in mm/min or inch/min	●	●	●	●
Time programming	●	●	●	●
Feed rate per revolution	●	●	●	●
Constant cutting speed	●	○ ¹⁾	○ ¹⁾	○ ¹⁾
Fixed Stop	●	●	●	●
Torque reduction	●	●	●	●
Shifts and compensations				
Mirroring, scaling, rotating	●	●	●	●
Zero offsets	●	●	●	●
Compensations and zero offsets programmable through CPL	●	●	●	●
Placements (FRAMES)	●	○ ²⁾	○ ^{2) 3)}	○ ^{2) 3)}
2D compensation	●	●	●	●
3D cutter radius compensation	–	–	○ ³⁾	○ ³⁾
Compensation with plane switching	●	●	●	●
Tangential tool guidance	●	●	●	●
Tool management				
Integrated flexible tool management	●	●	●	●
Configurable tool database	●	●	●	●
Freely definable tool compensation (length, radius, cutting position compensation, user data)	●	●	●	●
Additive tool compensations (D compensations)	–	●	●	●
Access to tool data from PLC	●	●	●	●
Access to tool data from CNC	●	●	●	●
CNC programming				
Part program development	DIN ISO 66025/ RS 274D	DIN ISO 66025/ RS 274D	DIN ISO 66025/ RS 274D	DIN ISO 66025/ RS 274D
High-level language programming, CPL (customer programming language)	●	●	●	●
Graphical NC simulation	–	○ ^{4) 5)}	○ ^{4) 5)}	○ ^{4) 5)}
CNC user memory	64 MB	256 MB	512 MB	1,024 MB

● Default ○ Optional ■ Optional in connection with a PC □ Optional with IndraDrive

¹⁾ “Turning 1” technology package ²⁾ “Milling 1” technology package ³⁾ “Milling 2” technology package ⁴⁾ “Turning” CNC simulation

⁵⁾ “Milling” CNC simulation ⁶⁾ “Shape cutting” technology package ⁷⁾ “Electronic transmission” technology package

*) An export license is required for this option. Per part I C of the export list (EC Regulation) item 2D002.

IndraMotion MTX – technical data

	MTX micro	MTX standard	MTX performance	MTX advanced
CNC programming				
Static memory	4 MB	8 MB	8 MB	16 MB
Max. size of parts program	8 MB	PC hard disk (network file system) ●	PC hard disk (network file system) ●	PC hard disk (network file system) ●
CompactFlash data memory	●	●	●	●
Technology cycles				
Drilling	●	●	●	●
Turning	●	●	●	●
Milling	●	●	●	●
Functions				
Dwell time in seconds	●	●	●	●
Acceleration programming, loop gain programming	●	●	●	●
Homing through NC program	●	●	●	●
Absolute dimension, relative dimension	●	●	●	●
Switching between inch and mm	●	●	●	●
Probe, static/on-the-fly measurement	●	●	●	●
Read process and drive data through sercos	●	●	●	●
Roundings and chamfers	●	●	●	●
Corner rounding with splines	●	●	●	●
Laser power control	●	●	●	●
Digitizing	●	●	●	●
NC block defined by PLC	●	●	●	●
Support for control elements				
Configurable operator screens	–	■	■	■
Cycle header/input support, OEM cycles	–	■	■	■
NC program restart/block search	●	●	●	●
Dry run	●	●	●	●
Retracting from and returning to the contour	●	●	●	●
Retrace function: reversing over the contour	●	○ ⁶⁾	○ ⁶⁾	○ ⁶⁾
PLC programming				
Integrated PLC: IndraLogic	●	●	●	●
Programming languages according to IEC 61131-3 (IL, LD, CFC, ST, SFC, FBD)	●	●	●	●
PLC program memory	2 MB	8 MB	8 MB	16 MB
Number of local/on-board I/Os	32 I/16 O ●	8 I/8 O ●	8 I/8 O ●	8 I/8 O ●
Max. number of local/on-board I/Os	96 I/48 O ○	○	○	○
Number of high-speed inputs/outputs	8 I/8 O ●	8 I/8 O ●	8 I/8 O ●	8 I/8 O ●
Number of fieldbus inputs/outputs in bytes	8,192 I/8,192 O	8,192 I/8,192 O	8,192 I/8,192 O	8,192 I/8,192 O
Multitasking	●	●	●	●
Max. number of PLC tasks	2	16	16	16

● Default ○ Optional ■ Optional in connection with a PC □ Optional with IndraDrive

(1) "Turning 1" technology package (2) "Milling 1" technology package (3) "Milling 2" technology package (4) "Turning" CNC simulation

(5) "Milling" CNC simulation (6) "Shape cutting" technology package (7) "Electronic transmission" technology package

*) An export license is required for this option. Per part I C of the export list (EC Regulation) item 2D002.

	MTX micro	MTX standard	MTX performance	MTX advanced
Diagnostic and startup tools				
Integrated, system-crossing engineering framework IndraWorks	○	●	●	●
Instructions and error messages in plain text	●	●	●	●
Integrated drive project planning	●	●	●	●
Drive oscilloscope	○	●	●	●
Integrated PLC project planning	○	●	●	●
Logic analyzer	○	●	●	●
Circular shape test	○	●	●	●
NC analyzer	–	●	●	●
Action recorder IndraMotion MTX acr	–	○	○	○
Cycle time analyzer IndraMotion MTX cta	○	○	○	○
Energy analyzer IndraMotion MTX ega	○	○	○	○
Remote condition monitoring system IndraMotion MTX rcm	–	○	○	○
Remote diagnosis I-Remote	–	○	○	○
IndraMotion MTX micro Trainer	●	–	–	–
IndraWorks view 3D	–	○	○	○
IndraWorks machine simulator	–	○	○	○
Open architecture				
Configurable user interface with all standard functions	–	●	●	●
User-specific operator screens	–	●	●	●
Adaptation and integration through standardized interfaces (OPC-UA, XML, ActiveX, .NET)	–	●	●	●
Control hardware and interfaces				
CPU		IndraControl L45	IndraControl L65	IndraControl L85
Digital drive interface sercos	100 Mbaud ●	100 Mbaud ●	100 Mbaud ●	100 Mbaud ●
PROFIBUS master/slave	–	12 Mbaud ●	12 Mbaud ●	12 Mbaud ●
Ethernet TCP/IP	100 Mbaud ●	10/100 Mbaud ●	10/100 Mbaud ●	10/100 Mbaud ●
EtherNet/IP adapter (slave)	–	○	○	○
PROFINET	–	○	○	○
Software and hardware				
Operating system Windows XP/Windows 7	–	○	○	○
Panel PC IndraControl VPP 16/40* – CPU: Intel Celeron P4500, 1.86 GHz or Core I5, 2.4 GHz or Core I7, 2.66 GHz – TFT display: 30.5 cm (12")/38.1 cm (15") – 16 machine control keys	–	○	○	○
Industrial PC IndraControl VPB 40* – CPU: Intel Celeron P4500, 1.86 GHz or Core I5, 2.4 GHz or Core I7, 2.66 GHz	–	○	○	○
Embedded PC IndraControl VEP 40/50* – CPU: Intel Atom, 1.1 GHz, 1 GB RAM – TFT display: 30.5 cm (12")/38.1 cm (15") – 16 machine control keys	–	○	○	○

● Default ○ Optional ■ Optional in connection with a PC □ Optional with IndraDrive

(1) "Turning 1" technology package (2) "Milling 1" technology package (3) "Milling 2" technology package (4) "Turning" CNC simulation (5) "Milling" CNC simulation (6) "Shape cutting" technology package (7) "Electronic transmission" technology package

*) An export license is required for this option. Per part I C of the export list (EC Regulation) item 2D002.

IndraMotion MTX micro – system configuration

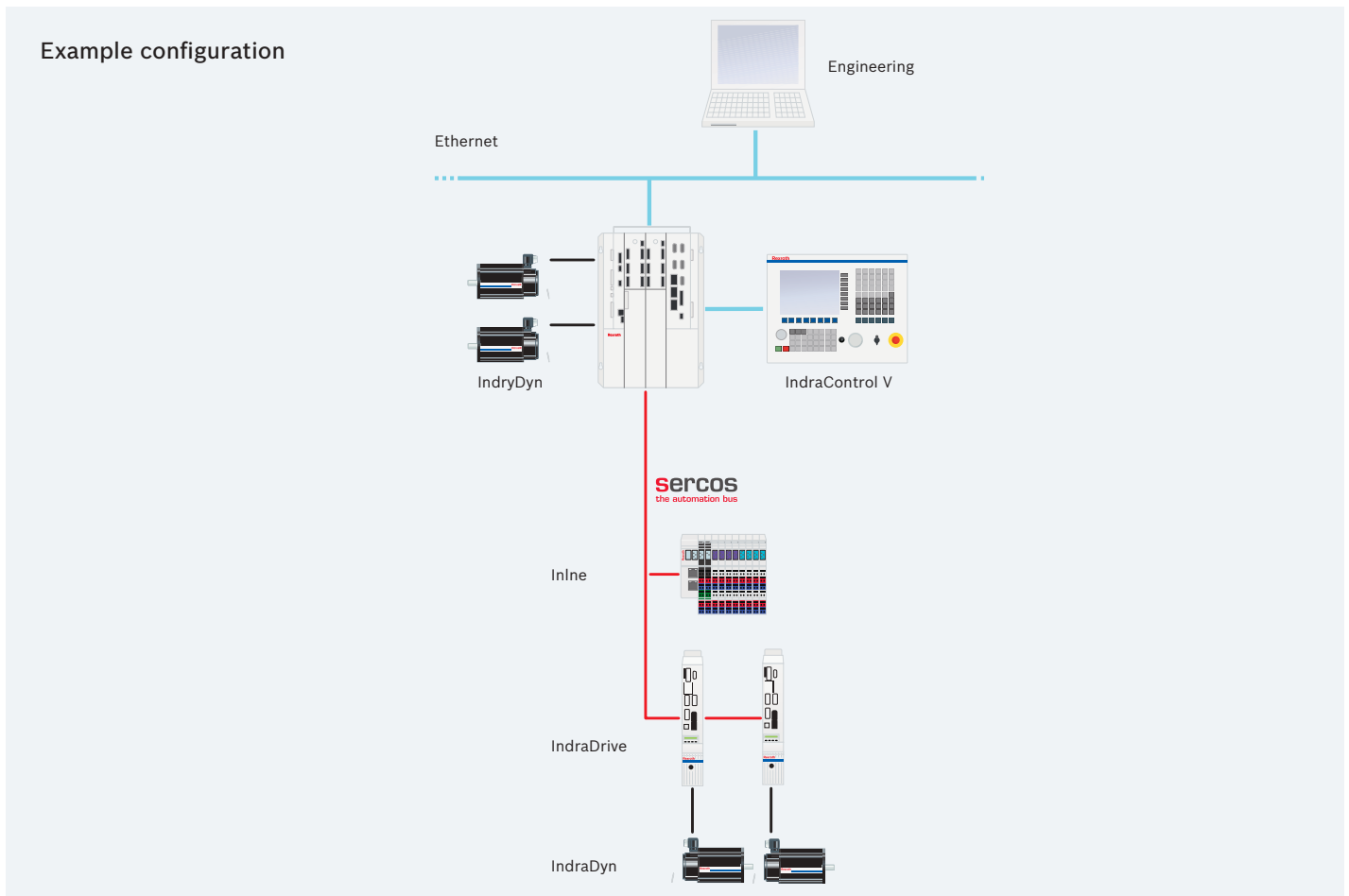

System configuration		
Software		Page(s)
Engineering framework	IndraWorks	60–79
Drive control unit with integrated CNC		
Basic device	IndraDrive HCT, IndraDrive HCQ	See the IndraMotion MTX micro brochure
Option modules	Digital I/O	140–175
Standard interfaces	sercos, Ethernet TCP/IP	–
HMI technology		
Visualization device and operator panel	IndraControl VDP80	See "IndraMotion MTX micro" brochure
Drives and motors		
Drive system for additional axes	IndraDrive	See "Drive System Rexroth IndraDrive"
Servo and main spindle motors	IndraDyn	See "Drive System Rexroth IndraDrive"

IndraMotion MTX micro – ordering data

Ordering data for firmware	
Description	Type code
Firmware for IndraMotion MTX micro	FWA-MICRO*-MTX-xxVRS-NN
Ordering data for software and software options	
Description	Type code
Software DVD, Engineering framework IndraWorks	SWA-IWORKS-MTX-xxVRS-D0-DVD
Single license, IndraWorks (Engineering MTX micro)	SWL-IWORKS-MTX-xxVRS-D0-MICRO
Multiple license (25), ndraWorks (Eengineering MTX micro)	SWL-IWORKS-MTX-xxVRS-D0-MICRO*M25
Software DVD, MTX micro trainer	SWA-MICRO*-MTX-xxVRS-A3-DVD**-TRAINER
Ordering data for hardware	
Description	Type code
Basic device 4-axes, 32 I, 16 O	HCQ02.1E-W0025-A-03-B-L8-1S-NN-NN-NN-FW
Basic device 4-axes, 64 I, 32 O	HCQ02.1E-W0025-A-03-B-L8-1S-D1-NN-NN-FW
Basic device 4-axes, 96 I, 48 O	HCQ02.1E-W0025-A-03-B-L8-1S-D1-D1-NN-FW
Basic device 3-axes, 32 I, 16 O	HCT02.1E-W0025-A-03-B-L8-2S-NN-NN-NN-FW
Basic device 3-axes, 64 I, 32 O	HCT02.1E-W0025-A-03-B-L8-2S-D1-NN-NN-FW
Basic device 3-axes, 96 I, 48 O	HCT02.1E-W0025-A-03-B-L8-2S-D1-D1-NN-FW
Turning control panel	VDP80.1FAN-C1-NN-EN
Milling control panel	VDP80.1FBN-C1-NN-EN
Turning control panel, graphite gray	VDP80.1FGN-C1-NN-EN
Milling control panel, graphite gray	VDP80.1FHN-C1-NN-EN
Universal control panel, graphite gray	VDP80.1FKN-C1-NN-EN
Basic device control panel connecting cable	RKB0030

xx = software/firmware version

Current documentation can be found in the Internet at www.boschrexroth.com/mediadirectory.

IndraMotion MTX standard – system configuration

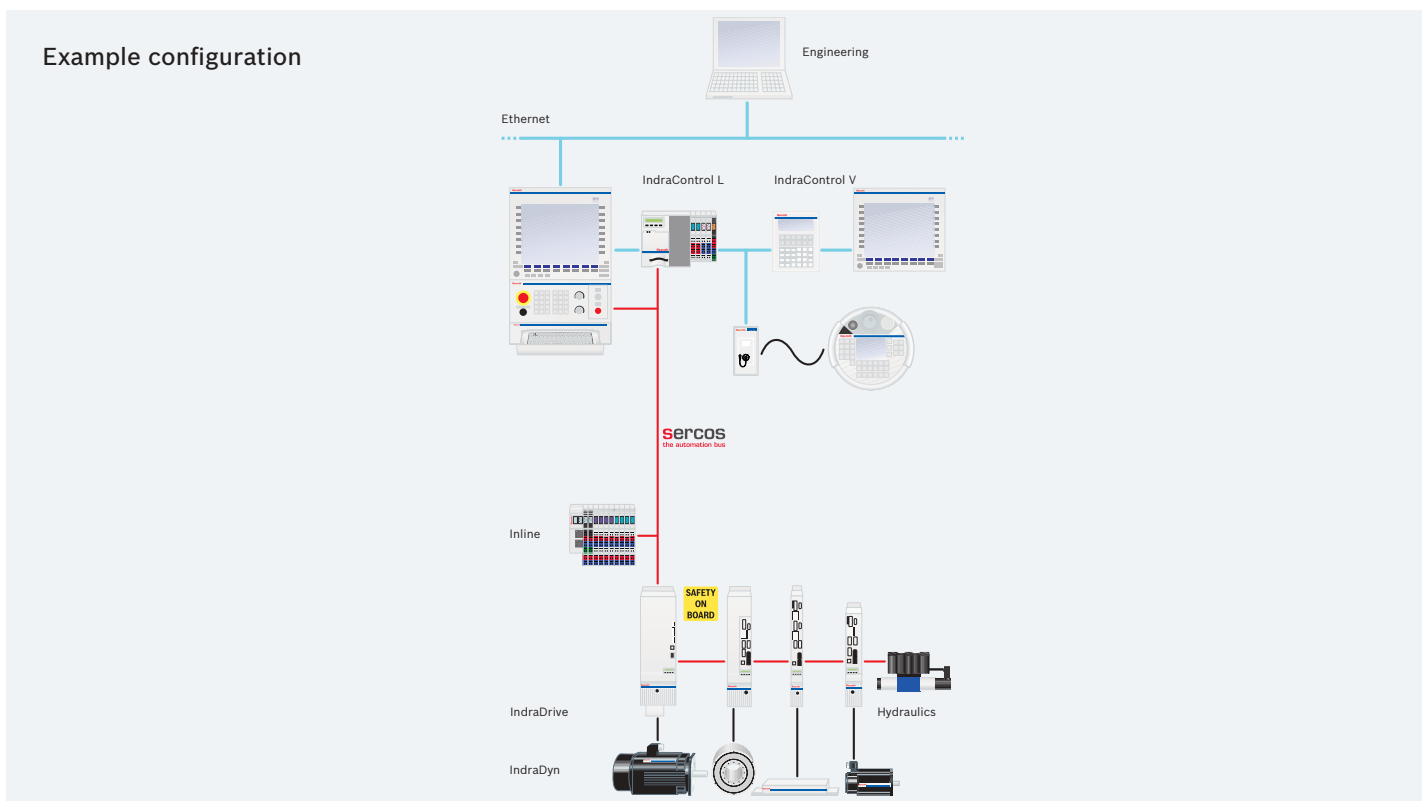

System configuration		
Software		Page(s)
Engineering framework	IndraWorks	60 – 79
Control components		
Control hardware	IndraControl L45	122 – 138
Standard interfaces	sercos, PROFIBUS, Ethernet TCP/IP, EtherNet/IP	–
HMI/PC technology		
Visualization devices, controller-based	IndraControl VCP, VCH	84 – 91
Visualization devices, embedded PC	IndraControl VEP	92 – 97
Visualization devices, industrial PC	IndraControl VPP, IndraControl VPB, VDP	100 – 114
I/O modules		
Distributed input/output modules in IP20	Inline	140 – 175
Distributed input/output modules in IP67	IndraControl S67	188 – 201
Drives and motors		
Drive system	IndraDrive and IndraDyn	See "Drive System Rexroth IndraDrive"

IndraMotion MTX standard – ordering data

Ordering data for firmware	
Description	Type code
Firmware for IndraMotion MTX standard	FWA-CML45*-MTX-xxVRS-NN
Ordering data for software and software options	
Description	Type code
Software DVD, Engineering framework IndraWorks	SWA-IWORKS-MTX-xxVRS-D0-DVD
Single license, IndraWorks (Operation)	SWL-IWORKS-MTX-xxVRS-D0-OPD
Multiple license (25), IndraWorks (Operation)	SWL-IWORKS-MTX-xxVRS-D0-OPD*M25
Single license, IndraWorks (Operation and Engineering)	SWL-IWORKS-MTX-xxVRS-D0-OPDENG
Multiple license (25), IndraWorks (Operation and Engineering)	SWL-IWORKS-MTX-xxVRS-D0-OPDENG*M25
Single license, IndraWorks (Offline Programming)	SWL-IWORKS-MTX-xxVRS-D0-WORKSTATION
Multiple license (25), IndraWorks (Offline Programming)	SWL-IWORKS-MTX-xxVRS-D0-WORKSTATION*M25
Single license, IndraWorks (OPC server)	SWL-IWORKS-MTX-xxVRS-D0-COM
Multiple license (25), IndraWorks (OPC server)	SWL-IWORKS-MTX-xxVRS-D0-COM*M25
Option, technology package – turning 1	SWS-MTX***-RUN-NNVRS-D0-TUR1
Option, technology package – milling 1 (DE/EN)	SWS-MTX***-RUN-NNVRS-D0-BAZ1
Option, electronic gear and system axis coupling	SWS-MTX***-RUN-NNVRS-D0-GEAR
Option, action recorder	SWS-MTX***-RUN-NNVRS-D0-ACR
Option, technology package – shape cutting	SWS-MTX***-RUN-NNVRS-D0-SHC1
Option, cycle time analyzer	SWS-MTX***-RUN-NNVRS-D0-CTA*ANALYZER
Option, cycle time analyzer (on dongle)	SWS-MTX***-RUN-NNVRS-D0-CTA*ANALYZER-DGL
Option, energy analyzer	SWS-MTX***-RUN-NNVRS-D0-EGA*ANALYZER
Option, energy analyzer (on dongle)	SWS-MTX***-RUN-NNVRS-D0-EGA*ANALYZER-DGL
Option, efficiency workbench recorder (for CTA and EGA)	SWS-MTX***-RUN-NNVRS-D0-EWB*RECORDER
Option, remote condition monitoring runtime	SWS-MTX***-RUN-NNVRS-D0-RCM
Option, NC simulation, milling	SWS-MTX***-RUN-NNVRS-D0-SIM*M
Option, NC simulation, turning	SWS-MTX***-RUN-NNVRS-D0-SIM*T
Ordering data for hardware	
Description	Type code
IndraControl L45 with sercos, PROFIBUS	CML45.1-3P-504-NA-NNNN-NW

xx = software/firmware version

Current documentation can be found in the Internet at www.boschrexroth.com/mediadirectory.

IndraMotion MTX performance/advanced – system configuration

Controller-based

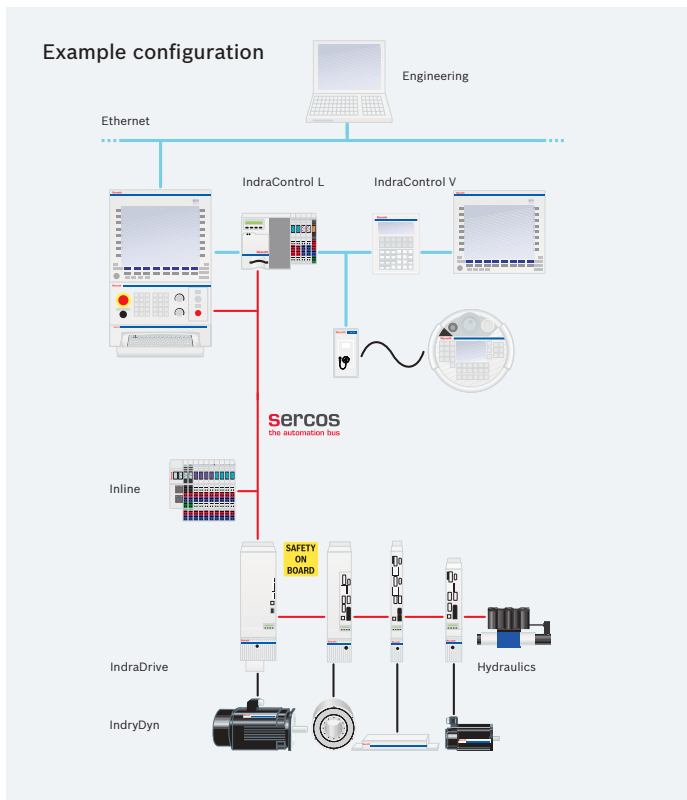

PC-based

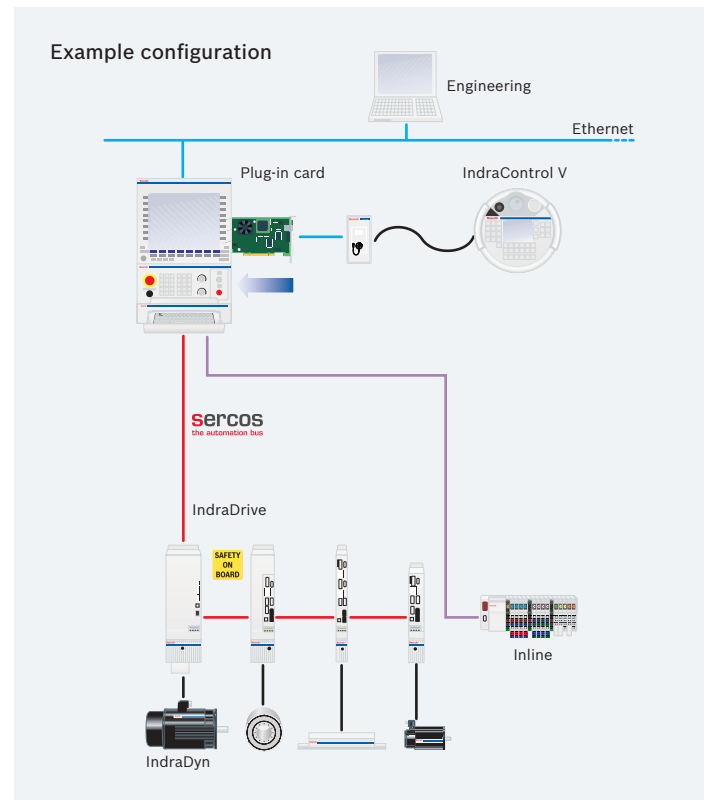

System configuration		
Software		Page(s)
Engineering framework	IndraWorks	60 – 79
Control components		
Control hardware	IndraControl L65, IndraControl L85	122 – 138
Standard interfaces	sercos, PROFIBUS, Ethernet TCP/IP, EtherNet/IP	–
HMI/PC technology		
Visualization devices, controller-based	IndraControl VCP, VCH	84 – 91
Visualization devices, embedded PC	IndraControl VEP	92 – 97
Visualization devices, industrial PC	IndraControl VPP, VPB, VDP	100 – 114
I/O modules		
Distributed input/output modules in IP20	Inline	140 – 175
Distributed input/output modules in IP67	IndraControl S67	188 – 201
Drives and motors		
Drive system	IndraDrive and IndraDyn	See "Drive System Rexroth IndraDrive"

IndraMotion MTX performance/advanced – ordering data

Ordering data for firmware	
Description	Type code
Firmware for IndraMotion MTX performance	FWA-CMP60*-MTX-xxVRS-NN, FWA-CML65*-MTX-xxVRS-NN
Firmware for IndraMotion MTX advanced	FWA-CMP70*-MTX-xxVRS-NN, FWA-CML85*-MTX-xxVRS-NN
Ordering data for software and software options	
Description	Type code
Software DVD, Engineering framework IndraWorks	SWA-IWORKS-MTX-xxVRS-D0-DVD
Single license, IndraWorks (Operation)	SWL-IWORKS-MTX-xxVRS-D0-OPD
Multiple license (25), IndraWorks (Operation)	SWL-IWORKS-MTX-xxVRS-D0-OPD*M25
Single license, IndraWorks (Operation and Engineering)	SWL-IWORKS-MTX-xxVRS-D0-OPDENG
Multiple license (25), IndraWorks (Operation and Engineering)	SWL-IWORKS-MTX-xxVRS-D0-OPDENG*M25
Single license, IndraWorks (Offline Programming)	SWL-IWORKS-MTX-xxVRS-D0-WORKSTATION
Multiple license (25), IndraWorks (Offline Programming)	SWL-IWORKS-MTX-xxVRS-D0-WORKSTATION*M25
Single license, IndraWorks (OPC server)	SWL-IWORKS-MTX-xxVRS-D0-COM
Multiple license (25), IndraWorks (OPC server)	SWL-IWORKS-MTX-xxVRS-D0-COM*M25
Option, technology package – turning 1	SWS-MTX***-RUN-NNVRS-D0-TUR1
Option, technology package – milling 1 (DE/EN)	SWS-MTX***-RUN-NNVRS-D0-BAZ1
Option, technology package – milling 2 (DE/EN)	SWS-MTX***-RUN-NNVRS-D0-BAZ2
Option, electronic gear and system axis coupling	SWS-MTX***-RUN-NNVRS-D0-GEAR
Option, action recorder	SWS-MTX***-RUN-NNVRS-D0-ACR
Option, technology package – shape cutting	SWS-MTX***-RUN-NNVRS-D0-SHC1
Option, cycle time analyzer	SWS-MTX***-RUN-NNVRS-D0-CTA*ANALYZER
Option, cycle time analyzer (on dongle)	SWS-MTX***-RUN-NNVRS-D0-CTA*ANALYZER-DGL
Option, energy analyzer	SWS-MTX***-RUN-NNVRS-D0-EGA*ANALYZER
Option, energy analyzer (on dongle)	SWS-MTX***-RUN-NNVRS-D0-EGA*ANALYZER-DGL
Option, efficiency workbench recorder (for CTA and EGA)	SWS-MTX***-RUN-NNVRS-D0-EWB*RECORDER
Option, remote condition monitoring runtime	SWS-MTX***-RUN-NNVRS-D0-RCM
Option, NC simulation, milling	SWS-MTX***-RUN-NNVRS-D0-SIM*M
Option, NC simulation, turning	SWS-MTX***-RUN-NNVRS-D0-SIM*T
Ordering data for hardware	
Description	Type code
Basic device IndraControl VP with plug-in card IndraControl P60	CFG-VPN01A1-GC-NN-NN
Basic device IndraControl VP with plug-in card IndraControl P60 and high-speed I/O interface (8 I/8 O)	CFG-VPN01A1-GC-IC-NN
Basic device IndraControl VP with plug-in card IndraControl P70	CFG-VPN01A1-WC-NN-NN
Basic device IndraControl VP with plug-in card IndraControl P70 and high-speed I/O interface (8 I/8 O)	CFG-VPN01A1-WC-NO-NN
IndraControl L65 with sercos, PROFIBUS	CML65.1-3P-504-NA-NNNN-NW
IndraControl L85 with sercos, PROFIBUS	CML85.1-3P-504-NA-NNNN-NW

xx = software/firmware version

Current documentation can be found in the Internet at www.boschrexroth.com/mediadirectory.

IndraMotion MLD – drive-based automation solution for single-axis and multi-axis applications

The integrated IndraMotion MLD automation solution is based on the scalable IndraDrive platform. High-performance motion control and PLC functions are joined to form a complete automation system for modern machine concepts. Higher-level controls are no longer necessary. This provides a clear and fast solution for complex control and motion tasks.

The drive-based solution is scalable as a single-axis control for simple applications as well as a multi-axis control for applications with a maximum of 10 axes. Ready-to-use function libraries simplify the use of intelligent drive functions of IndraDrive. In addition, function blocks according to PLCopen provide access to standardized motion control functions. The open technology and communication interfaces simplify integration of IndraMotion MLD in the automation design.

Your benefits

- ▶ Compact system for modular distributed architectures
- ▶ Scalable as single-axis or multi-axis control
- ▶ Electronic synchronization of up to 10 servo-axes
- ▶ Ready-to-use function libraries according to PLCopen
- ▶ Integrated intelligent drive functions
- ▶ Optional interfaces for communication, safety and additional encoder
- ▶ Drive-integrated motion control and PLC according to IEC 61131-3
- ▶ Certified safety technology according to EN ISO 13849-1, category 3 PL d and EN 62061 SIL 2
- ▶ Intuitive engineering framework IndraWorks for project development, programming, visualization and diagnostics
- ▶ Software options with technology packages and turnkey solutions



IndraMotion MLD from Rexroth helps you to integrate your valuable know-how directly in the drive, thus ensuring your competitive edge.

Compact, intelligent and economic

- ▶ Very cost-effective solution for single-axis and multi-axis applications without any additional hardware
- ▶ Minimized engineering through conformity with IEC and PLCopen
- ▶ Faster implementation of your system solution through predefined technology packages



As a sub-system, IndraMotion MLD can be flexibly integrated in the most varied machines and systems and ensures the highest productivity and efficiency in many applications:

- ▶ Machine tools
- ▶ Production machines
- ▶ Process systems
- ▶ Heavy load handling
- ▶ Automotive
- ▶ Renewable energies
- ▶ Cellulose and paper
- ▶ Solar technology

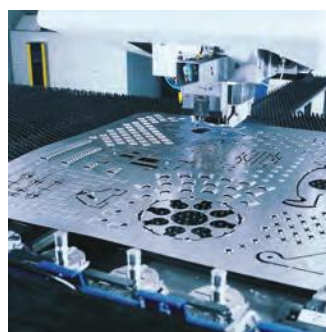

IndraMotion MLD controls drive-based compact systems, as well as modules in a complex system, that demand extremely precise and fast drive synchronization in the following areas:

- ▶ Packaging technology
- ▶ Printing presses and processing machines
- ▶ Forming machines and simple machine tools
- ▶ Bending and drawing machines, spinning lathes
- ▶ Press automation
- ▶ Nibbling and punching
- ▶ Wood processing
- ▶ Assembly and handling
- ▶ Transfer and transport
- ▶ Warehouses and storage



IndraMotion MLD – technical data

		MLD-M IndraDrive Cs	MLD-M IndraDrive C/M	MLD-S IndraDrive Cs	MLD-S IndraDrive C/M	MLD-S IndraDrive Mi
Control						
Runtime system	Integrated motion logic systems	●	●	●	●	●
Multitasking		●	●	●	●	●
Data management	Code, data, retentive data, user data	●	●	●	●	●
Storage	Boot project	●	●	●	●	●
	PLC project as packed archive file	●	●	●	●	●
	User data to the internal memory and a removable storage medium	●	●	●	●	●
Support	System events	●	●	●	●	●
Probe function, control		○	○	○	○	○
User memory	Total: code, data	4 MB	4 MB	512 kB	512 kB	512 kB
Retentive memory	Total: system, user	32 kB	32 kB	32 kB	32 kB	32 kB
On-board diagnosis and settings						
Status display (boot, sercos, test)	Display	●	●	●	●	–
Errors, warnings, messages, system reset	Display, keys	●	●	●	●	–
Ethernet settings (IP address)	Display, keys	●	●	●	●	–
Voltage monitoring, watchdog		●	●	●	●	●
Relay output ready for operation		●	●	●	●	●
IndraMotion service tool		▼	▼	–	–	–
On-board communication interfaces						
sercos III	Automation bus (master)	●	●	○	○	▼
	Automation bus (slave)	○	○	○	○	▼
Multi-Ethernet		●	●	●	○	▼
sercos II	Real-time motion bus	○	○	○	○	○
PROFIBUS	Slave	○	○	○	○	–
PROFINET IO	Device (slave)	○	○	○	○	▼
EtherNet/IP	Adapter (slave)	○	○	○	○	▼
DeviceNet	Slave	–	○	–	○	–
EtherCAT	Slave	○	○	○	○	▼
Ethernet TCP/IP		●	●	●	○	▼
ModbusTCP	Server (slave)	○	○	○	○	▼
CANopen	Slave	▼	○	▼	○	–
RS232	On-board	–	●	–	●	–

● Default ▼ In preparation ○ Optional – Not available

		MLD-M IndraDrive Cs	MLD-M IndraDrive C/M	MLD-S IndraDrive Cs	MLD-S IndraDrive C/M	MLD-S IndraDrive Mi
Options						
Encoder	Number	Max. 2	Max. 2	Max. 2	Max. 2	Max. 1
Encoder emulation	Number	–	Max. 1	–	Max. 1	–
HMI						
IndraControl VCP, VCH	Ethernet TCP/IP, OPC	○	○	○	○	○
IndraControl VEP, VEH	Ethernet TCP/IP, OPC	○	○	○	○	○
IndraControl VSP, VPP, VSB/VDP, VPB/VDP	Ethernet TCP/IP, OPC	○	○	○	○	○
Inputs/outputs						
On-board						
Digital inputs	Number	5	3	5	4	5
Digital inputs/outputs (any adjustment)	Number	1	4	1	3	1
High-speed digital inputs (probe)	Number/sampling time	2/500 μs	2/41 μs	2/500 μs	1/83 μs	2/500 μs
Analog inputs/outputs		1 / –	1 / 2	1 / –	Max. 2/–	–
Local						
Analog inputs/outputs		–	Max. 2/2	–	Max. 2/2	–
Digital inputs/outputs		–	Max. 16/16	–	Max. 16/16	–
Distributed via Inline (IP20)						
sercos III	On-board	●	●	○	○	▼
Logic control						
PLC runtime system						
IndraLogic 1G kernel	Conf. with IEC 61131-3	●	●	●	●	●
Program organization	According to IEC 61131-3	●	●	●	●	●
Loading and executing IEC-61131-3 applications		●	●	●	●	●
Task management						
Freely configurable tasks (priority 0-20)	Cyclic, free-running, event-controlled, externally event-controlled	4	4	4	4	4
Task-synchronous processing of the I/O process image		●	●	●	●	●
sercos III-synchronous processing of the I/O process image		●	●	●	●	●
Min. PLC cycle time	Synch. with system cycle	1 ms	1 ms	1 ms	1 ms	1 ms
	Synch. with sercos cycle	1 ms	1 ms	1 ms	1 ms	1 ms
Min. motion cycle time	Set value generator	0.25 ms	0.25 ms	1 ms	1 ms	1 ms
PLC processing times						
Typical processing time for 1,000 instructions/μs	Command mix (real, integer, bool, etc.)	50	50	100	260	260
	Bool operations	50	50	100	270	270
	Word operations	45	45	90	240	240

● Default ▼ In preparation ○ Optional – Not available

IndraMotion MLD – technical data

		MLD-M IndraDrive Cs	MLD-M IndraDrive C/M	MLD-S IndraDrive Cs	MLD-S IndraDrive C/M	MLD-S IndraDrive Mi
Motion control						
Number of axes	Real/virtual/encoder/grouped	1 / 10 / 2 / 1	1 / 10 / 2 / 1	1 / 1 / 2 / 0	1 / 1 / 2 / 0	1 / 1 / 2 / 0
Synchronization (ELS – electronic line shaft)	Real axes (servo drives)	●	●	●	●	●
	Virtual axes (virtual masters)	●	●	●	●	●
	Encoder axes (real masters)	●	●	●	●	●
	Grouped axes (cross communication)	●	●	–	–	–
	Dynamic synchronization	●	●	●	●	●
	Master axis cascading	●	●	–	–	–
Positioning	Single-axis	●	●	●	●	●
Electronic gears		●	●	●	●	●
Electronic cams	Intermediate point tables (in the drive, max. 1,024 intermediate points)	4	4	4	4	4
	Electronic motion profile (in the control, motion profiles with max. 8 segments)	2	2	2	2	2
Torque control		●	●	●	●	●
Velocity control		●	●	●	●	●
Motion commands according to PLCopen (choice)	MC_MoveAbsolute	●	●	●	●	●
	MC_MoveRelative	●	●	●	●	●
	MC_MoveVelocity	●	●	●	●	●
	MC_CamIn, MC_CamOut	●	●	●	●	●
	MC_GearIn, MC_GearOut	●	●	●	●	●
Extended motion commands (choice)	MB_ReadListParameter	●	●	●	●	●
	MB_WriteListParameter	●	●	●	●	●
	MB_GearInPos	●	●	●	●	●
	MB_PhasingSlave	●	●	●	●	●
	MB_Home	●	●	●	●	●
	MB_ClearAllError	●	●	●	●	●
Extended system functions (choice)						
Programmable limit switches		○	○	○	○	○
Encoder		○	○	○	○	○
Fault tolerance for failure of connected devices		●	●	○	○	○
	I/O	●	●	○	○	○
Ring healing and redundancy	Drives	●	●	–	–	–
		●	●	○	○	○

● Default ▼ In preparation ○ Optional – Not available

		MLD-M IndraDrive Cs	MLD-M IndraDrive C/M	MLD-S IndraDrive Cs	MLD-S IndraDrive C/M	MLD-S IndraDrive Mi
Technology functions (choice)						
Crank kinematics		○	○	○	○	○
Cross cutter		○	○	–	–	–
Flying cut-off		○	○	○	○	○
Tension control		○	○	–	–	–
Register control		○	○	○	○	○
Winder		○	○	○	○	○
Smart belt		○	○	○	○	○
Diagnosis						
Diagnosis (status, warnings, errors)	Function blocks (software)	●	●	●	●	●
	Parameter access to diagnosis memory (software)	●	●	●	●	●
	Locally via display (control hardware)	●	●	●	●	●
	Axis monitoring (e.g. capacity, encoders, limit values)	●	●	●	●	●
	Diagnosis memory (64 kB, max. 999 messages)	●	●	●	●	●
Debugging monitor for IEC applications		●	●	●	●	●
Drive systems						
IndraDrive		●	●	–	–	–
IndraDrive Mi	MPB firmware	▼	▼	–	–	–
IndraDrive Cs		●	●	–	–	–
Master communication	sercos III	●	●	●	●	●
Min. sercos III cycle time		0.25 ms	0.25 ms	1 ms	1 ms	1 ms
Engineering and operation						
IndraWorks		○	○	○	○	○
IndraMotion service tool		▼	▼	–	–	–

● Default ▼ In preparation ○ Optional – Not available

IndraMotion MLD – system configuration

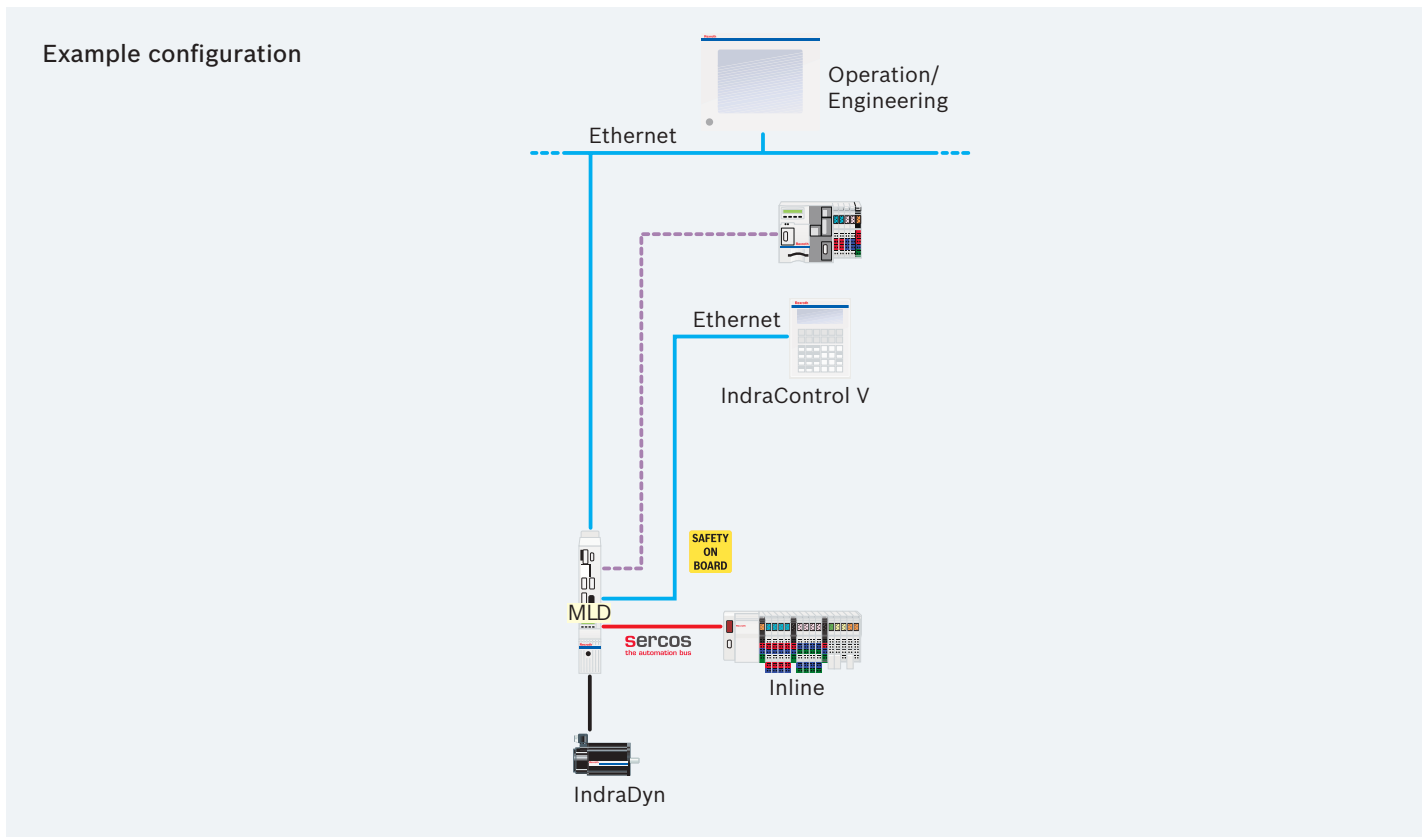

System configuration		
Software		Page(s)
Engineering framework	IndraWorks	60 – 79
HMI		
Manual operator panel	IndraControl VxH	90f/98f
Compact operator panel	IndraControl VCP	84 – 89
Embedded PC	IndraControl VEP	92 – 97
Panel PC	IndraControl VPP	100 – 103
Standard interfaces	Ethernet TCP/IP	–
I/O modules		
Local and distributed input/output modules in IP20	Inline	140 – 175
Standard interfaces	sercos III	–
Drives and motors		
Control/drive system	IndraDrive and IndraDyn	See "Drive System Rexroth IndraDrive"
Standard interfaces	sercos III	–

IndraMotion MLD – ordering data

Ordering data for firmware	
Description	Type code
Firmware IndraDrive BASIC with option TF (with PLC capable for technology functions)	FWA-INDRV*-MPB-xxVRS-xx-x-xxx-TF
Firmware IndraDrive ADVANCED with option ML (with PLC capable for technology functions)	FWA-INDRV*-MPH-xxVRS-xx-x-xxx-ML
Firmware IndraDrive ADVANCED with option MA (with PLC capable for extensive technology functions)	FWA-INDRV*-MPH-xxVRS-D5-1-ALL-MA
Technology function Rollfeed Standard for IndraMotion MLD-S, based on IndraDrive ADVANCED	FWS-MLDTFA-RFS-xxVRS-D0
Technology function Rollfeed Standard for IndraMotion MLD-S, based on IndraDrive BASIC	FWS-MLDTFB-RFS-xxVRS-D0
Technology function Rollfeed Extended for IndraMotion MLD-S, based on IndraDrive ADVANCED	FWS-MLDTFA-RFE-xxVRS-D0
Technology function Flying Shear for IndraMotion MLD-S, based on IndraDrive ADVANCED	FWS-MLDTFA-SPF-xxVRS-D0
Technology function Sequential Motion Control for IndraMotion MLD-S, based on IndraDrive ADVANCED	FWS-MLDTFA-SMC-xxVRS-D0
Ordering data for software	
Description	Type code
Software DVD, Engineering framework IndraWorks for IndraDrive drives (parameterization)	SWA-IWORKS-D*-xxVRS-D0-DVD**-COPY
Software DVD, Engineering framework IndraWorks for IndraDrive drives (service tool)	SWA-IWORKS-DS*-xxVRS-D0-DVD**-COPY
Software DVD, Engineering framework IndraWorks for IndraMotion MLD	SWA-IWORKS-MLD-xxVRS-D0-DVD**-COPY
Single license, for IndraWorks tool CamBuilder	SWS-IWORKS-CAM-xxVRS-D0
Software CD technology functions for IndraMotion MLD	SWA-IM*MLD-LTE-xxVRS-D0-CD650-COPY
Software CD technology functions for IndraMotion for Handling	SWA-IM*ML*-LHA-xxVRS-D0-CD650-COPY
Ordering data for hardware	
Description	Type code
Control and drive platform	See product catalog "Drive System Rexroth IndraDrive"

xx = IndraDrive configuration or software/firmware version

Current documentation can be found in the Internet at www.boschrexroth.com/mediadirectory.

IndraMotion MLC – controller-based solution with motion, robot and logic control

The compact Rexroth IndraMotion MLC motion logic system gives you any freedom you wish for your consistent and modern machine automation. Innovative software and firmware functions, easy engineering and open system interfaces provide maximum flexibility in all motion applications.

By combining motion, robot and logic control with technology functions, you can synchronize multi-axis applications very easily – freely scalable for central or decentralized solutions with a flexible control platform. Motion functions, such as master axes, electronic gears, electronic cams and the innovative FlexProfile for complex motion sequences, can be used quickly and transparently. Robot control provides full functionality for multi-axis path interpolation in space. Hydraulic axes can be integrated into the automation solution just as fast and just as simply, with the same tools and functions. The engineering framework IndraWorks with intuitive operation and the PLCopen-compliant software interface with standardized function blocks according to IEC 61131-3 facilitate integration in various machine designs.



Regardless whether you are using electric or hydraulic drive technology: The motion logic system IndraMotion MLC is the answer for all tasks demanding easy engineering, flexible process adjustments, and cost-optimized automation.

Your benefits

- ▶ Quick integration in various processes, machines and systems
- ▶ Compact and powerful control platform IndraControl L
- ▶ Scalable for centralized and distributed architectures with maximum performance
- ▶ Open communication interfaces for integration in heterogeneous control topologies
- ▶ Integrated runtime system with motion, robot and logic controls
- ▶ Extensive software libraries in conformity with IEC 61131-3 and PLCopen
- ▶ Industry-specific library functions
- ▶ Innovative motion function FlexProfile for complex motion sequences
- ▶ IndraWorks – one tool for all engineering tasks

IndraMotion MLC is the integrated controller-based system solution from Rexroth. Ready-to-use technology functions accelerate engineering, for example in packaging and handling applications.

Simple, open and flexible

- ▶ Overall solution with integrated motion logic
- ▶ Simple in use and scalable in performance and function
- ▶ Optimum performance for all mechatronic solutions



As a centralized motion logic system, IndraMotion MLC can be used for all single- and multi-axis applications with the highest synchronicity and optimum motion design:

- ▶ Up to 64 axes
- ▶ Synchronous movements with time and position-dependent segments
- ▶ Support of hydraulic axes
- ▶ Robot control with multi-axis path interpolation
- ▶ Electronic programmable limit switches with sampling rates of up to 125 μ s and 64 outputs



With an open system architecture, IndraMotion MLC is the ideal system solution for all automation tasks, such as:

- ▶ Packaging
- ▶ Printing
- ▶ Moving
- ▶ Positioning
- ▶ Forming
- ▶ Pressing
- ▶ Assembly and handling



IndraMotion MLC – technical data

		MLC L40 1G	MLC L65 1G	MLC L25	MLC L45	MLC L65
Control						
System						
Runtime system	Integrated motion logic system	●	●	●	●	●
Multitasking		●	●	●	●	●
Data management for code, data, retentive data, user data		●	●	●	●	●
Boot project storage		●	●	●	●	●
Storage of control projects as packed archive file		●	●	●	●	●
Storage of user data to the internal memory and a removable storage medium		●	●	●	●	●
Support of function modules		4	4	2	4	4
Support of system events		●	●	●	●	●
Probe function, control		●	●	○	●	●
User memory	Total: code, data	24 MB	36 MB	12 MB	24 MB	36 MB
Retentive memory	Total: system, user	128 kB	256 kB	256 kB	256 kB	256 kB
On-board diagnosis and settings						
Status display	LED	●	●	●	●	●
Status display (boot, sercos, test)	Display	●	●	●	●	●
Errors, warnings, messages, system reset	Display, keys	●	●	●	●	●
Ethernet settings (IP address)	Display, keys	●	●	●	●	●
Voltage monitoring, watchdog	LED	●	●	●	●	●
Relay output ready for operation	LED	●	●	●	●	●
IndraMotion Service Tool	Web-based engineering	–	–	●	●	●

● Default ▼ In preparation ○ Optional

		MLC L40 1G	MLC L65 1G	MLC L25	MLC L45	MLC L65
On-board communication interfaces						
sercos III	Real-time Ethernet bus	–	●	●	●	●
sercos II	Real-time motion bus	●	○	○	○	○
Master axis grouping	sercos II	○	○	○	○	○
	sercos III	○	○	○	○	○
	Number of controls in control link	64	64	64	64	64
PROFIBUS	Master	●	●	–	●	●
	Slave	●	–	–	●	●
PROFINET IO	Controller (master)	–	–	○	○	○
	Device (slave)	–	–	○	○	○
EtherNet/IP	Scanner (master)	–	–	▼	▼	▼
	Adapter (slave)	–	–	○	○	○
Ethernet TCP/IP		●	●	●	●	●
Control link	Ethernet TCP/UDP/IP	●	●	●	●	●
RS232		●	–	–	–	–
Function modules						
Number		4	4	2	4	4
PROFIBUS master/slave		○	○	–	–	–
Real-time Ethernet/PROFIBUS		–	–	○	○	○
DeviceNet master		○	○	–	–	–
Real-time Ethernet/DeviceNet		–	–	▼	▼	▼
sercos III/master axis grouping		○	○	○	○	○
sercos II/master axis grouping		○	○	○	○	○
Programmable limit switches		○	○	○	○	○
SRAM		○	○	○	○	○
Fast I/O		○	○	○	○	○
HMI						
IndraControl VCP, VCH	Ethernet TCP/IP, OPC	○	○	○	○	○
IndraControl VEP, VEH	Ethernet TCP/IP, OPC	○	○	○	○	○
IndraControl VSP, VPP, VSB/VDP, VPB/VDP	Ethernet TCP/IP, OPC	○	○	○	○	○
Inputs/outputs						
On-board						
High-speed digital inputs	Interrupt capability, typ. 50 µs	8	8	–	8	8
High-speed digital outputs	0.5 A, typ. 500 µs	8	8	–	8	8

● Default ▼ In preparation ○ Optional – Not available

IndraMotion MLC – technical data

		MLC L40 1G	MLC L65 1G	MLC L25	MLC L45	MLC L65
Inputs/outputs						
Local						
High-speed digital inputs (FAST I/O function module)	Interrupt capability, typ. 40 µs	○	○	○	○	○
High-speed digital outputs (FAST I/O function module)	0.5 A, typ. 70 µs	○	○	○	○	○
Inline (digital, analog, relay, technology)	64 bytes, max. 512 I/O	○	○	○	○	○
Distributed via Inline (IP20)						
sercos III	On-board/function module	-/○	○/○	○/○	○/○	○/○
PROFIBUS	On-board/function module	○	○	○	○	○
DeviceNet	Function module	○	○	-	-	-
Distributed via Fieldline (IP67)						
PROFIBUS	On-board/function module	-/○	○/○	○/○	○/○	○/○
DeviceNet	Function module	○	○	-	-	-
Distributed via IndraControl S67 (IP67)						
sercos III	On-board/function module	-/○	○/○	○/○	○/○	○/○
PROFIBUS	On-board/function module	-/○	○/○	○/○	○/○	○/○
DeviceNet	On-board/function module	○	○	-	-	-
Logic control						
PLC runtime system						
PLC kernel - IndraLogic 1G	Conforming with IEC 61131-3	●	●	-	-	-
PLC kernel - IndraLogic 2G	Conforming with IEC 61131-3 with extensions	-	-	●	●	●
Program organization	According to IEC 61131-3	●	●	●	●	●
Loading and executing IEC 61131-3 applications		●	●	●	●	●
Task management						
Freely configurable tasks (priority 1-20)	Cyclic, free-running, event-controlled, externally event-controlled	8	8	8	8	8
Cycle-synchronous processing of the I/O process image		●	●	●	●	●
sercos III-synchronous processing of the I/O process image		-	-	●	●	●
Min. PLC cycle time	Synchronous to the system cycle	1 ms	1 ms	1 ms	1 ms	1 ms
	Synchronous to the sercos cycle	-	-	1 ms	0.5 ms	0.25 ms
Min. motion cycle time	Set value generation	1 ms	1 ms	2 ms	1 ms	1 ms
PLC processing times						
Command mix (real, integer, word, bool, etc.)	Per 1,000 instructions	50 µs	5 µs	35 µs	30 µs	5 µs
Bool operations	Per 1,000 instructions	50 µs	5 µs	20 µs	30 µs	5 µs
Word operations	Per 1,000 instructions	50 µs	5 µs	20 µs	30 µs	5 µs

● Default ▼ In preparation ○ Optional - Not available

		MLC L40 1G	MLC L65 1G	MLC L25	MLC L45	MLC L65
Motion control						
Number of axes	Virtual, real, encoder, grouped	32	64	16	32	64
Control axis	Centrally controlled	–	–	4	8	32
Synchronization (ELS – electronic line shaft)	Virtual axes (virtual masters)	●	●	●	●	●
	Encoder axes (real axis)	●	●	●	●	●
	Real axes (servo drives)	●	●	●	●	●
	Grouped axes (cross communication)	●	●	●	●	●
	Dynamic synchronization	●	●	●	●	●
	Master axis cascading	●	●	●	●	●
Positioning	Single-axis	●	●	●	●	●
Electronic gears		●	●	●	●	●
Electronic cams	Intermediate point tables (in the drive, max. 1,024 intermediate points)	4	4	4	4	4
	Electronic motion profile (in the control, motion profile with max. 16 segments)	2	2	2	2	2
	FlexProfile (in the control, master/time-based motion profiles with max. 16 segments)	4	4	4	4	4
Motion commands according to PLCopen (choice)	MC_MoveAbsolute	●	●	●	●	●
	MC_MoveRelative	●	●	●	●	●
	MC_MoveVelocity	●	●	●	●	●
	MC_Home	●	●	●	●	●
	MC_CamIn, MC_CamOut	●	●	●	●	●
	MC_GearIn, MC_GearOut	●	●	●	●	●
Extended motion commands (choice)	MB_ReadListParameter	●	●	●	●	●
	MB_WriteListParameter	●	●	●	●	●
	MB_GearInPos	●	●	●	●	●
	ML_PhasingSlave	●	●	●	●	●
	MB_ClearAxisError	●	●	●	●	●
	MB_ClearSystemError	●	●	●	●	●
Hydraulics functions						
Best-in-class control		–	–	●	●	●
Synchronizer (active/passive)		–	–	●	●	●
Control transfer		–	–	●	●	●
Force ramps/curves		–	–	●	●	●
Travel-dependent deceleration		–	–	●	●	●
FcP/SvP control		–	–	●	●	●

● Default ▼ In preparation ○ Optional – Not available

IndraMotion MLC – technical data

		MLC L40 1G	MLC L65 1G	MLC L25	MLC L45	MLC L65
Robot control						
Number of axes per kinematic		16	16	16	16	16
Multi-axis kinematics	Incl. auxiliary axes	16	16	16	16	16
Kinematics transformations		●	●	●	●	●
LINEAR, CIRCULAR, PTP types of interpolation		●	●	●	●	●
Configurable block transitions		●	●	●	●	●
Override		●	●	●	●	●
Teach-in function		●	●	●	●	●
Approximate positioning		●	●	●	●	●
Late blending		–	–	●	●	●
Belt synchronization		●	●	●	●	●
Jogging/single step		–	–	●	●	●
Speed limitation	For path and axes	●	●	●	●	●
Acceleration limitation	For path and axes	●	●	●	●	●
Safety zones		▼	▼	▼	▼	▼
Extended system functions (choice)						
Programmable limit switches		●	●	●	●	●
PID control		●	●	●	●	●
Temperature control		●	●	●	●	●
Technology functions (choice)						
Crank kinematics		●	●	●	●	●
Cross cutter		●	●	●	●	●
Flying shear		●	●	●	●	●
Sag control		●	●	●	●	●
Tension control		●	●	●	●	●
Register control		–	–	●	●	●
Winder		●	●	●	●	●
Magic belt		–	–	●	●	●
Smart belt		–	–	●	●	●
Hydraulic axes		–	–	●	●	●

● Default ▼ In preparation ○ Optional – Not available

		MLC L40 1G	MLC L65 1G	MLC L25	MLC L45	MLC L65
Diagnosis						
Status, warnings, errors	Function blocks (software)	●	●	●	●	●
	Parameter access to diagnosis memory (software)	●	●	●	●	●
	Locally via display (control hardware)	●	●	●	●	●
	Axis monitoring (e.g. capacity, encoders, limit values)	●	●	●	●	●
	Diagnosis memory (64 kB, max. 999 messages)	●	●	●	●	●
Debugging monitor for IEC 61131-3 application	●	●	●	●	●	
Engineering						
IndraWorks		○	○	○	○	○
IndraMotion Service Tool (IMST)		–	–	○	○	○
Drive systems						
Electric axes						
IndraDrive	BASIC and ADVANCED with MPB/MPH firmware	●	●	●	●	●
	Dual-axis control units with MPD firmware	●	●	●	●	●
IndraDrive Mi	With MPB firmware	●	●	●	●	●
IndraDrive Cs		●	●	●	●	●
EcoDrive Cs		●	●	●	●	●
sercos pack profiles		●	●	●	●	●
Master communication	sercos III	●	●	●	●	●
Min. sercos III cycle time		1 ms	1 ms	1 ms	0.5 ms	0.25 ms
Hydraulic axes						
HNC100.3	Hydraulic drive	●	●	●	●	●

● Default ▼ In preparation ○ Optional – Not available

IndraMotion MLC – system configuration

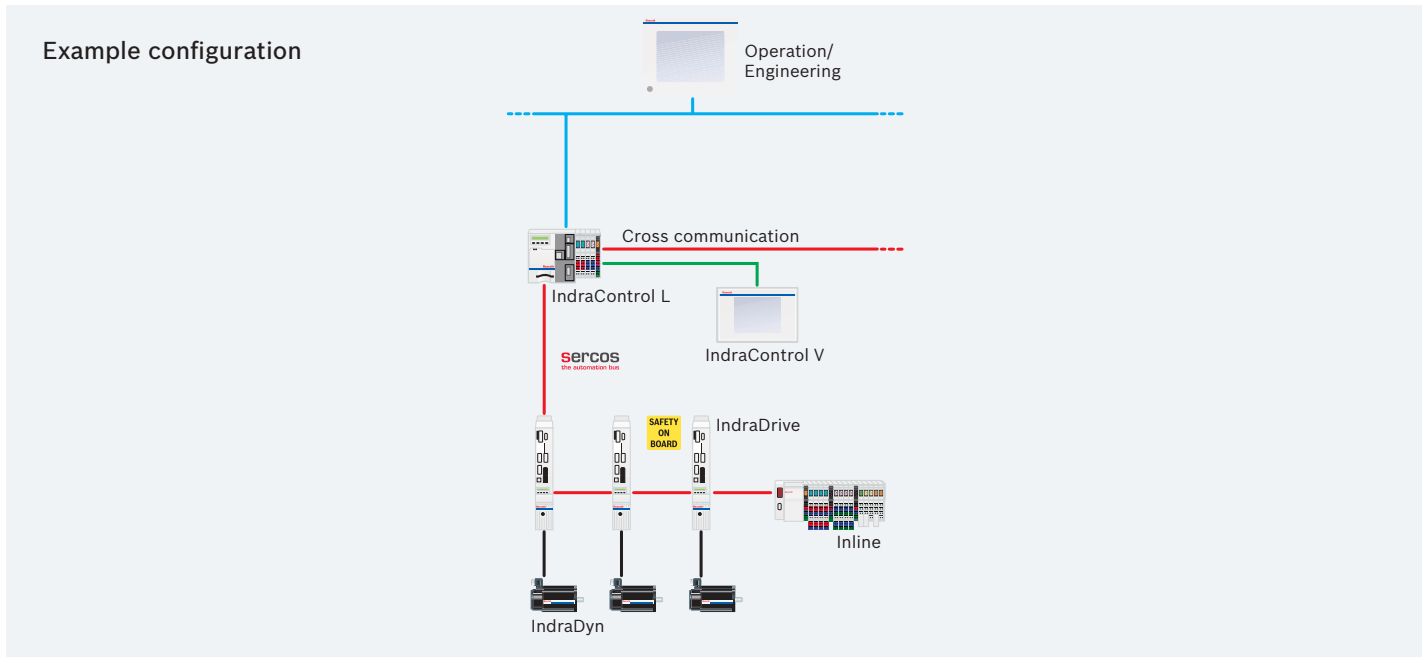

System configuration		
Software		Page(s)
Engineering framework	IndraWorks	60 – 79
Control components		
Control hardware	IndraControl L25	128
	IndraControl L40	129
	IndraControl L45	130
	IndraControl L65	131
Function modules	Cross communication/sercos II	133 – 136
	sercos III	133 – 136
	PROFIBUS master	133 – 136
	DeviceNet master	133 – 136
	Real-time Ethernet/PROFIBUS	133 – 136
	Programmable limit switches	133 – 136
	Fast I/O	133 – 136
SRAM	133 – 136	
HMI/PC technology		
Visualization devices, controller-based	IndraControl VCP, VCH	84 – 91
Visualization devices, embedded PC	IndraControl VEP	92 – 97
Visualization devices, high-end industrial PC	IndraControl VPP	100 – 103
Standard interfaces	Ethernet TCP/IP, PROFIBUS	–
I/O modules		
Local and distributed input/output modules in IP20	Inline	140 – 175
Distributed input/output modules in IP67	IndraControl S67, Fieldline	188 – 201
Standard interface	PROFIBUS, sercos III	–
Drives and motors		
Control/drive system	IndraDrive and IndraDyn	See "Drive System Rexroth IndraDrive"
Standard interface	sercos II (IndraControl L40)	–
	sercos III (IndraControl L25, L45, L65)	–

IndraMotion MLC¹⁾ – ordering data

Ordering data for firmware	
Description	Type code
Firmware for IndraControl L40	FWA-CML402-MLC-xxVRS-D0
Firmware for IndraControl L65	FWA-CML65*-MLC-xxVRS-D0
Ordering data for software	
Description	Type code
Single license, Engineering framework IndraWorks MLC	SWA-IWORKS-ML*-xxVRS-D0-CD650
Multiple license (25), Engineering framework IndraWorks MLC	SWA-IWORKS-ML*-xxVRS-D0-CD650-MUL
Single license, IndraWorks CamBuilder	SWS-IWORKS-CAM-xxVRS-D0
Software CD, technology functions for IndraMotion for Handling	SWA-IM*ML*-LHA-xxVRS-D0-CD650-COPY
Ordering data for hardware	
Description	Type code
Control hardware IndraControl L40 with sercos II and PROFIBUS	CML40.2-SP-330-NA-NNNN-NW
Control hardware IndraControl L65 with sercos III, PROFIBUS and real-time Ethernet	CML65.1-3P-500-NA-NNNN-NW
Control hardware IndraControl L65 with SRAM, sercos III, PROFIBUS and real-time Ethernet	CML65.1-3P-504-NA-NNNN-NW
IndraControl L function module, sercos III	CFL01.1-R3
IndraControl L function module, cross communication (sercos II)	CFL01.1-Q2
IndraControl L function module, PROFIBUS master	CFL01.1-P1
IndraControl L function module, DeviceNet master	CFL01.1-V1
IndraControl L function module, programmable limit switches	CFL01.1-N1
IndraControl L function module, Fast I/O	CFL01.1-E2
IndraControl L function module, SRAM	CFL01.1-Y1

xx = software/firmware version

¹⁾ Based on 1st generation PLC kernel

Current documentation can be found in the Internet at www.boschrexroth.com/mediadirectory.

IndraMotion MLC²⁾ – ordering data

Ordering data for firmware	
Description	Type code
Firmware for IndraControl L25	FWA-CML25*-MLC-xxVRS-D0
Firmware for IndraControl L45	FWA-CML45*-MLC-xxVRS-D0
Firmware for IndraControl L65	FWA-CML65*-MLC-xxVRS-D0
Single license, Extended Register Controller	FWS-IM*MLC-TEC-12VRS-NN-REGI*EXT
Single license, Extended Register Controller	FWS-IM*MLC-TEC-12VRS-NN-REGI*ADV
Single license, Advanced Tension Controller	FWS-IM*MLC-TEC-NNVRS-NN-TENS*ADV
Multiple license (10), Advanced Tension Controller	FWS-IM*MLC-TEC-NNVRS-NN-TENS*ADVM10
Multiple license (25), Advanced Tension Controller	FWS-IM*MLC-TEC-NNVRS-NN-TENS*ADVM25
Ordering data for software	
Description	Type code
Software DVD, Engineering framework IndraWorks	SWA-IWORKS-ML*-xxVRS-D0-DVD
Single license, IndraWorks Engineering	SWL-IWORKS-ML*-xxVRS-D0-ENG
Multiple license (25), IndraWorks Engineering	SWL-IWORKS-ML*-xxVRS-D0-ENG*M25
Single license, IndraWorks TeamServer	SWL-IWORKS-ML*-xxVRS-D0-TEAMSERVER
Single license, IndraWorks OPC server	SWL-IWORKS-ML*-xxVRS-D0-COM
Multiple license (25), IndraWorks OPC server	SWL-IWORKS-ML*-xxVRS-D0-COM*M25
Single license, IndraWorks Operation	SWL-IWORKS-ML*-xxVRS-D0-OPD
Multiple license (25), IndraWorks Operation	SWL-IWORKS-ML*-xxVRS-D0-OPD*M25
Single license, IndraWorks CamBuilder	SWS-IWORKS-CAM-xxVRS-D0
Multiple license (25), IndraWorks CamBuilder	SWS-IWORKS-CAM-xxVRS-D0-M25
Single license, IndraWorks TeamClient (VCS)	SWS-IWORKS-VCS-xxVRS-D0
Multiple license (10), IndraWorks TeamClient (VCS)	SWS-IWORKS-VCS-xxVRS-D0-M10
Multiple license (25), IndraWorks TeamClient (VCS)	SWS-IWORKS-VCS-xxVRS-D0-M25
Ordering data for hardware	
Description	Type code
Control hardware IndraControl L25 with sercos III	CML25.1-3N-400-NN-NNC1-NW
Control hardware IndraControl L45 with sercos III, PROFIBUS and real-time Ethernet	CML45.1-3P-500-NA-NNNN-NW
Control hardware IndraControl L45 with SRAM, sercos III, PROFIBUS and real-time Ethernet	CML45.1-3P-504-NA-NNNN-NW
Control hardware IndraControl L65 with sercos III, PROFIBUS and real-time Ethernet	CML65.1-3P-500-NA-NNNN-NW
Control hardware IndraControl L65 with SRAM, sercos III, PROFIBUS and real-time Ethernet	CML65.1-3P-504-NA-NNNN-NW
IndraControl L function module, sercos III	CFL01.1-R3
IndraControl L function module, cross communication (sercos II)	CFL01.1-Q2
IndraControl L function module, real-time Ethernet + PROFIBUS	CFL01.1-TP
IndraControl L function module, programmable limit switches	CFL01.1-N1
IndraControl L function module, Fast I/O	CFL01.1-E2
IndraControl L function module, SRAM	CFL01.1-Y1

xx = software/firmware version; ²⁾ Based on 2nd generation PLC kernel

Current documentation can be found in the Internet at www.boschrexroth.com/mediadirectory.



IndraLogic – open PLC systems for universal use

The powerful PLC systems from Bosch Rexroth set new benchmarks for automation with a consistent control, programming and communication design. Whether controller, embedded PC or industrial PC, the free selection of control platforms helps you solve all tasks quickly and efficiently.

With the latest PLC programming in accordance with the IEC-61131-3 standard and new language elements for object orientation, fully integrated in the engineering framework IndraWorks, you can implement your application with a single uniform software tool.

On various platforms, the capacity and functionality of IndraLogic can be customized precisely to centralized and distributed automation architectures:



Rexroth IndraLogic is the complete PLC solution for successful automation designs – efficient, scalable and standardized.

IndraLogic XLC

With the latest PLC technology, the new PLC system IndraLogic XLC (eXtended Logic Control) offers verifiable user benefits for intelligent automation of production machines and systems. The IndraWorks software completely integrates all tools and shortens the engineering process chain.

Object-oriented language extensions in the programming increase the quality of the user programs through simplified modularization and accelerate creation of machine variants.

The openness and scalability of the IndraControl family are the basis for flexible, user-oriented solutions in distributed or centralized control topologies. sercos the automation bus is the high-performance backbone of all system peripherals. Fast I/O signal processing and highly dynamic motion control tasks can be implemented thanks to a user-oriented task setting of the powerful motion logic runtime system. Uniform system information and transparent diagnosis of the entire system minimize downtimes and noticeably increase productivity in the most varied applications and processes.

Efficient, open, and standardized

- ▶ Consistent automation solution
- ▶ Comprehensive functions and numerous interfaces
- ▶ Uniform engineering and convenient operation



IndraLogic L/V

The PLC series IndraLogic L und IndraLogic V are available with a uniform runtime system and in various designs and performance classes.

IndraLogic L is based on the scalable control platform IndraControl L. Its compact design with modules enables easy assembly on hat rails, making it ideal for any automation environment. A consistent avoidance of wear parts, such as batteries and fans, helps the control to achieve the highest level of reliability while saving on maintenance. Whether you prefer a panel PC or separate PC and control unit – IndraLogic V gives you all the freedom needed to control and visualize your applications.

A tiered range of devices with an extremely robust industrial design in conjunction with the real-time operating systems VxWorks/VxWin or Microsoft Windows CE guarantee reliable use in the most varied applications. The complete system engineering is intuitive, user-friendly, and uniform thanks to the engineering framework IndraWorks.

Your benefits:

- ▶ State-of-the-art control hardware with many extension options
- ▶ The latest PLC kernel IndraLogic 2G (based on CoDeSys V3)
- ▶ High-performance communication via sercos III real-time Ethernet for all peripherals
- ▶ Synchronized motion control function
- ▶ IndraWorks – one tool for all engineering tasks



IndraLogic XLC – technical data

		IndraLogic XLC L25	IndraLogic XLC L45	IndraLogic XLC L65
Control				
Runtime system	Integrated motion logic system	●	●	●
Multitasking		●	●	●
Data management	Code, data, retentive data, user data	●	●	●
Storage	Boot project	●	●	●
	PLC project as packed archive file	●	●	●
	User data to the internal memory and a removable storage medium	●	●	●
Support	Function modules	2	4	4
	System events	●	●	●
Probe		●	●	●
User memory	Total: code, data	12 MB	24 MB	36 MB
Retentive memory	Total: system, user	256 kB	256 kB	256 kB
On-board diagnosis and settings				
Status display (boot, sercos, test)	Display	●	●	●
Errors, warnings, messages, system reset		●	●	●
Ethernet settings (IP address)		●	●	●
Voltage monitoring, watchdog		●	●	●
Relay output ready for operation		●	●	●
IndraMotion Service Tool		○	○	○
On-board communication interfaces				
sercos III	Real-time Ethernet bus	○	○	○
PROFIBUS	Master	○	●	●
	Slave	○	●	●
PROFINET IO	Controller (master)	○	○	○
	Device (slave)	○	○	○
EtherNet/IP	Scanner (master)	▼	▼	▼
	Adapter (slave)	○	○	○
Ethernet TCP/IP		●	●	●
Control grouping	Ethernet TCP/UDP/IP	●	●	●
Function modules				
Number		2	4	4
Real-time Ethernet/PROFIBUS		○	○	○
Programmable limit switches		○	○	○
Fast I/O		○	○	○

● Default ▼ In preparation ○ Optional – Not available

		IndraLogic XLC L25	IndraLogic XLC L45	IndraLogic XLC L65
HMI				
IndraControl VCP, VCH	Ethernet TCP/IP, OPC	○	○	○
IndraControl VEP, VEH	Ethernet TCP/IP, OPC	○	○	○
IndraControl VSP, VPP, VSB/VDP, VPB/VDP	Ethernet TCP/IP, OPC	○	○	○
Inputs/outputs				
On-board				
High-speed digital inputs	Interrupt capability, typ. 50 µs	–	8	8
High-speed digital outputs	0.5 A, typ. 500 µs	–	8	8
Local				
High-speed digital inputs (FAST I/O function module)	Interrupt capability, typ. 40 µs	○	○	○
High-speed digital outputs (FAST I/O function module)	0.5 A, typ. 70 µs	○	○	○
Inline (digital, analog, relay, technology)	64 bytes, max. 512 I/O	○	○	○
Distributed via Inline (IP20)				
sercos III	On-board/function module	○	○	○
PROFIBUS	On-board/function module	○	○	○
Distributed via Fieldline (IP67)				
PROFIBUS	On-board/function module	○	○	○
Distributed via IndraControl S67 (IP67)				
sercos III	On-board/function module	○	○	○
PROFIBUS	On-board/function module	○	○	○
Logic control				
PLC runtime system				
IndraLogic 2G kernel	Conforming with IEC 61131-3 with extensions	●	●	●
Program organization	According to IEC 61131-3	●	●	●
Loading and executing IEC-61131-3 applications		●	●	●
Task management				
Freely configurable tasks (priority 0-20)	Cyclic, free-running, event-controlled, externally event-controlled	8	8	8
Cycle-synchronous processing of the I/O process image		●	●	●
sercos III-synchronous processing of the I/O process image		●	●	●
Min. PLC cycle time	Synchronous to the system cycle	1 ms	1 ms	1 ms
	Synchronous to the sercos cycle	1 ms	0.5 ms	0.25 ms
Min. motion cycle time	Command value generator	2 ms	1 ms	1 ms

● Default ▼ In preparation ○ Optional – Not available

IndraLogic XLC – technical data

		IndraLogic XLC L25	IndraLogic XLC L45	IndraLogic XLC L65
PLC processing times				
Typical processing time for 1,000 instructions	Command mix (real, integer, bool, etc.)	35 µs	30 µs	5 µs
	Bool operations	20 µs	30 µs	5 µs
	Word operations	20 µs	30 µs	5 µs
Motion control				
Number of axes	Real, virtual, encoder	16	32	64
Synchronization (ELS – electronic line shaft)	Real axes (servo drives)	●	●	●
	Virtual axes (virtual masters)	●	●	●
	Encoder axes (real masters)	●	●	●
	Dynamic synchronization	●	●	●
	Master axis cascading	●	●	●
Positioning	Single-axis	●	●	●
Electronic gears		●	●	●
Electronic cams	Intermediate point tables (in the drive, max. 1,024 intermediate points)	4	4	4
	Electronic motion profile (in the control, motion profiles with max. 16 segments)	2	2	2
	FlexProfile (in the control, master/time-based motion profiles with max. 16 segments)	4	4	4
Motion commands according to PLCopen (choice)	MC_MoveAbsolute	●	●	●
	MC_MoveRelative	●	●	●
	MC_MoveVelocity	●	●	●
	MC_Home	●	●	●
	MC_CamIn, MC_CamOut	●	●	●
	MC_GearIn, MC_GearOut	●	●	●
Extended motion commands (choice)	MB_ReadListParameter	●	●	●
	MB_WriteListParameter	●	●	●
	MB_GearInPos	●	●	●
	MB_PhasingSlave	●	●	●
	MB_ClearAxisError	●	●	●
	MB_ClearSystemError	●	●	●
Extended system functions (choice)				
Programmable limit switches		●	●	●
PID controller		●	●	●
Temperature controller		●	●	●

● Default ▼ In preparation ○ Optional – Not available

		IndraLogic XLC L25	IndraLogic XLC L45	IndraLogic XLC L65
Diagnosis				
Diagnosis (status, warnings, errors)	Function blocks (software)	●	●	●
	Parameter access to diagnosis memory (software)	●	●	●
	Locally via display (control hardware)	●	●	●
	Axis monitoring (e.g. capacity, encoders, limit values)	●	●	●
	Diagnosis memory (64 kB, max. 999 messages)	●	●	●
Debugging monitor for IEC applications	●	●	●	
Drive systems				
IndraDrive		●	●	●
IndraDrive Cs		●	●	●
EcoDrive Cs		●	●	●
sercos Pack Profile		●	●	●
Master communication	sercos III	●	●	●
Engineering and operation				
IndraWorks		○	○	○
IndraMotion Service Tool		○	○	○

● Default ▼ In preparation ○ Optional – Not available

IndraLogic XLC – system configuration

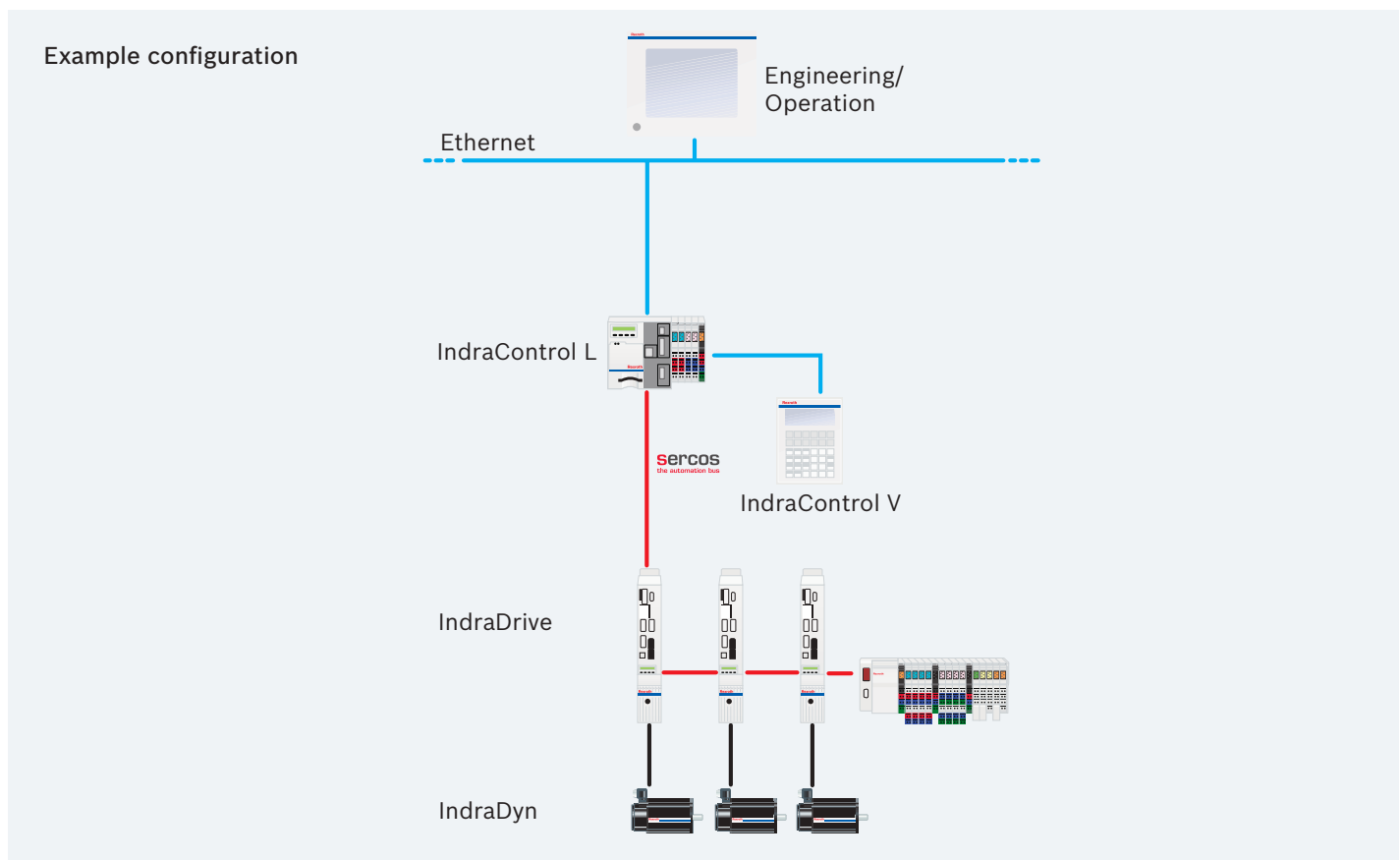

System configuration		
Software		Page(s)
Engineering framework	IndraWorks	60 – 79
Control components		
Control hardware	IndraControl L25, IndraControl L45, IndraControl L65	122 – 139
HMI/PC technology		
Manual operator panel	IndraControl VxH	90f/98f
Compact operator panel	IndraControl VCP	84 – 89
Embedded PC	IndraControl VEP	92 – 97
Panel PC	IndraControl VPP	100 – 103
I/O modules		
Local and distributed input/output modules in IP20	Inline	140 – 175
Distributed input/output modules in IP67	IndraControl S67	188 – 201

IndraLogic XLC – ordering data

Ordering data for firmware	
Description	Type code
Firmware for IndraControl L25	FWA-CML25*-XLC-xxVRS-D0
Firmware for IndraControl L45	FWA-CML45*-XLC-xxVRS-D0
Firmware for IndraControl L65	FWA-CML65*-XLC-xxVRS-D0
Ordering data for software and software options	
Description	Type code
Software DVD, Engineering framework IndraWorks	SWA-IWORKS-ML*-xxVRS-D0-DVD**
Single license, IndraWorks Engineering	SWL-IWORKS-XLC-xxVRS-D0-ENG
Multiple license (25), IndraWorks Engineering	SWL-IWORKS-XLC-xxVRS-D0-ENG*M25
Single license, IndraWorks TeamServer (VCS)	SWL-IWORKS-ML*-xxVRS-D0-TEAMSERVER
Single license, IndraWorks Communication (OPC server)	SWL-IWORKS-ML*-xxVRS-D0-COM
Multiple license (25), IndraWorks Communication (OPC server)	SWL-IWORKS-ML*-xxVRS-D0-COM*M25
Single license, IndraWorks Operation	SWL-IWORKS-ML*-xxVRS-D0-OPD
Multiple license (25), IndraWorks Operation	SWL-IWORKS-ML*-xxVRS-D0-OPD*M25
Single license, IndraWorks CamBuilder	SWS-IWORKS-CAM-xxVRS-D0
Multiple license (25), IndraWorks CamBuilder	SWS-IWORKS-CAM-xxVRS-D0-M25
Single license, IndraWorks TeamClient (VCS)	SWS-IWORKS-VCS-xxVRS-D0
Multiple license (10), IndraWorks TeamClient (VCS)	SWS-IWORKS-VCS-xxVRS-D0-M10
Multiple license (25), IndraWorks TeamClient (VCS)	SWS-IWORKS-VCS-xxVRS-D0-M25
Ordering data for hardware	
Description	Type code
Control hardware IndraControl L25 with sercos III	CML25.1-3N-400-NN-NNC1-NW
Control hardware IndraControl L25 with PROFIBUS and real-time Ethernet	CML25.1-PN-400-NN-NNC1-NW
Control hardware IndraControl L45 with sercos III, PROFIBUS and real-time Ethernet	CML45.1-3P-500-NA-NNNN-NW
Control hardware IndraControl L45 with PROFIBUS and real-time Ethernet	CML45.1-NP-500-NA-NNNN-NW
Control hardware IndraControl L65 with sercos III, PROFIBUS and real-time Ethernet	CML65.1-3P-500-NA-NNNN-NW
Control hardware IndraControl L65 with PROFIBUS and real-time Ethernet	CML65.1-NP-500-NA-NNNN-NW
IndraControl L function module, real-time Ethernet + PROFIBUS	CFL01.1-TP
IndraControl L function module, programmable limit switches	CFL01.1-N1
IndraControl L function module, Fast I/O	CFL01.1-E2

Current documentation can be found in the Internet at www.boschrexroth.com/mediadirectory.

IndraLogic L – technical data

		IndraLogic L10	IndraLogic L20	IndraLogic L40
Control				
Runtime system	Conforming with IEC 61131-3	●	●	●
Multitasking		●	●	●
Data management	Code, data, retentive data, user data	●	●	●
Storage	Boot project	●	●	●
	PLC project as packed archive file	●	●	●
	User data to the internal memory and a removable storage medium	●	●	●
Support	Function modules	–	–	4
Support	System events	●	●	●
User memory	Total: code, data	4 MB	3 MB	24 MB
Retentive memory	Total: system, user	32 kB	64 kB	128 kB
On-board diagnosis and settings				
Status display (boot, sercos, test)	Display/LED	–/●	●/–	●/–
Errors, warnings, messages, system reset	Display, keys/LEDs	–/●	●/–	●/–
Ethernet settings (IP address)	Display, keys/LEDs	–/●	●/–	●/–
Voltage monitoring, watchdog		●	●	●
Relay output ready for operation		●	●	●
On-board communication interfaces				
PROFIBUS	Master	–	●	●
	Slave	–	●	●
EtherNet/IP	Adapter (slave)	●	●	●
Ethernet TCP/IP		●	●	●
Control link	Ethernet TCP/UDP/IP	●	●	●
RS232		–	●	●
Function modules				
Number		–	–	4
PROFIBUS master		–	–	○
DeviceNet master		–	–	○
Fast I/O		–	–	○
HMI				
IndraControl VCP, VCH	Ethernet TCP/IP, OPC	○	○	○
IndraControl VEP, VEH	Ethernet TCP/IP, OPC	○	○	○
IndraControl VSP, VPP, VSB/VDP, VPB/VDP	Ethernet TCP/IP, OPC	○	○	○
Inputs/outputs				
On-board				
High-speed digital inputs	Interrupt capability, typ. 50 μs	8	8	8
High-speed digital outputs	0.5 A, typ. 500 μs	4	8	8
Local				
High-speed digital inputs (function module FAST I/O)	Interrupt capability, typ. 40 μs	–	–	○
High-speed digital outputs (function module FAST I/O)	0.5 A, typ. 70 μs	–	–	○

● Default ▼ In preparation ○ Optional – Not available

		IndraLogic L10	IndraLogic L20	IndraLogic L40
Inputs/outputs				
Local				
Inline (digital, analog, relay, technology)	32 bytes, max. 256 I/O	○	○	–
Inline (digital, analog, relay, technology)	64 bytes, max. 512 I/O	–	–	○
Distributed via Inline (IP20)				
PROFIBUS	On-board/function module	–	●/–	●/○
DeviceNet	Function module	–	–	○
Distributed via Fieldline (IP67)				
PROFIBUS	On-board/function module	–	●/–	○
DeviceNet	Function module	–	–	○
Distributed via IndraControl S67 (IP67)				
PROFIBUS	On-board/function module	○/○	●/–	●/○
DeviceNet	On-board/function module	–	–	–/○
Logic control				
PLC runtime system				
IndraLogic 1G kernel	Conforming with IEC 61131-3	●	●	●
Program organization	According to IEC 61131-3	●	●	●
Loading and executing IEC-61131-3 applications		●	●	●
Motion control functions via PLCopen function modules		–	●	●
Task management				
Freely configurable tasks (priority 0-31)	Cyclic, free-running, event-controlled, externally event-controlled	8	8	16
Cycle-synchronous processing of the I/O process image		●	●	●
Min. PLC cycle time	Synchronous to the system cycle	1 ms	1 ms	1 ms
PLC processing times				
Typical processing time for 1,000 instructions	Command mix (real, integer, bool, etc.)	150 μs	150 μs	50 μs
	Bool operations	150 μs	140 μs	50 μs
	Word operations	150 μs	140 μs	30 μs
Extended system functions (choice)				
PID control		●	●	●
Temperature control		●	●	●
Diagnosis				
Diagnosis (status, warnings, errors)	Function blocks (software)	●	●	●
	Locally via display (control hardware)	–	●	●
	Diagnosis memory (64 kB, max. 999 messages)	●	●	●
Debugging monitor for IEC applications		●	●	●
Engineering and operation				
IndraWorks		○	○	○
Compatible with all IndraLogic systems		●	●	●

● Default ▼ In preparation ○ Optional – Not available

IndraLogic L – system configuration

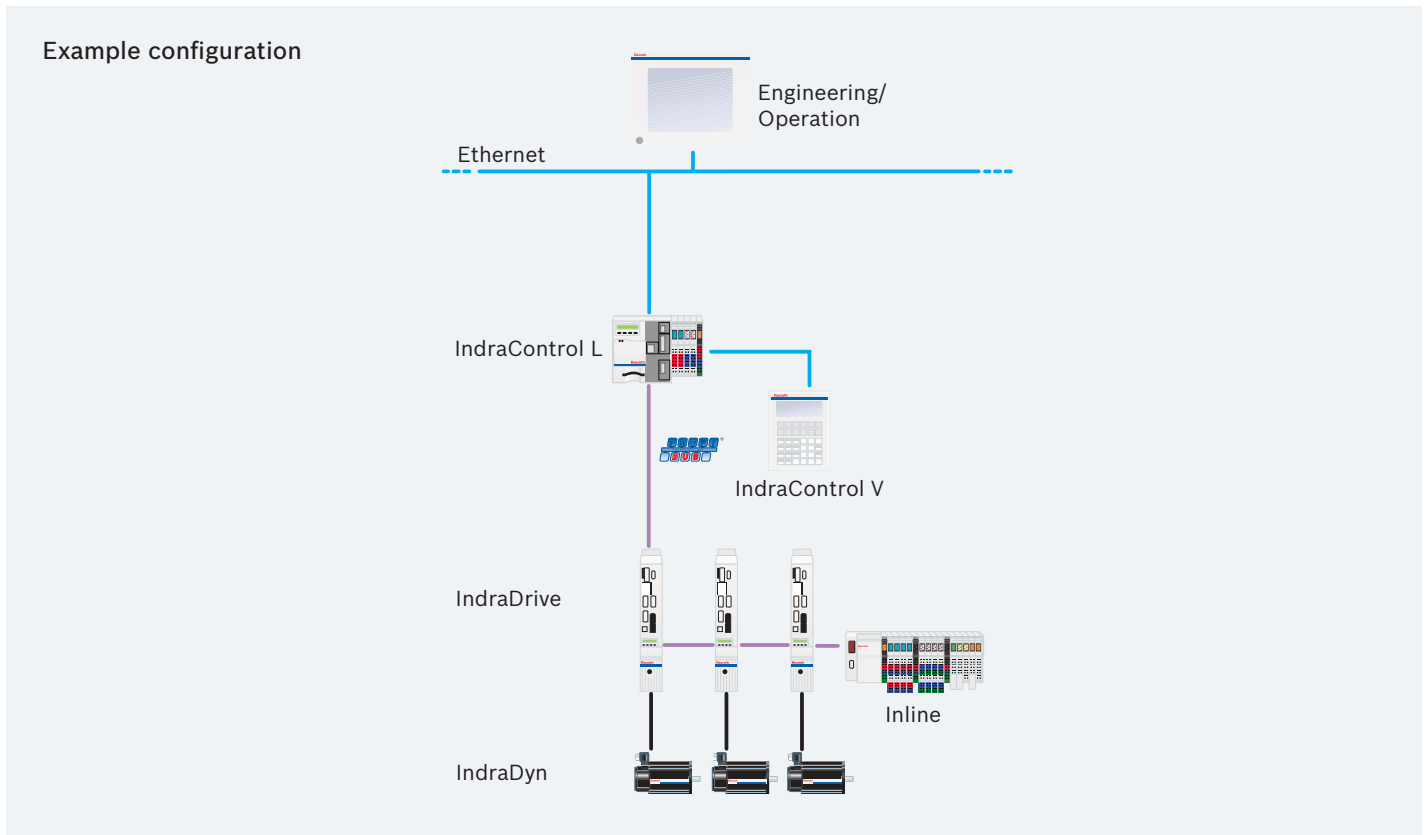

System configuration		
Software		Page(s)
Engineering framework	IndraWorks	60 – 79
Control components		
Control hardware	IndraControl L10, IndraControl L20, IndraControl L40	122 – 139
HMI/PC technology		
Manual operator panel	IndraControl VxH	90, 98
Compact operator panel	IndraControl VCP	84 – 89
Embedded PC	IndraControl VEP	92 – 97
Keyboards	IndraControl VAK	115 – 116
Control panels	IndraControl VAM	117 – 119
Box PC/displays	IndraControl VPB and VDP	104 – 114
Panel PC	IndraControl VPP	100 – 103
I/O modules		
Local and distributed input/output modules in IP20	Inline	140 – 175
Distributed input/output modules in IP67	IndraControl S67	188 – 201

IndraLogic L – ordering data

Ordering data for firmware

Description	Type code
Firmware for IndraControl L10	FWA-CML10*-IL*-xxVRS-D0
Firmware for IndraControl L20	FWA-CML20*-IL*-xxVRS-D0
Firmware for IndraControl L20 for IndraMotion for Handling	FWA-CML20*-IL*-xxVRS-D0*T01
Firmware for IndraControl L40	FWA-CML40*-IL*-xxVRS-D0
Firmware for IndraControl L40 for IndraMotion for Handling	FWA-CML40*-IL*-xxVRS-D0*T01

Ordering data for software and software options

Description	Type code
Software DVD, Engineering framework IndraWorks	SWA-IWORKS-ML*-xxVRS-D0-DVD**
Single license, IndraWorks Engineering	SWL-IWORKS-XLC-xxVRS-D0-ENG
Multiple license (25), IndraWorks Engineering	SWL-IWORKS-XLC-xxVRS-D0-ENG*M25
Single license, IndraWorks Communication (OPC server)	SWL-IWORKS-ML*-xxVRS-D0-COM
Multiple license (25), IndraWorks Communication (OPC server)	SWL-IWORKS-ML*-xxVRS-D0-COM*M25
Single license, IndraWorks Operation	SWL-IWORKS-ML*-xxVRS-D0-OPD
Multiple license (25), IndraWorks Operation	SWL-IWORKS-ML*-xxVRS-D0-OPD*M25
Software CD, Technology functions for IndraMotion for Handling	SWA-IM*ML*-LHA-xxVRS-D0-CD650-COPY

Ordering data for hardware

Description	Type code
Control hardware IndraControl L10	CML10.1-NN-210-NB-NNNN-NW
Control hardware IndraControl L20	CML20.1-NP-120-NA-NNNN-NW
Control hardware IndraControl L40 with PROFIBUS	CML45.1-3P-500-NA-NNNN-NW
IndraControl L function module PROFIBUS master	CFL01.1-P1
IndraControl L function module DeviceNet master	CFL01.1-V1
IndraControl L function module Fast I/O	CFL01.1-E2

Current documentation can be found in the Internet at www.boschrexroth.com/mediadirectory.

IndraLogic V – technical data

		IndraLogic VE	IndraLogic VS	IndraLogic VP
Control				
Runtime system	Conforming with IEC 61131-3	●	●	●
Multitasking		●	●	●
Data management	Code, data, retentive data, user data	●	●	●
Storage	Boot project	●	●	●
	PLC project as packed archive file	●	●	●
	User data to the internal memory and a removable storage medium	●	●	●
Support	System events	●	●	●
User memory	Total: code, data	24 MB	48 MB	48 MB
Retentive memory	Total: system, user	256 kB	2 MB	2 MB
On-board diagnosis and settings				
Status display (boot, sercos, test)	SoftPanel	●	●	●
Errors, warnings, messages, system reset	SoftPanel	●	●	●
Ethernet settings (IP address)	SoftPanel	●	●	●
Voltage monitoring, watchdog		●	●	●
On-board communication interfaces				
PROFIBUS	Master	●	●	●
Ethernet TCP/IP		●	●	●
Control link	Ethernet TCP/UDP/IP	●	●	●
HMI				
IndraControl VCP, VCH	Ethernet TCP/IP, OPC	○	○	○
IndraControl VEP, VEH	Ethernet TCP/IP, OPC	●	○	○
IndraControl VSP, VPP, VSB/VDP, VPB/VDP	Ethernet TCP/IP, OPC	○	●	●
Inputs/outputs				
Distributed via Inline (IP20)				
PROFIBUS	On-board	○	○	○
Distributed via Fieldline (IP67)				
PROFIBUS	On-board	○	○	○
Distributed via IndraControl S67 (IP67)				
PROFIBUS	On-board	○	○	○
Logic control				
PLC runtime system				
IndraLogic 1G kernel	Conforming with IEC 61131-3	●	●	●
Program organization	According to IEC 61131-3	●	●	●
Loading and executing IEC-61131-3 applications		●	●	●
Motion control functions via PLCopen function blocks		●	●	●

● Default ▼ In preparation ○ Optional – Not available

		IndraLogic VE	IndraLogic VS	IndraLogic VP
Logic control				
Task management				
Freely configurable tasks (priority 0-31)	Cyclic, free-running, event-controlled, externally event-controlled	16	32	32
Cycle-synchronous processing of the I/O process image		●	●	●
Min. PLC cycle time	Synchronous with the system cycle	1 ms	1 ms	1 ms
PLC processing times				
Typical processing time for 1,000 instructions	Command mix (real, integer, bool, etc.)	15 μs	10 μs	5 μs
	Bool operations	10 μs	10 μs	5 μs
	Word operations	20 μs	10 μs	5 μs
Extended system functions (choice)				
PID controller		●	●	●
Temperature controller		●	●	●
Diagnosis				
Diagnosis (status, warnings, errors)	Function blocks (software)	●	●	●
	SoftPanel	●	●	●
	Diagnosis memory (64 kB, max. 999 messages)	●	●	●
Debugging monitor for IEC applications		●	●	●
Engineering and operation				
IndraWorks		○	○	○
Compatibility with all IndraLogic V systems		●	●	●

● Default ▼ In preparation ○ Optional – Not available

IndraLogic V – system configuration

Example configuration

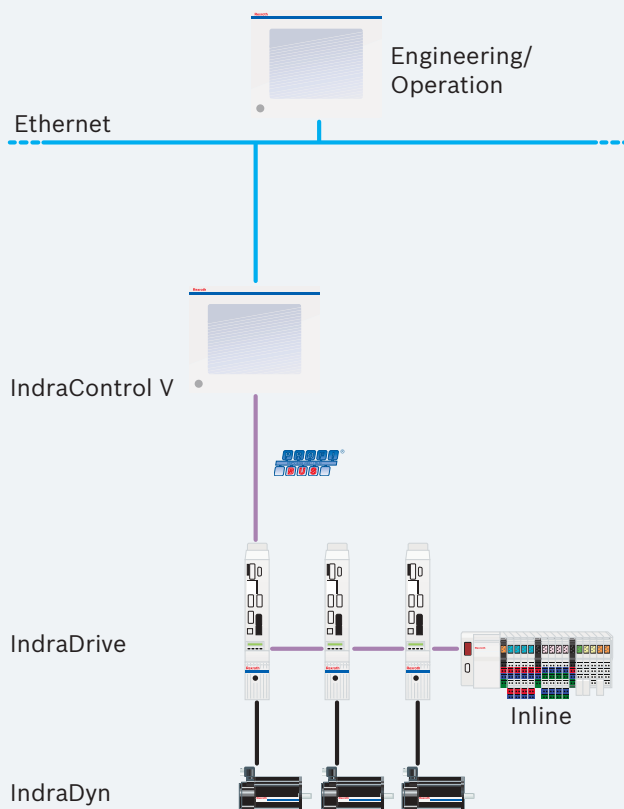

System configuration

Software		Page(s)
Engineering framework	IndraWorks	60 – 79
Control components		
Embedded PC	IndraControl VEP	92 – 97
Box PC/displays	IndraControl VPB and VDP	104 – 114
I/O modules		
Local and distributed input/output modules in IP20	Inline	140 – 175
Distributed input/output modules in IP67	IndraControl S67	188 – 201

IndraLogic V – ordering data

Ordering data for firmware	
Description	Type code
Runtime license IndraLogic VE	SWL-VE**01-ILC-04VRS-NN-0024
Runtime license IndraLogic VE for IndraMotion for Handling	SWL-VE**01-ILC-04VRS-NN-0024-T01
Firmware for IndraLogic VS/VP	FWA-VSXVPX-IL*-04VRS-D0-0048
Ordering data for software and software options	
Description	Type code
Software DVD, Engineering framework IndraWorks	SWA-IWORKS-ML*-xxVRS-D0-DVD**
Single license, IndraWorks Engineering	SWL-IWORKS-XLC-xxVRS-D0-ENG
Multiple license (25), IndraWorks Engineering	SWL-IWORKS-XLC-xxVRS-D0-ENG*M25
Single license, IndraWorks Communication (OPC server)	SWL-IWORKS-ML*-xxVRS-D0-COM
Multiple license (25), IndraWorks Communication (OPC server)	SWL-IWORKS-ML*-xxVRS-D0-COM*M25
Single license, IndraWorks Operation	SWL-IWORKS-ML*-xxVRS-D0-OPD
Multiple license (25), IndraWorks Operation	SWL-IWORKS-ML*-xxVRS-D0-OPD*M25
Software CD, Technology functions for IndraMotion for Handling	SWA-IM*ML*-LHA-xxVRS-D0-CD650-COPY
Ordering data for hardware	
Description	Type code
IndraControl VEP 30, PROFIBUS, control components	VEP30.3CCU-256NA-MAD-128-NN-FW
IndraControl VEP 30 CG, PROFIBUS, control components	VEP30.3DKU-256NA-MAD-128-CG-FW
IndraControl VEP 40, PROFIBUS, control components	VEP40.3CEU-256NA-MAD-128-NN-FW
IndraControl VEP 50, PROFIBUS, control components	VEP50.3CHU-256NA-MAD-128-NN-FW
IndraControl VS/VP	For detailed type codes, see pp. 100–107

Current documentation can be found in the Internet at www.boschrexroth.com/mediadirectory.

Automation systems and control components – software, hardware, and peripherals



IndraWorks – engineering framework 60

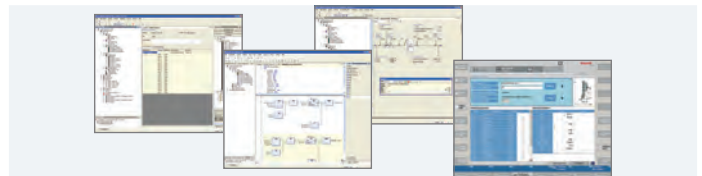

IndraControl V – human-machine interfaces (HMI) and industrial PCs 80



IndraControl L – controller-based hardware 122



Inline – I/O technology in IP20 140



IndraControl S20 – I/O technology in IP20 176



IndraControl S67 – I/O technology in IP67 188



Fieldline – I/O technology in IP67 202



Interconnection technology – cables and plugs 208



IndraWorks – one tool for all engineering tasks

Rexroth IndraWorks allows you to solve all tasks in a uniform and intuitive software environment – from project planning and programming to visualization and diagnosis.

The uniform engineering framework IndraWorks is consistently available for all systems. You, as user, profit from the fast and transparent access to all functions and system data of the automation components. The standardized tools and interfaces help you to solve all engineering tasks centrally with a single software program.

Your benefits

- ▶ Available for all IndraMotion and IndraLogic systems from Rexroth
- ▶ Integrated framework for all engineering tasks
- ▶ Consistent operating environment for project planning, programming, visualization and diagnosis
- ▶ Central project management with intuitive system navigation
- ▶ Intelligent operation with wizard support
- ▶ Comprehensive online help
- ▶ Uniform programming according to the PLC standard IEC 61131-3
- ▶ PLCopen-conforming function block and technology libraries
- ▶ Standardized interfaces for communication
- ▶ Transparent access to all system components
- ▶ Integrated FDT/DTM interface for integrating DTMs of third-party manufacturers



IndraWorks – the universal engineering framework

- ▶ One tool for all automation tasks
- ▶ Quick startup via dialog-driven commissioning
- ▶ Offline configuration of projects
- ▶ Comfortable programming environment



Project planning

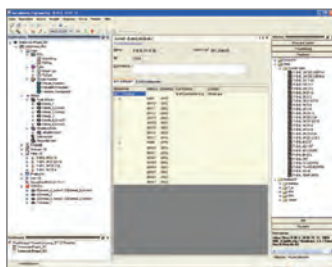

Planning of the overall system is uniform and consistent for all solutions. User and multi-project management are available in all instances. The project and device explorers provide access to all automation systems and control components. With its clearly organized dialog boxes, IndraWorks guides you intuitively through the configuration of your system.

Programming



The IndraLogic runtime system that is integrated in all solutions is consistently programmed in IndraWorks. The complete language scope specified in IEC 61131-3 is available. System-specific additional functions, such as motion blocks according to PLCopen or technology blocks, can be quickly and transparently implemented in your logic programs.

Operation and visualization

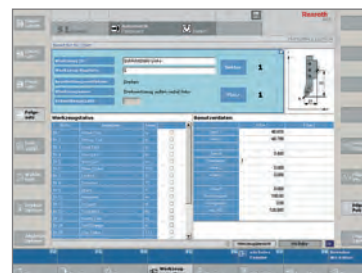

Apart from providing engineering functions, IndraWorks is also an HMI front end for various applications. IndraWorks allows you to create machine- or system-specific screens. Using the project development tool WinStudio, you can easily integrate standard screens in the user interface. In addition, you can easily use pre-developed ActiveX controls in your HMI applications.

Parameterization

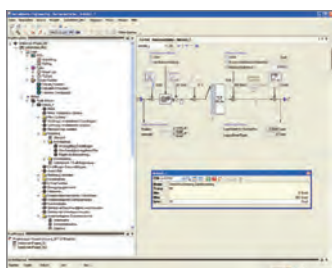

The project explorer provides access to all data of the system components. Wizards guide you through all engineering steps, interactively and in sequence. Control and drive options or motion axes can be parameterized easily and clearly, even offline. I/O peripherals and communication interfaces can be configured through the integrated configurators. The online help provides you with all necessary information.

Diagnosis

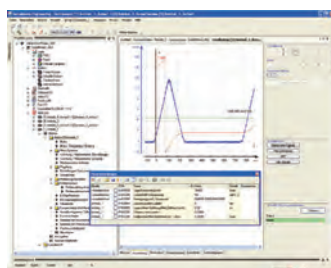

Comprehensive tools are implemented in IndraWorks to facilitate startup or service activities. Such tools cover the complete range from four-channel oscilloscope and logic analyzer through debugging functions of the PLC logic to manifold status messages and system diagnostics. At the push of a button comprehensive detailed information on controls, drives, HMI, and peripherals are provided.

Tools

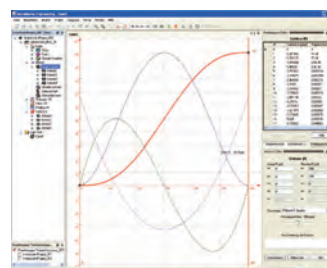

The tools for all engineering tasks are integrated in IndraWorks. Additional solution-specific tools are consistently available in the software framework. Using menus or the project tree, you can access, for example, CamBuilder for creating cams, simulation tools, firmware management, or system-specific programming editors.

IndraWorks Engineering – technical data

System		IndraDrive	IndraMotion MLC	IndraMotion MLD	IndraLogic XLC	IndraLogic L/V	IndraMotion MTX
IndraWorks variants							
IndraWorks ML*		●	●	●	●	●	–
IndraWorks MTX		●	–	●	●	●	●
IndraWorks MLD		●	–	●	–	–	–
IndraWorks D		●	–	–	–	–	–
IndraWorks Ds		●	–	–	–	–	–
Basic functions							
Supported operating systems	MS Windows XP, Windows 7	●	●	●	●	●	●
Multilinguality of framework		●	●	●	●	●	●
Multilinguality of projects		●	●	●	●	●	●
Export/import of texts of the PLC projects		●	●	●	●	●	●
Firmware management		●	●	●	●	●	●
Deactivating/parking drives in the project		●	●	●	●	●	●
Automatic scan of drives and I/O participants		●	●	●	●	●	●
Switching between online and offline modes		●	●	●	●	●	●
Automatic system monitoring	Display of messages and errors	●	●	●	●	●	●
Project comparison		●	●	●	●	●	●
Online change		●	●	●	●	●	●
Find/replace		●	●	●	●	●	●
Cross references		●	●	●	●	●	●
Call tree		●	●	●	●	●	●
Log file		●	●	●	●	●	●
Integration of third-party commissioning tools via FDT/DTMs		–	● ¹⁾	–	●	–	●
Working with version control (VCS) – Software option							
Supported VCS systems	Sub-version	–	● ¹⁾	–	●	–	▼
	Microsoft Visual Source Safe	–	● ¹⁾	–	●	–	▼
Check objects in/out		–	● ¹⁾	–	●	–	▼
Hijack objects		–	● ¹⁾	–	●	–	▼
Object comparison	Device, POE, function block, library, visualization	–	● ¹⁾	–	●	–	▼
Undo functions		–	● ¹⁾	–	●	–	▼
Update working copy		–	● ¹⁾	–	●	–	▼
Show version history		–	● ¹⁾	–	●	–	▼
Show versioned elements		–	● ¹⁾	–	●	–	▼
Configuration and project planning							
System configurator		●	●	●	●	●	●
Device library for controls, visualization, peripherals		●	●	●	●	●	●
Commissioning wizards		●	●	●	●	●	●
Project navigator		●	●	●	●	●	●
I/O configurator		●	●	●	●	●	●
Fieldbus configurator		●	●	●	●	●	●
Axis configurator	Real axes	●	●	●	●	–	●
	Virtual axes	–	●	●	●	–	●
	Encoder axes	–	●	●	●	–	–
	Link axes	–	●	●	–	–	–
	Control axes	–	●	–	–	–	–

System		IndraDrive	IndraMotion MLC	IndraMotion MLD	IndraLogic XLC	IndraLogic L/V	IndraMotion MTX
Configuration and project planning							
Drive configurator		●	●	●	●	●	●
Project archiving		●	●	●	●	●	●
Parameter monitor for controls and drives		●	●	●	●	●	●
Offline parameterization of controls and drives		●	●	●	●	●	●
FlexProfile configurator		●	●	–	●	–	–
Cam editor	CamBuilder	○	○	○	○	–	–
Robot control	Configuration of standard kinematics	–	●	–	–	–	–
	Definition of user-specific kinematics	–	●	–	–	–	–
	Integrated RCL editor	–	●	–	–	–	–
Extended project handling		●	●	●	●	●	●
PLC programming							
Graphical editors							
SFC – Sequential Function Chart		–	●	●	●	●	●
Time monitoring per step		–	●	●	●	●	●
Error analysis		–	●	●	●	●	●
Control flags		–	●	●	●	●	●
LD – Ladder Diagram		–	●	●	●	●	●
FBD – Function Block Diagram		–	●	●	●	●	●
CFC – Continuous Function Chart	Auto-routing of connections	–	●	●	●	●	●
	Possibility of macros to structure large networks	–	●	●	●	●	●
Textual editors							
IL – Instruction List		–	●	●	●	●	●
ST – Structured Text		–	●	●	●	●	●
SEQ.ST – Sequential programming	Based on ST	–	●	–	–	–	–
RCL – Robot Control Language		–	●	–	–	–	–
Language elements							
Operators	According to IEC 61131–3	–	●	●	●	●	●
Operands	Constants, variables, addresses, functions	–	●	●	●	●	●
Bit access		–	●	●	●	●	●
Typed pointers		–	●	●	●	●	●
Object-oriented language extension		–	● ¹⁾	▼	●	–	●
Data types							
Standard according to IEC 61131–3 incl. LREAL		–	●	●	●	●	●
User-defined: arrays, structures, enumeration, alias, pointer		–	●	●	●	●	●
Robot control: POINT, JC_POINT, BELT, TEXT, ARRAY, WC_FRAME, FILE		–	●	–	–	–	–
Special editor features							
Syntax coloring		–	●	●	●	●	●
Semantic coloring		–	●	●	●	●	●
Multiple undo/redo		–	●	●	●	●	●
Context-sensitive input assistance		–	●	●	●	●	●
Context-sensitive menus		–	●	●	●	●	●
Auto-declaration with type identification		–	●	●	●	●	●
Name spaces		–	●	●	●	●	●

● Default ▼ In preparation ○ Optional – Not available ¹⁾ Not IndraMotion MLC 04VRS or below

IndraWorks Engineering – technical data

System		IndraDrive	IndraMotion MLC	IndraMotion MLD	IndraLogic XLC	IndraLogic L/V	IndraMotion MTX
Special editor features							
Auto-complete (IntelliSense) for structures, functions, function blocks		–	●	●	●	●	●
Pre-compile for permanent syntax check		–	●	●	●	●	●
Folding (fading in/out of program blocks and structures)		–	●	●	●	●	●
Extended find and replace		–	●	●	●	●	●
Smart coding (auto-complete and auto-format)		–	●	●	●	●	●
Library management							
Managed libraries (several library versions in one project)		–	● ¹⁾	▼	●	–	●
License management		–	● ¹⁾	▼	●	–	●
Programming assistance							
Offline programming		–	●	●	●	●	●
Automatic variable declaration of the system components		–	●	●	●	●	●
Structures for access to axis data		–	●	●	●	●	●
AXIS_REF (reference to axis data)		–	●	●	●	–	●
ML_AXISDATA (direct access to axis data)		–	●	●	●	–	–
Generic Application Template							
Automatic code generation	Program structure	–	● ¹⁾	●	●	–	–
	Error handling	–	● ¹⁾	●	●	–	–
	Possible to separate program frame and user code	–	● ¹⁾	–	–	–	–
Wizard-assisted creating, editing, deleting of	Operating modes	–	● ¹⁾	●	●	–	–
	Operating states	–	● ¹⁾	●	●	–	–
	Modules	–	● ¹⁾	●	–	–	–
	Axes	–	● ¹⁾	●	●	–	–
	Visualizations	–	● ¹⁾	–	●	–	–
Online debugging and commissioning							
Diagnosis							
Real-time logic analyzer		–	●	●	●	●	●
Oscilloscope function	Graphical output with zoom function	●	●	●	●	●	●
	Display of signal values of drives	●	●	●	●	●	●
	Scaling	●	●	●	●	●	●
	Measuring with/without trigger	●	●	●	●	●	●
Circular shape test		–	–	–	–	–	●
NC analyzer		–	–	–	–	–	●
Action recorder IndraMotion MTX acr		–	–	–	–	–	●
Cycle time analyzer IndraMotion MTX cta		–	–	–	–	–	●
Debugging							
Monitoring of variables	Trace	●	●	●	●	●	●
Forcing of variables and variable sets		●	●	●	●	●	●
Project debugging	Incl. robot control	–	●	–	–	–	–
Power flow	Sequential check	–	●	●	●	●	●
Online exchange of function blocks		–	●	●	●	●	●
Offline simulation of PLC variables		–	●	●	●	●	●
Parameter monitor		●	●	●	●	●	●

System		IndraDrive	IndraMotion MLC	IndraMotion MLD	IndraLogic XLC	IndraLogic L/V	IndraMotion MTX
Debugging							
Writing of variables		●	●	●	●	●	●
Breakpoint		–	●	●	●	●	●
Single step operation		–	●	●	●	●	●
Single cycle operation		–	●	●	●	●	●
Flow control		–	●	●	●	●	●
Libraries (choice)							
Basic libraries	System functions	–	●	●	●	●	●
	Communication	–	●	●	●	●	●
	PLCopen	–	●	●	●	●	●
	Data handling	–	●	●	●	●	●
	Diagnosis	–	●	●	●	●	●
Technology libraries	Axis interface	–	●	●	●	–	●
	Kinematics	–	●	–	●	–	–
	Programmable limit switch	–	●	–	●	–	–
	Gantry axes	–	●	○	●	–	–
	Probe evaluation	–	●	●	●	–	–
	Programmable limit switch	–	●	–	●	–	–
	PID controller	–	●	▼	●	●	–
Technology libraries (industry-specific)	Temperature controller	–	●	▼	●	●	–
	Hydraulic functions	–	●	–	–	–	–
	Register control – Basic	–	●	○	–	–	–
	Register control – Advanced	–	○	○	–	–	–
	Register control – Extended	–	○	–	–	–	–
	Tension control – 1 axis	–	●	○	–	–	–
	Tension control – 8 axes	–	○	–	–	–	–
	Cross cutter	–	●	○	–	–	–
	Sag control	–	●	–	–	–	–
	Flying shear	–	●	○	–	–	–
	Smart belt/magic belt	–	●	○	–	–	–
	Magic belt	–	●	–	–	–	–
	Crank/bell-crank kinematics	–	●	○	–	–	–
Winder and dancer controller	–	●	○	–	–	–	
HMI project planning							
WinStudio Lite	500 variables	–	●	–	●	●	●
WinStudio 1.5 k	1,500 variables	–	○	○	○	○	○
WinStudio 4 k	4,000 variables	–	○	○	○	○	○
WinStudio 64 k	64,000 variables	–	○	○	○	○	○
WinStudio 512 k	512,000 variables	–	○	○	○	○	○
VI-Composer		○	○	○	○	○	○
Simulation							
IndraMotion MTX workstation software	PLC emulation	–	–	–	–	–	●
	NC emulation	–	–	–	–	–	●
3D offline simulation of workpiece processing of NC parts programs		–	–	–	–	–	○
IndraWorks View 3D (3D machine volume simulation incl. process link)		–	–	–	–	–	○
IndraWorks Machine Simulator (SiL/HiL peripherals simulation)		–	–	–	–	–	○

● Default ▼ In preparation ○ Optional – Not available ¹⁾ Not IndraMotion MLC 04VRS or below

IndraWorks Operation – technical data

System		IndraMotion MLC	IndraLogic XLC	IndraLogic L/V	IndraMotion MTX
IndraWorks variants					
IndraWorks Operation ML*		● ¹⁾	●	●	–
IndraWorks Operation MTX		–	–	–	●
Supported operating systems					
MS Windows XP/XPe (32 bit)		●	●	●	●
MS Windows 7 (32/64 bit)		●	●	●	●
Basic function					
WinStudio runtime	Function scope of lite license (500 tags)	●	●	●	●
General operating scope concept	Pre-developed navigation bars (OP/F/M panels)	●	●	●	●
	Header display: System status, diagnostic messages, PLC state, etc.	●	●	●	●
	Pre-developed operator screens for moving axes manually, incl. a display of position, status, and feasibility	●	●	●	●
	ACI images (configurable screens to show pre-developed and customer-specific ActiveX and .NET controls)	●	●	●	●
	Show customer-specific HMI images (WinStudio)	●	●	●	●
Pre-developed operating scopes	Maintenance and diagnosis	●	●	●	●
	Prepare (machine-specific operator screens)	–	–	–	●
	Machine (axis position, override for feed/spindle, G-code, etc.)	–	–	–	●
	Program (CNC program editor, program selection)	–	–	–	●
	Tool management (tool identification, downtime management, correction value application, type definition)	–	–	–	●
	System (channel display and change)	–	–	–	●
	Production data	–	–	–	●
Localization					
Standard languages	German/English	●	●	●	●
Optional language modules	HMI interface texts	○	○	○	○
	NC messages	–	–	–	○
	Drive diagnosis (only with “OPDENG” language module)	○	○	○	○
Diagnosis					
Diagnostic systems	ProVi (PLC-based message system)	●	●	●	●
	MZA (machine error and status display)	–	–	–	●
	NC messages	–	–	–	●
Header message line	Display of active messages with the following classes: Warning, error, note	●	●	●	●
Diagnosis operating scope	Detailed list of all errors according to date/time	●	●	●	●
	Extended information on the cause and remedy (text or HTML)	●	●	●	●
	Filter according to message class	●	●	●	●
Log file	Logging of all message classes with time stamp: Note/warning/error/set-up diagnosis/start requirement	●	●	●	●
	Filter according to: time frame, source, message class, and text	●	●	●	●
	Export function in format: ASCII/CSV XML	●	●	●	●
Fieldbus diagnosis	PROFIBUS DP	●	●	●	●
	Overview and display of individual bus participants	●	●	●	●
Criteria analysis for sequences	Automatic display of sequence name and program instruction at the time the error occurred	●	●	●	●
Optional extensions					
Technology packages	E.g. shop programming, machining centers, NC simulation	–	–	–	○
WinStudio license packages	Function and variable extension from 1K5 ti 512K tags (Win XP max. 4K)	○	○	○	○

● Default ▼ In preparation ○ Optional – Not available ●¹⁾ From IndraMotion MLC 11VRS

IndraWorks – ordering data

IndraWorks Engineering	
Description	Type code
Installation DVD for IndraMotion MLC, IndraLogic XLC, IndraLogic L/V	SWA-IWORKS-ML*-xxVRS-D0-DVD**
Installation DVD for IndraMotion MTX	SWA-IWORKS-MTX-xxVRS-D0-DVD**
Single license – IndraWorks Engineering for IndraMotion MLC, IndraLogic XLC and IndraLogic L/V	SWL-IWORKS-ML*-xxVRS-D0-ENG
25 single licenses – IndraWorks Engineering for IndraMotion MLC, IndraLogic XLC and IndraLogic L/V	SWL-IWORKS-ML*-xxVRS-D0-ENG*M25
Single license – IndraWorks Engineering for IndraLogic XLC and IndraLogic L/V	SWL-IWORKS-XLC-xxVRS-D0-ENG
25 single licenses – IndraWorks Engineering for IndraLogic XLC and IndraLogic L/V	SWL-IWORKS-XLC-xxVRS-D0-ENG*M25
Single license – IndraWorks Operation + Engineering for IndraMotion MTX	SWL-IWORKS-MTX-xxVRS-D0-OPDENG
25 single licenses – IndraWorks Operation + Engineering for IndraMotion MTX	SWL-IWORKS-MTX-xxVRS-D0-OPDENG*M25
Single license – IndraWorks Engineering for IndraMotion MTX micro	SWL-IWORKS-MTX-xxVRS-D0-MICRO
25 single licenses – IndraWorks Operation + Engineering for IndraMotion MTX micro	SWL-IWORKS-MTX-xxVRS-D0-MICRO*M25
Single license – IndraWorks MTX Workstation	SWL-IWORKS-MTX-xxVRS-D0-WORKSTATION
25 single licenses – IndraWorks MTX Workstation	SWL-IWORKS-MTX-xxVRS-D0-WORKSTATION*25
Single license – IndraWorks Communication (OPC server) and WinStudio Lite for IndraMotion MLC, IndraLogic XLC and IndraLogic L/V	SWL-IWORKS-ML*-xxVRS-D0-COM
25 single licenses – IndraWorks Communication (OPC server) and WinStudio Lite for IndraMotion MLC, IndraLogic XLC and IndraLogic L/V	SWL-IWORKS-ML*-xxVRS-D0-COM*M25
Single license – IndraWorks Communication (OPC server) and WinStudio Lite for IndraMotion MTX	SWL-IWORKS-MTX-xxVRS-D0-COM
25 single licenses – IndraWorks Communication (OPC server) and WinStudio Lite for IndraMotion MTX	SWL-IWORKS-MTX-xxVRS-D0-COM*M25
IndraWorks Operation	
Description	Type code
Installation DVD for IndraMotion MLC, IndraLogic XLC, IndraLogic L/V	SWA-IWORKS-ML*-xxVRS-D0-DVD**
Installation DVD for IndraMotion MTX	SWA-IWORKS-MTX-xxVRS-D0-DVD**
Single license – IndraWorks Operation for IndraMotion MLC, IndraLogic XLC and IndraLogic L/V	SWL-IWORKS-ML*-xxVRS-D0-OPD
25 single licenses – IndraWorks Operation for IndraMotion MLC, IndraLogic XLC and IndraLogic L/V	SWL-IWORKS-ML*-xxVRS-D0-OPD*M25
Single license – IndraWorks Operation for IndraMotion MTX	SWL-IWORKS-MTX-xxVRS-D0-OPD
25 single licenses – IndraWorks Operation for IndraMotion MTX	SWL-IWORKS-MTX-xxVRS-D0-OPD*M25
IndraWorks options	
Description	Type code
Single license – IndraWorks CamBuilder for IndraMotion MLC, IndraLogic XLC	SWS-IWORKS-CAM-xxVRS-D0
25 single licenses – IndraWorks CamBuilder for IndraMotion MLC, IndraLogic XLC	SWS-IWORKS-CAM-xxVRS-D0-M25
Single license – IndraWorks TeamClient for IndraMotion MLC, IndraLogic XLC	SWS-IWORKS-VCS-xxVRS-D0
10 single licenses – IndraWorks TeamClient for IndraMotion MLC, IndraLogic XLC	SWS-IWORKS-VCS-xxVRS-D0-M10
25 single licenses – IndraWorks TeamClient for IndraMotion MLC, IndraLogic XLC	SWS-IWORKS-VCS-xxVRS-D0-M25
Single license – IndraWorks View 3D for IndraMotion MTX	SWS-IWORKS-V3D-xxVRS-D0
Single license – IndraWorks machine simulator (HiL) for IndraMotion MTX	SWS-IWORKS-MAS-xxVRS-D0
Single license – IndraWorks machine simulator (SiL) for IndraMotion MTX	SWS-IWORKS-MAS-xxVRS-D0-NOHAWA

IndraWorks – ordering data

IndraWorks language modules	
Description	Type code
Installation DVD for IndraWorks language modules	SWA-IWORKS-SED-xxVRS-NN-DVD**
Single license – Language module for IndraWorks Operation	SWL-IWORKS-SED-xxVRS-xx-OPD
Single license – Language module for IndraWorks Operation & Engineering	SWL-IWORKS-SED-xxVRS-xx-OPDENG
WinStudio runtime options	
Description	Type code
Single license – WinStudio 07VRS Runtime 1500 variables, Windows 7/XP/Xpe	SWS-WINSTU-RUN-07VRS-D0-1K5
Single license – WinStudio 07VRS Runtime 4000 variables, Windows 7/XP/Xpe	SWS-WINSTU-RUN-07VRS-D0-4K
Single license – WinStudio 07VRS Runtime 64000 variables, Windows 7/XP/Xpe	SWS-WINSTU-RUN-07VRS-D0-64K
Single license – WinStudio 07VRS Runtime 512000 variables, Windows 7/XP/Xpe	SWS-WINSTU-RUN-07VRS-D0-512K
Single license – WinStudio 07VRS Runtime 1500 variables, 1 Web client, Windows 7/XP/Xpe	SWS-WINSTU-RUW-07VRS-D0-1K5-1CL
Single license – WinStudio 07VRS Runtime 4000 variables, 1 Web client, Windows 7/XP/Xpe	SWS-WINSTU-RUW-07VRS-D0-4K-1CL
Single license – WinStudio 07VRS Runtime 64000 variables, 1 Web client, Windows 7/XP/Xpe	SWS-WINSTU-RUW-07VRS-D0-64K01CL
Single license – WinStudio 07VRS Runtime 512000 variables, 1 Web client, Windows 7/XP/Xpe	SWS-WINSTU-RUW-07VRS-D0-512K-1CL
Single license – WinStudio 07VRS Runtime 1500 variables, 4 Web clients, Windows 7/XP/Xpe	SWS-WINSTU-RUW-07VRS-D0-1K5-4CL
Single license – WinStudio 07VRS Runtime 4000 variables, 4 Web clients, Windows 7/XP/Xpe	SWS-WINSTU-RUW-07VRS-D0-4K-4CL
Single license – WinStudio 07VRS Runtime 64000 variables, 4 Web clients, Windows 7/XP/Xpe	SWS-WINSTU-RUW-07VRS-D0-64K-4CL
Single license – WinStudio 07VRS Runtime 512000 variables, 4 Web clients, Windows 7/XP/Xpe	SWS-WINSTU-RUW-07VRS-D0-512K-4CL
Single license – WinStudio 07VRS Runtime 1500 variables, 8 Web clients, Windows 7/XP/Xpe	SWS-WINSTU-RUW-07VRS-D0-1K5-8CL
Single license – WinStudio 07VRS Runtime 4000 variables, 8 Web clients, Windows 7/XP/Xpe	SWS-WINSTU-RUW-07VRS-D0-4K-8CL
Single license – WinStudio 07VRS Runtime 64000 variables, 8 Web clients, Windows 7/XP/Xpe	SWS-WINSTU-RUW-07VRS-D0-64K-8CL
Single license – WinStudio 07VRS Runtime 512000 variables, 8 Web clients, Windows 7/XP/Xpe	SWS-WINSTU-RUW-07VRS-D0-512K-8CL
Single license – WinStudio 07VRS Runtime 1500 variables, Windows CE	SWS-WINSTU-RUN-07VRS-D0-WCE1K5
Single license – WinStudio 07VRS Runtime 4000 variables, Windows CE	SWS-WINSTU-RUN-07VRS-D0-WCE4K
Single license – WinStudio 07VRS Runtime 1500 variables, 1 Web client, Windows CE	SWS-WINSTU-RUW-07VRS-D0-WCE1K5-1CL
Single license – WinStudio 07VRS Runtime 4000 variables, 1 Web client, Windows CE	SWS-WINSTU-RUW-07VRS-D0-WCE4K-1CL
Single license – WinStudio 07VRS Runtime 1500 variables, 4 Web clients, Windows CE	SWS-WINSTU-RUW-07VRS-D0-WCE1K5-4CL
Single license – WinStudio 07VRS Runtime 4000 variables, 4 Web clients, Windows CE	SWS-WINSTU-RUW-07VRS-D0-WCE4K-4CL
Single license – WinStudio 07VRS Runtime 1500 variables, 8 Web clients, Windows CE	SWS-WINSTU-RUW-07VRS-D0-WCE1K5-8CL
Single license – WinStudio 07VRS Runtime 4000 variables, 8 Web clients, Windows CE	SWS-WINSTU-RUW-07VRS-D0-WCE4K-8CL
WinStudio engineering & runtime options	
Description	Type code
Single license – WinStudio 07VRS Engineering and Runtime 1500 variables, Windows 7/XP/Xpe	SWS-WINSTU-RUD-07VRS-D0-1K5
Single license – WinStudio 07VRS Engineering and Runtime 4000 variables, Windows 7/XP/Xpe	SWS-WINSTU-RUD-07VRS-D0-4K
Single license – WinStudio 07VRS Engineering and Runtime 64000 variables, Windows 7/XP/Xpe	SWS-WINSTU-RUD-07VRS-D0-64K
Single license – WinStudio 07VRS Engineering and Runtime 512000 variables, Windows 7/XP/Xpe	SWS-WINSTU-RUD-07VRS-D0-512K



IndraWorks tool: CamBuilder – intuitive software tool for cam creation

The graphics-oriented software tool CamBuilder facilitates the creation of cams on the PC. With the help of dialog-controlled inputs, all requirements and special features of applications, such as cross cutters, feed axes or printing length corrections, are implemented quickly and reliably. With minor effort, the data is transferred to our drives or controls in a short time.

CamBuilder is the optional toolbox integrated in the IndraWorks engineering framework. But CamBuilder is also available as a stand-alone tool and can be used independently of the controls and drive systems used.

Your benefits

- ▶ Easy creation of cams with the help of graphical objects
- ▶ Convenient editing of existing cams
- ▶ Editing of several cams at the same time
- ▶ Utilization of motion laws according to VDI 2143
- ▶ Transmitting and receiving of cams in Rexroth drives and controls
- ▶ Automatic display of position, acceleration, velocity, and jerk
- ▶ Support for frequent requirements provided by wizards
- ▶ Import of point tables for partial areas of the cam
- ▶ Automatic detection and calculation of marginal conditions of the cam
- ▶ Zoom functionality
- ▶ Switching between standardized and evaluated views
- ▶ Import/export functionality with various formats

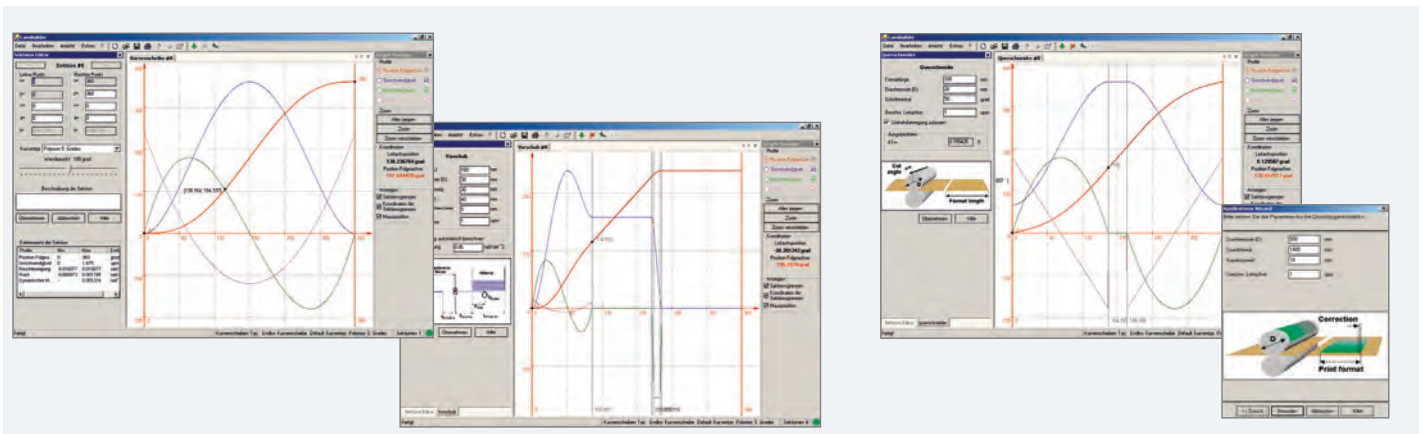

CamBuilder – software tool for fast and easy creation of cams

CamBuilder – technical data

System		IndraDrive	IndraMotion MLC	IndraMotion MLD	IndraLogic XLC
IndraWorks variants					
IndraWorks ML*		●	●	●	●
IndraWorks MTX		●	–	●	–
IndraWorks MLD		●	–	●	–
IndraWorks D		●	–	–	–
IndraWorks Ds		●	–	–	–
General					
Motion laws according to VDI 2143		●	●	●	●
Graphical editing of cams		●	●	●	●
Creation of cams		●	●	●	●
Creation of segmented motion profiles		●	●	●	●
Graphical output of the calculated cam		●	●	●	●
List of extreme values of the cam		●	●	●	●
Cam table display		●	●	●	●
Data management incl. import/export		●	●	●	●
Cam conversion to cam table		●	●	●	●
Conversion of cam to MotionProfile		●	●	●	●
Conversion of cam to FlexProfile		–	●	–	●
Display of position, acceleration, velocity, and jerk		●	●	●	●
Creation of function block for PLC program		–	●	–	●
Processing aids					
Graph editor		●	●	●	●
Motion editor		●	●	●	●
Event editor		–	·	–	·
Variable editor		●	●	●	●
Formula editor		●	●	●	●
Cam table editor		●	●	●	●
Project explorer		●	●	●	●
Application-specific wizards					
Cross cutter		●	●	●	●
Feeder		●	●	●	●
Printing length correction		●	●	●	●
Flying cut-off		●	●	●	●
Motion laws					
Rest in rest	Standstill	●	●	●	●
	Sine curve	●	●	●	●
	Inclined sine curve	●	●	●	●
	Acceleration-optimal inclined sine curve	●	●	●	●
	Moment-inclined sine curve	●	●	●	●
	Sinusoid of Gutman	●	●	●	●
	Modified sine curve	●	●	●	●
	Modified acceleration trapezoid	●	●	●	●
	Quadratic parabola	●	●	●	●
	Polynomial 5th order	●	●	●	●
	Polynomial 7th order	●	●	●	●
	Polynomial 8th order	●	●	●	●

CamBuilder – technical data/ordering data

System		IndraDrive	IndraMotion MLC	IndraMotion MLD	IndraLogic XLC	
Motion laws						
Rest to velocity	Polynomial 5th order	●	●	●	●	
	Polynomial 7th order	●	●	●	●	
Velocity to velocity	Constant velocity	●	●	●	●	
	Polynomial 5th order	●	●	●	●	
	Polynomial 7th order	●	●	●	●	
	Modified sine curve	●	●	●	●	
Velocity to rest	Polynomial 5th order	●	●	●	●	
	Polynomial 7th order	●	●	●	●	
General motion	Polynomial 2nd order	●	●	●	●	
	Polynomial 3rd order	●	●	●	●	
	Polynomial 4th order	●	●	●	●	
	Polynomial 5th order	●	●	●	●	
	Polynomial 7th order	●	●	●	●	
	Polynomial 8th order	●	●	●	●	
Extended motion	Resulting hub	Velocity 2nd order (Startacc. zero)	●	●	●	●
		Velocity 2nd order (Endacc. zero)	●	●	●	●
		Linear velocity	●	●	●	●
		Linear acceleration	●	●	●	●
	Resulting master axis range	Acceleration-limited motion (trapezoid profile)	●	●	●	●
		Acceleration-limited motion (sinusoid profile)	●	●	●	●
		Jerk-limited motion (trapezoid profile)	●	●	●	●
	Miscellaneous	Velocity-limited polynomial 5th order	●	●	●	●
		Free of harmonics polynomial 5th order	●	●	●	●
		Acceleration-limited (trapezoid profile)	●	●	●	●
	Free cam table for user-defined motion definition		●	●	●	●

● Default ▼ In preparation ○ Optional – Not available

Ordering data for software	
Description	Type code
Software CD, cam editor CamBuilder	SWA-CAM*PC-INB-xxVRS-D0-CD650
Single-license, cam editor CamBuilder in IndraWorks	SWS-IWORKS-CAM-xxVRS-D0
Multiple-license (25), cam editor CamBuilder in IndraWorks	SWS-IWORKS-CAM-xxVRS-D0-M25
Ordering data for documentation	
Description	Type code
Application manual, user manual	DOK-IWORKS-CAMBUIL*Vxx-FKxx-DE-P

xx = software/firmware version

IndraWorks tool: VI-Composer – the comfortable software for easy visualization and parameterization

VI-Composer is an easy but powerful project development tool for the visualization and parameterization of system-related data of the IndraControl VCP and VCH devices. In this convenient development environment, you can efficiently create your individual application, based on the usual Windows look-and-feel. The programming result can then be used on the various IndraControl VCP and VCH devices as often as desired.

The fully graphical VI-Composer software allows you to develop projects for IndraControl VCP and VCH devices according to the WYSIWYG (What You See Is What You Get) principle. Text, variables and graphics are immediately represented just as they will be displayed by the IndraControl VCP and VCH devices. Predefined masks and comprehensive graphics libraries with numerous industry-compatible screen objects facilitate the creation of your applications. Based on Windows-conforming operation, you describe all variables depending on the particular control, whereas masks, graphics, recipes and the like can be created independently of any control. VI-Composer provides direct access to the IndraWorks database and,

thus, to all variables of the controls and drives. The performance is completed by comprehensive help functions.

Your benefits

- ▶ Language management of the application with up to 16 languages
- ▶ Messaging and recording system
- ▶ Font editor for creating your own character sets
- ▶ Easy graphics incorporation via OLE
- ▶ Direct access to all control and drive variables
- ▶ Project and firmware download for downloadable functions
- ▶ Integrated creation of documentation and online help
- ▶ Predefined masks, curves and bar graphs
- ▶ Definition of free menu structures
- ▶ Screen elements: texts, variables, graphics, switches, buttons, drop-down list boxes, tables, etc.



VI-Composer – efficient programming of your application in a convenient development environment

VI-Composer – technical data/ordering data

IndraWorks VI-Composer	
Development license for operation system	Windows XP/2000/NT/7
Firmware	Integrated in all VCP/VCH devices
Variables	65,535
Connections	Download: Ethernet TCP/IP
Communication	Serial, PROFIBUS
Messages	9,999
Messaging buffer	3,000
Protocol driver	3S serial, Rexroth BUEP19E, BRC-Symbolic, DeviceNet, IndraLogic, PROFIBUS
Support of Asian characters	•
Print reports	•
Firmware download	•
Application upload	•
Recipe handling	•
Messaging and recording system	•
Online help	•
Integrated creation of documentation	•
Variables represented by curves and bar graphs	•
Translation support for multi-lingual projects	•
Graphics incorporation via OLE	With terminals with graphics capability
Development license	German/English

• Default

Ordering data for software

Description	Type code
VI-Composer software CD	SWA-VIC*PC-INB-xxVRS-D0-CD650

Ordering data for documentation

Description	Type code
Application manual, user manual	DOK-SUPPL *-VIC*BEDIEN*-AWxx-DE-P

• Default; xx = software/firmware version

IndraWorks tool: WinStudio – intelligent software for creating graphical HMI interfaces

WinStudio is the innovative visualization module of the IndraWorks software framework for consistent engineering and user-friendly operation. WinStudio allows you to create your individual applications quickly, easily and efficiently – with one tool for all applications.

Together with the embedded PCs and the PC-based HMI solutions from Rexroth, WinStudio ensures maximum functionality and optimum performance. The flexible licensing model is available in development and runtime versions. Needing only one development version, you can adapt your applications as often as desired and use them with various Runtime versions. This design allows continuous improvement to your machines and is also very cost effective.

Your benefits

- ▶ Less project development and maintenance work through a uniform visualization software
- ▶ Clearly organized selection of objects via the project explorer
- ▶ Easy creation of screens with comprehensive libraries
- ▶ Dynamic generation of websites
- ▶ Easy project planning without knowledge of high-level languages
- ▶ Graded software packages for individual adaptation
- ▶ UNICODE characters
- ▶ Auto-screen scaling

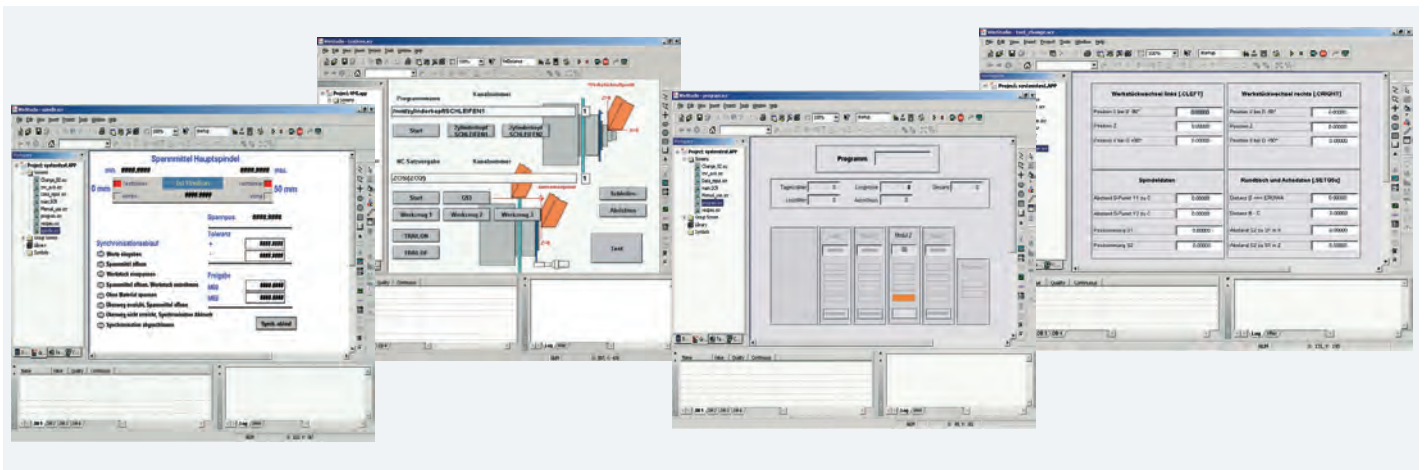

WinStudio – easy and effective project planning in the development environment by drag-and-drop

WinStudio – technical data/ordering data

Type	WinStudio lite	WinStudio 1.5 k	WinStudio 4 k	WinStudio 64 k	WinStudio 512 k	WinStudio lite	WinStudio 1.5 k	WinStudio 4 k
Operating system	WinXP/2000/ Server 2003/ Vista	WinXP/2000/ Server 2003/ Vista	WinXP/2000/ Server 2003/ Vista	WinXP/2000/ Server 2003/ Vista	WinXP/2000/ Server 2003/ Vista	WinCE	WinCE	WinCE
Runtime license	WinXP/2000/ Server 2003/ Vista	WinXP/2000/ Server 2003/ Vista	WinXP/2000/ Server 2003/ Vista	WinXP/2000/ Server 2003/ Vista	WinXP/2000/ Server 2003/ Vista	–	–	–
Operating system development license	500	1,500	4,000	64,000	512,000	500	1,500	4,000
Max. number of variables	256	256	512	1,024	16,384	256	256	512
Max. array size	32	32	32	64	512	32	32	32
Max. number of classes	–	•	•	•	•	–	•	•
Recipe handling (UNICODE, XML)	•	•	•	•	•	–	–	–
.NET controls	•	•	•	•	•	•	•	•
ODBC	–	•	•	•	•	–	•	•
Mathematics	–	•	•	•	•	–	•	•
Alarm/events	–	•	•	•	•	–	•	•
History	1	3	5	8	8	1	3	3
Driver	–	•	•	•	•	–	•	•
OPC server	•	•	•	•	•	•	•	•
OPC client	•	•	•	•	•	•	•	•
TCP/IP server	–	•	•	•	•	–	•	•
TCP/IP client	–	•	•	•	•	–	–	–
DDE server/client	•	•	•	•	•	•	•	•
Tags database	–	1/4/8	1/4/8	1/4/8	1/4/8	–	1/4/8	1/4/8
Web clients (optional from WinStudio 7.2)								

• Default – Not available

WinStudio – ordering data

Ordering data for software	
Description	Type code
WinStudio software DVD	SWA-WINSTU-RUD-xxVRS-D0-DVD
RUD/1.5K (Editor licenses Windows 2K/XP)	SWS-WINSTU-RUD-xxVRS-D0-1K5
RUD/4K (Editor licenses Windows 2K/XP)	SWS-WINSTU-RUD-xxVRS-D0-4K
RUD/64K (Editor licenses Windows 2K/XP)	SWS-WINSTU-RUD-xxVRS-D0-64K
RUD/512K (Editor licenses Windows 2K/XP)	SWS-WINSTU-RUD-xxVRS-D0-512K
RUN/1.5K (Runtime licenses Windows 2K/XP)	SWS-WINSTU-RUN-xxVRS-D0-1K5
RUN/4K (Runtime licenses Windows 2K/XP)	SWS-WINSTU-RUN-xxVRS-D0-4K
RUN/64K (Runtime licenses Windows 2K/XP)	SWS-WINSTU-RUN-xxVRS-D0-64K
RUN/512K (Runtime licenses Windows 2K/XP)	SWS-WINSTU-RUN-xxVRS-D0-512K
RUN/4K – 1 Web client (Runtime licenses Windows 2K/XP with Web client)	SWS-WINSTU-RUW-xxVRS-D0-1K5-1CL
RUN/1K5 – 1 Web client (Runtime licenses Windows 2K/XP with Web client)	SWS-WINSTU-RUW-xxVRS-D0-4K-1CL
RUN/64K – 1 Web client (Runtime licenses Windows 2K/XP with Web client)	SWS-WINSTU-RUW-xxVRS-D0-64K0-1CL
RUN/512K – 1 Web client (Runtime licenses Windows 2K/XP with Web client)	SWS-WINSTU-RUW-xxVRS-D0-512K-1CL
RUN/1K5 – 4 Web clients (Runtime licenses Windows 2K/XP with Web client)	SWS-WINSTU-RUW-xxVRS-D0-1K5-4CL
RUN/4K – 4 Web clients (Runtime licenses Windows 2K/XP with Web client)	SWS-WINSTU-RUW-xxVRS-D0-4K-4CL
RUN/64K – 4 Web clients (Runtime licenses Windows 2K/XP with Web client)	SWS-WINSTU-RUW-xxVRS-D0-64K0-4CL
RUN/512K – 4 Web clients (Runtime licenses Windows 2K/XP with Web client)	SWS-WINSTU-RUW-xxVRS-D0-512K-4CL
RUN/1K5 – 8 Web clients (Runtime licenses Windows 2K/XP with Web client)	SWS-WINSTU-RUW-xxVRS-D0-1K5-8CL
RUN/4K – 8 Web clients (Runtime licenses Windows 2K/XP with Web client)	SWS-WINSTU-RUW-xxVRS-D0-4K-8CL
RUN/64K – 8 Web clients (Runtime licenses Windows 2K/XP with Web client)	SWS-WINSTU-RUW-xxVRS-D0-64K-8CL
RUN/512K – 8 Web clients (Runtime licenses Windows 2K/XP with Web client)	SWS-WINSTU-RUW-xxVRS-D0-512K-8CL
RUN/1.5K – CE devices (Runtime licenses for Windows CE devices)	SWS-WINSTU-RUN-xxVRS-D0-WCE1K5
RUN/4K – CE devices (Runtime licenses for Windows CE devices)	SWS-WINSTU-RUN-xxVRS-D0-WCE4K
RUN/1K5 – 1 Web client (Runtime licenses Windows CE with Web client)	SWS-WINSTU-RUW-xxVRS-D0-WCE1K5-1CL
RUN/4K – 1 Web client (Runtime licenses Windows CE with Web client)	SWS-WINSTU-RUW-xxVRS-D0-WCE4K-1CL
RUN/1K5 – 4 Web clients (Runtime licenses Windows CE with Web client)	SWS-WINSTU-RUW-xxVRS-D0-WCE1K5-4CL
RUN/4K – 4 Web clients (Runtime licenses Windows CE with Web client)	SWS-WINSTU-RUW-xxVRS-D0-WCE4K-4CL
RUN/1K5 – 8 Web clients (Runtime licenses Windows CE with Web client)	SWS-WINSTU-RUW-xxVRS-D0-WCE1K5-8CL
RUN/4K – 8 Web clients (Runtime licenses Windows CE with Web client)	SWS-WINSTU-RUW-xxVRS-D0-WCE4K-8CL
Ordering data for accessories	
Description	Type code
USB dongle	B-AC USB-Dongle
Ordering data for documentation	
Description	Type code
Application manual, user manual	DOK-CONTRL-WIS*PC**Vxx-KBxx-DE-P

xx = software/firmware version

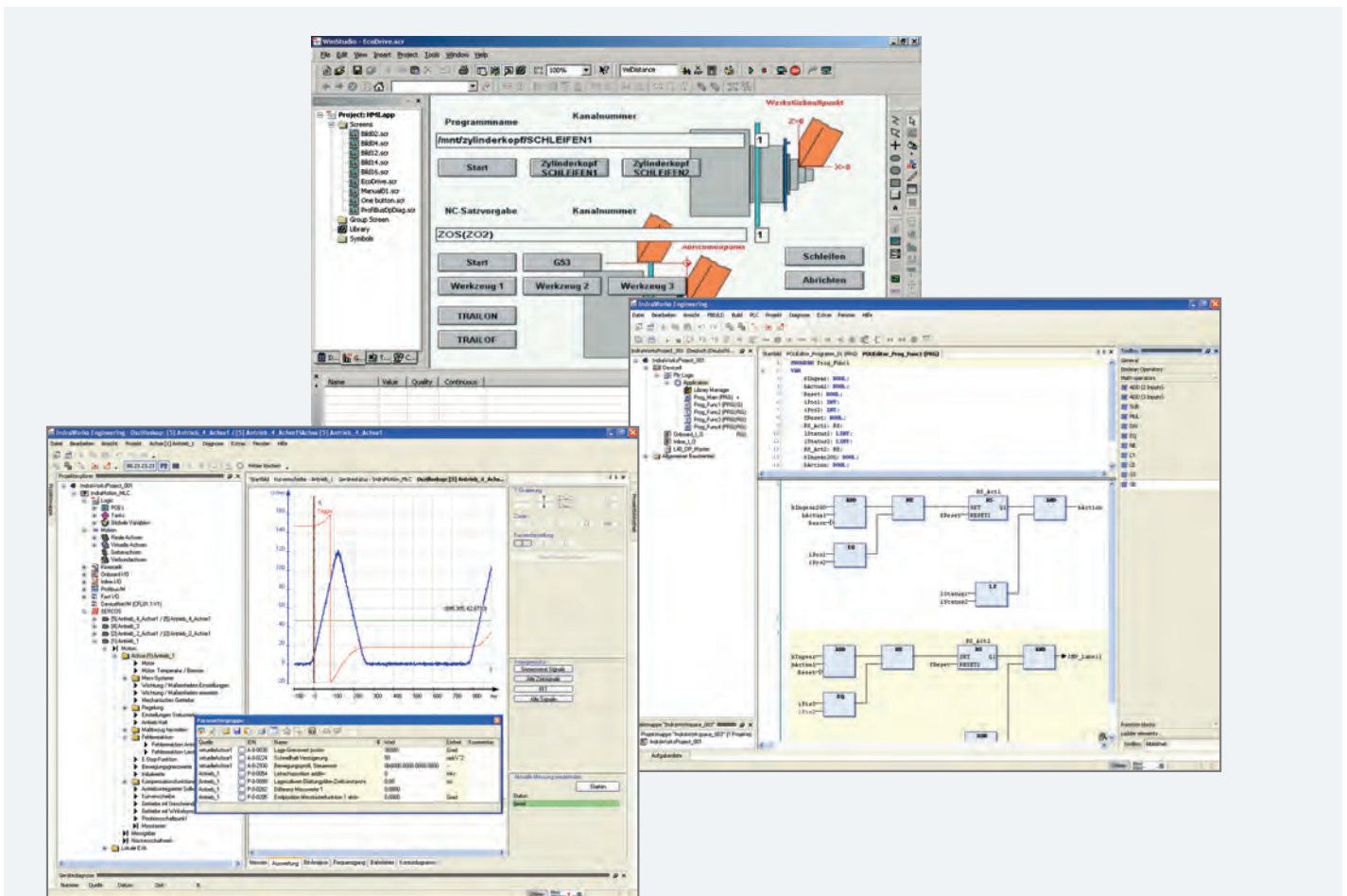

IndraControl V – trend-setting human-machine interfaces (HMI) and industrial PCs

Rexroth IndraControl V is the comprehensive HMI system range for individual control, operation and visualization in all industries. The program range covers controller-based devices, compact embedded PCs and high-performance industrial PCs. With its scalable hardware and software, IndraControl V can be precisely adapted to your machine-specific requirements.

IndraControl V integrates all functions required for cost-effective automation – from convenient operation and clearly organized visualization to integrated controls and diagnosis. When combined with the proven system solutions from Rexroth, IndraControl V provides you with a complete automation solution for:

- ▶ Machine tools
- ▶ Transfer machines
- ▶ Printing presses and processing machines
- ▶ Food processing and packaging machines
- ▶ Forming machines

- ▶ Wood processing machines
- ▶ Textile machines
- ▶ Handling and assembly systems

IndraControl V is available in the following versions:

- ▶ Controller-based
IndraControl VCP
IndraControl VCH
- ▶ Embedded-PC-based
IndraControl VEP
IndraControl VEH
- ▶ PC-based
IndraControl VPP
IndraControl VPB
IndraControl VDP
- ▶ Additional components
IndraControl VAK
IndraControl VAM



IndraControl V –
the comprehensive product
range for individual control,
operation and visualization
in all industries

Versatile, sturdy, and modular

- ▶ Consistent range for control, operation and visualization
- ▶ Reliable system technology, even in hostile industrial environments
- ▶ Future-proof through modern PC technology



IndraControl VCP – controller-based compact operator panels



These controller-based compact operator panels allow you to edit production data simply by pressing a key or touching the screen. The system versions cover a range from simple small graphics displays to touch screens with full graphics capabilities – with the number of function keys depending on the system design.

The comprehensive interface range supports communication via Ethernet TCP/IP, fieldbus or serial.

- ▶ Inexpensive operation and visualization
- ▶ Compact dimensions
- ▶ Easy configuration of the system visualization
- ▶ Comprehensive functions with the visualization software VI-Composer
- ▶ Support of Asian character sets

IndraControl VCH – compact manual operator panel for mobile use



Irrespective of the particular location – IndraControl VCH 08 allows operation, setup, parameterization and diagnosis via Ethernet TCP/IP. During connection and disconnection, the stop function is overridden automatically, thus ensuring smooth work. Together with the optimal design, the low weight allows fatigue-free work and high operator convenience. The integrated 3-step enabling button and 2-circuit stop button ensure maximum safety.

- ▶ Safety functions for man and machine
- ▶ Handles with integrated enabling and stop buttons
- ▶ Sturdy structure for industrial use
- ▶ Optimum ergonomics for reliable fatigue-free handling
- ▶ 9.7 cm (3.8") graphics display and universal-use touch panel

IndraControl VEP – embedded-PC-based operator panels



These panels allow you to operate your machine easily and conveniently via a touch screen or a virtual keyboard. These “almost a PC” devices only use embedded components to maximize reliability. Through the multitude of interfaces and slots, the IndraControl VEP devices can be optimally adapted to comply with machine and system requirements. This allows you to use the devices for visualization or as control hardware. Expand your embedded PCs with our soft PLC solution IndraLogic.

- ▶ Compact system design for control cabinet mounting
- ▶ Hardware without hard disk or rotating media
- ▶ Control and visualization in a single device
- ▶ Integrated short-time UPS
- ▶ Visualization, operation and observation with the common WinStudio visualization software

IndraControl V – trend-setting human-machine interfaces (HMI) and industrial PCs

IndraControl VEH – manual operator panel for mobile use



Irrespective of the particular location – IndraControl VEH 30 allows operation, setup, parameterization and diagnosis via Ethernet TCP/IP. The hot-plug principle facilitates trouble-free connection and disconnection during running operation, while the stop function is reliably overridden. The integrated 3-step enabling button and the 2-circuit stop button are looped in through the connection module V AC 30, thus ensuring maximum safety.

- ▶ Flexible use through hot-plug principle
- ▶ Safety functions for man and machine
- ▶ Handles with integrated enabling and stop buttons
- ▶ Sturdy structure for industrial use
- ▶ Optimum ergonomics for reliable fatigue-free handling
- ▶ Brilliant 21.3 cm (8.4") touch screen for convenient operation and visualization

IndraControl VPP – compact panel PCs for industrial applications



The mechanical and electrical design of the IndraControl VPP compact PC operator terminals make them ideal for applications that involve confined spaces. SSD memory, an optimized cooling concept and temperature monitoring ensure excellent reliability. The long-term availability of the devices and software packages gives you maximum investment security when developing and duplicating your machines.

- ▶ Best industry compatibility through the use of reliable hardware components
- ▶ Vibration resistance during operation
- ▶ Shock loading capacity
- ▶ Low heat losses through optimized cooling system
- ▶ Components, such as processors, motherboards, etc., available over the long term
- ▶ Ensured service capability, at least 5 years

IndraControl VPB and VDP – ideal PC solution for distributed architecture



IndraControl VPB and VDP provide a professional solution for applications where PC and control unit have to be separated. While the industrial PC is safely kept in the control cabinet, the sturdy and extremely thin operator display can be attached directly to the machine. To meet various industrial requirements, both the PCs and the displays are available in different versions.

- ▶ Compact cabinet PC (VPB) with special hardware for hostile industrial environments
- ▶ Thin displays (VDP), with optional keys or touch screen
- ▶ Individual solution for distributed operating and control designs
- ▶ Up to four displays at one industrial PC

IndraControl VEP and VDP – robust operator terminals with an ergonomic housing



IndraControl V operator terminals combine flat operator displays or embedded PCs with industrial-strength housings to form a robust unit. The IP54-compliant terminals, with IP65 protection at the front, are operated via a TFT touch screen, three function buttons, and an emergency stop button. The single-piece metal housing, with ergonomically-shaped grips and holders to VESA standards, enables user- and service-friendly operation directly at the machine.

Operator display IndraControl VDP

- ▶ Hot plug-capable CDI interface
- ▶ Distance of up to 80 meters from the industrial PC

Embedded PC IndraControl VEP

- ▶ Hardware with no hard drive, no rotating media
- ▶ Control and visualization in a single device
- ▶ Integrated UPS for temporary power

IndraControl VAK und VAM – ergonomic industrial keyboards and machine control panels



The compact industrial keyboards and the comfortable machine control panels allow you to configure a perfect and individual control and visualization design of your machine. These additional components are precisely matched to our IndraControl V devices and, with the industry-compatible design, ensure reliable and safe operation.

Slide-out keyboards

IndraControl VAK

- ▶ Alphanumeric keyboard and integrated mouse
- ▶ Protection to IP65 both when closed and when open

Touch panels IndraControl VAK







- ▶ Robust complete keyboard with configurable keys and separate number pad
- ▶ Protection to IP65
- ▶ Low installation depth

Machine control panels

IndraControl VAM

- ▶ Optimized operator design for standard machine tools and automated production
- ▶ Protection to IP54

IndraControl VCP – technical data

Technical data	VCP 02	VCP 05	VCP 08	VCP 11	VCP 20	VCP 25	VCP 35
							
Display	FSTN			FSTN-Touch/ TFT-Touch	FSTN	STN-color-Touch	TFT-Touch
	With graphics capability					With full graphics capability	With full graphics capability
	5 gray tones			5 gray tones/ 256 colors	5 gray tones	125 colors	256 colors
	7.6 cm (3")	7.6 cm (3")	9.7 cm (3.8")	9.7 cm (3.8")/ 8.9 cm (3.5")	14.5 cm (5.7")	14.5 cm (5.7")	25.4 cm (10.4")
Resolution	160 x 80	160 x 80	320 x 240	320 x 240/ 320 x 240	320 x 240	320 x 240	640 x 480
Keyboard/touch	Foil keys			Touch screen	Foil keys	Touch screen	Touch screen
Function keys/ system keys	4/7 (2 with LED)	6/24 (3 with LED)	15 (12 with LED)/ 24 (3 with LED)	–	8/16 (8 with LED)	–	–
Application memory				3 MB			
Flash memory				32 MB			
Slot for extensions				1			
Supply voltage				24 V DC			
Interfaces	1 x Ethernet TCP/IP, 2 x USB host, optional: 1 module RS232/RS485						
Fieldbus				PROFIBUS slave			
Approvals				CE/UL/CSA			
Protection category				Front IP65			
Temperature				5 to 45°C			
Dimensions (W x H x D)	144 x 96 x 58 mm	120 x 168 x 55 mm	155 x 205 x 55 mm	130 x 96 x 55 mm/ 130 x 96 x 58 mm	300 x 160 x 55 mm	203 x 147 x 66 mm	328 x 249 x 60 mm
Availability							
Automation system	IndraMotion MLD, IndraMotion MLC, IndraMotion MTX, IndraLogic XLC, IndraLogic, SYNAX 200 (technical details on request)						

● Standard ▼ In preparation ○ Optional – Not available

IndraControl VCP – ordering data

Ordering data for hardware	
Description	Type code
IndraControl VCP 02	VCP02.2DRN-003-NN-NN-PW
IndraControl VCP 02 with serial interfaces	VCP02.2DRN-003-SR-NN-PW
IndraControl VCP 02 PROFIBUS DP slave	VCP02.2DRN-003-PB-NN-PW
IndraControl VCP 05	VCP05.2DSN-003-NN-NN-PW
IndraControl VCP 05 with serial interfaces	VCP05.2DSN-003-SR-NN-PW
IndraControl VCP 05 PROFIBUS DP slave	VCP05.2DSN-003-PB-NN-PW
IndraControl VCP 08	VCP08.2DTN-003-NN-NN-PW
IndraControl VCP 08 with serial interfaces	VCP08.2DTN-003-SR-NN-PW
IndraControl VCP 08 PROFIBUS DP slave	VCP08.2DTN-003-PB-NN-PW
IndraControl VCP 11	VCP11.2DWN-003-NN-NN-PW
IndraControl VCP 11 with serial interfaces	VCP11.2DWN-003-SR-NN-PW
IndraControl VCP 11 PROFIBUS DP slave	VCP11.2DWN-003-PB-NN-PW
IndraControl VCP 11 (TFT display)	VCP11.2ECN-003-NN-NN-PW
IndraControl VCP 11 PROFIBUS DP slave (TFT display)	VCP11.2ECN-003-PB-NN-PW
IndraControl VCP 20	VCP20.2DUN-003-NN-NN-PW
IndraControl VCP 20 with serial interfaces	VCP20.2DUN-003-SR-NN-PW
IndraControl VCP 20 PROFIBUS DP slave	VCP20.2DUN-003-PB-NN-PW
IndraControl VCP 25	VCP25.2DVN-003-NN-NN-PW
IndraControl VCP 25 with serial interfaces	VCP25.2DVN-003-SR-NN-PW
IndraControl VCP 25 PROFIBUS DP slave	VCP25.2DVN-003-PB-NN-PW
IndraControl VCP 35	VCP35.2ECN-003-NN-NN-PW
IndraControl VCP 35 with serial interfaces	VCP35.2ECN-003-SR-NN-PW
IndraControl VCP 35 PROFIBUS DP slave	VCP35.2ECN-003-PB-NN-PW
Ordering data for accessories	
Description	Type code
Battery kit	VAS04.1-001-002-NN
Ordering data for documentation	
Description	Type code
IndraControl VCP 02 project planning manual in German	DOK-SUPPL*VCP*02.2***-PRxx-DE-P
IndraControl VCP 02 project planning manual in English	DOK-SUPPL*VCP*02.2***-PRxx-EN-P
IndraControl VCP 05 project planning manual in German	DOK-SUPPL*VCP*05.2***-PRxx-DE-P
IndraControl VCP 05 project planning manual in English	DOK-SUPPL*VCP*05.2***-PRxx-EN-P
IndraControl VCP 08 project planning manual in German	DOK-SUPPL*VCP*08.2***-PRxx-DE-P
IndraControl VCP 08 project planning manual in English	DOK-SUPPL*VCP*08.2***-PRxx-EN-P
IndraControl VCP 11 project planning manual in German	DOK-SUPPL*VCP*11.2***-PRxx-DE-P
IndraControl VCP 11 project planning manual in English	DOK-SUPPL*VCP*11.2***-PRxx-EN-P
IndraControl VCP 20 project planning manual in German	DOK-SUPPL*VCP*20.2***-PRxx-DE-P
IndraControl VCP 20 project planning manual in English	DOK-SUPPL*VCP*20.2***-PRxx-EN-P
IndraControl VCP 25 project planning manual in German	DOK-SUPPL*VCP*25.2***-PRxx-DE-P
IndraControl VCP 25 project planning manual in English	DOK-SUPPL*VCP*25.2***-PRxx-EN-P
IndraControl VCP 35 project planning manual in German	DOK-SUPPL*VCP*35.2***-PRxx-DE-P
IndraControl VCP 35 project planning manual in English	DOK-SUPPL*VCP*35.2***-PRxx-EN-P
IndraControl VCP xx. operator design in German	DOK-SUPPL*-VIC*BED*02*Awxx-DE-P
IndraControl VCP xx. operator design in English	DOK-SUPPL*-VIC*BED*02*Awxx-EN-P

xx = software/firmware version

IndraControl VCP 02 and VCP 05

IndraControl VCP 02

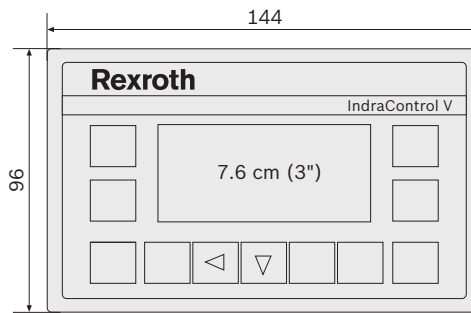

IndraControl VCP 05

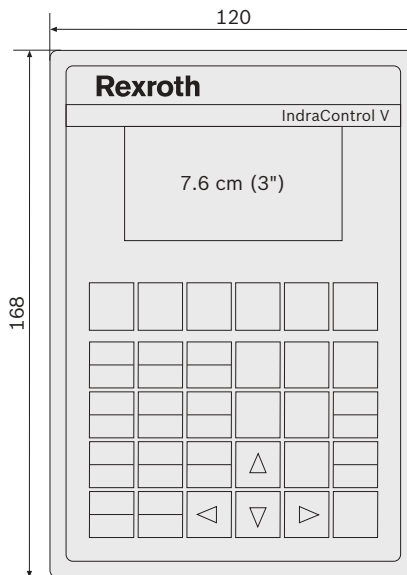

IndraControl VCP 08 and VCP 11

IndraControl VCP 08

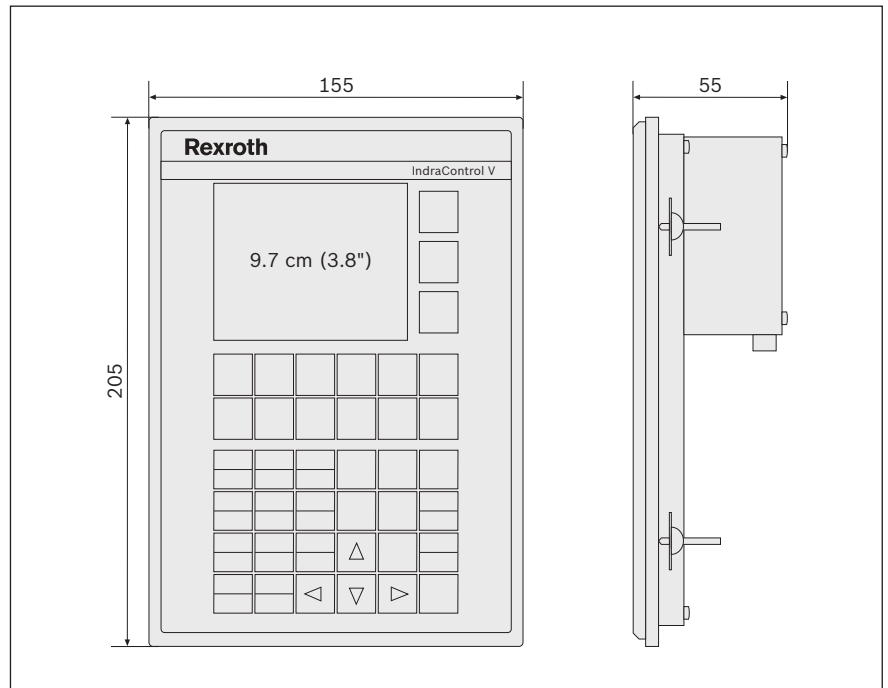
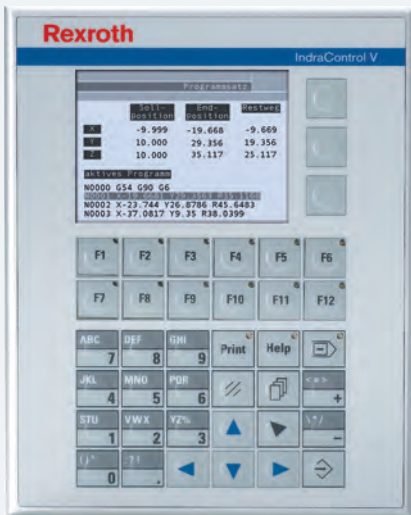

IndraControl VCP 11

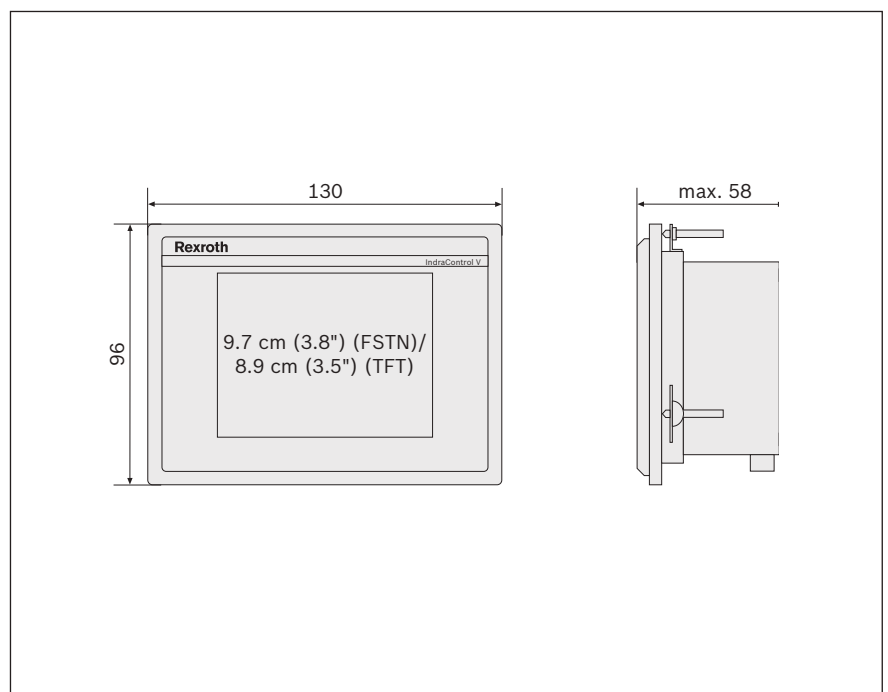
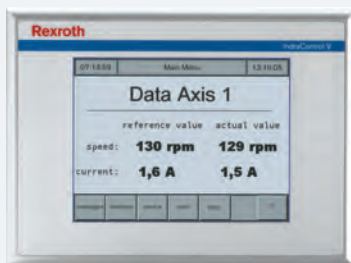

IndraControl VCP 20 and VCP 25

IndraControl VCP 20

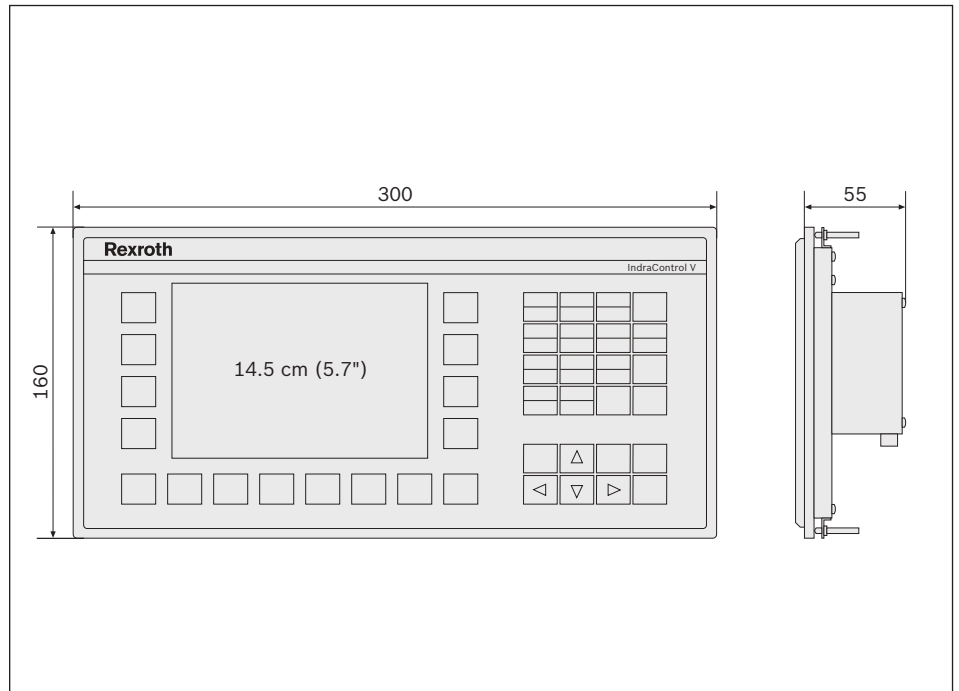
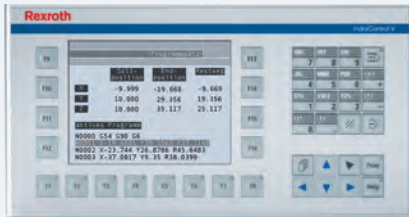

IndraControl VCP 25

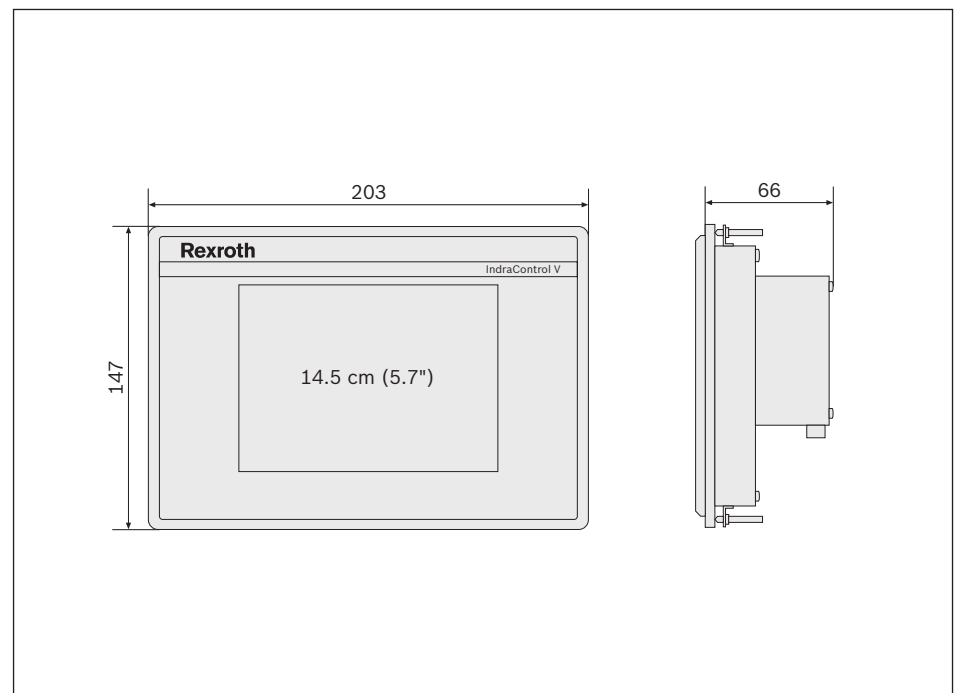

IndraControl VCP 35

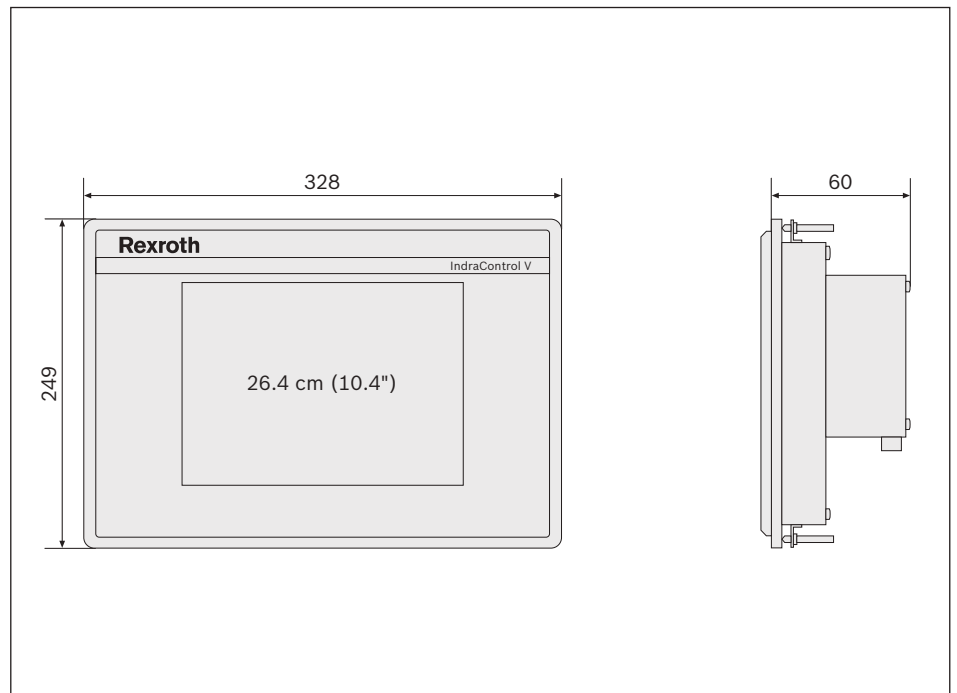

IndraControl VCH – technical data/ordering data



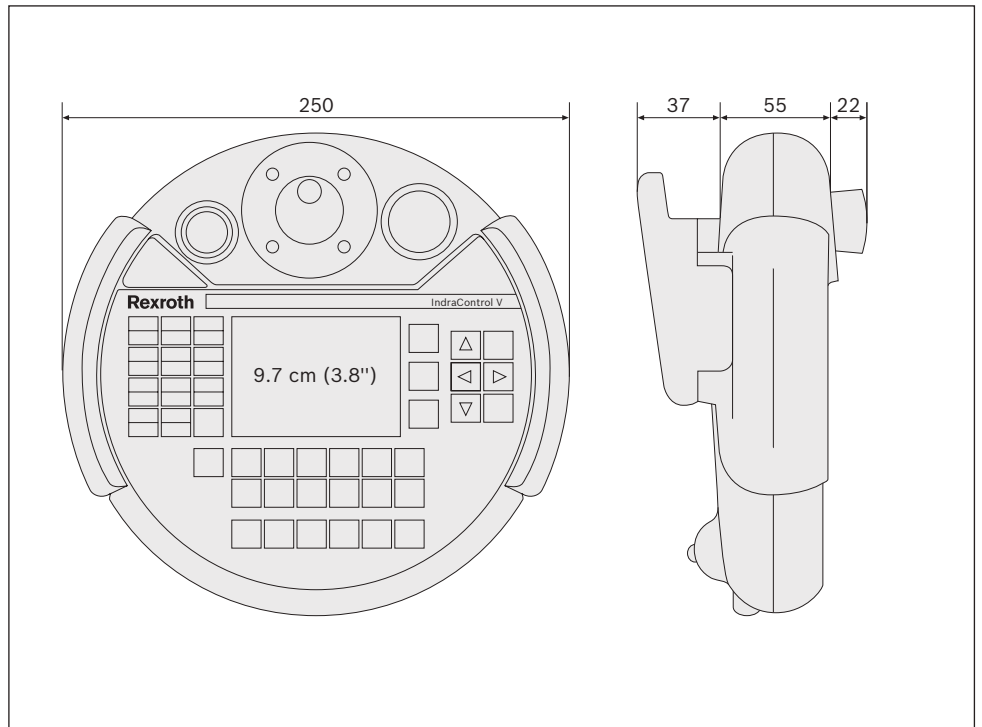

Technical data		VCH 08
		
Display	9.7 cm (3.8") – gray tones	
Resolution	320 x 240	
Touch screen	–	
Keyboard	40 foil keys	
Function keys	18 user-configurable function keys	
Stop/emergency-off button	●/○	
2 enabling buttons (2-circuit, 3-step)	●	
Override potentiometer	●	
Handwheel	○	
Processor	PXA 270/416 MHz	
RAM	64 MB	
CompactFlash	64 MB	
Supply voltage	24 V DC	
Visualization	VI-Composer	
Approvals	UL 508, UL 1740, SIBE, CSA	
Protection category	IP65	
Temperature	5 – 45°C	
Dimensions (W x H x D)	Diameter 250 x 55 mm + 37 mm handle + 22 mm stop button	
Weight	1.1 kg	
Max. height of fall	1.5 m	
Cable length	0.5/8 m	
Availability		
Automation system	IndraMotion MLD, IndraMotion MLC, IndraMotion MTX, IndraLogic (technical details on request)	
Ordering data for hardware		
Description	Type code	
IndraControl VCH 08 with stop button (8 m Ethernet control cable)	VCH08.1EAB-064ET-A1D-064-CS-E4-PW	
IndraControl VCH 08 with stop button, handwheel (8 m Ethernet)	VCH08.1EAB-064ET-A1D-064-DS-E4-PW	
IndraControl VCH 08 with stop button (0.5 m Ethernet control cable)	VCH08.1EAB-064ET-A1D-064-CS-E2-PW	
IndraControl VCH 08 with emergency-off button (0.5 m Ethernet)	VCH08.1EAB-064ET-A1D-064-FS-B2-PW	
Ordering data for accessories		
Description	Type code	
Connection module for VCH08.1 with stop button	VAC30.2N-NN	
Connection module for VCH08.1 with emergency-off button	VAC31.1C-NN	
Wall-mounted holder for VCH08.1	VAS01.1-002	
Extension cable for VCH08.1 with stop button	RKS0011/16.0	
Extension cable for VCH08.1 with emergency-off button	RKS0012/016.0	
Ordering data for documentation		
Description	Type code	
IndraControl VCH08.1 project planning manual in German	DOK-SUPPL*-VCH*08.1***-PR02-DE-P	
IndraControl VCH08.1 project planning manual in English	DOK-SUPPL*-VCH*08.1***-PR02-EN-P	

● Standard ▼ In preparation ○ Optional – Not available xx = software/firmware version

IndraControl VCH 08



IndraControl VEP (series 3) – technical data



Technical data	VEP 30.3	VEP 40.3	VEP 50.3	VEP 30.3 DK
				
Display	21.3 cm (8.4") – TFT	30.7 cm (12.1") – TFT	38.1 cm (15") – TFT	21.3 cm (8.4") – TFT
Resolution	800 x 600, SVGA	800 x 600, SVGA	1,024 x 768, XGA	800 x 600, SVGA
Touch screen	●			
Keyboard	Via virtual keyboard			
	–	–	–	3 function buttons/ 1 emergency-off button
Processor	Celeron 600 MHz			
RAM	512 MB			
CompactFlash	2 CF sockets, 1 x 1 GB CF card fitted			
Module slots	1			
Supply voltage	24 V DC			
Interfaces	RS232, 2 x USB, 2 x Ethernet			
Fieldbus	○ Fieldbus module (PROFIBUS master) occupies 1 slot			
UPS	○ Short-time UPS for data backup (512 kB) to CF card			
Operating system	Windows CE 4.2			
Approvals	CE/UL/CSA			
Protection category	Front IP65			Overall IP54
Temperature	5 to 45°C			
Dimensions (W x H x D)	296 x 200 x 75 mm	350 x 290 x 73 mm	407 x 370 x 75 mm	246 x 280 x 85 mm
Availability				
Automation system	IndraLogic (technical details on request)			
● Standard ▼ In preparation ○ Optional – Not available				

IndraControl VEP (series 3) – ordering data

Ordering data for hardware	
Description	Type code
IndraControl VEP30, PROFIBUS DP, control component	VEP30.3CCU-256NA-MAD-128-NN-FW
IndraControl VEP30, operator terminal, PROFIBUS DP, control component	VEP30.3DKU-256NA-MAD-128-CG-FW
IndraControl VEP40, PROFIBUS DP, control component	VEP40.3CEU-256NA-MAD-128-NN-FW
IndraControl VEP50, PROFIBUS DP, control component	VEP50.3CHU-256NA-MAD-128-NN-FW
Ordering data for firmware	
Description	Type code
Firmware for IndraControl VEP xx.3 with support of Asian characters	FWA-VEP*03-CWL-xxVRS-D0
Ordering data for documentation	
Description	Type code
IndraControl VEPxx.3 project planning manual in German	DOK-SUPPL*-VEP**_3****-PRxx-DE-P
IndraControl VEPxx.3 project planning manual in English	DOK-SUPPL*-VEP**_3****-PRxx-EN-P

xx = software/firmware version

IndraControl VEP (series 4) – technical data

Technical data	VEP30.4		VEP40.4		VEP50.4	
						
Display	21.3 cm (8.4") – TFT		30.7 cm (12.1") – TFT		38.1 cm (15") – TFT	
Resolution	800 x 600, SVGA				1024 x 768, XGA	
Touch screen	Yes		No		Yes	
Machine/function/additional keys	–		–		Yes	
Processor	Intel Atom processor 1.1 GHz.					
RAM	1 GB					
CompactFlash	2 CF sockets, ● 1 GB CF card fitted, ○ 4 GB CF card fitted					
Module slots	–					
Supply voltage	24 V DC					
Interfaces						
USB	3 (1 x front)					
Ethernet TCP/IP	1					
Operating system	Windows CE 6.0/Windows Xpe					
Approvals	CE/UL/CSA					
Protection category	Front IP65					
Temperature	5 to 45°C					
Dimensions (W x H x D)	296x200x53 mm	350x290x51 mm	350x290x51 mm	407x370x53 mm	407x370x53 mm	
Availability						
Automation system	IndraMotion MLC, IndraMotion MTX, IndraLogic XLC, IndraLogic (technical details on request)					

● Standard ▼ In preparation ○ Optional

IndraControl VEP (series 4) – ordering data

Ordering data for hardware	
Description	Type code
IndraControl VEP30, visualization	VEP30.4EFN-512NN-A2D-NNN-NN-FW
IndraControl VEP40, visualization	VEP40.4DBN-512NN-A2D-NNN-NN-FW
IndraControl VEP40, keys, visualization	VEP40.4BKN-512NN-A2D-NNN-NN-FW
IndraControl VEP50, visualization	VEP50.4DEN-512NN-A2D-NNN-NN-FW
IndraControl VEP50, keys, visualization	VEP50.4BIN-512NN-A2D-NNN-NN-FW
Ordering data for firmware	
Description	Type code
Firmware for IndraControl VEP xx.4-Atom (Windows CE 6.0)	FWA-VEP*04-CWN-10VRS-D0-A*
Firmware for IndraControl VEP xx.4-Atom (Windows Xpe)	FWA-VEP*04-XPE-01VRS-D0-A*
Ordering data for documentation	
Description	Type code
IndraControl VEPxx.4 project planning manual in German	DOK-SUPPL *-VEP*XX.4***-PRxx-DE-P
IndraControl VEPxx.4 project planning manual in English	DOK-SUPPL *-VEP*XX.4***-PRxx-EN-P

xx = software/firmware version

IndraControl VEP 30

IndraControl VEP 30

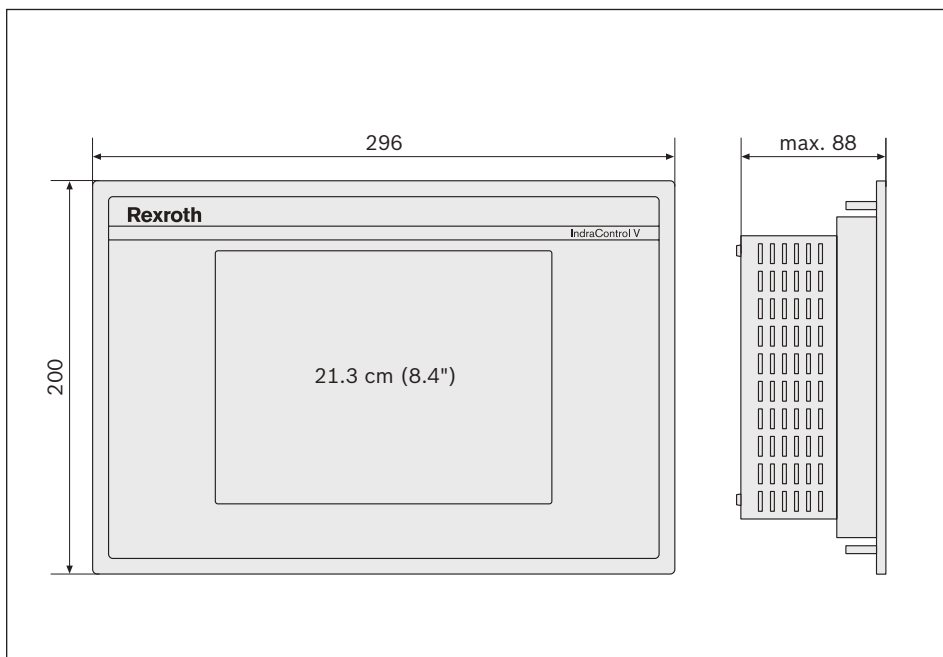
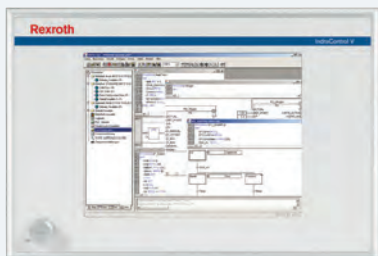

IndraControl VEP 30 DP

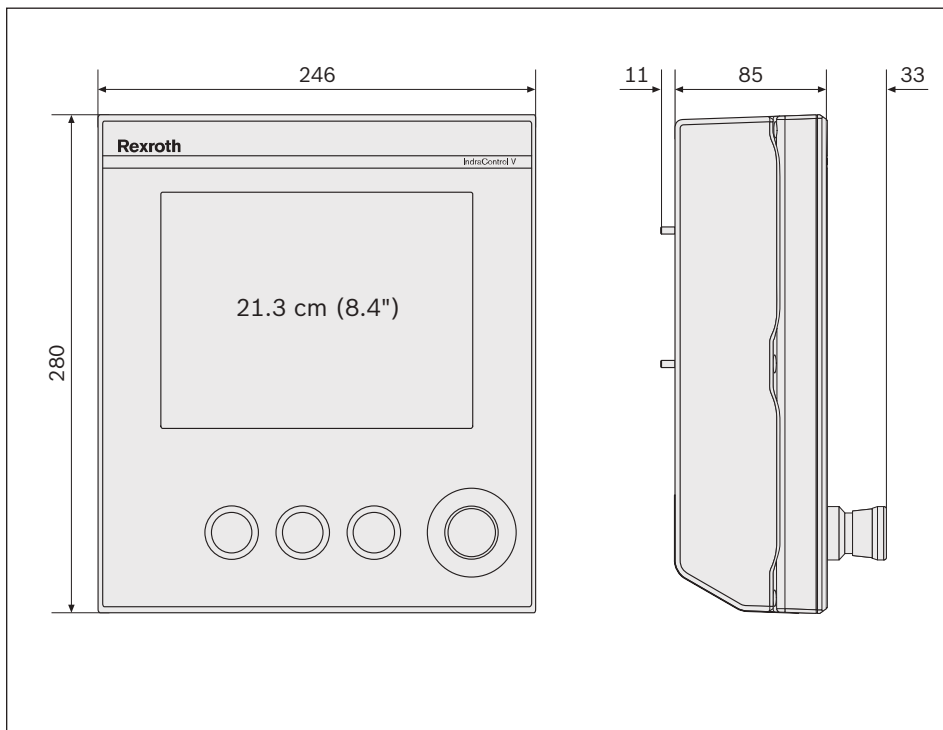

IndraControl VEP 40 and VEP 50

IndraControl VEP 40

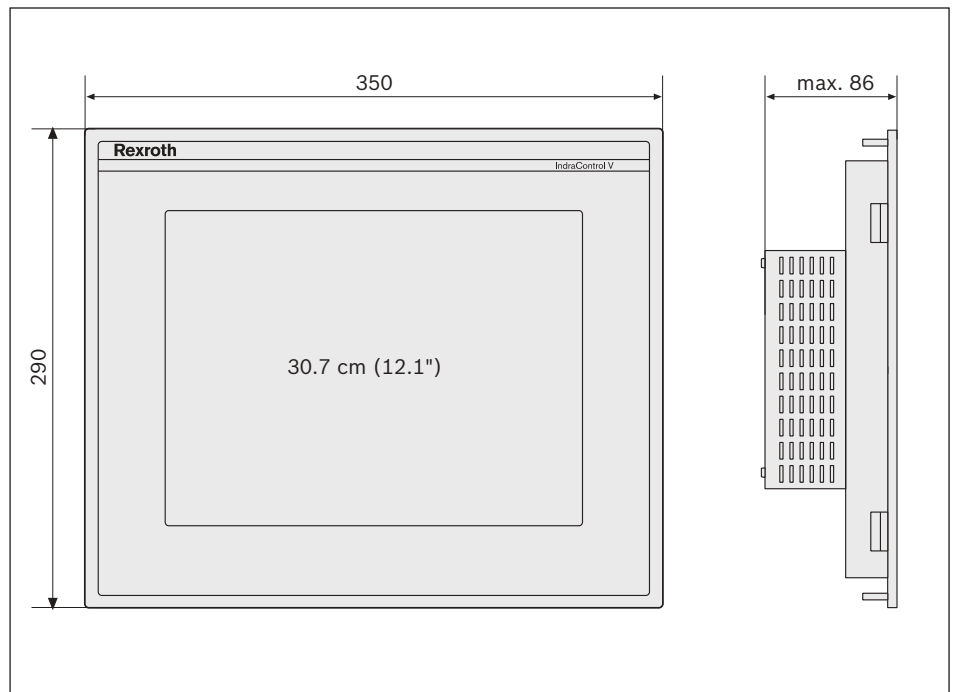

IndraControl VEP 50

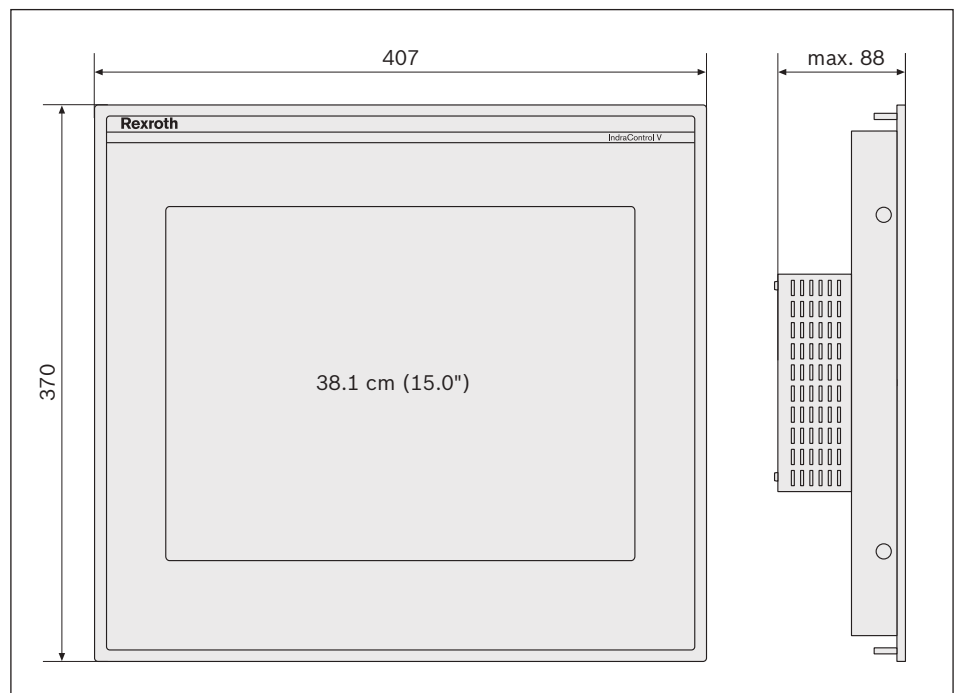

IndraControl VEH – technical data/ordering data

Technical data	VEH 30
	
Display	21.3 cm (8.4") – TFT
Resolution	1024 x 768, XGA/800 x 600, SVGA
Touch screen	•
Keyboard	Via virtual keyboard
Function keys	36 foil keys: 2 x 6 jog keys, 2 x 8 user-configurable keys, 8 navigation keys
Stop/emerg.-off button (2-circuit)	•/○
2 enabl. buttons (2-circuit, 3-step)	•
Override potentiometer	○
Handwheel	○
Processor	Intel Atom 1.1 GHz
RAM	512 MB
Flash memory	4 GB
Supply voltage	24 V DC
Operating system	Windows Xpe
Approvals	CE/UL/CSA/BG
Protection category	IP65
Temperature	5–45°C
Dimensions (W x H x D)	270 x 290 x 76 mm + 58 mm handle + 22 mm stop/emergency-off button
Weight	2.6 kg
Max. height of fall	1.5 m
Cable length	0.5 m/8 m
Availability	
Automation system	IndraMotion MLD, IndraMotion MLC, IndraMotion MTX, IndraLogic XLC (technical details on request)
• Standard ▼ In preparation ○ Optional – Not available	

Ordering data for hardware

Description	Type code
IndraControl VEH 30, stop button, 8 m connection cable	VEH30.2BNN-512ET-A2D-4G0-BS-E4-FW
IndraControl VEH 30, stop button, 0.5 m connection cable	VEH30.2BNN-512ET-A2D-4G0-BS-E2-FW
IndraControl VEH 30, stop button, handwheel, override, 0.5 m conn. cable	VEH30.2BNN-512ET-A2D-4G0-DS-E2-FW
IndraControl VEH 30, stop button, handwheel, override, 8 m conn. cable	VEH30.2BNN-512ET-A2D-4G0-DS-E4-FW

Ordering data for accessories

Description	Type code
Connection module for VEH 30.2 with stop button	VAC30.2N-NN
Connection module for VEH 30.2 with emergency-off button	VAC31.1C-NN
Wall-mounted holder	VAS01.1-001-NNN-NN
Extension cable for VEH 30.2 with stop button	RKS0011/16.0
Extension cable for VEH 30.2 with emergency-off button	RKS0012/016.0

Ordering data for firmware

Description	Type code
Firmware for IndraControl VEH30.2 with Windows XP	FWA-VEH*02-XPE-01VRS-D0-A



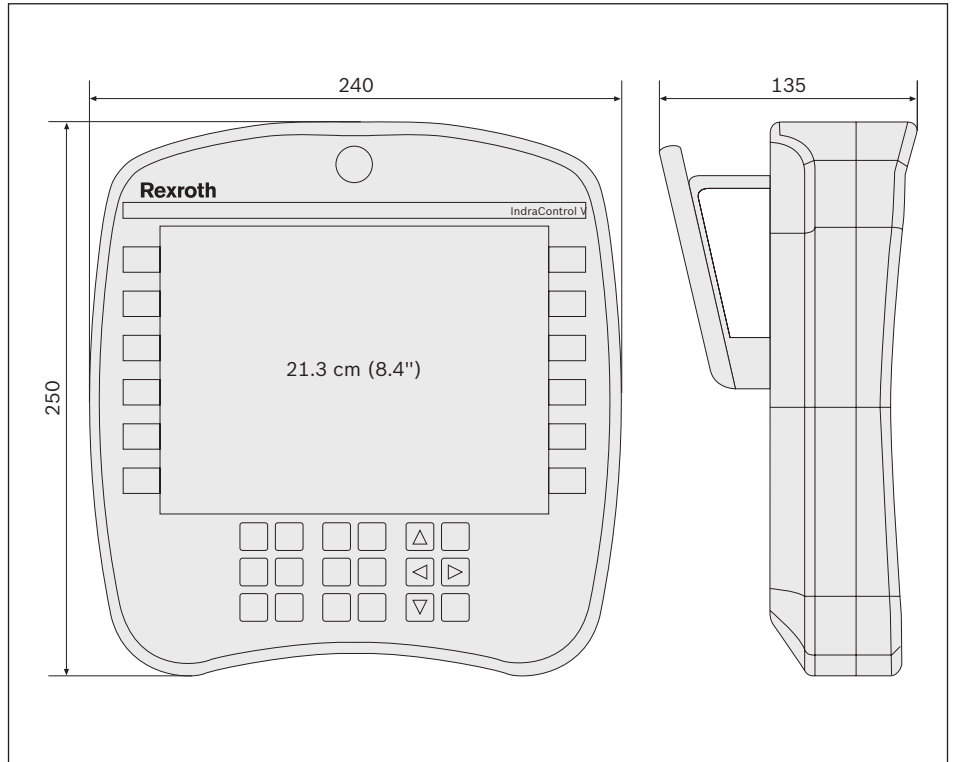

Ordering data for documentation

Description	Type code
IndraControl VEH30.2 project planning manual in German	DOK-SUPPL*-VEH*30.2***-PR02-DE-P
IndraControl VEH30.2 project planning manual in English	DOK-SUPPL*-VEH*30.2***-PR02-EN-P

IndraControl VEH



IndraControl VPP – technical data

Technical data	VPP 16.3	VPP 16.3	VPP 40.3	VPP 40.3	VPP 60.3
					
Display	30.5 cm (12") – TFT		38.1 cm (15") – TFT		48.3 cm (19") – TFT
Resolution	800 x 600, SVGA		1,024 x 768, XGA		1,280 x 1,024, SXGA
Colors	256,000		16 mil.		
Touch screen	–	●	–	●	●
Machine/function/additional keys	16/16/14	–	16/16/14	–	–
Alphanumeric keyboard	Additional component VAK				
Processor	Celeron P4500 1.86 GHz/Core i5 i5-520M 2.4 GHz/Core i7-620M 2.66 GHz				
RAM	2 GB/4 GB				
Operating system	Windows XP/Windows 7				
PCI/PCIe slots	1/0 2/0 1/1 4/0 2/2				
Approvals	CE/UL/CSA				
160 GB hard disk	●				
2 x 160 GB hard disk (RAID 1)	○				
100 GB solid state disk SSD	○				
DVD-ROM/DVD-RW	○				
Gbit Ethernet	2				
USB 2.0 on PC	6				
USB on front	1				
External service monitor	VGA				
Supply voltage	24 V DC				
UPS	External				
Status LED	Voltage, HDD, UPS, temperature				
Monitoring software	Voltage, temperature, fan				
Protection category	Front IP65				
Vibrations/shock carrying capacity	1 g/15 g				
Ambient temperature during operation	5 – 45°				
1 slot (W x H x D)	350 x 290 x 115 mm		407 x 370 x 109 mm		–
2 slots (W x H x D)	–		407 x 370 x 135 mm		–
4 slots (W x H x D)	350 x 290 x 123 mm		407 x 370 x 117 mm		483 x 400 x 137 mm
Availability					
Automation system	IndraMotion MLC, IndraMotion MLD, IndraMotion MTX, IndraLogic XLC, IndraLogic (technical details on request)				

● Standard ▼ In preparation ○ Optional – Not available

IndraControl VPP – ordering data

Ordering data for hardware	
Description	Type code
IndraControl VPP 40, 38.1 cm (15") display, touch screen, 1 x PCI slot, 160 GB HDD, Celeron P4500, 2 GB RAM	VPP40.3DEK-2G0NN-C3D-DN-NN-FW
IndraControl VPP 40, 38.1 cm (15") display, foil keys, 1 x PCI slot, 160 GB HDD, Celeron P4500, 2 GB RAM	VPP40.3BIK-2G0NN-C3D-DN-NN-FW
IndraControl VPP 40, 38.1 cm (15") display, foil keys, 4 x PCI slots, 160 GB HDD, Core i5-520M, 2 GB RAM	VPP40.3BIM-2G0NN-D4D-DN-NN-FW
IndraControl VPP 40, 38.1 cm (15") display, touch screen, 4 x PCI slots, 160 GB HDD, Core i5-520M, 2 GB RAM	VPP40.3DEM-2G0NN-D4D-DN-NN-FW
IndraControl VPP 40, 38.1 cm (15") display, foil keys, 4 x PCI slots, 100 GB SSD, Core i5-520M, 2 GB RAM	VPP40.3BIM-2G0NN-D4D-HN-NN-FW
IndraControl VPP 40, 38.1 cm (15") display, touch screen, 4 x PCI slots, 100 GB SSD, Core i5-520M, 2 GB RAM	VPP40.3DEM-2G0NN-D4D-HN-NN-FW
IndraControl VPP 40, 38.1 cm (15") display, foil keys and touch screen, 4 x PCI slots, 160 GB HDD, Core i5-520M, 2 GB RAM	VPP40.3DFM-2G0NN-D4D-DN-NN-FW
IndraControl VPP 40, 38.1 cm (15") display, foil keys, 4 x PCI slot, 160 GB HDD, Core i7-620M, 4 GB RAM	VPP40.3BIM-4G0NN-D5D-DN-NN-FW
IndraControl VPP 40, 38.1 cm (15") display, touch screen, 4 x PCI slots, 160 GB HDD, Core i7-620M, 4 GB RAM	VPP40.3DEM-4G0NN-D5D-DN-NN-FW
IndraControl VPP 40, 38.1 cm (15") display, foil keys, 1 x PCI slot, 100 GB SSD, Core i7-620M, 4 GB RAM	VPP40.3BIK-4G0NN-D5D-HN-NN-FW
Ordering data for accessories	
Description	Type code
Uninterrupted power supply UPS, 24 V DC, 240 watts	VAU01.1U-024-024-240-NN
24 V DC power supply unit, 100–120/200–240 V AC Auto Select	VAP01.1H-W32-024-010-NN
Ordering data for firmware	
Description	Type code
Firmware Windows XP Pro with multi-lingual interface (EN, DE, FR, IT, ES, PT, SV)	FWA-VS3VP3-WXP-xxVRS-A0-OEM
Firmware Windows XP Pro with multi-lingual interface (EN, DE, FR, IT, ES, PT, SV) and Acronis data backup software	FWA-VS3VP3-WXP-xxVRS-A0-OEM A1
Firmware Windows 7 with language support for EN, DE, FR, IT, ES, PT, SV	FWA-VP3***-W7*-xxVRS-A0-OEM
Firmware Windows 7 with language support for EN, DE, FR, IT, ES, PT, SV and Acronis data backup software	FWA-VP3***-W7*-xxVRS-A0-OEM A1
Ordering data for documentation	
Description	Type code
IndraControl VPP project planning manual	DOK-SUPPL*-VPP*16/40**PRxx-DE-P

xx = software/firmware version, device version

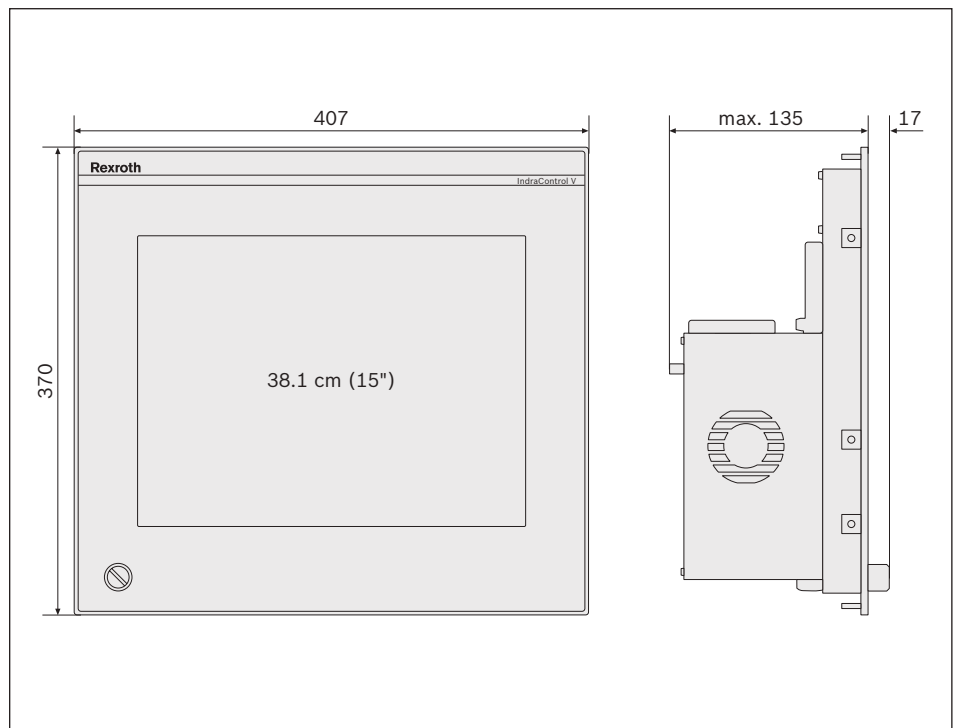
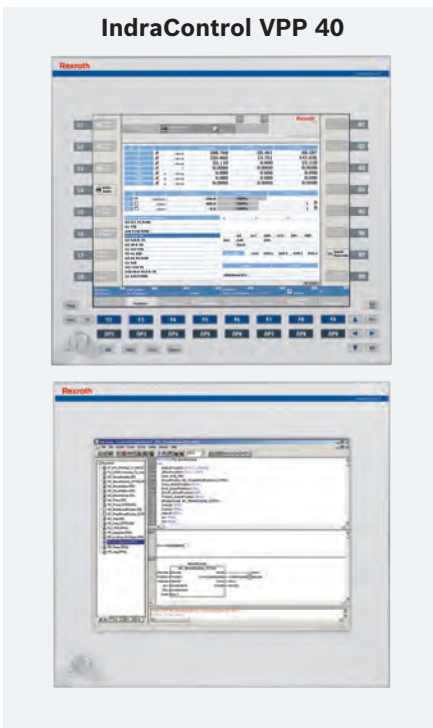
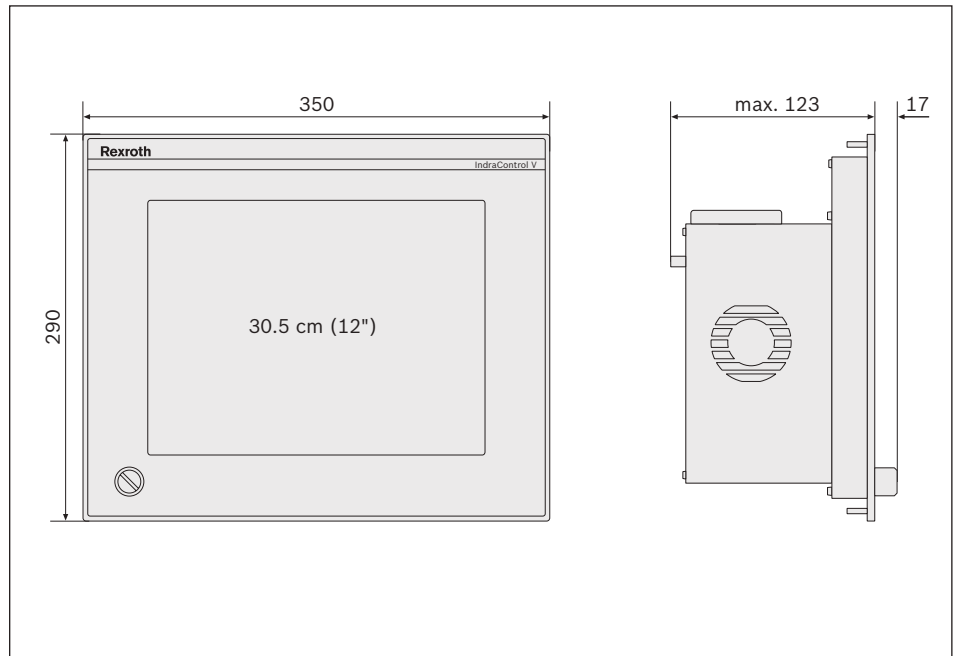
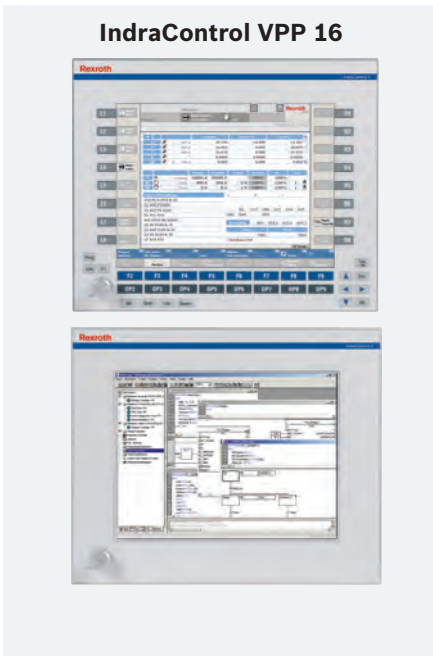

IndraControl VPP 16 and VPP 40

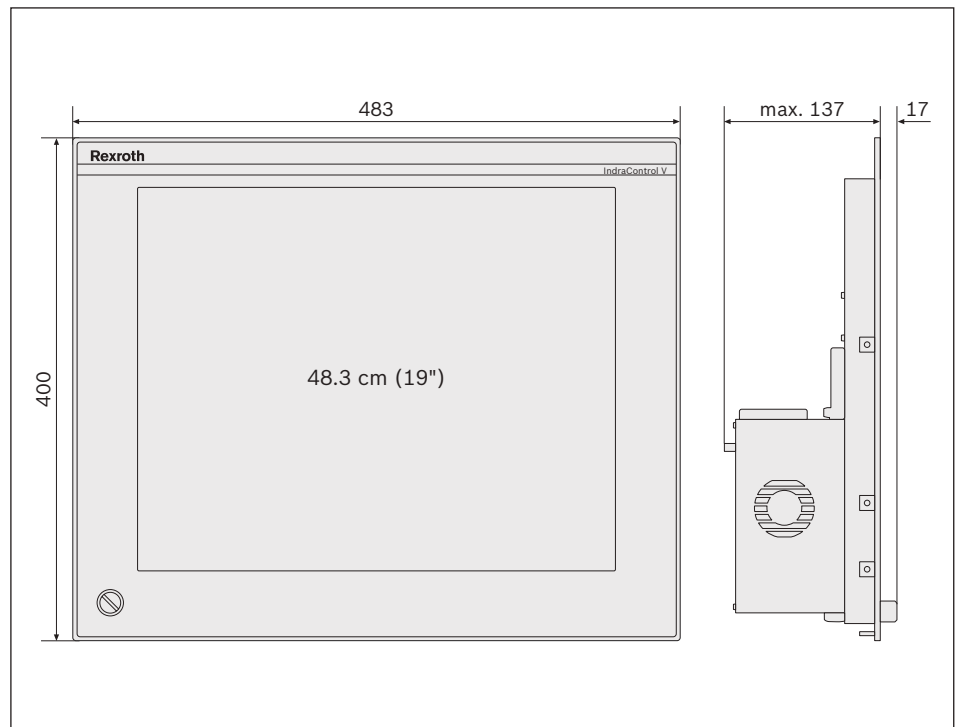
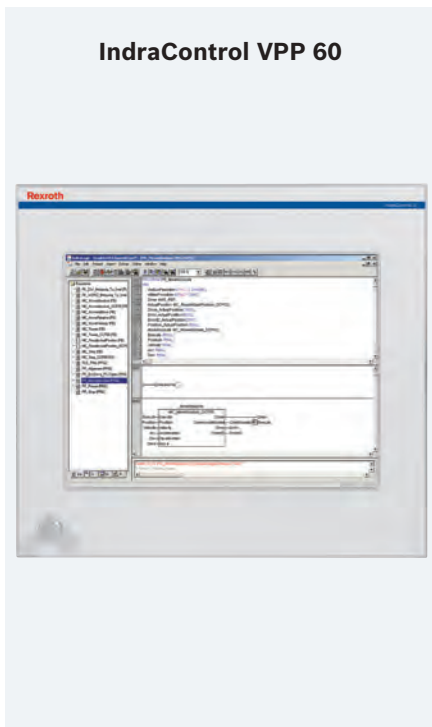

IndraControl VPP 60



IndraControl VPB – technical data

Technical data	VPB 40.3	VPB 40.3	VPB 40.3
			
Processor	Celeron P4500 1.86 GHz/Core i5 i5-520M 2.4 GHz/Core i7-620M 2.66 GHz		
RAM	2 GB/4 GB		
PCI/PCIe slots	1/0	2/0 or 1/1	4/0 or 2/2
Operating system	Windows XP/Windows 7		
Approvals	CE/UL/CSA		
160 GB hard disk	●		
2 x 160 GB hard disk (RAID 1)	○		
100 GB solid state disk SSD	○		
DVD-ROM/DVD-RW	○		
Gbit Ethernet	2		
USB 2.0	6		
External service monitor	DVI		
Connection to VDP	CDI		
Supply voltage	24 V DC		
UPS	External		
Status LED	Voltage, HDD, UPS, temperature		
Monitoring software	Voltage, temperature, fan		
Protection category	IP20		
Vibrations/shock carrying capacity	1 g/15 g		
Ambient temperature during operation	5 – 45°C		
Dimensions (W x H x D)	84 x 205 x 181 mm	110 x 205 x 181 mm	92 x 321 x 181 mm
Availability			
Automation system	IndraMotion MLC, IndraMotion MLD, IndraMotion MTX, IndraLogic XLC, IndraLogic (technical details on request)		

● Standard ▼ In preparation ○ Optional – Not available

IndraControl VPB – ordering data

Ordering data for hardware	
Description	Type code
IndraControl VPB 40, 2x PCI slots, 160 GB HDD, Celeron P4500, 2 GB RAM	VPB40.3D1L-2G0NN-C3D-DN-NN-FW
IndraControl VPB 40, 4x PCI slots, 160 GB HDD, DVD burner, Celeron P4500, 2 GB RAM	VPB40.3D1M-2G0NN-C3D-DE-NN-FW
IndraControl VPB 40, 1x PCI, 1x PCIe slot, 160 GB HDD, Celeron P4500, 2 GB RAM	VPB40.3D1N-2G0NN-C3D-DN-NN-FW
IndraControl VPB 40, 2x PCI slots, 160 GB HDD, Core i5-520M, 2 GB RAM	VPB40.3D1L-2G0NN-D4D-DN-NN-FW
IndraControl VPB 40, 2x PCI slots, 100 GB SSD, Core i5-520M, 2 GB RAM	VPB40.3D1L-2G0NN-D4D-HN-NN-FW
IndraControl VPB 40, 4x PCI slots, 160 GB HDD, DVD burner, Core i5-520M, 2 GB RAM	VPB40.3D1M-2G0NN-D4D-DE-NN-FW
IndraControl VPB 40, 4x PCI slots, 2x 160 GB HDD, DVD burner, Core i5-520M, 2 GB RAM	VPB40.3D1M-2G0NN-D4D-EE-NN-FW
IndraControl VPB 40, 1x PCI, 1x PCIe slot, 160 GB HDD, Core i5-520M, 2 GB RAM	VPB40.3D1N-2G0NN-D4D-DN-NN-FW
IndraControl VPB 40, 2x PCI slots, 160 GB HDD, Core i7-620M, 4 GB RAM	VPB40.3D1L-4G0NN-D5D-DN-NN-FW
IndraControl VPB 40, 2x PCI slots, 100 GB SSD, Core i7-620M, 4 GB RAM	VPB40.3D1L-4G0NN-D5D-HN-NN-FW
IndraControl VPB 40, 4x PCI slots, 160 GB HDD, DVD burner, Core i7-620M, 4 GB RAM	VPB40.3D1M-4G0NN-D5D-DE-NN-FW
IndraControl VPB 40, 4x PCI slots, 2x 160 GB HDD, DVD burner, Core i7-620M, 4 GB RAM	VPB40.3D1M-4G0NN-D5D-EE-NN-FW
IndraControl VPB 40, 2x PCI, 2x PCIe slots, 160 GB HDD, Core i7-620M, 4 GB RAM	VPB40.3D1Q-4G0NN-D5D-DN-NN-FW
IndraControl VPB 40, 4x PCI slots, 100 GB SSD, Core i7-620M, 4 GB RAM	VPB40.3D1M-4G0NN-D5D-HN-NN-FW
IndraControl VPB 40, 2x PCI slots, 2x 160 GB HDD, DVD burner, Core i7-620M, 4 GB RAM	VPB40.3D1L-4G0NN-D5D-EE-NN-FW
IndraControl VPB 40, 2x PCI slots, 2x 160 GB HDD, Core i7-620M, 4 GB RAM	VPB40.3D1L-4G0NN-D5D-EN-NN-FW
Ordering data for firmware	
Description	Type code
Firmware Windows XP Pro with multi-lingual interface (EN, DE, FR, IT, ES, PT, SV)	FWA-VS3VP3-WXP-xxVRS-A0-OEM
Firmware Windows XP Pro with multi-lingual interface (EN, DE, FR, IT, ES, PT, SV) and Acronis data backup software	FWA-VS3VP3-WXP-xxVRS-A0-OEM A1
Firmware Windows 7 with language support for EN, DE, FR, IT, ES, PT, SV	FWA-VP3***-W7*-xxVRS-A0-OEM
Firmware Windows 7 with language support for EN, DE, FR, IT, ES, PT, SV and Acronis data backup software	FWA-VP3***-W7*-xxVRS-A0-OEM A1

xx = software/firmware version, device version

IndraControl VPB

IndraControl VPB 40.3
(1 slot)

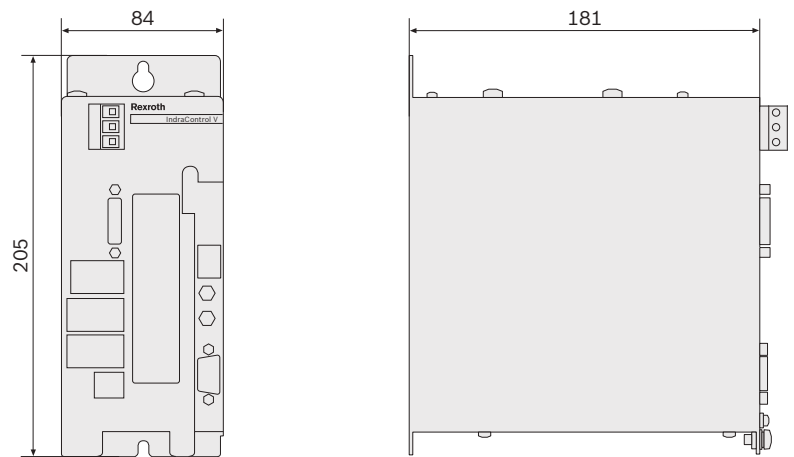
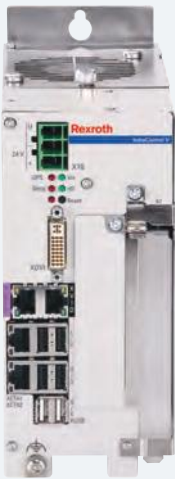

IndraControl VPB 40.3
(2 slots)

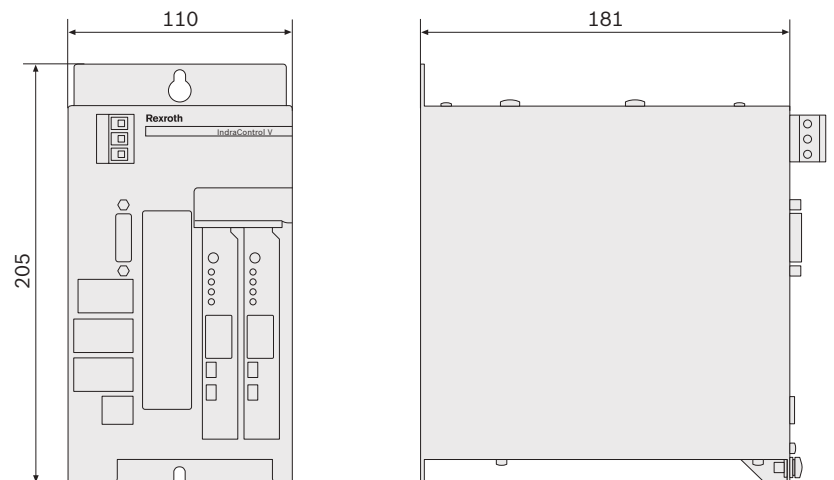



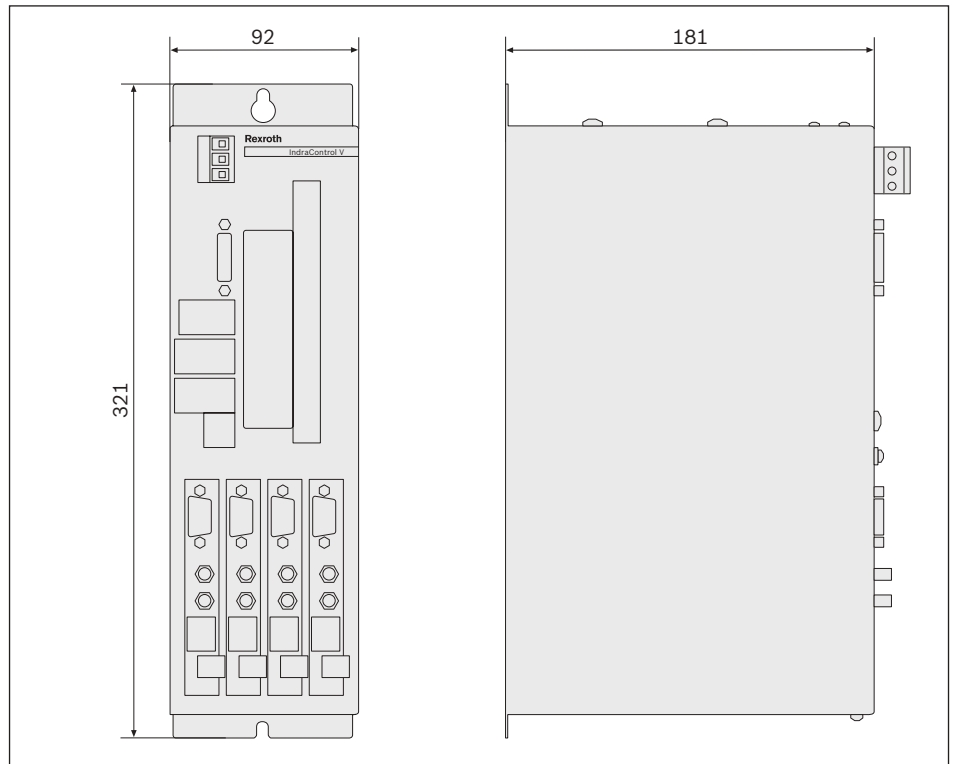

IndraControl VPB

IndraControl VPB 40.3
(4 slots)



IndraControl VDP operator display – technical data

Technical data	VDP 16.3	VDP 16.3	VDP 40.3	VDP 40.3	VDP 60.3
					
Display	30.5 cm (12") – TFT		38.1 cm (15") – TFT		48.3 cm (19") – TFT
Resolution	800 x 600, SVGA		1,024 x 768, XGA		1,280 x 1,024, SXGA
Colors	256,000				16 mil.
Touch screen	–	●	●	●	●
Machine/function/additional keys	16/16/14	–	16/16/14	–	–
Alphanumeric keyboard	Additional component VAK				
Approvals	CE/UL/CSA				
USB	4				
USB on front	1				
Supply voltage	24 V DC				
UPS	External				
Status LED	Voltage, HDD, UPS, temperature				
Protection category	Front IP65				
Vibrations/shock carrying capacity	1 g/15 g				
Ambient temperature during operation	5 – 45°C				
Dimensions (W x H x D)	350 x 290 x 46 mm		407 x 370 x 46 mm		483 x 400 x 62 mm
Availability					
Automation system	IndraMotion MLC, IndraMotion MLD, IndraMotion MTX, IndraLogic XLC, IndraLogic (technical details on request)				



● Standard ▼ In preparation ○ Optional – Not available

IndraControl VDP operator display – ordering data

Ordering data for hardware	
Description	Type code
IndraControl VDP 16 with 30.5 cm (12") display, touch screen	VDP16.3DBN-D1-NN-NN
IndraControl VDP 16 with 30.5 cm (12") display, foil keys	VDP16.3BKN-D1-NN-MX
IndraControl VDP 40 with 38.1 cm (15") display, touch screen	VDP40.3DEN-D1-NN-NN
IndraControl VDP 40 with 38.1 cm (15") display, foil keys	VDP40.3BIN-D1-NN-MX
IndraControl VDP 40 with 38.1 cm (15") display, touch screen, foil keys	VDP40.3DFN-D1-NN-MX
IndraControl VDP 60 with 48.3 cm (19") display, touch screen	VDP60.3FEN-D1-NN-NN
Ordering data for documentation	
Description	Type code
IndraControl VDP project planning manual	DOK-SUPPL*-VDP*xx.3*PRxx-DE-P

xx = software/firmware version, device version

IndraControl VDP operator terminals – technical data

Technical data	VDP 40.3	VDP 40.3
		
Display	38.1 cm (15") – TFT	
Resolution	1,024 x 768 pixels, XGA	
Colors	256,000	
Touch screen	●	●
Machine/function/additional keys	16/16/14	–
Additional keys	–	3 function buttons and 1 emergency-stop pushbutton
Approvals	CE/CSA	
Connection to IPC	CDI	
USB	4	
USB on front	1	
Supply voltage	24 V DC	
Status LED	Voltage, HDD, UPS, temperature	
Protection category	Front IP65, overall IP54	
Vibrations/shock carrying capacity	1 g/15 g	
Ambient temperature during operation	5 – 45°C	
Mounting	VESA bracket	
Dimensions (W x H x D)	407 x 370 x 60 mm	
Availability	IndraMotion MLC, IndraMotion MLD, IndraMotion MTX, IndraLogic XLC, IndraLogic (technical details on request)	
Automation system	IndraMotion MLC, IndraMotion MLD, IndraMotion MTX, IndraLogic XLC, IndraLogic (technical details on request)	

● Standard ▼ In preparation ○ Optional – Not available

IndraControl VDP operator terminals – ordering data

Ordering data for hardware

Description	Type code
IndraControl VDP 40 operator terminal with 38.1 cm (15") display, foil keys and touch screen, in a housing	VDP40.3DFN-D1-NN-CG
IndraControl VDP 40 operator terminal with 15" display, touch screen, in a housing with switching elements	VDP40.3DIN-D1-NN-CG

Ordering data for documentation

Description	Type code
IndraControl VDP operator terminal project planning manual	DOK-SUPPL*-VDP16/40/60-PRxx-DE-P

xx = software/firmware version, device version

IndraControl VDP 16 and VDP 40 operator display

IndraControl VDP 16

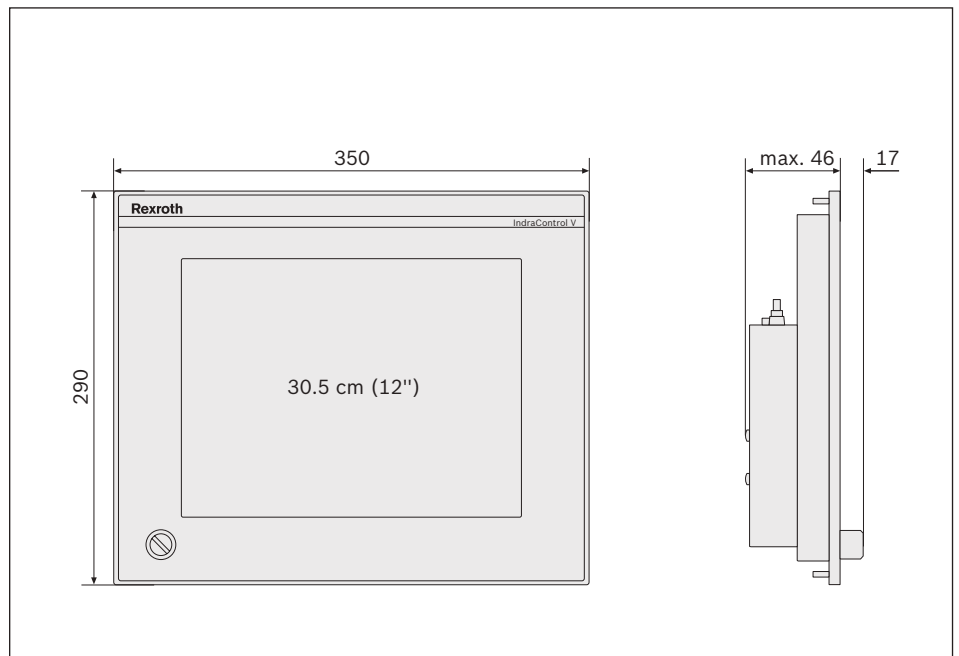

IndraControl VDP 40

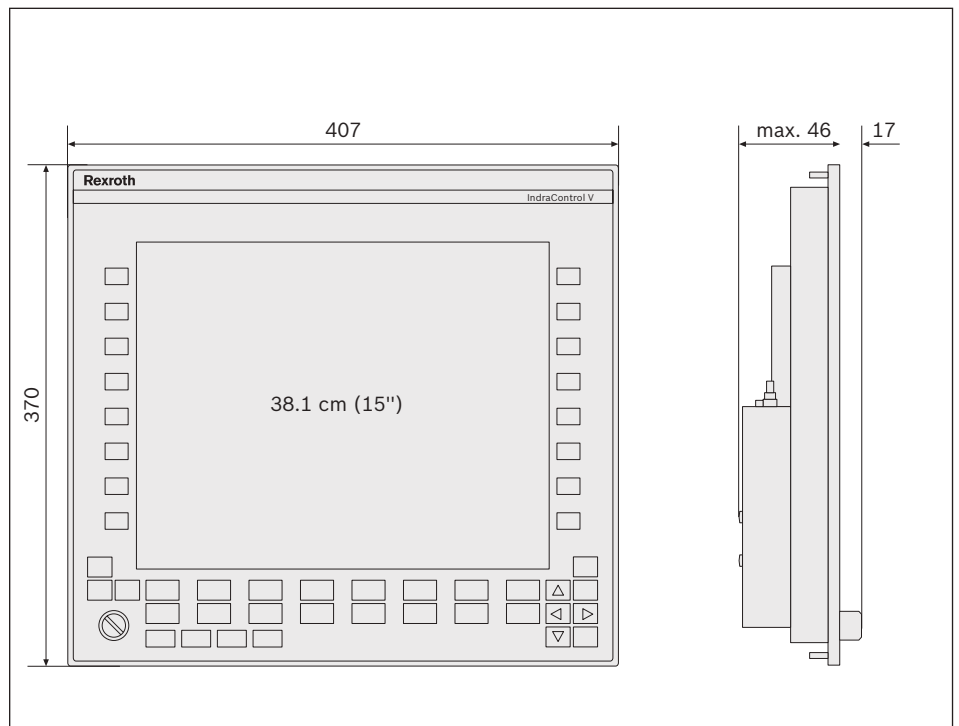
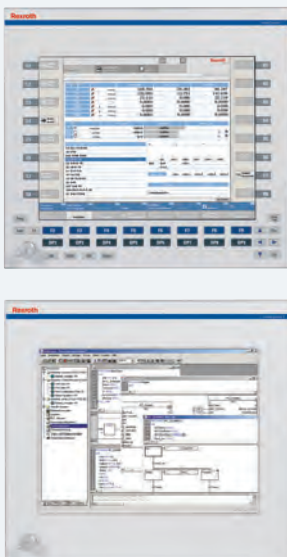

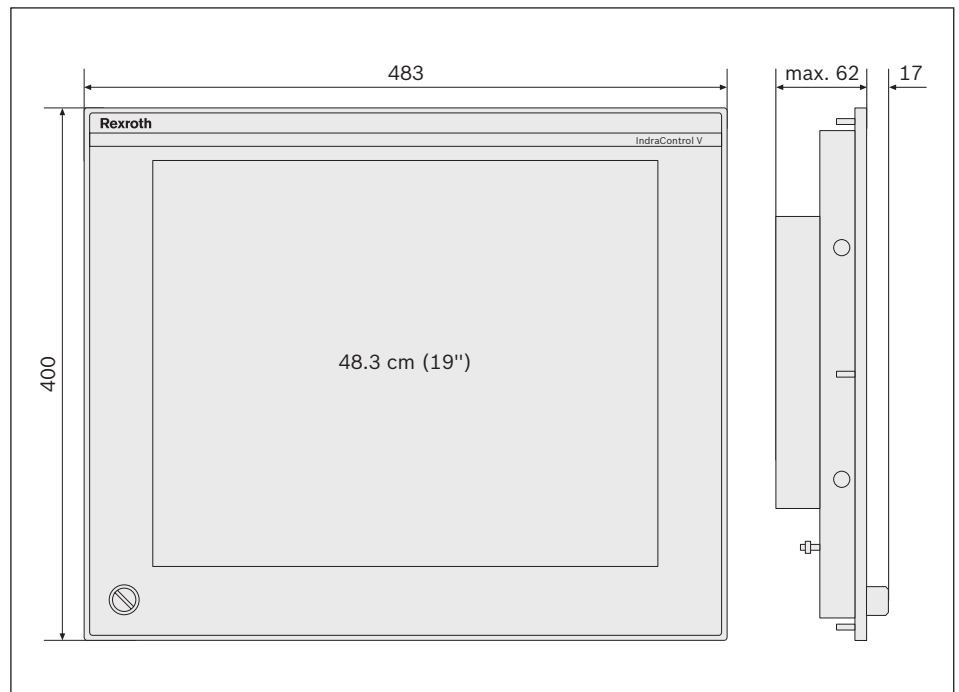
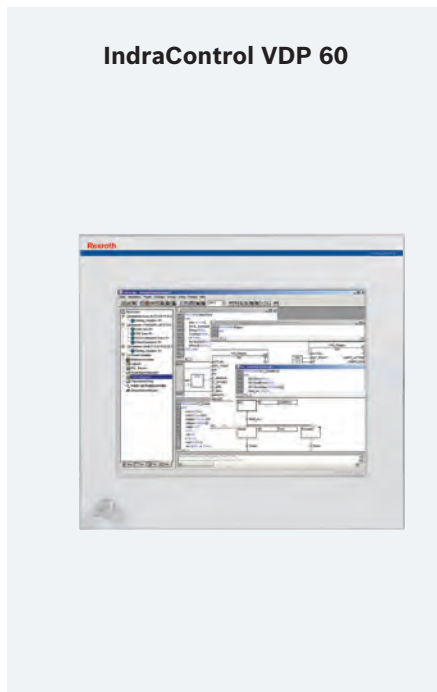

IndraControl VDP 60 operator display

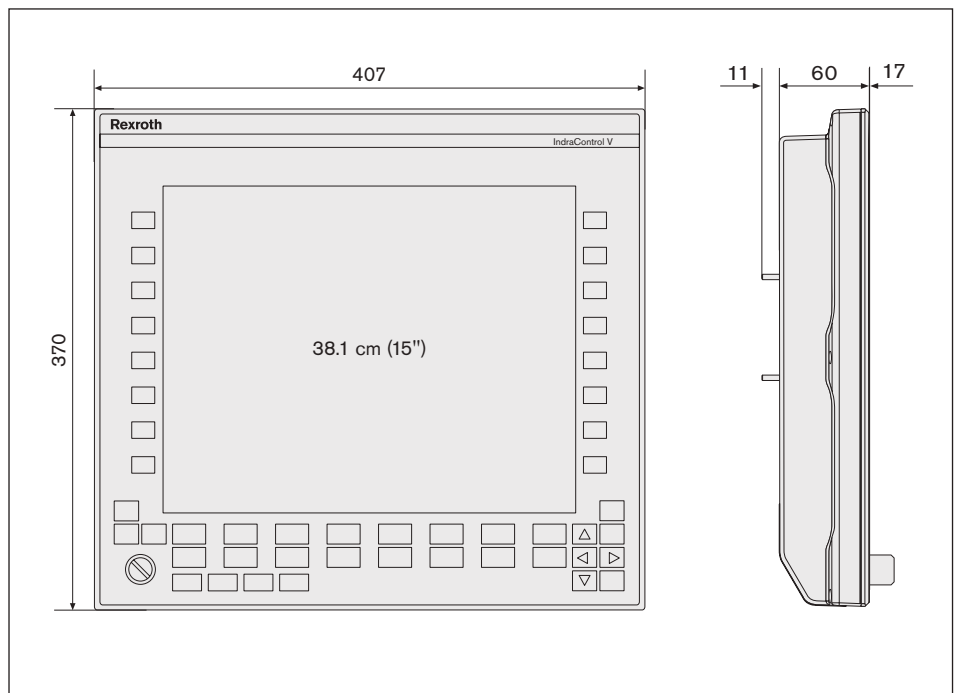
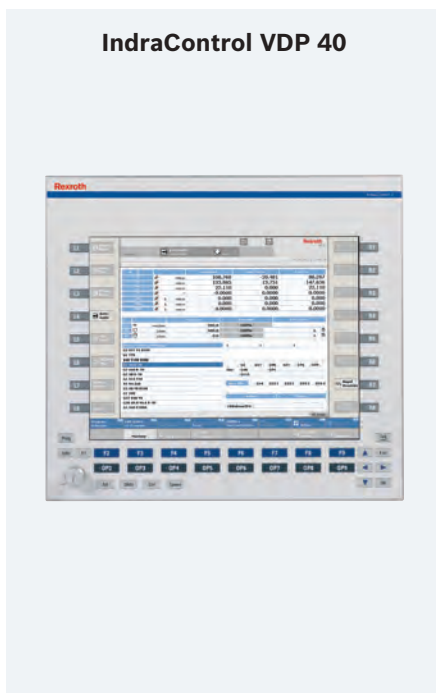
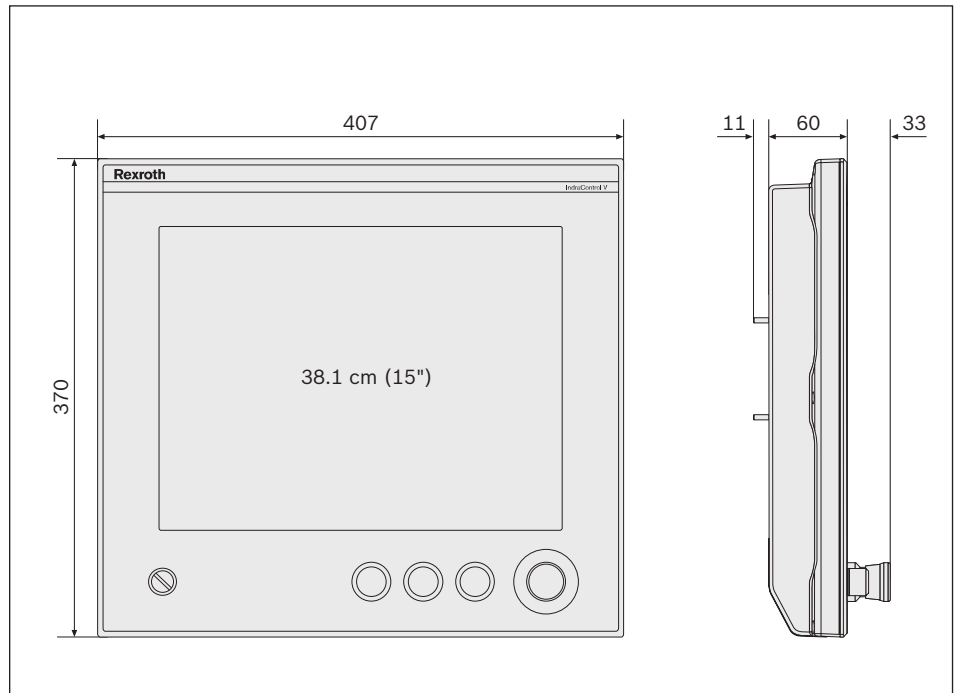

IndraControl VDP 40 operator terminal



IndraControl VAK – technical data/ordering data

Technical data	VAK 10/40	VAK 11/41
		
Type	Slide-out keyboard (full keyboard)	Touch panel (full keyboard)
Keyboard	Short-stroke keys	
Function and additional keys	86 keys, alphanumeric block, integrated mouse pointer	106 keys, alphanumeric block, 4 variable keys, keyboard mouse
Power consumption	0.01 A	
Supply voltage	5 V DC (via PS/2, USB)	
Interface	PS/2, USB	
Approvals	CE/UL/CSA	
Protection category on front	IP65	
Temperature	5 – 45°C	
Dimensions (W x H x D)	350/407 x 88 x 200 mm	350/407 x 140 x 40 mm
Panel cutout (W x H)	324 x 58/376 x 58 mm	318 x 108/375 x 108 mm
Connecting cable	1 m	
Weight in kg	Typ. 2.5/2.6 kg	Typ. 1.3/1.4 kg
Color	Light gray RAL 7035	

Availability

Automation system IndraMotion MLC, IndraMotion MTX, IndraLogic (technical details on request)

● Standard ▼ In preparation ○ Optional – Not available

Ordering data for hardware

Description	Type code
IndraControl VAK 10, slide-out keyboard, DE	VAK10.1E-DE-P-MPNN
IndraControl VAK 10, slide-out keyboard, EN	VAK10.1E-EN-P-MPNN
IndraControl VAK 40, slide-out keyboard, DE	VAK40.1E-DE-P-MPNN
IndraControl VAK 40, slide-out keyboard, EN	VAK40.1E-EN-P-MPNN
IndraControl VAK 11, touch panel, DE	VAK11.2F-DE-P-NNNN
IndraControl VAK 41, touch panel, EN	VAK41.2F-EN-P-NNNN

Ordering data for documentation

Description	Type code
IndraControl VAK 10 and VAK 40 project planning manual	DOK-SUPPL*-VAK*40.1***-PRxx-DE-P

xx = software/firmware version, device version

IndraControl VAK 10, VAK 11, VAK 40 and VAK 41



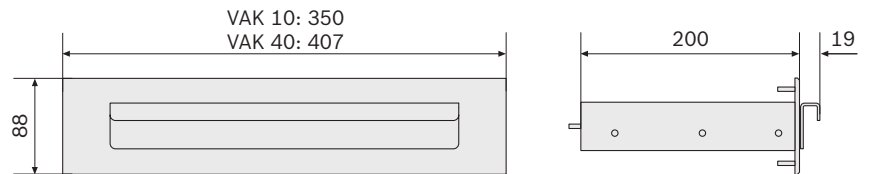

IndraControl VAK 10, VAK 40

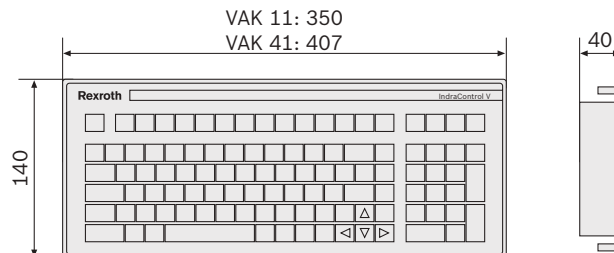

IndraControl VAK 11, VAK 41



IndraControl VAM – technical data

Technical data	VAM 04/05	VAM 10/40.2	VAM10/40.3	VAM 12/42
				
Type	Individual machine control panel with 7 or 8 cut-outs	Machine control panel for standard machine tools	Machine control panel for standard machine tools	Machine control panel for automated production
Illuminated pushbutton	–	–	–	4/6 long-stroke buttons
Foil pushbutton	–		2 x 15 short-stroke buttons	
Emergency-off button	–		2 NC contacts, 1 NO contact	
Override	–		Feed and spindle	
Key switch	–	4-level key-operated authorization	–	–
Fieldbus	–	PROFIBUS slave	sercos III	PROFIBUS slave
Logic supply U_L	–		24 V DC (19.2 to 30 V), PELV	
Power consumption from U_L	–		Max. 0.5 A	
Input/output supply U_O	–		24 V DC (19.2 to 30 V), PELV	
Power consumption	–		Max. 1.7 A	
Supply voltage	–		24 V DC	
Interface	–	Interface for external handwheel, 16/8 or 16/16 digital I/O, 24 V DC		
Approvals	CE/UL	CE/UL/CSA		CE/UL
Protection category on front		IP54		
Temperature	5–55°C	5 – 45°C		
Dimensions (W x H x D)	350/407x110x27 mm	350/407 x 169 x 102 mm	350/407 x 169 x 102 mm	350/407 x 240 x 102 mm
Panel cutout (W x H)	320x82/378x82 mm	318 x 137/375 x 137 mm	318 x 137/375 x 137 mm	318 x 208/375 x 208 mm
Weight in kg	Typ. 0.3/0.4 kg	Typ. 1.17/1.38 kg	Typ. 1.17/1.38 kg	Typ. 1.17/1.38 kg
Color		Light gray RAL 7035		

Availability

Automation system IndraMotion MLC, IndraMotion MTX, IndraLogic (technical details on request)

● Standard ▼ In preparation ○ Optional – Not available

IndraControl VAM – ordering data

Ordering data for hardware	
Description	Type code
IndraControl VAM 04, machine control panel	VAM04.1-NN
IndraControl VAM 05, machine control panel	VAM05.1-NN
IndraControl VAM 10, machine control panel	VAM10.2-PB-NA-TA-TA-VB-1608-NN
IndraControl VAM 10, machine control panel	VAM10.3-S3-NF-TA-TA-VD-1616-NN
IndraControl VAM 40, machine control panel	VAM40.3-S3-NF-TA-TA-VD-MA-1616-NN
IndraControl VAM 40, machine control panel	VAM40.2-PB-NA-TA-TA-VB-MA-1608-NN
IndraControl VAM 40, machine control panel with handwheel	VAM40.2-PB-NA-TA-TA-VB-HA-1608-NN
IndraControl VAM 12, machine control panel	VAM12.1-PB-NF-NN-TB-VD-NN-1608-NN
IndraControl VAM 42, machine control panel	VAM42.1-PB-NF-NN-TB-VD-NN-1608-NN
Ordering data for documentation	
Description	Type code
IndraControl VAM 10.2 and VAM 40.2 project planning manual	DOK-SUPPL*-VAM*xx.2***-PRxx-DE-P
IndraControl VAM 10.3 and VAM 40.3 project planning manual	DOK-SUPPL*-VAM*xx.3***-PRxx-DE-P
IndraControl VAM 12.1 and VAM 42.1 project planning manual	DOK-SUPPL*-VAM*xx.1***-PRxx-DE-P

xx = software/firmware version, device version

IndraControl VAM 04, VAM 05, and VAM 10

IndraControl VAM 04

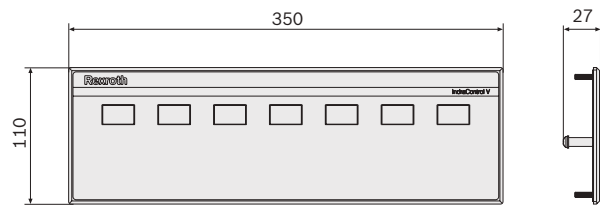

IndraControl VAM 05

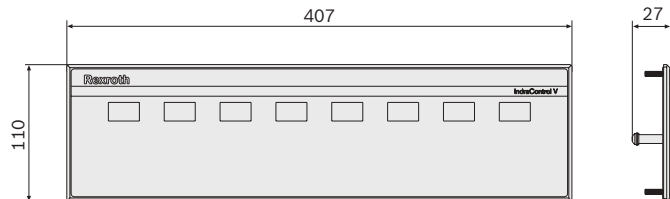

IndraControl VAM 10

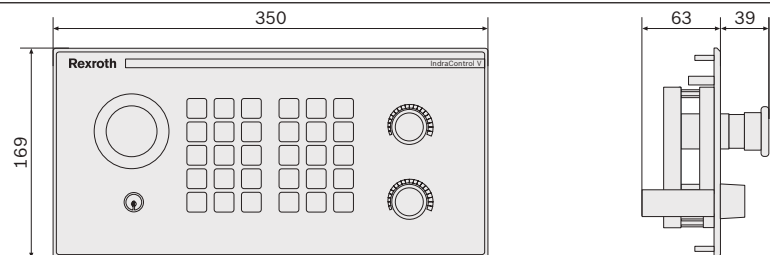

IndraControl VAM 12, VAM 40, and VAM 42

IndraControl VAM 40

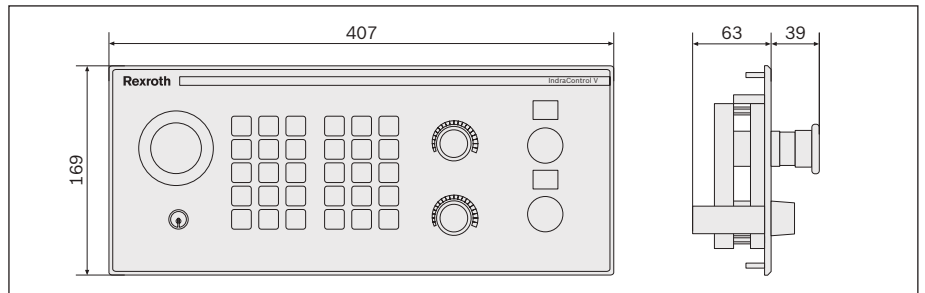

IndraControl VAM 12

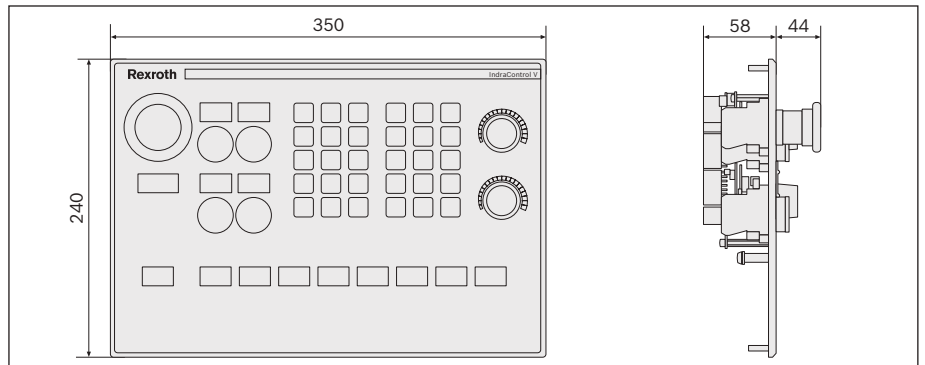

IndraControl VAM 42

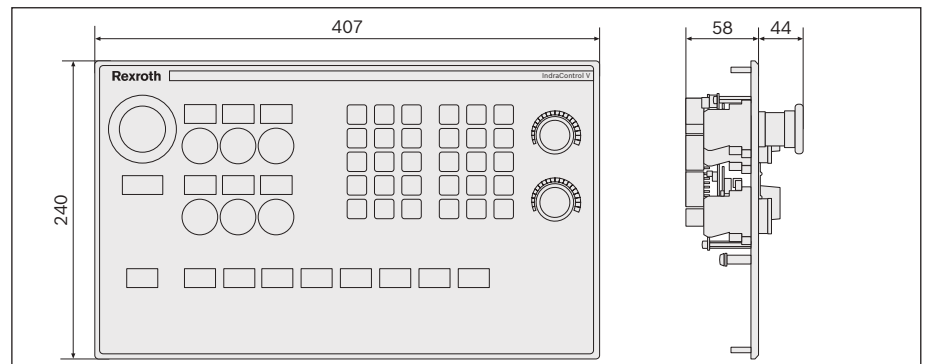



IndraControl L – controller-based automation systems and control components

IndraControl L allows easy and consistent automation for all centralized and distributed architectures. This technically and economically optimized control design offers a great number of benefits, both for the machine manufacturer and the end user.

IndraControl L is the flexibly configurable hardware platform for open control architectures. Whether you intend to implement a motion control, a CNC or a PLC application – it is always the same hardware you use. Your application is only defined by the software. To ensure that it matches your application in the best way possible, our control platform is available in various performance classes. Its open architecture, in combination with many different function modules, facilitates integration in heterogeneous system topologies.

Configurable fieldbus interfaces allow use as a master or as

a slave in distributed control architectures.

- ▶ Scalable hardware platform
- ▶ Standardized communication interfaces
- ▶ Optional extension through function and technology modules
- ▶ Ideal for centralized and distributed control topologies
- ▶ Individually extendable with high-grade visualization components
- ▶ Modular I/O units



IndraControl L – modular, controller-based control hardware allowing any desired, future-proof factory automation

Scalable, future-proof and flexible

- ▶ Individual control platform for any topology
- ▶ Standardized communication interfaces
- ▶ Scalable performance and function



IndraControl L – compact control platform



IndraControl L is the compact control platform for easy DIN-rail mounting, requiring less wiring effort. It is available in various performance classes with many extension options. In combination with our PLC system IndraLogic or our motion solutions IndraMotion, IndraControl L provides a maximum of flexibility and openness for the most varying system designs.

- ▶ Uniform hardware platform for all controller-based Rexroth controls
- ▶ Performance and function with flexible scalability
- ▶ Individual extension capability through visualization and I/O components
- ▶ Quick assembly and installation without any tools
- ▶ Open through standardized communication interfaces

IndraControl L – function modules



A range of function modules (fieldbus interfaces and technology modules) are available to integrate the IndraControl L into heterogeneous control topologies. The modules use the high-speed system bus to communicate with the control processor – this ensures that the high requirements for performance and functionality are met. Partial implementation of functions into the modules reduce the load on the controller CPU.

- ▶ Easy extension of the functions of the IndraControl L controls
- ▶ Many communication and technology interfaces
- ▶ Flexible combination options
- ▶ Ergonomic design

IndraControl L – control overview and short description

Performance



Connectivity



IndraControl L10

Entry-level compact controller for simple PLC applications.

- ▶ Communication: Ethernet TCP/IP
- ▶ On-board I/O: 8 high-speed inputs, 4 high-speed outputs
- ▶ I/O extension: up to 63 Inline I/O modules

Performance



Connectivity



IndraControl L20

Mid-range compact controller for standard PLC applications.

- ▶ Communication: Ethernet TCP/IP, PROFIBUS, RS232
- ▶ On-board I/O: 8 high-speed inputs, 8 high-speed outputs
- ▶ I/O extension: up to 63 Inline I/O modules

Performance



Connectivity



IndraControl L25

Mid-range compact controller for standard PLC and motion applications.

- ▶ Communication: Ethernet TCP/IP, sercos III
- ▶ Function modules: up to 2
- ▶ I/O extension: up to 63 Inline I/O modules

Performance



Connectivity



IndraControl L40

High-performance compact controller for demanding PLC, motion and CNC applications.

- ▶ Communication: Ethernet TCP/IP, PROFIBUS, RS232, sercos II
- ▶ Function modules: up to 4
- ▶ On-board I/O: 8 high-speed inputs, 8 high-speed outputs
- ▶ I/O extension: up to 63 Inline I/O modules

Performance



Connectivity



IndraControl L45

High-performance compact controller for demanding PLC motion applications and CNC applications.

- ▶ Communication: Ethernet TCP/IP, PROFIBUS, sercos III, PROFINET IO, EtherNet/IP
- ▶ Function modules: up to 4
- ▶ On-board I/O: 8 high-speed inputs, 8 high-speed outputs
- ▶ I/O extension: up to 63 Inline I/O modules

Performance



Connectivity



IndraControl L65

High-performance compact controller for high-end PLC motion applications and CNC applications.

- ▶ Communication: Ethernet TCP/IP, PROFIBUS, sercos III, PROFINET IO, EtherNet/IP
- ▶ Function modules: up to 4
- ▶ On-board I/O: 8 high-speed inputs, 8 high-speed outputs
- ▶ I/O extension: up to 63 Inline I/O modules

Performance



Connectivity



IndraControl L85

High-performance compact controller for high-end CNC applications.

- ▶ Communication: Ethernet TCP/IP, PROFIBUS, sercos III, PROFINET IO, EtherNet/IP
- ▶ Function modules: up to 4
- ▶ On-board I/O: 8 high-speed inputs, 8 high-speed outputs
- ▶ I/O extension: up to 63 Inline I/O modules

IndraControl L10 – technical data

Technical data	IndraControl L10	Legend
		
CPU	SH4 compatible	
RAM	32 MB	
Retentive memory	32 kB	
Removable storage medium	CF card/128 MB	①
Diagnosis	Temperature monitoring, watchdog, power-fail	
Real-time clock	–	
Display	–	
Protection category	IP20	
Dimensions (H x W x D)	121 x 123 x 71 mm	
Interfaces		
I/O modules	Inline	
Communication interfaces	1 x Ethernet TCP/IP (RJ45, 10/100 Base-T)	④
Inputs/outputs (digital)	8 DC-decoupled inputs (with interrupt capability)	②
	4 DC-decoupled outputs	②
I/O extension ¹⁾	Up to 63 Inline I/O modules with up to 128 I/O (16 bytes)	③
Function modules	–	
Power supply		
Nominal value	24 V DC	
Tolerance	-15/+20% (without residual ripple)	
Residual ripple	±5%	
U_{max}	30 V DC	
U_{min}	19.2 V DC	
Power consumption from U_{LS}	Max. 1.25 A	
Power consumption from $U_M + U_S$	Max. 8 A	
Environmental conditions		
Ambient temperature (operation)	+5 to +55°C	
Ambient temperature (transport/storage)	-25 to +70°C	
Relative humidity	RH-2; 5 to 95% acc. to DIN EN 61131-2, no dewing	
Atmospheric pressure (operation)	Up to 2,700 m above sea level acc. to DIN 60204	
Atmospheric pressure (transport/storage)	Up to 3,000 m above sea level acc. to DIN 60204	
Mechanical strength		
Vibration/shock resistance	Tested according to EN 60068-2-6/EN 60068-2-27	
EMC immunity	Tested according to EN 61000-6-2/EN 61000-6-4/EN 61131-2	
Availability		
Automation system	IndraLogic	

¹⁾ The total current of the logic supply U_L of the Inline modules must not exceed 0.8 A. If this value is exceeded, an additional infeed module is required.

IndraControl L20 – technical data

Technical data	IndraControl L20	Legend
		
CPU	SH4 compatible	
RAM	16 MB	
Retentive memory	64 kB	
Removable storage medium	CF card/128 MB	①
Diagnosis	Temperature monitoring, watchdog, power-fail	
Real-time clock	Integrated	
Display	1 line, 4 operator keys	⑦
Protection category	IP20	
Dimensions (H x W x D)	120 x 175 x 76 mm	
Interfaces		
I/O modules	Inline	
Communication interfaces	1 x Ethernet TCP/IP (RJ45, 10/100 Base-T)	④
	1 x RS232	⑤
	1 x PROFIBUS master/slave	⑥
Inputs/outputs (digital)	8 DC-decoupled inputs (with interrupt capability)	②
	8 DC-decoupled outputs	②
I/O extension	Up to 63 Inline I/O modules with up to 256 I/O (32 bytes)	③
Function modules	–	
Power supply		
Nominal value	24 V DC	
Tolerance	-15/+20% (without residual ripple)	
Residual ripple	±5%	
U_{max}	30 V DC	
U_{min}	19.2 V DC	
Power consumption from U_{Ls}	Max. 3 A	
Power consumption from $U_M + U_s$	Max. 8 A	
Environmental conditions		
Ambient temperature (operation)	+5 to +55°C	
Ambient temperature (transport/storage)	-25 to +70°C	
Relative humidity	RH-2; 5 to 95% acc. to DIN EN 61131-2, no dewing	
Atmospheric pressure (operation)	Up to 2,700 m above sea level acc. to DIN 60204	
Atmospheric pressure (transport/storage)	Up to 3,000 m above sea level acc. to DIN 60204	
Mechanical strength		
Vibration/shock resistance	Tested according to EN 60068-2-6/EN 60068-2-27	
EMC immunity	Tested according to EN 61000-6-2/EN 61000-6-4/EN 61131-2	
Availability		
Automation system	IndraLogic	

IndraControl L25 – technical data

Technical data	IndraControl L25	Legend
		
CPU	SH4 compatible	
RAM	128 MB	
Retentive memory	256 kB	
Removable storage medium	CF card/1 GB	①
Diagnosis	Temperature monitoring, watchdog, power-fail	
Real-time clock	Integrated	
Display	1 line, 4 operator keys	⑨
Protection category	IP20	
Dimensions (H x W x D)	120 x 175 x 76 mm	
Interfaces		
Communication interfaces (standard)	1 x Ethernet TCP/IP (RJ45, 10/100 Base-T) 1 x single-pole ready contact	④ ⑤
Communication interfaces (optional)	1 x sercos III (2 x RJ45), 1 x PROFINET IO controller/device (2 x RJ45), 1 x EtherNet/IP scanner/adaptor (2 x RJ45), 1 x PROFIBUS master/slave	⑥
I/O extension	Up to 63 Inline I/O modules with up to 512 I/O (64 bytes)	③
Function modules	Up to 2	
Power supply		
Nominal value	24 V DC	
Tolerance	-15/+20% (without residual ripple)	
Residual ripple	±5%	
U_{max}	30 V DC	
U_{min}	19.2 V DC	
Power consumption from U_{LS}	Max. 3 A	
Power consumption from $U_M + U_S$	Max. 8 A	
Environmental conditions		
Ambient temperature (operation)	+5 to +55°C	
Ambient temperature (transport/storage)	-25 to +70°C	
Relative humidity	RH-2; 5 to 95% acc. to DIN EN 61131-2, no dewing	
Atmospheric pressure (operation)	Up to 2,700 m above sea level acc. to DIN 60204	
Atmospheric pressure (transport/storage)	Up to 3,000 m above sea level acc. to DIN 60204	
Mechanical strength		
Vibration/shock resistance	Tested according to EN 60068-2-6/EN 60068-2-27	
EMC immunity	Tested according to EN 61000-6-2/EN 61000-6-4/EN 61131-2	
Availability		
Automation system	IndraMotion MLC, IndraLogic XLC	

IndraControl L40 – technical data

Technical data	IndraControl L40	Legend
		
CPU	x86 compatible, 500 MHz	
RAM	64 MB	
Retentive memory	128 kB	
Removable storage medium	CF card/128 MB	1
Real-time clock	Integrated	
Display	1 line, 4 operator keys	9
Protection category	IP20	
Dimensions (H x W x D)	120 x 175 x 76 mm	
Interfaces		
I/O modules	Inline	
Communication interfaces (standard)	1 x Ethernet TCP/IP (RJ45, 10/100 Base-T)	4
	1 x serial RS232	5
	1 x PROFIBUS master/slave	6
Communication interfaces (optional)	1 x sercos II	7
	1 x single-pole ready contact	8
Inputs/outputs (digital)	8 DC-decoupled inputs (with interrupt capability)	2
	8 DC-decoupled outputs	2
I/O extension	Up to 63 Inline I/O modules with up to 512 I/O (64 bytes)	3
Function modules	Up to 4	
Power supply		
Nominal value	24 V DC	
Tolerance	-15/+20% (without residual ripple)	
Residual ripple	±5%	
U_{max}	30 V DC	
U_{min}	19.2 V DC	
Power consumption from U_{LS}	Max. 3 A	
Power consumption from $U_M + U_S$	Max. 8 A	
Environmental conditions		
Ambient temperature (operation)	+5 to 55°C, if the ambient temperature exceeds 45°C, the optional fan must be installed	
Ambient temperature (transport/storage)	-25 to +70°C	
Relative humidity	RH-2; 5 to 95% acc. to DIN EN 61131-2, no dewing	
Atmospheric pressure (operation)	Up to 2,700 m above sea level acc. to DIN 60204	
Atmospheric pressure (transport/storage)	Up to 3,000 m above sea level acc. to DIN 60204	
Mechanical strength		
Vibration/shock resistance	Tested according to EN 60068-2-6/EN 60068-2-27	
EMC immunity	Tested according to EN 61000-6-2/EN 61000-6-4/EN 61131-2	
Availability		
Automation system	IndraLogic, IndraMotion MLC, IndraMotion MTX compact	

IndraControl L45 – technical data

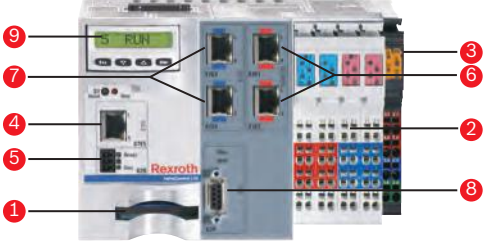
Technical data	IndraControl L45	Legend
		
CPU	x86 compatible/500 MHz	
RAM	512 MB	
Retentive memory	256 kB	
Removable storage medium	CF card/1 GB	①
Real-time clock	Integrated	
Display	1 line, 4 operator keys	⑨
Protection category	IP20	
Dimensions (H x W x D)	120 x 175 x 97.5 mm	
Interfaces		
I/O modules	Inline	
Communication interfaces (standard)	1 x Ethernet TCP/IP (RJ45, 10/100 Base-T)	④
	1 x single-pole ready contact	⑤
Communication interfaces (optional)	1 x PROFIBUS master/slave	⑧
	1 x sercos III (2 x RJ45)	⑥
	1 x PROFINET IO controller/device (2 x RJ45)	⑦
	1 x EtherNet/IP scanner/adaptor (2 x RJ45)	⑦
Inputs/outputs (digital)	8 DC-decoupled inputs (with interrupt capability)	②
	8 DC-decoupled outputs	②
I/O extension	Up to 63 Inline I/O modules with up to 512 I/O (64 bytes)	③
Function modules	Up to 4	
Power supply		
Nominal value	24 V DC	
Tolerance	15/+20% (without residual ripple)	
Residual ripple	±5%	
U_{max}	30 V DC	
U_{min}	19.2 V DC	
Power consumption from U_{LS}	Max. 3 A	
Power consumption from $U_M + U_S$	Max. 8 A	
Environmental conditions		
Ambient temperature (operation)	+5 to +55°C	
Ambient temperature (transport/storage)	-25 to +70°C	
Relative humidity	RH-2; 5 to 95% acc. to DIN EN 61131-2, no dewing	
Atmospheric pressure (operation)	Up to 2,700 m above sea level acc. to DIN 60204	
Atmospheric pressure (transport/storage)	Up to 3,000 m above sea level acc. to DIN 60204	
Mechanical strength		
Vibration/shock resistance	Tested according to EN 60068-2-6/EN 60068-2-27	
EMC immunity	Tested according to EN 61000-6-2/EN 61000-6-4/EN 61131-2	
Availability		
Automation system	IndraMotion MLC, IndraMotion MTX, IndraLogic XLC	

IndraControl L65 – technical data

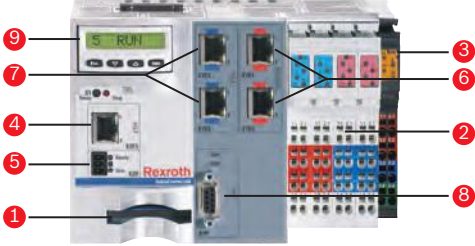
Technical data	IndraControl L65	Legend
		
CPU	x86 compatible/1000 MHz	
RAM	512 MB	
Retentive memory	256 kB	
Removable storage medium	CF card/1 GB	1
Real-time clock	Integrated	
Display	1 line, 4 operator keys	9
Protection category	IP20	
Dimensions (H x W x D)	120 x 175 x 97.5 mm	
Interfaces		
I/O modules	Inline	
Communication interfaces (standard)	1 x Ethernet TCP/IP (RJ45, 10/100 Base-T)	4
	1 x single-pole ready contact	5
Communication interfaces (optional)	1 x PROFIBUS master/slave	8
	1 x sercos III (2 x RJ45)	6
	1 x PROFINET IO controller/device (2 x RJ45)	7
	1 x EtherNet/IP scanner/adaptor (2 x RJ45)	7
Inputs/outputs (digital)	8 DC-decoupled inputs (with interrupt capability)	2
	8 DC-decoupled outputs	2
I/O extension	Up to 63 Inline I/O modules with up to 512 I/O (64 bytes)	3
Function modules	Up to 4	
Power supply		
Nominal value	24 V DC	
Tolerance	-15/+20% (without residual ripple)	
Residual ripple	±5%	
U_{max}	30 V DC	
U_{min}	19.2 V DC	
Power consumption from U_{LS}	Max. 3 A	
Power consumption from $U_M + U_S$	Max. 8 A	
Environmental conditions		
Ambient temperature (operation)	+5 to +55°C	
Ambient temperature (transport/storage)	-25 to +70°C	
Relative humidity	RH-2; 5 to 95% acc. to DIN EN 61131-2, no dewing	
Atmospheric pressure (operation)	Up to 2,700 m above sea level acc. to DIN 60204	
Atmospheric pressure (transport/storage)	Up to 3,000 m above sea level acc. to DIN 60204	
Mechanical strength		
Vibration/shock resistance	Tested according to EN 60068-2-6/EN 60068-2-27	
EMC immunity	Tested according to EN 61000-6-2/EN 61000-6-4/EN 61131-2	
Availability		
Automation system	IndraMotion MLC, IndraMotion MTX, IndraLogic XLC	

IndraControl L85 – technical data

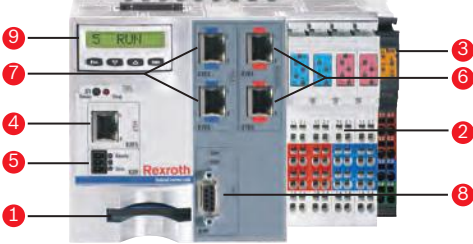
Technical data	IndraControl L85	Legend
		
CPU	Intel Core2Duo with 1.2 GHz	
RAM	512 MB	
Retentive memory	256 kB	
Removable storage medium	CF card/1 GB	①
Real-time clock	Integrated	
Display	1 line, 4 operator keys	⑨
Protection category	IP20	
Dimensions (H x W x D)	120 x 175 x 97.5 mm	
Interfaces		
I/O modules	Inline	
Communication interfaces (standard)	1 x Ethernet TCP/IP (RJ45, 10/100 Base-T) 1 x single-pole ready contact	④ ⑤
Communication interfaces (optional)	1 x PROFIBUS master/slave 1 x sercos III (2 x RJ45) 1 x PROFINET IO controller/device (2 x RJ45) 1 x EtherNet/IP scanner/adapter (2 x RJ45)	⑧ ⑥ ⑦ ⑦
Inputs/outputs (digital)	8 DC-decoupled inputs (with interrupt capability) 8 DC-decoupled outputs	② ②
I/O extension	Up to 63 Inline I/O modules with up to 512 I/O (64 bytes)	③
Function modules	Up to 4	
Power supply		
Nominal value	24 V DC	
Tolerance	-15/+20% (without residual ripple)	
Residual ripple	±5%	
U_{max}	30 V DC	
U_{min}	19.2 V DC	
Power consumption from U_{LS}	Max. 3 A	
Power consumption from $U_M + U_S$	Max. 8 A	
Environmental conditions		
Ambient temperature (operation)	+5 to +55°C	
Ambient temperature (transport/storage)	-25 to +70°C	
Relative humidity	RH-2; 5 to 95% acc. to DIN EN 61131-2, no dewing	
Atmospheric pressure (operation)	Up to 2,700 m above sea level acc. to DIN 60204	
Atmospheric pressure (transport/storage)	Up to 3,000 m above sea level acc. to DIN 60204	
Mechanical strength		
Vibration/shock resistance	Tested according to EN 60068-2-6/EN 60068-2-27	
EMC immunity	Tested according to EN 61000-6-2/EN 61000-6-4/EN 61131-2	
Availability		
Automation system	IndraMotion MTX	

IndraControl L – function module overview and short description



PROFIBUS master
PROFIBUS master
Fieldbus interface



sercos III
Fieldbus interface
sercos III
For implementation of the
Ethernet-based real-time
communication as
interface to drives,
I/O peripherals or control
cross communication



Cross communication
Fieldbus interface
sercos II
For communication with
drives in real-time or
redundant control cross
communication



**Programmable limit
switch**
Function interface,
programmable limit switch
with 16 high-speed
outputs
For implementation of
high-speed cams for
motion control
applications

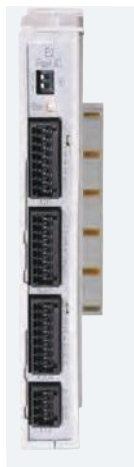

Fast I/O
Function interface, high-
speed inputs and outputs
for short response times
For implementation of
I/O with very short
response times;
8 inputs, 8 outputs and
8 user-configurable inputs
or outputs.
The inputs can be used as
probes with a resolution of
1 μ s.



**Real-time Ethernet and
PROFIBUS**
Fieldbus interface
RT Ethernet
(PROFINET RT,
EtherNet/IP) and
PROFIBUS



SRAM module
Memory module with 8 MB
SRAM, battery-buffered
For implementation of
additional storage capacity
for CNC and motion
control applications

IndraControl L function modules – technical data

Technical data		sercos III CFL01.1-R3	Cross communication CFL01.1-Q2	Real-time Ethernet/ PROFIBUS CFL01.1-TP	PROFIBUS master CFL01.1-P1
Protection category		IP20	IP20	IP20	IP20
Dimensions (H x W x D)	[mm]	120 x 20 x 70	120 x 20 x 70	120 x 20 x 70	120 x 20 x 70
Adjustable ring cycle time	[ms]	–	2, 4, 8	–	–
Max. number of slaves		–	15, 31, 63	–	–
Power supply					
Internal		System bus	System bus	System bus	System bus
Internal power consumption	[W]	2.05	2.3	1.65	1.65
External	[V DC]	–	–	–	–
External power consumption	[W]	–	–	–	–
Environmental conditions					
Ambient temperature (operation)	[°C]	+5 to +55			
Ambient temperature (transport/storage)	[°C]	-25 to +70			
Relative humidity		RH-2; 5 to 95% acc. to DIN EN 61131-2, no dewing			
Atmospheric pressure (operation)		Up to 2,700 m above sea level acc. to DIN 60204			
Atmospheric pressure (transport/storage)		Up to 3,000 m above sea level acc. to DIN 60204			
Mechanical strength					
Vibration/shock resistance		Tested according to EN 60068-2-6, EN 60068-2-27			
EMC immunity		Tested according to EN 60000-6-2, EN 61000-6-4			
Availability					
Automation system		IndraMotion MLC, IndraLogic XLC	IndraMotion MLC	IndraMotion MLC, IndraLogic XLC	IndraMotion MLC, IndraLogic

Technical data		Programmable limit switch CFL01.1-N1	Fast I/O CFL01.1-E2	SRAM CFL01.1-Y1
Protection category		IP20	IP20	IP20
Dimensions (H x W x D)	[mm]	120 x 20 x 70	120 x 20 x 70	120 x 20 x 70
Memory	[MB]	-	-	8 (SRAM)
Buffer time		-	-	Min. 4 years
Battery type		-	-	CR2450 3 V Lithium battery (CAP01.1-B2)
Power supply				
Internal		System bus	System bus	System bus
Internal power consumption	[W]	2.8	0.3	1.0
External	[V DC]	24	24	-
Tolerance (without residual ripple)	[%]	-15/+20	-15/+20	-
Residual ripple	[%]	±5	±5	-
U _{max}	[V]	30	30	-
U _{min}	[V]	19.2	19.2	-
Power consumption (max.)	[A]	4	4	-
Digital inputs				
Number		-	Max. 16 (of which 8 are fixed and 8 can be bitwise configured as input or output)	-
Connection method		-	1-wire	-
Potential isolated from logic voltage		-	Yes	-
Reverse polarity protection		-	Yes	-
Input voltage at "0"/"1"	[V DC]	-	-3 to +5/+11 to +30	-
Sensor supply	[V DC]	-	24	-
Digital outputs				
Number		16	Max. 16 (of which 8 are fixed and 8 can be bitwise configured as input or output)	-
Connection method		1-wire	1-wire	-
Output type		Semiconductor, no retaining	Semiconductor, no retaining	-
Output voltage, nominal	[V]	24	24	-
Rated output current	[A]	0.5	0.5	-
Lamp load at 8 Hz	[W]	5	5	-
Inductive load at 1 Hz	[W]	6.2 (SG 1)	6.2 (SG 1)	-
Environmental conditions				
Ambient temperature (operation)	[°C]		+5 to +55	
Ambient temperature (transport/storage)	[°C]		-25 to +70	
Relative humidity		RH-2; 5 to 95% acc. to DIN EN 61131-2, no dewing		
Atmospheric pressure (operation)		Up to 2,700 m above sea level acc. to DIN 60204		
Atmospheric pressure (transport/storage)		Up to 3,000 m above sea level acc. to DIN 60204		
Mechanical strength				
Vibration/shock resistance		Tested according to EN 60068-2-6, EN 60068-2-27		
EMC immunity		Tested according to EN 61000-6-2, EN 61000-6-4		
Availability				
Automation system		IndraMotion MLC, IndraLogic XLC	IndraMotion MLC, IndraLogic, IndraLogic XLC	IndraMotion MLC, IndraMotion MTX

Note: The various function modules are not entirely supported by every system. For information on which function modules are supported by the system version used, please refer to the appropriate system-specific manual.

IndraControl L – ordering data

Ordering data for hardware	
Description	Type code
IndraControl L10	CML10.1-NN-210-NB-NNNN-NW
IndraControl L20, PROFIBUS	CML20.1-NP-120-NA-NNNN-NW
IndraControl L25, sercos III	CML25.1-3N-400-NN-NNC1-NW
IndraControl L25, configurable fieldbus interface	CML25.1-PN-400-NN-NNC1-NW
IndraControl L40, PROFIBUS	CML40.2-NP-330-NA-NNNN-NN
IndraControl L40, PROFIBUS, sercos II	CML40.2-SP-330-NA-NNNN-NN
IndraControl L45, configurable fieldbus interface	CML45.1-NP-500-NA-NNNN-NW
IndraControl L45, sercos III, configurable fieldbus interface	CML45.1-3P-500-NA-NNNN-NW
IndraControl L45, sercos III, configurable fieldbus interface, 8 MB SRAM	CML45.1-3P-504-NA-NNNN-NW
IndraControl L65, configurable fieldbus interface	CML65.1-NP-500-NA-NNNN-NW
IndraControl L65, sercos III, configurable fieldbus interface	CML65.1-3P-500-NA-NNNN-NW
IndraControl L65, sercos III, configurable fieldbus interface, 8 MB SRAM	CML65.1-3P-504-NA-NNNN-NW
IndraControl L85, sercos III, configurable fieldbus interface, 16 MB SRAM	CML85.1-3P-705-NA-NNNN-NW
Ordering data for function modules	
Description	Type code
Real-time Ethernet/PROFIBUS	CFL01.1-TP
sercos III	CFL01.1-R3
Cross communication (sercos II with FO)	CFL01.1-Q2
PROFIBUS master	CFL01.1-P1
Programmable limit switch (16 high-speed outputs)	CFL01.1-N1
Fast I/O (8 inputs, 8 outputs, 8 user-configurable inputs or outputs)	CFL01.1-E2
SRAM module (8 MB, battery-buffered)	CFL01.1-Y1
Ordering data for accessories	
Description	Type code
Fan for IndraControl L40	CAL01.1-F1
Fan for IndraControl L45/L65	CAL01.1-F2
Spare battery for SRAM module CFL01.1-Y1	CAP01.1-B2
Connector set for IndraControl L	R-IB IL CML S01-PLSET
Connector set for IndraControl L (continuous numbering)	R-IB IL CML S04-PLSET
Connector set for IndraControl L10 (sectioned numbering)	R-IB IL CML S03-PLSET
Labeling field, narrow	R-IB IL FIELD 2
Labeling field, wide	R-IB IL FIELD 8
Ordering data for documentation	
Description	Type code
Project planning manual for IndraControl L10	DOK-CONTRL-IC*L10*****-PRxx-DE-P
Project planning manual for IndraControl L20	DOK-CONTRL-IC*L20*****-PRxx-DE-P
Project planning manual for IndraControl L25	DOK-CONTRL-IC*L25*****-PRxx-DE-P
Project planning manual for IndraControl L40	DOK-CONTRL-IC*L40*****-PRxx-DE-P
Project planning manual for IndraControl L45, L65, and L85	DOK-CONTROL-ICL45L64L85L-IS
Project planning manual for IndraControl L function modules	DOK-CONTRL-IC*L*FM*****-PRxx-DE-P

xx = software/firmware version, device version

IndraControl L10, L20, and L25

IndraControl L10

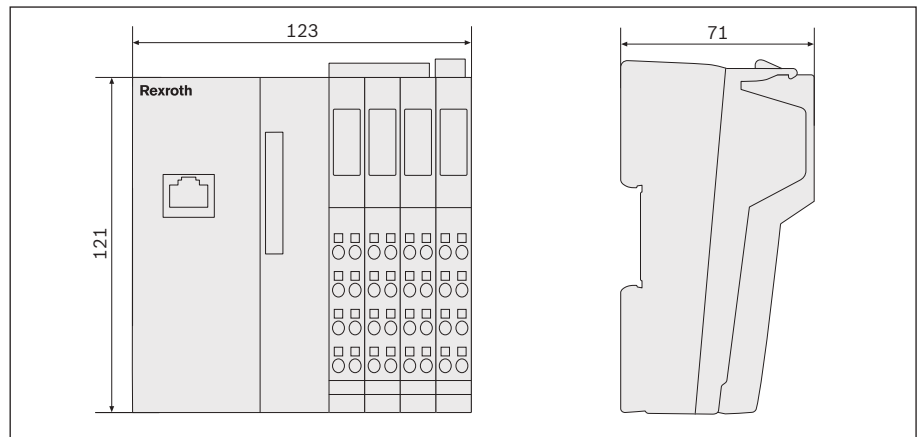

IndraControl L20

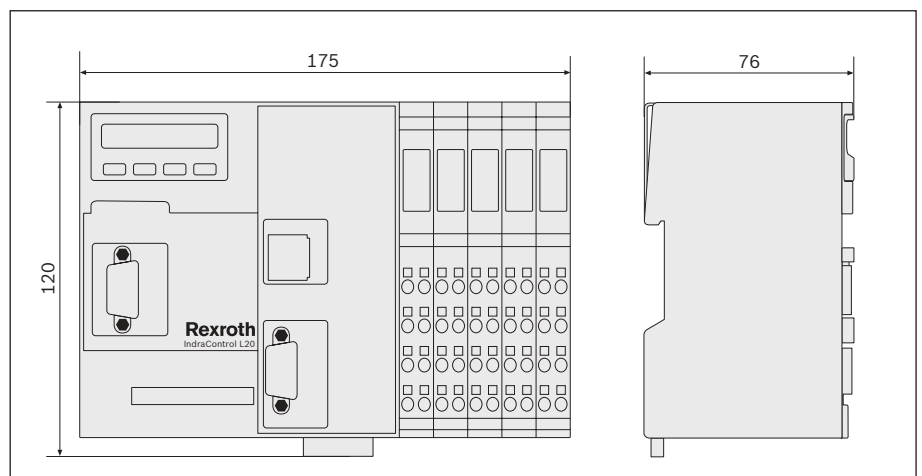

IndraControl L25

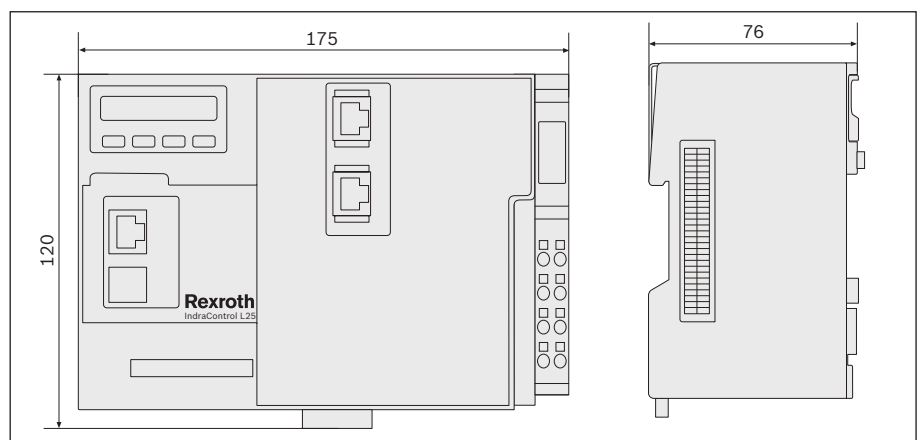

IndraControl L40, L45, L65, and L85

IndraControl L40

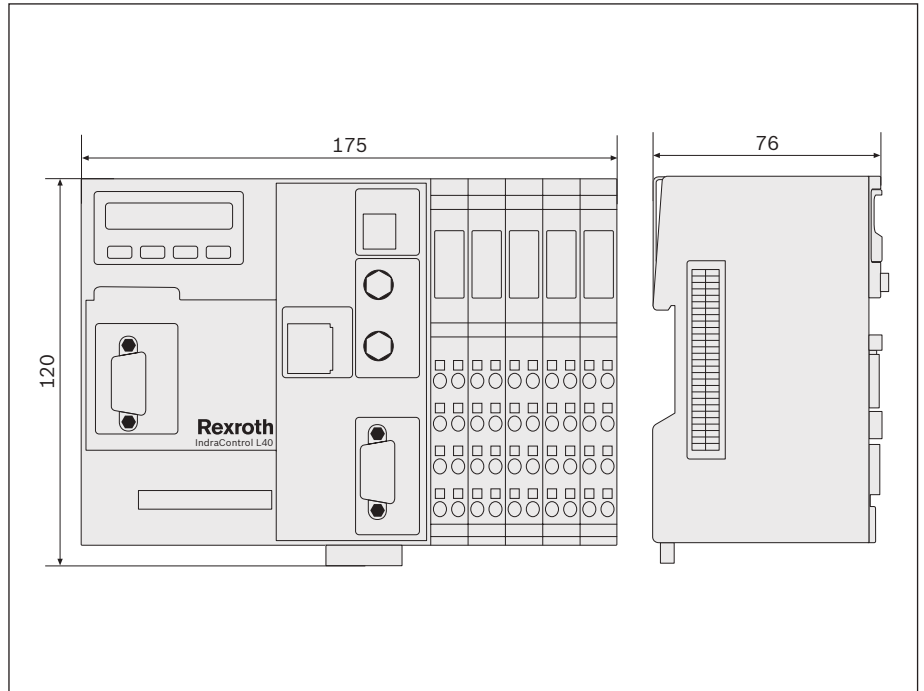

IndraControl L45, L65, and L85

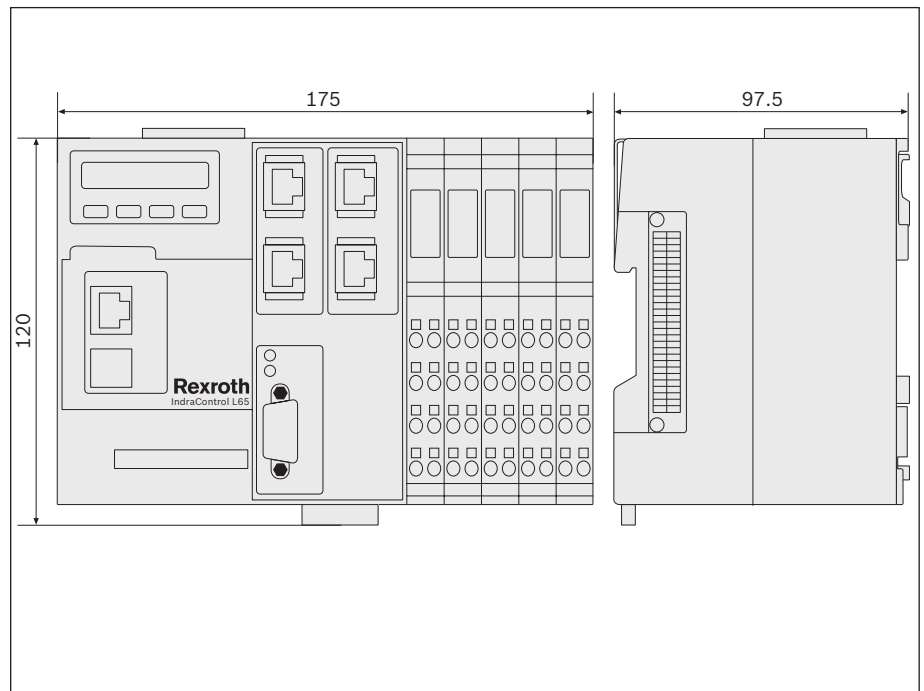



Inline – compact I/O technology in the control cabinet

Rexroth Inline is the flexibly scalable modular I/O system with IP20 protection for time-saving installation in a control cabinet – whether locally at the IndraControl L or as a distributed I/O station.

Rexroth Inline is available for all current fieldbus systems in the following two versions:

- ▶ Inline Modular – finely scalable modular I/O system for individual configuration
- ▶ Inline Block – bus coupler with preconfigured I/O as an ideal solution for nodes with limited I/O scope

Fieldbus coupler



Fieldbus couplers form the first module in an Inline station and are the interface to the fieldbus system. The various I/O modules can be directly connected to these fieldbus couplers.

Digital modules

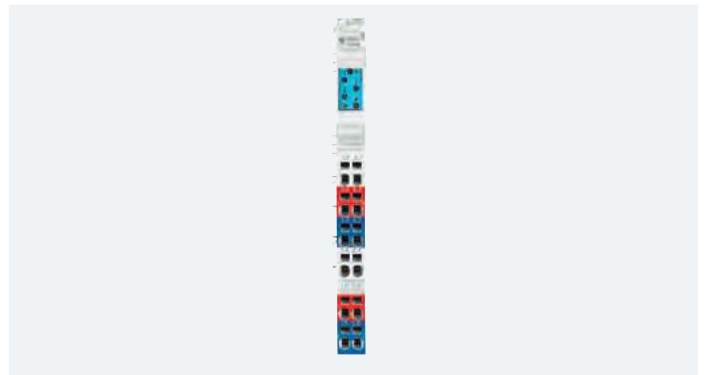

Digital I/O modules – for connection of digital signals, from pushbuttons, limit switches, or proximity switches.

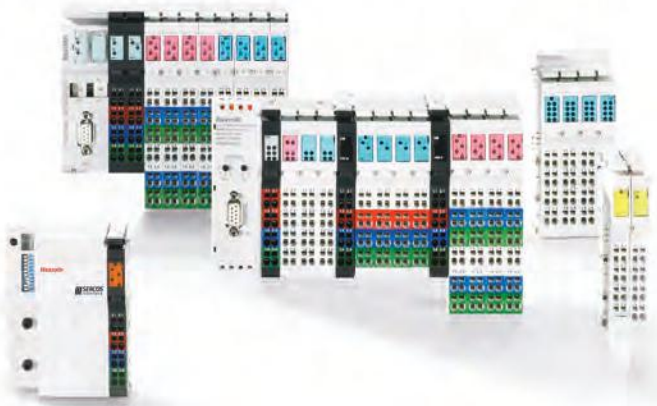

Rexroth Inline – the flexible I/O system for centralized and distributed system architectures

Compact, modular, and simple

- ▶ Space-saving I/O technology for attachment to standard rails
- ▶ Individually combinable modules
- ▶ Well-considered assembly and installation design



Analog modules



Analog I/O modules allow the measurement and output of analog signals from standard sensors and analog actuators with 16-bit resolution.

Power supply/segment modules

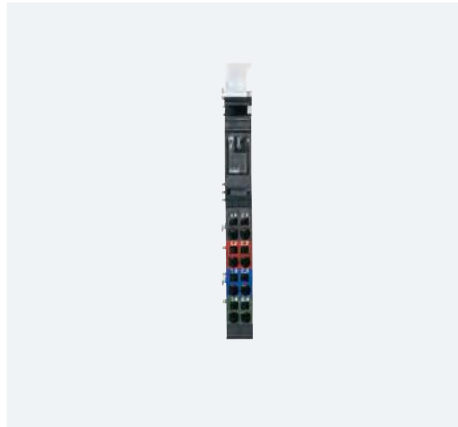

Power supply/segment modules allow the insertion of logic voltage or to isolate segments in Inline stations.

Technology modules



Technology modules solve special tasks, for example the detection of relative, absolute or angular positions.

Relay modules



Relay modules allow switching of an isolated voltage of up to 230 V AC.

Block I/O modules



Digital block I/O modules can be connected to all common fieldbus systems using the integrated bus coupler. The complete module minimizes costs compared to modular stations and is the ideal solution for assembly in compact control cabinets.

Inline – for quick and easy assembly

Time-saving combination of bus couplers and modules

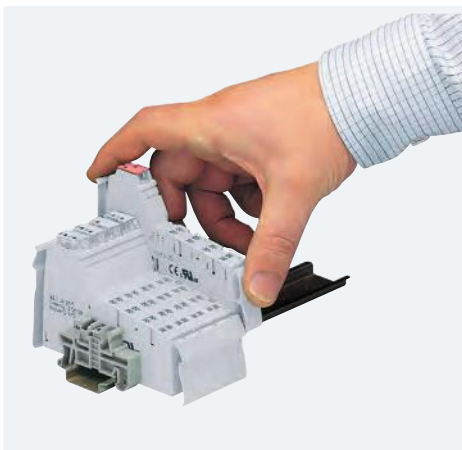

The bus coupler is the head of an Inline station. The I/O modules are simply connected to it end-to-end. All the voltages needed for these modules and the sensors/actuators are automatically cross-wired via the lateral contacts within an Inline station. As a result, all peripheral voltages can be directly tapped.

Flexible connection through permanent wiring

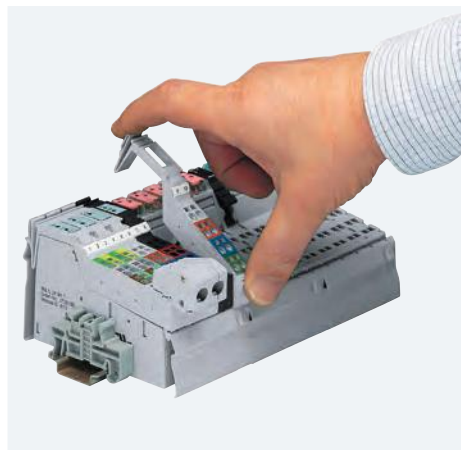

Using snap-on connectors you can quickly make connections to sensors/actuators in the field and release them again without any complex labeling of individual cores. Shielded cables can be connected directly to functional ground using connectors with an integrated shield connection.

Easy connection of conductors



Conductors with stripped ends are simply inserted in the spring-loaded terminals of the Inline connectors without any connector sleeves. Connection cross-sections in the range from 0.2 mm² to 1.5 mm² are possible.

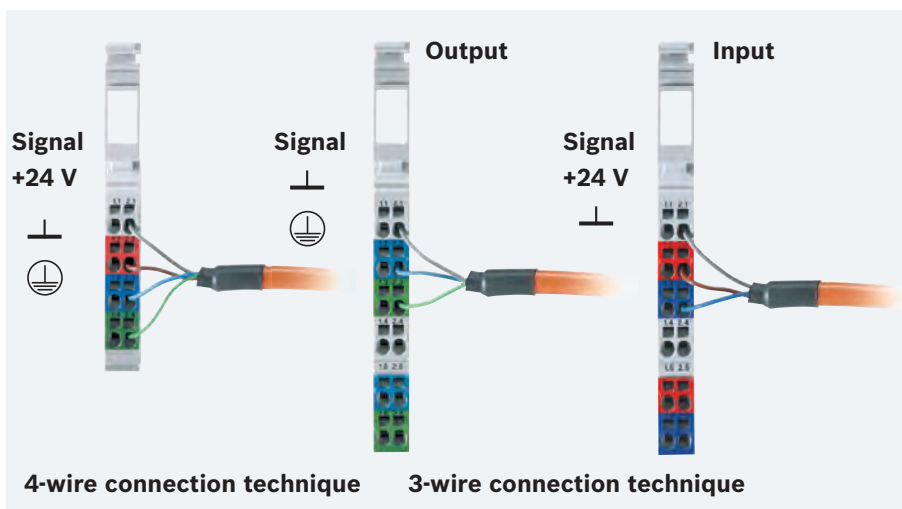

Cost-effective multi-wire connection technique

With the multi-wire connection technique there are no longer any strapping terminals in the control cabinet – this saves money and cuts installation time. The 1-wire connection technique provides you with particularly compact high-density modules with 32 channels.

The multi-wire connection technique minimizes your wiring costs.

Inline – with intelligent voltage distribution

Rexroth Inline is a convincing solution with its intelligent distribution concept for all voltages. The internal contacts of the modules automatically connect to the cross-wiring for the internal local bus as well as for the voltage supply to the logic, analog modules, sensors and actuators. Separate protection arrangements, electrical isolation and the formation of segments can be implemented very easily.

What this means to you: All voltages can be directly taken from the Inline modules and no additional distribution modules are necessary. This saves space, reduces costs and prevents wiring errors.

Supply to the bus coupler and provision of primary voltage

The voltages U_L for the logic circuit and U_{ANA} for analog modules are generated from the supply voltage U_{BK} which is connected to the bus coupler. The 24 V voltage supply to the main circuit U_M is fed in likewise at the bus coupler.

Main and segment circuits

The signal and actuator supply to the digital I/Os is provided by the segment voltage U_S . It is diverted from the main circuit U_M at the bus coupler via a bridge, an external fuse or a switch. Through the separation of U_M and U_S it is very easy to form segments which can be separately switched or protected. Neighboring terminals and their I/Os continue to be supplied when, for example, a single segment circuit is switched off.

Supply and segment modules

U_M and U_S can be fed in by means of supply modules if the power required by the signal and actuator supply exceeds the maximum distributable value. It is also possible to construct electrically-isolated main circuits within an Inline station. Inline segment modules enable several segment circuits to be constructed within a main circuit.

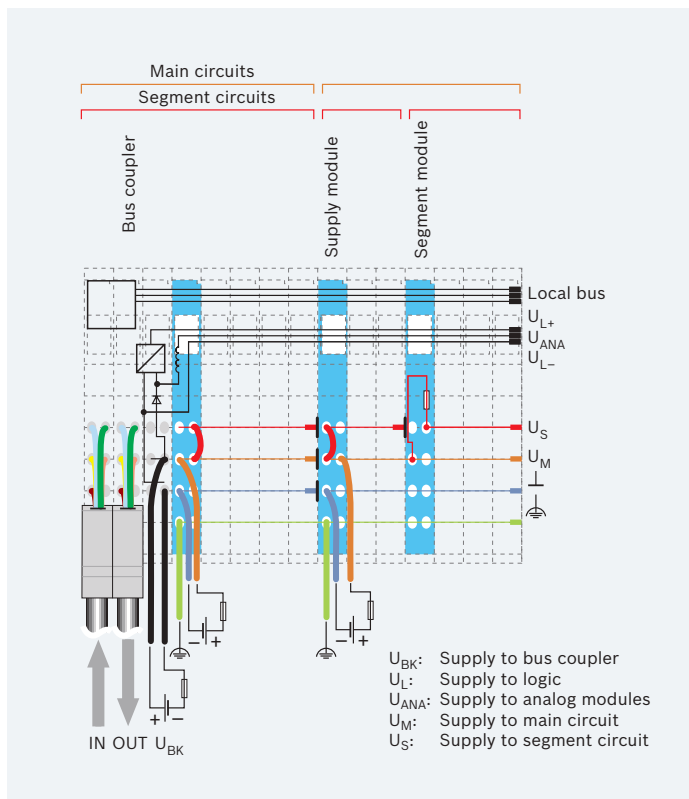

Easy setup of main and segment circuits – thanks to Inline.

Fieldbus coupler – technical data

Technical data	R-IBS IL 24 BK-DSUB-PAC	R-IBS IL 24 BK-T/U-PAC	R-IL SE BK	R-IL PB BK DP/V1-PAC
Communication				
Interfaces	INTERBUS	INTERBUS	sercos II (FO)	PROFIBUS
	Local bus	Local bus	Local bus	Local bus
System data				
Number of segments per station	Max. 63	Max. 63	Max. 40	Max. 63
Total of all I/O data per station	Max. 192 bytes	Max. 192 bytes	Max. 32 bytes inputs	Max. 184 bytes in IL PB BK mode Max. 176 bytes in IL PB BK DP/V1 mode
Transmission speed in the local bus	500 kbaud	500 kbaud	500 kbaud	500 kbaud
Segment feed U_S/U_M				
Nominal value	24 V DC	24 V DC	24 V DC	24 V DC
Tolerance	-15/+20%	-15/+20%	-15/+20%	-15/+20%
Load current	Max. 8 A	Max. 8 A	Max. 8 A	Max. 8 A
Logic supply U_L				
Nominal value	7.5 V (from ext. 24 V DC)	7.5 V (from ext. 24 V DC)	7.5 V (from ext. 24 V DC)	7.5 V (from ext. 24 V DC)
Load current	Max. 2 A	Max. 2 A	Max. 2 A	Max. 2 A
Analog supply U_{ANA}				
Nominal value	24 V DC	24 V DC	24 V DC	24 V DC
Tolerance	-15/+20%	-15/+20%	-15/+20%	-15/+20%
Permissible voltage range	19 to 30 V DC	19 to 30 V DC	19 to 30 V DC	19 to 30 V DC
Load current	Max. 0.5 A	Max. 0.5 A	Max. 0.5 A	Max. 0.5 A
Ambient conditions				
Permissible temperature (operation)	-25 to +55°C	-25 to +55°C	-25 to +55°C	-25 to +55°C
Permissible relative humidity (operation)	5 to 90%, no dewing	5 to 90%, no dewing	5 to 90%, no dewing	5 to 90%, no dewing
Mechanical data				
Dimensions (W x H x D)	90 x 120 x 70 mm	48.8 x 120 x 70 mm	90 x 121 x 70 mm	85 x 120 x 72 mm
Dimensional drawing (see pp. 172–175)	Type 2	Type 3	Type 2	Type 2
Weight (including plug)	210 g	210 g	210 g	297 g
Protection category	IP20	IP20	IP20	IP20

Technical data	R-IL S3 BK D18 DO4-PAC	R-IL PN BK D18 DO4-PAC	R-IL EIP BK D18 DO4 2TX-PAC	R-IL ETH BK D18 DO4 2TX-PAC	R-IL PB BK D18 DO4/CN-PAC
Communication					
Interfaces	sercos Local bus	PROFINET IO Local bus	EtherNET/IP Local bus	Modbus/TCP (UDP) Local bus	PROFIBUS Local bus
System data					
Number of segments per station	Max. 63 (incl. 2 at bus coupler)	Max. 63 (incl. 2 at bus coupler)	Max. 63 (incl. 2 at bus coupler)	Max. 63 (incl. 2 at bus coupler)	Max. 63 (incl. 2 at bus coupler)
Total of all I/O data per station	Max. 244 bytes	Max. 244 bytes	Max. 244 bytes	Max. 244 bytes	Max. 244 bytes
Transmission speed in the local bus	500 kbaud	500 kbaud	500 kbaud	500 kbaud	500 kbaud
Digital outputs					
Number	4	4	4	4	4
Nominal output voltage U_{Out}	24 V	24 V	24 V	24 V	24 V
Differential voltage at I_{Nom}	≤ 1 V	≤ 1 V	≤ 1 V	≤ 1 V	≤ 1 V
Nominal current I_{Nom} per channel	0.5 A	0.5 A	0.5 A	0.5 A	0.5 A
Nominal current tolerances	10%	10%	0.1	0.1	10%
Total current	2 A	2 A	2 A	2 A	2 A
Protection	Short-circuit, overload	Short-circuit, overload	Short-circuit, overload	Short-circuit, overload	Short-circuit, overload
Actuator connection type	2, 3-wire connection	2, 3-wire connection	2, 3-wire connection	2, 3-wire connection	2, 3-wire connection
Digital inputs					
Number	8	8	8	8	8
Design	Acc. to EN 61131-2, Type 1	Acc. to EN 61131-2, Type 1	Acc. to EN 61131-2, Type 1	Acc. to EN 61131-2, Type 1	Acc. to EN 61131-2, Type 1
Switching thresholds:					
Max. voltage at low level U_{Lmax}	< 5 V	< 5 V	< 5 V	< 5 V	< 5 V
Max. voltage at high level U_{Hmax}	> 15 V	> 15 V	> 15 V	> 15 V	> 15 V
Common potentials	Segment supply, ground	Segment supply, ground	Segment supply, ground	Segment supply, ground	Segment supply, ground
Nominal input voltage U_{INom}	24 V DC	24 V DC	24 V DC	24 V DC	24 V DC
Permissible nominal input voltage range	$-30 < U_{INom} < +30$ V DC	$-30 < U_{INom} < +30$ V DC	$-30 < U_{INom} < +30$ V DC	$-30 < U_{INom} < +30$ V DC	$-30 < U_{INom} < +30$ V DC
Nominal input current at U_{INom}	Typ. 3 mA	Typ. 3 mA	Typ. 3 mA	Typ. 3 mA	Typ. 3 mA
Permissible line length	30 m	30 m	30 m	30 m	30 m
Sensor connection type	2-wire and 3-wire connection	2-wire and 3-wire connection	2-wire and 3-wire connection	2-wire and 3-wire connection	2-wire and 3-wire connection
Segment feed U_g/U_M					
Nominal value	24 V DC	24 V DC	24 V DC	24 V DC	24 V DC
Tolerance	-15/+20%	-15/+20%	-15/+20%	-15/+20%	-15/+20%
Load current	Max. 8 A	Max. 8 A	Max. 8 A	Max. 8 A	Max. 8 A
Logic supply U_L					
Nominal value	7.5 V (from ext. 24 V DC)	7.5 V (from ext. 24 V DC)	7.5 V (from ext. 24 V DC)	7.5 V (from ext. 24 V DC)	7.5 V (from ext. 24 V DC)
Load current	Max. 0.8 A	Max. 0.8 A	Max. 0.8 A	Max. 0.8 A	Max. 0.8 A
Analog supply U_{ANA}					
Nominal value	24 V DC	24 V DC	24 V DC	24 V DC	24 V DC
Tolerance	-15/+20%	-15/+20%	-15/+20%	-15/+20%	-15/+20%
Permissible voltage range	19 to 30 V DC	19 to 30 V DC	19 to 30 V DC	19 to 30 V DC	19 to 30 V DC
Load current	Max. 0.5 A	Max. 0.5 A	Max. 0.5 A	Max. 0.5 A	Max. 0.5 A
Ambient conditions					
Permissible temperature (operation)	-25 to +55°C	-25 to +55°C	-25 to +55°C	-25 to +55°C	-25 to +55°C
Permissible relative humidity (operation)	5 to 90%, no dewing	5 to 90%, no dewing	5 to 90%, no dewing	5 to 90%, no dewing	5 to 90%, no dewing
Mechanical data					
Dimensions (W x H x D)	80 x 121 x 70 mm	80 x 121 x 70 mm	80 x 121 x 70 mm	80 x 121 x 70 mm	80 x 121 x 70 mm
Dimensional drawing (see pp. 172–175)	Type 1	Type 1	Type 1	Type 1	Type 1
Weight (including plug)	320 g	320 g	320 g	320 g	320 g
Protection category	IP20	IP20	IP20	IP20	IP20

Digital inputs – technical data

Technical data	R-IB IL 24 DI 2-PAC	R-IB IL 24 DI 4-PAC	R-IB IL 24 DI 8-PAC	R-IB IL 24 DI 8/HD-PAC
Digital inputs				
Number	2	4	8	8
Design	Acc. to EN 61131-2, Type 1	Acc. to EN 61131-2, Type 1	Acc. to EN 61131-2, Type 1	Acc. to EN 61131-2, Type 1
Switching thresholds				
Max. voltage at low level U_{Lmax}	< 5 V	< 5 V	< 5 V	< 5 V
Max. voltage at high level U_{Hmax}	> 15 V	> 15 V	> 15 V	> 15 V
Common potentials	Segment supply, ground	Segment supply, ground	Segment supply, ground	Segment supply, ground
Nominal input voltage U_{INom}	24 V DC	24 V DC	24 V DC	24 V DC
Permissible nominal input voltage range	$-30 < U_{INom} < +30$ V DC	$-30 < U_{INom} < +30$ V DC	$-30 < U_{INom} < +30$ V DC	$-30 < U_{INom} < +30$ V DC
Nominal input current at U_{INom}	Min. 5 mA	Min. 3 mA	Min. 3 mA	Min. 3 mA
Permissible line length	30 m	30 m	30 m	30 m
Sensor connection type	2, 3, and 4-wire connection	2, 3, and 4-wire connection	2, 3, and 4-wire connection	1-wire connection
Electrical data				
Logic voltage U_L	7.5 V	7.5 V	7.5 V	7.5 V
Power consumption from local bus U_L	35 mA	40 mA	50 mA	50 mA
Nom. current consumption from U_S	Max. 0.5 A (2 x 0.25 A)	Max. 1.0 A	Max. 2.0 A	Max. 2.0 A
Operating mode: process data mode	2 bits	4 bits	8 bits	8 bits
Transmission speed	500 kbaud	500 kbaud	500 kbaud	500 kbaud
Ambient conditions				
Permissible temperature (operation)	-25 to +55°C	-25 to +55°C	-25 to +55°C	-25 to +55°C
Permissible relative humidity (operation)	5 to 90%, no dewing	5 to 90%, no dewing	5 to 90%, no dewing	5 to 90%, no dewing
Mechanical data				
Dimensions (W x H x D)	12.2 x 120 x 71.5 mm	12.2 x 141 x 71.5 mm	48.8 x 120 x 71.5 mm	12.2 x 141 x 71.5 mm
Dimensional drawing (see pp. 172–175)	Type 4	Type 5	Type 6	Type 5
Weight (without plug)	38 g	44 g	118 g	44 g
Protection category	IP20	IP20	IP20	IP20

Technical data	R-IB IL 24 DI 16-PAC	R-IB IL 24 DI 16-NPN-PAC-NPN-switching	R-IB IL 24 DI 32/HD-PAC	R-IB IL 24 DI 32/HD-NPN-PAC-NPN-switching
Digital inputs				
Number	16	16	32	32
Design	Acc. to EN 61131-2, Type 1	Acc. to EN 61131-2, Type 1	Acc. to EN 61131-2, Type 1	Acc. to EN 61131-2, Type 1
Switching thresholds				
Max. voltage at low level U_{Lmax}	< 5 V	< 5 V	< 5 V DC	< 5 V DC
Max. voltage at high level U_{Hmax}	> 15 V	> 15 V	> 15 V DC	> 15 V DC
Common potentials	Segment supply, ground	Segment supply, ground	Segment supply, ground	Segment supply, ground
Nominal input voltage U_{INom}	24 V DC	24 V DC	24 V DC	24 V DC
Permissible nominal input voltage range	$-30 < U_{INom} < +30$ V DC	$-30 < U_{INom} < +30$ V DC	$-30 < U_{INom} < +30$ V DC	$-30 < U_{INom} < +30$ V DC
Nominal input current at U_{INom}	Min. 3 mA	3 mA	2.8 mA	2.8 mA
Delay time t_{On}	–	–	2 ms	2 ms
Delay time t_{Off}	–	–	4 ms	4 ms
Permissible line length	30 m	30 m	30 m	30 m
Sensor connection type	2-wire and 3-wire connection	2-wire and 3-wire connection	1-wire connection	1-wire connection
Electrical data				
Logic voltage U_L	7.5 V	7.5 V	7.5 V	7.5 V
Power consumption from local bus U_L	60 mA	60 mA	90 mA	90 mA
Nom. current consumption from U_S	Max. 4.0 A	Max. 4.0 A	–	–
Operating mode: process data mode	16 bits	16 bits	32 bits	32 bits
Transmission speed	500 kbaud	500 kbaud	500 kbaud	500 kbaud
Ambient conditions				
Permissible temperature (operation)	-25 to +55°C	-25 to +55°C	-25 to +55°C	-25 to +55°C
Permissible relative humidity (operation)	5 to 90%, no dewing	5 to 90%, no dewing	5 to 90%, no dewing	5 to 90%, no dewing
Mechanical data				
Dimensions (W x H x D)	48.8 x 141 x 71.5 mm	48.8 x 141 x 71.5 mm	48.8 x 120 x 71.5 mm	48.8 x 120 x 71.5 mm
Dimensional drawing (see pp. 172–175)	Type 7	Type 7	Type 6	Type 6
Weight (without plug)	122 g	122 g	125 g	125 g
Protection category	IP20	IP20	IP20	IP20

Digital outputs – technical data

Technical data		R-IB IL 24 DO 2-2A-PAC	R-IB IL 24 DO 4-PAC	R-IB IL 24 DO 8-PAC
Digital outputs				
Number		2	4	8
Nominal output voltage U_{Out}		24 V DC	24 V DC	24 V DC
Differential voltage at I_{Nom}		≤ 1 V	≤ 1 V	≤ 1 V
Nominal current I_{Nom} per channel		2 A	0.5 A	0.5 A
Nominal current tolerances		10%	10%	10%
Total current		4 A	2 A	4 A
Protection		Short-circuit/overload	Short-circuit/overload	Short-circuit/overload
Signal delay upon power up of	Nom. resistive load (12 Ω /48 W)	Typ. 200 μ s	Typ. 100 μ s	Typ. 100 μ s
	Nom. lamp load (48 W)	Typ. 200 ms	Typ. 100 ms	Typ. 100 ms
	Nom. inductive load (1.2 H, 12 Ω)	Typ. 250 ms	Typ. 100 ms	Typ. 100 ms
Signal delay upon power down of	Nom. resistive load (12 Ω /48 W)	Typ. 200 μ s	Typ. 1 ms	Typ. 1 ms
	Nom. lamp load (48 W)	Typ. 200 μ s	Typ. 1 ms	Typ. 1 ms
	Nom. inductive load (1.2 H, 12 Ω)	Typ. 250 ms	Typ. 50 ms	Typ. 50 ms
Actuator connection type		2, 3, and 4-wire connection	2, 3-wire connection	2, 3, and 4-wire connection
Electrical data				
Logic voltage		7.5 V	7.5 V	7.5 V
Power consumption from local bus U_L		Max. 35 mA	Max. 44 mA	Max. 60 mA
Segment supply voltage U_S		24 V DC (nominal)	24 V DC (nominal)	24 V DC (nominal)
Nominal current consumption from U_S		Max. 4 A (2 x 2 A)	Max. 2 A (2 x 0.5 A)	Max. 4 A (8 x 0.5 A)
Operating mode: process data mode		2 bits	4 bits	8 bits
Transmission speed		500 kbaud	500 kbaud	500 kbaud
Error message to the higher-level control system		Short-circuit/overload of an output	Short-circuit/overload of an output	Short-circuit/overload of an output
Ambient conditions				
Permissible temperature (operation)		-25 to +55°C	-25 to +55°C	-25 to +55°C
Permissible relative humidity (operation)		5 to 90%, no dewing	5 to 90%, no dewing	5 to 90%, no dewing
Mechanical data				
Dimensions (W x H x D)		12.2 x 120 x 71.5 mm	12.2 x 141 x 71.5 mm	48.8 x 120 x 71.5 mm
Dimensional drawing (see pp. 172–175)		Type 4	Type 5	Type 6
Weight (without plug)		46 g	46 g	130 g
Protection category		IP20	IP20	IP20

Technical data		R-IB IL 24 DO 8/HD-PAC	R-IB IL 24 DO 8-2A-PAC	R-IB IL 24 DO 8-NPN-PAC - NPN-switching
Digital outputs				
Number		8	8	8
Nominal output voltage U_{Out}		24 V DC	24 V DC	24 V DC
Differential voltage at I_{Nom}		≤ 1 V	≤ 1 V	≤ 1 V
Nominal current I_{Nom} per channel		0.5 A	2 A	0.5 A
Nominal current tolerances		0.1	10%	10%
Total current		4 A	8 A (with 50% synchronization)	4 A
Protection		Short-circuit/overload	Short-circuit/overload	Short-circuit/overload
Signal delay upon power up of	Nom. resistive load (12 Ω/48 W)	Typ. 500 μs	Typ. 50 μs	Typ. 100 μs
	Nom. lamp load (48 W)	Typ. 100 ms	Typ. 75 ms	Typ. 100 ms
	Nom. inductive load (1.2 H, 12 Ω)	Typ. 100 ms	Typ. 50 ms	Typ. 100 ms
Signal delay upon power down of	Nom. resistive load (12 Ω/48 W)	Typ. 1 ms	Typ. 500 μs	Typ. 1 ms
	Nom. lamp load (48 W)	Typ. 1 ms	Typ. 500 μs	Typ. 1 ms
	Nom. inductive load (1.2 H, 12 Ω)	Typ. 50 ms	Typ. 150 ms	Typ. 50 ms
Actuator connection type		1-wire connection	2, 3, and 4-wire connection	2, 3, and 4-wire connection
Electrical data				
Logic voltage		7.5 V	7.5 V	7.5 V
Power consumption from local bus U_L		Max. 45 mA	Max. 60 mA	Max. 60 mA
Segment supply voltage U_s		24 V DC (nominal)	24 V DC (nominal)	24 V DC (nominal)
Nominal current consumption from U_s		Max. 4 A (8 x 0.5 A)	Max. 8 A	Max. 4 A (8 x 0.5 A)
Operating mode: process data mode		8 bits	8 bits	4 bits
Transmission speed		500 kbaud	500 kbaud	500 kbaud
Error message to the higher-level control system		Short-circuit/ overload of an output	–	Short-circuit/ overload of an output
Ambient conditions				
Permissible temperature (operation)		-25 to +55°C	-25 to +55°C	-25 to +55°C
Permissible relative humidity (operation)		5 to 90%, no dewing	5 to 90%, no dewing	5 to 90%, no dewing
Mechanical data				
Dimensions (W x H x D)		12.2 x 120 x 71.5 mm	48.8 x 120 x 71.5 mm	48.8 x 120 x 71.5 mm
Dimensional drawing (see pp. 172–175)		Type 4	Type 6	Type 6
Weight (without plug)		60 g	130 g	130 g
Protection category		IP20	IP20	IP20

Digital outputs – technical data

Technical data		R-IB IL 24 DO 16-PAC	R-IB IL 24 DO 32/HD-PAC	R-IB IL 24 DO 32/HD-NPN-PAC - NPN-switching
Digital outputs				
Number		16	32	32
Nominal output voltage U_{Out}		24 V DC	24 V DC	24 V DC
Differential voltage at I_{Nom}		≤ 1 V	≤ 1 V	≤ 1 V
Nominal current I_{Nom} per channel		0.5 A	0.5 A	0.5 A
Nominal current tolerances		10%	10%	10%
Total current		8 A	8 A	8 A
Protection		Short-circuit/overload	Short-circuit/overload	Short-circuit/overload
Signal delay upon power up of	Nom. resistive load (12 Ω /48 W)	Typ. 500 μ s	Typ. 500 μ s	Typ. 500 μ s
	Nom. lamp load (48 W)	Typ. 100 ms	Typ. 100 ms	Typ. 100 ms
	Nom. inductive load (1.2 H, 12 Ω)	Typ. 100 ms	Typ. 100 ms	Typ. 100 ms
Signal delay upon power down of	Nom. resistive load (12 Ω /48 W)	Typ. 1 ms	Typ. 1 ms	Typ. 1 ms
	Nom. lamp load (48 W)	Typ. 1 ms	Typ. 1 ms	Typ. 1 ms
	Nom. inductive load (1.2 H, 12 Ω)	Typ. 50 ms	Typ. 50 ms	Typ. 50 ms
Actuator connection type		2, 3-wire connection	1-wire connection	1-wire connection
Electrical data				
Logic voltage		7.5 V	7.5 V	7.5 V
Power consumption from local bus U_L		Max. 90 mA	Max. 140 mA	Max. 140 mA
Segment supply voltage U_s		24 V DC (nominal)	24 V DC (nominal)	24 V DC (nominal)
Nominal current consumption from U_s		Max. 8 A (16 x 0.5 A)	Max. 8 A (16 x 0.5 A)	Max. 8 A (16 x 0.5 A)
Operating mode: process data mode		16 bits	32 bits	32 bits
Transmission speed		500 kbaud	500 kbaud	500 kbaud
Error message to the higher-level control system		Short-circuit/overload of an output	Short-circuit/overload	Short-circuit/overload
Ambient conditions				
Permissible temperature (operation)		-25 to +55°C	-25 to +55°C	-25 to +55°C
Permissible relative humidity (operation)		5 to 90%, no dewing	5 to 90%, no dewing	5 to 90%, no dewing
Mechanical data				
Dimensions (W x H x D)		48.8 x 141 x 71.5 mm	48.8 x 120 x 71.5 mm	48.8 x 120 x 71.5 mm
Dimensional drawing (see pp. 172–175)		Type 7	Type 6	Type 6
Weight (without plug)		130 g	135 g	135 g
Protection category		IP20	IP20	IP20

Technical data	R-IB IL 24/230 DOR 1/W-PAC	R-IB IL 24/230 DOR4/W-PAC
Relay output		
Number	1	4
Max. switching voltage	253 V AC, 250 V DC	253 V AC, 250 V DC
Max. switching capacity	750 VA	750 VA
Electrical data		
Logic voltage	7.5 V	7.5 V
Power consumption from local bus U_L	Max. 60 mA	Max. 187 mA
Operating mode: process data mode	2 bits	4 bits
Transmission speed	500 kbaud	500 kbaud
Ambient conditions		
Permissible temperature (operation)	-25 to +55°C	-25 to +55°C
Permissible relative humidity (operation)	5 to 90%, no dewing	5 to 90%, no dewing
Mechanical data		
Dimensions (W x H x D)	12.2 x 120 x 71.5 mm	12.2 x 120 x 71.5 mm
Dimensional drawing (see pp. 172–175)	Type 4	Type 6
Weight (without plug)	46 g	46 g
Protection category	IP20	IP20

Analog inputs – technical data

Technical data	R-IB IL AI 2/SF-230-PAC	R-IB IL AI 2/SF-PAC	R-IB IL AI 4/EF-PAC
Analog inputs			
Number	2 analog single-ended inputs	2 analog single-ended inputs	4 analog single-ended inputs
Digital filtering (averaging)	Across 16 measurement values (can be switched off)	Across 16 measurement values (can be switched off)	None or across 4, 16 or 32 measurement values
Conversion time of A/D converter	Typ. 120 µs	Typ. 120 µs	Max. 10 µs
Voltage inputs			
Measuring ranges	0 to 10 V, ±10 V	0 to 10 V, ±10 V	0 to 10 V; ± 10 V; 0 to 5 V; ± 5 V
Input resistance	> 220 kΩ	> 220 kΩ	Approx. 300 kΩ
Limit frequency (-3 dB) of input filters	230 Hz	40 Hz	500 Hz
Process data update of either channel	< 1.5 ms	< 1.5 ms	< 1 ms
Current inputs			
Input resistance	50 Ω	50 Ω	Approx. 110 Ω
Measuring ranges	0 to 20 mA, ±20 mA, 4 to 20 mA	0 to 20 mA, ±20 mA, 4 to 20 mA	0 to 20 mA; ± 20 mA; 4 to 20 mA
Limit frequency (-3 dB) of input filters	230 Hz	40 Hz	500 Hz
Process data update of either channel	< 1.5 ms	< 1.5 ms	< 1 ms
Max. permissible current in each input	±100 mA	±100 mA	Protected against overload
Resolution	16 bits	16 bits	16 bits
Sensor connection type	2-wire and 3-wire connection	2-wire and 3-wire connection	2, 3, and 4-wire connection
Electrical data			
Logic voltage U_L	7.5 V	7.5 V	7.5 V
Power consumption from local bus U_L	Typ. 45 mA	Typ. 45 mA	Typ. 85 mA
Peripheral supply voltage U_{ANA}	24 V DC	24 V DC	24 V DC
Power consumption from U_{ANA}	Typ. 12 mA	Typ. 12 mA	Typ. 13 mA
Operating mode: process data mode	32 bits	32 bits	32 bits
Transmission speed	500 kbaud	500 kbaud	500 kbaud
Error message to the higher-level control system	Failure of supply voltage U_{ANA} , peripheral/user error	Failure of supply voltage U_{ANA} , peripheral/user error	Failure of supply voltage U_{ANA} , peripheral/user error
Ambient conditions			
Permissible temperature (operation)	-25 to +55°C	-25 to +55°C	-25 to +55°C
Permissible relative humidity (operation)	5 to 90%, no dewing	5 to 90%, no dewing	10 to 95%, no dewing
Mechanical data			
Dimensions (W x H x D)	12.2 x 135 x 71.5 mm	12.2 x 135 x 71.5 mm	48.8 x 135 x 71.5 mm
Dimensional drawing (see pp. 172–175)	Type 8	Type 8	Type 10
Weight (without plug)	47 g	47 g	125 g
Protection category	IP20	IP20	IP20

Technical data	R-IB IL AI 8/IS-PAC	R-IB IL AI 8/SF-PAC	R-IB IL SGI 2/F-PAC ¹⁾
Analog inputs			
Number	8 analog single-ended inputs	8 analog single-ended inputs	2 input channels for strain gauges (4 voltage inputs)
Digital filtering (averaging)	None or across 4, 16 or 32 measurement values	None or across 4, 16 or 32 measurement values	–
Conversion time of A/D converter	Max. 10 µs	Max. 10 µs	–
Bridge voltage U_0	–	–	3.3 V (±0.5 V) or 5 V (±0.5 V)
Measurement representation	–	–	15 bits + sign bit
Process data update	–	–	Synchronous with the bus
Bus cycle time	–	–	≥1 ms
Limit frequency of differential bridge input	–	–	Typ. 1.6 kHz
Sensor connection type	–	–	6-wire and 4-wire connection
Voltage inputs			
Measuring ranges	–	0 to 10 V, ±10 V, 0 to 5 V, ±5 V, 0 to 25 V, ±25 V, 0 to 50 V	–
Input resistance	–	Min. 240 kΩ	–
Limit frequency (-3 dB) of input filters	–	3.5 kHz	–
Process data update of either channel	–	< 1.5 ms	–
Current inputs			
Input resistance	25 Ω	25 Ω	–
Measuring ranges	0 to 20 mA, 4 to 20 mA, ±20 mA, 0 to 40 mA, ±40 mA	0 to 20 mA, 4 to 20 mA, ±20 mA, 0 to 40 mA, ±40 mA	–
Limit frequency (-3 dB) of input filters	3.5 kHz	3.5 kHz	–
Process data update of either channel	Synchronous with the bus	< 1.5 ms	–
Max. permissible current in each input	±100 mA	±100 mA	–
Resolution	16 bits	16 bits	–
Sensor connection type	2-wire and 3-wire connection	2-wire connection	–
Outputs			
Number	–	–	2
Total impedance of Inline module	–	–	Voltage outputs ($U_V = 3.3$ V, $U_V = 5$ V)
	–	–	> 60 Ω
Electrical data			
Logic voltage U_L	7.5 V	7.5 V	7.5 V
Power consumption from local bus U_L	Typ. 52 mA, max. 65 mA	Typ. 52 mA, max. 65 mA	Typ. 75 mA
Peripheral supply voltage U_{ANA}	24 V DC	24 V DC	24 V DC
Power consumption from U_{ANA}	Typ. 31 mA, max. 40 mA	Typ. 31 mA, max. 40 mA	Typ. 8 mA, 32 mA ($U_V = 5$ V)
Operating mode: process data mode	32 bits	32 bits	48 bits
Transmission speed	500 kbaud	500 kbaud	500 kbaud
Error message to the higher-level control system	Failure of supply voltage U_{ANA} , peripheral/user error	Failure of supply voltage U_{ANA} , peripheral/user error	Yes
Ambient conditions			
Permissible temperature (operation)	-25 to +55°C	-25 to +55°C	-25 to +55°C
Permissible relative humidity (operation)	5 to 90%, no dewing	5 to 90%, no dewing	5 to 90%, no dewing
Mechanical data			
Dimensions (W x H x D)	48.8 x 135 x 71.5 mm	48.8 x 135 x 71.5 mm	48.8 x 135 x 71.5 mm
Dimensional drawing (see pp. 172–175)	Type 10	Type 10	Type 10
Weight (without plug)	125 g	125 g	125 g
Protection category	IP20	IP20	IP20

¹⁾ Inline analog strain gauge input terminals

Temperature modules – technical data

Technical data	R-IB IL TEMP 2 RTD-PAC	R-IB IL TEMP 2 UTH-PAC	R-IB IL TEMP 4/8 RTD-PAC
Analog inputs			
Number	2 inputs for resistive temperature sensors	2 inputs for thermocouples or linear voltages	8 inputs for resistive temperature sensors
Compatible sensor types	Pt, Ni, Cu, KTY	B, C, E, J, K, L, N, R, S, T, U, W, HK	Pt, Ni, Cu, KTY, linear resistors
Characteristic current	According to DIN According to SAMA	DIN EN 60584-1: 1995 (B, E, J, K, N, R, S, T) DIN 43710 (U, L)	Acc. to DIN EN 60751: 07/1996; acc. to SAMA RC 21-4-1966
Conversion time of A/D converter	Typ. 120 µs	Typ. 120 µs	Typ. 5 µs, max. 10 µs
Voltage input range	–	–15 to +85 mV	–15 to +85 mV
Process data update	Depending on connection technique	Max. 30 ms for either channel	Depending on connection technique
Both channels acc. to 2-wire connection	20 ms	–	–
One channel acc. to 2-wire connection, one channel acc. to 4-wire connection	20 ms	–	–
Both channels acc. to 3-wire connection	32 ms	–	–
Limit frequency of analog filter	–	48 Hz	–
Sensor connection type	2, 3, and 4-wire connection	2-wire connection	2-wire and 3-wire connection
Electrical data			
Logic voltage U_L	7.5 V	7.5 V	7.5 V
Power consumption from local bus U_L	Typ. 43 mA	Typ. 43 mA	Typ. 75 mA
Peripheral supply voltage U_{ANA}	24 V DC	24 V DC	24 V DC
Power consumption from U_{ANA}	Typ. 11 mA	Typ. 11 mA	Typ. 28 mA
Operating mode: process data mode	32 bits	32 bits	80 bits
Transmission speed	500 kbaud	500 kbaud	500 kbaud
Error message to the higher-level control system	Failure of supply voltage U_{ANA} , peripheral/user error	Failure of supply voltage U_{ANA} , peripheral/user error	Failure of supply voltage U_{ANA} , peripheral/user error
Ambient conditions			
Permissible temperature (operation)	–25 to +55°C	–25 to +55°C	–25 to +55°C
Permissible relative humidity (operation)	5 to 90%, no dewing	5 to 90%, no dewing	5 to 90%, no dewing
Mechanical data			
Dimensions (W x H x D)	12.2 x 135 x 71.5 mm	12.2 x 135 x 71.5 mm	48.8 x 135 x 71.5 mm
Dimensional drawing (see pp. 172–175)	Type 8	Type 8	Type 10
Weight (without plug)	46 g	46 g	125 g
Protection category	IP20	IP20	IP20

Analog outputs – technical data

Technical data	R-IB IL AO 1/SF-PAC	R-IB IL AO 1/SF/CN-PAC	R-IB IL AO 2/SF-PAC
	Uniform terminal point designation		
Analog outputs			
Number	1, automatically configured in relation to the terminal point used	1, automatically configured in relation to the terminal point used	2, automatically configured in relation to the terminal point used
Current ranges	0 to 20 mA, 4 to 20 mA	0 to 20 mA, 4 to 20 mA	0 to 20 mA, 4 to 20 mA
Voltage ranges	0 to 10 V	0 to 10 V	0 to 10 V
Basic error limit	–	–	±0.003%
Output load, voltage output	2 kΩ	2 kΩ	Min. 2 kΩ
Output load, current output	0 to 500 Ω	0 to 500 Ω	0 to 500 Ω
Resolution	16 bits	16 bits	16 bits
Process data update incl. conversion time of D/A converter	< 1 ms	< 1 ms	< 1 ms
Actuator connection type	2-wire connection	2-wire connection	2-wire connection
Electrical data			
Logic voltage U_L	7.5 V	7.5 V	7.5 V
Power consumption from local bus U_L	Typ. 30 mA, max. 40 mA	Typ. 30 mA, max. 40 mA	Typ. 36 mA, max. 45 mA
Peripheral supply voltage U_{ANA}	24 V DC	24 V DC	24 V DC
Power consumption from U_{ANA}	Typ. 50 mA, max. 65 mA	Typ. 50 mA, max. 65 mA	Typ. 75 mA, max. 95 mA
Operating mode: process data mode	32 bits	32 bits	32 bits
Transmission speed	500 kbaud	500 kbaud	500 kbaud
Error message to the higher-level control system	Failure or logic voltage U_L not reached	Failure or logic voltage U_L not reached	Failure of supply voltage U_{ANA}
Ambient conditions			
Permissible temperature (operation)	-25 to +55°C	-25 to +55°C	-25 to +55°C
Permissible relative humidity (operation)	5 to 90%, no dewing	5 to 90%, no dewing	5 to 90%, no dewing
Mechanical data			
Dimensions (W x H x D)	24.4 x 135 x 71.5 mm	24.4 x 135 x 71.5 mm	48.8 x 135 x 71.5 mm
Dimensional drawing (see pp. 172–175)	Type 9	Type 9	Type 10
Weight (without plug)	48 g	48 g	125 g
Protection category	IP20	IP20	IP20

Analog outputs – technical data

Technical data	R-IB IL AO 2/SF/CN-PAC	R-IB IL AO 2/U/BP-PAC
	Uniform terminal point designation	
Analog outputs		
Number	2, automatically configured in relation to the terminal point used	2 single-ended outputs
Current ranges	0 to 20 mA, 4 to 20 mA	
Voltage ranges	0 to 10 V	-10 to +10 V, 0 to +10 V
Basic error limit	±0.003%	±0.02%
Output load, voltage output	Min. 2 kΩ	Min. 2 kΩ
Output load, current output	0 to 500 Ω	
Resolution	16 bits	16 bits
Process data update incl. conversion time of D/A converter	< 1 ms	< 1 ms
Actuator connection type	2-wire connection	2-wire connection
Electrical data		
Logic voltage U_L	7.5 V	7.5 V
Power consumption from local bus U_L	Typ. 36 mA, max. 45 mA	Typ. 33 mA, max. 40 mA
Peripheral supply voltage U_{ANA}	24 V DC	24 V DC
Power consumption from U_{ANA}	Typ. 75 mA, max. 95 mA	Typ. 25 mA, max. 35 mA
Operating mode: process data mode	32 bits	32 bits
Transmission speed	500 kbaud	500 kbaud
Error message to the higher-level control system	Failure of supply voltage U_{ANA}	Failure or logic voltage U_L not reached
Ambient conditions		
Permissible temperature (operation)	-25 to +55°C	-25 to +55°C
Permissible relative humidity (operation)	5 to 90%, no dewing	5 to 90%, no dewing
Mechanical data		
Dimensions (W x H x D)	48.8 x 135 x 71.5 mm	12.2 x 135 x 71.5 mm
Dimensional drawing (see pp. 172–175)	Type 10	Type 8
Weight (without plug)	125 g	48 g
Protection category	IP20	IP20

Feed/segment modules – technical data

Technical data		R-IB IL 24 PWR IN-PAC	R-IB IL 24 PWR IN/R-PAC	R-IB IL 24 PWR IN/R/L-0.8A-PAC
24 V power supply for generation of U_L and U_{ANA}				
Rated value		–	24 V DC	24 V DC
Permissible range		–	19.2 to 30 V DC	19.2 to 30 V DC
Power consumption at nominal voltage				
24 V module supply		–	1.25 A	1.25 A
Logic supply	Rated value	–	7.5 V DC	7.5 V DC
	Max. output current	–	2.0 A	0.8 A
Analog supply	Rated value	–	24 V DC	–
	Max. output current	–	0.5 A	–
24 V peripheral supply (main circuit U_M)				
Rated value		24 V DC	24 V DC	24 V DC
Permissible range		19.2 to 30 V	19.2 to 30 V	19.2 to 30 V
Permissible current		Max. 8 A	Max. 8 A	Max. 8 A
Power supply		–	–	–
Electrical data				
Transmission speed		500 kbaud	500 kbaud	500 kbaud
Ambient conditions				
Permissible temperature (operation)		-25 to +55°C	-25 to +55°C	-25 to +55°C
Permissible relative humidity (operation)		5 to 90%, no dewing	5 to 90%, no dewing	5 to 90%, no dewing
Mechanical data				
Dimensions (W x H x D)		12.2 x 120 x 71.5 mm	48.8 x 120 x 71.5 mm	12.2 x 120 x 71.5 mm
Dimensional drawing (see pp. 172–175)		Type 4	Type 6	Type 4
Weight (without plug)		44 g	44 g	44 g
Protection category		IP20	IP20	IP20

Feed/segment modules – technical data

Technical data	R-IB IL 24 SEG-PAC	R-IB IL 24 SEG/F-D-PAC	R-IB IL 24 SEG/F-PAC
24 V peripheral supply (main circuit U_M)			
Power supply	Voltage infeed is in the bus terminal or in the infeed terminal. No connections for the supply voltage are required at the segment terminal. The appropriate terminal points are available for testing purposes.	Voltage infeed is in the bus terminal or in the infeed terminal.	Voltage infeed is in the bus terminal or in the infeed terminal. No connections for the supply voltage are required at the segment terminal. The appropriate terminal points are available for testing purposes.
Permissible total current in the potential terminals of the main and segment circuits			
Nominal terminal current	6.0 A	6.0 A	6.0 A
Max. permissible value	8.0 A	8.0 A	8.0 A
Electrical data			
Transmission speed	500 kbaud	500 kbaud	500 kbaud
Ambient conditions			
Permissible temperature (operation)	-25 to +55°C	-25 to +55°C	-25 to +55°C
Permissible relative humidity (operation)	5 to 90%, no dewing	5 to 90%, no dewing	5 to 90%, no dewing
Mechanical data			
Dimensions (W x H x D)	12.2 x 120 x 71.5 mm	12.2 x 120 x 71.5 mm	12.2 x 120 x 71.5 mm
Dimensional drawing (see pp. 172–175)	Type 4	Type 4	Type 4
Weight (without plug)	44 g	44 g	44 g
Protection category	IP20	IP20	IP20

Technical data	R-IB IL PD 24V-PAC	R-IB IL PD GND-PAC
Inline potential distributor		
24 V peripheral supply (main circuit U_M)		
Rated value	24 V DC	24 V DC
Permissible range	19.2 to 30 V	19.2 to 30 V
Permissible current	Max. 8 A	Max. 8 A
Power supply	Inline potential distributor. Voltage infeed is in the bus terminal or in the infeed terminal.	Inline potential distributor. Voltage infeed is in the bus terminal or in the infeed terminal.
Electrical data		
Transmission speed	500 kbaud	500 kbaud
Ambient conditions		
Permissible temperature (operation)	-25 to +55°C	-25 to +55°C
Permissible relative humidity (operation)	5 to 90%, no dewing	5 to 90%, no dewing
Mechanical data		
Dimensions (W x H x D)	12.2 x 120 x 71.5 mm	12.2 x 120 x 71.5 mm
Dimensional drawing (see pp. 172–175)	Type 4	Type 4
Weight (without plug)	44 g	44 g
Protection category	IP20	IP20

Technology modules – technical data

Technical data	R-IB IL CNT-PAC	R-IB IL INC-IN-PAC	
	Counter module	Incremental encoder module	
Digital inputs			
Number	1 counter input for 24 V signals 1 counter input for 5 V signals 1 control input for 24 V signals 1 control input for 5 V signals	3 – – –	
Design of input	–	According to EN 61131-2, Type 1	
Nominal input voltage U_{in}	24 V DC	24 V DC	
Permissible range	–	-30 < U_{in} < +30 V DC	
Nominal input current at U_{in}	5 mA	Typ. 2.7 mA	
Delay time	< 5 μ s	< 1 ms	
Sensor connection type	–	2-wire and 3-wire connection	
24 V sensor connection type	2-wire and 3-wire connection	–	
5 V sensor connection type	2-wire connection	–	
Number	1	–	
Nominal output voltage U_{out}	24 V DC	–	
Nominal current I_{Nom}	Max. 0.5 A	–	
Digital outputs			
Number	–	1 (double assignment of input E3)	
Output type	–	NPN (switches against ground)	
Actuator connection type	–	2-wire and 3-wire connection	
Encoder inputs			
Number	–	1	
Type	–	Incremental encoder	
Encoder signals	–	2 pulse strings (A and B, electrically shifted by 90°) and 1 reference signal (Z)	
Encoder types			
Symmetrical incremental-value encoders (symmetrical pulse train (RS422) with transverse trace)	Encoder supply	–	5 or 24 V DC
	Signal connection type	–	A and A inverted, B and B inverted, Z and Z inverted
	Input frequency	–	Max. 300 kHz
Asymmetrical incremental-value encoder (asymmetrical pulse train without transverse trace)	Encoder supply	–	5 or 24 V DC
	Signal connection type	–	A, B, Z
	Input frequency	–	Max. 300 kHz
Electrical data			
Logic voltage U_L	7.5 V	7.5 V	
Power consumption from local bus U_L	Typ. 40 mA, max. 50 mA	Max. 70 mA	
Nominal voltage U_S	24 V DC	24 V DC	

Technical data	R-IB IL CNT-PAC	R-IB IL INC-IN-PAC
	Counter module	Incremental encoder module
Nominal current consumption from U_s	Max. 1 A	Typ. 340 mA
Operating mode: process data mode	32 bits	32 bits
Transmission speed	500 kbaud	500 kbaud
Error message to the higher-level control system	Short-circuit/overload of sensor supply	Short-circuit/overload of sensor supply
Frequency measurement	$f \leq 100$ kHz	–
Event counter	$f \leq 100$ kHz	–
Time measurement	$0.25 \text{ ms} \leq t \leq 131 \text{ ms}$ (resolution 2 μs , without reference conditions)	–
	$1 \text{ ms} \leq t \leq 131 \text{ ms}$ (resolution 2 μs , with reference conditions)	–
	$2 \text{ ms} \leq t \leq 131 \text{ s}$ (resolution 2 ms)	–
	$10 \text{ ms} \leq t \leq 655 \text{ s}$ (resolution 10 ms)	–
Pulse generator	$1 \text{ kHz} \leq f \leq 10 \text{ kHz}$	–
Ambient conditions		
Permissible temperature (operation)	-25 to +55°C	-25 to +55°C
Permissible relative humidity (operation)	5 to 90%, no dewing	5 to 90%, no dewing
Mechanical data		
Dimensions (W x H x D)	24.4 x 135 x 71.5 mm	24.4 x 141 x 71.5 mm
Dimensional drawing (see pp. 172–175)	Type 9	Type 9
Weight (without plug)	90 g	90 g
Protection category	IP20	IP20

Technology modules – technical data

Technical data		R-IB IL PWM/2-PAC PWM output module
Digital outputs 24 V DC		
Number		2
Nominal output voltage U_{Out}		24 V DC
Differential voltage at I_{Nom}		≤ 1 V
Nominal current I_{Nom} per channel		0.5 A
Nominal current tolerances		10%
Protection		Short-circuit/overload
Signal delay upon power up of	Nominal resistive load (12 Ω /48 W)	Typ. 80 μ s
	Nominal lamp load (48 W)	Typ. 100 μ s
	Nominal inductive load (1.2 H, 12 Ω)	Typ. 150 μ s
Signal delay upon power down of	Nominal resistive load (12 Ω /48 W)	Max. 500 Hz
	Nominal lamp load (48 W)	Max. 500 Hz
	Nominal inductive load (1.2 H, 12 Ω)	Max. 0.3 Hz
Actuator connection type		2-wire and 3-wire connection
Digital outputs 5 V DC		
Number		2
Nominal output voltage U_{Out}		5 V DC
Differential voltage at I_{Nom}		0.5 V
Nominal current I_{Nom} per channel		10 mA
Nominal current tolerances		10%
Protection		Short-circuit/overload
Signal delay upon power up of nominal resistive load		2 μ s
Signal delay upon power down of nominal resistive load		2 μ s
Switching frequency at a nominal resistive load		50 kHz
Electrical data		
Logic voltage U_{L}		7.5 V
Power consumption from local bus U_{L}		130 mA
Nominal voltage U_{s}		24 V DC
Nominal current consumption from U_{s}		Max. 1 A
Operating mode: process data mode		32 bits
Transmission speed		500 kbaud
Error message to the higher-level control system		Short-circuit/overload of sensor supply
Ambient conditions		
Permissible temperature (operation)		-25 to +55°C
Permissible relative humidity (operation)		5 to 90%, no dewing
Mechanical data		
Dimensions (W x H x D)		24.4 x 135 x 71.5 mm
Dimensional drawing (see pp. 172–175)		Type 9
Weight (without plug)		90 g
Protection category		IP20

Technical data	R-IB IL SSI-IN-PAC	R-IB IL SSI-PAC
	Input for absolute rotary system or distance measuring system with SSI interface	Positioning terminal module with SSI interface
Digital inputs		
Number	–	4
Design of input	–	According to EN 61131-2, Type 1
Nominal input voltage U_{in}	–	24 V DC
Permissible range	–	$-30 < U_{in} < +30$ V DC
Nominal input current at U_{in}	–	Typ. 5 mA
Delay time	–	< 1 ms
Sensor connection type	–	2-wire and 3-wire connection
Digital outputs		
Number	–	4
Nominal output voltage U_{out}	–	24 V DC
Nominal current per output I_{Nom}	–	0.5 A
Total current of output	–	2 A
Actuator connection type	–	2-wire and 3-wire connection
Encoder inputs		
Number	1	1
Encoder signals	Clock pulse, inverted clock pulse, data, inverted data	Clock pulse, inverted clock pulse, data, inverted data
Encoder types		
Types	Single-turn or multi-turn	Single-turn or multi-turn
Resolution	8 to 25 bits (configurable)	8 to 25 bits (configurable)
Code type	Gray code, binary code	Gray code, binary code
Parity monitoring	None, even, uneven	None, even, uneven
Rotation direction reversal	Yes, no (configurable)	Yes
Encoder supply	5 V (250 mA)	5 V (500 mA) or 24 V (500 mA)
Transmission frequency	100 kHz, 200 kHz, 400 kHz, 800 kHz, 1 MHz (configurable)	400 kHz
Electrical data		
Logic voltage U_L	7.5 V	7.5 V
Power consumption from local bus U_L	Max. 28 mA	Max. 60 mA
Nominal voltage U_s	24 V DC	24 V DC
Nominal current consumption from U_s	Max. 65.7 mA	Max. 2 A
Operating mode: process data mode	32 bits	32 bits
Transmission speed	500 kbaud	500 kbaud
Error message to the higher-level control system	Failure or overload of encoder supply/ no encoder connected	Failure or overload of encoder supply/ no encoder connected
Ambient conditions		
Permissible temperature (operation)	-25 to +55°C	-25 to +55°C
Permissible relative humidity (operation)	5 to 90%, no dewing	5 to 90%, no dewing
Mechanical data		
Dimensions (W x H x D)	12.2 mm x 120 mm x 72 mm	48.8 x 141 x 71.5 mm
Dimensional drawing (see pp. 172–175)	Type 4	Type 10
Weight (without plug)	71 g	210 g
Protection category	IP20	IP20

Communication modules – technical data

Technical data	R-IB IL 24 FLM-PAC	R-IB IL 24 FLM MULTI-PAC
Serial interface		
Type	Fieldline M8 local bus	Fieldline M8 local bus
Electrical data		
Logic voltage U_L	7.5 V	7.5 V
Power consumption from local bus U_L	Typ. 110 mA	Typ. 110 mA
Segment supply voltage U_s	24 V DC	24 V DC
Nominal current consumption from U_s		
Fieldline M8 local bus	Max. 3 A (with infeed through return line), max. 6 A (with infeed on either side)	Max. 3 A (with infeed through return line), max. 6 A (with infeed on either side)
Internal	Max. 55 mA	Max. 55 mA
Operating mode: process data mode	96 bits	96 bits
Transmission speed	500 kbaud	500 kbaud
Error message to the higher-level control system	Through upstream segment terminal IB IL 24 SEG/F-D	Through upstream segment terminal IB IL 24 SEG/F-D
Ambient conditions		
Permissible temperature (operation)	-25 to +55°C	-25 to +55°C
Permissible relative humidity (operation)	5 to 90%, no dewing	5 to 90%, no dewing
Mechanical data		
Dimensions (W x H x D)	12.2 x 120 x 71.5 mm	12.2 x 120 x 71.5 mm
Dimensional drawing (see pp. 172–175)	Type 8	Type 8
Weight (without plug)	43 g	43 g
Protection category	IP20	IP20

Technical data	R-IB IL 24 LSKIP-PAC Line skip module	R-IB IL RS232-PRO-PAC
Serial interface		
Type	Inline local bus, max. 20 m line length	V.24 interface with DTR/CTS handshake, designed as data terminal equipment (DTE), electrical data acc. to EIA (RS) 232, CCITT V.28, DIN 66259 Part 1
Transmission rate adjustable to	–	38.4 kbaud
Receiver buffer	–	4 kB
Transmitter buffer	–	1 kB
Rated value	24 V DC	–
Permissible range	19.2 to 30 V DC	–
Rated value	24 V DC	–
Permissible range	19.2 to 30 V DC	–
Permissible current	Max. 8 A	–
Electrical data		
Logic voltage U_L	–	7.5 V
Power consumption from local bus U_L	–	Typ. 170 mA
Operating mode: process data mode	–	96 bits
Transmission speed	–	500 kbaud
Nominal current consumption from U_s		
Transmission speed	500 kbaud/2 Mbaud	–
Ambient conditions		
Permissible temperature (operation)	-25 to +55°C	-25 to +55°C
Permissible relative humidity (operation)	5 to 90%, no dewing	5 to 90%, no dewing
Mechanical data		
Dimensions (W x H x D)	48.8 x 134 x 72 mm	24.4 x 120 x 71.5 mm
Dimensional drawing (see pp. 172–175)	Type 3	Type 9
Weight (without plug)	150 g	90 g
Protection category	IP20	IP20

Communication modules – technical data

Technical data	R-IB IL RS485/422-PRO-PAC	R-IB IL 24 IOL 4 DI 12-PAC
Serial interface		
Type	Half-duplex RS485 or full-duplex RS422, electrical data acc. to EIA (RS) 485, EIA (RS) 422, CCITT V.11	–
Transmission rate adjustable to	37.5 kbaud	–
Receiver buffer	4 kB	–
Transmitter buffer	1 kB	–
IO-Link port		
Number	–	4
Nominal current for every IO-Link port	–	Max. 200 mA
Permissible line length to the sensor	–	20 m
Number	–	4
Nominal input voltage	–	24 V DC
Permissible range	–	0 to 30 V DC
Nominal input current	–	5.5 mA
Digital outputs in the SIO mode		
Number of outputs	–	4
Nominal output voltage	–	≥ Segment supply voltage $U_s - 3 V$
Nominal current per channel	–	Max. 200 mA
Digital inputs		
Number	–	12
Nominal input voltage	–	24 V DC
Nominal input current	–	2.2 mA
Delay time	–	3 ms
Connection technique	–	2-wire and 3-wire connection
Electrical data		
Logic voltage U_L	7.5 V	7.5 V
Power consumption from local bus U_L	Typ. 170 mA	Max. 100 mA
Nominal voltage U_M	–	24 V DC
Nominal current consumption from U_M	–	Max. 800 mA
Operating mode: process data mode	96 bits	96 bits
Transmission speed	500 kbaud	500 kbaud
Error message to the higher-level control system	–	Short-circuit of a digital output in the SIO mode
Ambient conditions		
Permissible temperature (operation)	-25 to +55°C	-25 to +55°C
Permissible relative humidity (operation)	5 to 90%, no dewing	10 to 95%, no dewing
Mechanical data		
Dimensions (W x H x D)	24.4 x 135 x 71.5 mm	48.8 x 120 x 72 mm
Dimensional drawing (see pp. 172–175)	Type 9	Type 6
Weight (without plug)	90 g	200 g
Protection category	IP20	IP20

Technical data	R-IB IL DALI/PWR-PAC	R-IB IL DALI-PAC
Interface		
Type	1-channel DALI master; with integrated DALI power supply unit; safe electrical isolation	1-channel DALI master; extension to IB IL DALI/PWR-PAC
Bus voltage	Typ. 14 V	–
Maximum bus load	128 mA	128 mA
Short circuit current	≤ 250 mA	≤ 250 mA
Transmission speed	12 kbaud	12 kbaud
Maximum addressable upstream devices	64	64
Protective device	Bus protected up to maximum 250 V	Bus protected up to maximum 250 V
Electrical data		
Logic voltage U_L	7.5 V	7.5 V
Power consumption from local bus U_L	≤ 38 mA	≤ 38 mA
Nominal voltage U_M	24 V DC	–
Nominal current consumption from U_M	$IM \approx 0.86 \cdot \sum IDALI$	–
Operating mode: process data mode	Process data mode with 2 words	Process data mode with 2 words
Transmission speed	500 kbaud	500 kbaud
Error message to the higher-level control system	Peripheral error message if the DALI bus voltage fails or has a short-circuit	Peripheral error message if the DALI bus voltage fails or has a short-circuit
Ambient conditions		
Permissible temperature (operation)	-25 to +55°C	-25 to +55°C
Permissible relative humidity (operation)	75% on average, occasionally 85% (no dewing)	75% on average, occasionally 85% (no dewing)
Mechanical data		
Dimensions (W x H x D)	48.8 mm x 120 mm x 72 mm	12.2 mm x 120 mm x 72 mm
Dimensional drawing (see pp. 172–175)	Type 6	Type 4
Weight (without plug)	190 g	60 g
Protection category	IP20	IP20

Block I/O modules – technical data

Technical data		R-ILB PB 24 DI16/DO16	R-ILB S3 24 DI16 DIO16
Communication			
Interfaces		PROFIBUS	sercos III
Digital inputs			
Number		16	32 (16 fixed, 16 user-configurable)
Design		According to EN 61131-2, Type 1	According to EN 61131-2, Type 1
Switching thresholds	Max. voltage at low level U_{Lmax}	< 5 V	< 5 V
	Max. voltage at high level U_{Hmax}	> 15 V	> 15 V
Common potentials		Segment supply, ground	Segment supply, ground
Nominal input voltage U_{INom}		24 V DC	24 V DC
Permissible nominal input voltage range		-30 < U_{INom} < +30 V DC	-30 < U_{INom} < +30 V DC
Nominal input current at U_{INom}		Min. 3 mA	Min. 3 mA
Delay time t_{On}		–	–
Delay time t_{Off}		–	–
Permissible line length		30 m	30 m
Sensor connection type		2-wire and 3-wire connection	2-wire and 3-wire connection
Digital outputs			
Number		16	16
Nominal output voltage U_{Out}		24 V DC	24 V DC
Differential voltage at I_{Nom}		≤ 1 V	≤ 1 V
Nominal current I_{INom} per channel		1 A	1 A
Nominal current tolerances		10%	10%
Total current		8 A	8 A
Protection		Short-circuit/overload	Short-circuit/overload
Signal delay upon power up of	Nominal resistive load (12 Ω/48 W)	Typ. 500 μs	Typ. 500 μs
	Nominal lamp load (48 W)	Typ. 100 ms	Typ. 100 ms
	Nominal inductive load (1.2 H, 12 Ω)	Typ. 100 ms	Typ. 100 ms
Actuator connection type		2-wire and 3-wire connection	2-wire and 3-wire connection
Ambient conditions			
Permissible temperature (operation)		-25 to +55°C	-25 to +55°C
Permissible relative humidity (operation)		5 to 90%, no dewing	5 to 90%, no dewing
Mechanical data			
Dimensions (W x H x D)		155.8 x 141 x 55 mm	155.8 x 141 x 55 mm
Dimensional drawing (see pp. 172–175)		Type 11	Type 11
Weight (including plug)		500 g	500 g
Protection category		IP20	IP20

Technical data	R-ILB S3 AI12 AO4 SSI-IN4
Communication	
Interfaces	sercos III
Absolute-value encoder inputs	
Number	4
Encoder signals	Clock pulse, inverted clock pulse, data, inverted data (acc. to RS-422)
Encoder types	
Types	Single-turn or multi-turn
Resolution	8 to 31 bits
Code type	Gray code, binary code
Parity monitoring	None, even, uneven (configurable)
Rotation direction reversal	Yes, no (configurable)
Encoder supply	24 V DC
Current carrying capacity	Max. 200 mA
Transmission frequency	67.5 kHz, 100 kHz, 125 kHz, 200 kHz, 250 kHz, 300 kHz, 400 kHz, 500 kHz, 600 kHz, 700 kHz, 800 kHz, 900 kHz, 1 MHz, 2 MHz, 4 MHz (configurable)
Analog differential inputs	
Number	12
Input filter	10 kHz HW filter, averaging via software filter
Conversion time of A/D converter	75 µs
Resolution of measurements	16 bits
Sensor connection type	2, 3-wire connection; shielded cable, twisted in pairs
Voltage inputs	
Measuring ranges	0 to 10 V; ±10 V
Input resistance	≥ 260 kΩ
Limit frequency (-3 dB) of input filters	10 kHz
Current inputs	
Measuring ranges	±10 mA; 0 to 20 mA; 4 to 20 mA; ±20 mA
Input resistance	240 Ω
Limit frequency (-3 dB) of input filters	10 kHz
Analog outputs	
Number	4
Current ranges	±10 mA; 0 to 20 mA; 4 to 20 mA; ±20 mA
Voltage ranges	0 to 10 V; ±10 V
Output load, voltage output	2 kΩ
Output load, current output	0 to 500 Ω
Resolution	16 bits
Process data update incl. conversion time of D/A converter	75 µs
Actuator connection type	2-wire connection; shielded cable, twisted in pairs
Ambient conditions	
Permissible temperature (operation)	-25 to +55°C
Permissible relative humidity (operation)	5 to 90%, no dewing
Mechanical data	
Dimensions (W x H x D)	156 mm x 141 mm x 59 mm
Dimensional drawing (see pp. 172–175)	Type 11
Weight (including plug)	505 g
Protection category	IP20

Inline – ordering data

Ordering data for fieldbus coupler

Description	Type code
Inline INTERBUS bus coupler*, D-SUB connection, 24 V DC	R-IBS IL 24 BK-DSUB-PAC
Inline INTERBUS bus coupler*, copper connection, 24 V DC	R-IBS IL 24 BK-T/U-PAC
Inline PROFIBUS bus coupler DP/V1*, 8 inputs 24 V DC, 4 outputs 24 V DC, 500 mA, 2, 3-wire connection, consecutive terminal point labeling	R-IL PB BK DI8 DO4/CN-PAC
Inline PROFIBUS bus coupler DPV1*	R-IL PB BK DP/V1-PAC
Inline sercos III bus coupler*, 8 inputs 24 V DC, 4 outputs 24 V DC, 500 mA, 2, 3-wire connection	R-IL S3 BK DI8 DO4-PAC
Inline PROFINET bus coupler*, 8 inputs 24 V DC, 4 outputs 24 V DC, 500 mA, 2, 3-wire connection	R-IL PN BK DI8 DO4-PAC
Inline EtherNet/IP bus coupler*, 8 inputs 24 V DC, 4 outputs 24 V DC, 500 mA, 2, 3-wire connection	R-IL EIP BK DI8 DO4 2TX-PAC
Inline Modbus/TCP (UDP) bus coupler*, 8 inputs 24 V DC, 4 outputs 24 V DC, 500 mA, 2, 3-wire connection	R-IL ETH BK DI8 DO4 2TX-PAC
Inline sercos II bus coupler*	R-IL SE BK

Ordering data for digital modules

Description	Type code
Inline digital input module*, 2 inputs, 24 V DC, 4-wire connection	R-IB IL 24 DI 2-PAC
Inline digital input module*, 4 inputs, 24 V DC, 3-wire connection	R-IB IL 24 DI 4-PAC
Inline digital input module*, 8 inputs, 24 V DC, 4-wire connection	R-IB IL 24 DI 8-PAC
Inline digital input module*, 8 inputs, 24 V DC, 1-wire connection	R-IB IL 24 DI 8/HD-PAC
Inline digital input module*, 16 inputs, 24 V DC, 2, 3-wire connection	R-IB IL 24 DI 16-PAC
Inline digital input module*, 16 inputs, 24 V DC, NPN-switching, 2, 3-wire connection	R-IB IL 24 DI 16-NPN-PAC
Inline digital input module*, 32 inputs, 24 V DC, 1-wire connection	R-IB IL 24 DI 32/HD-PAC
Inline digital input module*, 32 inputs, 24 V DC, NPN-switching, 1-wire connection	R-IB IL 24 DI 32/HD-NPN-PAC
Inline digital output module*, 2 outputs, 24 V DC, 2 A, 4-wire connection	R-IB IL 24 DO 2-2A-PAC
Inline digital output module*, 4 outputs, 24 V DC, 500 mA, 3-wire connection	R-IB IL 24 DO 4-PAC
Inline digital output module*, 8 outputs, 24 V DC, 500 mA, 4-wire connection	R-IB IL 24 DO 8-PAC
Inline digital output module*, 8 outputs, 24 V DC, 500 mA, 1-wire connection	R-IB IL 24 DO 8/HD-PAC
Inline digital output module*, 8 outputs, 24 V DC, 2 A, 4-wire connection	R-IB IL 24 DO 8-2A-PAC
Inline digital output module*, 8 outputs, 24 V DC, NPN-switching, 500 mA, 2, 3-wire connection	R-IB IL 24 DO 8-NPN-PAC
Inline digital output module*, 16 outputs, 24 V DC, 500 mA, 3-wire connection	R-IB IL 24 DO 16-PAC
Inline digital output module*, 32 outputs, 24 V DC, 500 mA, 1-wire connection	R-IB IL 24 DO 32/HD-PAC
Inline digital output module*, 32 outputs, 24 V DC, NPN-switching, 500 mA, 1-wire connection	R-IB IL 24 DO 32/HD-NPN-PAC
Inline digital output module*, 1 relay changeover contact/gold contact, 5-253 V AC, 3 A	R-IB IL 24/230 DOR 1/W-PAC
Inline digital output module*, 4 relay changeover contacts/gold contacts, 5-253 V AC, 3 A	R-IB IL 24/230 DOR4/W-PAC
Inline distance terminal*	R-IB IL DOR LV-SET-PAC

Ordering data for analog modules

Description	Type code
Inline analog input module*, 2 inputs, 0-20 mA, 4-20 mA, ± 20 mA, 0-10 V, ± 10 V, 3-dB cut-off frequency at 230 Hz, 2-wire connection	R-IB IL AI 2/SF-230-PAC
Inline analog input module*, 2 inputs, 0-20 mA, 4-20 mA, ± 20 mA, 0-10 V, ± 10 V, 2-wire connection	R-IB IL AI 2/SF-PAC
Inline analog input module with differential input channels*, 4 inputs, 0-20 mA, 4-20 mA, ± 20 mA, 0-10 V, ± 10 V, 0-5 V, ± 5 V, 2, 3, or 4-wire connection	R-IB IL AI 4/EF-PAC
Inline analog input module*, 8 inputs, 0-20 mA, 4-20 mA, 0-40 mA, ± 20 mA, ± 40 mA, 2, 3-wire connection	R-IB IL AI 8/IS-PAC
Inline analog input module*, 8 inputs, 0-20 mA, 4-20 mA, ± 20 mA, 0-10 V, ± 10 V, (additionally 0-40 mA, ± 40 mA, 0-5 V, ± 5 V, 0-25 V, ± 25 V, 0-50 V), 2-wire connection	R-IB IL AI 8/SF-PAC
Inline analog input module*, 2 inputs, RTD (resistance temperature detector), 2-, 3-, 4-wire connection	R-IB IL TEMP 2 RTD-PAC
Inline analog input module*, 2 inputs, TC (thermocouple), 2-wire connection	R-IB IL TEMP 2 UTH-PAC
Inline analog input module*, 8 channels, RTD (resistance temperature detector), 2, 3-wire connection	R-IB IL TEMP 4/8 RTD-PAC
Inline analog output module*, 1 output, 0-20 mA, 4-20 mA, 0-10 V, 2-wire connection	R-IB IL AO 1/SF-PAC
Inline analog output module*, 1 output, 0-20 mA, 4-20 mA, 0-10 V, 2-wire connection, consecutive terminal point labeling	R-IB IL AO 1/SF/CN-PAC
Inline analog output module*, 2 outputs, 0-20 mA, 4-20 mA, 0-10 V, 2-wire connection	R-IB IL AO 2/SF-PAC
Inline analog output module*, 2 outputs, 0-20 mA, 4-20 mA, 0-10 V, 2-wire connection, consecutive terminal point labeling	R-IB IL AO 2/SF/CN-PAC
Inline analog output module*, 2 outputs, 0-10 V, ± 10 V, 2-wire connection	R-IB IL AO 2/U/BP-PAC

Ordering data for feed/segment, technology, communication, relay modules	
Description	Type code
Branch module for coupling a Fieldline Modular local bus M8 to the end of an Inline station*, change of Inline local bus physics to the physics of the Fieldline local bus	R-IB IL 24 FLM-PAC
Inline branch module for coupling a Fieldline Modular local bus M8 at any point of the Inline local bus*, change of Inline local bus physics to the physics of the Fieldline local bus	R-IB IL 24 FLM MULTI-PAC
Inline branch module to skip a line in an Inline local bus*	R-IB IL 24 LSKIP-PAC
Inline RS-232 function terminal*, for serial data transfer, 1 serial input and output channel in RS-232 version, complete with accessories*	R-IB IL RS232-PRO-PAC
Inline RS-485/-422 function terminal*, for serial data transfer, 1 serial input and output channel in RS-485/-422 version	R-IB IL RS485/422-PRO-PAC
Inline IO Link master*, 4 IO Link ports, 12 digital inputs, 24 V DC, 2, 3-wire connection	R-IB IL 24 IOL 4 DI 12-PAC
Inline 1-channel DALI master*; with integrated DALI power supply unit; safe electrical isolation	R-IB IL DALI/PWR-PAC
Inline 1-channel DALI master*; extension for IB IL DALI/PWR-PAC	R-IB IL DALI-PAC
Inline power module*, 24 V DC, without fuse	R-IB IL 24 PWR IN-PAC
Inline power module or boost terminal*, 24 V DC, without fuse	R-IB IL 24 PWR IN/R-PAC
Inline boost terminal for logic supply U_L of 0.8 A*	R-IB IL 24 PWR IN/R/L0.8A-PAC
Inline segment module*, 24 V DC, without fuse	R-IB IL 24 SEG-PAC
Inline segment module*, 24 V DC, with fuse and diagnosis	R-IB IL 24 SEG/F-D-PAC
Inline segment module*, 24 V DC, with fuse	R-IB IL 24 SEG/F-PAC
Inline module for distribution of potential (24 V)*, feeding out the 24 V supply voltage from the segment circuit (U_S)	R-IB IL PD 24V-PAC
Inline module for distribution of potential (GND)*, connections for GND	R-IB IL PD GND-PAC
Inline counter module*, 1 counter input, 1 control input, 1 output, 24 V DC, 500 mA, 3-wire connection	R-IB IL CNT-PAC
Inline detection terminal for position encoder*, 1 input for incremental encoder with square wave signal (symmetrical or asymmetrical), 3 digital outputs 24 V DC, 3-wire connection	R-IB IL INC-IN-PAC
Inline function module* for pulse widths and frequency modulation or control of step motor servo amplifiers with pulse/direction interface, 2 outputs for 5 V or 24 V	R-IB IL PWM/2-PAC
Inline analog strain gauge input module*, 2 high-speed inputs, 4, 6-wire connection	R-IB IL SGI 2/F-PAC
Inline detection terminal for absolute-value encoder*, 1 input for absolute rotary systems or distance measuring systems with SSI interface	R-IB IL SSI-IN-PAC
Inline positioning module*, 1 absolute-value encoder input, 4 digital inputs 24 V DC, 4 digital outputs 24 V DC, 500 mA, 3-wire connection	R-IB IL SSI-PAC
Ordering data for block I/O modules	
Description	Type code
Inline block I/O digital input/output module*, PROFIBUS, 16 inputs, 24 V DC, 2, 3-wire connection, 16 outputs, 24 V DC, 500 mA, 2, 3-wire connection	R-ILB PB 24 DI16 DO16
Inline block I/O digital input/output module*, sercos III, 16/32 inputs, 24 V DC, 16 outputs, 24 V DC, 500 mA, 2, 3-wire connection	R-ILB S3 24 DI16 DIO16
Inline block I/O analog input/output module*, sercos III, 4 inputs: 0-20 mA, 4-20 mA, ± 20 mA, 0-5 V, ± 5 V, 0-10 V, ± 10 V, Pt 100, Pt 1000, Ni 1000..., 2 outputs: 0-5 V, ± 5 V, 0-10 V, ± 10 V, 0-20 mA, ± 20 mA, 4-20 mA, 2, 3, 4-wire connection	R-ILB S3 AI4 A02
Ordering data for documentation	
Description	Type code
Automation terminals of the Rexroth Inline product range	DOK-CONTRL-ILSYSINS***-AWxx-DE-P

Technical information and data sheets for Rexroth Inline are available from <http://www.boschrexroth.de/mediadirectory>

* Complete with accessories (connection plug and labeling field)

Inline fieldbus coupler

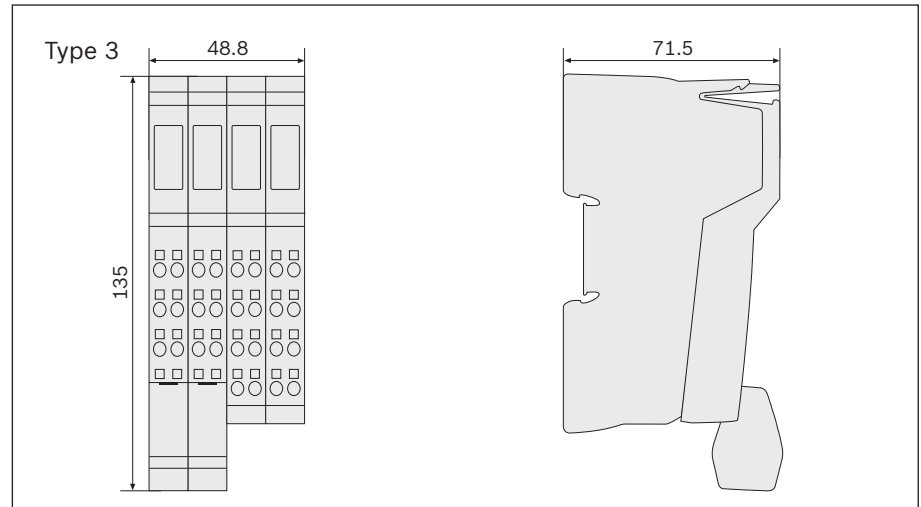
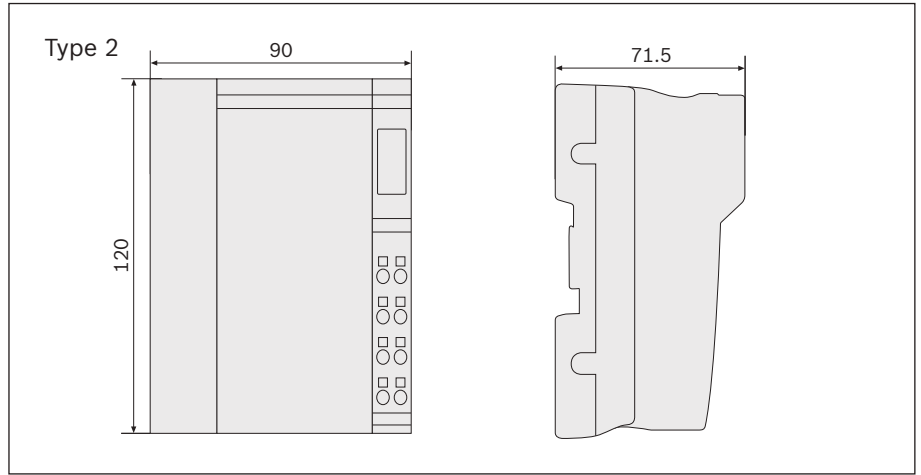
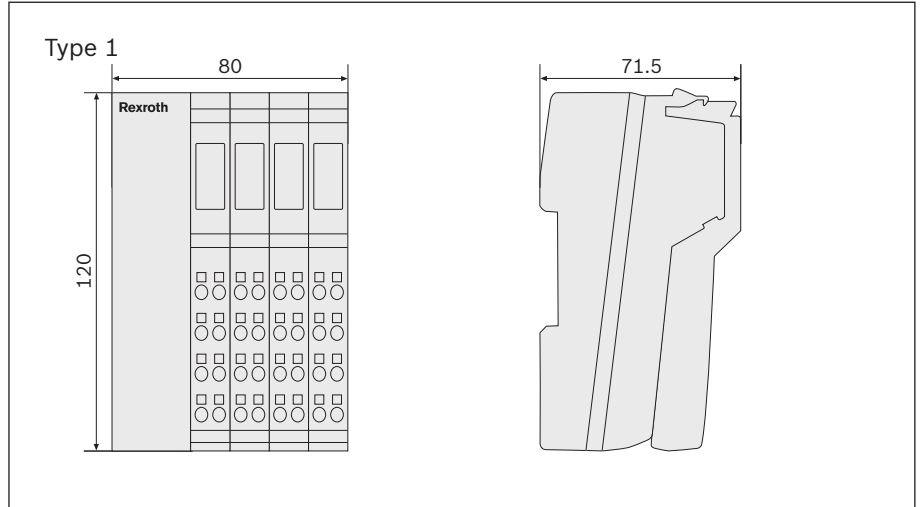

Inline digital modules

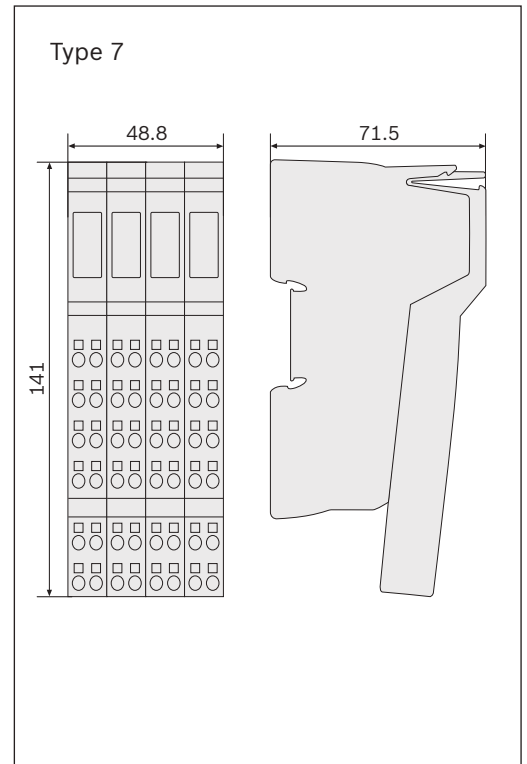
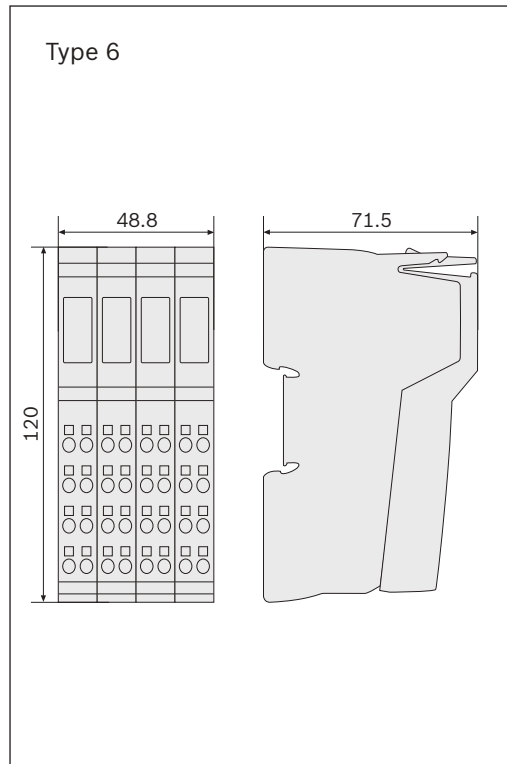
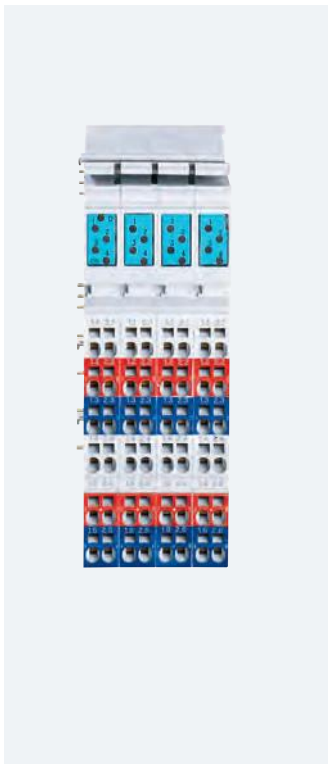
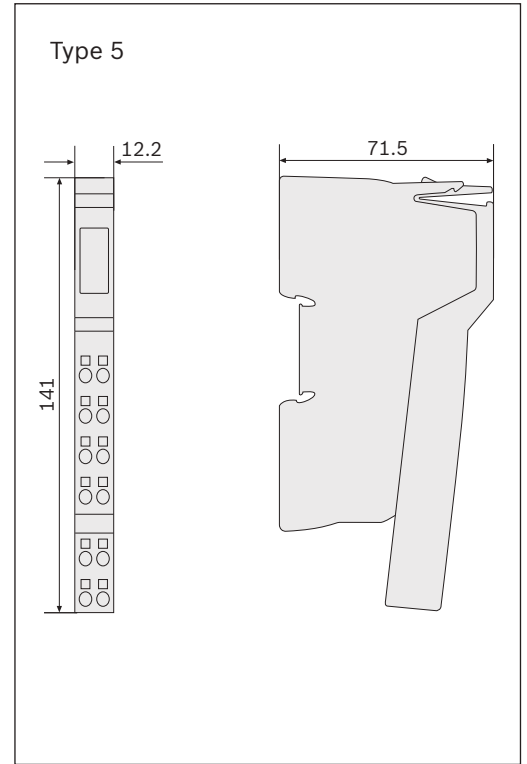
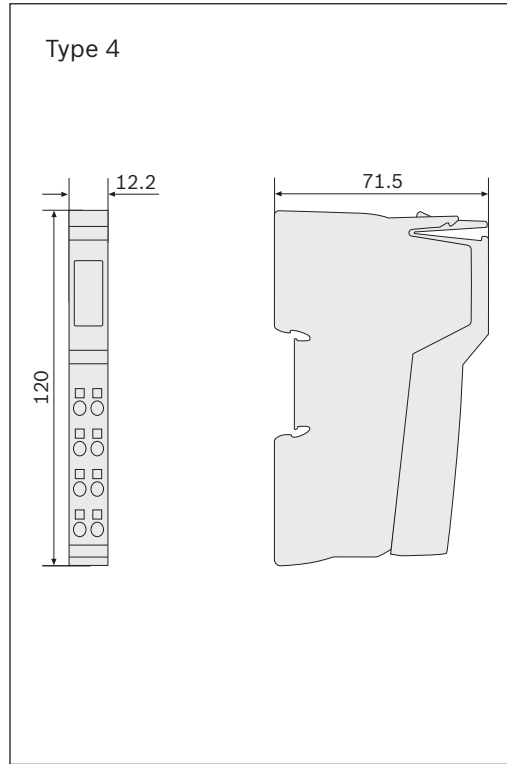

Inline analog, temperature, communication, and function modules

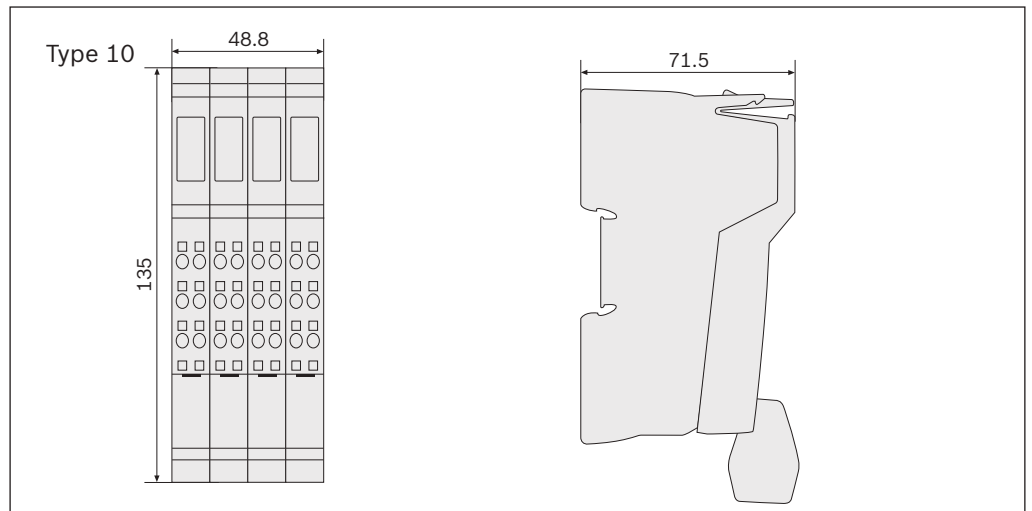
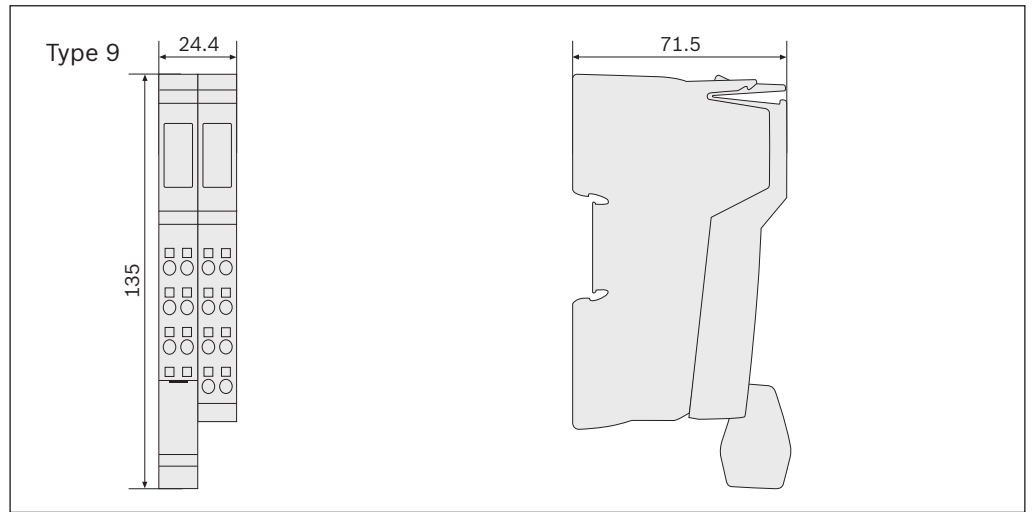
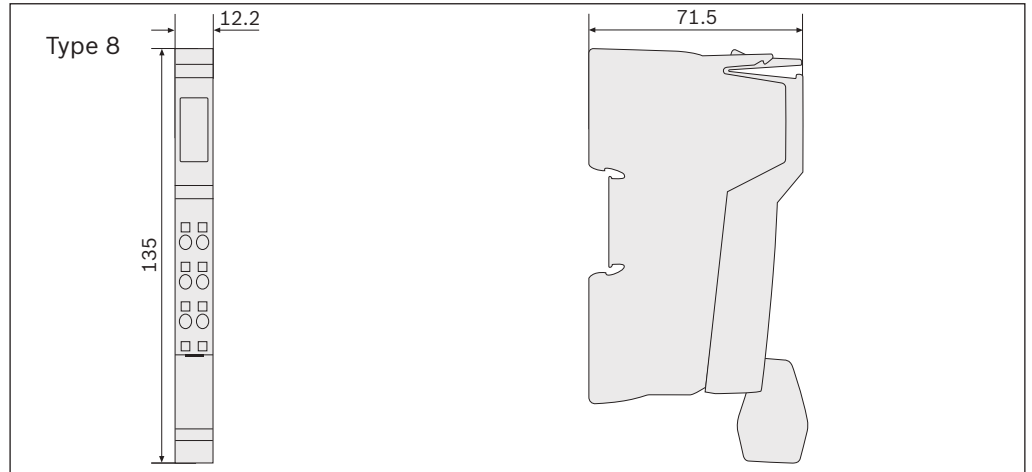

Inline block I/O modules

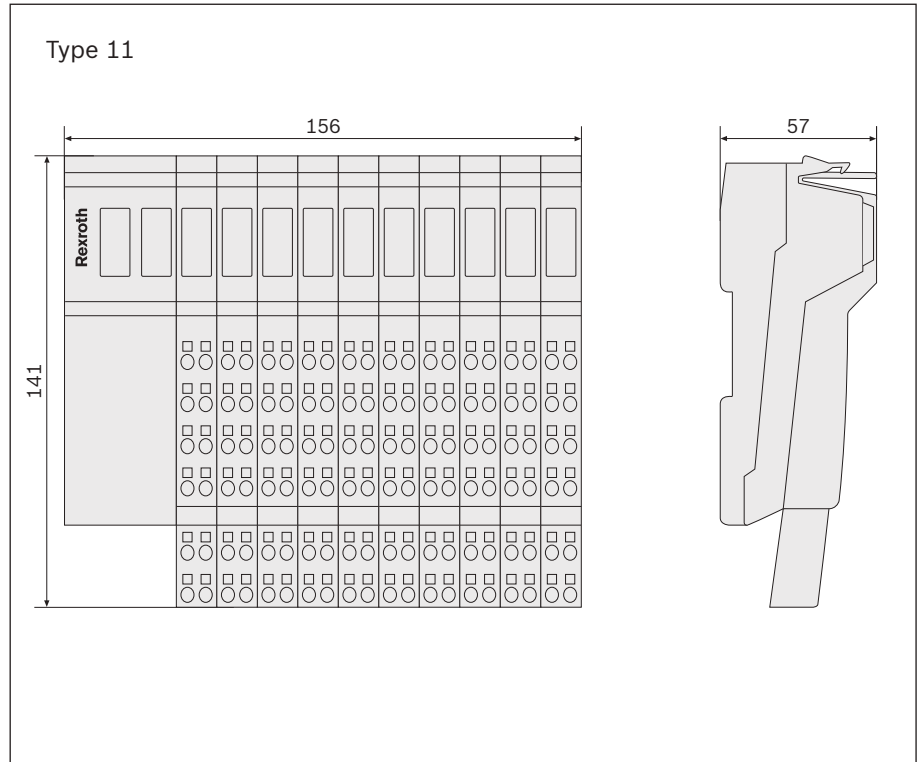

IndraControl S20

The modular IndraControl S20 I/O system in protection category IP20 enables real-time data flow between the control and peripherals.

It links fast sensors and actuators via the system bus and links the bus coupler to the network. The system provides for constant cycle synchronicity of sercos the automation bus, which is a worldwide standard for Ethernet-based real-time communication, or alternatively via PROFINET. Modularly extendable I/O modules only require an update time of 1 μ s each. This reduces update times to a minimum, even with the maximum extension of up to 63 I/O modules per bus coupler. Faster recording and transfer of measurement results improves process control, enabling shorter cycle times and higher precision.

The IndraControl S20 system has been designed for heavy-duty use and tested in comprehensive continuous shock tests. Adjustable filter times improve electromagnetic

compatibility and reduced radiation makes the system future-proof. Cable assembly does not require tools and simplifies wiring and maintenance. In the case of a malfunction, the user can simply remove the plug and exchange the electronics module.

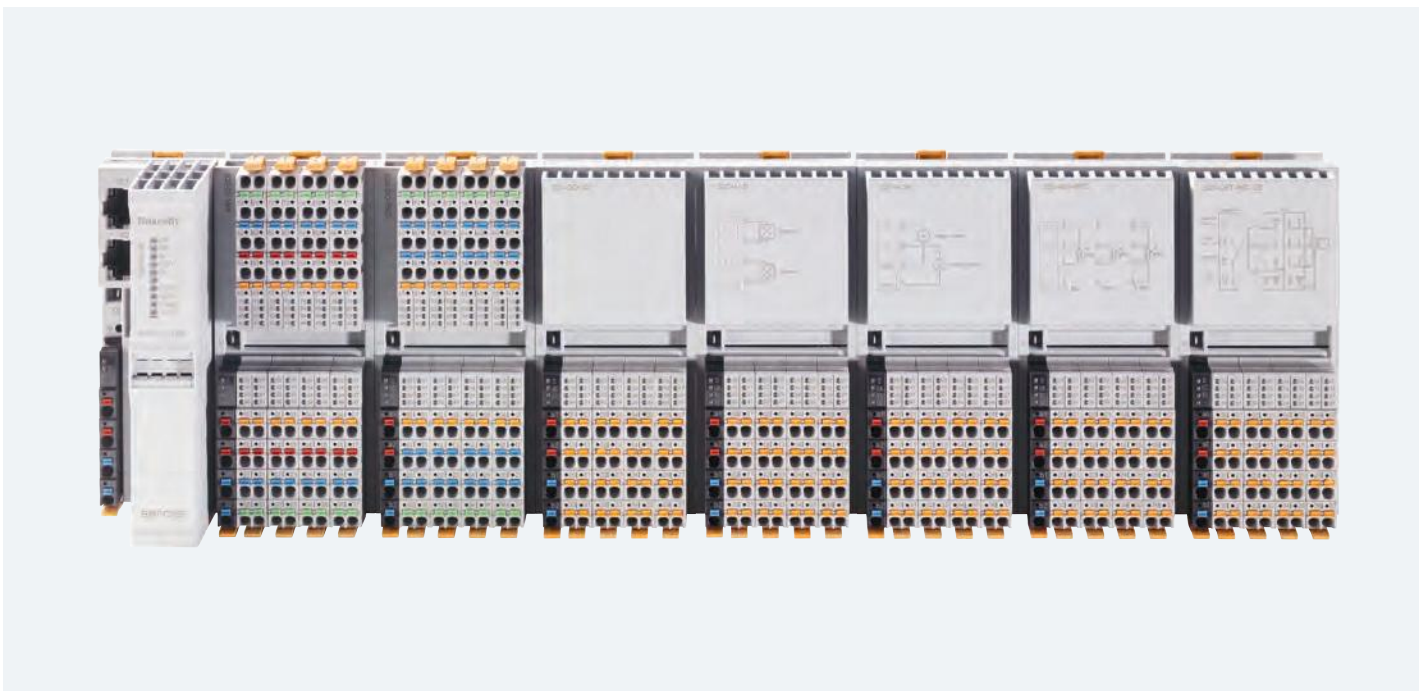

Fast, robust, and simple

- ▶ Reliable measurement of time-critical signals
- ▶ Extremely robust design and mechanics
- ▶ Easy to handle



Fieldbus coupler



Fieldbus couplers – for connecting as the first module in an IndraControl S20 station and as an interface to the fieldbus system. The various I/O modules can be directly connected to the fieldbus couplers.

Digital I/O modules

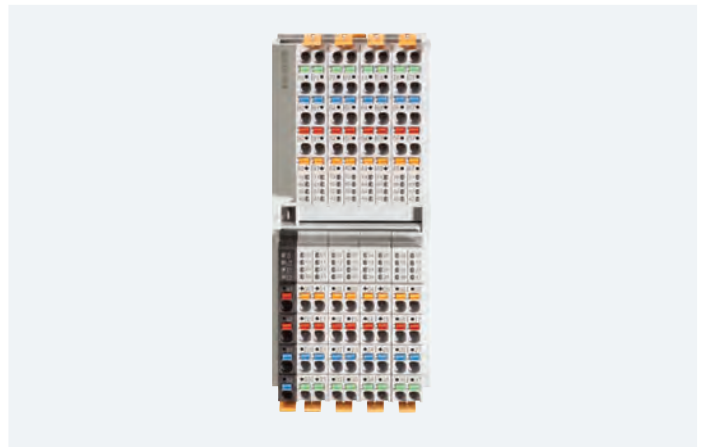

Digital I/O modules – for connection of digital signals from pushbuttons, limit switches, or proximity switches.

Analog I/O modules

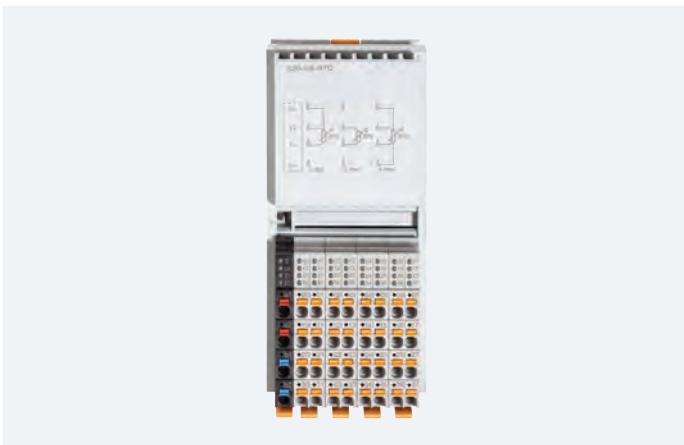

Analog I/O modules – for acquiring and outputting analog signals from standard sensors and analog actuators.

Function modules

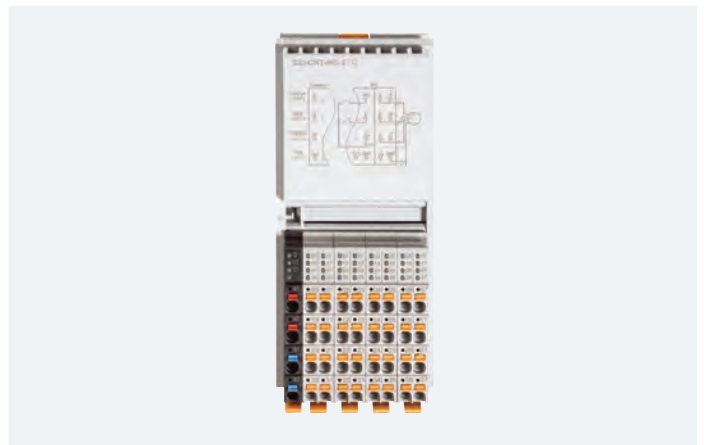

Function modules – for solving special tasks, for example fast counting forwards/backwards, incremental recording.

General technical data

Ambient conditions		
Temperature range (operation)	-25°C to +60°C	
Relative humidity (operation)	5 to 95% (no dewing)	
Vibration	5 g acc. to EN 60068-2-6	
Shock	25 g acc. to EN 60062-2-27	
Continuous shock	10 g acc. to EN 60068-2-29	
Protection category	IP20	
Electromagnetic compatibility		
Interference emission	Class B acc. to EN 61000-6-3	
Interference immunity	Acc. to EN 61000-4	
Supply voltage		
Nominal value	24 V DC	
Ripple	±5% acc. to EN 61131-2	
Permissible range	19.2 to 30.0 V	
System data		
System bus cycle time	2 µs	
Offset per module	1 µs	
Connection		
Connection type	Direct-plug spring-force connection	
Connection data	Rigid	0.2–1.5 mm ²
	Flexible	0.2–1.5 mm ²
	AWG	24–16

Fieldbus coupler – technical data

	S20-PN-BK	S20-S3-BK
Interfaces		
Fieldbus system	PROFINET-IO	sercos
Connection type	RJ45 socket autonegotiation and autocrossing	RJ45 socket autonegotiation and autocrossing
Number	2	2
Transmission speed	100 Mbit/s (full-duplex)	100 Mbit/s (full-duplex)
Transmission length	Max. 100 m	Max. 100 m
PROFINET-IO		
Device function	PROFINET-IO device	sercos
Update rate	250 μ s	250 μ s
Local bus interface		
Designation	Axio bus	Axio bus
Connection type	Connection for bus socket module	Connection for bus socket module
Transmission speed	100 Mbit/s	100 Mbit/s
Number of supported segments	Max. 63 (per station)	Max. 63 (per station)
Module electronics supply		
Logic voltage supply U_L	24 V DC	24 V DC
Maximum permissible voltage range	19.2 to 30 V DC (including all tolerances, including ripple)	19.2 to 30 V DC (including all tolerances, including ripple)
Logic voltage U_{BUS}	5 V DC (via bus socket module)	5 V DC (via bus socket module)
Power supply at U_{BUS}	2 A	2 A
Protective circuit	Overvoltage protection for supply voltage Reverse polarity protection for supply voltage	Overvoltage protection for supply voltage Reverse polarity protection for supply voltage
Mechanical data		
Dimensions (W x H x D)	40 x 123.6 x 75 mm	40 x 123.6 x 75 mm
Dimensional drawing (see p. 186)	Type 1	Type 1
Weight	173 g	173 g

Digital inputs – technical data

	S20-DI-16/4	S20-DI-32/1
Local bus interface		
Designation	Axio bus	Axio bus
Connection type	Bus socket module	Bus socket module
Module electronics supply		
Logic voltage U_{BUS}	5 V DC (via bus socket module)	5 V DC (via bus socket module)
Power consumption from U_{BUS}	120 mA	120 mA
Peripherals supply		
Digital input module supply U_i	24 V DC	24 V DC
Maximum permissible voltage range	19.2 to 30 V DC including all tolerances, including ripple	19.2 to 30 V DC including all tolerances, including ripple
Power consumption from U_i	Max. 4 A (2 A per group of eight inputs)	Max. 4 A (2 A per group of eight inputs)
Protective circuit	Overvoltage protection for supply voltage Reverse polarity protection for supply voltage	Overvoltage protection for supply voltage Reverse polarity protection for supply voltage
Digital inputs		
Connection technique	2, 3, 4-wire	1-wire
Number of inputs	16	32
Input description	EN 61131-2, Type 1 and 3	EN 61131-2, Type 1 and 3
Nominal input voltage U_{IN}	24 V DC	24 V DC
Nominal input current at U_{IN}	2.4 mA	2.4 mA
Input filter time	500 μs (default)	3000 μs (default)
		1000 μs
	<100 μs	<100 μs
Protective circuit	Input reverse polarity protection	Input reverse polarity protection
Mechanical data		
Dimensions (W x H x D)	53.6 x 129.9 x 51.4 mm	53.6 x 129.9 x 51.4 mm
Dimensional drawing (see p. 187)	Type 2	Type 3
Weight	231 g	167 g

Digital outputs – technical data

	S20-DO-16/3	S20-DO-32/1
Local bus interface		
Designation	Axio bus	Axio bus
Connection type	Bus socket module	Bus socket module
Module electronics supply		
Logic voltage U_{BUS}	5 V DC (via bus socket module)	5 V DC (via bus socket module)
Power consumption from U_{BUS}	120 mA	120 mA
Peripherals supply		
Digital output module supply U_o	24 V DC	24 V DC
Maximum permissible voltage range	19.2 to 30 V DC including all tolerances, including ripple	19.2 to 30 V DC including all tolerances, including ripple
Power consumption from U_o	8 A	16 A
Protective circuit	Overvoltage protection for supply voltage Reverse polarity protection for supply voltage	Overvoltage protection for supply voltage Reverse polarity protection for supply voltage
Digital outputs		
Connection technique	2, 3-wire	1-wire
Number of outputs	16	32
Output voltage	24 V DC	24 V DC
Maximum output current per channel	500 mA	500 mA
Maximum output current per module	8 A	16 A
Overload behavior	Switch off with automatic restart	Switch off with automatic restart
Protective circuit	Short-circuit protection, overload protection of the outputs	Short-circuit protection, overload protection of the outputs
Mechanical data		
Dimensions (W x H x D)	53.6 x 129.9 x 51.4 mm	53.6 x 129.9 x 51.4 mm
Dimensional drawing (see p. 187)	Type 2	Type 3
Weight	234 g	209 g

Analog inputs – technical data

S20-AI-8	
Local bus interface	
Designation	Axio bus
Connection type	Bus socket module
Module electronics supply	
Logic voltage U_{BUS}	5 V DC (via bus socket module)
Power consumption from U_{BUS}	130 mA
Peripherals supply	
Analog module supply U_A	24 V DC
Maximum permissible voltage range	19.2 to 30 V DC including all tolerances, including ripple
Protective circuit	Overvoltage protection, reverse polarity protection, transient protection
Analog inputs	
Connection technique	2-wire (shielded, twisted in pairs)
Number of inputs	8 (differential inputs, either voltage or current may be selected)
Voltage input signal	0 to 5 V, -5 to 5 V, 0 to 10 V, ± 10 V
Current input signal	0 to 20 mA, 4 to 20 mA, ± 20 mA
Characteristic values	
Measurement representation	16 bits (15 bits + sign bit)
Input filter	30 Hz, 12 kHz and averaging (configurable)
Accuracy	0.1% (of measurement range and value with active averaging and 30 Hz filter)
Mechanical data	
Dimensions (W x H x D)	53.6 x 129.9 x 51.4 mm
Dimensional drawing (see p. 187)	Type 3
Weight	204 g

Analog outputs – technical data

S20-AO-8	
Local bus interface	
Designation	Axio bus
Connection type	Bus socket module
Module electronics supply	
Logic voltage U_{BUS}	5 V DC (via bus socket module)
Power consumption from U_{BUS}	130 mA
Peripherals supply	
Analog module supply U_A	24 V DC
Maximum permissible voltage range	19.2 to 30 V DC including all tolerances, including ripple
Protective circuit	Overvoltage protection, reverse polarity protection, transient protection
Analog outputs	
Connection technique	2-wire (shielded, twisted in pairs)
Number of outputs	8 (differential inputs, either voltage or current may be selected)
Voltage output signal	0 to 5 V, -5 to 5 V, 0 to 10 V, ± 10 V
Current output signal	0 to 20 mA, 4 to 20 mA, ± 20 mA
Load impedance	500 Ω
Characteristic values	
Measurement representation	16 bits (15 bits + sign bit)
Accuracy	0.1% (of output range end value)
Mechanical data	
Dimensions (W x H x D)	53.6 x 129.9 x 51.4 mm
Dimensional drawing (see p. 187)	Type 3
Weight	260 g

Temperature module – technical data

S20-AI-8-RTD	
Local bus interface	
Designation	Axio bus
Connection type	Bus socket module
Module electronics supply	
Logic voltage U_{BUS}	5 V DC (via bus socket module)
Power consumption from U_{BUS}	180 mA
Peripherals supply	
Analog module supply U_A	24 V DC
Maximum permissible voltage range	19.2 to 30 V DC including all tolerances, including ripple
Protective circuit	Overvoltage protection, reverse polarity protection, transient protection
Analog inputs	
Connection technique	2, 3, 4-wire (shielded, twisted in pairs)
Number of outputs	8 (for resistive temperature sensors)
Protective circuit	Short-circuit protection, overload protection of the inputs, transient protection of the inputs, transient protection of the sensor supplies
Compatible sensor types	Pt, Ni, KTY, Cu sensors
Linear resistance range	500 Ω , 5 k Ω
Characteristic values	
Measurement representation	16 bits (15 bits + sign bit)
Input filter time	40 ms/60 ms/100 ms/120 ms (configurable)
Accuracy	Typ. ± 0.1 K (Pt100 in 3-wire connection)
Mechanical data	
Dimensions (W x H x D)	53.6 x 129.9 x 51.4 mm
Dimensional drawing (see p. 187)	Type 3
Weight	197 g

Technology module – technical data

S20-CNT-INC-2/2	
Local bus interface	
Designation	Axio bus
Connection type	Bus socket module
Module electronics supply	
Logic voltage U_{BUS}	5 V DC (via bus socket module)
Power consumption from U_{BUS}	100 mA
Peripherals supply	
Analog module supply U_A	24 V DC
Maximum permissible voltage range	19.2 to 30 V DC including all tolerances, including ripple
Protective circuit	Overvoltage protection, reverse polarity protection, transient protection
Counter inputs	
Number of inputs	2 (S1, S2)
Input frequency	Max. 300 kHz/150 kHz (dependent on the circuit)
Input voltage	24 V DC
Encoder inputs	
Number of inputs	2 (A1, /A1, B1, /B1, Z1, /Z1; A2, /A2, B2, /B2, Z2, /Z2)
Encoder signals	Symmetrical and asymmetrical encoders
Input frequency	Max. 300 kHz/150 kHz (dependent on the circuit)
Digital inputs	
Connection technique	1-wire
Number of inputs	8
Input description	EN 61131-2 type 3
Nominal input voltage U_{IN}	24 V DC
Nominal input current at U_{IN}	2.5 mA (per channel)
Digital outputs	
Connection technique	1-wire
Number of outputs	2
Output voltage	24 V DC
Maximum output current per channel	500 mA
Protective circuit	Short-circuit protection, overload protection of the outputs
Mechanical data	
Dimensions (W x H x D)	53.6 x 129.9 x 51.4 mm
Dimensional drawing (see p. 187)	Type 3
Weight	205 g

IndraControl S20 – ordering data

Description	Type code
IndraControl S20 PROFINET IO bus coupler (incl. connection plug)	S20-PN-BK
IndraControl S20 sercos bus coupler (incl. connection plug)	S20-S3-BK
IndraControl S20 digital input module, 16 inputs, 24 V DC, 2, 3, 4-wire connection (incl. bus socket module and plugs)	S20-DI-16/4
IndraControl S20 digital input module, 32 inputs, 24 V DC, 1-wire connection (incl. bus socket module and plugs)	S20-DI-32/1
IndraControl S20 digital output module, 16 outputs 24 V DC, 2, 3-wire connection (incl. bus socket module and plugs)	S20-DO-16/3
IndraControl S20 digital output module, 32 outputs 24 V DC, 1-wire connection (incl. bus socket module and plugs)	S20-DO-32/1
IndraControl S20 analog input module, 8 inputs: 0-10 V, ± 10 V, 0-20 mA, 4-20 mA, ± 20 mA, 2-wire connection (incl. bus socket module and plugs)	S20-AI-8
IndraControl S20 analog output module, 8 outputs: 0-10 V, ± 10 V, 0-5 V, ± 5 V, 0-20 mA, 4-20 mA, ± 20 mA, 2-wire connection (incl. bus socket module and plugs)	S20-AO-8
IndraControl S20 temperature module, 8 inputs for connecting resistance temperature detectors (RTD) (incl. bus socket module and plugs)	S20-AI-8-RTD
IndraControl S20 technology module, 2 counter inputs, 2 incremental-value encoder inputs (incl. bus socket module and plugs)	S20-CNT-INC-2/2
IndraControl S20 bus socket module	S20-BS

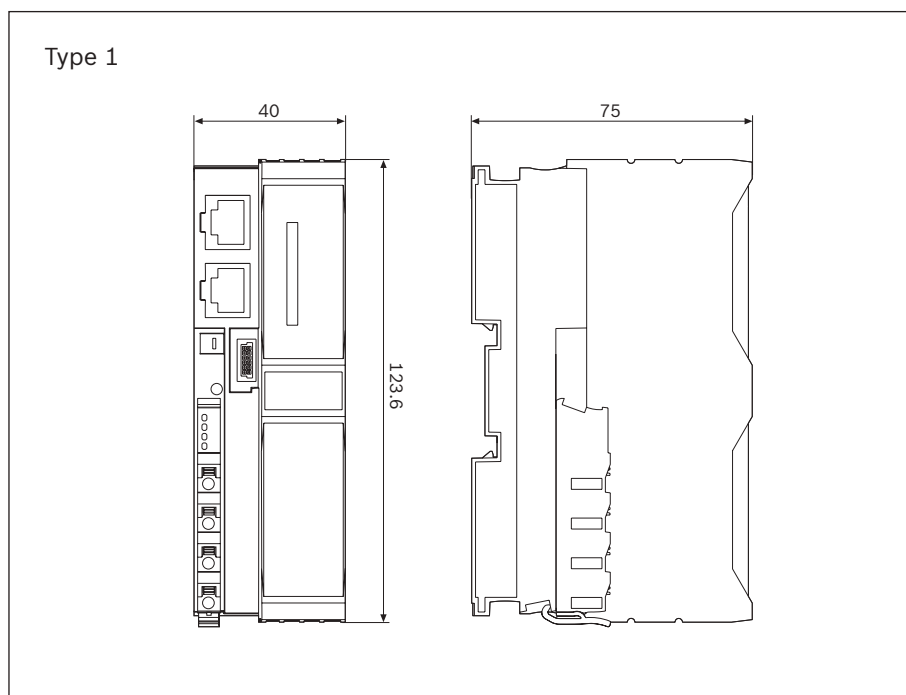

IndraControl S20

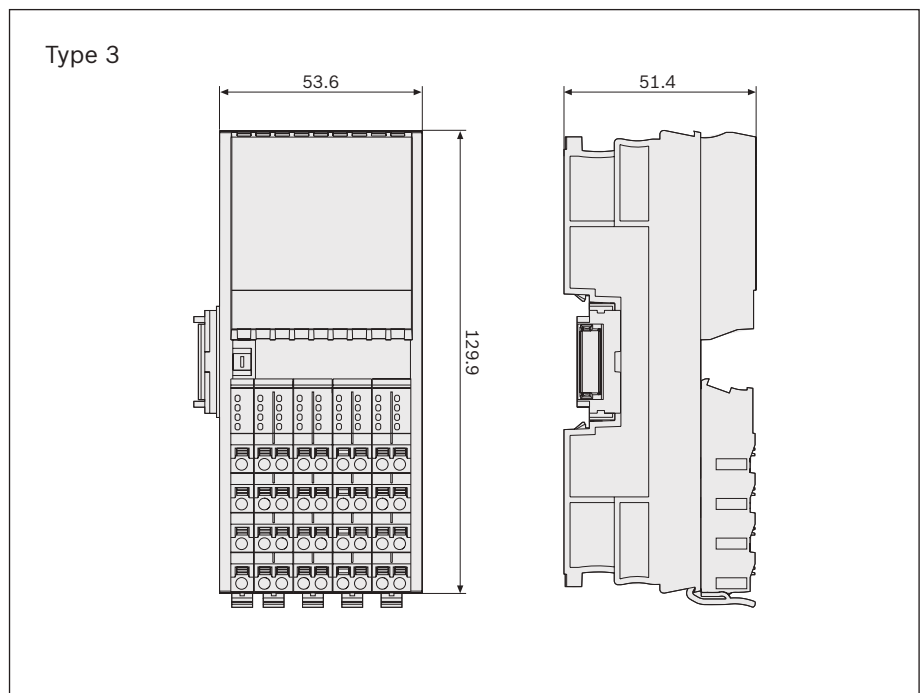
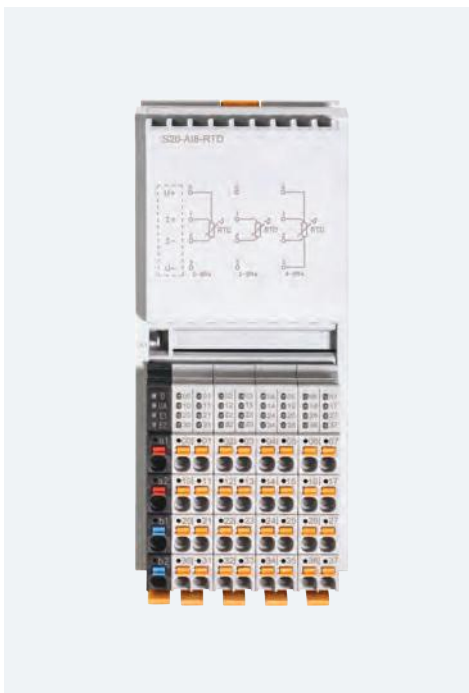
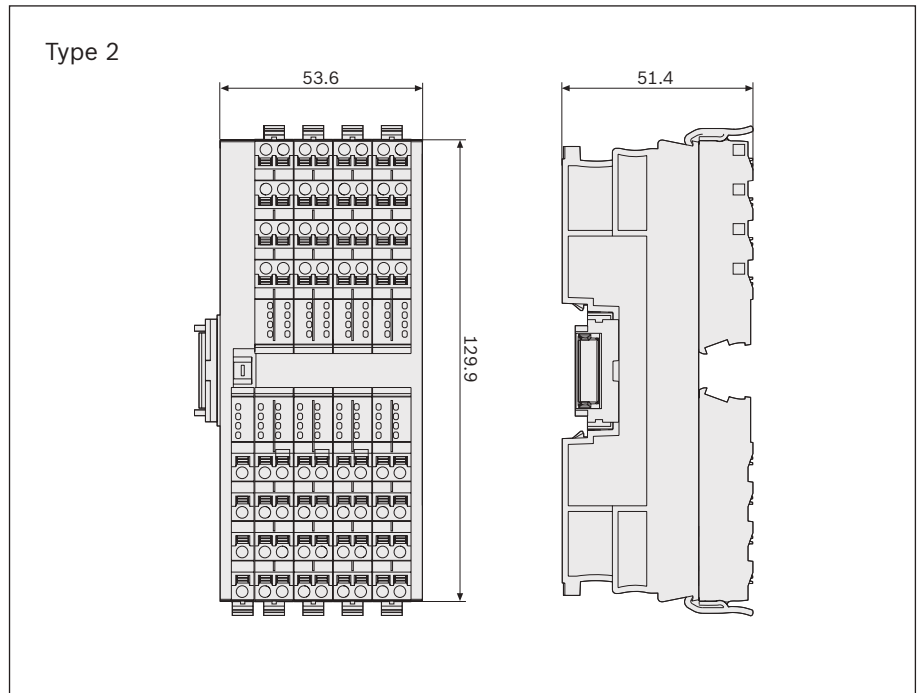
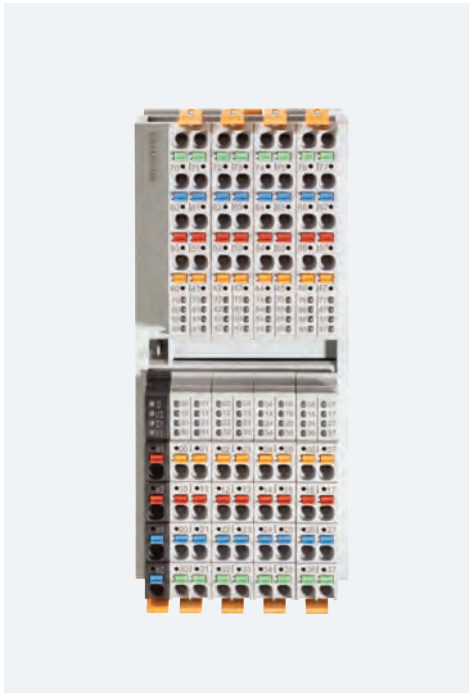

IndraControl S67 – fast I/O system for cabinet-free automation

The IndraControl S67 enables cabinet-free installation near the machine and is suitable for use in harsh environments. The modular I/O modules provide for ultra-high flexibility and economic realization of customized machine concepts. Its high performance makes the IndraControl S67 ideal for the reliable acquisition of time-critical signals.

With IP67 protection, the IndraControl S67 is also very well suited to harsh industrial environments. The system is modular in design so that it can be optimally adapted to a wide range of applications; up to 64 I/O modules can be operated from a single fieldbus coupler. Highly accurate, synchronous acquisition and processing of signals ensure sufficient reserve capacity for motion control applications and fast signal acquisition. Comprehensive parameterization and diagnostic functions, fast, easy installation, and M12 and M8 connection technique round out the system.

Your benefits

- ▶ Extremely fast cycle times thanks to optimized data transmission
- ▶ Highly reliable operation under extreme ambient conditions
- ▶ Modular and individually extendable
- ▶ Extendable to 500 m per I/O station
- ▶ Flexible installation
- ▶ M12 and M8 connection technique in compact housing design
- ▶ Simple operation and application
- ▶ Comprehensive diagnostic options



IndraControl S67 – for reliable acquisition of time-critical signals directly at the machine

Fast, modular, and robust

- ▶ Reliable acquisition of time-critical signals
- ▶ Modular and individually extendable system structure
- ▶ High level of protection for application in harsh industrial environments



Fieldbus coupler

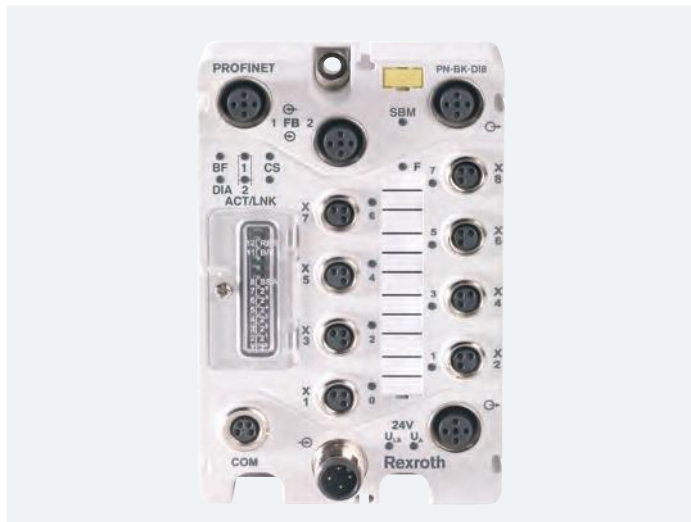

Fieldbus coupler – for connecting local I/O modules to a higher-level fieldbus system.

Digital I/O modules



Digital I/O modules – for acquiring and outputting digital signals, e.g. for buttons, limit or proximity switches.

Analog I/O modules



Analog I/O modules – for acquiring and outputting analog signals for standard sensors, e.g. temperature or pressure sensors.

Feed modules

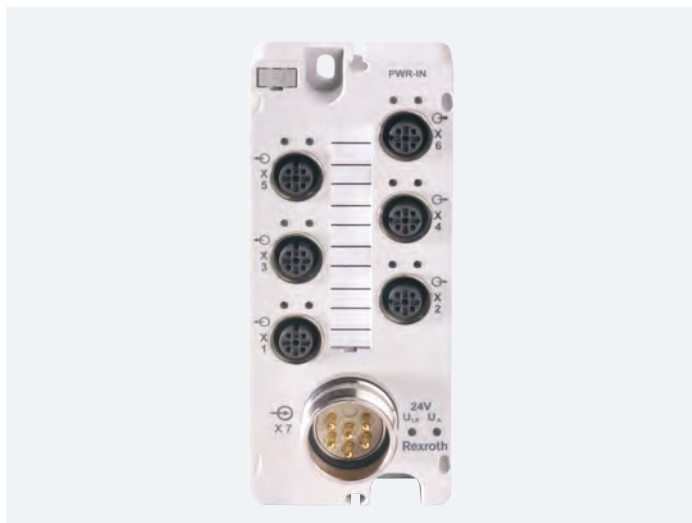

Feed modules – for supplying IndraControl S67 components for extensive overall extension of the system.

Fieldbus coupler – technical data

Technical data	S67-PB-BK-DI8-M8	S67-PN-BK-DI8-M8
Fieldbus coupler		
Type	PROFIBUS	PROFINET IO
Connection type	M12 connectors, B-coded, 5-pin	M12 connectors, D-coded, 5-pin
Transmission speed	12 Mbit/s (automatic recognition)	100 Mbit/s
Transmission medium	Copper cable	Copper cable
Digital inputs		
Number of inputs	8	8
Connection type	M8 connectors, A-coded, 3-pin	M8 connectors, A-coded, 3-pin
Connection technique	2 to 3-wire	2 to 3-wire
Input filter	Configurable	Configurable
Input characteristic	Type 1, acc. to IEC 61131-2	Type 1, acc. to IEC 61131-2
Signal voltage (0)	-30 to +5 V DC	-30 to +5 V DC
Signal voltage (1)	+11 to +30 V DC	+11 to +30 V DC
Input circuit	High-side switching	High-side switching
Input voltage	24 V DC (-30 < U _{IN} < +30 V DC)	24 V DC (-30 < U _{IN} < +30 V DC)
Input current	Typ. 2.8 mA	Typ. 2.8 mA
Cable length, unshielded	≤ 30 m	≤ 30 m
Module supply		
Connection type	M12 connectors, A-coded, 4-pin	M12 connectors, A-coded, 4-pin
Current carrying capacity of supply connections	Max. 8 A (U _{LS} : 4 A, U _A : 4 A)	Max. 8 A (U _{LS} : 4 A, U _A : 4 A)
Supply voltage	Logic and sensor voltage U _{LS}	24 V DC (-25 to +30%)
	Actuator voltage U _A	24 V DC (-25 to +30%)
Supply current	Logic and sensor current I _{LS}	Typ. 45 mA + sensors (max. 400 mA)
	Actuator current I _A	5 mA
Protection	Reverse polarity protection for U _{LS} + U _A Short-circuit protection for sensor supply	Reverse polarity protection for U _{LS} + U _A Short-circuit protection for sensor supply
System bus		
Number of extendable modules	63	63
Connection type	M12 connectors, B-coded, 5-pin, shielded	M12 connectors, B-coded, 5-pin, shielded
Electrical isolation		
Channel – channel	No	No
U _{LS} , U _A , system bus	500 V DC each	500 V DC each
Service interface		
Type	USB	USB
Connection type	M8 connectors, 4-pin	M8 connectors, 4-pin
Configurable functions/digital inputs		
Input filter (per channel)	0.1/0.5/3/15/20 ms/filter off	0.1/0.5/3/15/20 ms/filter off
Online simulation (per channel)	Lock/unlock; simulation value: 0/1	Lock/unlock; simulation value: 0/1
Diagnosis (per module)	Overload and short circuit (sensor supply); undervoltage (U _{LS} + U _A)	Overload and short circuit (sensor supply); undervoltage (U _{LS} + U _A)
Process image		
Input process image	244 bytes	512 bytes
Output process image	244 bytes	512 bytes
Ambient conditions		
Permissible temperature (operation)	-25 to +60°C	-25 to +60°C
Permissible relative humidity (operation)	5 to 95%, no dewing	5 to 95%, no dewing
Permissible air pressure (operation)	795 to 1,080 hPa	795 to 1,080 hPa
Mechanical data		
Dimensions (W x H x D)	75 x 117 x 35 mm	75 x 117 x 35 mm
Dimensional drawing (see p. 201)	Type 1	Type 1
Weight	330 g	330 g
Vibration resistance	According to IEC 60068-2-6	According to IEC 60068-2-6
Shock resistance (temporary)	According to IEC 60068-2-27	According to IEC 60068-2-27

Technical data	S67-S3-BK-DI8-M8	S67-ET-BK-DI8-M8
Fieldbus coupler		
Type	sercos	EtherNet/IP
Connection type	M12 connectors, B-coded, 5-pin	M12 connectors, D-coded, 5-pin
Transmission speed	12 Mbit/s (automatic recognition)	10/100 Mbit/s
Transmission medium	Copper cable	Copper cable
Digital inputs		
Number of inputs	8	8
Connection type	M8 connectors, A-coded, 3-pin	M8 connectors, 3-pin
Connection technique	2 to 3-wire	2 to 3-wire
Input filter	Configurable	Configurable
Input characteristic	Type 1, acc. to IEC 61131-2	Type 1, acc. to IEC 61131-2
Signal voltage (0)	-30 to +5 V DC	-30 to +5 V DC
Signal voltage (1)	+11 to +30 V DC	+15 to +30 V DC
Input circuit	High-side switching	High-side switching
Input voltage	24 V DC (-30 < U _N < +30 V DC)	24 V DC (-30 < U _N < +30 V DC)
Input current	Typ. 2.8 mA	Typ. 2.8 mA
Cable length, unshielded	≤ 30 m	≤ 30 m
Module supply		
Connection type	M12 connectors, A-coded, 4-pin	M12 connectors, A-coded, 4-pin
Current carrying capacity of supply connections	Max. 8 A (U _{LS} : 4 A, U _A : 4 A)	Max. 8 A (U _{LS} : 4 A, U _A : 4 A)
Supply voltage	Logic and sensor voltage U _{LS}	24 V DC (-25 to +30%)
	Actuator voltage U _A	24 V DC (-25 to +30%)
Supply current	Logic and sensor current I _{LS}	Typ. 45 mA + sensors (max. 400 mA)
	Actuator current I _A	5 mA
Protection	Reverse polarity protection for U _{LS} + U _A Short-circuit protection for sensor supply	Reverse polarity protection for U _{LS} + U _A Short-circuit protection for sensor supply
System bus		
Number of extendable modules	63	64
Connection type	M12 connectors, B-coded, 5-pin, shielded	M12 connectors, B-coded, 5-pin, shielded
Electrical isolation		
Channel – channel	No	No
U _{LS} , U _A system bus	500 V DC each	500 V DC each
Service interface		
Type	USB	USB
Connection type	M8 connectors, 4-pin	M8 connectors, 4-pin
Configurable functions/digital inputs		
Input filter (per channel)	0.1/0.5/3/15/20 ms/filter off	0.1/0.5/3/15/20 ms/filter off
Online simulation (per channel)	Lock/unlock; simulation value: 0/1	Lock/unlock; simulation value: 0/1
Diagnosis (per module)	Overload and short circuit (sensor supply); undervoltage (U _{LS} + U _A)	Short circuit/wire break (sensor supply); undervoltage (U _{LS} + U _A)
Process image		
Input process image	244 bytes	2048 bytes
Output process image	244 bytes	2048 bytes
Ambient conditions		
Permissible temperature (operation)	-25 to +60°C	-25 to +60°C
Permissible relative humidity (operation)	5 to 95%, no dewing	5 to 95%, no dewing
Permissible air pressure (operation)	795 to 1,080 hPa	795 to 1,080 hPa
Mechanical data		
Dimensions (W x H x D)	75 x 117 x 35 mm	75 x 35.7 x 117
Dimensional drawing (see p. 201)	Type 1	Type 1
Weight	330 g	330 g
Vibration resistance	According to IEC 60068-2-6	According to IEC 60068-2-6
Shock resistance (temporary)	According to IEC 60068-2-27	According to IEC 60068-2-27

Digital inputs – technical data

Technical data		S67-DI8-M8
Digital inputs		
Number of inputs		8
Connection type		M12 connectors, A-coded, 3-pin
Connection technique		2 to 3-wire
Input filter		Configurable
Input characteristic		Type 2, acc. to IEC 61131-2
Signal voltage (0)		-30 to +5 V DC
Signal voltage (1)		+11 to +30 V DC
Input circuit		High-side switching
Input voltage		24 V DC ($-30 < U_{IN} < +30$ V DC)
Input current		Typ. 7.3 mA
Cable length, unshielded		≤ 30 m
Module supply		
Connection type		M12 connectors, A-coded, 4-pin
Current carrying capacity of supply connections		Max. 8 A (U_{LS} : 4 A, U_A : 4 A)
Supply voltage	Logic and sensor voltage U_{LS}	24 V DC
	Actuator voltage U_A	24 V DC
Supply current	Logic and sensor current I_{LS}	Typ. 40 mA + sensors (max. 400 mA)
	Actuator current I_A	5 mA
Protection		Reverse polarity protection for $U_{LS} + U_A$ Short-circuit protection for sensor supply
System bus		
Connection type		M12 connectors, B-coded, 5-pin, shielded
Electrical isolation		
Channel – channel		No
U_{LS} , U_A , system bus		500 V DC each
Configurable functions		
Input filter (per channel)		0.1/0.5/3/15/20 ms/filter off
Online simulation (per channel)		Lock/unlock; simulation value: 0/1
Diagnosis (per module)		Overload and short circuit (sensor supply); undervoltage ($U_{LS} + U_A$)
Process image		
Process data width		1 byte data + status
Ambient conditions		
Permissible temperature (operation)		-25 to +60°C
Permissible relative humidity (operation)		5 to 95%, no dewing
Permissible air pressure (operation)		795 to 1,080 hPa
Mechanical data		
Dimensions (W x H x D)		50 x 117 x 35 mm
Dimensional drawing (see p. 201)		Type 2
Weight		230 g
Vibration resistance		According to IEC 60068-2-6
Shock resistance (temporary)		According to IEC 60068-2-27

Technical data		S67-DI8-M12
Digital inputs		
Number of inputs		4
Connection type		M12 connectors, A-coded, 3-pin
Connection technique		2 to 3-wire
Input filter		Configurable
Input characteristic		Type 2, acc. to IEC 61131-2
Signal voltage (0)		-30 to +5 V DC
Signal voltage (1)		+11 to +30 V DC
Input circuit		High-side switching
Input voltage		24 V DC ($-30 < U_{IN} < +30$ V DC)
Input current		Typ. 7.3 mA
Cable length, unshielded		≤ 30 m
Module supply		
Connection type		M12 connectors, A-coded, 4-pin
Current carrying capacity of supply connections		Max. 8 A (U_{LS} : 4 A, U_A : 4 A)
Supply voltage	Logic and sensor voltage U_{LS}	24 V DC
	Actuator voltage U_A	24 V DC
Supply current	Logic and sensor current I_{LS}	Typ. 40 mA + sensors (max. 400 mA)
	Actuator current I_A	5 mA
Protection		Reverse polarity protection for U_{LS} + U_A Short-circuit protection for sensor supply
System bus		
Connection type		M12 connectors, B-coded, 5-pin, shielded
Electrical isolation		
Channel – channel		No
U_{LS} , U_A , system bus		500 V DC each
Configurable functions		
Input filter (per channel)		0.1/0.5/3/15/20 ms/filter off
Online simulation (per channel)		Lock/unlock; simulation value: 0/1
Diagnosis (per module)		Overload and short circuit (sensor supply); undervoltage (U_{LS} + U_A)
Process image		
Process data width		1 byte data + status
Ambient conditions		
Permissible temperature (operation)		-25 to +60°C
Permissible relative humidity (operation)		5 to 95%, no dewing
Permissible air pressure (operation)		795 to 1,080 hPa
Mechanical data		
Dimensions (W x H x D)		50 x 117 x 35 mm
Dimensional drawing (see p. 201)		Type 2
Weight		230 g
Vibration resistance		According to IEC 60068-2-6
Shock resistance (temporary)		According to IEC 60068-2-27

Digital outputs – technical data

Technical data	S67-DO8-M8	S67-DO8-M12
Digital outputs		
Number of outputs	8	8
Connection type	M8 connectors, 3-pin	M12 connectors, 3-pin
Connection technique	2 to 3-wire	2 to 3-wire
Output voltage	$\leq U_A$	$\leq U_A$
Output current (per channel)	0.5 A (max. 0.6 A), short-circuit/overload proof (thermal disconnection)	0.5 A (max. 0.6 A), short-circuit/overload proof (thermal disconnection)
Voltage drop against U_A at 500 mA	Max. 0.2 V DC	Max. 0.2 V DC
Output current (module)	Max. 4 A	Max. 4 A
Switching-on of overload circuit	Configurable	Configurable
Leak current when off	Typ. 150 μ A	Typ. 150 μ A
Output circuit	High-side switching	High-side switching
Module supply		
Connection type	M12 connectors, A-coded, 4-pin	M12 connectors, A-coded, 4-pin
Current carrying capacity of supply connections	Max. 8 A (U_{LS} : 4 A, U_A : 4 A)	Max. 8 A (U_{LS} : 4 A, U_A : 4 A)
Supply voltage	Logic and sensor voltage U_{LS}	24 V DC
	Actuator voltage U_A	24 V DC
Supply current	Logic and sensor current I_{LS}	Typ. 45 mA (only logic part)
	Actuator current I_A	Typ. 25 mA + actuators
Protection	Reverse polarity protection for $U_{LS} + U_A$ Short-circuit protection for sensor supply	Reverse polarity protection for $U_{LS} + U_A$ Short-circuit protection for sensor supply
Information on selecting the actuator		
Rise time from 0 to 1	Typ. 40 μ s (resistive load)	Typ. 40 μ s (resistive load)
Rise time from 1 to 0	Typ. 50 μ s (resistive load)	Typ. 50 μ s (resistive load)
Cable length (unshielded)	≤ 30 m	≤ 30 m
System bus		
Connection type	M12 connectors, B-coded, 5-pin, shielded	M12 connectors, B-coded, 5-pin, shielded
Electrical isolation		
Channel – channel	No	No
U_{LS} , U_A , system bus	500 V DC each	500 V DC each
Configurable functions		
Substitute value strategy (per channel)	Switch substitute value/ hold last value	Switch substitute value/ hold last value
Substitute value (per channel)	0/1 (default: 0)	0/1 (default: 0)
Online simulation (per channel)	Lock/unlock; simulation value: 0/1	Lock/unlock; simulation value: 0/1
Diagnosis	Per channel	Overload and short circuit (actuators)
	Per module	Undervoltage ($U_{LS} + U_A$)
Process image		
Process data width	1 byte data + status	1 byte data + status
Ambient conditions		
Permissible temperature (operation)	-25 to +60°C	-25 to +60°C
Permissible relative humidity (operation)	5 to 95%, no dewing	5 to 95%, no dewing
Permissible air pressure (operation)	795 to 1,080 hPa	795 to 1,080 hPa
Mechanical data		
Dimensions (W x H x D)	50 x 117 x 35 mm	50 x 117 x 35 mm
Dimensional drawing (see p. 201)	Type 2	Type 2
Weight	230 g	230 g
Vibration resistance	According to IEC 60068-2-6	According to IEC 60068-2-6
Shock resistance (temporary)	According to IEC 60068-2-27	According to IEC 60068-2-27

Technical data		S67-DO8-M8-2A	S67-DO8-M12-2A
Digital outputs			
Number of outputs		8	8
Connection type		M8 connectors, 3-pin	M12 connectors, 3-pin
Connection technique		2 to 3-wire	2 to 3-wire
Output voltage		$\leq U_A$	$\leq U_A$
Output current (per channel)		2.0 A (max. 2.4 A), short-circuit/overload proof (thermal disconnection)	0.5 A (max. 0.6 A), short-circuit/overload proof (thermal disconnection)
Voltage drop against U_A at 500 mA		Max. 0.2 V DC	Max. 0.2 V DC
Output current (module)		Max. 8 A	Max. 8 A
Switching-on of overload circuit		Configurable	Configurable
Leak current when off		Typ. 150 μ A	Typ. 150 μ A
Output circuit		High-side switching	High-side switching
Module supply			
Connection type		M12 connectors, A-coded, 4-pin	M12 connectors, A-coded, 4-pin
Current carrying capacity of supply connections		Max. 4.5 A each (U_{LS} : 45 mA, U_A : 4 A)	Max. 8 A (U_{LS} : 4 A, U_A : 4 A)
Supply voltage	Logic and sensor voltage U_{LS}	24 V DC	24 V DC
	Actuator voltage U_A	24 V DC	24 V DC
Supply current	Logic and sensor current I_{LS}	Typ. 45 mA (only logic part)	Typ. 45 mA (only logic part)
	Actuator current I_A	Typ. 55 mA + actuators	Typ. 25 mA + actuators
Protection		Reverse polarity protection for $U_{LS} + U_A$ Short-circuit protection for sensor supply	Reverse polarity protection for $U_{LS} + U_A$ Short-circuit protection for sensor supply
Information on selecting the actuator			
Rise time from 0 to 1		Typ. 30 μ s (resistive load)	Typ. 40 μ s (resistive load)
Rise time from 1 to 0		Typ. 50 μ s (resistive load)	Typ. 50 μ s (resistive load)
Cable length (unshielded)		≤ 30 m	≤ 30 m
System bus			
Connection type		M12 connectors, B-coded, 5-pin, shielded	M12 connectors, B-coded, 5-pin, shielded
Electrical isolation			
Channel – channel		No	No
U_{LS} , U_A , system bus		500 V DC each	500 V DC each
Configurable functions			
Substitute value strategy (per channel)		Switch substitute value/ hold last value	Switch substitute value/ hold last value
Substitute value (per channel)		0/1 (default: 0)	0/1 (default: 0)
Online simulation (per channel)		Lock/unlock; simulation value: 0/1	Lock/unlock; simulation value: 0/1
Diagnosis	Per channel	Overload and short circuit (actuators)	Overload and short circuit (actuators)
	Per module	Undervoltage ($U_{LS} + U_A$)	Undervoltage ($U_{LS} + U_A$)
Process image			
Process data width		1 byte data + status	1 byte data + status
Ambient conditions			
Permissible temperature (operation)		-25 to +60°C	-25 to +60°C
Permissible relative humidity (operation)		5 to 95%, no dewing	5 to 95%, no dewing
Permissible air pressure (operation)		795 to 1,080 hPa	795 to 1,080 hPa
Mechanical data			
Dimensions (W x H x D)		50 x 117 x 35 mm	50 x 117 x 35 mm
Dimensional drawing (see p. 201)		Type 2	Type 2
Weight		230 g	230 g
Vibration resistance		According to IEC 60068-2-6	According to IEC 60068-2-6
Shock resistance (temporary)		According to IEC 60068-2-27	According to IEC 60068-2-27

Analog inputs – technical data

Technical data	S67-AI4-U/I-M12
Analog inputs	
Number of inputs	4
Connection type	M12 connectors, A-coded, 5-pin
Type of signal	Currents and voltages (differential inputs)
Connection technique	2 to 4-wire connection (external shield via knurled nut)
Measuring range	0 to 20 mA, 4 to 20 mA, ± 20 mA, 0 to 10 V, ± 10 V
Cable length, shielded	≤ 30 m
Analog value creation	
Resolution	16 bits
Conversion time	1 ms
Sampling delay	1 ms (module), $< 100 \mu\text{s}$ (channel/channel)
Sampling repeat time	1 ms
Failures and errors	
Max. measuring error at 25°C	Approx. $\pm 0.2\%$ of the measuring range
Temperature error	Approx. $\pm 0.01\%$ of the measuring range/K
Module supply	
Connection type	M12 connectors, A-coded, 4-pin
Logic, sensor, and actuator supply voltage U_{LS} , U_A	24 V DC
Logic and sensor supply current I_{LS}	Typ. 45 mA + sensors (max. 400 mA)
Actuator current I_A	5 mA
Protection	Reverse polarity protection for U_{LS} + U_A Short-circuit protection for sensor supply
System bus	
Connection type	M12 connectors, B-coded, 5-pin, shielded
Electrical isolation	
Channel – channel	No
U_{LS} , U_A , system bus	500 V DC each
Configurable functions	
Measuring range (per channel)	0 to 20 mA, 4 to 20 mA, ± 20 mA, 0 to 10 V, ± 10 V
Limiting values (per channel)	Lock/unlock, Min1/Min2/Max1/Max2
Input filter (per channel)	Low pass
Sampling duration (per channel)	1, 2, 4, 8 ms
Interference frequency suppression (per channel)	50/60 Hz
Online simulation (per channel)	Lock/unlock, simulation value
Electrical isolation	
Diagnosis (per module)	Short circuit (sensor power supply); undervoltage (U_{LS} + U_A); wire break (4 to 20 mA); limit value violation; overrange/measuring range underflow
Process image	
Process data width	8 bytes data + status
Ambient conditions	
Permissible temperature (operation)	-25 to +60°C
Permissible relative humidity (operation)	5 to 95%, no dewing
Permissible air pressure (operation)	795 to 1,080 hPa
Mechanical data	
Dimensions (W x H x D)	35 x 177 x 50 mm
Dimensional drawing (see p. 201)	Type 2
Weight	230 g
Vibration resistance	According to IEC 60068-2-6
Shock resistance (temporary)	According to IEC 60068-2-27

Technical data		S67-AI4-RTD-M12
Analog inputs		
Number of inputs		4
Connection type		M12 connectors, A-coded, 5-pin
Type of signal		Resistance thermometers, resistors, potentiometers
Connection technique		2 to 4-wire connection (external shield via knurled nut)
Signal measuring range		Resistance thermometer: PT100, PT200, PT500, PT1000, NI200, NI120, NI1000 Resistors: 1 kΩ and 4 kΩ Potentiometer: 0 to 100% setting angle (for 1.25 kΩ and 5 kΩ) Free characteristics: PT 3000, NTC etc.
Temperature range		PT: -200 to +850°C, NI: -60 to +250°C
Cable length, shielded		≤ 30 m
Analog value creation		
Resolution		16 bits
Input filter		16.7 Hz, 33 Hz, 50 Hz, 60 Hz, 120 Hz, 250 Hz, 500 Hz
Failures and errors		
Max. measuring error at 25°C		±0.1% of the measuring range
Temperature error		±0.001% of the measuring range/K
Module supply		
Connection type		M12 connectors, A-coded, 4-pin
Logic, sensor, and actuator supply voltage U_{LS} , U_A		24 V DC
Logic and sensor supply current I_{LS}		Typ. 45 mA + sensors (max. 400 mA)
Actuator current I_A		5 mA
Protection		Reverse polarity protection for U_{LS} + U_A Short-circuit protection for sensor supply
System bus		
Connection type		M12 connectors, B-coded, 5-pin, shielded
Electrical isolation		
Channel – channel		No
U_{LS} , U_A , system bus		500 V DC each
Configurable functions		
Measuring range (per channel)		PT100/PT200/PT500/PT1000, NI100/NI120/NI1000 1.25 kΩ/5 kΩ, 0 to 100% setting angle (for 1.25 kΩ and 5 kΩ PT 3000, NTC, own characteristics)
Connection type		2/3/4-wire
Limiting values (per channel)		Lock/unlock, Min1/Min2/Max1/Max2
Input filter (per channel)		16.7 Hz, 33 Hz, 50 Hz, 60 Hz, 120 Hz, 250 Hz, 500 Hz
Electrical isolation		
Diagnosis (per module)		Undervoltage (U_{LS} + U_A); wire break; limit value violation; overrange/measuring range underflow
Process image		
Process data width		8 bytes data + status
Ambient conditions		
Permissible temperature (operation)		-25 to +60°C
Permissible relative humidity (operation)		5 to 95%, no dewing
Permissible air pressure (operation)		795 to 1,080 hPa
Mechanical data		
Dimensions (W x H x D)		35 x 177 x 50 mm
Dimensional drawing (see p. 201)		Type 2
Weight		230 g
Vibration resistance		According to IEC 60068-2-6
Shock resistance (temporary)		According to IEC 60068-2-27

Analog outputs – technical data

Technical data	S67-AO4-U/I-M12
Analog outputs	
Number of outputs	4
Connection type	M12 connectors, A-coded, 5-pin
Type of signal	Currents and voltages (differential inputs)
Connection technique	2 to 4-wire connection (external shield via knurled nut)
Measuring range	0 to 20 mA, 4 to 20 mA, ± 20 mA, 0 to 10 V, ± 10 V
Load impedance	≤ 500 k Ω (current); ≥ 5 k Ω (voltage)
Maximum capacitive load (at voltage outputs)	10 nF
Maximum inductive load (at current outputs)	1 mH
Cable length, shielded	≤ 30 m
Analog value creation	
Resolution	15 bits (unipolar), 16 bits (bipolar)
Monotony	Yes
Cycle time	Approx. 1 ms
Recovery time for resistive, inductive and capacitive loads	Approx. 1 ms
Failures and errors	
Max. measuring error at 25°C	Approx. $\pm 0.2\%$ of the measuring range
Overshooting	Approx. $\pm 0.05\%$ of the measuring range
Output ripple	Approx. $\pm 0.02\%$ of the measuring range
Crosstalk between the channels at DC voltage and AC voltage 50 Hz and 60 Hz	-90 dB
Short-circuit protection	Electronic
Nominal output current	Max. 1 A
Module supply	
Connection type	M12 connectors, A-coded, 4-pin
Logic, sensor, and actuator supply voltage U_{LS} , U_A	24 V DC
Logic and sensor supply current I_{LS}	Typ. 28 mA (only logic part)
Actuator current I_A	34 mA + actuators
Protection	Reverse polarity protection for $U_{LS} + U_A$ Short-circuit protection for sensor supply
System bus	
Connection type	M12 connectors, B-coded, 5-pin, shielded
Electrical isolation	
Channel – channel	No
U_{LS} , U_A , system bus	500 V DC each
Configurable functions	
Measuring range (per channel)	0 to 20 mA, 4 to 20 mA, ± 20 mA, 0 to 10 V, ± 10 V
Substitute value strategy (per channel)	Switch substitute value/hold last value
Substitute value (per channel)	0 mA or 0 V (default: 0 mA or 0 V)
Online simulation (per channel)	Lock/unlock, simulation value
Diagnosis (per module)	Short circuit (voltage) or wire break (current), actuator supply undervoltage ($U_{LS} + U_A$)
Process image	
Process data width	8 bytes data + status
Ambient conditions	
Permissible temperature (operation)	-25 to +60°C
Permissible relative humidity	5 to 95%, no dewing
Permissible air pressure (operation)	795 to 1,080 hPa
Mechanical data	
Dimensions (W x H x D)	50 x 117 x 35 mm
Dimensional drawing (see p. 201)	Type 2
Weight	230 g
Vibration resistance	According to IEC 60068-2-6
Shock resistance (temporary)	According to IEC 60068-2-27

Power divider – technical data

Technical data	S67-PWR-IN-M12
Power divider	
Connection type	M23 connectors, 6-pin
Supply voltage	
Logic and sensor voltage U_{LS}	24 V DC (-25 to +30%)
Actuator voltage U_A	24 V DC (-25 to +30%)
Logic and sensor supply current I_{LS}	Typ. 4 mA
Actuator current I_A	Typ. 4 mA
Supply outputs	
Number of outputs	6
Connection type	M12 connectors, A-coded, 4-pin
Current carrying capacity, connector	Max. 8 A (U_{LS} : 4 A, U_A : 4 A)
Current carrying capacity, module	Max. 24 A (U_{LS} : max. 8 A, U_A : max. 16 A)
Short-circuit protection	No
Electrical isolation	
$U_{LS} - U_A$	500 V AC
Ambient conditions	
Permissible temperature (operation)	-25 to +60°C
Permissible relative humidity	5 to 95%, no dewing
Permissible air pressure (operation)	795 to 1,080 hPa
Mechanical data	
Dimensions (W x H x D)	50 x 117 x 35 mm
Dimensional drawing (see p. 201)	Type 2
Weight	240 g
Vibration resistance	According to IEC 60068-2-6
Shock resistance (temporary)	According to IEC 60068-2-27

IndraControl S67 – ordering data

IndraControl S67 ordering data	
Description	Type code
IndraControl S67 PROFIBUS coupler with 8 digital inputs 24 V DC (8 x M8)	S67-PB-BK-DI8-M8
IndraControl S67 PROFINET bus coupler with 8 digital inputs 24 V DC (8 x M8)	S67-PN-BK-DI8-M8
IndraControl S67 sercos bus coupler with 8 digital inputs 24 V DC (8 x M8)	S67-S3-BK-DI8-M8
IndraControl S67 EtherNet/IP bus coupler with 8 digital inputs 24 V DC (8 x M8)	S67-ET-BK-DI8-M8
IndraControl S67 digital input module, 8 inputs M8, 24 V DC	S67-DI8-M8
IndraControl S67 digital input module, 8 inputs M12 (4 x M12, two inputs per connector), 24 V DC	S67-DI8-M12
IndraControl S67 digital input module, 8 inputs M8, 24 V DC, NPN-switching	S67-DI8-M8-NPN
IndraControl S67 digital input module, 8 inputs M12 (4 x M12, two inputs per connector), 24 V DC, NPN-switching	S67-DI8-M12-NPN
IndraControl S67 digital output module, 8 outputs M8, 24 V DC, 0.5 A	S67-DO8-M8
IndraControl S67 digital output module, 8 outputs M12 (4 x M12, two outputs per connector), 24 V DC, 0.5 A	S67-DO8-M12
IndraControl S67 digital output module, 8 outputs M8, 24 V DC, 2.0 A	S67-DO8-M8-2A
IndraControl S67 digital output module, 8 outputs M12 (4 x M12, two outputs per connector), 24 V DC, 2.0 A	S67-DO8-M12-2A
IndraControl S67 digital output module, 8 outputs M8, 24 V DC, 0.5 A, NPN-switching	S67-DO8-M8-NPN
IndraControl S67 digital output module, 8 outputs M12 (4 x M12, two outputs per connector), 24 V DC, 0.5 A, NPN-switching	S67-DO8-M12-NPN
IndraControl S67 analog input module, 4 inputs M12, 0-20 mA, 4-20 mA, ± 20 mA, 0-10 V, ± 10 V	S67-AI4-U/I-M12
IndraControl S67 analog input module, 4 inputs M12, resistance thermometer, resistors, potentiometer	S67-AI4-RTD-M12
IndraControl S67 analog output module, 4 outputs M12 0-20 mA, 4-20 mA, ± 20 mA, 0-10 V, ± 10 V	S67-AO4-U/I-M12
IndraControl S67 power supply module (1 x M23/6 x M12 connection)	S67-PWR-IN-M12
Ordering data for accessories	
Description	Type code
Cable	See interconnection technology
System bus cable, M12 socket, M12 plug, available lengths 0.20/0.30/0.50/1/2/5/10 m	RKB0041/0xx,x
System bus cable, M12 socket, M12 plug, any length	RKB0041/000,0
System bus terminating connector, B-coded, axial	RBS0020
Carrier rail adapter for fieldbus couplers	SUP-M01-S67-0001
Carrier rail adapter for I/O modules	SUP-M01-S67-0002
Profile adapter for fieldbus couplers	SUP-M01-S67-0003
Profile adapter for I/O modules	SUP-M01-S67-0004
Spacer	SUP-M01-S67-0005
Marker strips for fieldbus couplers and I/O modules	SUP-M01-S67-0006
Ordering data for documentation	
Description	Type code
Application manual, IndraControl S67	DOK-CONTRL-S67*****-APxx-DE-P

xxx = cable length in meters

Technical information and data sheets for Rexroth Inline are available from <http://www.boschrexroth.de/mediadirectory>

IndraControl S67

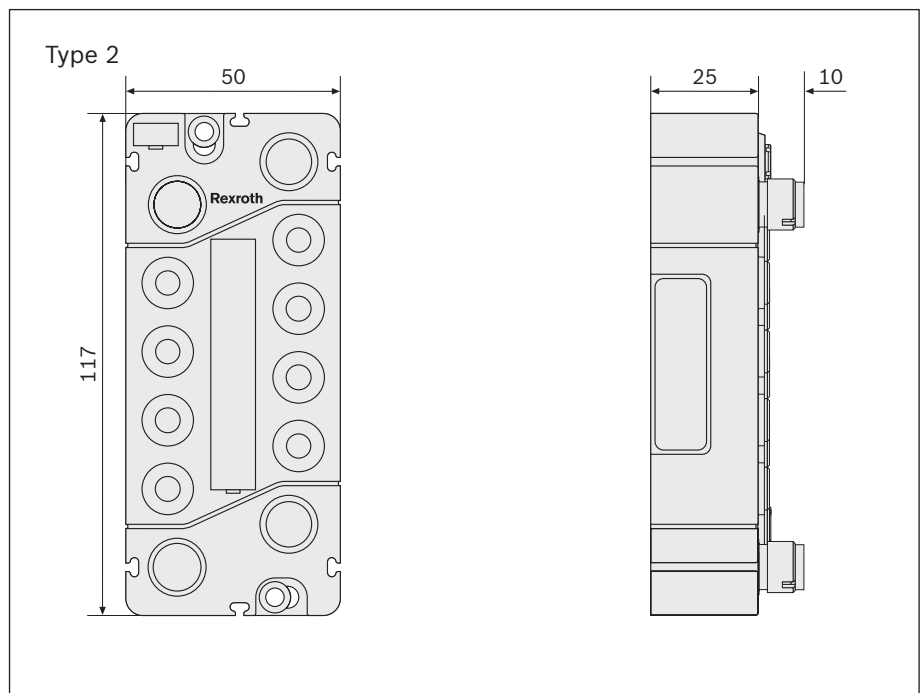
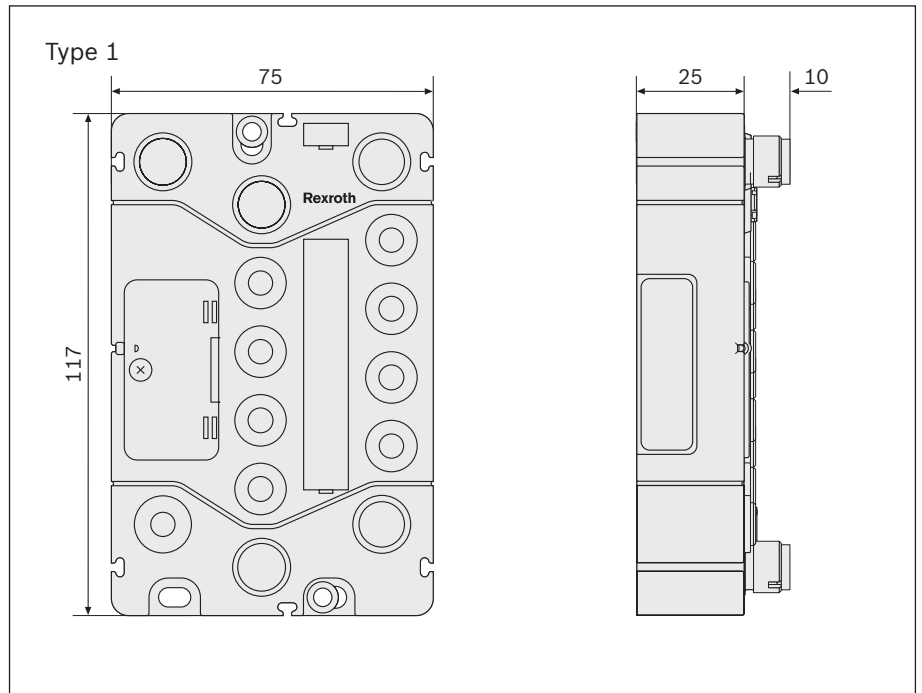

Fieldline – the robust I/O technology for field use

Rexroth Fieldline enables on-machine installation with particularly high operational reliability even in harsh environment – thanks to IP67 enclosure rating. User-friendly operation, easy installation and flexible assembly enable I/Os to be connected over shorter wiring distances and without a control cabinet.

Fieldline Modular M8

Thanks to their compact design and the M8 connection system, the Fieldline modules are ideal for connecting sensors and actuators in the immediate vicinity of the process, even under the most difficult mounting conditions. They can be coupled to our Fieldline Modular coupler for PROFIBUS or to an Inline Modular station.

Your benefits

- ▶ High protection category IP67 for harsh industrial environments
- ▶ Easy handling
- ▶ Flexible assembly
- ▶ Simple operation and application
- ▶ Quick and convenient diagnosis
- ▶ Intelligent voltage concept for selective power-off
- ▶ Fast and perfect installation
- ▶ Highly reliable operation under extreme ambient conditions
- ▶ Compact, space-saving design



Rexroth Fieldline – allows reliable I/O signal transmission directly at the machine.

Fieldline Modular M8 – technical data

Technical data	RF-FLM DI 8 M8	RF-FLM DIO 8/4 M8
Digital inputs		
Input description	4 digital inputs	4 digital inputs, 4 digital in-/outputs
Connection technique	2, 3-wire connection	
Number	8	
Protective circuit	Reverse polarity protection	
Filter time	3 ms	
Input characteristic	IEC 61131-2, Type 1	
Input voltage	24 V DC	
Input voltage range, low level	-30 to 5 V DC	
Input voltage range, high level	13 to 30 V DC	
Digital outputs		
Output description	–	Can also be used as inputs
Connection technique	–	2, 3-wire connection
Number of outputs	–	4
Max. output current per channel	–	500 mA
Protective circuit	–	Protective circuit
Output voltage	–	24 V DC
Electrical data		
Supply voltage	24 V DC	
Supply voltage range	18 to 30 V DC, IEC 61131-2 (ripple included)	
Supply current	3 A	
Transmission rate	500 kbaud	
Connection type	M8 connectors	
Ambient conditions		
Ambient temperature (operation)	-25 to +60°C	
Permissible relative humidity (operation)	5 to 95%, no dewing	
Atmospheric pressure (operation)	80 to 106 kPa (up to 2,000 m above sea level)	
Mechanical data		
Dimensions (W x H x D)	29.8 x 143 x 26.5 mm	
Dimensional drawing (see p. 206)	Type 4	Type 4
Weight	137 g	
Drill hole spacing	133 mm	
Mounting type	Mounted to walls	
Test section to peripherals	500 V AC	
Protection category	IP65/67	
Protection class	3, VDE 0106, IEC 60536	

Fieldline Modular M8 bus coupler – technical data

Technical data	RF-FLM BK PB M12 DI 8 M12
Digital inputs	
Connection type	M12 connectors
Connection technique	2, 3, 4-wire
Number of inputs	8
Protective circuit	Reverse polarity protection
Filter time	3 ms
Input voltage	24 V DC
Input voltage range, low level	-30 to 5 V DC
Input voltage range, high level	13 to 30 V DC
Local bus gateway	
Connection type	M12 connectors, B-coded
Transmission rate	500 kbaud
Max. number of local bus users	16
Max. length of local bus	20 m
Interface	
Designation	PROFIBUS
Connection type	2 x M12 connectors, B-coded
Transmission rate	9.64 to 12 Mbaud, autobaud
Electrical data	
Connection technique	M12 connectors
Designation	U_L
Supply voltage	24 V DC
Supply voltage range	18 to 30 V DC, IEC 61131-2 (ripple included)
Ambient conditions	
Ambient temperature (operation)	-25 to 60°C
Atmospheric pressure (operation)	80 to 106 kPa (up to 2000 m above MSL)
Mechanical data	
Dimensions (W x H x D)	70 x 178 x 50 mm
Dimensional drawing (see p. 206)	Type 3
Weight	331 g
Drill hole spacing	168 mm
Mounting type	Mounted to walls
Test section to peripherals	500 V AC
Protection category	IP65/67
Protection class	3, VDE 0106, IEC 60536

Fieldline – ordering data

Ordering data Fieldline M8

Description	Type code
Fieldline Modular M8, local bus device, 8 digital inputs, 24 V DC	RF-FLM DI 8 M8
Fieldline Modular M8, local bus device, 8 digital inputs, max. 4 digital outputs, 500 mA, 24 V DC	RF-FLM DIO 8/4 M8
Fieldline Modular bus coupler, PROFIBUS, 8 digital inputs 24 V DC, M12	RF-FLM BK PB M12 DI 8 M12

Ordering data for accessories

Description	Type code
Adapter, M12/M8	RF-FLM ADAP M12/M8

Ordering data for documentation

Description	Type code
Fieldline PROFIBUS, application manual	DOK-CONTRLRF-FLS-PB**-AWxx-DE-P
Fieldline PROFIBUS, project planning manual	DOK-CONTRLRF-FLS-PB**-PRxx-DE-P

Technical information and data sheets for Rexroth Fieldline are available from <http://www.boschrexroth.de/mediadirectory>

xxx = cable length in meters

Fieldline Modular M8

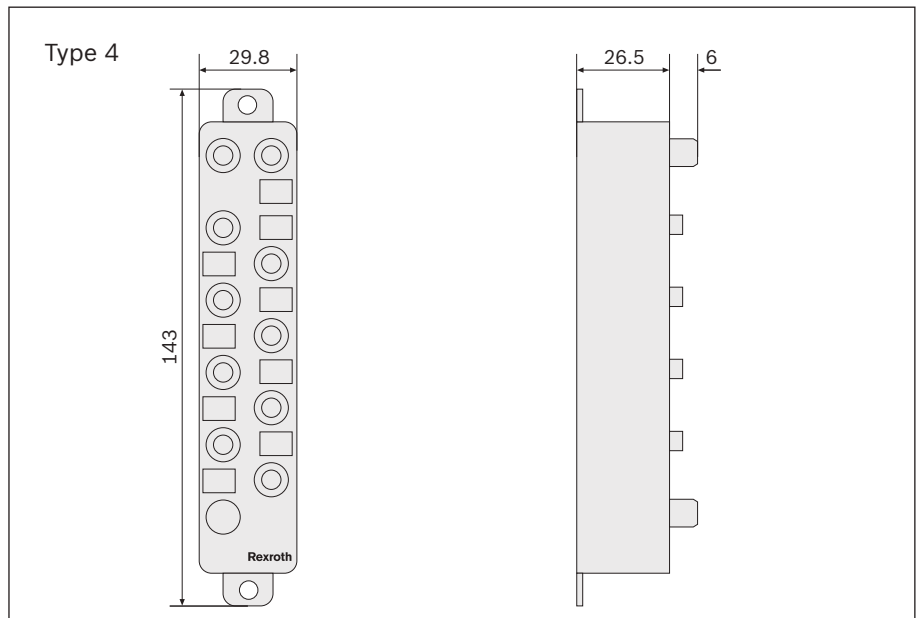
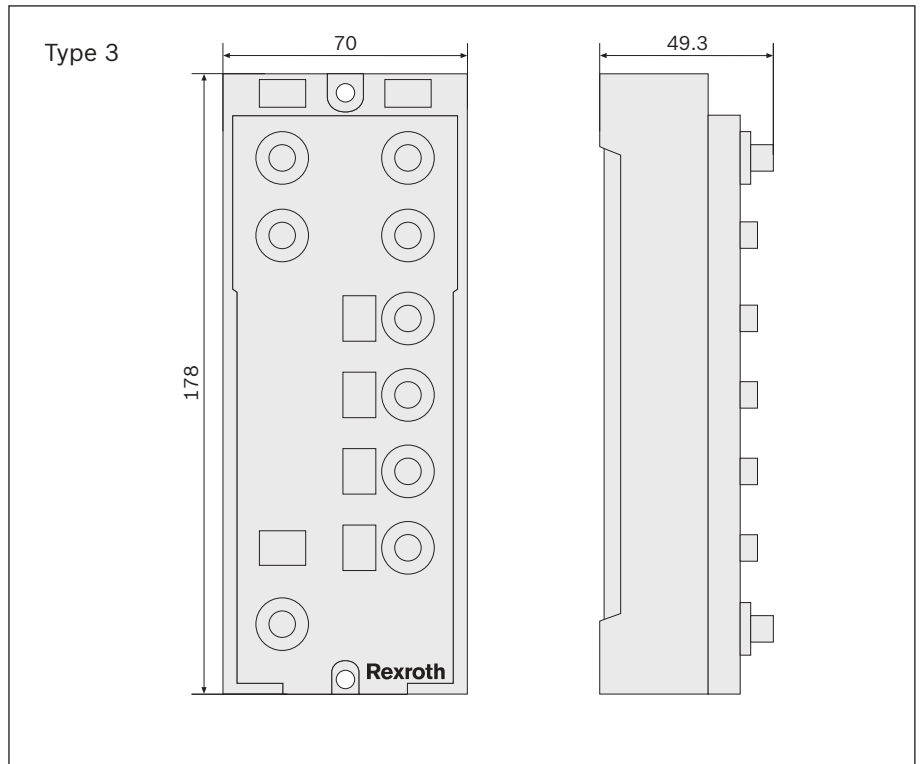



Interconnection technology – general overview

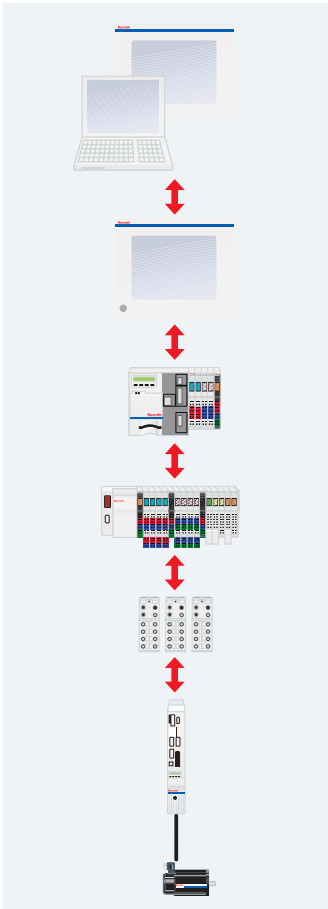

	sercos III	sercos II	PROFIBUS	DeviceNet	INTERBUS	Ethernet TCP/IP	RS232
Engineering/operation							
			IKB0033, IKB0034			RKB0007, RKB0008	RKB0009
HMI/PC components							
IndraControl V			IKB0033, IKB0034			RKB0007, RKB0008	RKB0009
Control components							
IndraControl L	RKB0011, RKB0013	RKO0100, RKO0101	IKB0033, IKB0034			RKB0007, RKB0008	RKB0009
I/O modules in IP20							
Inline	RKB0011, RKB0013		IKB0033, IKB0034, IKB0049	IKB0043	IKB0046		
I/O modules in IP67							
Fieldline M8/ IndraControl S67			IKB0049, IKB0050, RF-FLM ADAP M12/ M8 ¹⁾ , RKB0016	IKB0042, IKB0044	IKB0047		
Drives (link to control level)²⁾							
IndraDrive	RKB0011, RKB0013	RKO0100, RKO0101	IKB0033, IKB0034			RKB0007, RKB0008	

¹⁾ In combination with Rexroth Fieldline

²⁾ Power supply and encoder cables for all drive/motor combinations can be found in the "Drive System Rexroth IndraDrive" product catalog

Interconnection technology – selection tool

Selecting the fieldbus and voltage supply cables

An extensive cable range is available for wiring all IndraControl L components. Please proceed as follows when selecting the cables and plugs:

- 1 Define station n (left column)
- 2 Determine station n + 1 (top header)
- 3 Select pre-assembled cable (on gray background), or the individual interconnection components (on white background)
- 4 Define the bus terminating resistor



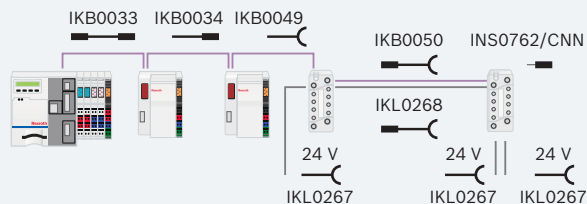







































































































Selection example for PROFIBUS



Legend of cable symbols



































Pre-assembled cable	Pre-assembled plug/ socket	Open cable end/ plug	Open cable end/ socket	Plug	Socket

Interconnection technology – PROFIBUS selection matrix







	IndraControl L	Inline/IndraControl S20	IndraControl S67	Fieldline M8	IndraDrive
					
IndraControl L	 IKB0033/xxx	 IKB0033/xxx			 IKB0033/xxx
	 RBS0010... RBS0012	 RBS0010... RBS0012	 RBS0010... RBS0012	 IKB0049/xxx	 RBS0010... RBS0012
	 IKB0034/xxx	 IKB0034/xxx			 IKB0034/xxx
	 RBS0013... RBS0015	 REB0001/xxx REB0002/xxx	 RBS0013... RBS0015	 REB0001/xxx REB0002/xxx	 RBS0013... RBS0015
	 RBS0013... RBS0015	 REB0001/xxx REB0002/xxx	 RBS0013... RBS0015	 REB0001/xxx REB0002/xxx	 RBS0013... RBS0015
Function module PROFIBUS	 IKB0033/xxx	 IKB0033/xxx			 IKB0033/xxx
	 RBS0001	 RBS0001	 IKB0034/xxx	 RBS0002	 RBS0010... RBS0012
	 IKB0034/xxx	 IKB0034/xxx			 IKB0034/xxx
	 RBS0001	 REB0001/xxx REB0002/xxx	 RBS0001	 REB0001/xxx REB0002/xxx	 RBS0013... RBS0015
	 RBS0001	 REB0001/xxx REB0002/xxx	 RBS0001	 REB0001/xxx REB0002/xxx	 RBS0013... RBS0015
Inline/IndraControl S20	 IKB0033/xxx	 IKB0033/xxx			 IKB0033/xxx
	 RBS0010... RBS0012	 RBS0010... RBS0012		 IKB0049/xxx	 IKB0034/xxx
	 IKB0034/xxx	 IKB0034/xxx			 IKB0034/xxx
	 RBS0013... RBS0015	 REB0001/xxx REB0002/xxx	 RBS0013... RBS0015	 REB0001/xxx REB0002/xxx	 RBS0013... RBS0015
	 RBS0013... RBS0015	 REB0001/xxx REB0002/xxx	 RBS0001	 REB0001/xxx REB0002/xxx	 RBS0013... RBS0015
IndraControl S67			 IKB0050/xxx	 RF-FLM ADAP M12/M8 ¹⁾ RKB0016 ¹⁾	
	 RBS0001	 IKB0049/xxx	 IKB0049/xxx	 RBS0002	 RBS0001
	 IKB0034/xxx				 IKB0034/xxx
	 RBS0001	 REB0001/xxx REB0002/xxx	 RBS0001	 REB0001/xxx REB0002/xxx	 RBS0001
	 RBS0001	 REB0001/xxx REB0002/xxx	 RBS0001	 REB0001/xxx REB0002/xxx	 RBS0013... RBS0015
IndraDrive					
	 RBS0010... RBS0012	 IKB0034/xxx	 RBS0010... RBS0012	 IKB0049/xxx	
	 IKB0034/xxx				
	 RBS0013... RBS0015	 REB0001/xxx REB0002/xxx	 RBS0013... RBS0015	 REB0001/xxx REB0002/xxx	 RBS0010... RBS0012
	 RBS0013... RBS0015	 REB0001/xxx REB0002/xxx	 RBS0012	 REB0001/xxx REB0002/xxx	 RBS0002

¹⁾ In combination with Rexroth Fieldline



Interconnection technology – PROFINET IO selection matrix

	IndraControl L	Inline/IndraControl S20	IndraControl S67
			
IndraControl L 			 RKB0045
	 RBS0016  RBS0016	 RBS0016  RBS0016	 RBS0016  RBS0018
Function module Real-time Ethernet with PROFINET or DeviceNet 	PROFINET IO		 RKB0045
	 RBS0016  RBS0016	 RBS0016  RBS0016	 RBS0016  RBS0018
Inline/ IndraControl S20 			 RKB0045
	 RBS0016  RBS0016	 RBS0016  RBS0016	 RBS0016  RBS0018
IndraControl S67 			 RKB0040
	 RBS0018  RBS0018	 RBS0018  RBS0016	 RBS0018  RBS0018



Interconnection technology – DeviceNet selection matrix

	Inline D-SUB 	Function module DeviceNet master 
Function module DeviceNet master 		
Inline 		
IndraControl S67 	 IKB0042/xxx	





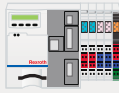

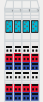



Interconnection technology – INTERBUS selection matrix

	INTERBUS	<p style="text-align: center;">Inline</p> 
<p style="text-align: center;">Inline</p> 		
		<p style="text-align: center;">— INK0699</p>

Interconnection technology – line skipping module selection matrix













	<p>IndraControl L</p> 	<p>Inline</p> 
<p>Inline</p> 	<p>New line</p> <p>—</p> <p>INK0699</p>	<p>—</p> <p>INK0699</p>

Interconnection technology – Fieldline M8 and IndraControl S67 voltage supply selection matrix

	IndraControl S67	Fieldline M8
		
IndraControl S67 	 IKL0268/xxx	
	RBS0003 	 IKL0267/xxx
Fieldline M8 		
+24 V	 RKB0003/000.3 ¹⁾	 RKB0017/xxx
	 IKL0267/xxx	

¹⁾ In combination with Rexroth Fieldline

Interconnection technology – Fieldline M8 selection matrix

	IndraControl L	Inline	Fieldline M8
			
IndraControl L 			 RKB0015/xxx
Inline 			
Fieldline M8			 RKB0015/xxx
			 RF-FLM ADAP M12/M8 RKB0016
Fieldline bus coupler 			
Fieldline M8 			 RKB0016/xxx
	 RKB0014/xxx	 RKB0014/xxx	

Interconnection technology – ordering data

Description	Type code
sercos III cable sets	
sercos III cable, 100-Base-T, CAT5E, shielded, RJ45 plug on both sides, 4-wire, twisted quad, stranded, red, any length	RKB0011/xxx
sercos III cable, 100-Base-T, CAT5E, S/TP, RJ45 plug on both sides, 8-wire, twisted pair, red, available lengths: 0.25/0.35/0.55 m	RKB0013/xxx
sercos II cable sets	
FO cable, 2.2 mm in diameter, available lengths: 0.15/0.25/0.30/0.50/1.00 m	RK00100/xxx
FO cable, 6.0 mm in diameter, available lengths: 5/10/15 m	RK00101/xxx
FO cable plug connector (2.2 mm in diameter)	ROS0001/C02
FO cable plug connector (6.0 mm in diameter)	ROS0002/C06
FO cable, 2.2 mm in diameter (by the meter)	INK0414
FO cable, 6.0 mm in diameter (by the meter)	INK0435
PROFIBUS cable sets	
PROFIBUS bus cable, D-SUB, cable outlet 45°, D-SUB cable outlet 45°	IKB0033
PROFIBUS bus cable, D-SUB, cable outlet 45°, free line end	IKB0034
PROFIBUS bus cable, standard cable, fast connect, any length	REB0001
PROFIBUS bus cable, drag cable, fast connect, any length	REB0002
D-SUB connector, PROFIBUS, cable outlet 90°, screwed connection	RBS0010
D-SUB connector, PROFIBUS, cable outlet 90°, with additional D-SUB socket, screwed connection	RBS0011
D-SUB connector, PROFIBUS, cable outlet 180°, screwed connection	RBS0012
D-SUB connector, PROFIBUS, cable outlet 90°, insulation displacement	RBS0013
D-SUB connector, PROFIBUS, cable outlet 90°, with additional D-SUB socket, insulation displacement	RBS0014/F03
D-SUB connector, PROFIBUS, cable outlet 180°, insulation displacement	RBS0015/F03
PROFIBUS bus cable, M12 plug, straight, shielded, 5-pin, B-coded, free line end, available lengths: 5/10 m	IKB0048/xxx
PROFIBUS bus cable, M12 socket, straight, shielded, 5-pin, B-coded, free line end, available lengths: 5/10 m	IKB0049/xxx
PROFIBUS bus cable, M12 plug, straight, shielded, 5-pin, B-coded, M12 socket, straight, shielded, 5-pin, B-coded, available lengths: 0.30/0.50/1/2/5/10 m	IKB0050/xxx
M12 connector, straight plug, shielded, with screwed connection, 5-pin, B-coded	RBS0001/K01
M12 connector, straight socket, shielded, with screwed connection, 5-pin, B-coded	RBS0002/K01
M12 terminating resistor, PROFIBUS, 5-pin, B-coded	INS0762/CNN
Local bus cable, M8 socket, straight, M8 pin, straight	RKB0016/xxx
Stripping tool for PROFIBUS cables	WERKZ-ABISOLIERER-FC-KABEL
Spare knife for stripping tool	WERKZ-ABISOLIERER-FC-KABEL-ERSATZMESSER

xxx = cable length in meters

Interconnection technology – ordering data

Description	Type code
INTERBUS cable sets	
INTERBUS plug, 9-pin socket	INS0703/K01
Local bus cable, M8 plug, straight, free line end, available lengths: 2/5/10 m	RKB0014/xxx
Local bus cable, M8 socket, straight, free line end, available lengths: 2/5/10 m	RKB0015/xxx
Local bus cable, M8 socket, straight, M8 pin, straight, available lengths: 0.10/1/2/5 m	RKB0016/xxx
Supply cable sets	
M12 connector, plug, straight, unshielded, A-coded, 4-pin	RBS0003/K01
M12 connector, plug, straight, unshielded, A-coded, 4-pin	RBS0003/K01
M12 connector, socket, straight, unshielded, A-coded, 4-pin	RBS0004/K01
M12 connector – insulation displacement, plug, straight, unshielded, A-coded, 4-pin	RBS0005/Q01
M12 connector – insulation displacement, socket, straight, unshielded, A-coded, 4-pin	RBS0006/Q01
Voltage cable, socket, straight, unshielded, M12, A-coded, 4-pin, open line end, available lengths: 5/10/15 m	IKL0267/xxx
Voltage cable, socket, straight, unshielded, M12, A-coded, 4-pin, socket, straight, unshielded, M12, A-coded, 4-pin, available lengths: 0.30/0.50/1/2/5/10 m	IKL0268/xxx
Voltage cable, Y-connector, straight, M12 on 2x sockets, straight, M12	RKB0003/xxx
Voltage cable, M8, socket, straight, free line end, available lengths: 2/5/10 m	RKB0017/002.0/xxx
Ethernet cable sets	
Ethernet cable, 10-Base-T, CAT.6+, crosslink, UL, suitable as trailing cable, pre-assembled with RJ45 plug on both ends, available lengths: 0.15/2.50/5/10/25 m	RKB0007/xxx
Ethernet cable, 10-Base-T, CAT.6+, UL, suitable as trailing cable, pre-assembled with RJ45 plug on both ends, available lengths: 2.50/5/10/25 m	RKB0008/xxx
Accessories for I/O modules in IP67	
End mount for Inline station	SUP-M01-ENDHALTER
End mount for Inline station, aluminum	SUP-M01-ENDHALTER/AL
M8 cover for unused inputs/outputs	RF-PROT-M8
M12 cover for unused inputs/outputs	SUP-M01-SM*12.1
M12 cover for unused connectors	RF-PROT-M12-M
RS232 cable set	
RS232 cable, null modem, pre-assembled, with 9-pin D-SUB on both sides, length: 5 m	RKB0009/005,0
HMI cable set	
Giga interface cable between VxB 40 and VDP (G5)	BKS-U-H-G4****-IPCVPD-xxx,0-P

xxx = cable length in meters



Glossary

► C

CDI

Compact Display Interface – interface for connecting the separate operating display to the control cabinet PC

CFC

Short for Continuous Function Chart; graphics-oriented programming language for creating PLC user programs

CNC

Computerized Numerical Control. Digital control for machine tools.

► D

DeviceNet

CAN-based communication system for linking industrial automation components to higher-order control equipment in a network

DVI

Digital Visual Interface – interface for digital transmission of video data

► E

Electronic cam

The target position of the slave axis is calculated from the actual position of the master axis using a mathematical “cam” function

Electronic gear

Electronic simulation of a mechanical gear by software

Embedded systems

Systems with embedded computer functions

EtherNet/IP adapter

Slave in an EtherNet/IP network (see slave)

EtherNet/IP scanner

Master in an EtherNet/IP network (see master)

► F

FDT/DTM

Manufacturer-independent concept allowing the configuration of field devices from different manufacturers with only one program

Fieldbus

Conducted communication system which connects control units, sensors and actuators. Standardized through IEC 61158.

Firmware

Device-specific software for automation components. Not exchangeable when filed to a read-only memory, or on removable memory media such as CompactFlash.

FlexProfile

Motion functionality for non-linear motion sequences with master-axis-related or time-related profile segments

FO

Fiber optic cable

Function library

Collection of function blocks or functions, for example according to IEC 61131-3 or PLCopen

FBD

Function Block Diagram; graphics-oriented programming language for creating PLC user programs according to IEC 61131-3

► G

GAT

Generic Application Template – general adjustable software templates for selective implementation of application tasks

► H

HMI

Human Machine Interface. System for operating and visualizing machines and systems.

Hot-plug principle

Failure-free connection and disconnection of devices during running operation

► **I****I/O**

Input/output – I/Os are discrete interfaces for transmitting or receiving digital or analog signals

IL

Short Instruction List; textual assembler-like programming language for creating PLC programs according to IEC 61131-3

IndraControl L

Controller-based PLC system family from Rexroth

IndraControl V

IPC and visualization platform from Rexroth

IndraDrive

Drive platform from Rexroth

IndraDyn

Motor platform from Rexroth

IndraLogic

Consistent PLC platform according to IEC 61131-3 from Rexroth

IndraLogic L

Controller-based PLC system family from Rexroth

IndraLogic V

PC-based and embedded-PC-based PLC system family from Rexroth

IndraLogic XLC

Control system with PLC kernel IndraLogic 2G (based on CoDeSys V3)

IndraMotion

System family of integrated motion logic solutions from Rexroth

IndraMotion MLC

Controller-based system solution with integrated motion logic from Rexroth

IndraMotion MLD

Drive-based system solution with integrated motion logic from Rexroth

IndraMotion MTX

System family of CNC solutions from Rexroth

IndraWorks

Software framework for engineering and operation, consistent for all solutions from Rexroth

IPC

Industrial PC – sturdy design of a standard PC, which meets the conditions of an industrial environment

► **L****LD**

Ladder Diagram; graphics-oriented programming language for creating PLC user programs according to IEC 61131-3

► **M****Master**

Central bus user controlling bus access

Master axis

Position or velocity command value of a master for the following slave axes

Motion control

Intelligent and complex guidance of the movements of multi-axis systems. Control and drive functionalities are integrated in a single system.

Motion logic

Automation software or firmware with integrated motion control and PLC logic

MotionProfile

Motion functionality for non-linear motion sequences with master-axis-related profile segments

Motion profile

Method for describing motion using speed, time, and position

Multikinematics

Multiple motions in space, described by path, velocity, acceleration

► **O****OPC**

OLE for Process Control, communication standard for components in the automation sector, to ensure smooth standardized data exchange between controls, operating and visualization systems, field devices and office applications of various manufacturers

► **P****PLC**

A programmable logic controller, PLC or programmable controller is a small computer used for automation of real-world processes, such as control of machinery on factory assembly lines. Where older automated systems would use hundreds or thousands of relays and cam timers, a single PLC can be programmed as a replacement. Programmable controllers were initially adopted by the automotive manufacturing industry, where software revision replaced the re-wiring of hard-wired control panels.

Glossary

PLCopen

International community of interests, established by control manufacturers, software companies and institutes (independent of manufacturers and products). In compliance with the PLC standard IEC 61131-3, technical committees define standards facilitating an increase in the efficiency of application software.

PROFIBUS DP

Process Field Bus – today, mainly serial fieldbuses are used as communication systems for exchanging information among automation systems as well as with the connected distributed field devices.

PROFINET controller

Master in a PROFINET network
(see master)

PROFINET device

Slave in a PROFINET network
(see slave)

Programmable limit switch

Function emitting a binary signal in relation to the current position or to the distance traveled. In the past, this function was realized mechanically. Today, it is executed by programmable electronic controls.

► **R**

RDS

Remanent Data Storage

Ready-to-apply solution

See turnkey solution

Robot control

Motion functionality for path interpolation in space

► **S**

Safety on Board

Integrated safety solutions from Rexroth

SFC

Short for Sequential Function Chart; graphical programming language for structuring PLC user programs according to IEC 61131-3

sercos II

Serial Real-time Communications Standard Interface – open and serial real-time communication standard for high-precision motion control applications, designed by leading manufacturers of numerically controlled drives

sercos III

Third sercos generation – further development of the existing sercos II standard according to IEC/EN 61491, based on standard Ethernet. In this generation, the known sercos mechanisms, such as motion control profiles, telegram structure and hardware synchronization, have been applied for real-time communication.

Slave

Network user not allowed to participate in data exchange except when addressed by the master

SSD

Solid State Disk – flash-based bulk storage medium with HDD form factor

ST

Structured Text; Pascal-like programming language for PLC according to IEC 61131-3

► **T**

Technology function

Pre-developed software code for quick and safe implementation of master functions, e.g. winder, probe

Technology library

Collection of available technology functions

Technology module

See Technology function

Technology package

Compilation of several technology functions for a specific application

Turnkey solution

Preconfigured and ready-to-use automation system

► **U**

UPS

Uninterruptible Power Supply – ensures continuous user supply for a certain time in the event of a power failure

User library

Collection of user-specific function blocks or functions in the form of a downloadable PLC library

User program

Application-specific software

► **V**

Virtual master axis

Calculated position or velocity command value of a virtual master for the following slave axes

Standards and certificates

General standards	
Quality management	DIN EN ISO 9001:2000
Quality management	ISO/TS 16949
Environmental protection management system	DIN ISO EN 14001
CE mark, EC declaration of conformity	95/EC
Decree on the safety of devices and products	GPSGV
Low Voltage Directive	73/23/EEC
Machinery Directive	98/73/EC
ATEX Product Directive	94/9/EC
EMC Directive; IndraControl is a Class-A product	2004/108/EC
Product-specific standards	
www.ce-richtlinien.de	CE mark
www.UL.com	UL mark
Programmable controllers	IEC EN 61131
Programmable controllers – Part 2: Equipment requirements and tests	IEC EN 61131-2
Programmable controllers – Part 3: Programming languages	IEC EN 61131-3
Digital data communication for measurement and control	IEC EN 61158
sercos II	IEC EN 61491
See glossary	PLCopen
Safety technology in the drive	
Safety of machinery – Safety-related parts of control systems	EN ISO 13849-1:2006
Safety of machinery – Safety-related parts of control systems	ISO 13849-1:1999
Safety of machinery – Safety-related parts of control systems	EN ISO 13849-2:2003
Safety of machinery – Electrical equipment of machines	EN 60204-1:1997
Safety of machinery – Electrical equipment of machines	EN 60204-1:2007
Electronic equipment for use in power installations	EN 50178:1997
Adjustable speed electrical power drive systems – Part 3: EMC requirements and specific test methods	EN 61800-3:2004
Standard for Power Conversion Equipment	UL 508C R7.03
Safety Functions Incorporating Electronic Technology	C22.2 No. 0.8-M86 (R2003)
Industrial Control Equipment	CAN/CSA C22.2 No. 14-95
Safety technology in the control	
Functional safety of electrical/electronic/programmable electronic safety-related systems	IEC 61508
Safety of machinery – Functional safety of safety-related electrical, electronic and programmable electronic control systems	EN IEC 62061
Safety of machinery – Safety-related parts of control systems	EN ISO13849-1:20

Bosch Rexroth AG

Postfach 13 57
97803 Lohr, Germany
Bgm.-Dr.-Nebel-Str. 2
97816 Lohr, Germany
Tel. +49 9352 18-0
Fax +49 9352 18-8400
www.boschrexroth.com/electrics

Local contact information can be found at:

www.boschrexroth.com/adressen