

ONKYO®

AV Receiver

TX-SR604/604E

TX-SR8460

TX-SR674/674E

TX-SR8467

Instruction Manual

Thank you for purchasing an Onkyo AV Receiver. Please read this manual thoroughly before making connections and plugging in the unit. Following the instructions in this manual will enable you to obtain optimum performance and listening enjoyment from your new AV Receiver. Please retain this manual for future reference.

Contents

Introduction.....2

Connections.....18

First Time Setup.....38

Basic Operations.....49

Advanced Operations.....66

Advanced Setup.....67

Zone 2.....79

Controlling Other Components.....83

Specifications.....86

Troubleshooting.....87



WARNING:

TO REDUCE THE RISK OF FIRE OR ELECTRIC SHOCK, DO NOT EXPOSE THIS APPARATUS TO RAIN OR MOISTURE.

CAUTION:

TO REDUCE THE RISK OF ELECTRIC SHOCK, DO NOT REMOVE COVER (OR BACK). NO USER-SERVICEABLE PARTS INSIDE. REFER SERVICING TO QUALIFIED SERVICE PERSONNEL.



WARNING
RISK OF ELECTRIC SHOCK
DO NOT OPEN

AVIS
RISQUE DE CHOC ELECTRIQUE
NE PAS OUVRIR



The lightning flash with arrowhead symbol, within an equilateral triangle, is intended to alert the user to the presence of uninsulated “dangerous voltage” within the product’s enclosure that may be of sufficient magnitude to constitute a risk of electric shock to persons.



The exclamation point within an equilateral triangle is intended to alert the user to the presence of important operating and maintenance (servicing) instructions in the literature accompanying the appliance.

Important Safety Instructions

1. Read these instructions.
2. Keep these instructions.
3. Heed all warnings.
4. Follow all instructions.
5. Do not use this apparatus near water.
6. Clean only with dry cloth.
7. Do not block any ventilation openings. Install in accordance with the manufacturer’s instructions.
8. Do not install near any heat sources such as radiators, heat registers, stoves, or other apparatus (including amplifiers) that produce heat.
9. Do not defeat the safety purpose of the polarized or grounding-type plug. A polarized plug has two blades with one wider than the other. A grounding type plug has two blades and a third grounding prong. The wide blade or the third prong are provided for your safety. If the provided plug does not fit into your outlet, consult an electrician for replacement of the obsolete outlet.
10. Protect the power cord from being walked on or pinched particularly at plugs, convenience receptacles, and the point where they exit from the apparatus.
11. Only use attachments/accessories specified by the manufacturer.
12. Use only with the cart, stand, tripod, bracket, or table specified by the manufacturer, or sold with the apparatus. When a cart is used, use caution when moving the cart/apparatus combination to avoid injury from tip-over.

PORTABLE CART WARNING
S3125A
13. Unplug this apparatus during lightning storms or when unused for long periods of time.
14. Refer all servicing to qualified service personnel. Servicing is required when the apparatus has been damaged in any way, such as power-supply cord or plug is damaged, liquid has been spilled or objects have fallen into the apparatus, the apparatus has been exposed to rain or moisture, does not operate normally, or has been dropped.
15. Damage Requiring Service
Unplug the apparatus from the wall outlet and refer servicing to qualified service personnel under the following conditions:
 - A. When the power-supply cord or plug is damaged,
 - B. If liquid has been spilled, or objects have fallen into the apparatus,
 - C. If the apparatus has been exposed to rain or water,
 - D. If the apparatus does not operate normally by following the operating instructions. Adjust only those controls that are covered by the operating instructions as an improper adjustment of other controls may result in damage and will often require extensive work by a qualified technician to restore the apparatus to its normal operation,
 - E. If the apparatus has been dropped or damaged in any way, and
 - F. When the apparatus exhibits a distinct change in performance this indicates a need for service.
16. Object and Liquid Entry
Never push objects of any kind into the apparatus through openings as they may touch dangerous voltage points or short-out parts that could result in a fire or electric shock.
The apparatus shall not be exposed to dripping or splashing and no objects filled with liquids, such as vases shall be placed on the apparatus.
Don’t put candles or other burning objects on top of this unit.
17. Batteries
Always consider the environmental issues and follow local regulations when disposing of batteries.
18. If you install the apparatus in a built-in installation, such as a bookcase or rack, ensure that there is adequate ventilation.
Leave 20 cm (8") of free space at the top and sides and 10 cm (4") at the rear. The rear edge of the shelf or board above the apparatus shall be set 10 cm (4") away from the rear panel or wall, creating a flue-like gap for warm air to escape.

Precautions

1. **Recording Copyright**—Unless it's for personal use only, recording copyrighted material is illegal without the permission of the copyright holder.
2. **AC Fuse**—The AC fuse inside the unit is not user-serviceable. If you cannot turn on the unit, contact your Onkyo dealer.
3. **Care**—Occasionally you should dust the unit all over with a soft cloth. For stubborn stains, use a soft cloth dampened with a weak solution of mild detergent and water. Dry the unit immediately afterwards with a clean cloth. Don't use abrasive cloths, thinners, alcohol, or other chemical solvents, because they may damage the finish or remove the panel lettering.
4. **Power**

WARNING

BEFORE PLUGGING IN THE UNIT FOR THE FIRST TIME, READ THE FOLLOWING SECTION CAREFULLY.

AC outlet voltages vary from country to country. Make sure that the voltage in your area meets the voltage requirements printed on the unit's rear panel (e.g., AC 230 V, 50 Hz or AC 120 V, 60 Hz).

The power cord plug is used to disconnect this unit from the AC power source. Make sure that the plug is readily operable (easily accessible) at all times.

Some models have a voltage selector switch for compatibility with power systems around the world. Before you plug in such a model, make sure that the voltage selector is set to the correct voltage for your area.

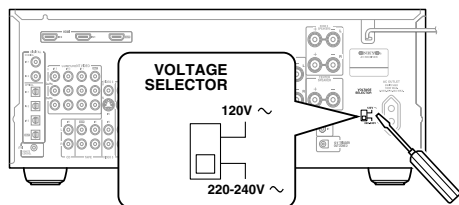

Pressing the [STANDBY/ON] button to select Standby mode does not fully shutdown the unit. If you do not intend to use the unit for an extended period, remove the power cord from the AC outlet.

5. **Never Touch this Unit with Wet Hands**—Never handle this unit or its power cord while your hands are wet or damp. If water or any other liquid gets inside this unit, have it checked by your Onkyo dealer.
6. **Handling Notes**
 - If you need to transport this unit, use the original packaging to pack it how it was when you originally bought it.
 - Do not leave rubber or plastic items on this unit for a long time, because they may leave marks on the case.
 - This unit's top and rear panels may get warm after prolonged use. This is normal.

- If you do not use this unit for a long time, it may not work properly the next time you turn it on, so be sure to use it occasionally.

For U.S. models

FCC Information for User

CAUTION:

The user changes or modifications not expressly approved by the party responsible for compliance could void the user's authority to operate the equipment.

NOTE:

This equipment has been tested and found to comply with the limits for a Class B digital device, pursuant to Part 15 of the FCC Rules. These limits are designed to provide reasonable protection against harmful interference in a residential installation.

This equipment generates, uses and can radiate radio frequency energy and, if not installed and used in accordance with the instructions, may cause harmful interference to radio communications. However, there is no guarantee that interference will not occur in a particular installation. If this equipment does cause harmful interference to radio or television reception, which can be determined by turning the equipment off and on, the user is encouraged to try to correct the interference by one or more of the following measures:

- Reorient or relocate the receiving antenna.
- Increase the separation between the equipment and receiver.
- Connect the equipment into an outlet on a circuit different from that to which the receiver is connected.
- Consult the dealer or an experienced radio/TV technician for help.

For Canadian Models

NOTE: THIS CLASS B DIGITAL APPARATUS COMPLIES WITH CANADIAN ICES-003.

For models having a power cord with a polarized plug:

CAUTION: TO PREVENT ELECTRIC SHOCK, MATCH WIDE BLADE OF PLUG TO WIDE SLOT, FULLY INSERT.

Modèle pour les Canadien

REMARQUE: CET APPAREIL NUMÉRIQUE DE LA CLASSE B EST CONFORME À LA NORME NMB-003 DU CANADA.

Sur les modèles dont la fiche est polarisée:

ATTENTION: POUR ÉVITER LES CHOCS ÉLECTRIQUES, INTRODUIRE LA LAME LA PLUS LARGE DE LA FICHE DANS LA BORNE CORRESPONDANTE DE LA PRISE ET POUSSER JUSQU'AU FOND.

Precautions—Continued

For British models

Replacement and mounting of an AC plug on the power supply cord of this unit should be performed only by qualified service personnel.

IMPORTANT

The wires in the mains lead are coloured in accordance with the following code:

Blue: Neutral

Brown: Live

As the colours of the wires in the mains lead of this apparatus may not correspond with the coloured markings identifying the terminals in your plug, proceed as follows:

The wire which is coloured blue must be connected to the terminal which is marked with the letter N or coloured black.

The wire which is coloured brown must be connected to the terminal which is marked with the letter L or coloured red.

IMPORTANT

The plug is fitted with an appropriate fuse. If the fuse needs to be replaced, the replacement fuse must be approved by ASTA or BSI to BS1362 and have the same ampere rating as that indicated on the plug. Check for the ASTA mark or the BSI mark on the body of the fuse.

If the power cord's plug is not suitable for your socket outlets, cut it off and fit a suitable plug. Fit a suitable fuse in the plug.

For European Models

Declaration of Conformity

We, ONKYO EUROPE
ELECTRONICS GmbH
LIEGNITZERSTRASSE 6,
82194 GROEBENZELL,
GERMANY



declare in own responsibility, that the ONKYO product described in this instruction manual is in compliance with the corresponding technical standards such as EN60065, EN55013, EN55020 and EN61000-3-2, -3-3.

GROEBENZELL, GERMANY

K. MIYAGI

ONKYO EUROPE ELECTRONICS GmbH

Supplied Accessories

Make sure you have the following accessories:

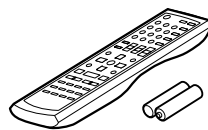

Remote controller & two batteries (AA/R6)

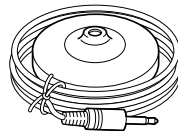

Speaker setup microphone



Indoor FM antenna

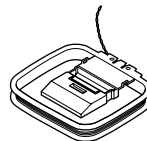

AM loop antenna

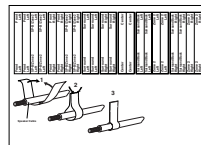

Speaker cable labels



Power-plug adapter

Only supplied in certain countries. Use this adapter if your AC outlet does not match with the plug on the AV receiver's power cord (adapter varies from country to country).

*How to mount the AC plug:

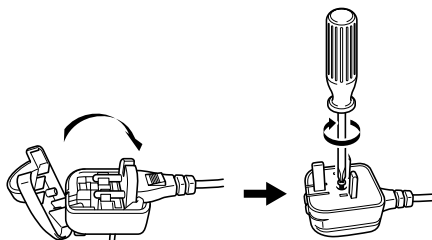

* In catalogs and on packaging, the letter at the end of the product name indicates the color. Specifications and operations are the same regardless of color.

Features

Amplifier

- 7-channel amplifier
- Optimum Gain Volume Circuitry
- Zone 2 capability
- 24-bit/192 kHz D/A converters
- WRAT (Wide Range Amplifier Technology)
- Color-coded speaker terminal posts

Audio/Video

- Dolby^{*1} Digital, Dolby Digital EX, Dolby Pro Logic IIx
- DTS^{*2}, DTS-ES Discrete, DTS-ES Matrix, DTS Neo:6, and DTS 96/24
- Pure Audio listening mode (not North American models)
- Neural Surround^{*3} (North American models only)
- 6 digital inputs (4 optical, 2 coaxial), 1 digital optical output
- Zone 2 line out
- 2 HDMI^{*4} inputs, 1 output (Version 1.1)
- Composite and S-Video to component video conversion
- Composite video to S-Video and S-Video to composite video conversion
- 3 component video inputs, 1 output
- 5 S-Video inputs, 3 outputs
- CinemaFILTER^{*5}
- Subwoofer pre out

FM/AM/XM Tuner

- 40 AM/FM presets
- AM/FM auto tuning
- XM Satellite Radio^{*6} (XM Passport System required; sold separately) (North American models only)
- RDS (Radio Data System) (European models only)

Others

- Audyssey^{*7} 2EQ to correct room acoustic problems
- Easy-to-use onscreen setup menus
- Preprogrammed remote controller for use with other AV components

TX-SR674/674E and TX-SR8467 Only

- 95 watts per channel into 8 ohms, 20 Hz to 20 kHz, less than 0.08% total harmonic distortion (FTC rating)
- VLSC^{*8} (Vector Linear Shaping Circuitry) all channels
- HDMI up-conversion from composite video, S-Video, and component video

TX-SR604/604E and TX-SR8460 Only

- 90 watts per channel into 8 ohms, 20 Hz to 20 kHz, less than 0.08% total harmonic distortion (FTC rating)
- VLSC^{*8} (Vector Linear Shaping Circuitry) on the front left and right channels



Manufactured under license from Dolby Laboratories. "Dolby", "Pro Logic" and the double-D symbol are registered trademarks of Dolby Laboratories.



"DTS," "DTS 96/24," "DTS-ES," and "Neo:6" are trademarks of DTS, Inc.



Neural Surround name and related logos are trademarks owned by Neural Audio Corporation.

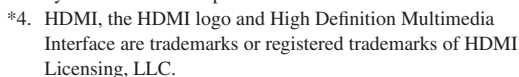

"CinemaFILTER" is a trademark of Onkyo Corporation.



XM Ready[®], XM Public Radio[™] are trademarks of XM Satellite Radio Inc. ©2006 XM Satellite Radio Inc. All rights reserved. All other trademarks are the property of their respective owners.

*7. Manufactured under license from Audyssey Laboratories. U.S. and foreign patents pending.

MultEQ or 2EQ is a trademark of Audyssey Laboratories.

*8. VLSC is a registered trademark of Onkyo Corporation.

Apple and iPod are trademarks of Apple Computer, Inc., registered in the U.S. and other countries.

"Xantech" is a registered trademark of Xantech Corporation.

"Niles" is a registered trademark of Niles Audio Corporation.

This product incorporates copyright protection technology that is protected by U.S. patents and other intellectual property rights. Use of this copyright protection technology must be authorized by Macrovision Corporation, and is intended for home and other limited consumer uses only unless otherwise authorized by Macrovision. Reverse engineering or disassembly is prohibited.

Table of Contents

Introduction	
Important Safety Instructions	2
Precautions	3
Supplied Accessories	4
Features	5
Front & Rear Panels	7
Remote Controller	12
About Home Theater	17

Connecting the AV Receiver	
About AV Connections	18
Connecting Your Speakers	19
Connecting Antenna.....	21
Connecting Your TV or Projector.....	24
Connecting AV Components	25
Connecting Audio Components.....	33
Connecting Onkyo RI Components	36
Connecting the Power Cord of Another Component.....	36
Turning On the AV Receiver	37

First Time Setup	
Automatic Speaker Setup (Audyssey2EQ)....	38
About the Onscreen Setup Menus.....	43
Digital Input.....	44
Video Input.....	45
Changing the Input Display	47
Minimum Speaker Impedance (not North American models)	47
TV Format Setup (not North American models) ...	48
AM Frequency Step Setup (on some models)...	48

Basic Operations	
Selecting the Input Source.....	49
Using the Multichannel DVD Input.....	50
Adjusting the Bass & Treble	50
Displaying Source Information.....	50
Setting the Display Brightness.....	51
Muting the AV Receiver	51
Using the Sleep Timer	51
Using Headphones	51
Using the Tuner	52
Presetting AM/FM Stations & XM Channels....	53
Using RDS (European models only).....	54

Listening to XM Satellite Radio® (North American models only)	56
Selecting Listening Modes	61
Listening Mode Table	62
About the Listening Modes.....	63
Recording	65

Advanced Operations	
Using the Late Night Function (Dolby Digital only)	66
Using the CinemaFILTER	66
Adjusting Individual Speaker Levels	66

Advanced Setup	
Speaker Setup	67
Multichannel DVD Input Settings	72
Audio Adjust Functions	72
Assigning Listening Modes to Input Sources	74
IntelliVolume.....	75
Volume Setup/OSD Setup	75
Changing the AV Receiver's ID.....	76
HDMI Audio Out	76
Lock Setup	77
Digital Input Signal Formats	77
Correcting Sound and Picture Sync	78
Changing the Remote Controller's ID	78

Zone 2	
Connecting Zone 2.....	79
Setting the Powered Zone 2.....	80
Using Zone 2.....	81
Using the Remote Control in Zone 2.....	82

Controlling Other Components	
Entering Remote Control Codes	83
Remote Control Codes for Onkyo Components Connected via RI	84
Resetting REMOTE MODE Buttons.....	84
Resetting the Remote Controller	84

Others	
Specifications	86
Troubleshooting	87

Front & Rear Panels

Front Panel

North American models

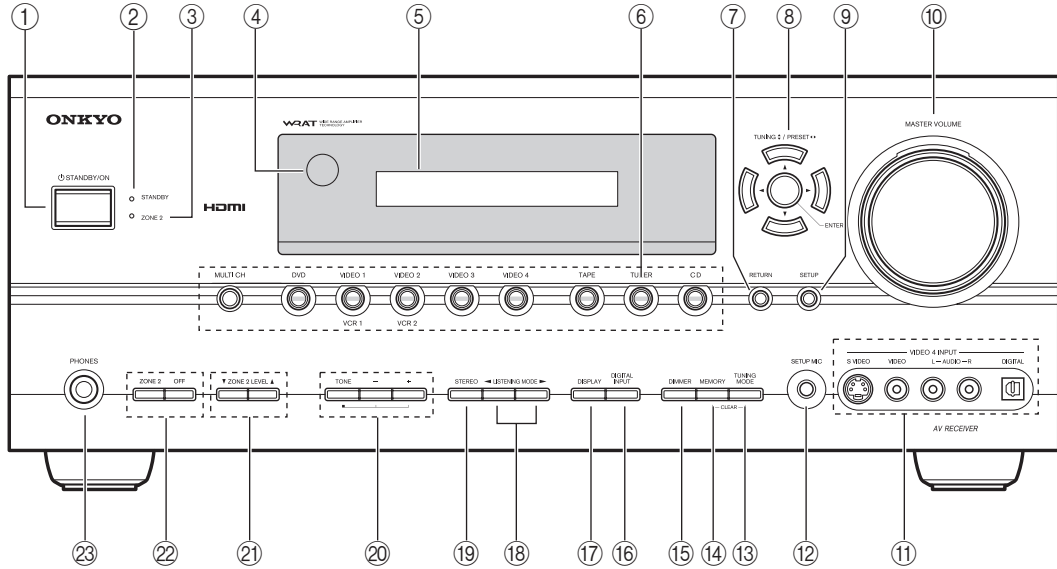

Other models

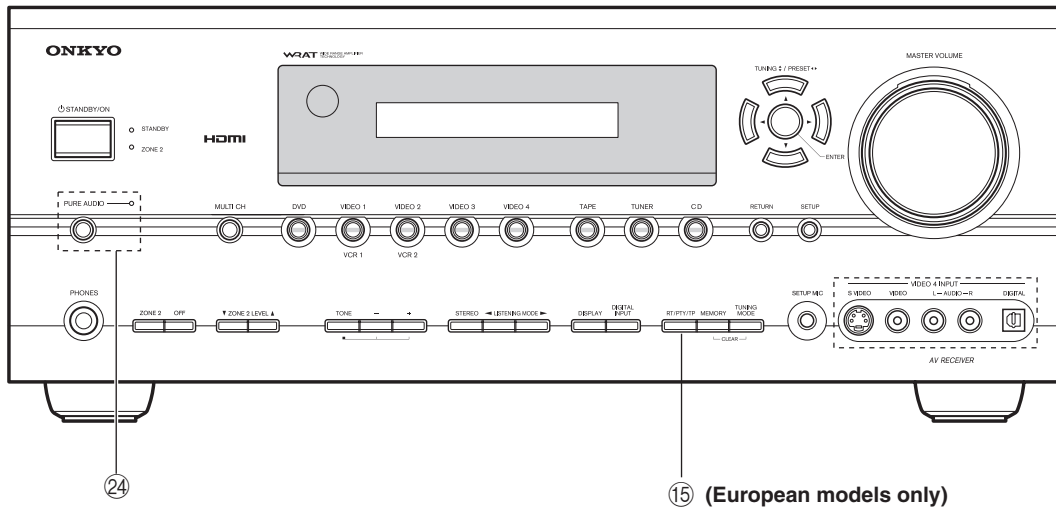

15 (European models only)

The page numbers in parentheses show where you can find the main explanation for each item.

- ① **STANDBY/ON button (37)**
This button is used to set the AV receiver to On or Standby.
- ② **STANDBY indicator (37)**
This indicator lights up when the AV receiver is in Standby mode, and it flashes while a signal is being received from the remote controller.
- ③ **ZONE 2 indicator (81)**
This indicator lights up when Zone 2 is selected.
- ④ **Remote control sensor (12)**
This sensor receives control signals from the remote controller.
- ⑤ **Display**
See “Display” on page 9.
- ⑥ **Input selector buttons (49)**
These buttons are used to select from the following input sources: MULTI CH, DVD, VIDEO 1, VIDEO 2, VIDEO 3, VIDEO 4, TAPE, TUNER or CD.
The [MULTI CH] button selects the DVD analog multichannel input.
- ⑦ **RETURN button**
This button is used to return to the previously displayed onscreen setup menu.

⑧ **Arrow/TUNING/PRESET & ENTER buttons**

When the AM or FM input source is selected, the TUNING [▲] [▼] buttons are used to tune the tuner, and the PRESET [◀] [▶] buttons are used to select radio presets (see page 53). When the onscreen setup menus are used, they work as arrow buttons and are used to select and set items. The [ENTER] button is also used with the onscreen setup menus.

⑨ **SETUP button**

This button is used to access the onscreen setup menus that appear on the connected TV.

⑩ **MASTER VOLUME control (49)**

This control is used to adjust the volume of the AV receiver to MIN, 1 through 99, or MAX.

⑪ **VIDEO 4 INPUT**

This input can be used to connect a camcorder, game console, and so on. There are jacks for optical digital audio, S-Video, composite video, and analog audio.

⑫ **SETUP MIC (38)**

The included speaker setup microphone is connected here for automatic speaker setup.

⑬ **TUNING MODE button (52)**

This button is used to select the Auto or Manual tuning mode.

⑭ **MEMORY button (53)**

This button is used when storing or deleting radio presets.

⑮ **DIMMER or RT/PTY/TP button (51, 55)**

DIMMER is used to adjust the display brightness.

On the European model, this is the RT/PTY/TP button, and it's for RDS (Radio Data System). See "Using RDS (European models only)" on page 54.

⑯ **DIGITAL INPUT button (44, 77)**

This button is used to assign the digital inputs and to specify the format of digital input signals.

⑰ **DISPLAY button (50)**

This button is used to display various information about the currently selected input source.

⑱ **LISTENING MODE [◀] [▶] buttons (61)**

These buttons are used to select the listening modes.

⑲ **STEREO button (61)**

This button is used to select the Stereo listening mode.

⑳ **TONE, [-] & [+] buttons (50)**

These buttons are used to adjust the bass and treble.

㉑ **ZONE 2 LEVEL button (82)**

This button is used to set the volume for Zone 2.

㉒ **ZONE 2/OFF button (81)**

The ZONE 2 button is used to select the input source for Zone 2.

The OFF button is used to turn off the output of Zone 2.

㉓ **PHONES jack (51)**

This 1/4-inch phone jack is for connecting a standard pair of stereo headphones for private listening.

㉔ **PURE AUDIO button and indicator (61)**

The North American models do not have this button and indicator.

Selects the Pure Audio listening mode. The indicator lights up when this mode is selected.

Display

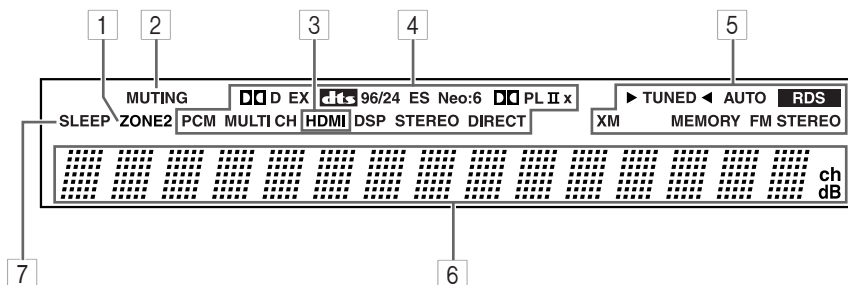

The page numbers in parentheses show where you can find the main explanation for each item.

- 1 **ZONE 2 indicator (81)**
This indicator lights up when Zone 2 is selected.
- 2 **MUTING indicator (51)**
This indicator flashes while the AV receiver is muted.
- 3 **HDMI indicator**
This indicator lights up when the HDMI input is used.
- 4 **Listening mode & format indicators**
These indicators show the currently selected listening mode and the format of digital input signals.
- 5 **Tuning indicators**
TUNED (52): This indicator lights up when the AV receiver is tuned into a radio station.
AUTO (52): This indicator lights up when the Auto Tuning mode is selected, and disappears when the Manual Tuning mode is selected.
- RDS (European models only) (54):** This indicator lights up when tuned to a radio station that supports RDS (Radio Data System).
- XM (North American models only) (56):** This indicator lights up when XM radio is selected.
- MEMORY (53):** This indicator lights up when pre-setting radio stations.
- FM STEREO (52):** This indicator lights up when the AV receiver is tuned to a stereo FM station.
- 6 **Message area**
This area of the display shows various information about the currently selected source.
- 7 **SLEEP indicator (51)**
This indicator lights up when the Sleep function has been set.

Rear Panel

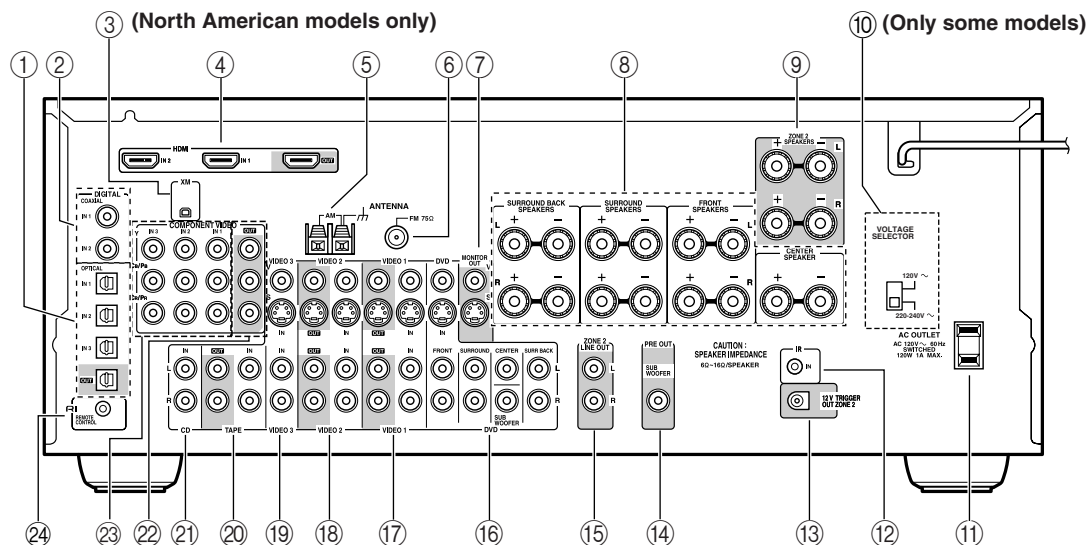

The page numbers in parentheses show where you can find the main explanation for each item.

① DIGITAL OPTICAL IN 1, 2, 3 and OUT

The optical digital audio inputs can be used to connect CD and DVD players, and other components with an optical digital audio output.

The optical output can be used connect a CD recorder or other digital recorder with an optical digital input.

② DIGITAL COAXIAL IN 1, 2

The coaxial digital audio inputs can be used to connect CD and DVD players, and other components with a coaxial digital audio output.

③ XM antenna (on North American models)

This jack is for connecting an XM antenna, sold separately (see page 56).

④ HDMI IN 1, 2, and OUT

HDMI (High Definition Multimedia Interface) connections carry digital audio and digital video.

The HDMI inputs are for connecting components with HDMI outputs, such as DVD players.

The HDMI output is for connecting a TV or projector with an HDMI input.

⑤ AM ANTENNA (21)

These push terminals are for connecting an AM antenna.

⑥ FM ANTENNA (21)

This jack is for connecting an FM antenna.

⑦ MONITOR OUT

The S-Video or composite video jack should be connected to a video input on your TV or projector.

⑧ FRONT, CENTER, SURROUND & SURROUND BACK SPEAKERS (20)

These terminal posts are for connecting your front, center, surround, and surround back speakers.

⑨ ZONE 2 SPEAKERS (79)

These terminals are for connecting speakers in Zone 2.

⑩ VOLTAGE SELECTOR (only some models)

This voltage selector provides compatibility with power systems around the world (see page 3).

⑪ AC OUTLET

This switched AC outlet can be used to supply power to other AV components. The type of outlet depends on the country in which you purchased your AV receiver.

⑫ IR IN (82)

If you want to use the remote controller to control the AV receiver from Zone 2, or if the AV receiver is installed in a cabinet and the line of sight between the AV receiver and the remote controller is obstructed, a commercially available IR receiver can be connected here.

⑬ 12V TRIGGER OUT ZONE 2 (81)

This output can be connected to the 12-volt trigger input on a power amplifier in Zone 2. When Zone 2 is turned on, a 12-volt trigger signal is output.

⑭ PRE OUT SUBWOOFER (19)

The SUBWOOFER jack is for connecting a powered subwoofer.

- ⑮ **ZONE 2 LINE OUT (79)**
This analog audio output can be connected to a line input on an integrated amplifier in Zone 2.
- ⑯ **DVD IN**
Here you can connect a DVD player. Input jacks include S-Video, composite video, and analog audio. You can connect a DVD player's 2-channel analog audio output or 7.1-channel analog audio output.
- ⑰ **VIDEO 1 IN/OUT**
Here you can connect a VCR. Input and output jacks include S-Video, composite video, and analog audio.
- ⑱ **VIDEO 2 IN/OUT**
Here you can connect a VCR. Input and output jacks include S-Video, composite video, and analog audio.
- ⑲ **VIDEO 3 IN**
Here you can connect a video source (VCR, set-top box, etc.). Input jacks include S-Video, composite video, and analog audio.
- ⑳ **TAPE IN/OUT**
This analog audio input and output are for connecting a recorder with an analog audio input and output (cassette, Mini Disc, etc.).
- ㉑ **CD IN**
This analog audio input is for connecting a CD player's analog audio output.
- ㉒ **COMPONENT VIDEO OUT**
This component video output can be used to connect a TV or projector with a component video input.
- ㉓ **COMPONENT VIDEO IN 1, 2, 3**
These component video inputs can be used to connect AV components with component video outputs, such as DVD players.
- ㉔ **RI REMOTE CONTROL**
This **RI** (Remote Interactive) jack can be connected to an **RI** jack on another Onkyo AV component. The AV receiver's remote controller can then be used to control that component. To use **RI**, you must make an analog audio connection (RCA) between the AV receiver and the other AV component, even if they are connected digitally.

See pages 18-36 for connection information.

Remote Controller

Installing the Batteries

- 1 To open the battery compartment, press the small hollow and slide off the cover.**

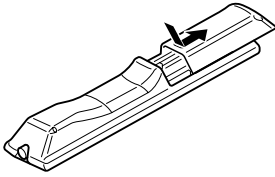

- 2 Insert the two supplied batteries (AA/R6) in accordance with the polarity diagram inside the battery compartment.**

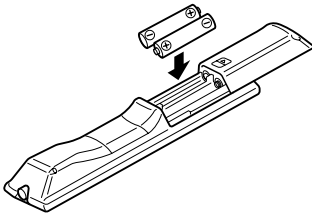

- 3 Put the cover onto the remote controller and slide it shut.**

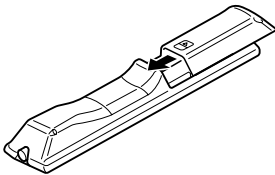

Notes:

- If the remote controller doesn't work reliably, try replacing the batteries.
- Don't mix new and old batteries or different types of batteries.
- If you intend not to use the remote controller for a long time, remove the batteries to prevent damage from leakage or corrosion.
- Expired batteries should be removed as soon as possible to prevent damage from leakage or corrosion.

Aiming the Remote Controller

To use the remote controller, point it at the AV receiver's remote control sensor, as shown below.

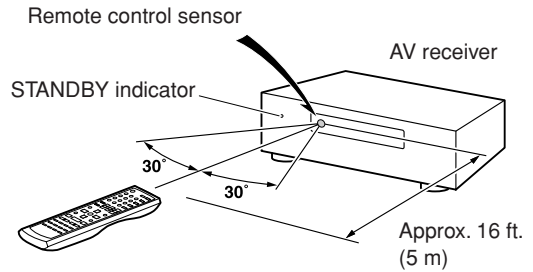

Notes:

- The remote controller may not work reliably if the AV receiver is subjected to bright light, such as direct sunlight or inverter-type fluorescent lights. Keep this in mind when installing.
- If another remote controller of the same type is used in the same room, or the AV receiver is installed close to equipment that uses infrared rays, the remote controller may not work reliably.
- Don't put anything, such as a book, on the remote controller, because the buttons may be pressed inadvertently, thereby draining the batteries.
- The remote controller may not work reliably if the AV receiver is installed in a rack behind colored glass doors. Keep this in mind when installing.
- The remote controller will not work if there's an obstacle between it and the AV receiver's remote control sensor.

Using the Remote Controller

The remote controller can be used to control different components including the AV receiver. The remote controller has a specific operating mode for use with each type of component. Modes are selected by using the six REMOTE MODE buttons.

■ RECEIVER/TAPE Mode

In RECEIVER/TAPE mode, you can control the AV receiver and an Onkyo cassette recorder connected via **RI**.

■ DVD and CD/MD/CDR/HDD Modes

With these modes, you can control a DVD player and CD, MD, CDR, or HDD player or recorder. By entering the appropriate remote control code, you can control Onkyo components or components made by other manufacturers (see page 83).

■ TV, VCR and SAT/CABLE Modes

With these modes, you can control a TV, VCR, and satellite or cable receiver. You must enter the appropriate remote control code first (see page 83).



1

Press one of the REMOTE MODE buttons to select a mode.

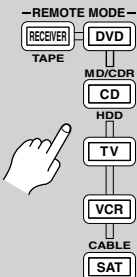

2

Use the buttons supported by that mode to control the component.

RECEIVER/TAPE mode:
see right column

DVD mode:
see page 15

CD/MD/CDR/HDD mode:
see page 16

TV, VCR, SAT/CABLE modes:
see page 85

RECEIVER/TAPE Mode

RECEIVER/TAPE mode is used to control the AV receiver. It can also be used to control an Onkyo cassette recorder connected via **RI**.

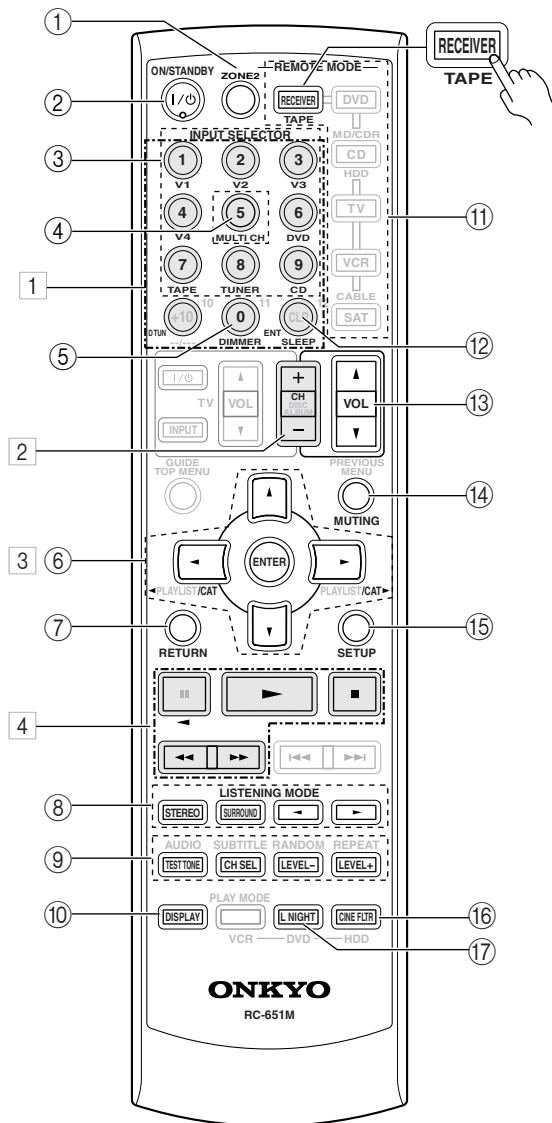

Buttons **1**, **2**, **3**, and **4** are used when the TUNER or TAPE input is selected.

Note:

Some of the remote controller operations described in this manual may not work as expected with other components.

For detailed information, see the pages in parentheses.

- ① **ZONE 2 button (81)**
Used to select the input source for Zone 2.
- ② **ON/STANDBY button (37)**
Sets the AV receiver to On or Standby.
- ③ **INPUT SELECTOR buttons (49)**
Used to select the input sources.
- ④ **MULTI CH button (50)**
Selects the multichannel DVD input.
- ⑤ **DIMMER button (51)**
Adjusts the display brightness.
- ⑥ **Arrow [▲]/[▼]/[◀]/[▶] and ENTER buttons**
Used to select and adjust settings.
- ⑦ **RETURN button**
Selects the previously displayed setup menu.
- ⑧ **LISTENING MODE buttons (61)**
Used to select the listening modes. These buttons work in all remote controller modes.
 - STEREO button**
Selects the Stereo listening mode.
 - SURROUND button**
Selects the Dolby and DTS listening modes and the Neural Surround listening mode (North American models only).
 - [◀]/[▶] buttons**
Used to select the available listening modes.
- ⑨ **TEST TONE, CH SEL, LEVEL-, and LEVEL+ buttons (66, 70)**
Used to adjust the level of each speaker.
- ⑩ **DISPLAY button (50)**
Displays various information about the selected input source.
- ⑪ **REMOTE MODE buttons (13)**
Used to select the remote controller modes. When a remote controller button is pressed, the REMOTE MODE button for the currently selected mode lights up.
- ⑫ **SLEEP button (51)**
Used with the Sleep function.
- ⑬ **VOL [▲]/[▼] button (49)**
Adjusts the volume of the AV receiver regardless of the currently selected remote controller mode.
- ⑭ **MUTING button (51)**
Mutes or unmutes the AV receiver.
- ⑮ **SETUP button**
Used to access the setup menus.
- ⑯ **CINE FLTR button (66)**
Used with the CinemaFILTER function.
- ⑰ **L NIGHT button (66)**
Used with the Late Night function.

■ Buttons used when the TUNER input is selected

To select the Tuner (AM/FM/XM) as the input source, press:



- 1 **Number, D TUN, and ENT buttons (52, 58)**
Used to select AM and FM radio stations and XM radio channels directly.
- 2 **CH +/- button (53)**
Used to select radio presets.
- 3 **Arrow [▲]/[▼]/[◀]/[▶] and ENTER buttons**
For AM and FM, the Up and Down [▲]/[▼] buttons are used for tuning.

North American models only

For XM, the Up and Down [▲]/[▼] buttons are used to select channels, and the [ENTER] button is used to change the search mode. The Left and Right [◀]/[▶] buttons are used to select categories.

■ Buttons used when the TAPE input is selected

To select your Cassette deck as the input source, press:



- 4 **Playback buttons**
On twin cassette decks, only deck B can be controlled.
 - Play [▶] button**
Starts playback.
 - Stop [■] button**
Stops playback.
 - Reverse Play [◀] button**
Starts reverse playback.
 - Rewind and FF [◀◀]/[▶▶] buttons**
The Rewind [◀◀] button starts rewind. The FF [▶▶] button starts fast forward.

DVD Mode

By default, the remote controller is set to control an Onkyo DVD player.

To select your DVD player as the input source, press:

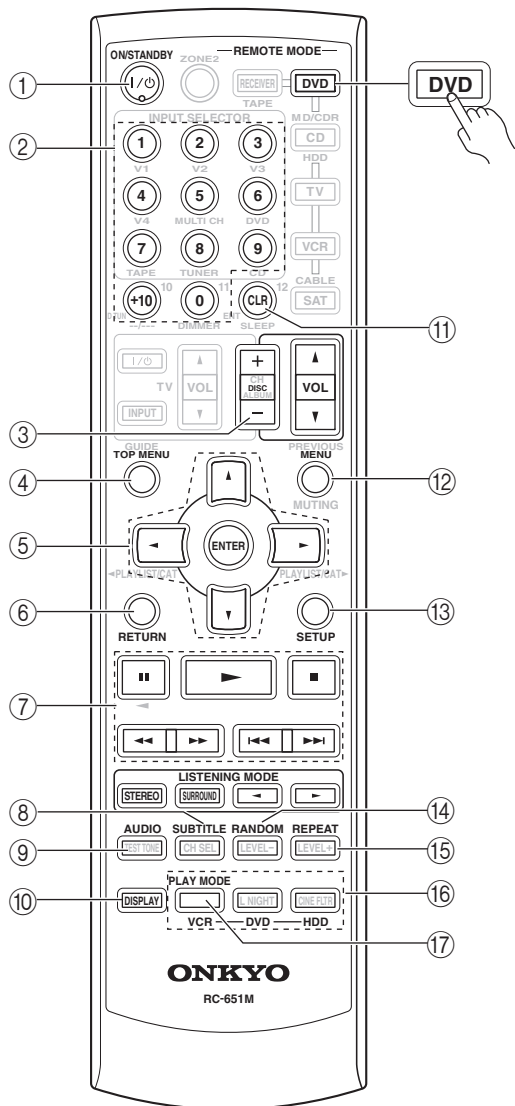

- ① **ON/STANDBY button**
Sets the DVD player to On or Standby.
- ② **Number buttons**
Used to enter title, chapter, and track numbers and times for locating specific points.
- ③ **DISC +/- button**
Selects discs on a DVD changer.
- ④ **TOP MENU button**
Selects a DVD's top menu.
- ⑤ **Arrow [▲]/[▼]/[◀]/[▶] and ENTER buttons**
Used to navigate DVD menus and the DVD player's onscreen setup menus.
- ⑥ **RETURN button**
Exits the DVD player's onscreen setup menus.
- ⑦ **Playback buttons**
From left to right: Pause, Play, Stop, Fast Reverse, Fast Forward, Previous, and Next.
- ⑧ **SUBTITLE button**
Selects subtitles.
- ⑨ **AUDIO button**
Selects foreign language soundtracks and audio formats (e.g., Dolby Digital or DTS).
- ⑩ **DISPLAY button**
Displays information about the current disc, title, chapter, or track, including elapsed time, remaining time, total time, and so on.
- ⑪ **CLR button**
Cancels functions and clears entered numbers.
- ⑫ **MENU button**
Displays a DVD's menu.
- ⑬ **SETUP button**
Used to access the DVD player's onscreen setup menus.
- ⑭ **RANDOM button**
Used with the random playback function.
- ⑮ **REPEAT button**
Used with the repeat playback functions.
- ⑯ **VCR, DVD, and HDD buttons**
Used to select VCR, HDD (hard disk drive), or DVD playback on a VCR/DVD recorder with a built-in hard disk drive.
- ⑰ **PLAY MODE button**
Selects play modes on components with selectable play modes.

CD/MD/CDR/HDD Mode

By default, the remote controller is set to control an Onkyo CD player.

To select the input source, press:



* If you're using an MD, CDR, or HDD component, you must change the input display (see page 47).

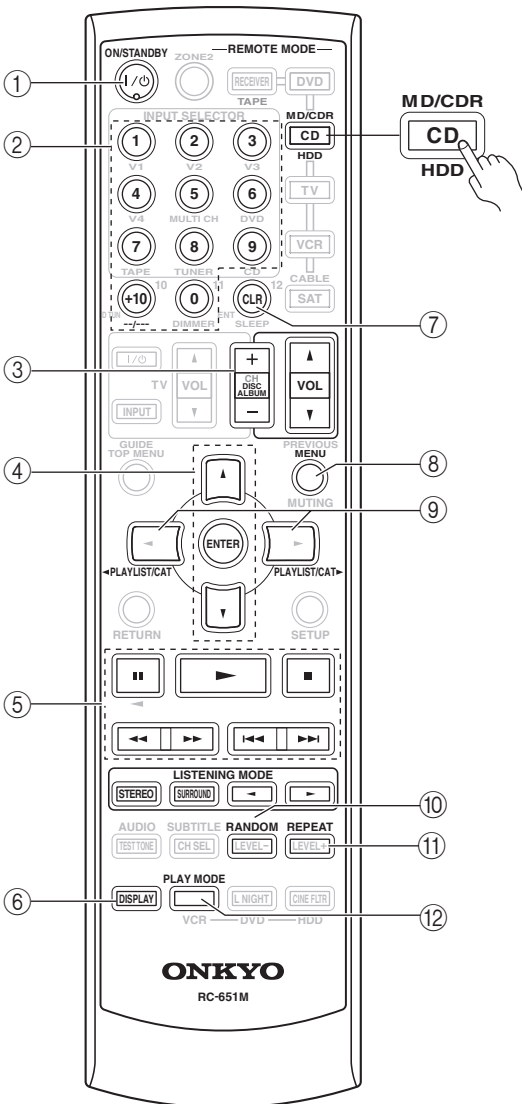

- ① **ON/STANDBY button**
Sets the component to On or Standby.
- ② **Number buttons**
Used to enter track numbers and times for locating specific points on CD/MD players.
- ③ **DISC/ALBUM +/- button**
Selects discs on a CD changer, or the next or previous album on an HDD-compatible component.
- ④ **Arrow [▲]/[▼] and ENTER buttons**
Used to navigate menus on an HDD-compatible component.
- ⑤ **Playback buttons**
From left to right: Pause, Play, Stop, Fast Reverse, Fast Forward, Previous and Next.
- ⑥ **DISPLAY button**
Displays information about the current disc or track on a CD player or MD/CD recorder, including elapsed time, remaining time, total time, and so on. On an HDD-compatible component, it turns on the back light for 30 seconds.
- ⑦ **CLR button**
Cancels functions and clears entered numbers on a CD player or MD/CD recorder.
- ⑧ **MENU button**
Used to navigate menus on an HDD-compatible component.
- ⑨ **PLAYLIST [◀]/[▶] buttons**
Selects the previous or next playlist on an HDD-compatible component.
- ⑩ **RANDOM button**
Used with the random/shuffle playback function.
- ⑪ **REPEAT button**
Used with the repeat playback functions.
- ⑫ **PLAY MODE button**
Used to select play modes on components with selectable play modes.

About Home Theater

Enjoying Home Theater

Thanks to the AV receiver's superb capabilities, you can enjoy surround sound with a real sense of movement in your own home—just like being in a movie theater or concert hall. With DVDs you can enjoy DTS and Dolby Digital. With analog and digital TV you can enjoy Dolby Pro Logic IIx or Onkyo's own DSP surround listening modes.

Front left and right speakers

These output the overall sound. Their role in a home theater is to provide a solid anchor for the sound image. They should be positioned facing the listener at about ear level, and equidistant from the TV. Angle them inward so as to create a triangle, with the listener at the apex.

Center speaker

This speaker enhances the front left and right speakers, making sound movements distinct and providing a full sound image. In movies it's used mainly for dialog.

Position it close to your TV facing forward at about ear level, or at the same height as the front left and right speakers.

Subwoofer

The subwoofer handles the bass sounds of the LFE (Low-Frequency Effects) channel. The volume and quality of the bass output from your subwoofer will depend on its position, the shape of your listening room, and your listening position. In general, a good bass sound can be obtained by installing the subwoofer in a front corner, or at one-third the width of the wall, as shown.

Tip: To find the best position for your subwoofer, while playing a movie or some music with good bass, experiment by placing your subwoofer at various positions within the room, and choose the one that provides the most satisfying results.

Surround back left and right speakers

These speakers are necessary to enjoy Dolby Digital EX, DTS-ES Matrix, and DTS-ES Discrete. They enhance the realism of surround sound and improve sound localization behind the listener. Position them behind the listener about 2–3 feet (60–100 cm) above ear level.

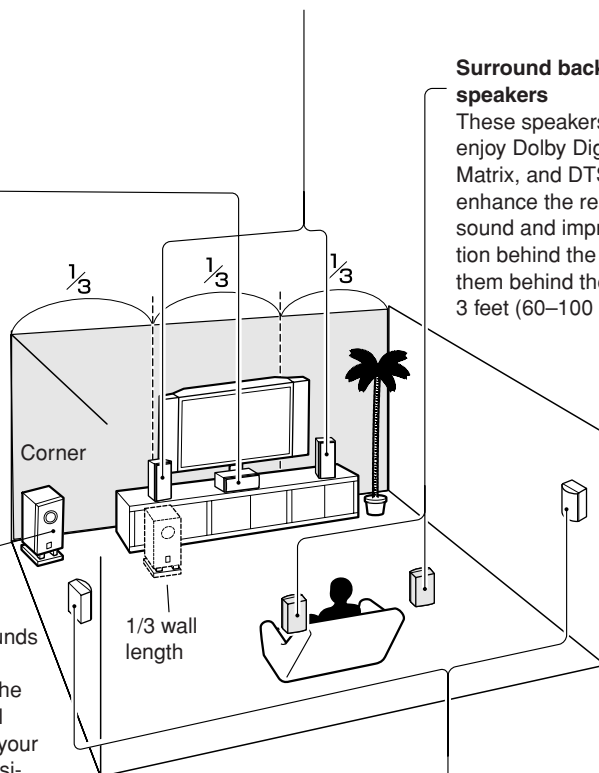

Surround left and right speakers

These speakers are used for precise sound positioning and to add realistic ambience.

Position them at the sides of the listener, or slightly behind, about 2–3 feet (60–100 cm) above ear level. Ideally they should be equidistant from the listener.

Connecting the AV Receiver

About AV Connections

- Before making any AV connections, read the manuals supplied with your other AV components.
- Don't connect the power cord until you've completed and double-checked all AV connections.

Optical Digital Jacks

The AV receiver's optical digital jacks have shutter-type covers that open when an optical plug is inserted and close when it's removed. Push plugs in all the way.

Caution: To prevent shutter damage, hold the optical plug straight when inserting and removing.

AV Connection Color Coding

RCA-type AV connections are usually color-coded: red, white, and yellow. Use red plugs to connect right-channel audio inputs and outputs (typically labeled "R"). Use white plugs to connect left-channel audio inputs and outputs (typically labeled "L"). And use yellow plugs to connect composite video inputs and outputs.

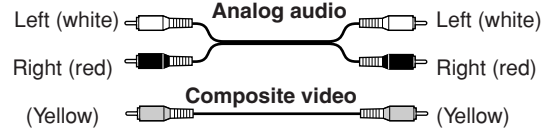

- Push plugs in all the way to make good connections (loose connections can cause noise or malfunctions).
- To prevent interference, keep audio and video cables away from power cords and speaker cables.

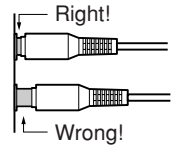

AV Cables & Jacks

Video

Cable	Jack	Description
		Component video separates the luminance (Y) and color difference signals (PR, PB), providing the best picture quality (some TV manufacturers label their component video sockets slightly differently).
		S-Video separates the luminance and color signals and provides better picture quality than composite video.
		Composite video is commonly used on TVs, VCRs, and other video equipment. Use only dedicated composite video cables.

Audio

Cable	Jack	Description
		Offers the best sound quality and allows you to enjoy surround sound (e.g., Dolby Digital, DTS). The audio quality is the same as for coaxial.
		Offers the best sound quality and allows you to enjoy surround sound (e.g., Dolby Digital, DTS). The audio quality is the same as for optical.
		This cable carries analog audio. It's the most common connection format for analog audio, and can be found on virtually all AV components.
		This cable carries multichannel analog audio and it's typically used to connect DVD players with a 7.1-channel analog audio output. Several standard analog audio cables can be used instead of a multi-channel cable.

Note: The AV receiver does not support SCART plugs.

Connecting Your Speakers

Speaker Configuration

For the best surround sound experience, you should connect seven speakers and a powered subwoofer.

The following table indicates the channels you should use depending on the number of speakers that you have.

Number of speakers:	2	3	4	5	6	7
Front left	✓	✓	✓	✓	✓	✓
Front right	✓	✓	✓	✓	✓	✓
Center		✓		✓	✓	✓
Surround left			✓	✓	✓	✓
Surround right			✓	✓	✓	✓
Surround back					✓	
Surround back left*						✓
Surround back right*						✓

*If you're using only one surround back speaker, connect it to the left (L) SURROUND BACK SPEAKERS terminals.

No matter how many speakers you use, a powered subwoofer is recommended for a really powerful and solid bass.

To get the best from your surround sound system, you need to set the speaker settings by using the supplied setup microphone (see page 38).

Using Dipole Speakers

You can use dipole speakers for the surround left and right and surround back left and right speakers. Dipole speakers output the same sound in two directions.

Dipole speakers typically have an arrow printed on them to indicate how they should be positioned. The surround left and right dipole speakers should be positioned so that their arrows point toward the TV/screen, while the surround back left and right dipole speakers should be positioned so that their arrows point toward each other, as shown.

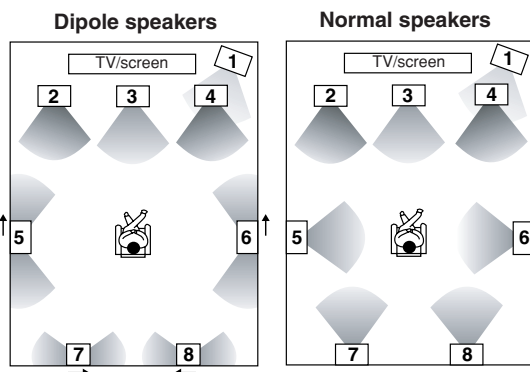

1. Subwoofer
2. Front left speaker
3. Center speaker
4. Front right speaker
5. Surround left speaker
6. Surround right speaker
7. Surround back left speaker
8. Surround back right speaker

Connecting a Powered Subwoofer

Using a suitable cable, connect the AV receiver's PRE OUT SUBWOOFER to an input on your powered subwoofer, as shown. If your subwoofer is unpowered and you're using an external amplifier, connect the PRE OUT SUBWOOFER to an input on the amp.

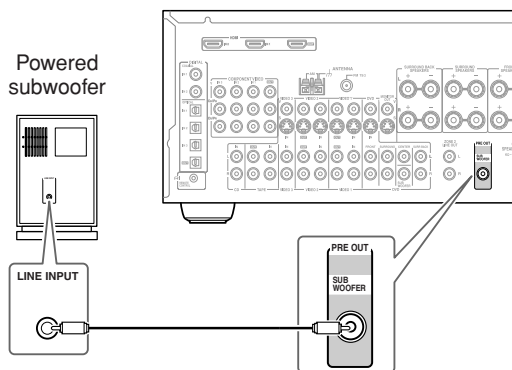

Attaching the Speaker Labels

The AV receiver's positive (+) speaker terminals are color-coded for ease of identification (the negative (-) speaker terminals are all black).

Speaker terminal	Color
Front left, Zone 2 left	White
Front right, Zone 2 right	Red
Center	Green
Surround left	Blue
Surround right	Gray
Surround back left	Brown
Surround back right	Tan

The supplied speaker labels are also color-coded and you should attach them to the positive (+) side of each speaker cable in accordance with the above table. Then all you need to do is to match the color of each label to the corresponding speaker terminal.



Connecting the AV Receiver—Continued



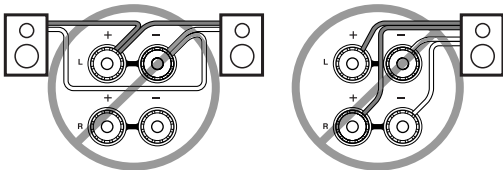
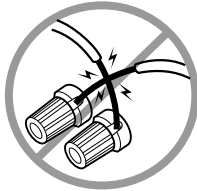

Speaker Connection Precautions

Read the following before connecting your speakers:

- **North American models:** Only connect speakers with an impedance of 6 ohms or higher. If you use speakers with a lower impedance, and use the amplifier at high volume levels for a long period of time, the built-in protection circuit may be activated.
- **Other models:** You can connect speakers with an impedance of between 4 and 16 ohms. If the impedance of any of the connected speakers is 4 ohms or more, but less than 6 ohms, be sure to set the minimum speaker impedance to “4 ohms” (see page 47). If you use speakers with a lower impedance, and use the amplifier at high volume levels for a long period of time, the built-in protection circuit may be activated.
- Disconnect the power cord from the wall outlet before making any connections.
- Read the instructions supplied with your speakers.
- Pay close attention to speaker wiring polarity. In other words, connect positive (+) terminals only to positive (+) terminals, and negative (–) terminals only to negative (–) terminals. If you get them the wrong way around, the sound will be out of phase and will sound unnatural.
- Unnecessarily long, or very thin speaker cables may affect the sound quality and should be avoided.
- If you use 4 or 5 speakers, connect each of the two surround speakers to the SURROUND SPEAKERS terminals. Do not connect them to the SURROUND BACK SPEAKERS terminals.
- Be careful not to short the positive and negative wires. Doing so may damage the AV receiver.
- Make sure the metal core of the wire does not have contact with the AV receiver’s rear panel. Doing so may damage the AV receiver.
- Don’t connect more than one cable to each speaker terminal. Doing so may damage the AV receiver.
- Don’t connect one speaker to several terminals.

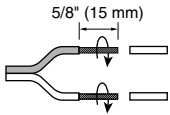

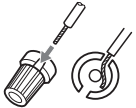
Connecting the Speaker Cables

1	Strip about 5/8" (15 mm) of insulation from the ends of the speaker cables, and twist the bare wires tightly, as shown.	
2	Unscrew the terminal.	
3	Fully insert the bare wires.	
4	Screw the terminal tight.	

The following illustration shows which speaker should be connected to each pair of terminals.

If you’re using only one surround back speaker, connect it to the left (L) SURROUND BACK SPEAKERS terminals.

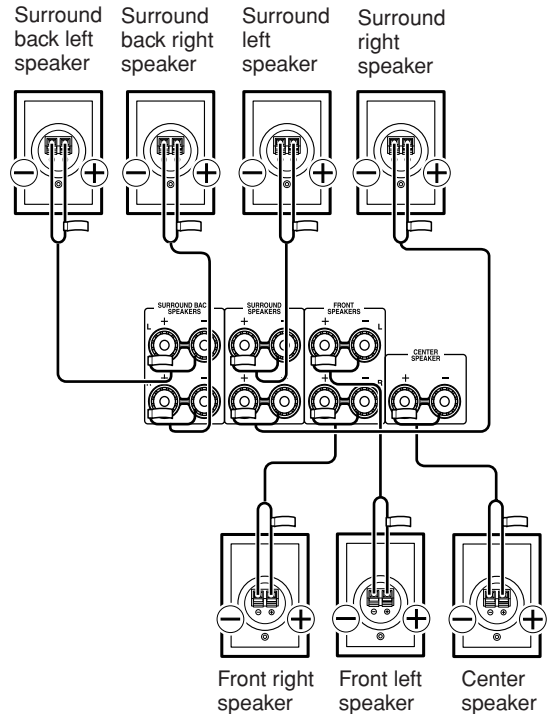

Connecting the AV Receiver—Continued

Connecting Antenna

This section explains how to connect the supplied indoor FM antenna and AM loop antenna, and how to connect commercially available outdoor FM and AM antennas. The AV receiver won't pick up any radio signals without any antenna connected, so you must connect the antenna to use the tuner.

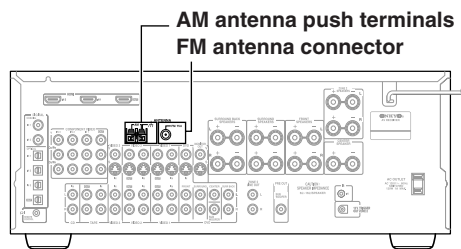

Connecting the Indoor FM Antenna

The supplied indoor FM antenna is for indoor use only.

1 Attach the FM antenna, as shown.

■ North American models

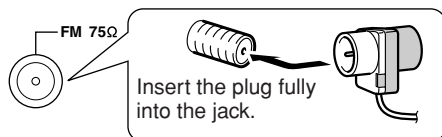

■ Other models

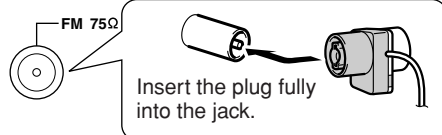

Once your AV receiver is ready for use, you'll need to tune into an FM radio station and adjust the position of the FM antenna to achieve the best possible reception.

2 Use thumbtacks or something similar to fix the FM antenna into position.

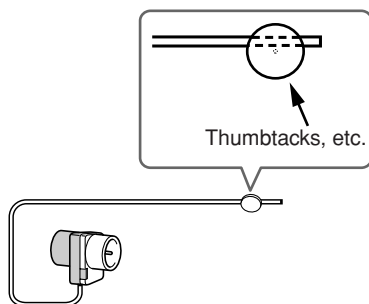

Caution: Be careful that you don't injure yourself when using thumbtacks.

If you cannot achieve good reception with the supplied indoor FM antenna, try a commercially available outdoor FM antenna instead (see page 22).

Connecting the AM Loop Antenna

The supplied indoor AM loop antenna is for indoor use only.

1 Assemble the AM loop antenna, inserting the tabs into the base, as shown.

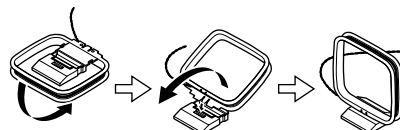

2 Connect both wires of the AM loop antenna to the AM push terminals, as shown.

(The antenna's wires are not polarity sensitive, so they can be connected either way around.)

Make sure that the wires are attached securely and that the push terminals are gripping the bare wires, not the insulation.

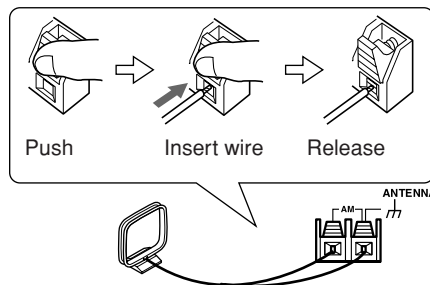

Once your AV receiver is ready for use, you'll need to tune into an AM radio station and adjust the position of the AM antenna to achieve the best possible reception.

Keep the antenna as far away as possible from your AV receiver, TV, speaker cables, and power cords.

If you cannot achieve good reception with the supplied indoor AM loop antenna, try using it with a commercially available outdoor AM antenna (see page 22).

Connecting the AV Receiver—Continued

Connecting an Outdoor FM Antenna

If you cannot achieve good reception with the supplied indoor FM antenna, try a commercially available outdoor FM antenna instead.

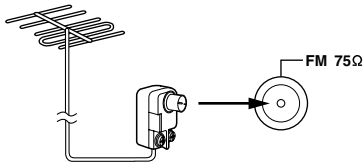

Notes:

- Outdoor FM antennas work best outside, but usable results can sometimes be obtained when installed in an attic or loft.
- For best results, install the outdoor FM antenna well away from tall buildings, preferably with a clear line of sight to your local FM transmitter.
- Outdoor antenna should be located away from possible noise sources, such as neon signs, busy roads, etc.
- For safety reasons, outdoor antenna should be situated well away from power lines and other high-voltage equipment.
- Outdoor antenna must be grounded in accordance with local regulations to prevent electrical shock hazards.

■ Using a TV/FM Antenna Splitter

It's best not to use the same antenna for both FM and TV reception, as this can cause interference problems. If circumstances demand it, use a TV/FM antenna splitter, as shown.

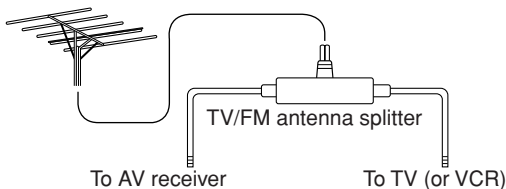

Connecting an Outdoor AM Antenna

If good reception cannot be achieved using the supplied AM loop antenna, an outdoor AM antenna can be used in addition to the loop antenna, as shown.

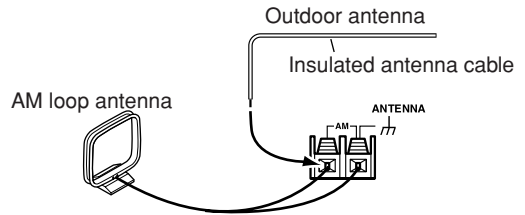

Outdoor AM antennas work best when installed outside horizontally, but good results can sometimes be obtained indoors by mounting horizontally above a window. Note that the AM loop antenna should be left connected.

Outdoor antenna must be grounded in accordance with local regulations to prevent electrical shock hazards.

Connecting the AV Receiver—Continued

Connecting Both Audio & Video

By connecting both the audio and video outputs of your DVD player and other AV components to the AV receiver, you can select both the audio and video simultaneously simply by selecting the appropriate input source on the AV receiver.

⤴ : Signal Flow

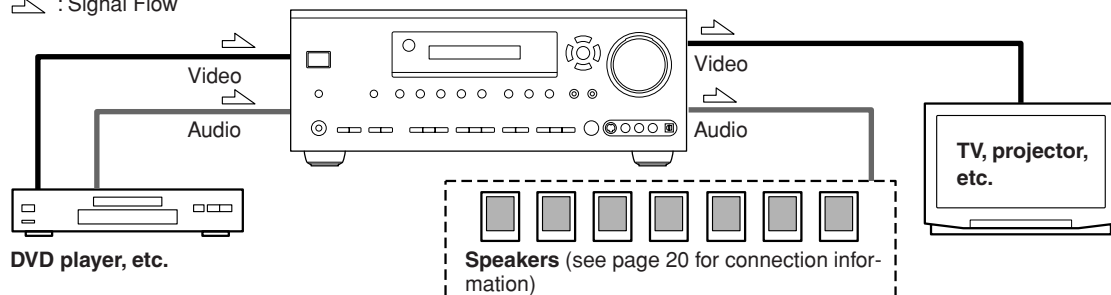

Which Connections Should I Use?

The AV receiver supports several connection formats for compatibility with a wide range of AV equipment. The format you choose will depend on the formats supported by your other components. Use the following sections as a guide. For video components, you must make two connections—one for audio, one for video.

Video Connection Formats

Video equipment can be connected to the AV receiver by using any one of the following video connection formats: composite video, S-Video, or component video, the latter offering the best picture quality.

A video signal connected to a V or S IN jack will be converted—composite video to S-Video or S-Video to composite video—but only for the MONITOR OUT jacks, not the VIDEO 1 and VIDEO 2 OUT V and S jacks.

Notes:

- The AV receiver can be set to upconvert composite video and S-Video input signals and output them from the COMPONENT VIDEO OUT (see page 46).
- For details on the HDMI jacks, see page 32.
- Depending on the settings made on the AV receiver, the “composite video to S-Video” and “S-Video to composite video” conversions may not work (see page 46).

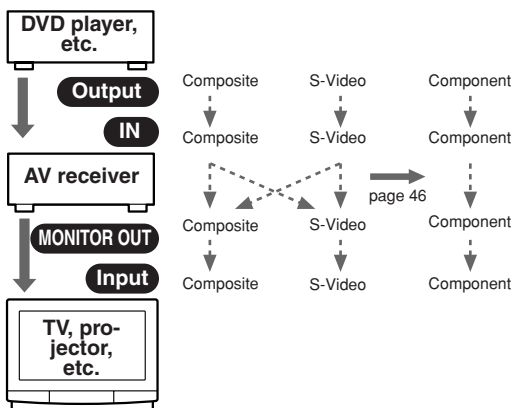

Audio Connection Formats

Audio equipment can be connected to the AV receiver by using any of the following audio connection formats: analog, optical, coaxial, or multichannel.

When choosing a connection format, bear in mind that the AV receiver doesn't convert between them. For example, audio signals connected to an OPTICAL or COAXIAL input are not output by the analog TAPE OUT.

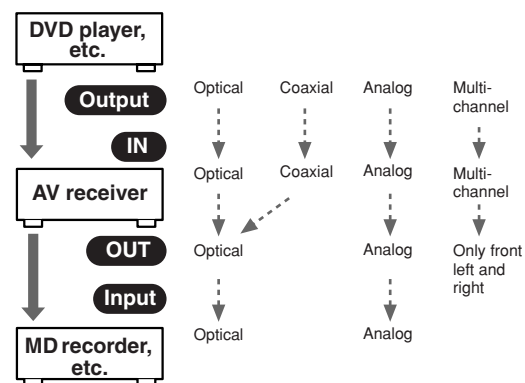

Connecting the AV Receiver—Continued

Connecting Your TV or Projector

Step 1: Video Connection

Choose a video connection that matches your TV (**A**, **B**, or **C**), and then make the connection.

Step 2: Audio Connection

Choose an audio connection that matches your TV (**a**, **b**, or **c**), and then make the connection.

- With connection **a**, you can listen to and record audio from your TV and listen in Zone 2.
- To enjoy Dolby Digital and DTS, use connection **b** or **c**. (For recording, use **a** and **b**, or **a** and **c**.)

Connection	AV receiver	Signal flow	TV	Picture quality
A	COMPONENT VIDEO OUT	⇒	Component video input	Best
B	MONITOR OUT S	⇒	S-Video input	Better
C	MONITOR OUT V	⇒	Composite video input	Standard
a	VIDEO 3 IN L/R	←	Analog audio L/R output	
b	DIGITAL COAXIAL IN 2	←	Digital coaxial output	
c	DIGITAL OPTICAL IN 2	←	Digital optical output	

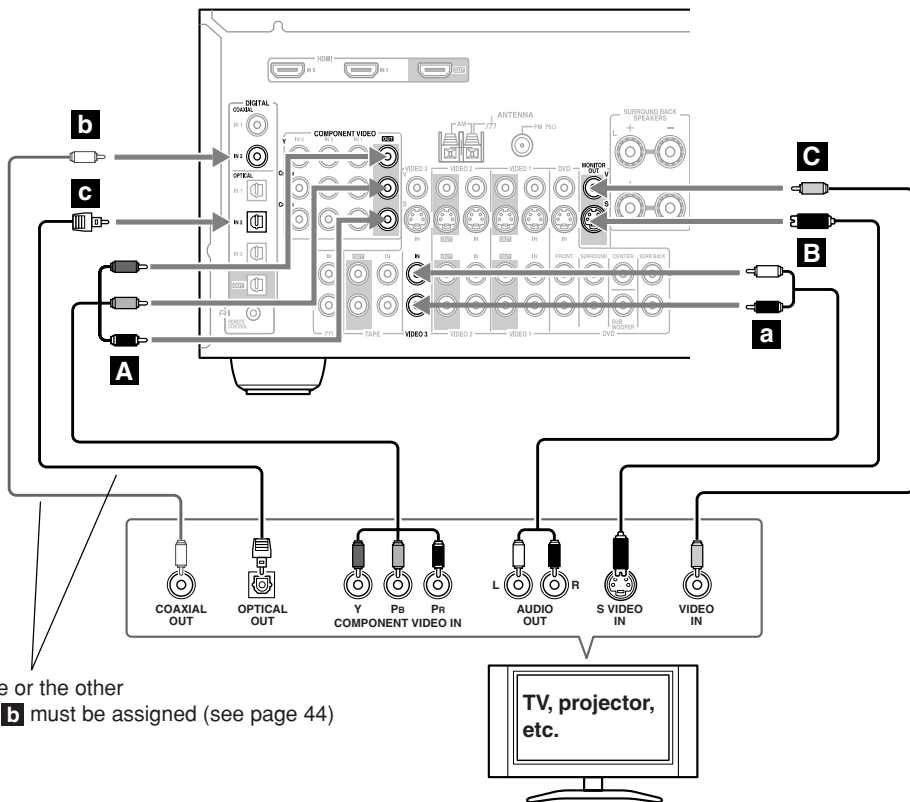

Connect one or the other
Connection **b** must be assigned (see page 44)



If your TV has no audio outputs, connect an audio output from your VCR or cable or satellite receiver to the AV receiver and use its tuner to listen to TV programs through the AV receiver (see pages 27 and 29).

Connecting the AV Receiver—Continued

Connecting a DVD Player

Step 1: Video Connection

Choose a video connection that matches your DVD player (**A**, **B**, or **C**), and then make the connection. You must connect the AV receiver to your TV via the same type of connection.

Step 2: Audio Connection

Choose an audio connection that matches your DVD player (**a**, **b**, or **c**), and then make the connection.

- With connection **a**, you can listen to and record audio from a DVD and listen in Zone 2.
- To enjoy Dolby Digital and DTS, use connection **b** or **c**. (For recording, use **a** and **b**, or **a** and **c**.)
- If your DVD player has main left and right outputs and multichannel left and right outputs, be sure to use the main left and right outputs for connection **a**.

Connection	AV receiver	Signal flow	DVD player	Picture quality
A	COMPONENT VIDEO IN 1	←	Component video output	Best
B	DVD IN S	←	S-Video output	Better
C	DVD IN V	←	Composite video output	Standard
a	DVD IN FRONT	←	Analog audio L/R output	
b	DIGITAL COAXIAL IN 1	←	Digital coaxial output	
c	DIGITAL OPTICAL IN 3	←	Digital optical output	

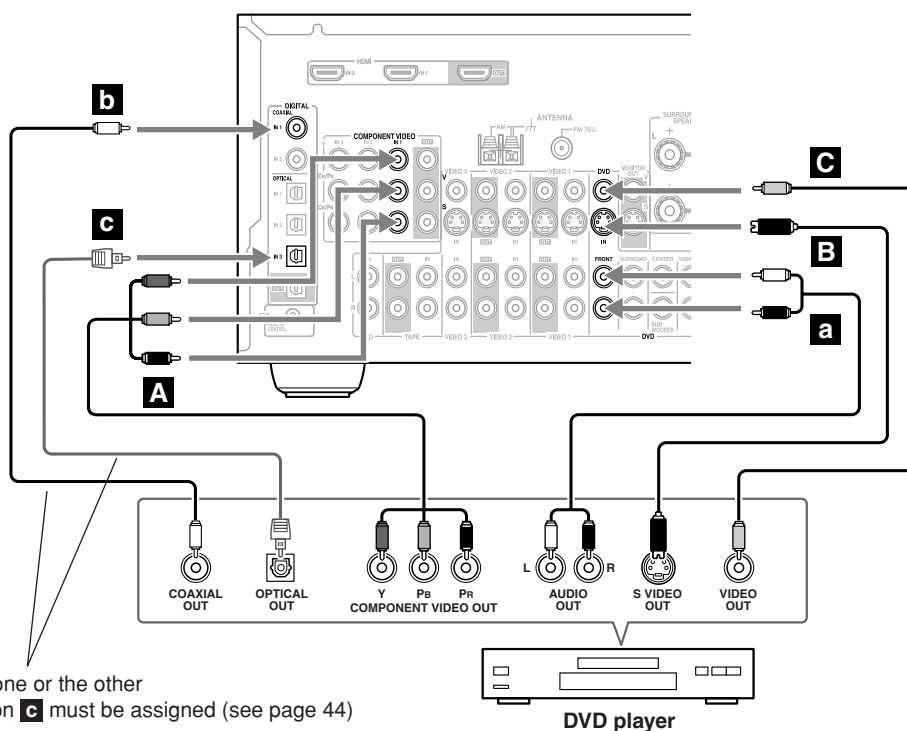

Connect one or the other
Connection **c** must be assigned (see page 44)

To connect a DVD player or DVD-Audio/SACD-capable player with a multichannel analog audio output, see page 26. ➔

Connecting the AV Receiver—Continued

Hooking Up the Multichannel DVD Input

If your DVD player supports multichannel audio formats such as DVD-Audio or SACD, and it has a multichannel analog audio output, you can connect it to the AV receiver's multichannel DVD input.

Use a multichannel analog audio cable, or several normal audio cables, to connect the AV receiver's DVD IN FRONT L/R, CENTER, SURROUND L/R, SURR BACK L/R, and SUBWOOFER jacks to the 7.1-channel analog audio output on your DVD player. If your DVD player has a 5.1-channel analog audio output, don't connect anything to the AV receiver's SURR BACK L/R jacks.

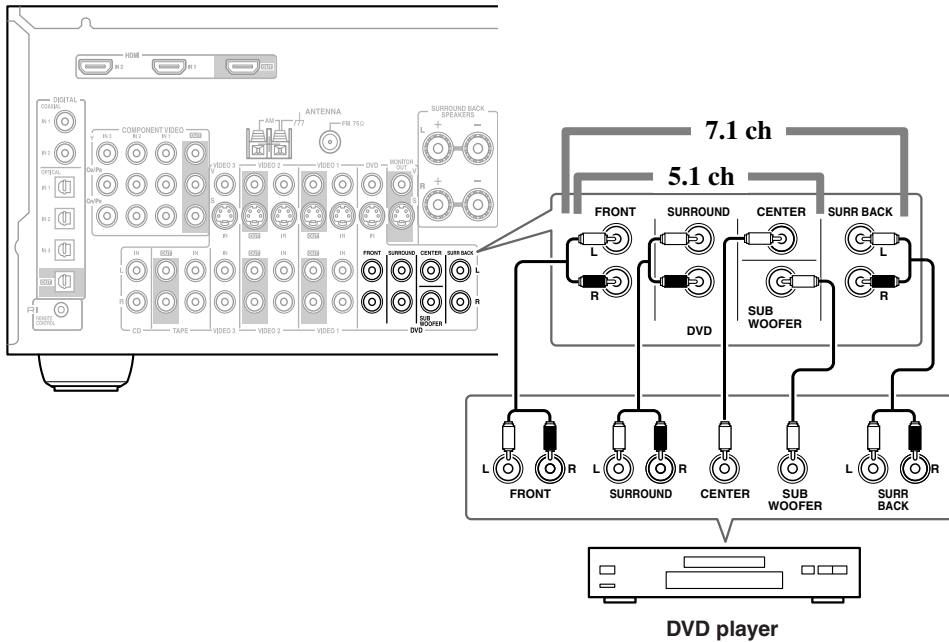

Connecting the AV Receiver—Continued

Connecting a VCR or DVD Recorder for Playback



With this hookup, you can use your VCR's tuner to listen to your favorite TV programs via the AV receiver, useful if your TV has no audio outputs.

Step 1: Video Connection

Choose a video connection that matches your VCR or DVD recorder (**A**, **B**, or **C**), and then make the connection. You must connect the AV receiver to your TV via the same type of connection.

Step 2: Audio Connection

Choose an audio connection that matches your VCR or DVD recorder (**a**, **b**, or **c**), and then make the connection.

- With connection **a**, you can listen to the VCR or DVD recorder even in Zone 2.
- To enjoy Dolby Digital and DTS, use connection **b** or **c**. (To listen in Zone 2 as well, use **a** and **b**, or **a** and **c**.)

Connection	AV receiver	Signal flow	VCR or DVD recorder	Picture quality
A	COMPONENT VIDEO IN 2	←	Component video output	Best
B	VIDEO 1 IN S	←	S-Video output	Better
C	VIDEO 1 IN V	←	Composite video output	Standard
a	VIDEO 1 IN L/R	←	Analog audio L/R output	
b	DIGITAL COAXIAL IN 2	←	Digital coaxial output	
c	DIGITAL OPTICAL IN 1	←	Digital optical output	

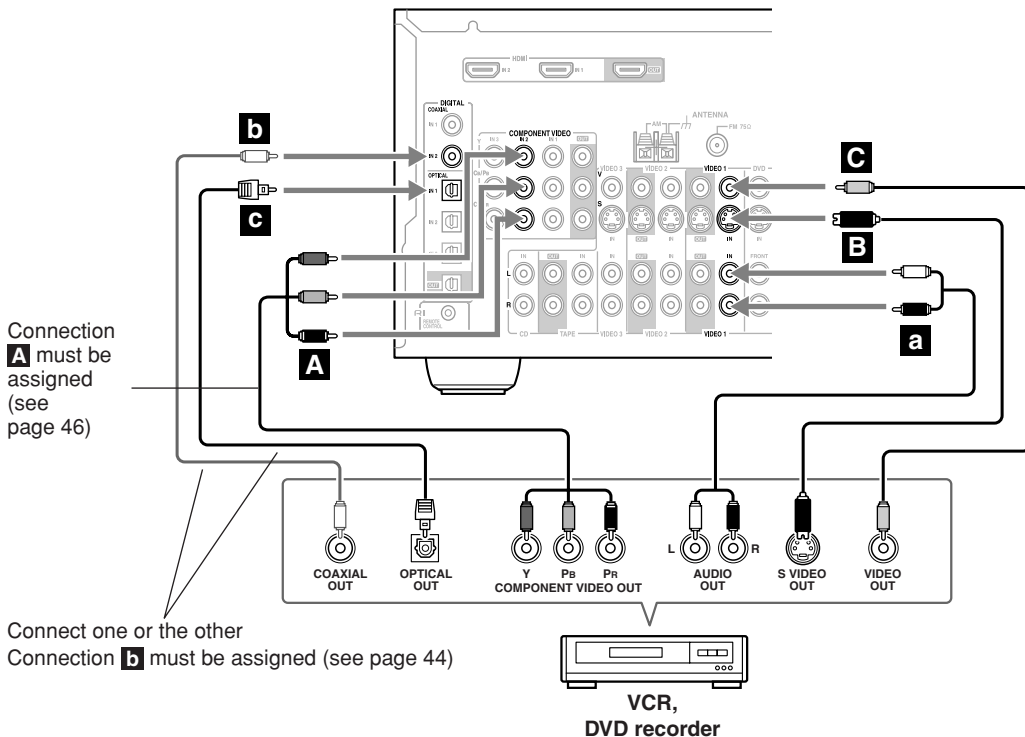

Connecting the AV Receiver—Continued

Connecting a VCR or DVD Recorder for Recording

If you have two video recorders (e.g., a VCR and a DVD recorder), connect one recorder to the VIDEO 1 OUT jacks, as shown here, and connect the other recorder to the VIDEO 2 OUT jacks in the same way.

Step 1: Video Connection

Choose a video connection that matches your VCR or DVD recorder (**A** or **B**), and then make the connection. The video source to be recorded must be connected to the AV receiver via the same type of connection.

Step 2: Audio Connection

Choose an audio connection that matches your VCR or DVD recorder (**a** or **b**), and then make the connection.

Connection	AV receiver	Signal flow	VCR or DVD recorder	Picture quality
A	VIDEO 1 OUT S	⇒	S-Video input	Better
B	VIDEO 1 OUT V	⇒	Composite video input	Standard
a	VIDEO 1 OUT L/R	⇒	Audio L/R input	
b	DIGITAL OPTICAL OUT	⇒	Digital optical input	

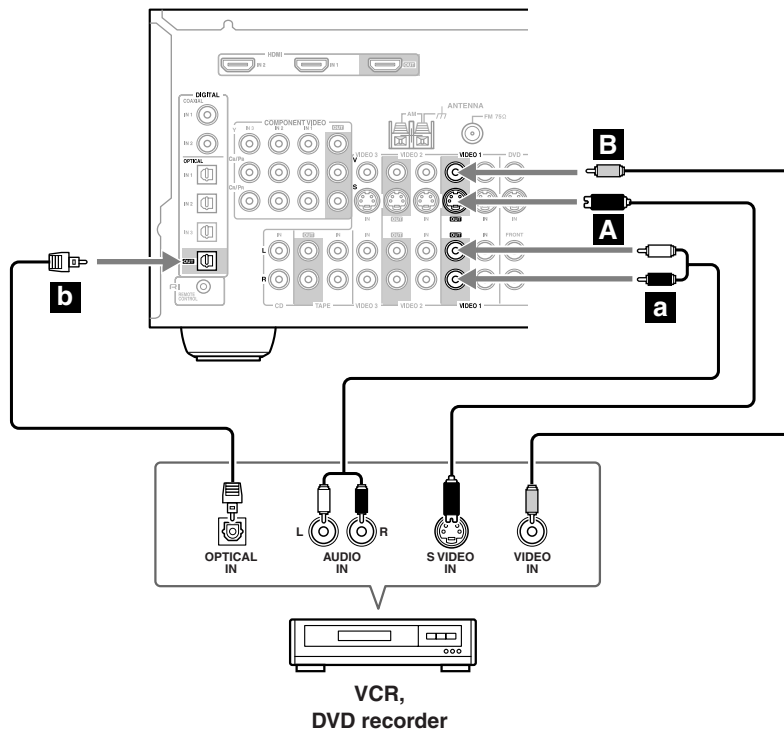

Notes:

- The AV receiver must be turned on for recording. Recording is not possible while it's in Standby mode.
- If you want to record directly from your TV or playback VCR to the recording VCR without going through the AV receiver, connect the TV/VCR's audio and video outputs directly to the recording VCR's audio and video inputs. See the manuals supplied with your TV and VCR for details.
- Video signals connected to composite video inputs can only be recorded via composite video outputs. If your TV/VCR is connected to a composite video input, the recording VCR must be connected to a composite video output. Similarly, video signals connected to S-Video inputs can only be recorded via S-Video outputs. If your TV/VCR is connected to an S-Video input, the recording VCR must be connected to an S-Video output.

Connecting the AV Receiver—Continued

Connecting a Satellite, Cable, Set-top box, or Other Video Source



With this hookup, you can use your satellite or cable receiver to listen to your favorite TV programs via the AV receiver, useful if your TV has no audio outputs.

Step 1: Video Connection

Choose a video connection that matches the video source (**A**, **B**, or **C**), and then make the connection. You must connect the AV receiver to your TV via the same type of connection.

Step 2: Audio Connection

Choose an audio connection that matches the video source (**a**, **b**, or **c**), and then make the connection.

- With connection **a**, you can listen to and record audio from the video source and listen in Zone 2.
- To enjoy Dolby Digital and DTS, use connection **b** or **c**. (For recording, use **a** and **b**, or **a** and **c**.)

Connection	AV receiver	Signal flow	Video source	Picture quality
A	COMPONENT VIDEO IN 3	←	Component video output	Best
B	VIDEO 3 IN S	←	S-Video output	Better
C	VIDEO 3 IN V	←	Composite video output	Standard
a	VIDEO 3 IN L/R	←	Analog audio L/R output	
b	DIGITAL COAXIAL IN 2	←	Digital coaxial output	
c	DIGITAL OPTICAL IN 2	←	Digital optical output	

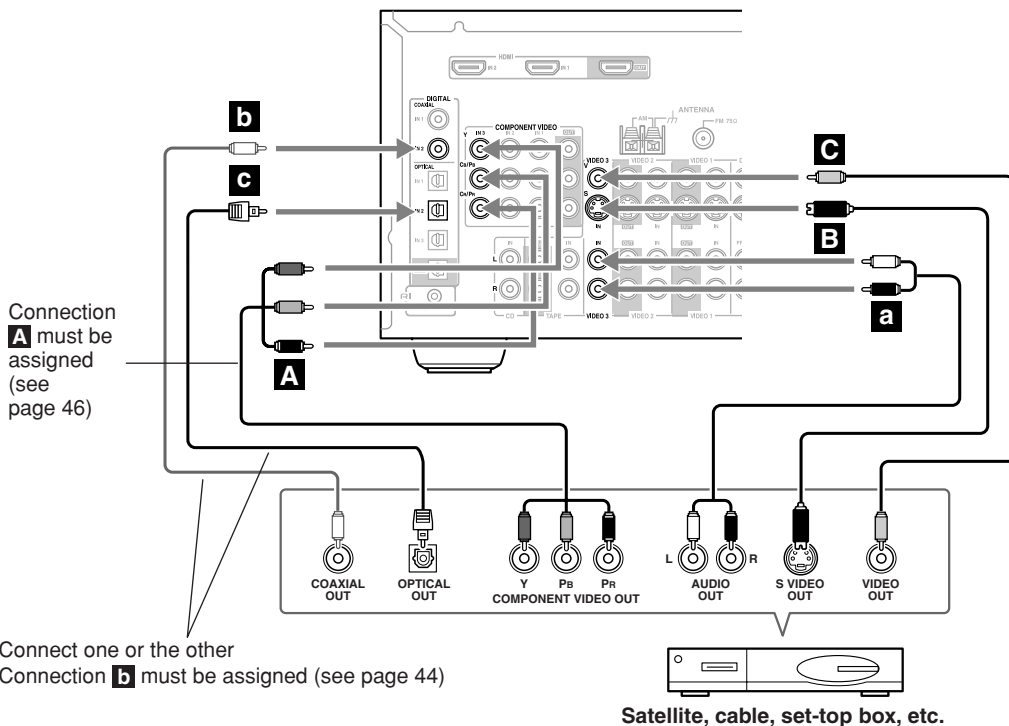

Connecting the AV Receiver—Continued

Connecting a Camcorder, Games Console, or Other Device

Step 1: Video Connection

Choose a video connection that matches the camcorder or console (**A** or **B**), and then make the connection.

Step 2: Audio Connection

Choose an audio connection that matches the camcorder or console (**a** or **b**), and then make the connection.

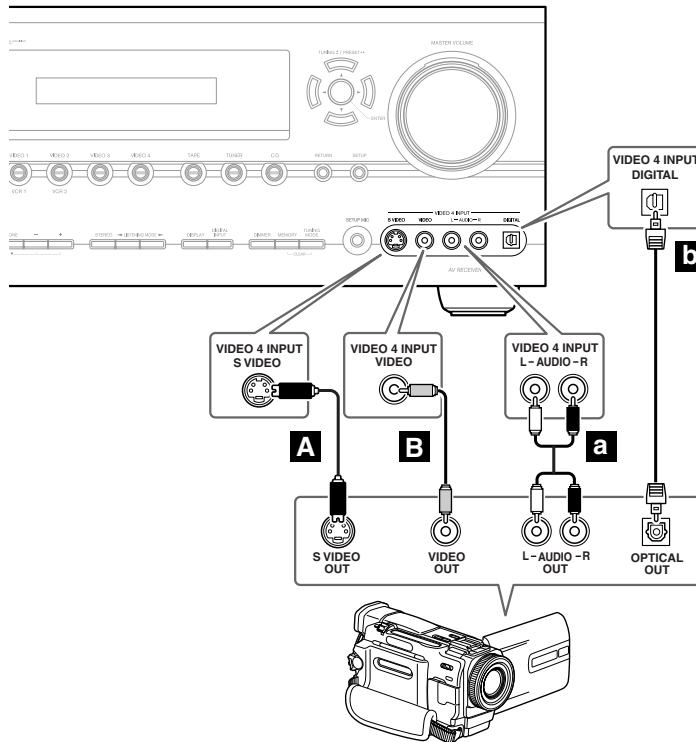

Camcorder, games console, etc.

Connection	AV receiver	Signal flow	Camcorder or console
A	VIDEO 4 INPUT S VIDEO	←	S-Video output
B	VIDEO 4 INPUT VIDEO	←	Composite video output
a	VIDEO 4 INPUT L/R	←	Analog audio L/R output
b	VIDEO 4 INPUT DIGITAL	←	Digital optical output

Connecting Components with HDMI

About HDMI

Designed to meet the demands of digital TV, HDMI (High Definition Multimedia Interface) is a new digital interface standard for connecting TVs, projectors, DVD players, set-top boxes, and other video components. Until now, several separate video and audio cables have been required to connect AV components. With HDMI, a single cable can carry control signals, digital video, and up to eight channels of digital audio (2-channel PCM, multichannel digital audio, and multichannel PCM).

The HDMI video stream (i.e., video signal) is compatible with DVI (Digital Visual Interface)^{*1}, so TVs and displays with a DVI input can be connected by using an HDMI-to-DVI adapter cable. (This may not work with some TVs and displays, resulting in no picture.)

The AV receiver uses HDCP (High-bandwidth Digital Content Protection), so only HDCP-compatible components can display the picture.

The AV receiver's HDMI interface is based on the following standard:
High-Definition Multimedia Interface Specification Informational Version 1.1

Supported Audio Formats

- 2-channel linear PCM (32–192 kHz, 16/20/24 bit)
- Multichannel linear PCM (5.1 ch, 32–96 kHz, 16/20/24 bit)
- Bitstream (Dolby Digital, DTS)

Your DVD player must also support HDMI output of the above audio formats.

About Copyright Protection

The AV receiver supports HDCP (High-bandwidth Digital Content Protection)^{*2}, a copy-protection system for digital video signals. Other devices connected to the AV receiver via HDMI must also support HDCP.

Commercially available HDMI cables (supplied with some components) should be used to connect the AV receiver's HDMI OUT to the HDMI input on your TV or projector.

*1 DVI (Digital Visual Interface): The digital display interface standard set by the DDWG^{*3} in 1999.

*2 HDCP (High-bandwidth Digital Content Protection): The video encryption technology developed by Intel for HDMI/DVI. It's designed to protect video content and requires a HDCP-compatible device to display the encrypted video.

*3 DDWG (Digital Display Working Group): Lead by Intel, Compaq, Fujitsu, Hewlett Packard, IBM, NEC, and Silicon Image, this open industry group's objective is to address the industry's requirements for a digital connectivity specification for high-performance PCs and digital displays.

Connecting the AV Receiver—Continued

Making HDMI Connections

Step 1: Use HDMI cables to connect the AV receiver's HDMI jacks to your HDMI-compatible DVD player, TV, projector, and so on.

Step 2: Assign each HDMI IN to an input selector in the HDMI Video setup (see page 45).

Video Signal Flow Chart

(TX-SR604/604E, TX-SR8460)

Digital video signals received at HDMI IN 1 and 2 are only output by the HDMI OUT and sent to your TV. Composite video, S-Video, and component video input signals are not output by the HDMI OUT.

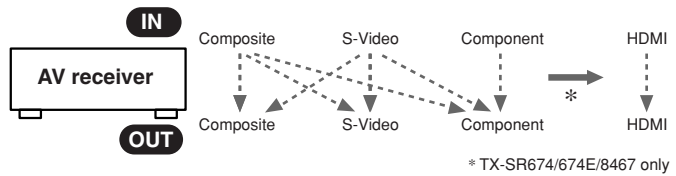

Note:

The onscreen setup menus are not output by the HDMI OUT, so you'll also need to make a composite video, S-Video, or component video connection to your TV (see page 24).

(TX-SR674/674E, TX-SR8467)

Digital video signals received at HDMI IN 1 and 2 are only output by the HDMI OUT.

By configuring the AV receiver, input signals from the composite video, S-Video, and component video jacks can be output through the HDMI OUT (see page 45).

Audio Signal Flow Chart

Digital audio signals received at HDMI IN 1 or 2 are output by the speakers and headphones connected to the AV receiver. They're also output by the OPTICAL OUT and can be output by the HDMI OUT by setting the HDMI Audio Out setting to On (see page 76).

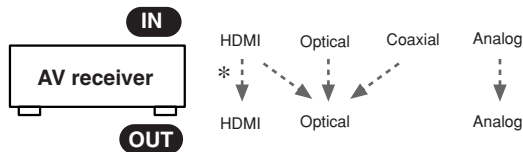

* To listen to audio received at HDMI IN 1 and 2 through your TV speakers, set the HDMI Audio Out setting to On (see page 76) and your DVD player's output setting to PCM.

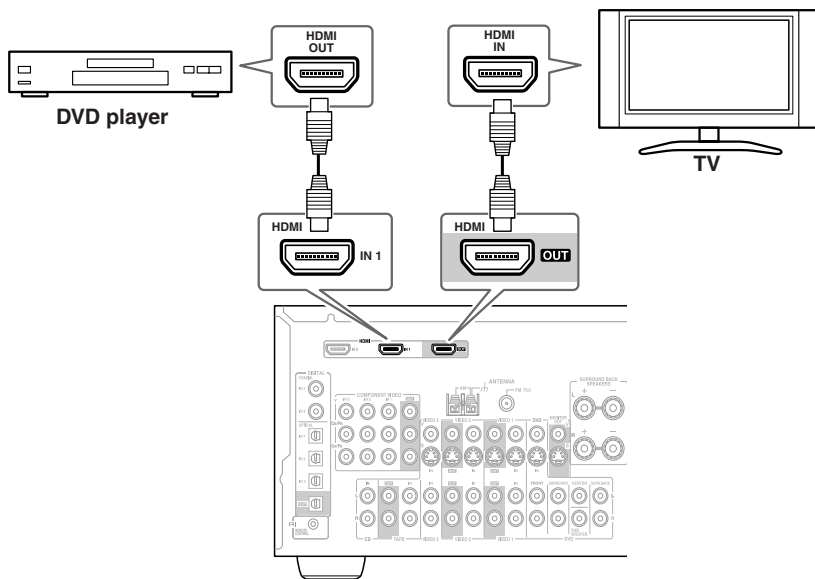

Connecting a CD Player or Turntable

■ CD Player or Turntable (MM) with Built-in Phono Preamp

Step 1:

Choose a connection that matches your CD player (**a**, **b**, or **c**). Use connection **a** for a turntable with a built-in phono preamp.

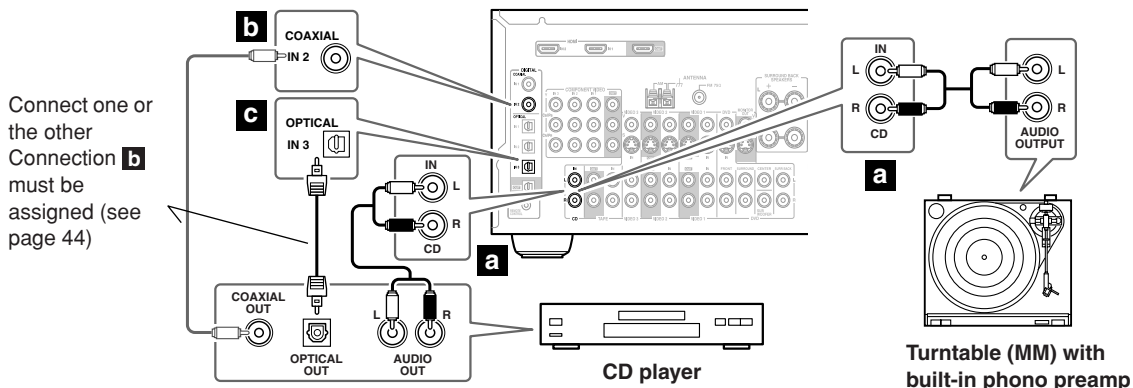

- With connection **a**, you can listen to and record audio from the CD player and listen in Zone 2.
- To connect the CD player digitally, use connection **b** or **c**. (For recording, use **a** and **b**, or **a** and **c**.)

Connection	AV receiver	Signal flow	CD or turntable
a	CD IN L/R	←	Analog audio L/R output
b	DIGITAL COAXIAL IN 2	←	Digital coaxial output
c	DIGITAL OPTICAL IN 3	←	Digital optical output

■ Turntable (MM) with no Phono Preamp Built-in

A phono preamp is necessary to connect a turntable that doesn't have a phono preamp built-in.

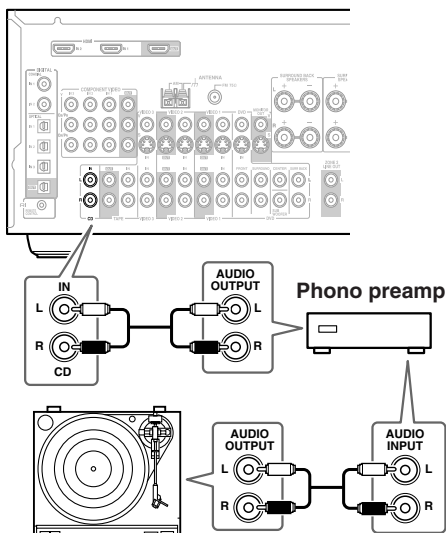

■ Turntable with an MC (Moving Coil) Cartridge

An MC head amp and phono preamp are necessary to connect a turntable with an MC (Moving Coil) cartridge.

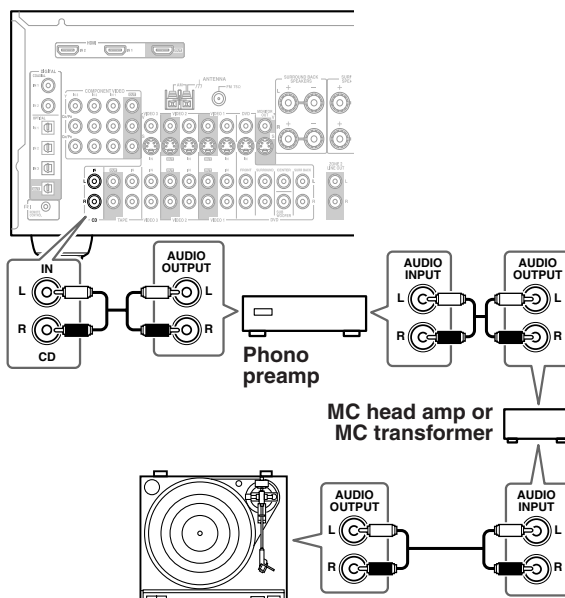

Connecting a HDD-compatible Component

As of this printing, the Onkyo Remote Interactive Dock is the only HDD-compatible component available.

■ For HDD-compatible components that support video

Connect your HDD-compatible component's analog audio output jacks and video output jack to the AV receiver's VIDEO 3 IN L/R jacks and VIDEO 3 IN (V or S) jack. (The example shown below is for connection with the DS-A1.)

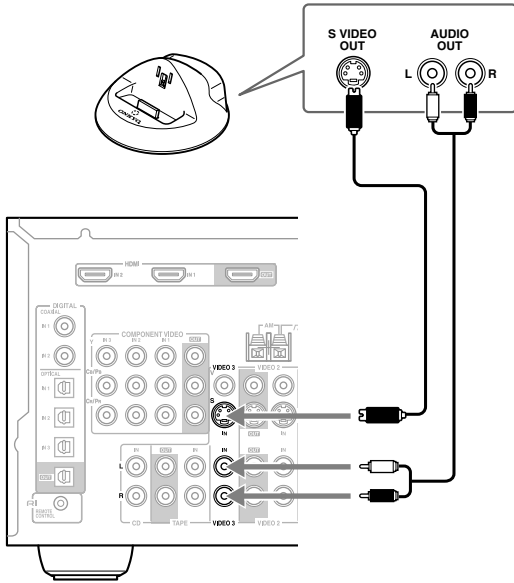

■ For HDD-compatible components that don't support video

Connect your HDD-compatible component's analog audio output jacks to the AV receiver's TAPE IN L/R jacks.

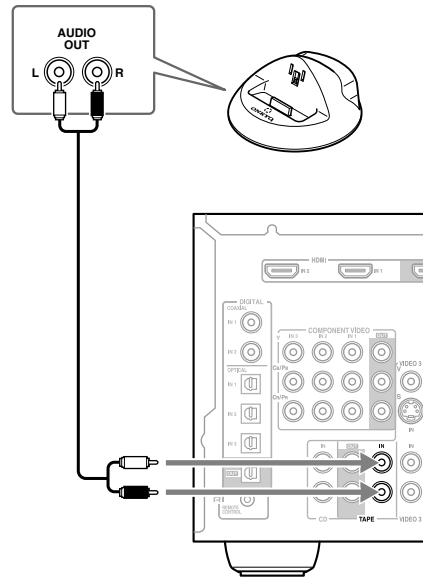

Notes:

- Connect the Remote Interactive Dock with an **RI** cable (see page 36).
- Set the Remote Interactive Dock's RI MODE switch to HDD.
- Set the AV receiver's input display to HDD (see page 47).
- Refer to the Remote Interactive Dock's instruction manual.

Connecting the AV Receiver—Continued

Connecting a Cassette, CDR, MiniDisc, or DAT Recorder

Step 1:

Choose a connection that matches the recorder (**a**, **b**, **c**, or **d**), and then make the connection.

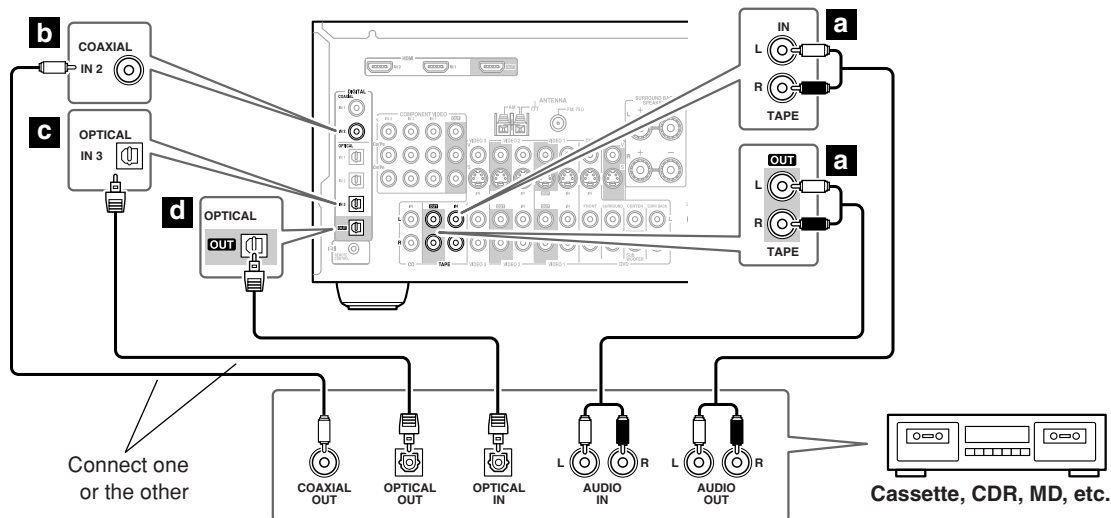

- With connection **a**, you can play and record and listen in Zone 2.
- To connect the recorder digitally for playback, use connections **a** and **b**, or **a** and **c**.
- To connect the recorder digitally for recording, use connection **d**.

Connection	AV receiver	Signal flow	Cassette, CDR, MD, or DAT recorder
a	TAPE IN L/R TAPE OUT L/R	← ⇒	Analog audio L/R output Analog audio L/R input
b	DIGITAL COAXIAL IN 2	←	Digital coaxial output
c	DIGITAL OPTICAL IN 3	←	Digital optical output
d	DIGITAL OPTICAL OUT	⇒	Digital optical input

Connecting Onkyo RI Components

Step 1: Make sure that each Onkyo component is connected to the AV receiver with an analog audio cable (connection **a** in the hookup examples) (see pages 24 to 35).

Step 2: Make the **RI** connection.

Step 3: If you're using an MD, CDR, or HDD component, change the input display (see page 47).

With **RI** (Remote Interactive), you can use the following special functions:

■ Auto Power On/Standby

When you start playback on a component connected via **RI**, if the AV receiver is on Standby, it will automatically turn on and select that component as the input source. Similarly, when the AV receiver is set to Standby, all components connected via **RI** will also go on Standby. This function will not work on components connected to an AC OUTLET on the AV receiver.

■ Direct Change

When playback is started on a component connected via **RI**, the AV receiver automatically selects that component as the input source. If your DVD player is connected to the AV receiver's multichannel DVD input, you'll need to press the [MULTI CH] button to hear all channels (see page 50), as the Direct Change **RI** function only selects the FRONT DVD IN jacks.

■ Remote Control

You can use the AV receiver's remote controller to control your other **RI**-capable Onkyo components, pointing the remote controller at the AV receiver's remote control sensor instead of the component. You must enter the appropriate remote control code first (see page 84).

Notes:

- Use only **RI** cables for **RI** connections. **RI** cables are supplied with Onkyo players (DVD, CD, etc.).
- Some components have two **RI** jacks. You can connect either one to the AV receiver. The other jack is for connecting additional **RI**-capable components.
- Connect only Onkyo components to **RI** jacks. Connecting other manufacturer's components may cause a malfunction.
- Some components may not support all **RI** functions. Refer to the manuals supplied with your other Onkyo components.

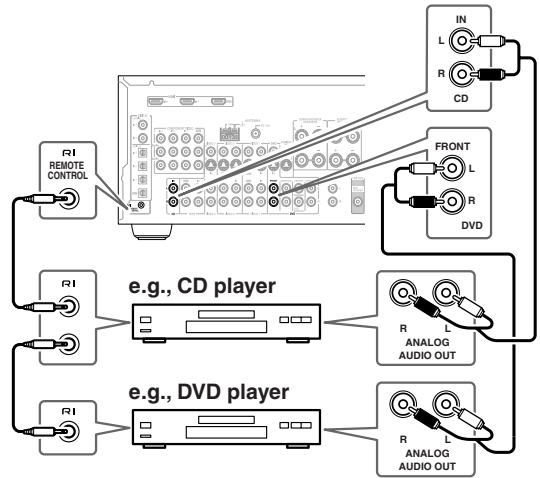

Connecting the Power Cord of Another Component

The AV receiver has an AC outlet on its rear panel for connecting the power cord of another AV component. The other component's power switch can then be left in the ON position so that it turns on or off when the AV receiver is set to On or Standby.

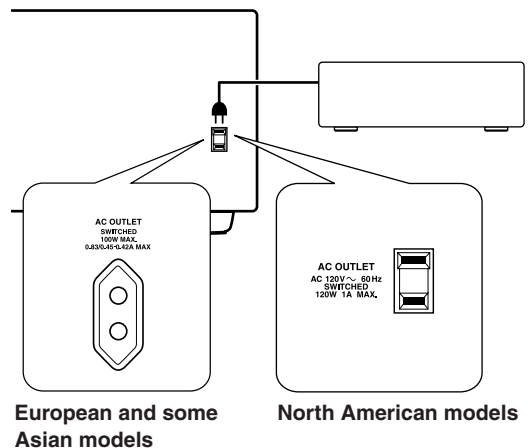

Caution:

Make sure that the capacity of the component that you connect to the AC OUTLET does not exceed the stated capacity (e.g., 100W).

Notes:

- Onkyo components with **RI** jacks should be connected directly to wall outlets, not the AV receiver's AC OUTLET.
- The socket type and capacity will depend on the country in which you purchased the AV receiver.

Turning On the AV Receiver

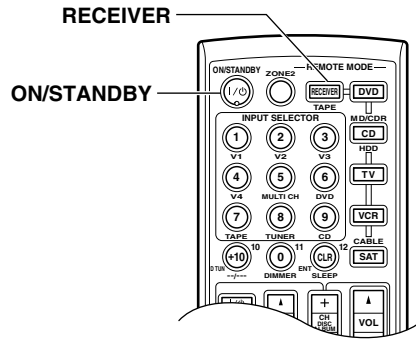
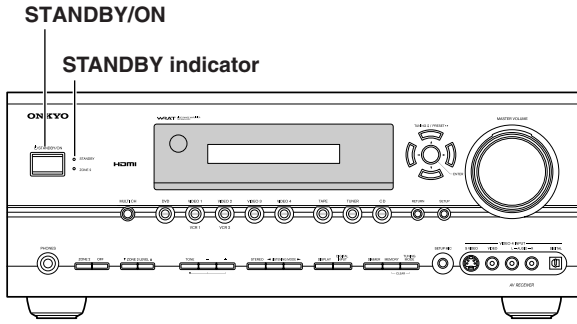

Connecting the Power Cord

- Connect the AV receiver's power cord to a suitable wall outlet.

Notes:

- Before connecting the power cord, connect all of your speakers and AV components.
- Turning on the AV receiver may cause a momentary power surge that might interfere with other electrical equipment on the same circuit. If this is a problem, plug the AV receiver into a different branch circuit.

Turning On and Standby

1

AV receiver



or

Remote controller



↓

ON/STANDBY



Press the [STANDBY/ON] button.

Alternatively, press the remote controller's [RECEIVER] button, followed by the [ON/STANDBY] button.

The AV receiver comes on, the display lights up, and the STANDBY indicator goes off.

To turn the AV receiver off, press the [STANDBY/ON] button, or press the remote controller's [ON/STANDBY] button. The AV receiver will enter Standby mode. To prevent any loud surprises when you turn on the AV receiver, always turn down the volume before you turn it off.

Smooth Operation in a Few Easy Steps

To ensure smooth operation, here's a few easy steps to help you configure the AV receiver before you use it for the very first time. These settings only need to be made once.

■ Do the automatic speaker setup—this is essential!

See "Automatic Speaker Setup (Audyssey2EQ)" on page 38.



■ Have you connected a component to an HDMI input, component video input, or digital audio input?

If you have, see "HDMI Video Setup" on page 45, "Component Video Setup" on page 46, or "Digital Input" on page 44 respectively.

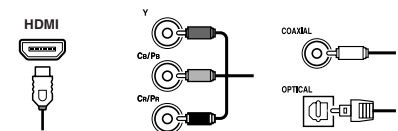

■ Have you connected an Onkyo MD recorder, CD recorder, or next generation HDD-compatible component?

If you have, see "Changing the Input Display" on page 47.

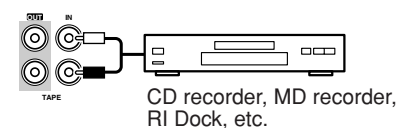

First Time Setup

This section explains the settings that you need to make before using the AV receiver for the very first time.

Automatic Speaker Setup (Audyssey2EQ)

With the supplied speaker setup microphone, the Audyssey2EQ function can measure the number of speakers connected, their sizes, crossover frequencies, and the distance from each speaker to the listening position and calculate the optimal speaker settings for your listening environment automatically.

Before using this function, connect and position all of your speakers.

Measurement Points

To create a listening area in which several people can enjoy home theater simultaneously, the Audyssey2EQ function takes measurements at three points within the listening area:

- ① **First measurement point**
This is the center point of the listening area, or the listening position if it's just one person.
- ② **Second measurement point**
The right side of the listening area.
- ③ **Third measurement point**
The left side of the listening area.

The distances between points ① and ② and points ① and ③ must be at least 1 meter.

From the examples below, choose the listening area that best matches yours and place the microphone accordingly when prompted.

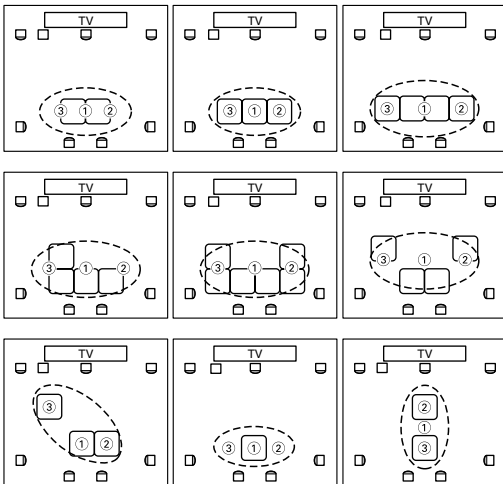

- : listening area
- : listening position

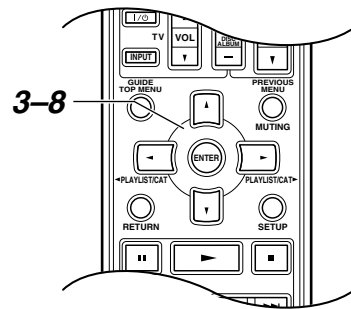
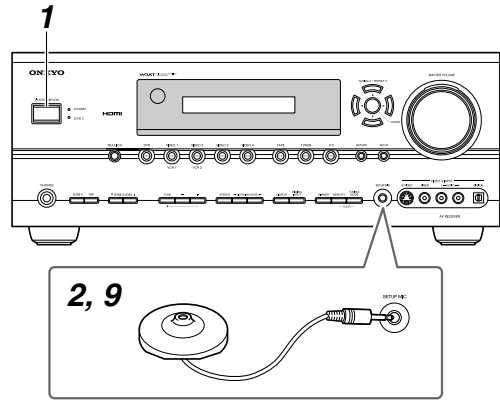

Note: If any of your speakers is 4 ohms, change the minimum speaker impedance setting before running the automatic speaker setup (see page 47).

- 1 Turn on the AV receiver and the connected TV.**
On the TV, select the input to which the AV receiver is connected.

2

Put the speaker setup microphone at measurement point ①.

```

Auto Speaker Setup
=====
Please place microphone
at center of listening
area at ear height.

Push Enter:Next
    
```

Notes:

- Make sure the microphone is horizontal.
- If there's an obstacle between the microphone and any speaker, the automatic setup will not work correctly. Set up the room as you would when enjoying a DVD.
- Positioning the microphone close to where your ears would normally be will provide better results. You can adjust the height of the microphone by using a tripod or level table.
- It takes about 10 minutes to complete the automatic speaker setup.

Connect the setup microphone to the SETUP MIC jack.



Notes:

- If the AV receiver was previously muted, it will be unmuted.
- Automatic speaker setup cannot be performed while a pair of headphones is connected.

3

Press [ENTER].

The automatic speaker setup starts.



```

Auto Speaker Setup
=====
Do not unplug Setup Mic.

Please, keep quiet.

Now measuring...
    
```

A test tone is output by each speaker in turn, as the Audyssey2EQ function determines which speakers are connected. This takes a few minutes.

Note:

If any extraneous noise is picked up by the microphone, the automatic setup may not work correctly, so don't make any noise.

4

The speaker detect results appear.

```

Auto Speaker Setup
-----SP Detect Result-----
FL:Yes  FR:Yes
SL:Yes  SR:Yes
SBL:Yes SBR:Yes
C:No    SW:Yes
-----
Next
Retry
Cancel
    
```

“Yes” means that the speaker was detected. “No” means that no speaker was detected.

If you agree with the results, use the Up and Down [▲]/[▼] buttons to select Next, and then press [ENTER].

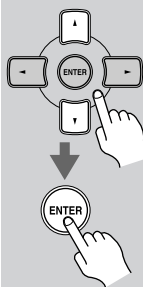

The options are:

Next:

Proceed to the next step.

Retry:

Return to step 2 and try again.

Cancel:

Cancel the automatic speaker setup.

5

The following screen appears.

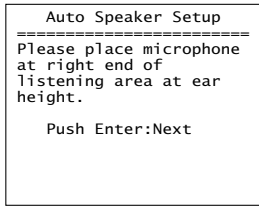

Move the speaker setup microphone to measurement point ② (page 38), then press [ENTER].

Audyssey2EQ performs more measurements. This takes a few minutes.

6

The following screen appears.

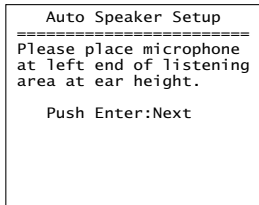

Move the speaker setup microphone to measurement point ③ (page 38), then press [ENTER].

Audyssey2EQ performs more measurements. This takes a few minutes.

7

When the measurements are complete, the following screen appears.

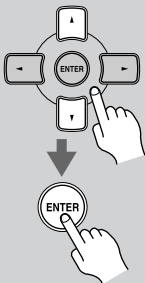
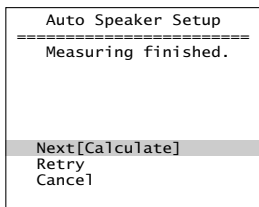

Use the Up and Down [▲]/[▼] buttons to select an option, and then press [ENTER].

The options are:

Next (Calculate):

Calculate the results, which takes a few minutes, and then proceed to the next step.

Retry:

Return to step 2 and try again.

Cancel:

Cancel the automatic speaker setup.

8

When the calculations are complete, the following screen appears.

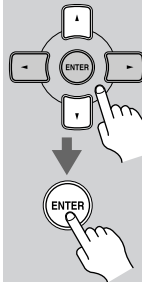
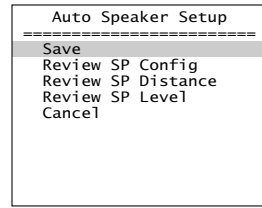

Use the Up and Down [▲]/[▼] buttons to select an option, and then press [ENTER].

The options are:

Save:

Save the calculated settings and exit the automatic speaker setup.

Review SP Config:

Review the speaker configuration settings (see “Reviewing the Results” on page 41).

Review SP Distance:

Review the speaker distance settings (see “Reviewing the Results” on page 41).

Review SP Level:

Review the speaker level settings (see “Reviewing the Results” on page 41).

Cancel:

Cancel the automatic speaker setup.

9

Disconnect the speaker setup microphone.

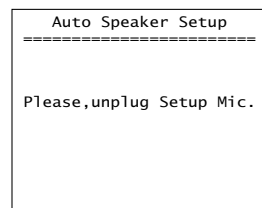

Notes:

- When the automatic speaker setup is complete, the Equalizer Settings (page 71) will be set to “Audyssey.”
- You can cancel the automatic speaker setup at any point in this procedure simply by disconnecting the setup microphone.

Error Messages

While the automatic speaker setup is in progress, one of the following error messages may appear:

❑ Ambient noise is too high

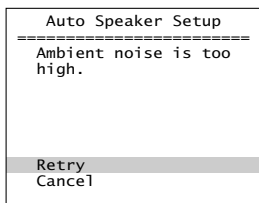

This message appears if the background noise is too loud and the measurements cannot be performed properly. Remove the source of the noise and try again.

Retry:

Return to step 2 and try again.

Cancel:

Cancel the automatic speaker setup.

❑ Speaker Detect Errors

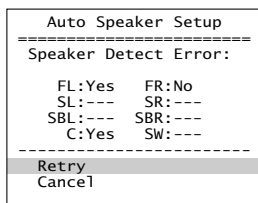

One of the front speakers has not been detected.

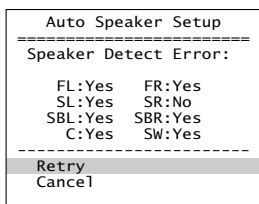

One of the surround speakers has not been detected.

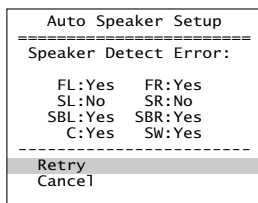

The surround back speakers have been detected but the surround speakers haven't.

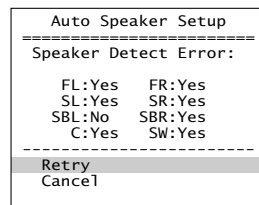

The right surround back speaker has been detected but the left surround back speaker hasn't. Make sure speakers that cannot be detected are connected properly.

Retry:

Return to step 2 and try again.

Cancel:

Cancel the automatic speaker setup.

Reviewing the Results

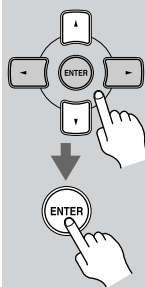

Use the Up and Down [**▲**]/[**▼**] buttons to select the settings that you want to review, and then press [ENTER].

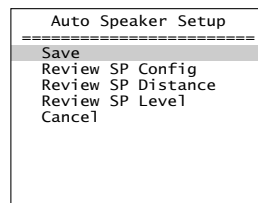

The options are:

Review SP Config:

Review the speaker configuration settings.

Review SP Distance:

Review the speaker distance settings.

Review SP Level:

Review the speaker level settings.

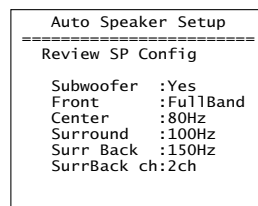

```
Auto Speaker Setup
=====
Review SP Distance

Front      :15ft
Center     :15ft
SurrRight  : 7ft
SurrBack R : 7ft
SurrBack L : 7ft
SurrLeft   : 7ft
Subwoofer  :15ft
```

```
Auto Speaker Setup
=====
Review SP Level

Left       : +12dB
Center     :  0dB
Right      : -12dB
SurrRight  : +3dB
SurrBack R : +4dB
SurrBack L : -6dB
SurrLeft   : -3dB
Subwoofer  :  0dB
```

Press the [RETURN] button to return to the previous menu.

Changing the Speaker Settings Manually

In some situations, the measurements taken by the automatic speaker setup may not provide usable results. If running the speaker setup a second time still doesn't provide usable results, you'll have to set the speaker settings manually (see pages 67–71).

Using a Powered Subwoofer

If you're using a powered subwoofer, because it outputs very low-frequency sound and its position is usually low, it may not be detected by the automatic speaker setup. If the subwoofer (SW) appears on the SP Detect Result screen as "No," increase the subwoofer's volume, set it to its highest crossover frequency, and then try running the automatic speaker setup again. Note that if the volume is set too high and the sound distorts, it may not be detected, so use an appropriate volume level. If the subwoofer has a low-pass filter switch, set it to Off or Direct. Refer to your subwoofer's instruction manual for details.

About the Onscreen Setup Menus

The onscreen setup menus are displayed on the connected TV and provide a convenient way to change the AV receiver's settings. (The onscreen menus do not appear on a TV that's connected to the HDMI OUT (TX-SR604/604E/8460 only).)

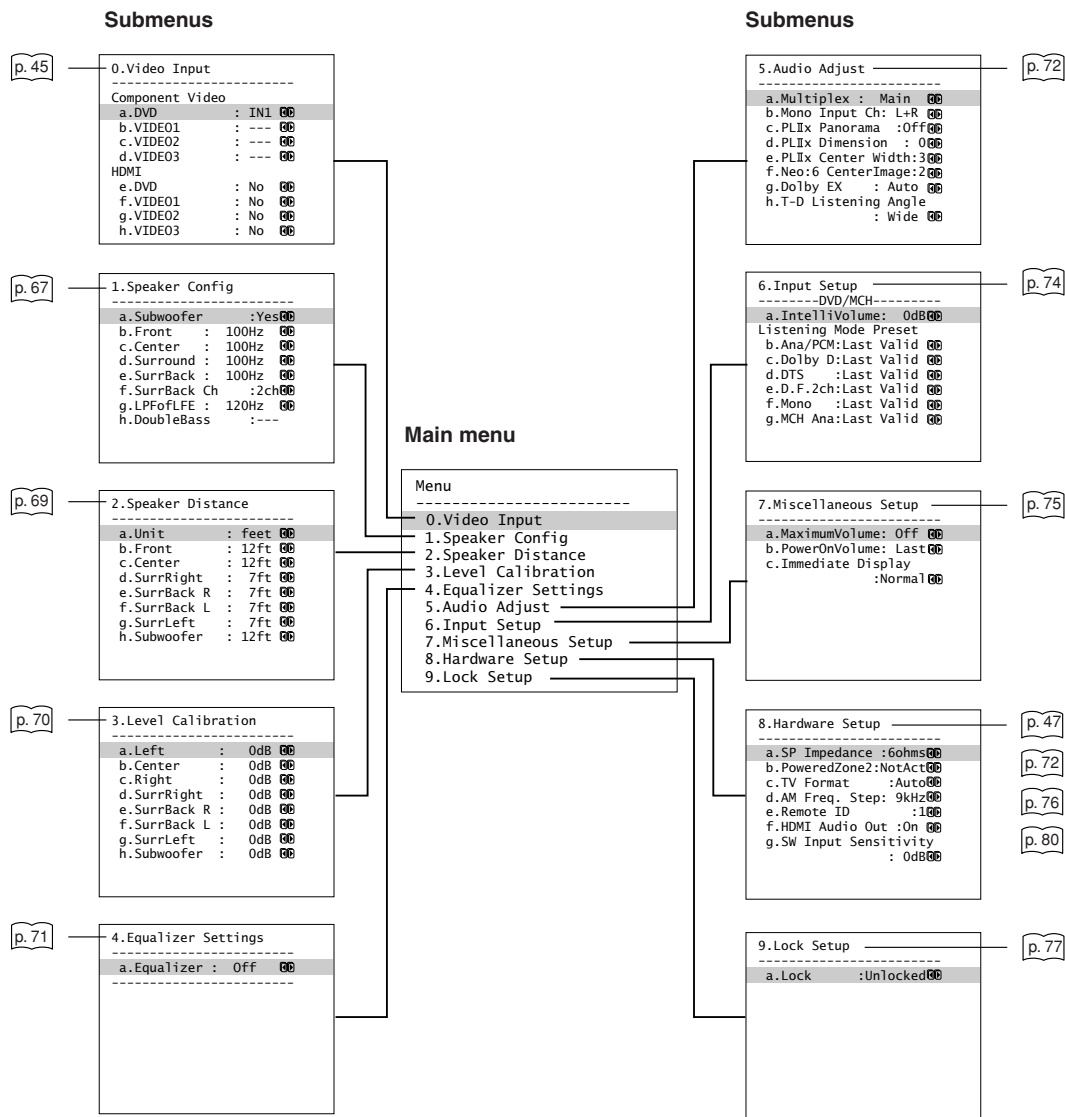

Digital Input

If you connect a component to a digital input jack, you must assign that jack to an input selector. For example, if you connect your CD player to the OPTICAL IN2 jack, you should assign that jack to the CD input selector. By default, the COAXIAL IN1 jack is assigned to the DVD input selector, although this can be changed.

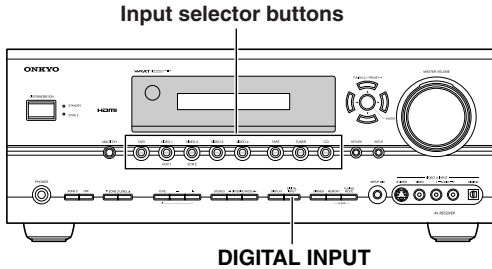

Here are the default assignments.

Input selector	Default assignment
DVD	COAX1
VIDEO 1	OPT1
VIDEO 2	----
VIDEO 3	OPT2
TAPE	----
CD	OPT3

When HDMI IN 1 or 2 is assigned to an input selector in the “HDMI Video Setup” on page 45, the input selector assignment on this page is automatically set to HDMI 1 or HDMI 2.

1

Press the input selector button for the source that you want to assign.
(Digital inputs cannot be assigned to the TUNER input source)

2

Press the [DIGITAL INPUT] button.
The current assignment appears.

DVD #COAX1

3

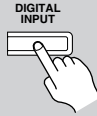

Press the [DIGITAL INPUT] button repeatedly to select COAX1, COAX2, OPT1, OPT2, OPT3, or ---- (analog).

- An input selector that has been assigned to IN1 or IN2 in the “HDMI Video Setup” (page 45) can be set to HDMI here.
- There are no assignments for TUNER.
- VIDEO 4 is used only for digital input from the front panel terminals.

Examples:

If you connect your DVD player to the OPTICAL IN 2 jack, set “DVD” to “OPT2.”

If you want to listen to audio from the component connected to the OPTICAL IN 3 jack when the VIDEO 1 input selector is selected, set “VIDEO1” to “OPT3.”

If you want to listen to audio from the component connected to the COAXIAL IN 1 jack when the VIDEO 2 input selector is selected, set “VIDEO2” to “COAX1.”

For input selectors that you don’t want to assign a digital input jack, set to “---- (analog).”

Video Input

HDMI Video Setup

If you connect a video component to HDMI IN 1 or 2, you must assign that input to an input selector. For example, if you connect your DVD player to HDMI IN 1, you must assign HDMI IN 1 to the DVD input selector.

Note:

When HDMI IN 1 or 2 is assigned to an input selector here, the digital audio input for that selector is automatically set to HDMI IN 1 or 2. See “Digital Input” on page 44.

1

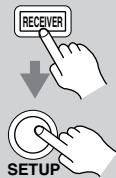

Press the [RECEIVER] button followed by the [SETUP] button.

The main menu appears onscreen.

2

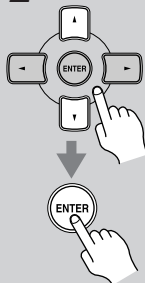

Use the Up and Down [▲]/[▼] buttons to select “0. Video Input,” and then press [ENTER].

The Video Input menu appears.

0.Video Input		

Component Video		
a.DVD	: IN1	<input checked="" type="checkbox"/>
b.VIDEO1	: ---	<input type="checkbox"/>
c.VIDEO2	: ---	<input type="checkbox"/>
d.VIDEO3	: ---	<input type="checkbox"/>
HDMI		
e.DVD	: No	<input type="checkbox"/>
f.VIDEO1	: No	<input type="checkbox"/>
g.VIDEO2	: No	<input type="checkbox"/>
h.VIDEO3	: No	<input type="checkbox"/>

3

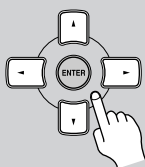

Use the Up and Down [▲]/[▼] buttons to select an input selector, and use the Left and Right [◀]/[▶] buttons to select:

(TX-SR604/604E/8460 only)

0.Video Input		

Component Video		
a.DVD	: IN1	<input checked="" type="checkbox"/>
b.VIDEO1	: ---	<input type="checkbox"/>
c.VIDEO2	: ---	<input type="checkbox"/>
d.VIDEO3	: ---	<input type="checkbox"/>
HDMI		
e.DVD	: No	<input type="checkbox"/>
f.VIDEO1	: No	<input type="checkbox"/>
g.VIDEO2	: No	<input type="checkbox"/>
h.VIDEO3	: No	<input type="checkbox"/>

IN1: Select if the video component is connected to HDMI IN 1.

IN2: Select if the video component is connected to HDMI IN 2.

No: Select when not using the HDMI output.

(TX-SR674/674E/8467 only)

0.Video Input		

Component Video		
a.DVD	: IN1	<input checked="" type="checkbox"/>
b.VIDEO1	: ---	<input type="checkbox"/>
c.VIDEO2	: ---	<input type="checkbox"/>
d.VIDEO3	: ---	<input type="checkbox"/>
HDMI		
e.DVD	: ---	<input checked="" type="checkbox"/>
f.VIDEO1	: ---	<input type="checkbox"/>
g.VIDEO2	: ---	<input type="checkbox"/>
h.VIDEO3	: ---	<input type="checkbox"/>

IN1: Select if the video component is connected to HDMI IN 1.

IN2: Select if the video component is connected to HDMI IN 2.

---: Output composite video, S-Video, and component video sources from the HDMI OUT. The video output signal from the HDMI OUT is the one configured in “Component Video Setup” (page 46).

4



Press the [SETUP] button.

Setup closes.

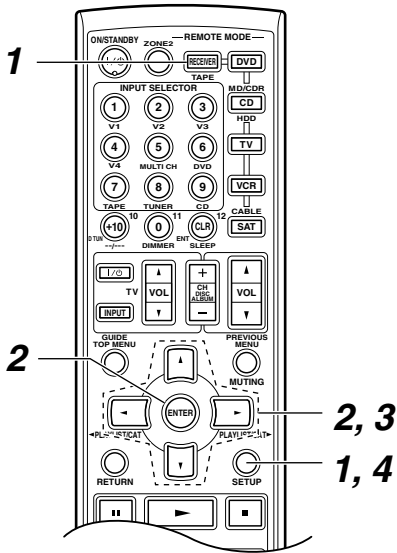

Component Video Setup

If you connect to a COMPONENT VIDEO IN, you must assign it to an input selector. For example, if you connect your DVD player to COMPONENT IN 3, you should assign it to the DVD input selector.

If you want to output composite and S-Video sources from the COMPONENT VIDEO OUT, select “---,” as explained below.

Input selector	VIDEO IN jack
DVD	IN 1
VIDEO 1	---
VIDEO 2	---
VIDEO 3	---

VIDEO 4 is fixed to “---.”

1 Press the [RECEIVER] button followed by the [SETUP] button. The main menu appears onscreen.

2 Use the Up and Down [▲]/[▼] buttons to select “0. Video Input,” and then press [ENTER]. The Video Input menu appears.

0.Video Input	

Component Video	
a. DVD	: IN1
b. VIDEO1	: ---
c. VIDEO2	: ---
d. VIDEO3	: ---
HDMI	
e. DVD	: No
f. VIDEO1	: No
g. VIDEO2	: No
h. VIDEO3	: No

3 Use the Up and Down [▲]/[▼] buttons to select an input selector, and then use the Left and Right [◀]/[▶] buttons to select:

- IN1:** Use the video component connected to COMPONENT VIDEO IN 1.
- IN2:** Use the video component connected to COMPONENT VIDEO IN 2.
- IN3:** Use the video component connected to COMPONENT VIDEO IN 3.
- : Output composite video and S-Video sources from the COMPONENT VIDEO OUT.

4 Press the [SETUP] button. The setup menu closes.

- Notes:**
- (TX-SR674/674E/8467 only) When the input selector assignment for the COMPONENT VIDEO IN jacks is set to IN1, IN2 or IN3, the “composite video to S-Video” and “S-Video to composite video” conversions will not work.
 - This procedure can also be performed on the AV receiver by using its [SETUP] button, arrow buttons, and [ENTER] button.

Changing the Input Display

If you connect an **RI**-capable Onkyo MiniDisc recorder, CD recorder, or next generation HDD-compatible component to the TAPE IN/OUT or VIDEO 3 IN jacks, for **RI** to work properly, you must change this setting.

This setting can only be changed on the AV receiver.

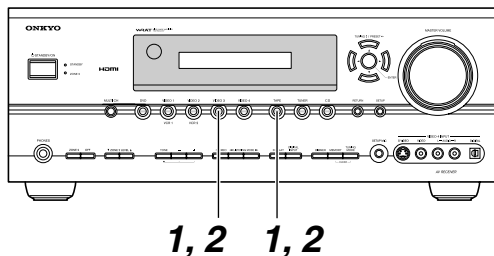

iPod photo: If you're using an iPod photo with the DS-A1 Remote Interactive Dock, connect the DS-A1 to the VIDEO 3 IN jacks.

1 **TAPE**



Press the [TAPE] or [VIDEO 3] input selector button so that "TAPE" or "VIDEO 3" appears on the display.

TAPE

VIDEO3

VIDEO 3



2 **TAPE**



Press and hold down the [TAPE] or [VIDEO 3] input selector button (about 3 seconds) to change the setting.

Repeat this step to select MD, CDR, or HDD.

For the TAPE input selector, the setting changes in this order:

TAPE → MD → CDR → HDD

↑

For the VIDEO 3 input selector, the setting changes in this order:

VIDEO 3 ↔ HDD

Note:

HDD can be selected for the TAPE input selector or VIDEO 3 input selector, but not both at the same time.

Minimum Speaker Impedance (not North American models)

If you change this setting, you must run the automatic speaker setup again (see page 38).

If the impedance of any speaker is 4 ohms or more but less than 6, set the minimum speaker impedance to 4 ohms.

Note:

Before you change this setting, turn down the volume.

1

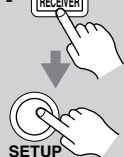

Press the [RECEIVER] button, followed by the [SETUP] button.
The main menu appears onscreen.

2

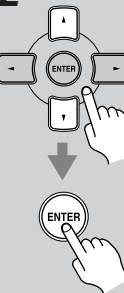

Use the Up and Down [▲]/[▼] buttons to select "8. Hardware Setup," and then press [ENTER].
The Hardware Setup menu appears.

```

8. Hardware Setup
-----
a. SP Impedance :6ohms00
b. PoweredZone2:NotAct00
c. TV Format      :Auto00
d. AM Freq. Step: 9kHz00
e. Remote ID     :100
f. HDMI Audio Out:Off00
g. SW Input Sensitivity
                   : 0dB00
            
```

3

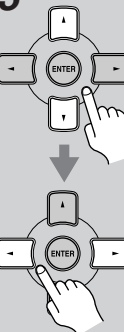

Use the Up and Down [▲]/[▼] buttons to select "SP Impedance," and then use the Left and Right [◀]/[▶] buttons to select:

4 ohms: Select if the impedance of any speaker is 4 ohms or more but less than 6.

6 ohms: Select if the impedances of all speakers are between 6 and 16 ohms.

4







Press the [SETUP] button.
Setup closes.

Note:

This procedure can also be performed on the AV receiver by using its [SETUP] button, arrow buttons, and [ENTER] button.

TV Format Setup (not North American models)

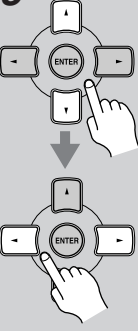
You must specify the TV system used in your area.





<p>1</p>  	<p>Press the [RECEPTOR] button, followed by the [SETUP] button. The main menu appears onscreen.</p>
<p>2</p> 	<p>Use the Up and Down [▲]/[▼] buttons to select “8. Hardware Setup,” and then press [ENTER]. The Hardware Setup menu appears.</p> <div data-bbox="322 647 617 888" style="border: 1px solid black; padding: 5px;"> <pre> 8. Hardware Setup ----- a. SP Impedance : 6ohms b. PoweredZone2 : NotAct c. TV Format : Auto d. AM Freq. Step: 9kHz e. Remote ID : 1 f. HDMI Audio Out : Off g. SW Input Sensitivity : 0dB </pre> </div>
<p>3</p> 	<p>Use the Up and Down [▲]/[▼] buttons to select “TV Format,” and then use the Left and Right [◀]/[▶] buttons to select:</p> <p>Auto: Select this to automatically detect the TV system from the video input signals.</p> <p>NTSC: Select if the TV system in your area is NTSC.</p> <p>PAL: Select if the TV system in your area is PAL.</p>
<p>4</p> 	<p>Press the [SETUP] button. Setup closes.</p>

Note:

- This procedure can also be performed on the AV receiver by using its [SETUP] button, arrow buttons, and [ENTER] button.

AM Frequency Step Setup (on some models)

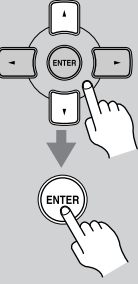
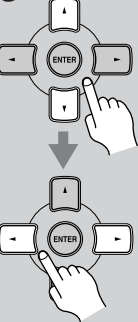
You must specify the AM frequency step used in your area. Note that when this setting is changed, all radio presets are deleted.

<p>1</p>  	<p>Press the [RECEPTOR] button, followed by the [SETUP] button. The main menu appears onscreen.</p>
<p>2</p> 	<p>Use the Up and Down [▲]/[▼] buttons to select “8. Hardware Setup,” and then press [ENTER]. The Hardware Setup menu appears.</p> <div data-bbox="919 695 1214 937" style="border: 1px solid black; padding: 5px;"> <pre> 8. Hardware Setup ----- a. SP Impedance : 6ohms b. PoweredZone2 : NotAct c. TV Format : Auto d. AM Freq. Step: 9kHz e. Remote ID : 1 f. HDMI Audio Out : Off g. SW Input Sensitivity : 0dB </pre> </div>
<p>3</p> 	<p>Use the Up and Down [▲]/[▼] buttons to select “AM Freq. Step,” and then use the Left and Right [◀]/[▶] buttons to select:</p> <p>10 kHz: Select if 10 kHz steps are used in your area.</p> <p>9 kHz: Select if 9 kHz steps are used in your area.</p>
<p>4</p> 	<p>Press the [SETUP] button. Setup closes.</p>

Note:

- This procedure can also be performed on the AV receiver by using its [SETUP] button, arrow buttons, and [ENTER] button.

Basic Operations

Selecting the Input Source

This section explains how to select the input source (i.e., the AV component that you want to listen to or watch).

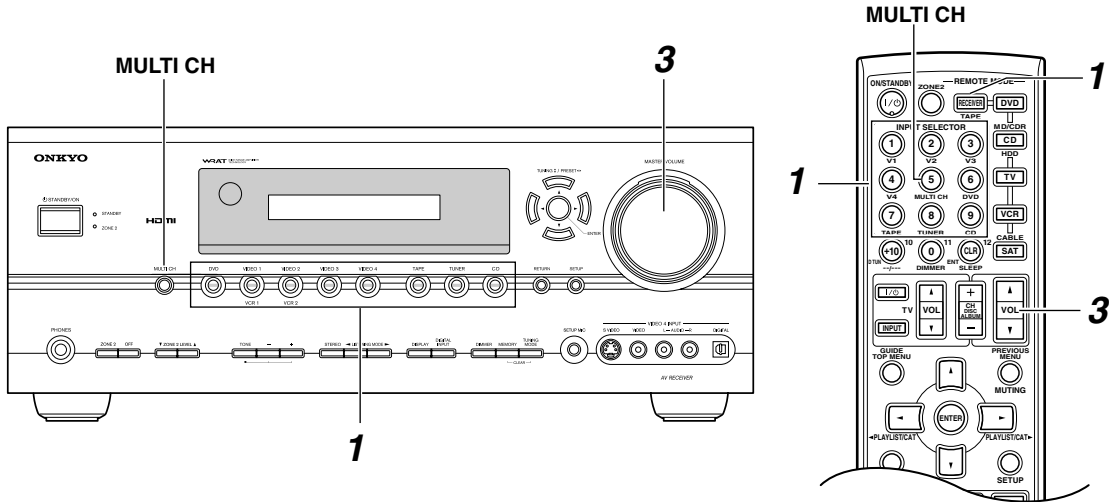

- 1**

AV receiver

Remote controller

Use the AV receiver's input selector buttons to select the input source.

To select the input source with the remote controller, press the [RECEIVER] button, and then use the INPUT SELECTOR buttons.

On the remote controller, the [V1], [V2], [V3], and [V4] buttons select the VIDEO 1, VIDEO 2, VIDEO 3, and VIDEO 4 input sources, respectively.
- 2**

Start playback on the source component.

When you select DVD or another video component, on your TV, you'll need to select the video input that's connected to the AV receiver's COMPONENT VIDEO OUT, HDMI OUT or MONITOR OUT.

On some DVD players, you may need to turn on the digital audio output.
- 3**

AV receiver

Remote controller

To adjust the volume, use the MASTER VOLUME control, or the remote controller's [VOL] button.

The volume can be set to MIN, 1 through 99, or MAX.

The AV receiver is designed for home theater enjoyment. It has a wide volume range, allowing precise adjustment.

Using the Multichannel DVD Input

The multichannel DVD input is for connecting a component with a 7.1-channel analog audio output, such as a DVD-Audio or SACD-capable DVD player, or an MPEG decoder. See page 26 for hookup information.

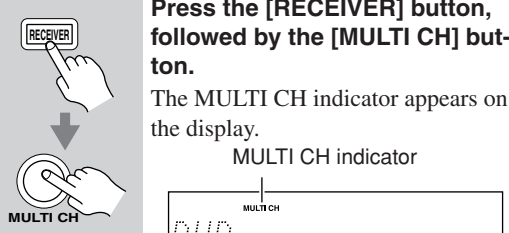

Press the [RECEIVER] button, followed by the [MULTI CH] button.

The MULTI CH indicator appears on the display.

AUDIO FROM THE MULTICHANNEL DVD INPUT WILL NOW BE USED FOR THE DVD INPUT SOURCE.

Note:

While the multichannel DVD input is selected, the Speaker Configuration settings on page 67 are ignored, and signals from the multichannel input are fed to the speakers as they are.

Adjusting the Bass & Treble

You can adjust the bass and treble for the front speakers, except when the Direct or Pure Audio (not North American models) listening mode is selected.

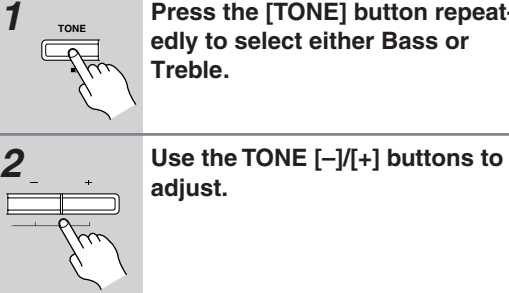

1 Press the [TONE] button repeatedly to select either Bass or Treble.

2 Use the TONE [-]/[+] buttons to adjust.

■ **Bass**

You can boost or cut low-frequency sounds output by the front speakers from -10 dB to +10 dB in 2 dB steps.

■ **Treble**

You can boost or cut high-frequency sounds output by the front speakers from -10 dB to +10 dB in 2 dB steps.

Displaying Source Information

You can display various information about the current input source as follows.

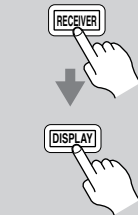

Press the [RECEIVER] button, and then press the [DISPLAY] button repeatedly to cycle through the available information.

Note:

This procedure can also be performed on the AV receiver by using its [DISPLAY] button.

The following information can typically be displayed for input sources.

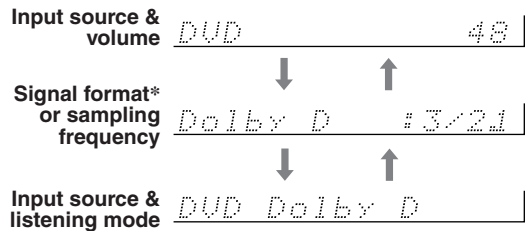

* If the input signal is analog, no format information is displayed. If the input signal is PCM, the sampling frequency is displayed. If the input signal is digital but not PCM, the signal format is displayed. Information is displayed for about three seconds, then the previously displayed information reappears.

Interpreting Surround Channel Values

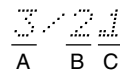

- A: The number of front channels (3 means front left, front right, and center).
- B: The number of surround channels (2 means surround left and surround right). If there's surround back channel information, this will be 3.
- C: LFE channel for subwoofer (1 means yes).

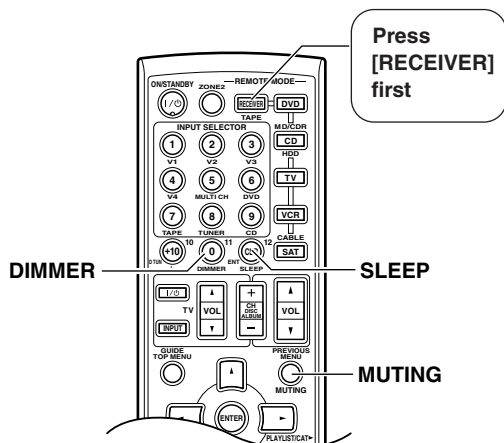

Setting the Display Brightness

You can adjust the brightness of the display.

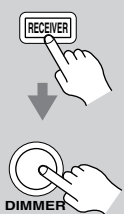

Press the [RECEIVER] button, and then press the [DIMMER] button repeatedly to select:

- Normal+VOLUME light on.
- Normal+VOLUME light off.
- Dim+VOLUME light off.
- Dimmer+VOLUME light off.

Muting the AV Receiver

You can temporarily mute the output of the AV receiver.

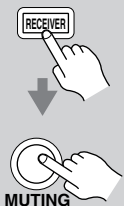

Press the [RECEIVER] button, and then press the [MUTING] button.

The output is muted and the MUTING indicator flashes on the display, as shown.



To unmute the AV receiver, press the [MUTING] button again, or adjust the volume.

The Mute function is cancelled when the AV receiver is set to Standby.

Using the Sleep Timer

With the sleep timer, you can set the AV receiver to turn off automatically after a specified period.

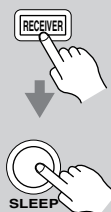

Press the [RECEIVER] button, and then press the [SLEEP] button repeatedly to select the required sleep time.

The sleep time can be set from 90 to 10 minutes in 10 minute steps.

The SLEEP indicator appears on the display when the sleep timer has been set. The specified sleep time appears on the display for about five seconds, then the previous display reappears.

If you need to cancel the sleep timer, press the [SLEEP] button repeatedly until the SLEEP indicator disappears.

To check the time remaining until the AV receiver sleeps, press the [SLEEP] button. Note that if you press the [SLEEP] button while the sleep time is being displayed, you'll shorten the sleep time by 10 minutes.

Using Headphones

You can connect a pair of stereo headphones (1/4-inch phone plug) to the AV receiver's PHONES jack for private listening, as shown.

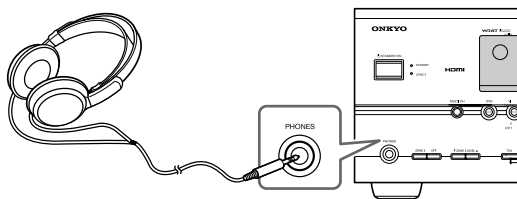

Notes:

- Always turn down the volume before connecting your headphones.
- The speakers are turned off while the headphones plug is inserted in the PHONES jack (Zone 2 speakers are not turned off).
- When you connect a pair of headphones, the listening mode is set to Stereo, unless it's already set to Stereo, Mono, Direct, or Pure Audio (not North American models).
- Only the Stereo, Direct, Pure Audio (not North American models), and Mono listening modes can be used with headphones (the listening modes available also depend on the currently selected input source).
- When the multichannel input is used, only the front left and right audio can be heard in the headphones.
- To adjust the headphone level, press the [CH SEL] button on the remote controller, and then press the [LEVEL +]/[LEVEL -] buttons. You can adjust the level between -12 dB and +12 dB.

Listening to the Radio

Using the Tuner

With the built-in tuner you can enjoy AM and FM radio stations. You can store your favorite stations as presets for quick selection.

Listening to the Radio

TUNER



Use the [TUNER] input selector button to select either AM or FM.

In this example, FM has been selected. Each time you press the [TUNER] button, the input source changes between AM and FM.

FM 87.5 MHz

Band Frequency

(Actual display depends on country)

Tuning into Radio Stations

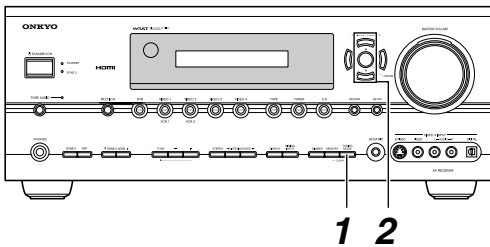

Auto Tuning Mode

1

TUNING MODE



Press the [TUNING MODE] button so that the AUTO indicator appears on the display.

2

TUNING / PRESET



Press the TUNING Up or Down [▲]/[▼] button.

Searching stops when a station is found.

When tuned into a station, the TUNED indicator appears. When tuned into a stereo FM station, the FM STEREO indicator appears on the display, as shown.

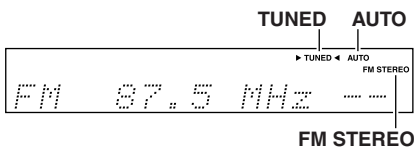

Manual Tuning Mode

1

TUNING MODE



Press the [TUNING MODE] button so that the AUTO indicator disappears from the display.

2

TUNING / PRESET

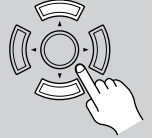

Press and hold the TUNING Up or Down [▲]/[▼] button.

The frequency stops changing when you release the button.

Press the buttons repeatedly to change the frequency one step at a time.

The North American models change FM frequency in 0.2 MHz steps, 10 kHz steps for AM. For other models it's 0.05 MHz steps for FM and 9 kHz steps for AM. In Manual Tuning mode, FM stations will be in mono.

Tuning into weak FM stereo stations

If the signal from a stereo FM station is weak, it may be impossible to get good reception. In this case, switch to Manual Tuning mode and listen to the station in mono.

Tuning into Stations by Frequency

You can tune into AM and FM stations directly by entering the appropriate frequency.

1

RECEIVER



Press the [RECEIVER] button, followed by the [D TUN] button.

D TUN



FM 87.5 MHz

(Actual display depends on country.)
The [RECEIVER] button flashes.

2

Within 8 seconds, use the number buttons to enter the frequency of the radio station.

For example, to tune to 87.5 (FM), press 8, 7, 5.

Note: While the [RECEIVER] button is flashing, the input source cannot be changed by using the remote controller.

Presetting AM/FM Stations & XM Channels

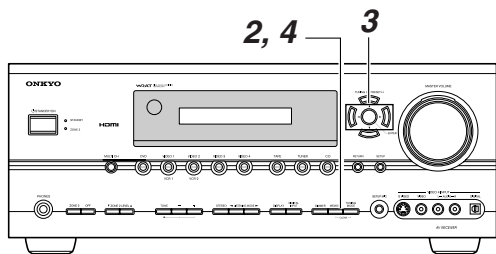

You can store a combination of up to 40 of your favorite AM/FM radio stations and XM channels as presets.

1 Tune into the AM/FM station or XM channel that you want to store as a preset.
See page 58 to select XM channel

2 Press the [MEMORY] button.
The MEMORY indicator appears and the preset number flashes.

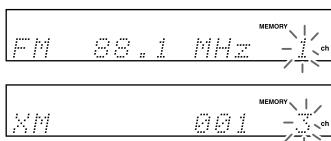
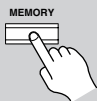

3 While the MEMORY indicator is displayed (about 8 seconds), use the PRESET [◀]/[▶] buttons to select a preset from 1 through 40.



4 Press the [MEMORY] button again to store the station or channel.
The station or channel is stored and the preset number stops flashing.
Repeat this procedure for all of your favorite AM/FM radio stations and XM channels.

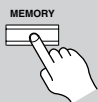

Selecting Presets

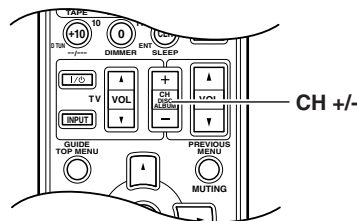
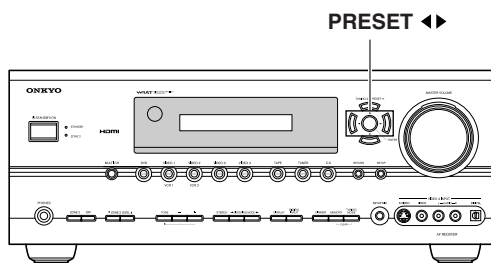

To select a preset, use the PRESET [◀]/[▶] buttons, or the remote controller's CH [+/-] button.

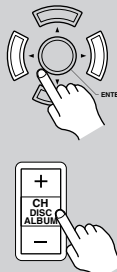

Deleting Presets

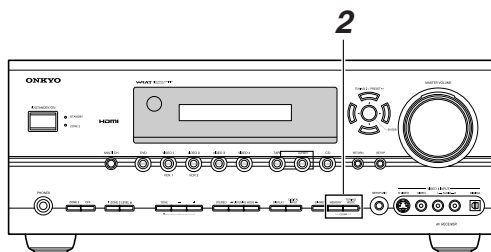

1 Select the preset that you want to delete.
See the previous section.

2 While holding down the [MEMORY] button, press the [TUNING MODE] button.
The preset is deleted and its number disappears from the display.

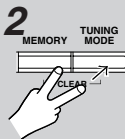

Using RDS (European models only)

RDS only works with European models and only in areas where RDS broadcasts are available.

When tuned into an RDS station, the RDS indicator appears.

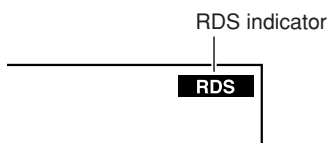

■ What is RDS?

RDS stands for *Radio Data System* and is a method of transmitting data in FM radio signals. It was developed by the European Broadcasting Union (EBU) and is available in most European countries. Many FM stations use it these days. In addition to displaying text information, RDS can also help you find radio stations by type (e.g., news, sport, rock, etc.).

The AV receiver supports four types of RDS information:

PS (Program Service)

When tuned to an RDS station that's broadcasting PS information, the station's name will be displayed. Pressing the [DISPLAY] button will display the frequency for 3 seconds.

RT (Radio Text)

When tuned to an RDS station that's broadcasting text information, the text will be shown on the display (see page 55).

PTY (Program Type)

This allows you to search for RDS radio stations by type (see page 55).

TP (Traffic Program)

This allows you to search for RDS radio stations that broadcast traffic information (see page 55).

Notes:

- In some cases, the text characters displayed on the AV receiver may not be identical to those broadcast by the radio station. Also, unexpected characters may be displayed when unsupported characters are received. This is not a malfunction.
- If the signal from an RDS station is weak, RDS data may be displayed intermittently or not at all.

RDS Program Types (PTY)

Type	Display
None	NONE
News reports	NEWS
Current affairs	AFFAIRS
Information	INFO
Sport	SPORT
Education	EDUCATE
Drama	DRAMA
Culture	CULTURE
Science and technology	SCIENCE
Varied	VARIED
Pop music	POP M
Rock music	ROCK M
Middle of the road music	EASY M
Light classics	LIGHT M
Serious classics	CLASSICS
Other music	OTHER M
Weather	WEATHER
Finance	FINANCE
Children's programmes	CHILDREN
Social affairs	SOCIAL
Religion	RELIGION
Phone in	PHONE IN
Travel	TRAVEL
Leisure	LEISURE
Jazz music	JAZZ
Country music	COUNTRY
National music	NATION M
Oldies music	OLDIES
Folk music	FOLK M
Documentary	DOCUMENT
Alarm test	TEST
Alarm	ALARM

Displaying Radio Text (RT)

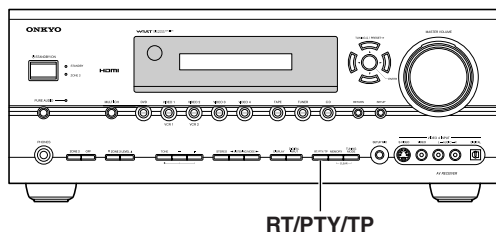

When tuned to an RDS station that's broadcasting text information, the text can be displayed.

RT/PTY/TP



Press the [RT/PTY/TP] button once.

The RT information scrolls across the display.

Notes:

- The message "Waiting" may appear while the AV receiver waits for the RT information.
- If the message "No Text Data" appears on the display, no RT information is available.

Finding Stations by Type (PTY)

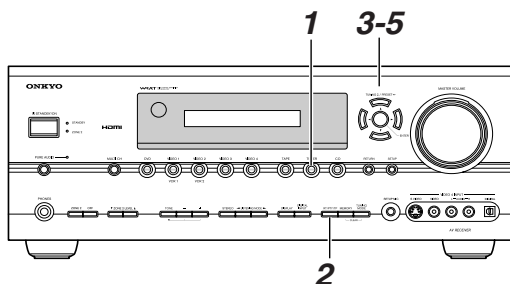

You can search for radio stations by type.

1

TUNER



Use the [TUNER] input selector button to select FM.

2

RT/PTY/TP



Press the [RT/PTY/TP] button twice.

The current program type appears on the display.

3

TUNING / PRESET



Use the PRESET [◀]/[▶] buttons to select the type of program you want.

See the table on page 54.

4

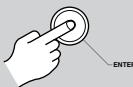

To start the search, press [ENTER].

The AV receiver searches until it finds a station of the type you specified, at which point it stops briefly before continuing with the search.

5

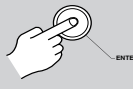

When a station you want to listen to is found, press [ENTER].

If no stations are found, the message "Not Found" appears.

Listening to Traffic News (TP)

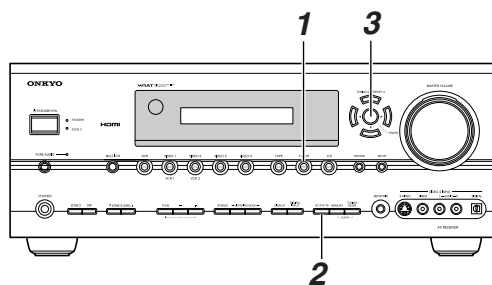

You can search for stations that broadcast traffic news.

1

TUNER



Use the [TUNER] input selector button to select FM.

2

RT/PTY/TP



Press the [RT/PTY/TP] button three times.

If the current radio station is broadcasting TP (Traffic Program), "[TP]" will appear on the display, and traffic news will be heard as and when it's broadcast. If "TP" without square brackets appears, this means that the station is not broadcasting TP.

3



To locate a station that is broadcasting TP, press [ENTER].

The AV receiver searches until it finds a station that's broadcasting TP. If no stations are found, the message "Not Found" appears.

Listening to XM Satellite Radio® (North American models only)

Important XM Radio Information

To receive XM Radio on this receiver you need to purchase an optional XM Passport System and subscribe to XM's paid programming. Please note that XM is currently only licensed to provide service to the contiguous 48 United States (not available in Alaska and Hawaii) and portions of Canada. XM Radio service is not currently available in Mexico or any other region outside the continental U.S. and portions of Canada. For updates on service availability please visit XM's website at <http://www.xmradio.com> or <http://www.xmradio.ca>

Note:

Hardware and required basic monthly subscription sold separately. Premium Channels available at additional monthly cost. Installation costs and other fees and taxes, including a one-time activation fee may apply. Subscription fee is consumer only. All fees and programming subject to change.

About XM Radio:

There is a world beyond AM and FM. It is XM Satellite Radio. XM offers more than 160 digital channels of audio entertainment, including 100% commercial-free music channels, in the top markets in the U.S.

Channels with frequent explicit language are indicated with an XL. Channel blocking is available for XM radio receivers by calling 1-800-XMRADIO.

About XM Canada:

XM Canada offers the most commercial-free music – and engaging talk show programs. XM Canada creates original content that reflects our unique Canadian culture and broadcasts it throughout North America.

Canadian Satellite Radio Inc. offers its satellite radio service and operates under the XM Canada™ brand. XM Canada has an exclusive Canadian licence from XM Satellite Radio Inc.

For more information about XM Canada, visit www.xmradio.ca or call 1-877-GET-XMSR

A warning against reverse engineering:

It is prohibited to copy, decompile, disassemble, reverse engineer, or manipulate any technology incorporated in receivers compatible with the XM Satellite Radio system. Furthermore, the AMBE® voice compression software included in this product is protected by intellectual property rights including patent rights, copyrights, and trade secrets of Digital Voice Systems, Inc. The user of this or any other software contained in an XM Radio is explicitly prohibited from attempting to copy, decompile, reverse engineer, or disassemble the object code, or in any other way convert the object code into human-readable form. The software is licensed solely for use within this product.

Connecting the XM Passport System

The XM Passport System is sold separately. You can purchase the *XM Passport System* from the XM Web site at: <http://www.xmradio.com> (U.S.A.)
<http://www.xmradio.ca> (Canada)

Connect the Passport System to the XM antenna jack on the rear panel.

XM antenna jack

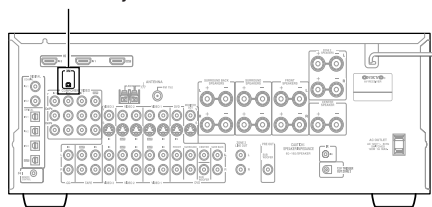

Put the XM Passport System by a southerly facing window, with nothing obstructing its path to the sky.

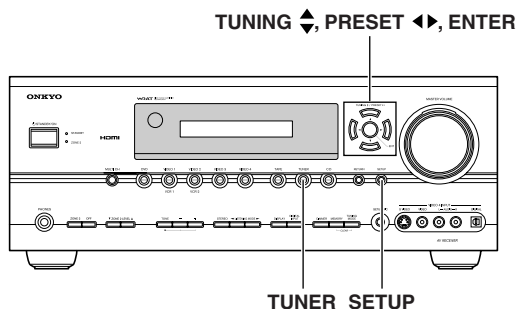

Setting the Satellite Radio Mode

<p>1</p>	<p>On the AV receiver, press the [SETUP] button.</p>
<p>2</p>	<p>Use the TUNING Up or Down [▲]/[▼] buttons to select “8. Hardware Setup,” and then press [ENTER].</p> <div data-bbox="307 855 602 1093" style="border: 1px solid black; padding: 5px;"> <pre> 8. Hardware Setup ----- a. PoweredZone2:NotAct00 b. SAT Radio : None 00 c. Remote ID : 100 d. HDMI Audio Out : Off00 e. SW Input Sensitivity : 0dB00 </pre> </div>
<p>3</p>	<p>Use the TUNING Up or Down [▲]/[▼] buttons to select “SAT Radio,” and then use the PRESET [◀]/[▶] buttons to select “XM.” Pressing the PRESET [◀]/[▶] buttons cycles through the following SAT options: None ↔ XM.</p> <p>None: Select if you are not using satellite radio.</p> <p>XM: Select to use XM satellite radio.</p>
<p>4</p>	<p>Press the [SETUP] button.</p>

Selecting XM Satellite Radio

<p>TUNER</p>	<p>Press the [TUNER] input selector button repeatedly to select XM. If “CHECK ANTENNA” appears on the display, make sure the XM Passport System is connected properly.</p>
---------------------	--

Signing Up for XM Satellite Radio

Before you can use XM Satellite Radio, you must first sign up for an account. You’ll need a major credit card and your XM Satellite Radio ID, which you can get from the AV receiver, as explained below, or from the Passport System package and itself.

<p>1</p>	<p>Use the TUNING Up and Down [▲]/[▼] buttons to select channel 0. Your XM Satellite Radio ID number is displayed. Write it below.</p> <p style="text-align: center;">ID _____</p>
<p>2</p>	<p>To sign up, go to: http://activate.xmradio.com Or call: 1-800-967-2346 For XM Canada, go to: http://xmradio.ca Or call: 1-877-GET-XMSR</p>

Notes:

- Channel 0 cannot be selected in Category Search mode. You must select Channel Search mode (see page 58).
- The following letters are not used in XM Satellite Radio IDs: I, O, S, F.

Listening to the Radio—Continued

Selecting XM Radio Channels

There are three ways to select XM radio channels:

- **Channel Search mode:** select any channel.
- **Category Search mode:** select channels by category.
- **Direct tuning:** enter channel number.

Note:

You can't select Channel Search or Category Search mode, while the Tuning Arrow indicators are flashing, as tuning is in progress.

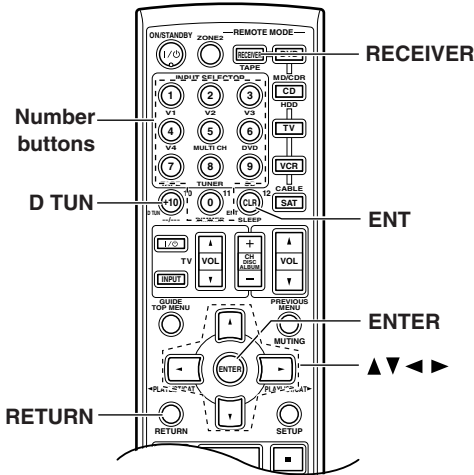

■ Channel Search Mode

1 Press the [RECEIVER] button, followed by the [ENTER] button to select “Channel Search” mode.

ChannelSearch

2 Use the Up and Down []/] buttons to select a channel.

050 The Loft

Channel number Channel name

You can also use the Left and Right []/] buttons to select a category.

■ Category Search Mode

1 Press the [RECEIVER] button, followed by the [ENTER] button to select “Category Search” mode.

CategorySearch

2 Use the Left and Right []/] buttons to select a category, and use the Up and Down []/] buttons to select a channel in that category.

■ Direct Tuning

You can select an XM radio channel directly by entering its number.

1 Press the [RECEIVER] button, followed by the [D TUN] button. The [RECEIVER] button flashes.

XM

2 Within 8 seconds, use the number buttons to enter the channel number.

The channel is selected.

For example, to select channel #20, press 0, 2, 0, or 2, 0, [ENT].

Note: While the [RECEIVER] button is flashing, the input source cannot be changed by using the remote controller.

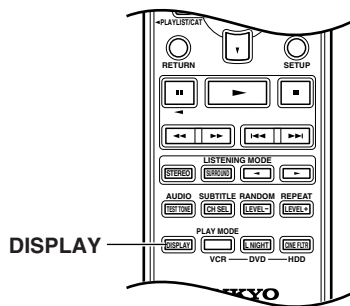
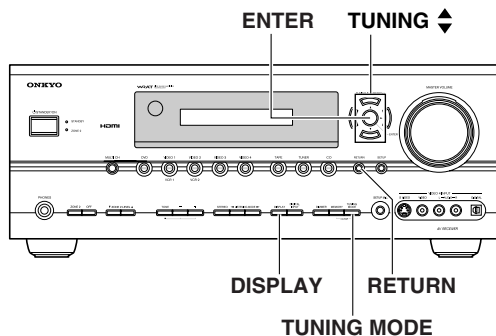

Selecting XM Channels from the Front Panel:

- 1** Press the [TUNING MODE] button to select “Channel Search” or “Category Search” mode.
- 2** Press the [ENTER] button repeatedly to select a category.
- 3** Use the TUNING Up and Down [▲]/[▼] buttons to select a channel.
 In Channel Search mode, you can select any channel.
 In Category Search mode, you can only select channels from the currently selected category.

Selecting the Previous Channel:

- To listen to the previously selected XM channel, press the [RETURN] button.
-
-

Displaying XM Radio Information

- Press the [DISPLAY] button repeatedly to cycle through the available information.
-
-

The following information can be displayed:

- Channel name XM The Loft
- Channel number & preset number XM 050 5
- Category CAT >Rock
- Artist NAME>Coldplay
- Song title TITL>Clocks
- Listening mode XM Stereo

Note:

If the category, artist, or song title is not available, “- - -” will be displayed instead.

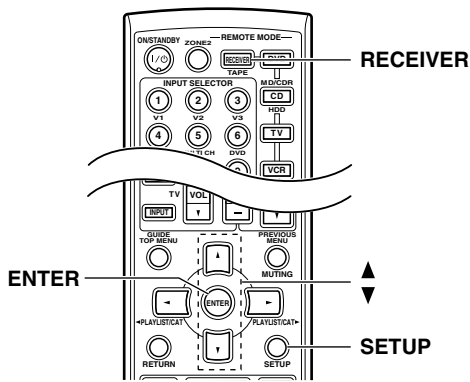

Terrestrial (TER) signals are only available in certain areas. So long as the signal strength is good, you can enjoy XM Radio by using either satellite or terrestrial reception.

XM Radio Messages

The following messages may appear while using XM radio.

CHECK ANTENNA

The XM Passport System is not connected properly. Check the connection.

UPDATING

The XM user encryption code is being updated. Please wait.

NO SIGNAL

The signal is too weak. Check the XM Passport System connection and reposition it for the best reception.

LOADING

The AV receiver is tuning or decoding audio or text data. Please wait.

OFF AIR

The XM channel you selected is not currently broadcasting. Select another channel.

Positioning the XM Passport System

You can check the signal strength of the XM radio signal and adjust the position of the XM Passport System accordingly.

1

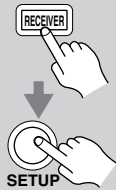

Press the [RECEIVER] button followed by the [SETUP] button. The main menu appears onscreen.

2

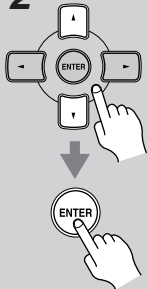

Use the Up and Down [▲]/[▼] buttons to select “6. Input Setup,” and then press [ENTER]. The Input Setup menu appears.

3

Adjust the position of the XM Passport System so that the SAT/TER signal strength bar is as long as possible.

```
6. Input Setup
-----TUNER-----
a. IntelliVolume: +12dB
Listening Mode Preset
b. Analog : Last Valid

Antenna Aiming( XM )
SAT [■■■■■■■■■■]
TER [■■■■■■■■■■]
```



Using the Listening Modes

Selecting Listening Modes

See “About the Listening Modes” on page 63 for detailed information about the listening modes.

- The Dolby Digital and DTS listening modes can only be selected if your DVD player is connected to the AV receiver with a digital audio connection (coaxial or optical).
- Listening mode availability depends on the format of the current input signal.

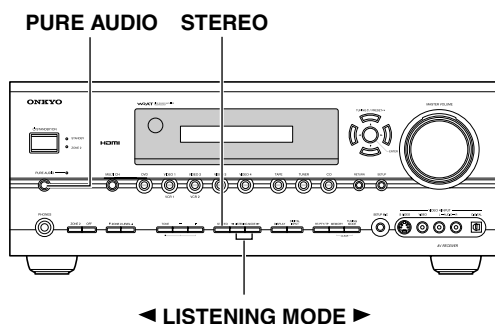
Selecting on the AV Receiver



■ [PURE AUDIO] button (not North American models)

This button selects the Pure Audio listening mode. When this mode is selected, the AV receiver's display is turned off and only video signals input through HDMI IN can be output. Pressing this button again will select the previous listening mode.

■ [STEREO] button

This button selects the Stereo listening mode.

■ LISTENING MODE [◀] [▶] buttons

Pressing these buttons repeatedly cycles through all of the listening modes that can be used with the current input source.

Selecting with the Remote Controller

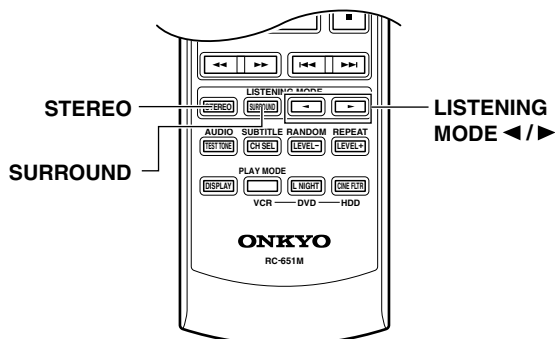

■ [SURROUND] button

This button selects the Dolby Digital and DTS listening modes and the Neural Surround* listening mode (*North American models only).

■ [STEREO] button

This button selects the Stereo listening mode.

■ LISTENING MODE [◀] [▶] buttons

Pressing these buttons repeatedly cycles through all of the listening modes that can be used with the current input source.

Using the Listening Modes—Continued

The following table shows which listening modes can be used with each input signal format.

Source format		Analog, PCM ¹	Dolby Digital				DTS/DTS 96/24 ²			Multich analog, Multich PCM
			3/2.1 2/2.1	2/0	1/0, 1+1	Other	3/2.1 2/2.1	2/0	DTS-ES	
		CD, TV, radio, cassette, etc.	DVD, DTV, etc.				DVD, CD, etc.			DVD
Listening mode										
Pure Audio (not North American models) Direct		✓	✓	✓	✓	✓	✓	✓	✓	✓
Stereo		✓	✓	✓	✓	✓	✓	✓	✓	
Mono		✓	✓	✓	✓	✓	✓	✓	✓	
Multich										✓
PLIIx Movie/Music/Game ³ Neo:6 Cinema Neo:6 Music		✓		✓				✓		
Neural Surround (North American models only)		✓ ⁴								
Dolby	Dolby D		✓			✓				
	Dolby+Neo:6 Dolby D EX Dolby D+PLIIx Music		✓							
	Dolby D+PLIIx Movie		✓							
DTS	DTS, DTS 96/24					✓			✓ ⁵	
	DTS-ES Discrete							✓		
	DTS-ES Matrix								✓	
	DTS+Neo:6 DTS+Dolby EX DTS+PLIIx Music					✓				
	DTS+PLIIx Movie					✓				
T-D		✓	✓	✓	✓	✓	✓	✓	✓	
Onkyo Original DSP	Mono Movie Orchestra Unplugged Studio-Mix TV Logic All Ch Stereo Full Mono	✓ ⁶	✓	✓	✓	✓	✓	✓	✓	

1. In the Pure Audio and Direct listening modes, 32 kHz, 44.1 kHz, and 48 kHz PCM is processed at 64 kHz, 88.2 kHz, and 96 kHz respectively. In listening modes other than Pure Audio, Direct, and Stereo, 64 kHz, 88.2 kHz, and 96 kHz PCM is processed at 32 kHz, 44.1 kHz, and 48 kHz respectively. For PCM 176.4/192 kHz signals input through HDMI IN, only Pure Audio, Direct, and Stereo listening modes can be selected.
2. In listening modes other than Pure Audio, Direct, Stereo, and DTS 96/24, DTS 96/24 sources are processed as normal DTS.
3. If the Surr Back parameter is set to None, or the ZONE 2 SPEAKERS terminals are being used, normal Pro Logic II is used.
4. Not available for 88.2 kHz and 96 kHz PCM input signals.
5. If the Surr Back setting is set to None, or the ZONE 2 SPEAKERS terminals are being used, normal DTS is used.
6. Available only when surround speakers are connected.

- : Only available on 6.1/7.1-channel playback systems. Not available while the ZONE 2 SPEAKERS terminals are being used.
- : Only available on 7.1-channel playback systems. Not available while the ZONE 2 SPEAKERS terminals are being used.

Tip: To check the format of the digital input signal, see “Displaying Source Information” on page 50.

About the Listening Modes

The AV receiver's listening modes can transform your listening room into a movie theater or concert hall, with high fidelity and stunning surround sound.

The illustration shows which speakers are active in each listening mode with 7.1 channel speaker system.

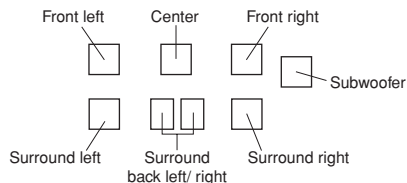

Pure Audio (not North American models)

In this mode, the display and video circuitry are turned off, minimizing possible noise sources for the ultimate in high-fidelity reproduction. (As the video circuitry is turned off, only video signals input through HDMI IN can be output.)

Direct

In this mode, audio from the input source is output directly with minimal processing, providing high-fidelity reproduction. All of the source's audio channels are output as they are.

Stereo

Sound is output by the front left and right speakers and subwoofer.

Mono

Use this mode when watching an old movie with a mono soundtrack, or use it with the foreign language soundtracks recorded in the left and right channels of some movies. It can also be used with DVDs or other sources containing multiplexed audio, such as karaoke DVDs.

Dolby Pro Logic IIx

Dolby Pro Logic II

Dolby Pro Logic IIx expands any 2-channel source for 7.1-channel playback. It provides a very natural and seamless surround-sound experience that fully envelops the listener. As well as music and movies, video games can also benefit from the dramatic spatial effects and vivid imaging. If you're not using any surround back speakers, **Dolby Pro Logic II** will be used instead of Dolby Pro Logic IIx.

- **PLIIx Movie**

Use this mode with any stereo or Dolby Surround (Pro Logic) movie (e.g., TV, DVD, VHS).

- **PLIIx Music**

Use this mode with any stereo or Dolby Surround (Pro Logic) music source (e.g., CD, radio, cassette, TV, VHS, DVD).

- **PLIIx Game**

Use this mode with video games, especially those that bear the Dolby Pro Logic II logo.

Dolby Digital

Use this mode with DVDs that bear the Dolby Digital logo, and Dolby Digital TV broadcasts. This is the most common digital surround-sound format, and it'll put you right in the middle of the action, just like being in a movie theater or concert hall.



Dolby Digital EX DTS+Dolby EX

These modes expand 5.1-channel Dolby Digital and DTS sources for 6.1/7.1-channel playback. They're especially suited to Dolby Digital EX soundtracks that include a matrix-encoded surround back channel. The additional channel adds an extra dimension and provides an enveloping surround sound experience, perfect for rotating and fly-by sound effects. Use them with DVDs that bear the Dolby Digital or DTS logo.



Dolby Digital+PLIIx Music DTS+PLIIx Music

These modes use the Pro Logic IIx Music mode to expand 5.1-channel Dolby Digital and DTS sources for 6.1/7.1-channel playback. Use them with Dolby Digital or DTS 5.1 music sources (e.g., DVD and Dolby Digital TV broadcasts).



Dolby Digital+PLIIx Movie DTS+PLIIx Movie

These modes use the Pro Logic IIx Movie mode to expand 5.1-channel Dolby Digital and DTS sources for 7.1-channel playback. Use them with Dolby Digital and DTS 5.1 movies (e.g., DVD and select digital TV broadcasts).



DTS

The DTS digital surround-sound format supports up to 5.1 discrete channels and uses less compression for high-fidelity reproduction. Use it with DVDs and CDs that bear the DTS logo.



DTS 96/24

This mode is for use with DTS 96/24 sources. This is high-resolution DTS with a 96 kHz sampling rate and 24-bit resolution, providing superior fidelity. Use it with DVDs that bear the DTS 96/24 logo.



DTS-ES Discrete

This mode is for use with DTS-ES Discrete soundtracks, which use a discrete surround back channel for true 6.1/7.1-channel playback. The seven totally separate audio channels provide better spatial imaging and 360-degree sound localization, perfect for sounds that pan across the surround channels. Use it with DVDs that bear the DTS-ES logo, especially those with a DTS-ES Discrete soundtrack.



DTS-ES Matrix

This mode is for use with DTS-ES Matrix soundtracks, which use a matrix-encoded back-channel for 6.1/7.1-channel playback. Use it with DVDs that bear the DTS-ES logo, especially those with a DTS-ES Matrix soundtrack.



DTS Neo:6

This mode expands any 2-channel source for 6.1-channel playback. It uses six full-bandwidth channels of matrix decoding for matrix-encoded material, providing a very natural and seamless surround sound experience that fully envelops the listener.

- **Neo:6 Cinema**
Use this mode with any stereo movie (e.g., TV, DVD, VHS).
- **Neo:6 Music**
Use this mode with any stereo music source (e.g., CD, radio, cassette, TV, VHS, DVD).

Dolby Digital + Neo:6 DTS+Neo:6

This mode uses Neo:6 to expand 5.1-channel Dolby Digital and DTS sources for 6.1/7.1-channel playback. Use it with DVDs that bear the Dolby Digital or DTS logo and feature a 5.1-channel soundtrack.



Neural Surround

(North American models only)

Neural Surround represents the latest advancement in surround technology developed for music and is adopted by XM Satellite Radio for digital radio broadcast of surround recordings and live events in surround sound. Neural Surround employs psychoacoustic frequency-domain processing, which allows delivery of a more detailed sound stage, with superior channel separation and localization of audio elements. System playback is scalable from 5.1 to 7.1 multichannel surround playback.

Onkyo Original DSP Modes

Mono Movie

This mode is suitable for old movies and other mono sources. The center speaker outputs the sound as it is, while reverb is applied to the sound output by the other speakers, giving presence to even mono material.

Orchestra

Suitable for classical or operatic music, this mode emphasizes the surround channels in order to widen the stereo image, and simulates the natural reverberation of a large hall.

Unplugged

Suitable for acoustic instruments, vocals, and jazz, this mode emphasizes the front stereo image, giving the impression of being right in front of the stage.

Studio-Mix

Suitable for rock or pop music, listening to music in this mode creates a lively sound field with a powerful acoustic image, like being at a club or rock concert.

TV Logic

This mode adds realistic acoustics to TV shows produced in a TV studio, surround effects to the entire sound, and clarity to voices.

All Ch Stereo

Ideal for background music, this mode fills the entire listening area with stereo sound from the front, surround, and surround back speakers.

Full Mono

In this mode, all speakers output the same sound in mono, so the sound you hear is the same regardless of where you are within the listening room.

T-D (Theater-Dimensional) or

With this mode you can enjoy a virtual 5.1 surround sound even with only two or three speakers. This works by controlling how sounds reach the listener's left and right ears. Good results may not be possible if there's too much reverb, so we recommend that you use this mode in an environment with little or no natural reverb.

Recording

This section explains how to record the selected input source to a component with recording capability, and how to record audio and video from different sources.

Notes:

- The surround sound and DSP listening modes cannot be recorded.
- Copy-protected DVDs cannot be recorded.
- You cannot record from the DVD analog multichannel input.
- Various restrictions apply to digital recording. Refer to the manuals supplied with your digital recording equipment for more details.
- Digital signals received at COAXIAL IN/OPTICAL IN or HDMI IN 1/2 are only output by OPTICAL OUT. However, certain types of digital signal such as DVD-Audio signal input from HDMI IN will not be output. Analog input signals are output by only the analog outputs. There is no internal conversion from digital to analog or vice versa.
- DTS signals will be recorded as noise, so don't attempt analog recording of DTS CDs or LDs.
- While the listening mode is set to Pure Audio, no image is provided because the power is turned off for the video circuit. If you want to make recordings, select other listening mode.

AV Recording

Audio sources can be recorded to a recorder (e.g., cassette deck, CDR, MD) connected to the TAPE OUT or DIGITAL OPTICAL OUT jacks. Video sources can be recorded to a video recorder (e.g., VCR, DVD recorder) connected to the VIDEO 1 OUT or VIDEO 2 OUT jacks. See pages 23 to 36 for hookup information.

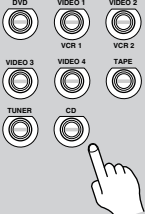
1	<p>Use the input selector buttons to select the source that you want to record.</p> <p>You can watch the source while recording. The AV receiver's VOLUME control has no effect on recording.</p> 
2	<p>On your recorder, start recording.</p>
3	<p>On the source component, start playback.</p> <p>If you select another input source during recording, that input source will be recorded.</p>

Recording Separate AV Sources

Here you can record audio and video from completely separate sources, allowing you to overdub audio onto your video recordings. This function takes advantage of the fact that when an audio-only input source (i.e., TAPE, TUNER, or CD) is selected, the video input source remains unchanged.

In the following example, audio from the CD player connected to the CD IN, and video from the camcorder connected to the VIDEO 4 INPUT VIDEO jack are recorded by the VCR connected to the VIDEO 1 OUT jacks.

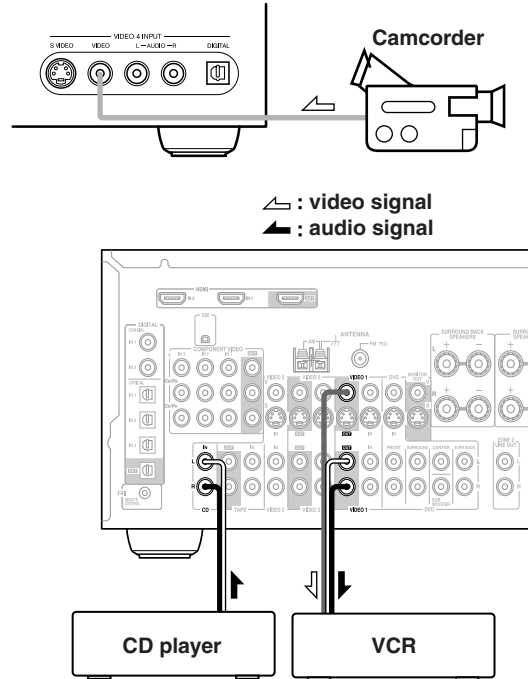

- 1 Prepare the camcorder and CD player for playback.**
- 2 Prepare the VCR for recording.**
- 3 Press the [VIDEO 4] input selector button.**
- 4 Press the [CD] input selector button.**
This selects the CD player as the audio source, but leaves the camcorder as the video source.
- 5 Start recording on the VCR and start playback on the camcorder and CD player.**
The video from the camcorder and the audio from the CD player are recorded by the VCR.

Advanced Operations

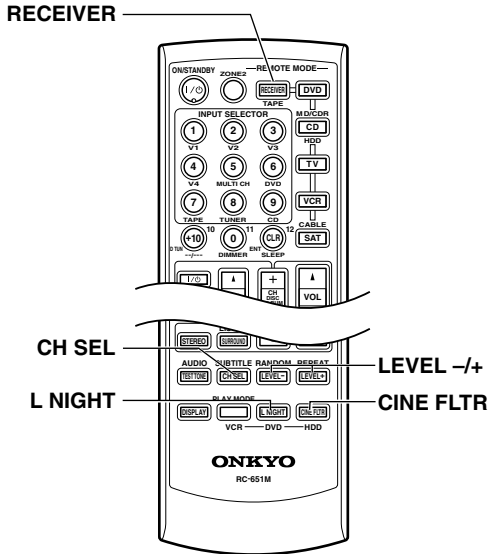

Using the CinemaFILTER

With the CinemaFILTER, you can soften overly bright movie soundtracks, which are typically mixed for reproduction in a movie theater.

CinemaFILTER can be used with the following listening modes: Dolby Digital, Dolby Digital EX, Dolby Pro Logic IIx Movie, Dolby Pro Logic II Movie, DTS, DTS-ES, DTS Neo:6 Cinema, DTS 96/24, Dolby/DTS+PLIIx Movie, Dolby/DTS+Neo:6, and DTS+Dolby EX.

Press the [RECEIVER] button, and then press the [CINE FLTR] button repeatedly to select:

- On:** CinemaFILTER on.
- Off:** CinemaFILTER off.

Using the Late Night Function (Dolby Digital only)

With the Late Night function, you can reduce the dynamic range of Dolby Digital material so that you can still hear quiet parts even when listening at low volume levels—ideal for watching movies late at night when you don't want to disturb anyone.

Press the [RECEIVER] button, and then press the [L NIGHT] button repeatedly to select:

- Off:** Late Night function off.
- Low:** Small reduction in dynamic range.
- High:** Big reduction in dynamic range.

Notes:

- The effect of the Late Night function depends on the Dolby Digital material that you are playing, and with some material there will be little or no effect.
- The Late Night function is set to Off when the AV receiver is set to Standby.

Adjusting Individual Speaker Levels

You can adjust the level of individual speakers during playback. These adjustments are temporary and will be cancelled when the AV receiver is set to Standby.

Press the [RECEIVER] button, use the [CH SEL] button to select each speaker, and use the [LEVEL-] and [LEVEL+] buttons to adjust the volume.

Speakers are selected in the following order: Front Left → Center → Front Right → Surr Right → Surr Back Right → Surr Back Left → Surr Left → Subwoofer.

You can adjust the volume of each speaker from -12 dB to +12 dB (-15 dB to +12 dB for the subwoofer). The name of the currently selected speaker and its volume appear on the display, as shown.

Left : 0dB

Notes:

- You cannot use this function while the AV receiver is muted.
- Speakers that are set to No or None in the Speaker Configuration cannot be adjusted.

Advanced Setup

Speaker Setup

Some of the settings in this section are set automatically by the Automatic Speaker Setup function (see page 38). Here you can check the settings made by the Automatic Speaker Setup function, or set them manually, which is useful if you change one of the connected speakers after using the Automatic Speaker Setup function.

Speaker Configuration

This setting is set automatically by the Automatic Speaker Setup function (see page 38).

With these settings, you can specify which speakers are connected and a crossover frequency for each speaker.

The following crossover frequencies can be specified: Full Band, 40 Hz, 50 Hz, 60 Hz, 80 Hz, 100 Hz, 120 Hz, 150 Hz, 200 Hz.

Specify Full Band for speakers that can output low-frequency bass sounds adequately, for example, speakers with a good sized woofer. For smaller speakers, specify a crossover frequency. Sounds below the crossover frequency will be output by the subwoofer instead of the speaker. Refer to your speakers' manuals to determine the optimum crossover frequencies.

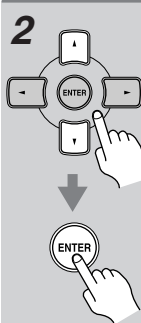
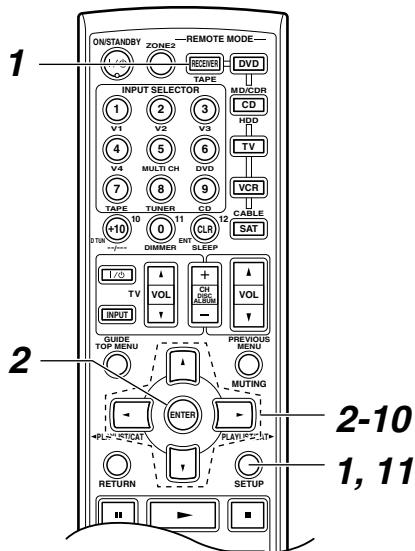

2 Use the Up and Down [**▲**]/[**▼**] buttons to select “1. Speaker Config,” and then press [ENTER].

The Speaker Config menu appears.

1. Speaker Config	
a. Subwoofer	:Yes 00
b. Front	: 100Hz 00
c. Center	: 100Hz 00
d. Surround	: 100Hz 00
e. SurrBack	: 100Hz 00
f. SurrBack Ch	: 2ch 00
g. LPFoLFE	: 120Hz 00
h. DoubleBass	:---

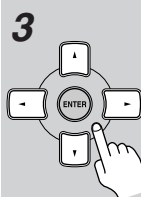

3 Use the Up and Down [**▲**]/[**▼**] buttons to select “a. Subwoofer,” and then use the Left and Right [**◀**]/[**▶**] buttons to select:

Yes: Select if a subwoofer is connected.

No: Select if no subwoofer is connected.

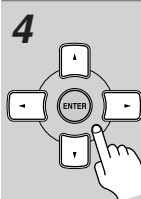

4 Use the Up and Down [**▲**]/[**▼**] buttons to select “b. Front,” and then use the Left and Right [**◀**]/[**▶**] buttons to select a crossover frequency.

Note:

If the Subwoofer setting in step 3 is set to No, this setting is fixed at Full Band.

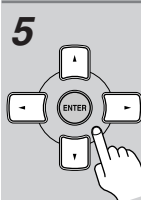

5 Use the Up and Down [**▲**]/[**▼**] buttons to select “c. Center,” and then use the Left and Right [**◀**]/[**▶**] buttons to select a crossover frequency.

If no center speaker is connected, select None.

Note:

If the Front setting in step 4 is set to anything other than Full Band, Full Band cannot be selected here.



1 Press the [RECEIVER] button followed by the [SETUP] button.

The main menu appears onscreen.

6

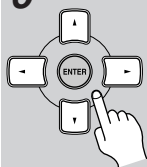

Use the Up and Down [▲]/[▼] buttons to select “d. Surround,” and then use the Left and Right [◀]/[▶] buttons to select a crossover frequency.

If no surround left and right speakers are connected, select None.

Note:

If the Front setting in step 4 is set to anything other than Full Band, Full Band cannot be selected here.

7

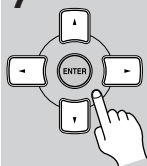

Use the Up and Down [▲]/[▼] buttons to select “e. SurrBack,” and then use the Left and Right [◀]/[▶] buttons to select a crossover frequency.

If no surround back speakers are connected, select None.

Notes:

- If the Surround setting in step 6 is set to None, this setting cannot be selected.
- If the Surround setting in step 6 is set to anything other than Full Band, Full Band cannot be selected here.

8

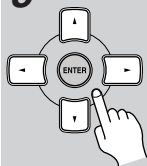

Use the Up and Down [▲]/[▼] buttons to select “f. SurrBack Ch,” and then use the Left and Right [◀]/[▶] buttons to select:

- 1ch:** Select if one surround back speaker is connected.
- 2ch:** Select if two (left and right) surround back speakers are connected.

Note:

If the Surround Back Setting in step 7 is set to None, this setting cannot be selected.

Continue with step 9 in the right column.

Low-Pass Filter for the LFE Channel

This setting is **not** set automatically by the Automatic Speaker Setup function (see page 38).

With this setting, you can specify the cutoff frequency of the LFE channel’s low-pass filter (LPF), which can be used to filter out unwanted hum. The LPF only applies to sources that use the LFE channel.

9

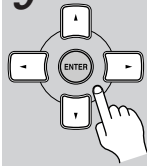

Use the Up and Down [▲]/[▼] buttons to select “g. LPFofLFE,” and then use the Left and Right [◀]/[▶] buttons to select a low-pass filter frequency.

The following low-pass filter frequencies can be selected: 80 Hz, 100 Hz, 120 Hz (default), 150 Hz, or 200 Hz. Continue with step 10 below.

Double Bass

This setting is not set automatically by the Automatic Speaker Setup function (see page 38).

With the Double Bass function, you can boost bass output by feeding bass sounds from the front left and right channels to the subwoofer. This function can be set only if the Subwoofer setting in step 3 is set to Yes, and the Front setting in step 4 is set to Full Band.

In the speaker setup screen, you can choose how bass information is distributed to your speakers only if you have large front left and right speakers AND a subwoofer.

10

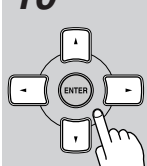

Use the Up and Down [▲]/[▼] buttons to select “h. Double Bass,” and then use the Left and Right [◀]/[▶] buttons to select:

- On:** Double Bass function on (default). Front left and right bass also goes to the subwoofer simultaneously.
- Off:** Double Bass function off.

11



Press the [SETUP] button. The setup menu closes.

Note:

This procedure can also be performed on the AV receiver by using its [SETUP] button, arrow buttons, and [ENTER] button.

Speaker Distance

This setting is set automatically by the Automatic Speaker Setup function (see page 38).

Here you can specify the distance from each speaker to the listening position so that the sound from each speaker arrives at the listener's ears as the sound designer intended.

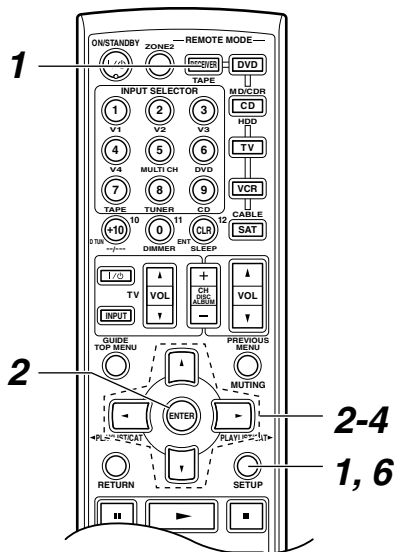

1 Press the [RECEIVER] button followed by the [SETUP] button. The main menu appears onscreen.

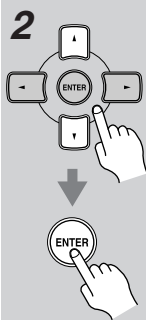

2 Use the Up and Down [▲]/[▼] buttons to select “2. Speaker Distance,” and then press [ENTER]. The Speaker Distance menu appears.

2. Speaker Distance	
a. Unit	: meters
b. Front	: 3.6m
c. Center	: 3.6m
d. SurrRight	: 2.1m
e. SurrBack R	: 2.1m
f. SurrBack L	: 2.1m
g. SurrLeft	: 2.1m
h. Subwoofer	: 3.6m

Note: Speakers that you set to No or None on the Speaker Configuration page (page 67) cannot be selected.

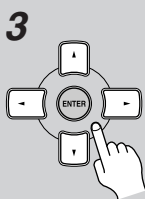

3 Use the Up and Down [▲]/[▼] buttons to select “a. Unit,” and then use the Left and Right [◀]/[▶] buttons to select:

feet: Select if you want to enter distances in feet. Can be set from 1 to 30 feet in 1-foot steps.

meters: Select if you want to enter distances in meters. Can be set from 0.3 to 9 meters in 0.3-meter steps.

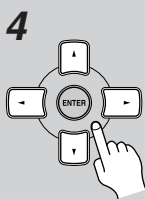

4 Use the Up and Down [▲]/[▼] buttons to select “b. Front,” and then use the Left and Right [◀]/[▶] buttons to specify the distance. Specify the distance from the front left speaker to your listening position.

5 Repeat step 4 for all speakers.



6 Press the [SETUP] button. The setup menu closes.

Notes:

- The Center and Subwoofer distances can be set up to 5 ft. (1.5 m) more or less than the Front distance. For example, if the Front distance is set to 20 ft. (6 m), the Center and Subwoofer distances can be set between 15 and 25 ft. (4.5 and 7.5 m). The Surr Right, Surr Left, and Surr Back distances can be set up to 5 ft. (1.5 m) more or 15 ft. (4.5 m) less than the Front distance. For example, if the Front distance is set to 20 ft. (6 m), the Surr Right, Surr Left, and Surr Back distances can be set between 5 and 25 ft. (1.5 and 7.5 m).
- This procedure can also be performed on the AV receiver by using its [SETUP] button, arrow buttons, and [ENTER] button.

Speaker Level Calibration

This setting is set automatically by the Automatic Speaker Setup function (see page 38).

Here you can adjust the level of each speaker with the built-in test tone so that the volume of each speaker is the same at the listening position.

Note:

The speakers cannot be calibrated while the output of the AV receiver is muted or while a pair of headphones is connected.

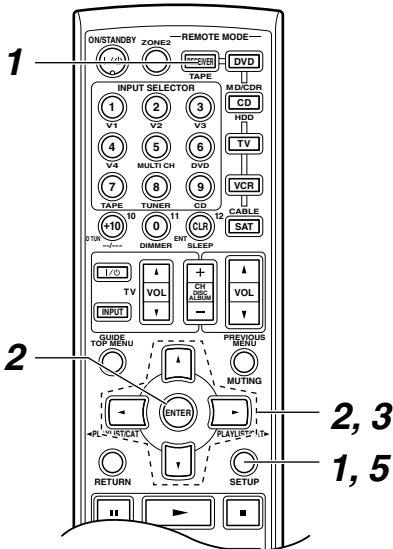



1



RECEIVER
SETUP

Press the [RECEIVER] button followed by the [SETUP] button.
The main menu appears onscreen.

2

Use the Up and Down [▲]/[▼] buttons to select “3. Level Calibration,” and then press [ENTER].
The Level Calibration menu appears and the pink noise test tone is output by the front left speaker.

3.Level Calibration		
a. Left	:	0dB
b. Center	:	0dB
c. Right	:	0dB
d. SurrRight	:	0dB
e. SurrBack R	:	0dB
f. SurrBack L	:	0dB
g. SurrLeft	:	0dB
h. Subwoofer	:	0dB

3

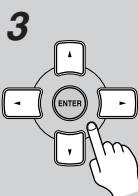

Use the Up and Down [▲]/[▼] buttons to select each speaker, and use the Left and Right [◀]/[▶] buttons to set the volume.
The volume can be adjusted from -12 to +12 dB in 1 dB steps (-15 to +12 dB for the subwoofer).

4

Repeat step 3 until the volume of the test tone from each speaker is the same.

5



SETUP

Press the [SETUP] button.
The setup menu closes.

Note:
This procedure can also be performed by using the remote controller. First press the [TEST TONE] button to output the test tone. Use the [LEVEL-] and [LEVEL+] buttons to set the volume, and use the [CH SEL] button to select the speakers.

Equalizer Setting

This setting is set automatically by the Automatic Speaker Setup function (see page 38).

Here you can adjust the EQ of individual speakers. To set the volume of individual speakers see page 70.

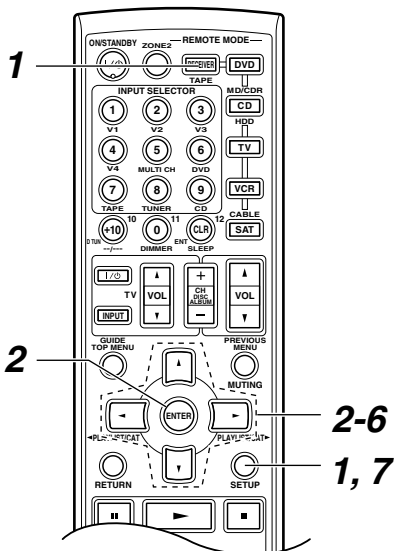

1 Press the [RECEIVER] button followed by the [SETUP] button. The main menu appears onscreen.



2 Use the Up and Down [▲]/[▼] buttons to select “4. Equalizer Settings,” and then press [ENTER]. The Equalizer Settings menu appears.



3 Use the Left and Right [◀]/[▶] buttons to select:



Off: Tone off, response flat.
Audyssey: The tone for each speaker is set automatically by the Automatic Speaker Setup function.

Be sure to select this setting after having performed the Automatic Speaker Setup.

Manual: You can adjust the EQ of each speaker manually.

If you select Manual, continue with this procedure. If you select Off or Audyssey, go to step 7.

4 Use the Down [▼] button to select “Channel,” and then use the Left and Right [◀]/[▶] buttons to select a speaker.

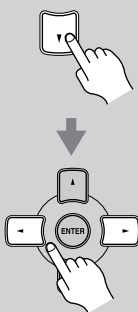

4. Equalizer Settings	
a. Equalizer	: Manual
b. Channel	: Front
c. 80Hz	: 0dB
d. 250Hz	: 0dB
e. 800Hz	: 0dB
f. 2500Hz	: 0dB
g. 8000Hz	: 0dB

5 Use the Up and Down [▲]/[▼] buttons to select a frequency, and then use the Left and Right [◀]/[▶] buttons to adjust the level at that frequency.

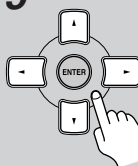

The volume at each frequency can be adjusted from -6 to +6 dB in 1 dB steps.

Tip: Low frequencies (e.g., 80 Hz) affect bass sounds; high frequencies (e.g., 8000 Hz) affect treble sounds.

6 Use the Up [▲] button to select “Channel,” and then use the Left and Right [◀]/[▶] buttons to select another speaker. Repeat steps 5 and 6 for each speaker.

7 Press the [SETUP] button. The setup menu closes.



Notes:

- When the listening mode is set to Direct or Pure Audio, no effect will be produced.
- This procedure can also be performed on the AV receiver by using its [SETUP] button, arrow buttons, and [ENTER] button.

Multichannel DVD Input Settings

1 Press the [RECEIVER] button followed by the [SETUP] button. The main menu appears onscreen.



2 Use the Up and Down [▲]/[▼] buttons to select “8. Hardware Setup,” and then press [ENTER].

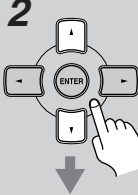

Use the Up and Down [▲]/[▼] buttons to select “SW Input Sensitivity,” and use the Left and Right [◀]/[▶] buttons to select a value.



3 Press the [SETUP] button. Setup closes.



SW Input Sensitivity

Some DVD players output the LFE channel from their subwoofer output at 15 dB higher than normal. You can change the subwoofer sensitivity to match your DVD player. Note that this setting only affects signals connected to the SUBWOOFER input jack of the multichannel DVD input.

You can select 0 dB, 5 dB, 10 dB, or 15 dB.

If you find that your subwoofer is too loud, try the 10 dB or 15 dB setting.

Audio Adjust Functions

Here you can set listening mode-related settings and functions.

1 Press the [RECEIVER] button followed by the [SETUP] button. The main menu appears onscreen.



2 Use the Up and Down [▲]/[▼] buttons to select “5. Audio Adjust,” and then press [ENTER]. The Audio Adjust menu appears.

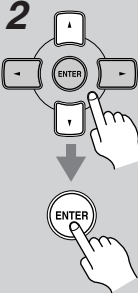

```

5.Audio Adjust
-----
a.Multiplex : Main 00
b.Mono Input Ch: L+R 00
c.PLIIx Panorama :Off00
d.PLIIx Dimension : 000
e.PLIIx Center Width:300
f.Neo:6 CenterImage:200
g.Dolby EX : Auto 00
h.T-D Listening Angle
: Wide 00
    
```

3 Use the Up and Down [▲]/[▼] buttons to select the settings, and use the Left and Right [◀]/[▶] buttons to set them. The settings are explained on page 73.

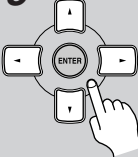

4 When you've finished, press the [SETUP] button. The setup menu closes.



Note:

This procedure can also be performed on the AV receiver by using its [SETUP] button, arrow buttons, and [ENTER] button.

Advanced Setup—Continued

The Audio Adjust functions are explained below.

Input Channel Settings

■ Multiplex

This setting determines which channel is output from a stereo multiplex source. Use it to select audio channels or languages with multiplex sources, multilingual TV broadcasts, and so on.

Main: The main channel is output (default).

Sub: The sub channel is output.

Main/Sub: Both the main and sub channels are output.

■ Mono Input Ch

This setting specifies the channel to be used for playing any 2-channel digital source such as Dolby Digital, or 2-channel analog/PCM source in the Mono listening mode.

L+R: Both the left and right channels are output (default).

Left: Only the left channel is output.

Right: Only the right channel is output.

PL IIx Music Mode Settings

These settings provide for playing any 2-channel digital source such as Dolby Digital, or 2-channel analog/PCM source in the PLIIx Music listening mode.

■ Panorama

With this function, you can broaden the width of the front stereo image when using the Pro Logic II Music or Pro Logic IIx Music listening mode.

On: Panorama function on.

Off: Panorama function off (default).

■ Dimension

With this setting, you can move the sound field forward or backward when using the Pro Logic II Music or Pro Logic IIx Music listening mode. It can be adjusted from -3 to +3 (default is 0). Lower settings move the sound field forward. Higher settings move it backward.

If the stereo image feels too wide, or there is too much surround sound, move the sound field forward to improve the balance. Conversely, if the stereo image feels like it is in mono, or there is not enough surround sound, move it backward.

■ Center Width

With this function, you can adjust the width of the sound from the center speaker when using the Pro Logic II Music or Pro Logic IIx Music listening mode. Normally if you are using a center speaker, the center channel sound is output by only the center speaker. (If you are not using a center speaker, the center channel sound will be distributed to the front left and right speakers to create a phantom center.) This setting controls the front left, right, and center mix, allowing you to adjust the weight of the center channel sound. It can be adjusted from 0 to 7 (default is 3).

Neo:6 Music Mode Setting

■ Center Image

The DTS Neo:6 Music listening mode creates 6-channel surround sound from 2-channel (stereo) sources. With this setting, you can specify by how much the front left and right channel output is attenuated in order to create the center channel. It can be adjusted from 0 to 5 (default is 2). This setting is unavailable if no surround speakers are connected.

When set to 0, the front left and right channel output is attenuated by half (-6 dB), giving the impression that the sound is located centrally. This setting works well when the listening position is considerably off center. When set to 5, the front left and right channels are not attenuated, maintaining the original stereo balance.

Dolby Digital EX Input Signal Setting

■ Dolby EX

This setting determines how Dolby Digital EX signals are handled. This setting is unavailable if no surround back speakers are connected.

Auto: If the source signal contains a Dolby Digital EX flag, the Dolby Digital EX listening mode is used (default).

Manual: You can select Pro Logic IIx Movie, Pro Logic IIx Music, Dolby Digital, Dolby Digital EX, or Dolby Digital+Neo:6.

T-D Listening Setting

■ Listening Angle

With this setting, you can specify the angle of the front left and right speakers relative to the listening position. Processing for the Theater-Dimensional listening mode is based on this setting. Ideally, the front left and right speakers should be equidistant from the listening position and at an angle close to one of the two available settings.

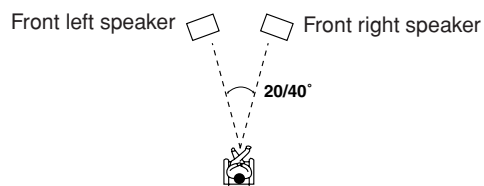

Narrow: Select if the listening angle is 20 degrees.

Wide: Select if the listening angle is 40 degrees (default).

Assigning Listening Modes to Input Sources

You can assign a default listening mode to each input source that will be selected automatically when you select each input source. For example, you can set the default listening mode to be used with Dolby Digital input signals. You can select other listening modes during playback, but the mode specified here will be resumed once the AV receiver has been set to Standby.

1

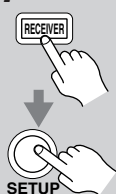

Press the [RECEIVER] button followed by the [SETUP] button.

The main menu appears onscreen.

2

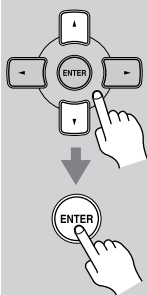

Use the Up and Down [▲]/[▼] buttons to select “6. Input Setup,” and then press [ENTER].

The Input Setup menu appears.

```

6. Input Setup
-----DVD/MCH-----
a. IntelliVolume: 0dB
Listening Mode Preset
b. Ana/PCM: Last Valid
c. Dolby D: Last Valid
d. DTS : Last Valid
e. D.F. 2ch: Last Valid
f. Mono : Last Valid
g. MCH Ana: Last Valid
    
```

3



Use the INPUT SELECTOR buttons on the remote controller to select the input source that you want to set.

For input selectors that have no digital input jacks, only “b. Analog” will be available.

4

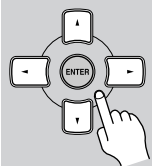

Use the Up and Down [▲]/[▼] buttons to select the signal format that you want to set, and then use the Left and Right [◀]/[▶] buttons to select a listening mode.

Only listening modes that can be used with each input signal format can be selected.

5



When you’ve finished, press the [SETUP] button.

The setup menu closes.

The Last Valid option means that the listening mode selected last will be used.

b. Ana/PCM: With this setting, you can specify the listening mode to be used when an analog (CD, TV, LD, VHS, MD, turntable, radio, cassette, cable, satellite, etc.) or PCM digital (CD, DVD, etc.) audio signal is played.

c. Dolby D: With this setting, you can specify the listening mode to be used when a Dolby Digital format digital audio signal is played (DVD, etc.).

d. DTS: With this setting, you can specify the listening mode to be used when a DTS format digital audio signal is played (DVD, LD, CD, etc.).

e. D.F. 2ch: With this setting, you can specify the listening mode to be used when a 2-channel (2/0) digital audio signal (Dolby Digital, DTS) is played (DVD, etc.).

f. Mono: With this setting, you can specify the listening mode to be used when a mono digital audio signal is played (DVD, etc.).

g. MCH Ana: This setting is available only when DVD or MULTI CH is selected with INPUT SELECTOR. With this setting, you can specify the listening mode to be used when the DVD analog multichannel input is used.

h. MCH PCM*: Specifies the default listening mode for multichannel PCM sources input via a HDMI IN, such as DVD-Audio.

i. PCM192k*: Specifies the default listening mode for high resolution 176.4 kHz and 192 kHz digital audio sources such as DVD-Audio.

*Only for inputs the HDMI IN jack is assigned to

Note:

This procedure can also be performed on the AV receiver by using its [SETUP] button, arrow buttons, and [ENTER] button.

IntelliVolume

You can set the input level for each input source. This is useful if some of your AV components are louder or quieter than others. IntelliVolume does not affect Zone 2. While this menu is shown onscreen, you can select each input source and set the levels while listening to and comparing them.

1 Press the [RECEIVER] button followed by the [SETUP] button.
The main menu appears onscreen.



2 Use the Up and Down [▲]/[▼] buttons to select “6. Input Setup,” and then press [ENTER].
The Input Setup menu appears.

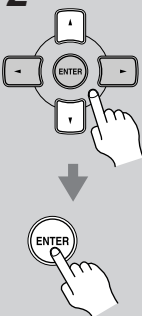

```

6. Input Setup
-----DVD/MCH-----
a. IntelliVolume: 0dB@@
Listening Mode Preset
b. Ana/PCM: Last Valid @@
c. Dolby D: Last Valid @@
d. DTS : Last Valid @@
e. D.F. 2ch: Last Valid @@
f. Mono : Last Valid @@
g. MCH Ana: Last Valid @@
    
```

3 Use the INPUT SELECTOR buttons on the remote controller to select the input source that you want to set.



4 Use the Up and Down [▲]/[▼] buttons to select “a. IntelliVolume.”
If a component is too loud compared to your other components, use the Left [◀] button to adjust the level. If it’s too quiet, use the Right [▶] button.

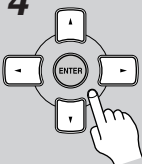

- The level can be set from -12 dB to +12 dB.

Volume Setup/OSD Setup

This section explains the items on the Miscellaneous Setup menu.

1 Press the [RECEIVER] button followed by the [SETUP] button.
The main menu appears onscreen.



2 Use the Up and Down [▲]/[▼] buttons to select “7. Miscellaneous Setup,” and then press [ENTER].
The Miscellaneous Setup menu appears.



```

7. Miscellaneous Setup
-----
a. MaximumVolume: Off @@
b. PowerOnVolume: Last@@
c. Immediate Display
    :Normal@@
    
```

3 Use the Up and Down [▲]/[▼] buttons to select the settings, and use the Left and Right [◀]/[▶] buttons to set them.
The settings are explained on page 76.

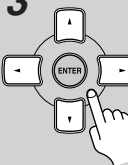

4 When you’ve finished, press the [SETUP] button.
The setup menu closes.



Note:

This procedure can also be performed on the AV receiver by using its [SETUP] button, arrow buttons, and [ENTER] button.

Maximum Volume

With this preference, you can prevent the volume being set too high by specifying a maximum volume level. The range is from 50 to 99. To specify no maximum volume, select Off.

Power On Volume

With this preference, you can specify the volume setting to be used each time the AV receiver is turned on. The range is MIN, 1 - 99, MAX. To use the same volume level that was used when the AV receiver was turned off, select Last.

The “Power On Volume” cannot be set higher than the “Maximum Volume” setting.

Immediate Display

This preference determines whether or not actions, such as selecting an input source, are displayed onscreen.

Normal: Select if your TV is 4:3.

Wide: Select if your TV is 16:9.

Off: Actions not displayed.

Even if this preference is set to Normal or Wide, actions are not displayed on the TV or projector while outputting the signals received at COMPONENT VIDEO IN or HDMI IN.

HDMI Audio Out

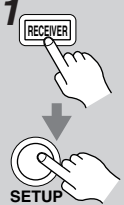
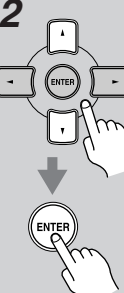
<p>1</p> 	<p>Press the [RECEIVER] button followed by the [SETUP] button. The main menu appears onscreen.</p>
<p>2</p> 	<p>Use the Up and Down [▲]/[▼] buttons to select “8. Hardware Setup,” and then press [ENTER].</p> <p>Use the Up and Down [▲]/[▼] buttons to select “HDMI Audio Out,” and use the Left and Right [◀]/[▶] buttons to select On or Off.</p>

This preference determines whether audio received at the HDMI IN is output by the HDMI OUT. You may want to turn this preference on if your TV is connected to the HDMI OUT and you want to listen to the audio from a component that’s connected to an HDMI IN, through your TV’s speakers. Normally, this should be set to Off.

Off: HDMI audio is not output (default).

On: HDMI audio is output.

With some TVs and input signals, no sound may be output even when this setting is set to On.

In these cases, set the connected device’s output to PCM.

Changing the AV Receiver’s ID

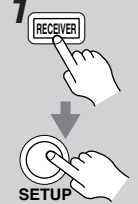
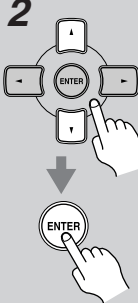
<p>1</p> 	<p>Press the [RECEIVER] button followed by the [SETUP] button. The main menu appears onscreen.</p>
<p>2</p> 	<p>Use the Up and Down [▲]/[▼] buttons to select “8. Hardware Setup,” and then press [ENTER].</p> <p>Use the Up and Down [▲]/[▼] buttons to select “Remote ID,” and use the Left and Right [◀]/[▶] buttons to select a value.</p>

Remote ID

With this setting, you can change the AV Receiver’s remote control ID. You may need to change this if the remote controller’s control codes overlap with those of another Onkyo component located in the same room.

- If you change the AV receiver’s remote control ID, be sure to set the same ID on both the AV receiver and remote controller (see page 78). The default ID for both is 1.

Lock Setup

1 Press the [RECEIVER] button followed by the [SETUP] button. The main menu appears onscreen.



2 Use the Up and Down [▲]/[▼] buttons to select “9. Lock Setup,” and then press [ENTER].



9. Lock Setup

a. Lock :Unlocked

With this preference, you can protect your settings by locking the setup menus.

When the setup menus are locked, you cannot change any setting.

Locked: Setup menus locked.

Unlocked: Setup menus not locked.

Digital Input Signal Formats

The digital input signal formats are available only for the digital input sources that you have assigned a digital input jack; otherwise you will see “Analog” indicated on the screen (see page 44).

Normally, the AV receiver detects the signal format automatically. However, if you experience either of the following issues when playing PCM or DTS material, you can manually set the signal format to PCM or DTS:

- If the beginnings of tracks from a PCM source are cut off, try setting the format to PCM.
- If noise is produced when fast forwarding or reversing a DTS CD, try setting the format to DTS.

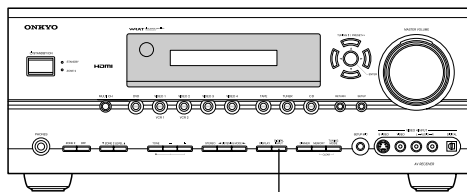





DIGITAL INPUT

- 1** Press and hold the AV receiver’s [DIGITAL INPUT] button for about 3 seconds.
- 2** While “Auto” is displayed (about 3 seconds), press the [DIGITAL INPUT] button again to select: PCM, DTS, or Auto.
- DTS or PCM:** The DTS or PCM indicator, depending on which format you have set, flashes, and only signals in that format are output. Digital signals in other formats are ignored.
- Auto (default):** The format is detected automatically. If no digital input signal is present, the corresponding analog input is used instead.

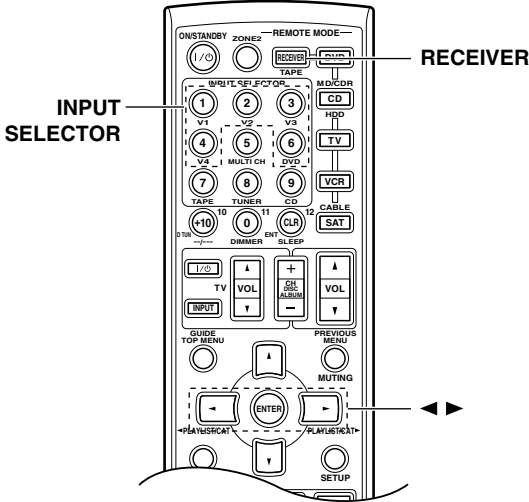
Correcting Sound and Picture Sync

When using progressive scanning on your DVD player, you may find that the picture and sound are out of sync. With this setting, you can correct this by delaying the audio signals. You can set it from 0 to 100 milliseconds (ms) in 10 millisecond steps.



1		Press the [RECEIVER] button.
2		<p>Press and hold, for more than 4 seconds, the input selector button for the input source that you want to correct.</p> <p>This can be the [DVD], [VIDEO 1], [VIDEO 2], [VIDEO 3] or [VIDEO 4] input source.</p>
3		<p>Use the Left and Right [◀]/[▶] buttons to adjust the delay from 0 to 100 milliseconds in 10 millisecond steps.</p> <div style="border: 1px solid black; padding: 5px; width: fit-content; margin: 10px auto;"> <p>A/V Sync # 20ms</p> </div>

Note:
This setting is not available when the Pure Audio listening mode is used, or the Direct listening mode is used with an analog input signal.

Changing the Remote Controller's ID

If several Onkyo components are used in the same room, the remote controller's control codes may overlap with those of another component. To differentiate the remote controller's control codes, you can change its ID to another number.

Note:
If you change the remote controller's ID, be sure to set the same ID on both the remote controller and AV receiver (see "Changing the AV Receiver's ID" on page 76). The default ID for both is 1.

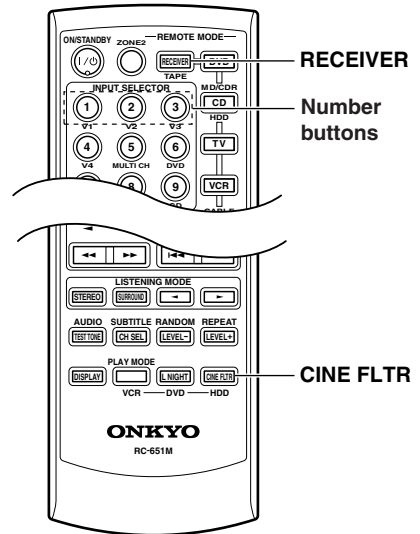

1	<p>Press the [RECEIVER] and the [CINE FLTR] at the same time.</p> <p>The [RECEIVER] button lights up.</p>
2	<p>Use the number buttons to enter a remote control ID.</p> <p>You can enter 1, 2, or 3.</p>

Zone 2

Connecting Zone 2

With the Zone 2 function, you can enjoy one input source in the main room and a different source in another room.

There are two connection methods: using a receiver/integrated amp in Zone 2 or using only a pair of speakers in Zone 2.

Using a Receiver/Integrated Amp in Zone 2

With this connection method, you can use 7.1 surround sound in the main room and play a different AV source in Zone 2. The volume for Zone 2 is set on the receiver/integrated amp.

- Use an RCA audio cable to connect the AV receiver's ZONE 2 LINE OUT L/R jacks to an analog audio input on your receiver/integrated amp.
- Connect the Zone 2 speakers to the speaker terminals on the receiver/integrated amp.

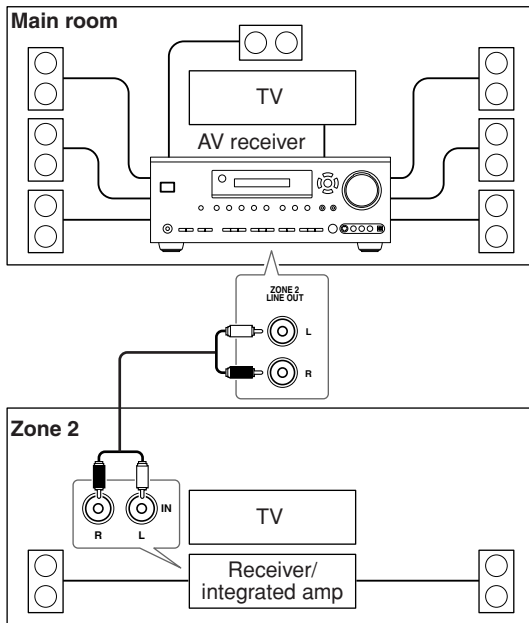

Using Only Speakers in Zone 2

With this connection method, you can use 5.1 surround sound in the main room and play a different AV source in Zone 2. The volume for Zone 2 is set on the AV receiver.

- Set the Powered Zone 2 setting to "Act" (see page 80).
- Connect your Zone 2 speakers to the AV receiver's ZONE 2 SPEAKERS terminals.

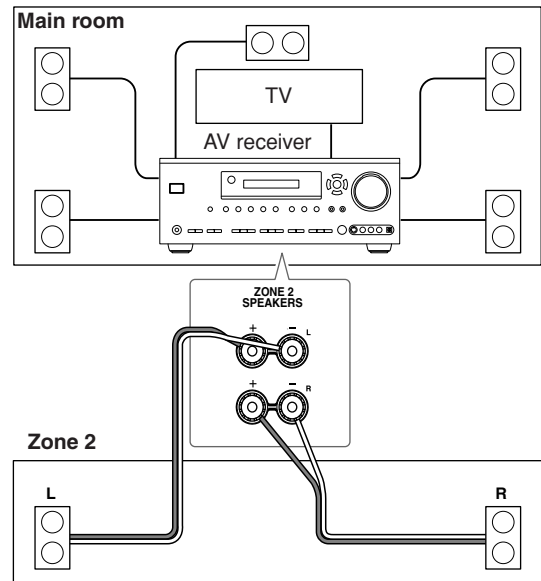

Setting the Powered Zone 2

To use Zone 2, you must make this setting. It enables the speakers connected to the ZONE 2 SPEAKERS terminals so that they produce sound when Zone 2 is used.

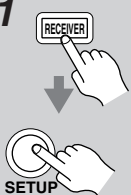
1  **Press the [RECEIVER] button followed by the [SETUP] button.**
The main menu appears onscreen.

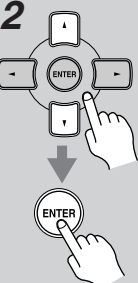
2  **Use the Up and Down [▲]/[▼] buttons to select “8. Hardware Setup,” and then press [ENTER].**
The Hardware Setup menu appears.

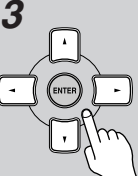
3  **Use the Up and Down [▲]/[▼] buttons to select “Powered Zone 2,” and use the Left and Right [◀]/[▶] buttons to select:**

```
8. Hardware Setup
-----
a.SP Impedance :6ohmsⓄ
b.PoweredZone2:NotActⓄ
c.TV Format    :AutoⓄ
d.AM Freq. Step: 9kHzⓄ
e.Remote ID   :1Ⓞ
f.HDMI Audio Out :OffⓄ
g.SW Input Sensitivity : 0dBⓄ
```

Not Act: ZONE 2 SPEAKERS terminals deactivated.

Act: ZONE 2 SPEAKERS terminals activated.

When Zone 2 is activated and turned on (see page 81), the speakers connected to the ZONE 2 SPEAKERS terminals output sound, but the speakers connected to the SURROUND BACK SPEAKERS terminals do not (when Zone 2 is activated but not used, the surround back speakers work as normal).

4  **Press the [SETUP] button.**
The setup menu closes.

Note:
This procedure can also be performed on the AV receiver by using its [SETUP] button, arrow buttons, and [ENTER] button.

Using Zone 2

This section explains how to turn Zone 2 on and off, how to select an input source for Zone 2, and how to adjust the volume for Zone 2.

Controlling Zone 2 from the AV receiver

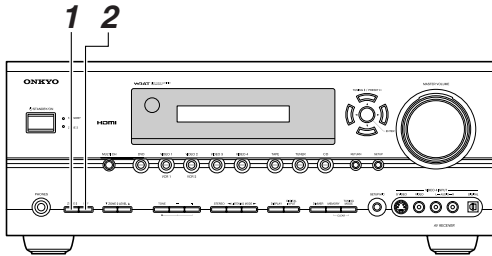

1



To turn on Zone 2 and select an input source, press the [ZONE 2] button repeatedly.

Alternatively, press the [ZONE 2] button followed by an input selector button within 8 seconds.

Zone 2 turns on, the ZONE 2 indicator lights up, and the ZONE 2 12V TRIGGER OUT goes high (+12 V).

To select AM, FM, or XM (North American models only), press the [TUNER] input selector button repeatedly.

To select the same source as that of the main room, press the [ZONE 2] button repeatedly until “Zone 2 Sel: Source” appears.

2

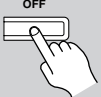

To turn off Zone 2, press the ZONE 2 [OFF] button.

Controlling Zone 2 with the Remote Controller

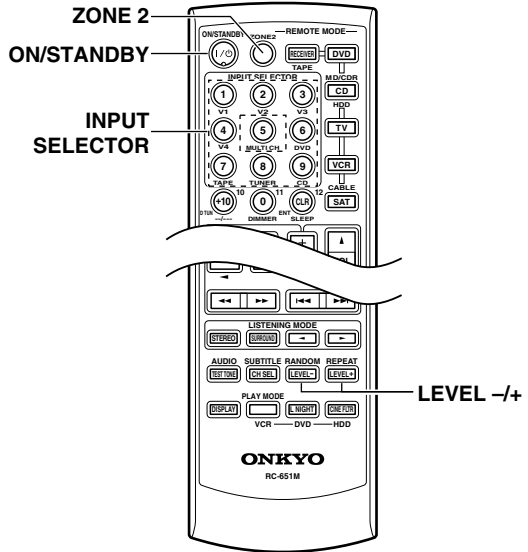

Note:

- To control Zone 2, you must press the remote controller's [ZONE 2] button first.

1



Press the [ZONE 2] button, then point the remote controller at the AV receiver and press the [ON/STANDBY] button.

Zone 2 turns on, and the ZONE 2 12V TRIGGER OUT goes high (+12 V).

2

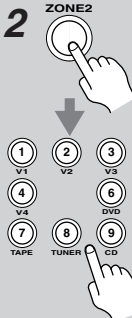

To select an input source for Zone 2, press the [ZONE 2] button, followed by an INPUT SELECTOR button.

To select AM, FM, or XM, press the [TUNER] INPUT SELECTOR button repeatedly.

3



To turn off Zone 2, press the [ZONE 2] button, followed by the [ON/STANDBY] button.

Adjusting the Volume for Zone 2

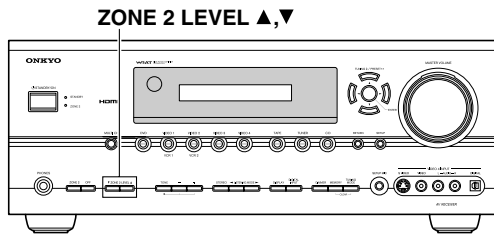

Remote controller
ZONE2

↓

AV receiver

On the remote controller, press the [ZONE 2] button, and then use the [LEVEL-] and [LEVEL+] buttons.

On the AV receiver, use the ZONE 2 LEVEL [▲]/[▼] buttons.

If your Zone 2 speakers are connected to an amp in Zone 2, use its volume control to adjust the volume.

To Mute Zone 2:

Press the remote controller's [ZONE 2] button, followed by the [MUTING] button. To unmute Zone 2, press the remote controller's [ZONE 2] button again, followed by the [MUTING] button, or adjust the volume for Zone 2.

Notes:

- Only analog input sources are output by the ZONE 2 LINE OUT and ZONE 2 SPEAKERS terminals. Digital input sources are not output. If no sound is heard when an input source is selected, check if it's connected to an analog input.
- While Zone 2 is being used, listening modes that need surround back speakers (i.e., Dolby Digital EX and DTS-ES) are unavailable.
- While Zone 2 is on, **RI** functions will not work.
- You can't select different radio stations for Zone 2 and the main room. For example, if you have an FM station for the main room, that station will also be used in Zone 2.

Using the Remote Control in Zone 2

To use the remote controller to control the AV receiver from Zone 2, you'll need one of the following commercially available multiroom remote control kits:

- Multiroom Kits are made by Niles and Xantech.
- These kits can also be used when the AV receiver is not in line of sight of the remote controller, for example, when it's installed inside a cabinet.

Using a Multiroom Kit with Zone 2

In the following diagram, an IR receiver picks up the infrared signals from the remote controller in Zone 2 and feeds them to the AV receiver in the main room via the connecting block.

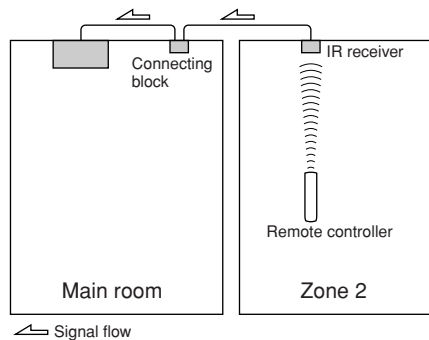

Connect the miniplug cable from the connecting block to the AV receiver's IR IN jack as shown below.

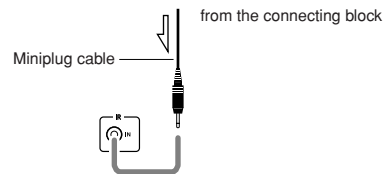

Using a Multiroom Kit with a Cabinet

In the following diagram, an IR receiver picks up the infrared signals from the remote controller and feeds them to the AV receiver in the cabinet via the connecting block.

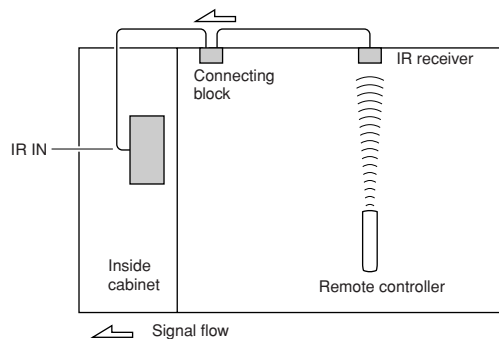

Controlling Other Components

You can use the AV receiver's remote controller (RC-651M) to control your other AV components, including those made by other manufacturers. This section explains how to enter the necessary remote control code for the component that you want to control (e.g., DVD player, TV, or VCR).

Entering Remote Control Codes

To control another component, you must first enter the appropriate remote control code to a REMOTE MODE button. You'll need to enter a code for each component that you want to control.

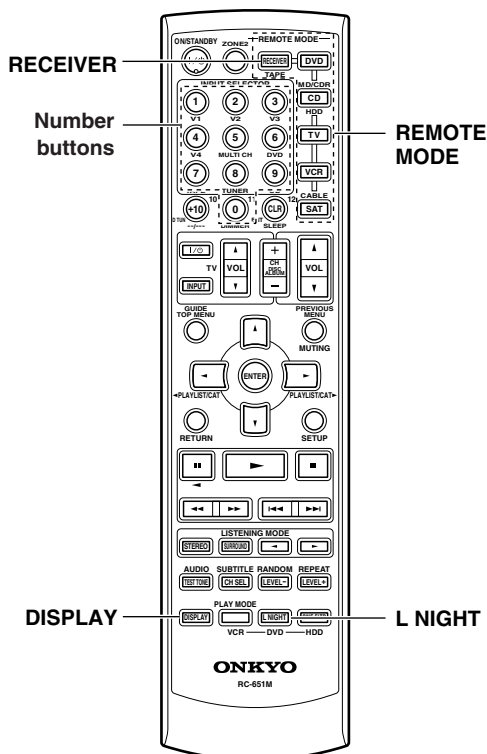

1

Look up the appropriate remote control code in the separate Remote Control Codes list.

The codes are organized by category (e.g., DVD player, TV, etc.).

2

—REMOTE MODE—

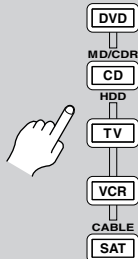

While holding down the REMOTE MODE button that you want to set, press the [DISPLAY] button for 3 seconds.

The REMOTE MODE button lights up.

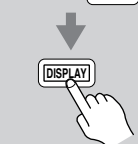

3



Within 30 seconds, use the number buttons to enter the 4-digit remote control code.

The REMOTE MODE button flashes twice.

4

Press the REMOTE MODE button again to select the remote controller mode, point the remote controller at the component, and check the operation.

If the remote controller doesn't work as expected, and several remote codes are listed, try each one in turn and use the one that works best.

Notes:

- A remote control code cannot be entered for the [RECEIVER] REMOTE MODE button.
- The remote control codes provided are correct at the time of printing, but are subject to change.

Remote Control Codes for Onkyo Components Connected via **RI**

Onkyo components that are connected via **RI** are controlled by pointing the remote controller at the AV receiver, not the component. This allows you to control components that are out of view, in a rack, for example.

- 1** Make sure the Onkyo component is connected with an **RI** cable and an analog audio cable (RCA).
See page 36 for details.
- 2** Enter the appropriate remote control code for the [DVD] or [CD] REMOTE MODE button.
[DVD] REMOTE MODE button
1612: Onkyo DVD player with **RI**
[CD/MD/CDR/HDD] REMOTE MODE button
1327: Onkyo CD player with **RI**
1808: Onkyo MD recorder with **RI**
1322: Onkyo CD recorder with **RI**
1993: HDD-compatible component with **RI**
See the previous page for how to enter remote control codes.
- 3** Press the [DVD] or [CD] REMOTE MODE button, point the remote controller at the AV receiver, and operate the component.

If you want to control an Onkyo component by pointing the remote controller directly at it, or you want to control an Onkyo component that's not connected via **RI**, use the following remote control codes:

- [DVD] REMOTE MODE button
0627: Onkyo DVD player without **RI** (default)
- [CD/MD/CDR/HDD] REMOTE MODE button
1817: Onkyo CD player without **RI** (default)
0868: Onkyo MD recorder without **RI**
1323: Onkyo CD recorder without **RI**
1990: HDD-compatible component without **RI**

Note:

If you connect an **RI**-capable Onkyo MD recorder, CD recorder, or HDD-compatible component to the TAPE IN/OUT or VIDEO 3 jacks, for remote operation to work properly, you must set the input display to MD, CDR, or HDD (see page 47).

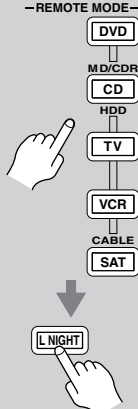
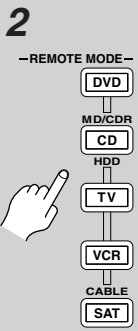

Resetting REMOTE MODE Buttons

You can reset a REMOTE MODE button to its default remote control code.

- 1** While holding down the REMOTE MODE button that you want to reset, press the [L NIGHT] button for 3 seconds.
The REMOTE MODE button lights up.

- 2** Press the REMOTE MODE button again.
The REMOTE MODE button flashes twice, indicating that it's been reset.
The [DVD] and [CD] REMOTE MODE buttons are preprogrammed with remote control codes for controlling Onkyo DVD players and CD players respectively. When these buttons are reset, the preprogrammed code is restored.

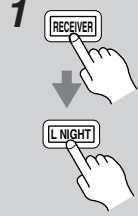
Resetting the Remote Controller

You can reset the remote controller to its default settings.

- 1** While holding down the [RECEIVER] REMOTE MODE button, press the [L NIGHT] button for 3 seconds.
The [RECEIVER] button lights up.

- 2** Press the [RECEIVER] REMOTE MODE button again.
The [RECEIVER] button flashes twice, indicating that it's been reset.

Controlling Other Components—Continued

To control another component, point the remote controller at it and use the buttons explained below. (You must select the appropriate remote control mode first.) With some AV components, certain buttons may not work as expected, and some may not work at all.

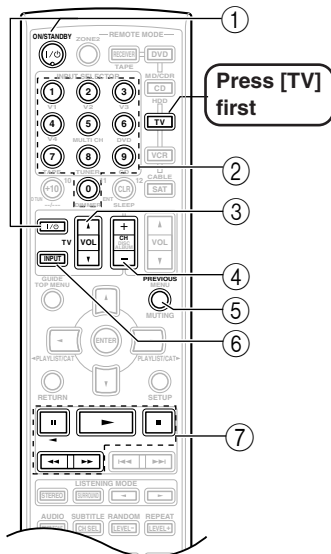
■ Controlling a TV



- ① **[ON/STANDBY], TV [⏻/⏻]***
Sets the TV to On or Standby.
- ② **Number buttons**
Enter numbers.
- ③ **TV VOL [▲]/[▼]***
Adjusts the TV's volume.
- ④ **[CH +/-]**
Selects channels on the TV.
- ⑤ **[PREVIOUS]**
Selects the previous channel.
- ⑥ **[TV INPUT]***
Selects the TV's VCR input.
- ⑦ **[⏮], [▶], [⏪], [⏩], [⏭]**
Operates the VCR.

* Buttons marked with an asterisk (*) are exclusively for controlling a TV and can be used at any-time regardless of the current remote controller mode.

■ Controlling a VCR

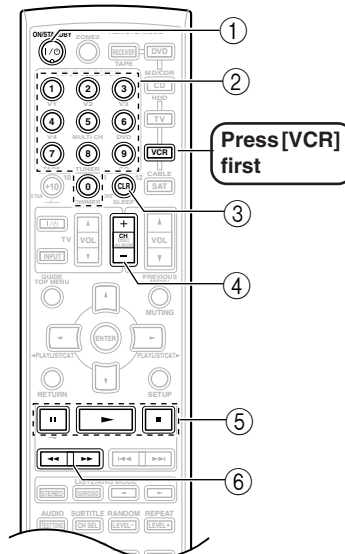

- ① **[ON/STANDBY]**
Sets the VCR to On or Standby.
- ② **Number buttons**
Select channels.
- ③ **[CLR]**
Cancels functions.
- ④ **[CH +/-]**
Selects channels on the VCR.
- ⑤ **[⏮], [▶], [⏪]**
Pause, Play, Stop.
- ⑥ **[⏮], [⏩]**
Rewind and Fast forward.

■ Controlling a Satellite or Cable Receiver

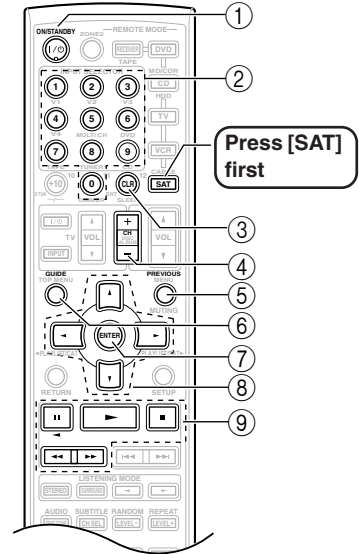

- ① **[ON/STANDBY]**
Sets the satellite/cable receiver to On or Standby.
- ② **Number buttons**
Enter numbers.
- ③ **[CLR]**
Cancels functions.
- ④ **[CH +/-]**
Selects satellite/cable channels.
- ⑤ **[PREVIOUS]**
Selects the previous channel.
- ⑥ **[GUIDE]**
Displays the program guide.
- ⑦ **[ENTER]**
Confirms the selection.
- ⑧ **[▲]/[▼]/[◀]/[▶]**
Selects menu items.
- ⑨ **[⏮], [▶], [⏪], [⏩], [⏭]**
Operates the VCR.

Specifications

Amplifier Section

Rated Output Power (FTC)
(TX-SR674/674E, TX-SR8467)

All channels: 95 watts minimum continuous power per channel, 8 ohm loads, 2 channels driven from 20 Hz to 20 kHz, with a maximum total harmonic distortion of 0.08%

115 watts minimum continuous power per channel, 6 ohm loads, 2 channels driven at 1 kHz, with a maximum total harmonic distortion of 0.1%

(TX-SR604/604E, TX-SR8460)

All channels: 90 watts minimum continuous power per channel, 8 ohm loads, 2 channels driven from 20 Hz to 20 kHz, with a maximum total harmonic distortion of 0.08%

110 watts minimum continuous power per channel, 8 ohm loads, 2 channels driven at 1 kHz, with a maximum total harmonic distortion of 0.9%

115 watts minimum continuous power per channel, 6 ohm loads, 2 channels driven at 1 kHz, with a maximum total harmonic distortion of 0.1%

Rated Output Power (IEC)

7 ch × 150 W at 6 ohms, 1 kHz, 1 ch driven

Maximum Output Power (JEITA)

7 ch × 185 W at 6 ohms, 1 kHz, 1 ch driven

Dynamic Power

225 W + 225 W (3 Ω, Front)
170 W + 170 W (4 Ω, Front)
105 W + 105 W (8 Ω, Front)

THD (Total Harmonic Distortion)

0.08% (Power Rated)

Damping Factor

60 (Front, 1 kHz, 8 Ω)

Input Sensitivity and Impedance

200 mV/47 kΩ (LINE)

Output Level and Impedance

200 mV/470 Ω (REC OUT)

Frequency Response

10 Hz - 100 kHz/+1 dB - 3 dB (Direct mode)

Tone Control

±10 dB, 50 Hz (BASS)
±10 dB, 20 kHz (TREBLE)

Signal to Noise Ratio

106 dB (LINE, IHF-A)

Speaker Impedance

North American: 6 Ω - 16 Ω
Others: 4 Ω - or 6 Ω - 16 Ω

Video Section

Input Sensitivity/Output

Level and Impedance 1 V_{p-p}/75 Ω (Component and S-Video Y)
0.7 V_{p-p}/75 Ω (Component Pb/Cb, Pr/Cr)
0.28 V_{p-p}/75 Ω (S-Video C)
1 V_{p-p}/75 Ω (Composite)

Component Video

Frequency Response 5 Hz - 50 MHz

Tuner Section

■ FM

Tuning Frequency Range North American: 87.5 MHz - 107.9 MHz
Others: 87.5 MHz - 108.0 MHz

Usable Sensitivity

Stereo: 22.2 dBf (75 Ω IHF)
Mono: 15.2 dBf (75 Ω IHF)

Signal to Noise Ratio

Stereo: 67 dB (IHF-A)
Mono: 73 dB (IHF-A)

THD

Stereo: 0.5% (1 kHz)
Mono: 0.3% (1 kHz)

Frequency Response

30 Hz - 15 kHz/±1 dB

Stereo Separation

40 dB (1 kHz)

■ AM

Tuning Frequency Range

North American: 530 kHz - 1710 kHz
European: 522 kHz - 1611 kHz
Others: 522/530 kHz - 1611/1710 kHz

Usable Sensitivity

300 μV/m

Signal to Noise Ratio

40 dB

THD

0.7%

General

Power Supply

North American: AC 120 V, 60 Hz
European: AC 230 - 240 V, 50 Hz
Others: AC 120/220 - 240 V, 50/60 Hz
AC 220 - 230 V, 50/60 Hz

Power Consumption

North American: 7 A
European: 630 W
Others: 630/670 W

Standby Power

Consumption

North American: 0.1 W
European: 0.3 W
Others: 0.5 W

Dimensions

(W × H × D)

435 × 174 × 377 mm
17-1/8" × 6-7/8" × 14-13/16"

Weight

11.4 kg
25.1 lbs.

■ Video Inputs

HDMI

IN1, IN2

Component

IN1, IN2, IN3

S-Video

DVD, VIDEO1, VIDEO2, VIDEO3, VIDEO4

Composite

DVD, VIDEO1, VIDEO2, VIDEO3, VIDEO4

■ Video Outputs

HDMI

OUT

Component

OUT

S-Video

MONITOR, VIDEO1, VIDEO2

Composite

MONITOR, VIDEO1, VIDEO2

■ Audio Inputs

Digital Inputs

Optical: 4 (1 on Front Panel)
Coaxial: 2

Analog Inputs

DVD (MULTICHANNEL), VIDEO1, VIDEO2, VIDEO3, VIDEO4, TAPE, CD

Multichannel Inputs

7.1

■ Audio Outputs

Digital Output

1

Analog Outputs

TAPE, VIDEO1, VIDEO2, ZONE2

Subwoofer Pre Output

1

Speaker Outputs

L, R, C, SL, SR, SBL, SBR, ZONE2 (L/R)

Phones

1

IR Input

1

12V Trigger Out

1 (ZONE2)

Specifications and features are subject to change without notice.

Troubleshooting

If you have any trouble using the AV receiver, look for a solution in this section. If you can't resolve the issue yourself, contact your Onkyo dealer.

If you can't resolve the issue yourself, try resetting the AV receiver before contacting your Onkyo dealer.

To reset the AV receiver to its factory defaults, turn it on and, while holding down the [VIDEO 1] button, press the [STANDBY/ON] button. "Clear" will appear on the display and the AV receiver will enter Standby mode.

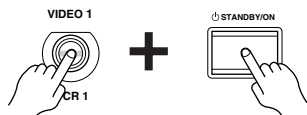

Note that resetting the AV receiver will delete your radio presets and custom settings.

Power

Can't turn on the AV receiver

- Make sure that the power cord is properly plugged into the wall outlet.
- Unplug the power cord from the wall outlet, wait five seconds or more, then plug it in again.

The AV receiver turns off as soon as it's turned on

- The amp protection circuit has been activated. Remove the power cord from the wall outlet immediately and contact your Onkyo dealer.

Audio

There's no sound, or it's very quiet

- Make sure that the digital input source is selected properly (page 44). Press the [DIGITAL INPUT] button repeatedly.
- Make sure that all audio connecting plugs are pushed in all the way (page 18).
- Make sure that the inputs and outputs of all components are connected properly (page 18).
- Make sure that the polarity of the speaker cables is correct, and that the bare wires are in contact with the metal part of each speaker terminal (page 20).
- Make sure that the input source is properly selected (page 49).
- Make sure that the speaker cables are not shorting.
- Check the volume. It can be set to MIN, 1 through 99, or MAX (page 49). The AV receiver is designed for home theater enjoyment. It has a wide volume range, allowing precise adjustment.
- If the MUTING indicator is shown on the display, press the remote controller's [MUTING] button to unmute the AV receiver (page 51).

- While a pair of headphones is connected to the PHONES jack, no sound is output by the speakers (page 51).
- If there's no sound from a DVD player connected to an HDMI IN, check the DVD player's output settings, and be sure to select a supported audio format.
- Check the digital audio output setting on the connected device. On some game consoles, such as those that support DVD, the default setting is off.
- With some DVD-Video discs, you need to select an audio output format from a menu.
- If your turntable doesn't have a built-in phono preamp, you must connect one between it and the AV receiver. If your turntable uses an MC cartridge, you must connect an MC head amp, or an MC transformer and phono equalizer.
- Make sure that none of the connecting cables are bent, twisted, or damaged.
- Not all listening modes use all speakers (page 63).
- Specify the speaker distances (page 69) and adjust the individual speaker levels (page 70).
- Make sure that the speaker setup microphone is not still connected.
- The input signal format is set to PCM or DTS. Set it to Auto (page 77).

Only the center speaker produces sound

- If you use the Pro Logic IIX Movie, Pro Logic IIX Music, or Pro Logic IIX Game listening mode with a mono source, such as an AM radio station or mono TV program, the sound is concentrated in the center speaker.
- Make sure the speakers are configured correctly (page 67).

The surround speakers produce no sound

- When the Stereo or Mono listening mode is selected, the surround speakers produce no sound (page 63).
- Depending on the source and current listening mode, not much sound may be produced by the surround speakers. Try selecting another listening mode.
- Make sure the speakers are configured correctly (page 67).

The center speaker produces no sound

- When the Mono or Stereo listening mode is selected, the center speaker produces no sound (page 63).
- Make sure the speakers are configured correctly (page 67).

The surround back speakers produce no sound

- The surround back speakers are not used with all listening modes. Select another listening mode (page 63).
- Not much sound may be produced by the surround back speakers with some sources.
- Make sure the speakers are configured correctly (page 67).

The subwoofer produces no sound

- When you play source material that contains no information in the LFE channel, the subwoofer produces no sound.
- Make sure the speakers are configured correctly (page 67).

There's no sound with a certain signal format

- Check the digital audio output setting on the connected device. On some game consoles, such as those that support DVD, the default setting is off.
- With some DVD-Video discs, you need to select an audio output format from a menu.
- Depending on the input signal, some listening modes cannot be selected (page 62).

Can't select the DTS-ES Discrete/Matrix listening modes

- These modes cannot be selected when no surround back speakers are connected, or the Zone 2 speakers are being used.
- You can not always select all of the listening modes, depending on the number of the speaker connected (page 62).

Can't get 6.1/7.1 playback

- If no surround back speakers are connected, or the Zone 2 speakers are being used, 6.1/7.1 playback is not possible.
- You can not always select all of the listening modes, depending on the number of the speakers connected (page 62).

The volume cannot be set to 99

- When the levels of all speakers have been calibrated (page 70), the maximum volume setting may change.

Noise can be heard

- Using cable ties to bundle audio cables with power cords, speaker cables, and so on may degrade the audio performance, so don't do it.
- An audio cable may be picking up interference. Try repositioning your cables.

The Late Night function doesn't work

- Make sure the source material is Dolby Digital (page 66).

The DVD analog multichannel input doesn't work

- Check the DVD analog multichannel input connections (page 26).
- To select the DVD analog multichannel input, press the [MULTI CH] input selector button.
- Check the audio output settings on your DVD player.

About DTS signals

- When DTS program material ends and the DTS bitstream stops, the AV receiver remains in DTS listening mode and the DTS indicator remains on. This is to prevent noise when you use the pause, fast forward, or fast reverse function on your player. If you switch your player from DTS to PCM, because the AV receiver does not switch formats immediately, you may not hear any sound, in which case you should stop your player for about three seconds, and then resume playback.
- With some CD and LD players, you won't be able to playback DTS material properly even though your player is connected to a digital input on the AV receiver. This is usually because the DTS bitstream has been processed (e.g., output level, sampling rate, or frequency response changed) and the AV receiver doesn't recognize it as a genuine DTS signal. In such cases, you may hear noise.
- When playing DTS program material, using the pause, fast forward, or fast reverse function on your player may produce a short audible noise. This is not a malfunction.

The beginning of audio received by an HDMI IN can't be heard

- Since it takes longer to identify the format of an HDMI signal than it does for other digital audio signals, audio output may not start immediately.

Video

There's no picture

- Make sure that all video connecting plugs are pushed in all the way (page 18).
- Make sure that each video component is properly connected.
- If your video component is connected to a component video input, your TV must be connected to the component video output (page 23) (TX-604/604E/8460 only).
- If a video component is connected to an HDMI input, your TV must be connected to the HDMI OUT.
- While the Pure Audio listening mode (not North American models) is selected, the video circuitry is turned off and only video signals input through HDMI IN can be output.

Troubleshooting—Continued

- On your TV, make sure that the video input to which the AV receiver is connected is selected.

There's no picture from a source connected to an HDMI IN

- If the message "Resolution Error" appears on the AV receiver's display, this indicates that the TV or display does not support the current video resolution and you need to select another resolution on your DVD player.

The onscreen menus don't appear

- The onscreen menus do not appear on a TV that's connected to the HDMI OUT (TX-SR604/604E/8460 only).
- Make sure that the video settings are correct (page 45).
- On your TV, make sure that the video input to which the AV receiver is connected is selected.

The immediate display does not appear

- The immediate display appears on a device connected to the COMPONENT VIDEO OUT, when the Component Video Setup (page 46) is set to "---."
- TX-SR604/604E/8460: The immediate display does not appear on a device connected to the HDMI OUT.
- TX-SR674/674E/8467: If both of the HDMI Video Setup (page 45) and the Component Video Setup (page 46) are set to "---," the immediate display is output to a device connected to the HDMI OUT.

Tuner

Reception is noisy, FM stereo reception is noisy, or the FM STEREO indicator doesn't appear

- Relocate your antenna.
- Move the AV receiver away from your TV or computer.
- Listen to the station in mono (page 52).
- When listening to an AM station, operating the remote controller may cause noise.
- Passing cars and airplanes can cause interference.
- Concrete walls weaken radio signals.
- If nothing improves the reception, install an outdoor antenna.

Remote Controller

The remote controller doesn't work

- Make sure that the batteries are installed with the correct polarity (page 12).
- Install new batteries. Don't mix different types of batteries, or old and new batteries (page 12).
- Make sure that the remote controller is not too far away from the AV receiver, and that there's no obstruction between the remote controller and the AV receiver's remote control sensor (page 12).

- Make sure that the AV receiver is not subjected to direct sunshine or inverter-type fluorescent lights. Relocate if necessary.
- If the AV receiver is installed in a rack or cabinet with colored-glass doors, the remote controller may not work reliably when the doors are closed.
- Make sure you've selected the correct remote controller mode (pages 13-16).
- When using the remote controller to control other manufacturers' AV components, some buttons may not work as expected.
- Make sure you've entered the correct remote control code.
- Make sure to set the same ID on both the AV receiver and remote controller (pages 76 and 78).

Can't control other components

- If it's an Onkyo component, make sure that the **RI** cable and analog audio cable are connected properly. Connecting only an **RI** cable won't work (page 36).
- Make sure you've selected the correct remote controller mode (pages 13-16).
- If you've connected an **RI**-capable Onkyo MD recorder, CD recorder, or next generation HDD-compatible component to the TAPE IN/OUT jacks, or a DS-A1 Remote Interactive Dock to the VIDEO 3 IN jacks, for the remote controller to work properly, you must set the display to MD, CDR, or HDD (pages 47 and 84).
- To control another manufacturer's component, point the remote controller at that component.
- To control an Onkyo component that's connected via **RI**, point the remote controller at the AV receiver. Be sure to enter the appropriate remote control code first (page 84).
- To control an Onkyo component that's not connected via **RI**, or another manufacturer's component, point the remote controller at the component. Be sure to enter the appropriate remote control code first (page 83).

Recording

Can't record

- On your recorder, make sure the correct input is selected (e.g., digital or analog).
- When the Pure Audio listening mode (not North American models) is selected, recording is not possible because no video signals are output. Select another listening mode.

Zone 2

There's no sound

- Only components connected to analog inputs can be played in Zone 2.

Others

The sound changes when I connect my headphones

- When a pair of headphones is connected, the listening mode is set to Stereo, unless it's already set to Stereo, Mono, Direct, or Pure Audio (not North American models).

The speaker volume cannot be set as required

- When the Automatic Speaker Setup function is used, or the volume is adjusted on the onscreen setup menus, the maximum possible volume setting may change.

The speaker distance cannot be set as required

- In some cases, corrected values suitable for home theater use may be set automatically.

The display doesn't work

- The display is turned off when the Pure Audio (not North American models) listening mode is selected.

How do I change the language of a multiplex source

- Use the "a. Multiplex" setting on the "Audio Adjust" menu to select Main or Sub (page 73).

The **RI** functions don't work

- To use **RI**, you must make an **RI** connection and an analog audio connection (RCA) between the component and AV receiver, even if they are connected digitally (page 36).

The functions Auto Power On/Standby and Direct Change don't work for components connected via **RI**

- These functions don't work when Zone 2 is turned on.

When performing "Automatic Speaker Setup," the measurement fails showing the message "Ambient noise is too high."

- This can be caused by any malfunction in your speaker unit. Check if the unit produces normal sounds.

The following settings can be made for the component video, S-Video, and composite video inputs

You must use the buttons on the unit to make these settings.

1. While holding down the input selector button for the input source that you want to set, press the [SETUP] button.
2. Use the Left and Right [◀]/[▶] buttons to change the setting.
3. Press the [SETUP] button when you've finished.

• Video Attenuation

This setting can be made for the DVD, VIDEO 1, VIDEO 2, VIDEO 3, or VIDEO 4 input.

If you have a games console connected to the component video, S-Video, or composite video input, and the picture isn't very clear, you can attenuate the gain.

Video ATT:0: (default).

Video ATT:2: Gain is reduced by 2 dB.

The AV receiver contains a microcomputer for signal processing and control functions. In very rare situations, severe interference, noise from an external source, or static electricity may cause it to lockup. In the unlikely event that this happens, unplug the power cord from the wall outlet, wait at least five seconds, and then plug it back in again.

Onkyo is not responsible for damages (such as CD rental fees) due to unsuccessful recordings caused by the unit's malfunction. Before you record important data, make sure that the material will be recorded correctly.

The AV receiver uses a battery-less memory backup system in order to retain radio presets and other settings when it's unplugged or in the case of a power failure. Although no batteries are required, the AV receiver must be plugged into an AC outlet in order to charge the backup system.

Before disconnecting the power cord from the wall outlet, set the AV receiver to Standby.

MEMO

ONKYO CORPORATION

Sales & Product Planning Div. : 2-1, Nisshin-cho, Neyagawa-shi, OSAKA 572-8540, JAPAN
Tel: 072-831-8023 Fax: 072-831-8124

ONKYO U.S.A. CORPORATION

18 Park Way, Upper Saddle River, N.J. 07458, U.S.A.
Tel: 201-785-2600 Fax: 201-785-2650 <http://www.us.onkyo.com/>

ONKYO EUROPE ELECTRONICS GmbH

Liegnitzerstrasse 6, 82194 Groebenzell, GERMANY
Tel: +49-8142-4401-0 Fax: +49-8142-4401-555 <http://www.eu.onkyo.com/>

ONKYO EUROPE UK Office

Suite 1, Gregories Court, Gregories Road, Beaconsfield, Buckinghamshire, HP9 1HQ
UNITED KINGDOM Tel: +44-(0)1494-681515 Fax: +44(0)-1494-680452

ONKYO CHINA LIMITED

Unit 1 & 12, 9/F, Ever Gain Plaza Tower 1, 88, Container Port Road, Kwai Chung,
N.T., Hong Kong Tel: 852-2429-3118 Fax: 852-2428-9039
<http://www.ch.onkyo.com/>



D0606-1

SN 29344223

(C) Copyright 2006 ONKYO CORPORATION Japan. All rights reserved.



* 2 9 3 4 4 2 2 3 *