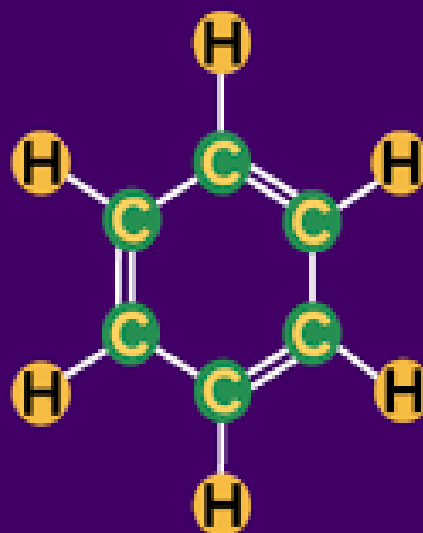
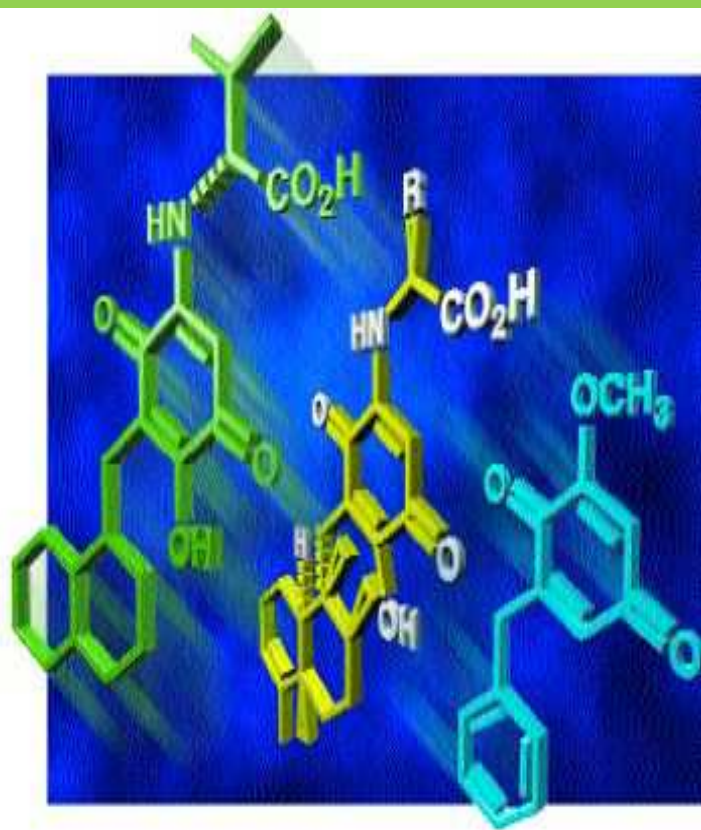




**BSCCH- 302**

**B.Sc. III YEAR  
ORGANIC CHEMISTRY-III**



**SCHOOL OF SCIENCES  
DEPARTMENT OF CHEMISTRY  
UTTARAKHAND OPEN UNIVERSITY**

**BSCCH-302**

---

# **ORGANIC CHEMISTRY III**

---



**SCHOOL OF SCIENCES  
DEPARTMENT OF CHEMISTRY  
UTTARAKHAND OPEN UNIVERSITY**

**Phone No. 05946-261122, 261123**

**Toll free No. 18001804025**

**Fax No. 05946-264232, E. mail [info@uou.ac.in](mailto:info@uou.ac.in)**

**<http://uou.ac.in>**

---

**Expert Committee****Prof. B.S.Saraswat**

Department of Chemistry  
Indira Gandhi National Open University  
Maidan Garhi, New Delhi

**Prof. A.K. Pant**

Department of Chemistry  
G.B.Pant Agriculture, University  
Pantnagar

**Prof. A. B. Melkani**

Department of Chemistry  
DSB Campus,  
Kumaun University, Nainital

**Prof. Diwan S Rawat**

Department of Chemistry  
Delhi University  
Delhi

**Dr. Hemant Kandpal**

Assistant Professor  
School of Health Science  
Uttarakhand Open University, Haldwani

**Dr. Charu Pant**

Academic Consultant  
Department of Chemistry  
Uttarakhand Open University,

---

**Board of Studies****Prof. A.B. Melkani**

Department of Chemistry  
DSB Campus, Kumaun University  
Nainital

**Prof. G.C. Shah**

Department of Chemistry  
SSJ Campus, Kumaun University  
Nainital

**Prof. R.D.Kaushik**

Department of Chemistry  
Gurukul Kangri Vishwavidyalaya  
Haridwar

**Prof. P.D.Pant**

Director I/C, School of Sciences  
Uttarakhand Open University  
Haldwani

**Dr. Shalini Singh**

Assistant Professor  
Department of Chemistry  
School of Sciences  
Uttarakhand Open University, Haldwani

**Dr. Charu Pant**

Academic Consultant  
Department of Chemistry  
School of Science  
Uttarakhand Open University,

---

**Programme Coordinator****Dr. Shalini Singh**

Assistant Professor  
Department of Chemistry  
Uttarakhand Open University  
Haldwani

---

<b>Unit Written By</b>	<b>Unit No.</b>
<b>Dr. Charu Pant</b> Department of Chemistry Uttarakhand Open University Haldwani	<b>01, 02 &amp; 03</b>
<b>Dr. Girdhar Joshi</b> Department of Chemistry P.G. College Gopeshwar	<b>04 &amp; 05</b>
<b>Dr. Bipin Chandra Joshi</b> Department of Chemistry LSM Govt. PG College Pithoragarh	<b>06 &amp; 09</b>
<b>Dr. Devendra Singh Dhama</b> Department of Chemistry SSJ Campus, Almora	<b>07 &amp; 08</b>
<b>Dr. Neelam Kumari</b> Department of Chemistry Meerut College, Meerut	<b>10, 11, 12 &amp; 13</b>

---

**Course Editor**

---

**Dr. Charu Pant**  
Academic Consultant  
Department of Chemistry  
School of Science  
Uttarakhand Open University

---

<b>Title</b>	<b>: Organic Chemistry III</b>
<b>ISBN No.</b>	<b>:</b>
<b>Copyright</b>	<b>: Uttarakhand Open University</b>
<b>Edition</b>	<b>: 2019</b>

**CONTENTS**

---

**Block-I NMR and Organometallic compounds**

Unit 1 NMR Spectroscopy	5-32
Unit 2 Organometallic Compounds	33- 43
Unit 3 Organosulphur Compounds	44-56

---

---

**Block -2 Heterocyclic Compounds**

Unit 4 Heterocyclic Compounds-I	57-96
Unit 5 Heterocyclic compounds II	97-125

---

---

**Block -3 Biomolecules-I**

Unit 6 Amino acids, Peptides, Proteins	126-163
Unit 7 Carbohydrates-I	164- 193
Unit 8 Carbohydrate- II	194-216
Unit 9 Lipids	217-243

---

---

**Block-4 Biomolecular-II**

Unit 10 Nucleic acids	244-261
Unit 11 Fats Oils and Detergents	262-277
Unit 12 Synthesis Dyes	278-296
Unit 13 Natural Products	297-331

---

---

## UNIT 1: NMR SPECTROSCOPY

---

### **CONTENTS:**

1.1 Objectives

1.2 Introduction

1.3 Proton magnetic resonance ( $^1\text{H}$  NMR) spectroscopy

1.3.1 Phenomena of energy absorption (Resonance & relaxation phenomena)

1.3.2 Nuclear shielding and deshielding

1.4 Chemically equivalent & Non-equivalent protons

1.5 Chemical shift

1.5.1 Chemical shift parameters

1.5.2 Internal standard for NMR spectroscopy

1.6 Spin-spin splitting and coupling constants

1.7 Area of signals

1.8 Applications of NMR Spectroscopy

1.9 Interpretation of PMR spectra of simple organic molecules e.g. Ethyl bromide, ethanol, acetaldehyde, 1, 1, 2-tribromoethane, ethyl acetate, toluene and acetophenone.

1.10 Problems pertaining to the structure elucidation of simple organic compounds using UV, IR and PMR spectroscopic techniques.

1.11 Summary

1.12 Terminal Question

1.13 Answers

---

### ***1.1. OBJECTIVES***

---

- Give a brief description of NMR, including what peaks represent, and what you can learn about a compound.
- Know how nuclear spins are affected by a magnetic field
- What happens when radiofrequency radiation is absorbed

- Use a list of common chemical shift ranges to predict the range of H's in various functional groups.
- Be able to predict the number of proton NMR signals expected from a compound given its structure.
- Be able to predict the splitting pattern in the proton NMR spectrum of a compound given its structure.
- Be able to use NMR spectra to determine the structures of compounds, given other information such as a molecular formula.
- Be able to calculate coupling constants from  $^1\text{H}$  NMR spectra, and utilize the coupling constants for determining compound structure.
- Be able to determine the compound structure based on information generated from mass spectrometry, IR, NMR, and elemental analysis.

---

## 1.2. INTRODUCTION

---

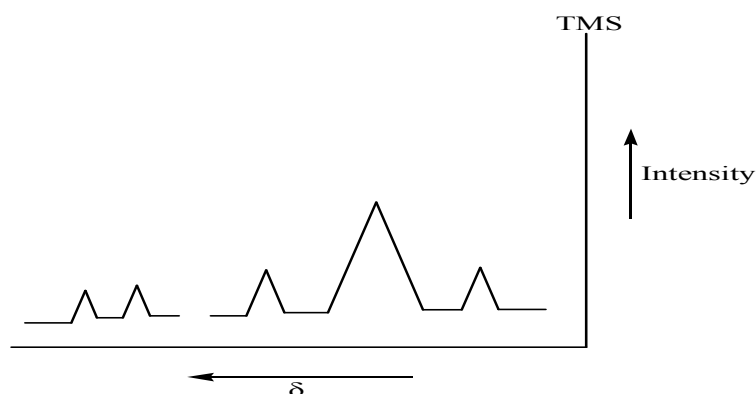
The concept of NMR was represented at first in 1946 by two groups of eminent physicist; Black Hensen and Packard at Stanford University detected a signal from the Protons of water and Parcell, Torrey and Pound at Harvard University observed a signal from the protons in Paraffin wax. Black and Parcell were jointly awarded a Nobel Prize for Physics in 1952 for this discovery.

NMR spectroscopy involves transition of a nucleus from one spin state to other with the resultant absorption of electromagnetic radiation by spin active nuclei (having nuclei spin not equal to zero) when they are placed in magnetic field. Nuclear magnetic resonance spectroscopy related to the nuclei and only one type of nucleus at a particular timeline.

$^1\text{H}$  or  $\text{C}^{13}$ ,  $\text{F}^{19}$  when the frequency of the rotating magnetic field and that of the processing nucleus (Larmor Frequency) become equal, they are said to be in resonance absorption or emission of energy by the nucleus can be obtained. Plot of the peak intensities versus the frequencies of objection (represented by  $\delta$  or  $\tau$ ) establish an NMR spectrum.

The  $^1\text{H}$  nucleus is most commonly studied by NMR spectroscopy because of its high natural abundance (99.98%) and the fact that it is present in the majority of organic compounds, the PMR or  $^1\text{H}$  NMR spectrum provides information about the number of different types of protons and also the chemical environment of each of them.

A simple representation of NMR spectrum can be given as:



*Figure: 1.1 A simple representation of NMR spectrum*

---

### **1.3. PROTON MAGNETIC RESONANCE ( $^1\text{H}$ NMR) SPECTROSCOPY**

---

$^1\text{H}$ NMR or PMR spectroscopy is the most widely applicable Nuclear Magnetic Resonance spectroscopy for the structural determination of various organic compounds but the other NMR spectroscopic methods like  $\text{C}^{13}$  and  $\text{P}^{31}$  NMR spectroscopy;  $\text{F}^{19}$  spectroscopy can also be helpful in the structural determination of the compounds.

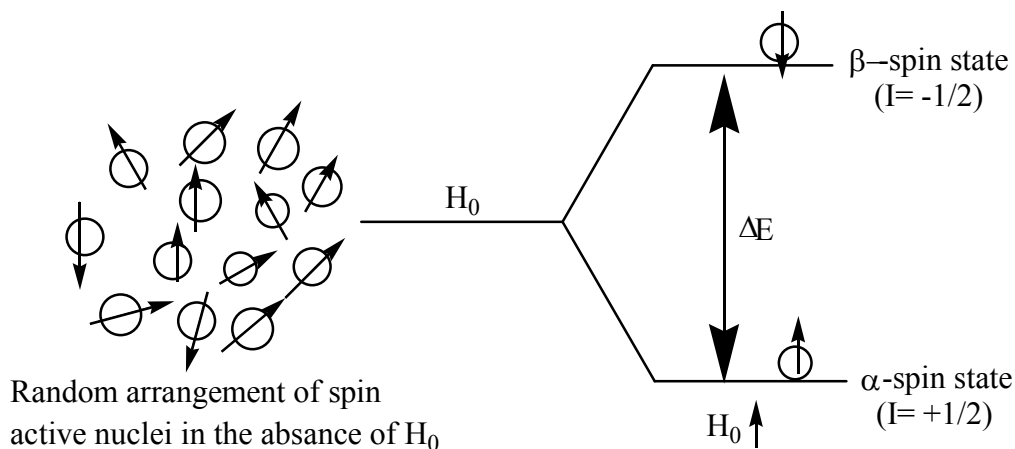
**Spin active nuclei:** All those nuclei which having the full integer or half integer nuclear spin value are known as spin active nuclei. With the help of the number of the electron/proton and neutron in the various nuclei, the spin active or inactive nature for them can be defined as:

$e^-/p$	Neutron (n)	Nuclear spin (I)	Nuclei	Examples
Even	Even	0	Inactive	$^8\text{O}^{16}$
Odd	Odd	Full integer	Active	$^7\text{N}^{14}$ , $^6\text{C}^{12}$
Even	Odd	Full integer	Active	$^6\text{C}^{13}$
Odd	Even	Half integer	Active	$^{15}\text{P}^{31}$ , $^1\text{H}^1$

#### **1.3.1. Phenomena of energy absorption (Resonance & relaxation phenomena):**

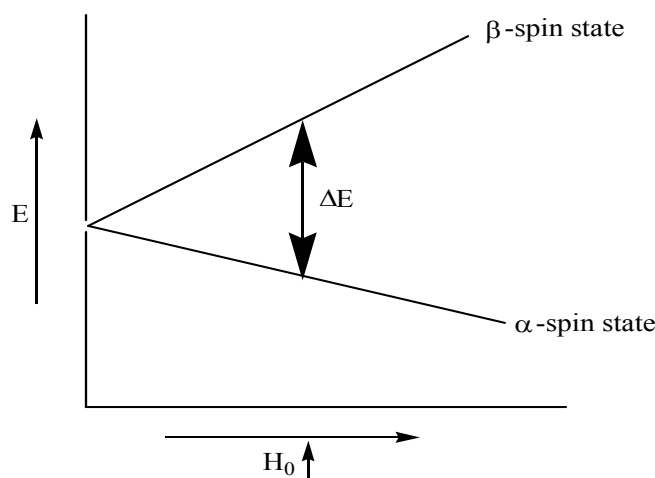


In the absence of external magnetic field  $H_0$  the nuclear spin are randomly oriented, However when the sample is placed in an external magnetic field then the nuclei (proton) with the spin  $+\frac{1}{2}$  are aligned with the applied field in that lower energy  $\alpha$ - spin stage and the nuclei with the spin  $-\frac{1}{2}$  are aligned against to the external magnetic field in the higher energy  $\beta$ - spin state that can be represented as:



**Figure 1.2.** Orientation of spinning nuclei in absence and presence of external magnetic field

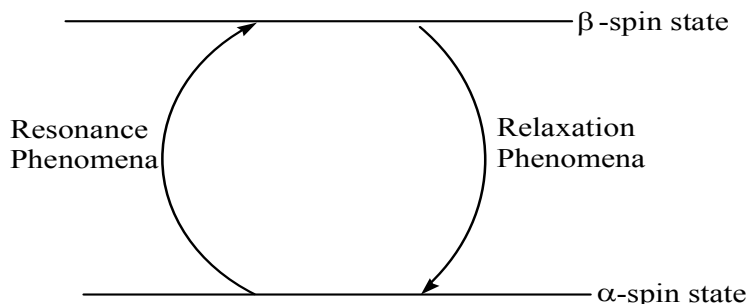
The value of energy difference b/w  $\alpha$  and  $\beta$  spin state depends on the strength of external magnetic field  $H_0$  according to the equation  $\Delta E = 2\mu h_0$  during the PMR spectroscopy, and then it can be represented as:



**Figure 1.3.** Energy states of nuclear spin

Thus according to above spin states **resonance phenomena** may be defined as the transition of spin active nuclei from  $\alpha$  spin state to the  $\beta$  - spin state by the absorption of Rf radiation while

the phenomena of returning the spin active nuclei from high energy  $\beta$ - spin state to the low energy  $\alpha$ -spin state is known as **relaxation phenomena**. Both the resonance and relaxation phenomena can be represented as:



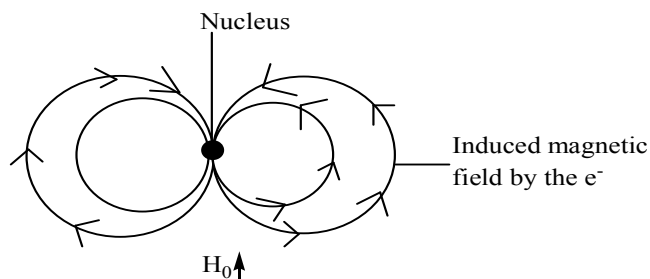
*Figure 1.4. Resonance and Relaxation*

---

## **1.4. NUCLEAR SHIELDING AND DESHIELDING**

---

Electron surrounding the spin active nuclei can also generate their own magnetic field which is called as induced magnetic field, that oppose the applied magnetic field in the region of the nucleus and these  $e^-$  which generate their induced magnetic field are known as diamagnetic  $e^-$  and this effect on the nucleus by these  $e^-$  is known as diamagnetic shielding.



*Figure 1.5. Shielding and deshielding of a nucleus*

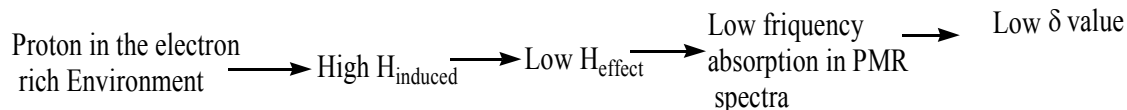
The external magnetic field is uniform over the entire molecule and therefore cannot differentiate to the different types of the proton. However the induced magnetic field generated by the  $e^-$  around the nucleus is not uniform, this situation makes the different spin active nuclei (proton) to be non-equivalent. Thus each proton in the different electronic environment show slightly different magnetic field due to the circulation of  $e^-$  in the neighboring bond.

Thus the effective magnetic field for the different spin active nuclei can be calculated through the following equations:

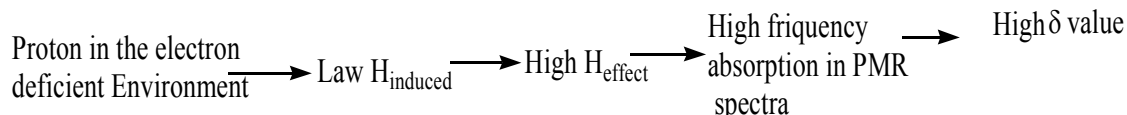
$$H_{\text{effect}} = H_0 - H_{\text{induced}}$$

Form the above equation the shielded and deshielded proton concept can be given as:

**(i) For shielding:**



**(ii) For deshielding:**



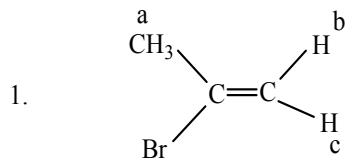

---

### ***1.5 CHEMICALLY EQUIVALENT & NON-EQUIVALENT PROTONS***

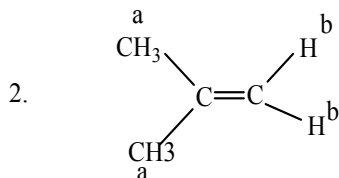
---

Those protons present in the sample of spin active nuclei which having same chemical environment are known as chemically equivalent protons. The entire chemically equivalent protons appear as a single signal in the PMR spectrum.

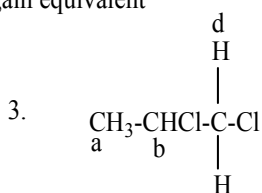
On the other hand those protons present in the sample of spin active nuclei which having different chemical environment are known as chemically non-equivalent proton. Chemically non-equivalent proton represents the different signal in the PMR spectrum.



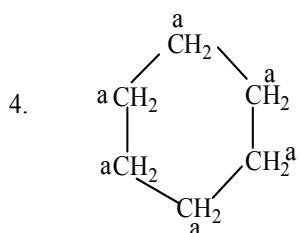
In a molecule reveals that three different types of protons, indicated by the letters a,b,c.



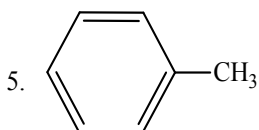
There are two types of protons. Six methyl protons on the LHS are equivalent. The protons on RHS are again equivalent



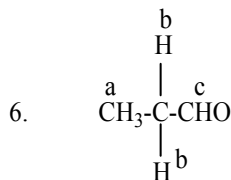
Protons marked c and d appear to be equivalent, but they are not actually so. Thus it has four types of protons.



In this case all the protons are equivalent giving rise to only one PMR signals



There are two types of protons, benzene ring protons and the methyl protons. Two signals will be observed.



There are three kinds of protons giving rise to three signals.

---

## 1.6 CHEMICAL SHIFT

---

Chemical shift it expresses the difference in the resonance frequency of a given proton compared to that of the methyl protons of TMS, under the experimental conditions. In practice,

this difference is divided by the operating radio-frequency of the instrument and the chemical shift ( $\delta$ ) is expressed, downfield from TMS, as per the given equation.

$$\text{chemical shift } \delta = \frac{V_s - V_{TMS} (\text{Hz})}{V_0 (\text{MHz})} \times 10^6$$

For example, if the observed shift from TMS is 200 Hz and the operating frequency of the instrument is 100 MHz, then the chemical shift  $\delta$  is given by the following expression:

$$\delta \frac{200 \text{ Hz}}{100 \times 10^6 \text{ Hz}} = 2.0 \times 10^{-6}$$

This frequency ratio ( $2.0 \times 10^{-6}$ ) is multiplied by  $10^6$  in order to obtain an easily handled number ( $2.0 \times 10^{-6} \times 10^6$  ppm) and consequently the chemical shift  $\delta$  is expressed as part per million ( $10^6$ ) of the operating frequency.

Thus,

$$\text{Chemical shift} = \frac{v_s - v_{TMS} (\text{Hz})}{\text{Operating frequency}} \times 10^6$$

### 1.6.1 Chemical shift parameters:

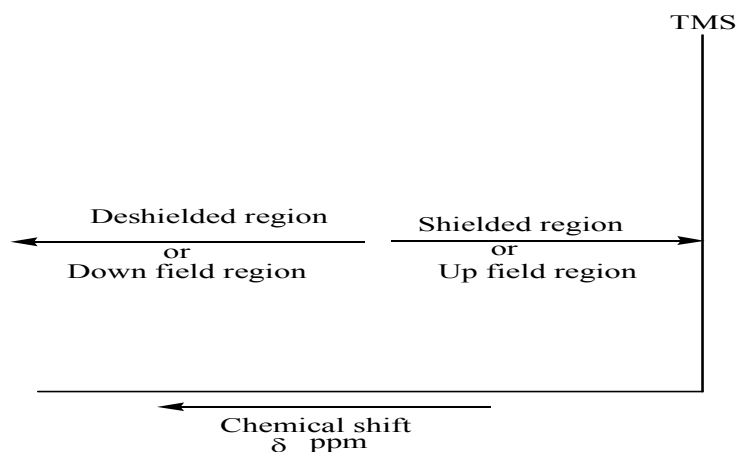
The usual scale, for PMR studies, is about 10 ppm while for  $^{13}\text{C}$ , the full range is over 200 ppm. The positions of various signals in an NMR spectrum are measured on  $\delta$  and  $\tau$  scale, relative to the resonance position of twelve equivalent protons of TMS, an arbitrary reference standard.

#### (i) Chemical shift measurement on $\delta$ scale:

The protons in the vast majority of organic compounds resonate at a low field than the protons of TMS. Therefore, by arbitrarily assigning TMS=0 it is possible to devise a scale, called  $\delta$  scale, in which the chemical shift values for most protons will have the same sign (+ve convenience).

#### (ii) Chemical shift measurement on $\tau$ scale:

$\tau$  Scale is an alternative chemical shift scale, in which TMS is given an arbitrary value of 10 ppm.



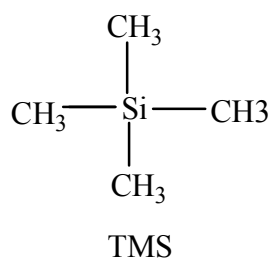
*Figure 1.6. Chemical shift region*

### 1.6.2 Internal standard for NMR spectroscopy:

That compound which is used as a reference standard to represent the NMR/PMR signal of the compounds is known as internal standard for the NMR or PMR spectroscopy.

In case of PMR spectroscopy Tetramethylsilane (TMS) used as a internal standard due to the following reasons:

- (i) Due to the more shielded nature of the proton of TMS in compare to the protons of most of the organic compound.
- (ii) It is chemically inert and miscible with large range of solvent.
- (iii) It does not take part in intermolecular association with the sample.
- (iv) Due to the volatile nature of TMS.



The internal standard for some other type of the NMR spectroscopic methods can be given as:

$\text{F}^{19}$  NMR –  $\text{CFCl}_3$

$\text{N}^{15}$  NMR –  $\text{NH}_4\text{NO}_3$

$\text{C}^{13}$  NMR – TMS

---

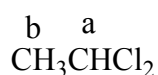
## 1.7 SPIN-SPIN SPLITTING AND COUPLING CONSTANTS

---

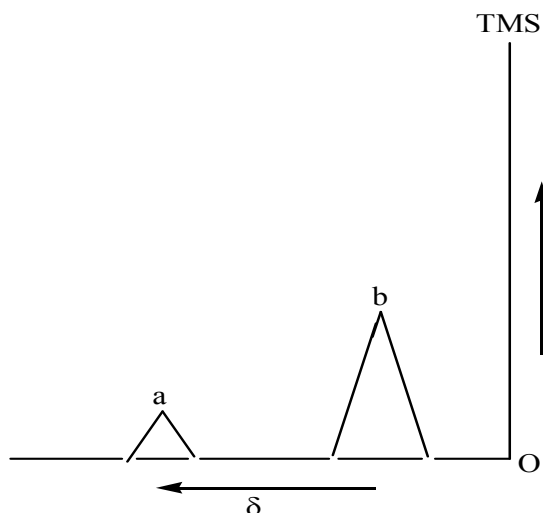
The coupling interaction between two or more protons, most often through the bond, results in splitting of the spectral lines. This is called spin-spin coupling. It is related to the possible combinations of the spin orientations of the neighboring protons.

The phenomena of splitting the signal of any particular type of proton by the spin orientation of the non-equivalent proton present adjacent to it is known as spin-spin coupling phenomena.

### Example:

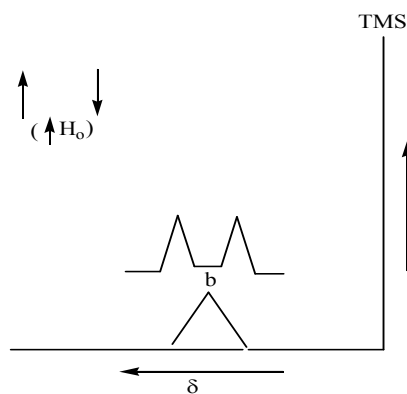


According to the NMR spectroscopy the signal of two different type of the proton present in this compound can be give as:

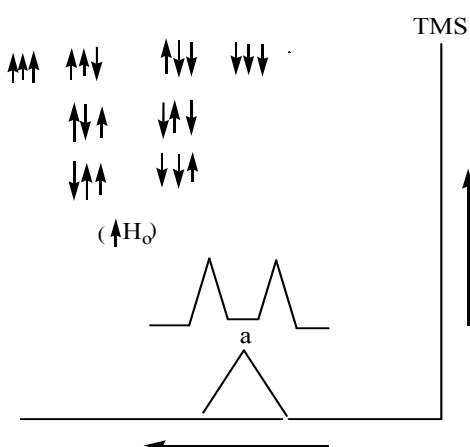


According to the spin-spin coupling phenomena the splitting of the signal of  $\text{H}^{\text{b}}$  proton &  $\text{H}^{\text{a}}$  proton according to the spin orientation of non-equivalent adjacent proton can be given as:

(i) Spin orientation of  $\text{H}^{\text{a}}$  for the splitting of the signal of  $\text{H}^{\text{b}}$  :



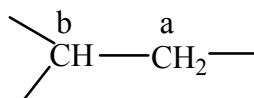
(ii) Spin orientation of  $H_b$  for the splitting of the signal of  $H_a$



### Coupling constant (J):

The distance between the centers of the two adjacent peaks in a multiplet is usually constant and is called the coupling constant. The value of coupling constant is independent of the external field. It is measured Hertz (Hz) or in cps (cycle per second). It is denoted by the letter J. In other words, we can say the value of J remains the same whatever the applied field. The value of J generally lies between 0 and 20 Hertz (Hz). Always the value of coupling constant being same for the protons which causing the splitting each other signal.

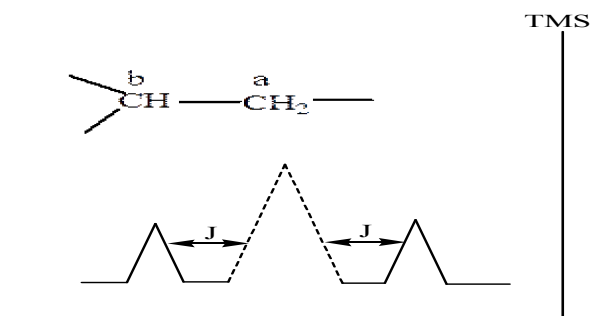
Now, let us consider a compound:



In this compound two signals are expected in the NMR spectrum. Under the influence of two equivalent proton a, the signal for proton b will appear as a triplet. The distance between any



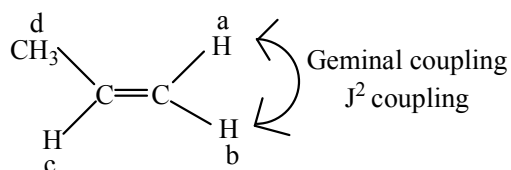
two adjacent peaks in a multiplet will be exactly the same. The spin-spin coupling is given below:



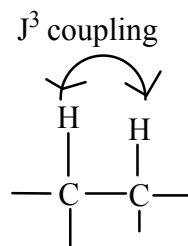
*Figure 1.7: spin-spin coupling*

It may be clearly noted that the value of coupling constant depends on the number of covalent bonds through which protons may interact and also upon the structural relationship between the coupled protons. Various types of the coupling may be given as:

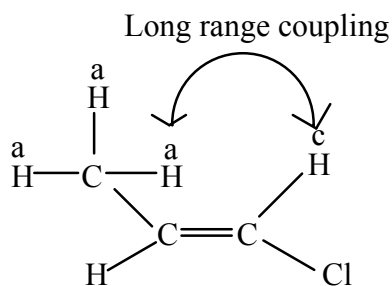
**(i) Geminal coupling:** Such type of the spin-spin coupling phenomena in which two chemically non-equivalent protons present at the same carbon atom causing the splitting of each other signal will be called as Geminal coupling or  $J^2$  coupling.



**(ii) Vicinal coupling-**Such type of the coupling phenomena in which two chemically non-equivalent protons present at the adjacent carbon atom causing the splitting of each other signal are known as vicinal coupling or  $J^3$  coupling.



**(iii) Long range coupling:** such type of the coupling phenomena in which two chemically non-equivalent protons causing the splitting of each other signal being separated by more than three covalent bonds are known as multi range/long range coupling. The probability of this type of the coupling phenomena in the organic compounds being very low.



## 1.8 AREA OF SIGNALS

In an NMR spectrum, various peaks represent equivalent sets of protons. The size or the area of each peak tells the number of protons in each set present in the compound under investigation. The area under an NMR signal is directly proportional to the number of protons giving rise to signal. For flipping over a proton, a quantum of energy is absorbed in the same effective magnetic field. Greater the number of protons that flip over at a particular frequency, greater will be the energy absorbed and greater is the area under the absorption peak. Squares under each peak are simply counted and from this, the ration between various kinds of protons is found out. These ratios are then converted into whole numbers. The whole numbers (or some multiple of them) tell the number of protons represented by the various NMR signals.

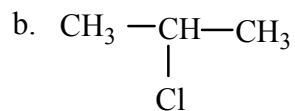
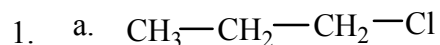
Let us consider the spectrum of toluene. It shows two types of protons as is clear from the two signals. If the number of squares under each signal are counted. It will be found that the areas under the two peaks have the ration 5:3. Thus, in toluene, five protons are of one kind and three protons are of another kind. Hence, we say that the NMR spectrum of toluene represents two kinds of protons which are in the ration 5:3.

- (i) Five proton signal (downfield due to deshielding) and
- (ii) Three protons signal (up field)

## 1.9 APPLICATIONS OF NMR SPECTROSCOPY

The NMR spectroscopy is very widely used for the identification of an unknown compound.

**1. Identification of structural isomers.** The distinction between the following isomers can be easily made from their NMR spectra:



In the isomer 'a' three signals are observed whereas we see only two signals in the spectrum for 'b' which is a clear distinction between the above isomers. The three signals for isomer 'a' in order of decreasing tau values are:

- (i) A three proton triplet
- (ii) A two proton sextet and
- (iii) A two proton triplet

For isomer (b), two signals have their multiplicities as:

- (i) Doublet (6H)-up field and
- (ii) Septet (1H)-downfield

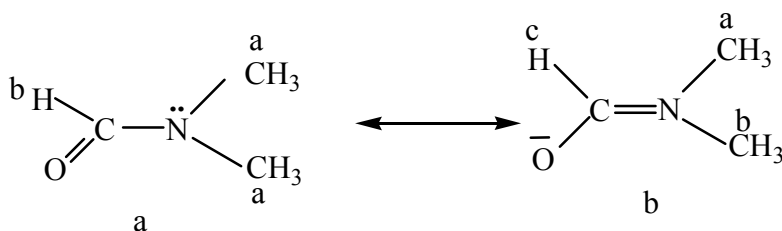
**2. Detection of hydrogen bonding:** Intermolecular hydrogen bonding shifts the absorption for a concerned proton downfield. The extent of hydrogen bonding varies with the nature of solvent, concentration of the solution and the temperature. The intramolecular hydrogen bonding also shifts the absorption downfield. The two types of hydrogen bonding can be distinguished as the intramolecular hydrogen bonding is not concentration dependant.

**3. Detection of aromaticity.** Protons attached to the benzoly, polynuclear and heterocyclic compounds whose  $\pi$  electrons follow Huckel's rule [i.e.  $(4n+2)$   $\pi$  electrons where  $n=1,2,3,\dots$ (whole numbers)] are extremely deshielded due to the circulating sextet (ring current) of  $\pi$  electrons. As a result of this, the signal for the aromatic protons appears at a very low field than that observed even for benzene. From this, the aromatic character of the compound under investigation can be predicted.

**4. Distinction between Cis-Trans Isomers and conformers.** The is and trans isomers of a compound can be easily distinguished as the concerned protons have different values of the chemical shift as well as the coupling constants. Similarly, the various conformation of a compound, the axial and equatorial positions of the proton or group carrying a proton can be distinguished from their different values of the coupling.

**5. Detection of electronegative atom or group:** It is known that the presence of an electronegative atom or group in the neighborhood of the proton cause deshielding and the signal is shifted downfield. Greater the electro negativity of the adjacent atom, smaller is the tau value of absorption for the concerned proton. Fluorine causes more downward shift as compared to oxygen and oxygen in turn causes more downward shift as compared to nitrogen and so on.

**6. Detection of some double bond character due to resonance:** In some compounds, the molecule acquires a little double bond character due to resonance. Due to this, two signals can be expected for apparently equivalent protons, It is due to the hindered rotation which changes the geometry of the molecules. Consider N, N- dimethyl formamide. It can be written in the following resonating structures:



For structure (a), two signals (singlets) should be expected with peak areas 6:1 as the two methyls are exactly equivalent.

In structure (b), the presence of double bond restricts rotation and now the two methyl groups remain no longer equivalent (Geometrical isomers). For this structure, two signals, appear for two methyl groups.

**7. Importance in quantitative analysis:** NMR spectroscopy is gaining importance for the quantitative analysis of the compounds. Equilibrium mixtures can be analyzed when the proton signals of the components are well separated. In the NMR spectrum of pure ethanol ( $\text{CH}_3\text{CH}_2\text{OH}$ ), a triplet is formed for the OH proton but when water is added in alcohol, then due to proton exchange, the triplet collapses to a singlet. The position of this singlet depends upon the water content in alcohol. From the values of the chemical shift, the ration of water and alcohol can be estimated by comparing with the known results.

---

## 1.10 INTERPRETATION OF PMR SPECTRA OF SIMPLE ORGANIC MOLECULES

---

NMR interpretation plays an important role in molecular identifications. As interpreting NMR spectra, the structure of an unknown compound, as well as known structures, can be assigned by several factors such as chemical shift, spin multiplicity, coupling constants, and integration. For the interpreting of the NMR spectra, the following points may be noted:

1. Molecular formula is determined by chemical analysis such as elementary analysis.
2. **Double-bond equivalent or Degree of Unsaturation:** It is calculated by a simple equation to estimate the number of the multiple bonds and rings. It assumes that oxygen (O) and sulfur (S) are ignored and halogen (Cl, Br) and nitrogen is replaced by CH. The resulting empirical formula is  $C_xH_y$

$$\text{Double Bond Equivalent (DBE)} = \frac{(2x + 2) - y}{2}$$

3. Structure fragmentation is determined by chemical shift, spin multiplicity, integral (peak area), and coupling constant (1J, 2J)
4. Molecular skeleton is built up using 2-dimensional NMR spectroscopy.
5. Relative configuration is predicted by coupling constant ( $^3J$ ).

### 1. Ethyl bromide ( $CH_3CH_2Br$ ):

In this compound (Ethyl bromide) containing two sets of equivalent protons 'a' and 'b' types. The signal due to equivalent protons a will be under the influence of neighboring proton b. Similarly, the signal for proton b will be under the influence of three equivalent protons a whose spin possibilities with respect to the applied field can be given as-

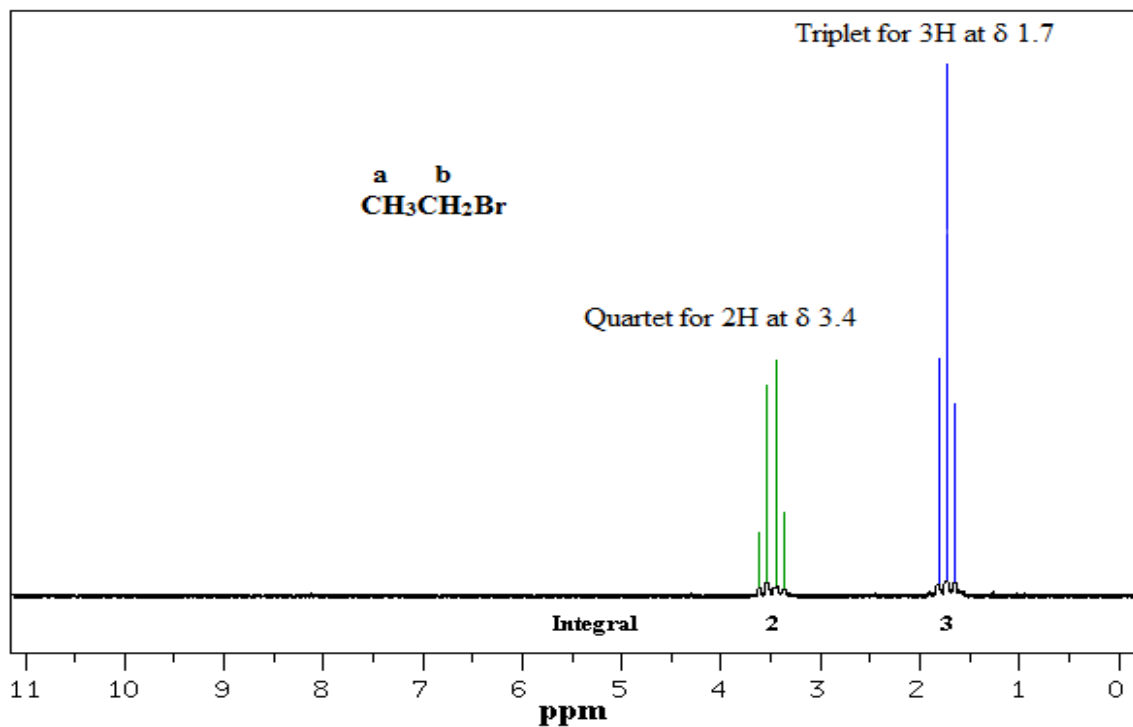


Figure 1.8: NMR Spectra of ethyl bromide

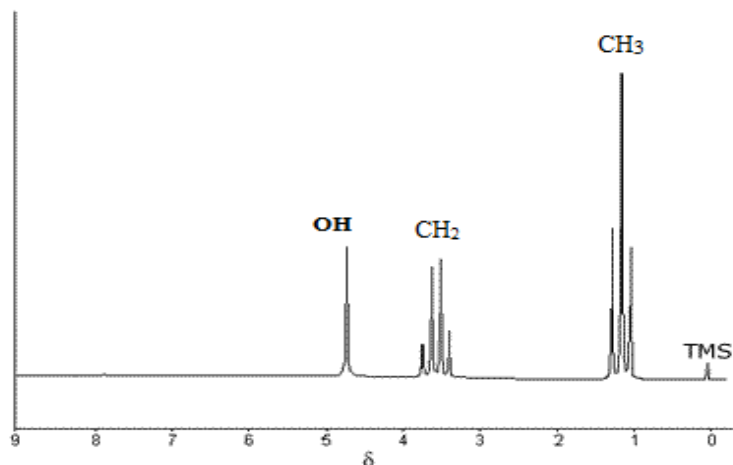
The following peaks can be identified in the spectrum

(a) Triplet,  $\delta$  1.7, 3H            (b) Quartet,  $\delta$  3.4, 2H

The proton at  $\delta$  1.7 is given by the three methyl protons which are magnetically equivalent and are coupled with the two methylene protons to give a shielding. While the quartet at  $\delta$  3.4 is from the two equivalent methylene protons which are coupled with the three methylene protons to produce a downfield quartet as a result of deshielding influence of bromine.

## 2. Interpretation of PMR spectra of ethanol:

The  $^1\text{H}$  NMR spectrum of ethanol (Figure 1.9) shows the methyl peak has been split into three peaks (triplet) and the methylene peak has been split into four peaks (quartet). This occurs because there is a small interaction between the two groups of protons. The space between the peaks of the methyl triplet is equal to the space between the peaks of the methylene quartet. This spacing is measured in Hertz and is called the coupling constant, J.

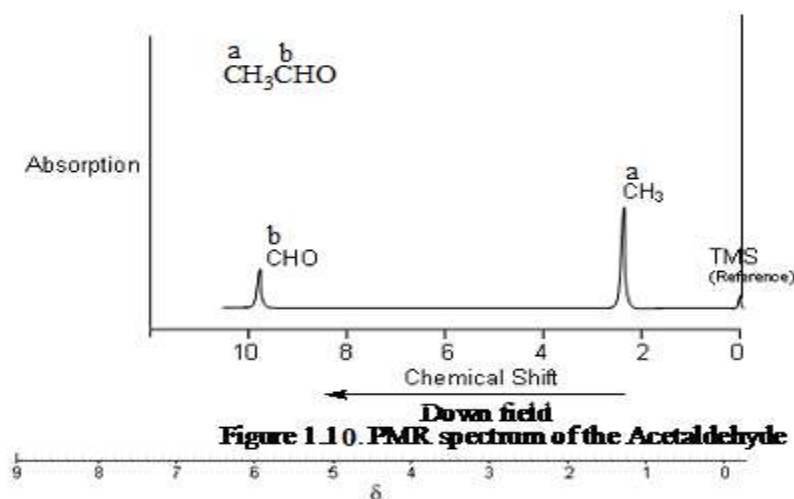


*Figure 1.9: PMR Spectrum of Ethyl alcohol*

In the above PMR spectrum of ethyl alcohol the following observation takes place:

1. A triplet centered at 1.18  $\delta$ , equivalent to 3H, represents the CH<sub>3</sub> (a) proton.
2. A singlet at 4.51  $\delta$ , equivalent to 1H, exhibit the OH (c) proton.
3. A quartet centered at 3.63  $\delta$ , equivalent to 2H indicates the CH<sub>2</sub> (b) proton.

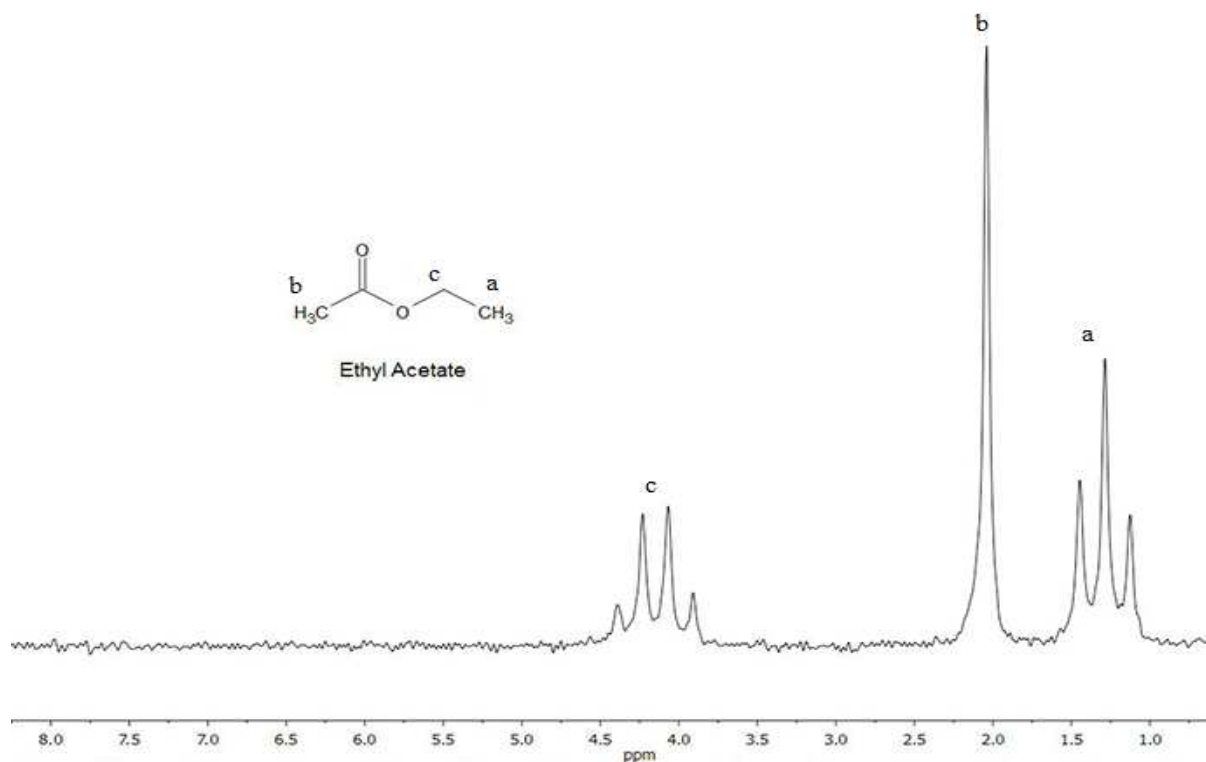
### 3. Interpretation of PMR spectra of Acetaldehyde:



1. A doublet centred at 2.14  $\delta$ , equivalent to 3H, represents the methyl proton (a).
2. A quartet, centred at 9.78, equivalent to 1H, indicates the aldehydic proton (b).

### 4. Interpretation of PMR spectra of Ethyl acetate:

The PMR spectrum of ethyl acetate is given in Figure 1.11. There are three different peaks in the spectrum. Two of the peaks are split or have multiplicities greater than one.



*Figure 1.11: PMR Spectrum of Ethyl acetate*

The following peaks are observed in the NMR spectrum of Ethyl acetate.

1. A triplet at 1.23  $\delta$  equivalent to 3H, indicate the methyl protons (a).
2. A singlet at 1.97  $\delta$ , equivalent to 3H indicates the methyl protons (b).
3. A quartet at 4.06  $\delta$ , equivalent to 2H, indicates the methylene protons (c).

#### **5. Interpretation of PMR spectra of Toluene:**



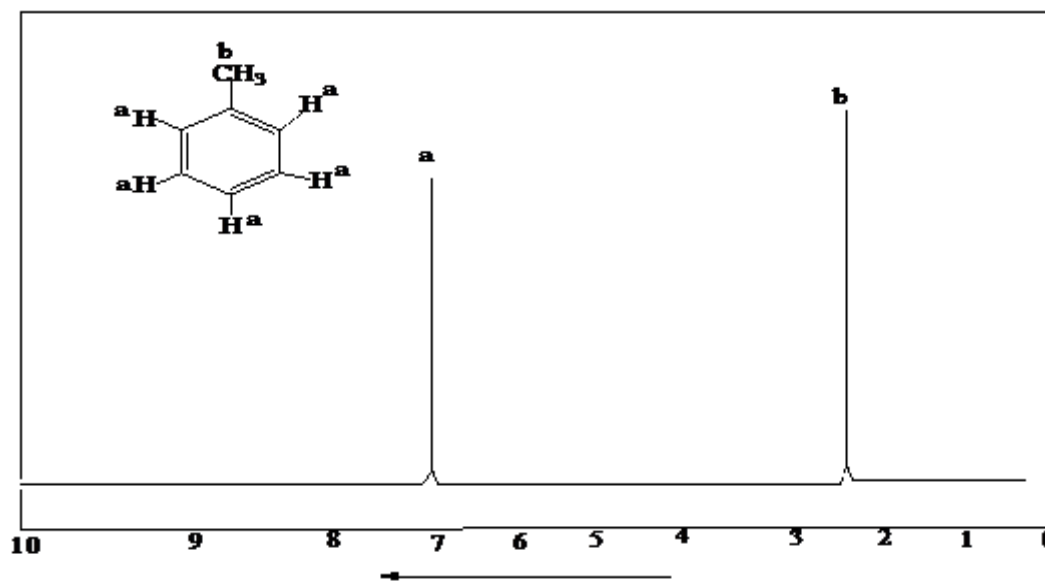


Figure 1.12 PMR spectrum of Toluene

The following peaks are observed in the NMR spectrum of toluene:

1. Singlet,  $\delta$  2.34, 3H
2. Singlet,  $\delta$  7.17, 5H

The compound toluene has eight protons, five of which are aromatic and remaining three from methyl group. The signals for three protons of methyl which are attached to an aromatic ring appear as a singlet at  $\delta$  2.34. All the five protons are chemically equivalent because they are unaffected by methyl protons. Hence these protons do not couple with each other and give rise to only one signal at  $\delta$  7.17.

---

### ***1.11. PROBLEMS PERTAINING TO THE STRUCTURE ELUCIDATION OF SIMPLE ORGANIC COMPOUNDS USING UV, IR AND PMR SPECTROSCOPIC TECHNIQUES***

---

#### **1.11.1. Determination of number of double bond and ring Equivalent (DBE) from the molecular formula of Organic compounds:**

The number of double number and ring equivalent (DBE) can be calculated if the molecular formula of the compound is known and thus the structure of the compounds may be calculated with the help of given spectroscopic data.

The DBE of the various organic compounds can be determined from the molecular formula as per given formula:

**a. Compounds containing carbon and Hydrogen only:**

If the compound is a hydrocarbon and the general formula is  $C_xH_y$  then:

$$DBE = x + 1 - \frac{y}{2}$$

For example: If the molecular formula of the compound is  $C_2H_6$ , then the DBE is given by-

$$DBE = 2 + 1 - \frac{6}{2} = 0$$

**b. If the compound containing carbon, hydrogen and divalent atoms:**

If the compound containing carbon, hydrogen and divalent atoms like Oxygen and Sulphur etc; then DBE may be calculated by given as:

$$DBE = x + 1 - \frac{y}{2}$$

For example: If the molecular formula of the compounds is  $C_3H_8O_3$ , then the DBE will be given as:

$$DBE = 3 + 1 - \frac{8}{2} = 0$$

**c. If compound containing carbon, hydrogen and monovalent atoms:**

If an Organic compound containing some monovalent atoms like (X= Cl, Br, I etc.),

Then the DBE can be calculated by given formula:

$$DBE = x + 1 - \frac{y + z}{2}$$

For example: If the molecular formula of the compound is  $C_{10}H_7Br$ , then the DBE is given by the following equation:

$$DBE = 10 + 1 - \frac{7 + 1}{2} = 11 - 4 = 7$$

**1.11.2. Problems pertaining to the structure elucidation of simple organic compounds:**

**Problem 1:**

An organic compound contains 66.6% carbon, 11.1% hydrogen. In UV, it gave a characteristic band at  $275 \text{ m}\mu$   $E_{\text{max}}$ . 17. In infra-red, bands are formed at 2941-2857(m), 1715 (s) and 1460  $\text{cm}^{-1}$ (m). In NMR, three signals appear at (i) 7.52  $\tau$  quartet, (2H), 7.88 $\tau$  singlet, (3H) and 8.93  $\tau$  Triplet, (3H). Determine the structural formula of the compound.

**Solution:**

The compound contains

$$\text{C} = 66.6\%$$

$$\text{H} = 11.1\%$$

$$\text{O} = 100 - (66.6 + 11.1) = 22.3\%$$

From the above data, the empirical formula of the compound is found to be  $\text{C}_4\text{H}_8\text{O}$ . This must be the molecular formula since eight hydrogen atoms are shown by NMR spectrum.

(i) The absorption at  $275 \text{ m}\mu$   $E_{\text{max}}$ . 17 is characteristic of a carbonyl group.

(ii) The absorption at 2941-2857  $\text{cm}^{-1}$  (m) in the IR spectrum is due to C-H stretching, at 1715  $\text{cm}^{-1}$  (s) is characteristic of saturated ketonic group and that at 1460  $\text{cm}^{-1}$  (s) is characteristic of saturated ketonic group and that at 1460  $\text{cm}^{-1}$  (m) may be due to bonding.

(iii) The NMR spectrum reveals three kinds of protons.

The presence of a triplet at 8.93  $\tau$  and a quartet at 7.25 $\tau$  is characteristic of  $\text{CH}_3\text{-CH}_2\text{-}$  group in the compound. The singlet at 7.88  $\tau$  is due to methyl group adjacent to a carbonyl group.

Thus the molecular formula of the compounds is  $\text{CH}_3\text{-CH}_2\text{-CO-CH}_3$ .

**Problem 2.**

A compound with molecular weight 116 gave the following data.

(I) UV: 283 22.

(II) IR: 3000-2500(b), 1715(s), 1342  $\text{cm}^{-1}$ (w).

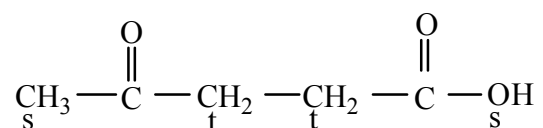
(III) NMR: 7.88 $\tau$  singlet (3H), 7.40 $\tau$  Triplet (2H), 7.75  $\tau$  Triplet (2H) and -1.1  $\tau$  singlet (1H). Find the structural formula of the compound.

**Solution:** In the ultraviolet spectrum, the absorption at 283 m $\mu$  indicates the presence of carbonyl group.

The presence of an acid group is also shown by NMR which gives a signal (singlet) at the negative tau value. Thus, the compound under investigation contains

- (i) -CO- Group and
- (ii) -COOH- Group

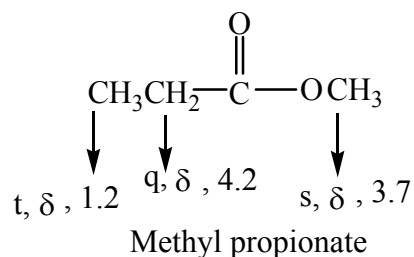
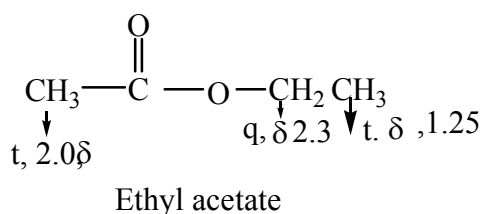
Further two triplets result at 7.4  $\tau$  and 7.75  $\tau$  having the same integral area. It must be due to clearly, two methylene groups must be under different environments and thus, couple to give rise to two triplets. The three protons singlet at 7.88  $\tau$  must be a methyl group attached with the carbonyl group. Thus the structure of the compound is-



### Problem 3.

Ethyl acetate and methyl propionate both have the molecular formula C<sub>4</sub>H<sub>8</sub>O<sub>2</sub>. How do they differ in their PMR spectra?

**Solution:** (Ethyl acetate) shows downfield singlet at  $\delta$  2.0 due to methyl group of acetate part, methylene quartet at  $\delta$  2.3 and methyl triplet at  $\delta$  1.25 due to ethyl group attached to oxygen. While (methyl propionate) shows a methylene quartet at  $\delta$  4.2 and a methyl triplet at  $\delta$  1.2 due to group of propionate part; downfield methyl singlet at  $\delta$  3.7 due to methyl group attached to oxygen.



### Problem 4:

Carbonyl compound containing carbon, hydrogen and oxygen and having a molecular mass of 72 gives a PMR spectrum which shows a triplet, a singlet and a quartet (at increasing values of  $\delta$ ). What is the structure of the compound?

**Solution:** The possible structure of the given data is:



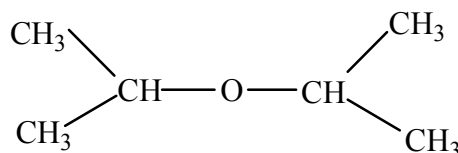
A compound **Problem 5:**

having the percentage composition C = 70.6%, H=13.7% and O =15.7% exhibits the following PMR spectrum:

Multiplet at  $\delta$ , 3.56 (2H); Doublet at  $\delta$ , 1.05 (12H).

Determine its molecular formula and assign a suitable structure to it.

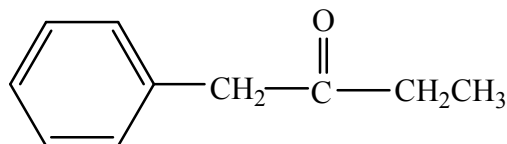
**Solution:** The molecular formula of the compound with the above percentage composition comes out to be  $\text{C}_6\text{H}_{14}\text{O}$ . The structure of the compound is given below:



**Problem 5:**

PMR spectrum of a compound shows the following peaks:  $\delta$  7.22 (s, 5H);  $\delta$  2.77 (q, 2H);  $\delta$  0.97 (t, 3H). Give the structure with the above data:

**Solution:** On the basis of the above spectral data, the structure of the compound is:

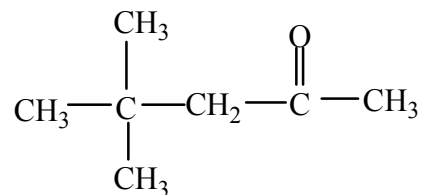


**Problem 6:**

A carbonyl compound having the molecular formula gives the following PMR spectrum. Identify the compound.  $\delta$  1.01 (Singlet, 9H);  $\delta$  2.32 (Singlet, 2H);  $\delta$  2.11 (Singlet, 3H).

**Solution:**

The structure of the compound with the formula is:



### Problem 7:

How can you explain the following difference in the chemical shifts of aromatic protons in the following compounds?

Benzene  $\delta$  7.37, Toluene  $\delta$  7.14, p-xylene 7.05

**Solution.** The chemical shifts of aromatic protons in toluene and p-xylene are slightly upfield due to electron releasing and shielding effect of methyl groups.

## 1.12. SUMMARY

Nuclear magnetic resonance spectroscopy, commonly known as **NMR** spectroscopy, it is an analytical technique that exploits the magnetic properties of certain atomic nuclei. This type of spectroscopy determines the physical and chemical properties of atoms or molecules. It relies on the phenomenon of nuclear magnetic resonance and can provide the information about the structure, chemical environment of molecules and details of the electronic structure of a molecule and its functional groups present in the sample.

NMR spectra are unique analytical tool and often highly predictable for small molecules. Thus, in organic chemistry practice, NMR analysis is used to confirm the identity of a substance.

## 1.13 REVIEW QUESTIONS

### A. Short Answer Type Questions:

- Describe briefly the theory of NMR spectrometry.
- What do you understand by the positions of the signals in an nmr spectrum? How many signals are expected in each of the following compounds? (a) propane (b) isobutance (c) Ethanol (d) Cyclobutance (e) Ethylmethly ether
- What do you mean by the term chemical shift?
- Write with suitable examples, the shielding and the deshielding.

5. Describe with suitable examples the various effect the magnitude of the chemical shift.
6. Define the term chemical shift and describe the factors which affect it.
7. Explain the term 'spin-spin' coupling. Why does a peak for a particular set of protons split into a multiplet? Give with examples.
8. Write a short note on the use of standard solvents in the NMR spectrometry.
9. An Organic compound has a molecular formula at  $C_{10}H_{13}Cl$  assign its structure with the help of the following data:

Singlet  $\delta$  1.57, 6H

Singlet 3.07  $\delta$  2H

Singlet 7.27  $\delta$  5H

Describe briefly the various applications the NMR spectroscopy.

10. Write a detailed note on coupling constant.
11. An Organic compound with molecular formula formula  $C_6H_5NO_3$  is found to show two signals in the PMR spectrum.
12. (i) Unsymmetrical patten-multiplet = 1.8-2.9 $\tau$ (4H)
13. (ii) Singlet = 0.1  $\tau$  (1H)
14. What is meant by the term chemical shift? Give the various factors which affect the value of chemical shift.
15. Name some important solvents used in NMR spectroscopy. What are the important characteristics of the solvents used in the technique?
16. Write brief notes on the following:
  - (i) Chemical shift
  - (ii) Spin-spin coupling
  - (iii) Coupling constant
  - (iv) Resonance Phenomenon
18. Write short notes on:
  - (i) Spin-Spin coupling
  - (ii) Areas of the various signals
  - (iii) Deshielding due to hydrogen bonding
19. Explain the term PMR spectrum of ethyl bromide.

20. Explain the term PMR spectrum of acetaldehyde.
21. Tetramethylsilane is chosen as reference compounds in PMR studies. Why?
22. Write a brief account of equivalent and non equivalent protons.
23. Write a detailed note on spin-spin coupling?
24. Distinguish the following pair on the basis of PMR data.
- $\text{CH}_3\text{OCH}_3$  and  $\text{CH}_3\text{CH}_2\text{OH}$
  - $\text{CH}_3\text{COOC}_2\text{H}_5$  and  $\text{C}_2\text{H}_5\text{COOCH}_3$
25. A compound having the molecular formula  $\text{C}_9\text{H}_{11}\text{Br}$  showed the following set of NMR data:
- $\delta$  2.25, 2H, Multiplet
  - $\delta$  2.72, 2H, Triplet
  - $\delta$  3.38, 2H, Triplet
  - $\delta$ , 7.22, 5H, Singlet

---

**B. Multiple choice questions:**

---

1. How many signals are obtained for ethyl alcohol in its PMR spectrum?
- Four
  - three
  - Five
  - One
2. How many signals are obtained for 1, 1, 2 tribromoethane in its pmr spectrum.
- Four
  - three
  - five
  - two
3. How many NMR signals are formed for 2-chloro propene.
- 2
  - 3
  - 1
  - none
4. Tell the number of NMR signals in case of 1,2 dichloropropane.
- 2
  - 3
  - 4
  - 5
5. Write the multiplicity of the signals in  $\text{CH}_3\text{CH}_2\text{OCH}_2\text{CH}_3$  in NMR spectrum.
- Two triplets
  - a triplet and a quartet
  - Three signals
  - Two singlets and two triplets.
6. Write the multiplicity of signals in  $\text{CH}_3\text{CH}_2\text{OH}$  in NMR spectroscopy.
- singlet, triplet and quartet
  - Two triplets and a quintet.
  - Three signals
  - None of these
7. In an organic compound, the proton linked to  $\text{sp}^2$  hybridized carbonation is more deshielded than that linked to.



(a) Sp hybridized carbon (b) hybridized carbon (c) Both of these (d) None of these.

8. Which of the following solvents cannot be used in NMR spectroscopy?

(a) CCl<sub>4</sub> (b) CS<sub>2</sub> (c) CHCl<sub>3</sub> (d) (CCl<sub>3</sub>) CO

9. The spin is an integer 1, 2, 3 .....n for a nucleus having

- (a) even number of protons and neutrons
- (b) odd mass number
- (c) even mass number and odd number of protons

10. NMR spectra are observed in the region.

(a) Radio frequency (b) Microwave (c) UV/Vis (d) X-ray.

**Answer: 1. b, 2. d, 3. B, 4. C, 5. b, 6. a, 7. c, 8. C, 9. C, 10. a**

**References:**

- 1 *Paula Yurkanis Bruice 4<sup>th</sup> edition.*
- 2 *R.M. Silverstein, G. C. Bassler and T.C. Morrill, Spectrometric Identification of Organic Compounds, Fifth edition John Wiley & sons.*
- 3 *Jag Mohan, Organic Spectroscopy, Principles and Applications II edition, Narosa Publishing House, New Delhi.*
- 4 *Y.R. Sharma, Elementary Organic Spectroscopy, Principles and Chemical Application, Revised Edition, S. Chand.*
- 5 *R. L. Madan, S. Chand and company Pvt. Ltd.*

---

## UNIT-2 ORGANOMETALIC COMPOUNDS

---

### CONTENTS

- 2.1 Objectives
- 2.2 Introduction
- 2.3 Organomagnesium compounds
- 2.4 Grignard reagents
  - 2.4.1 Formation
  - 2.4.2 Structure and chemical reactions
- 2.5 Organozinc compounds
  - 2.5.1 Formation, Structure
  - 2.5.2 Chemical reaction
- 2.6 Summary
- 2.7 Terminal Question
- 2.8 Answers

---

### ***2.1 OBJECTIVES***

---

The main objectives of this chapter are:

- To have a basic knowledge of Organometallic Chemistry.
- Preparation and properties of Organomagnesium compounds.
- Idea about Grignard reagents (formation, structure and chemical properties).
- Idea about Organozinc compounds (formation, structure and chemical properties).

---

### ***2.2 INTRODUCTION***

---

Organometallic Chemistry is the branch of Chemistry which deals with the study of organometallic compounds. Chemical compounds containing at least one chemical bond between a carbon atom and a metal, including alkaline, alkaline earth, and transition metals, and sometimes broadened to include metalloids like boron, silicon, and tin, as well. Aside from

bonds to organyl fragments or molecules, bonds to 'inorganic' carbon, like carbon monoxide (metal carbonyls), cyanide, or carbide, are generally considered to be organometallic as well. Some related compounds such as transition metal hydrides and metal phosphine complexes are often included in discussions of organometallic compounds, though strictly speaking, they are not necessarily organometallic. The related but distinct term "metalorganic compound" refers to metal-containing compounds lacking direct metal-carbon bonds but which contain organic ligands. Metal  $\beta$ -diketonates, alkoxides, dialkylamides, and metal phosphine complexes are representative members of this class. The field of organometallic chemistry combines aspects of traditional inorganic and Organic Chemistry.

In organometallic compounds carbon is bonded with electropositive atom hence carbon contain negative charge and metal contains positive charge thus carbon-metal bond is polarized  $R^{\delta-}-M^{\delta+}$ . Organic part of organometallic compounds is always behaves as nucleophile as well as base.

---

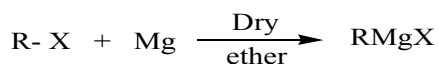
## ***2.3 ORGANOMAGNESIUM COMPOUNDS***

---

Organomagnesium halide were discovered by the French chemist Victor Grignard in 1900 and these compounds are now called as Grignard reagents and was awarded the 1912 Nobel Prize in Chemistry for this work. Grignard reagents are similar to organolithium reagents because both are strong nucleophiles that can form new carbon-carbon bonds. The nucleophilicity increases if the alkyl substituent is replaced by an amido group.

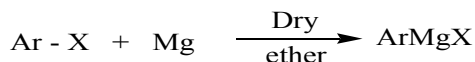
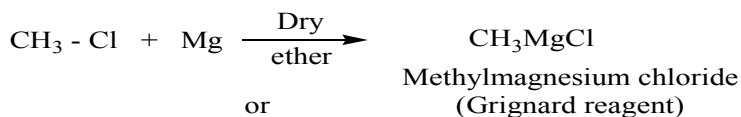
### **2.3.1 Formation of Grignard reagents:**

Grignard reagents are usually prepared by the reaction of organic halide with magnesium in the presence of dry ether.



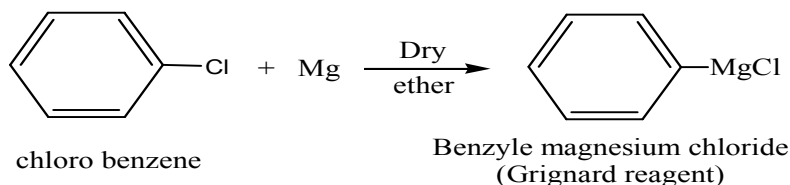
Where R = Alkyl groups (CH<sub>3</sub>, C<sub>2</sub>H<sub>5</sub>, C<sub>3</sub>H<sub>7</sub>.....)  
X = Halogen atoms (Cl, Br, I)

**For examples:**



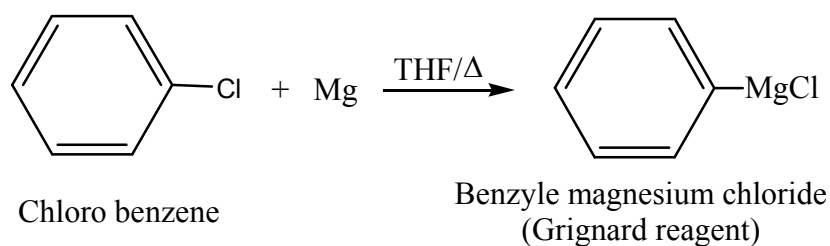
Where Ar = Aryle groups (CH<sub>3</sub>, C<sub>2</sub>H<sub>5</sub>, C<sub>3</sub>H<sub>7</sub>.....)  
X = Halogen atoms (Cl, Br, I)

**For examples:**



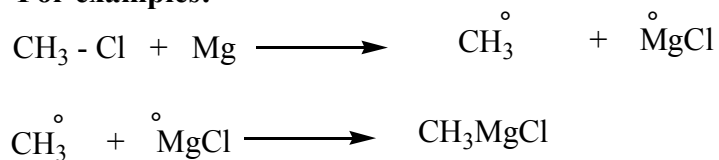
Ether is used as a solvent because it can dissolve the reagent by acting as a base towards the acidic magnesium. For the formation of Grignard reagent tetrahydrofuran (THF) is also used as a solvent in place of dry ether.

**For examples:**



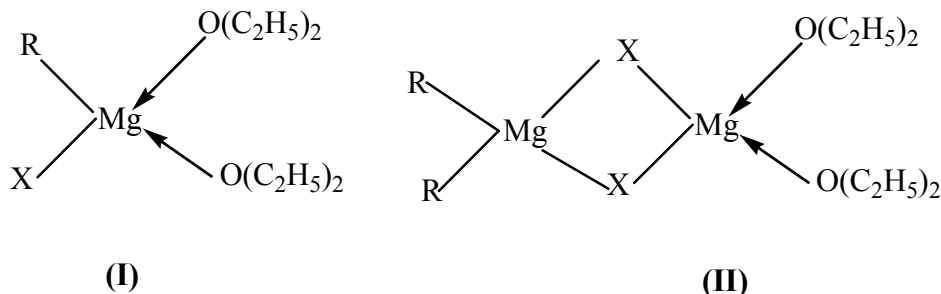
**Mechanism:** The most common mechanism appears for the formation of Grignard reagent is to be free radical mechanism.

**For examples:**



### 2.3.2 Structure of Grignard Reagents:

During the formation of Grignard reagents, dry ether used as a solvent. Thus, it has been assumed that ether molecules are present as ether of crystallization. Since, following two most probable structures have been proposed for the Grignard reagent.



### 2.3.3 Properties of Grignard Reagents:

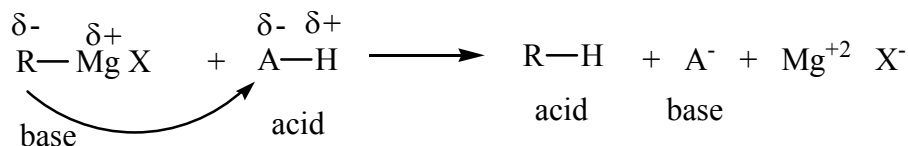
#### [A] Physical properties:

Grignard Reagents are colorless and non volatile solvents. They are not isolated in free form due to their explosive character.

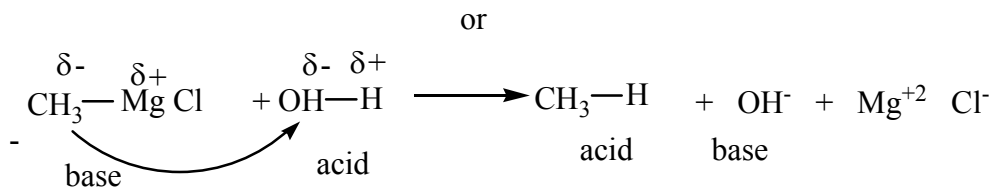
**[B] Chemical Properties:** Grignard reagents give following types of reaction:

#### (1) Reaction with compounds containing acidic hydrogen:

Grignard Reagents react with compounds having acid hydrogen to form hydrocarbons. The reaction behaves as acid base reaction because in this reaction it acts as base.



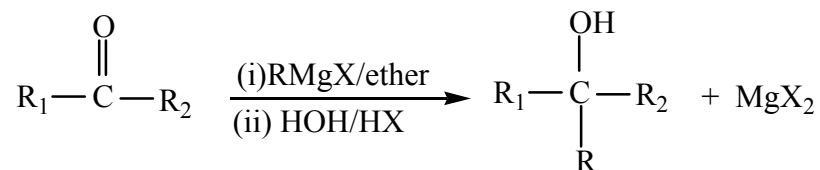
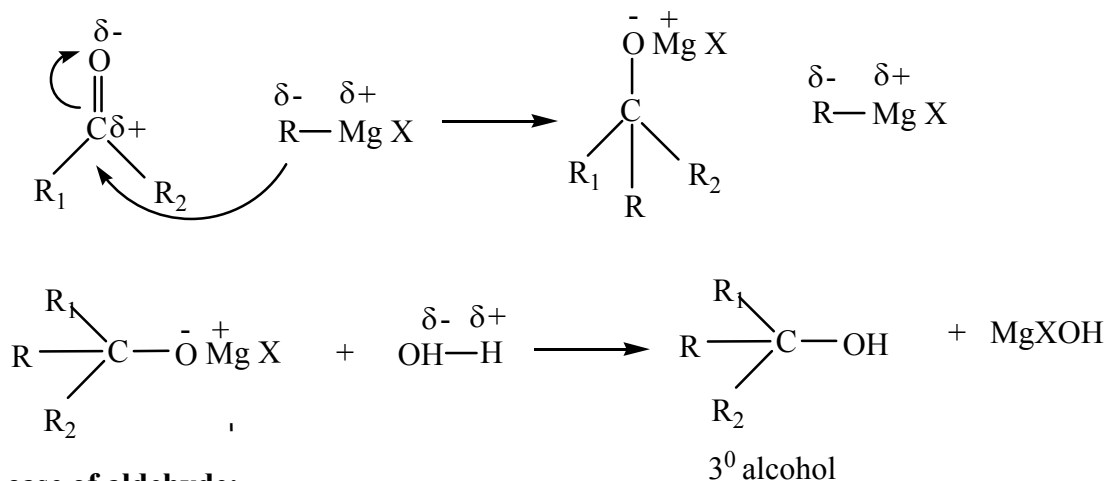
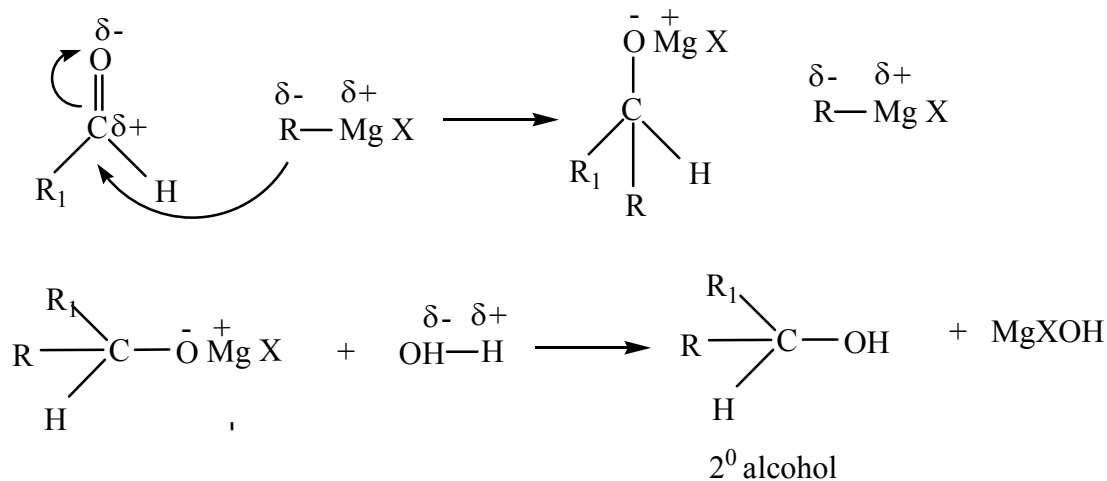
Where  $\text{A}-\text{H} = \text{HOH}, \text{C}_6\text{H}_5\text{OH}, \text{ROH}, \text{C}_6\text{H}_5\text{SH}, \text{RCOOH}, \text{NH}_3, \text{RNH}_2, \text{R}_2\text{NH}, \text{HX}, \text{H}_2\text{SO}_4$  etc



Thus, these compounds can be used for the decomposition of excess Grignard reagents from the reaction mixture.

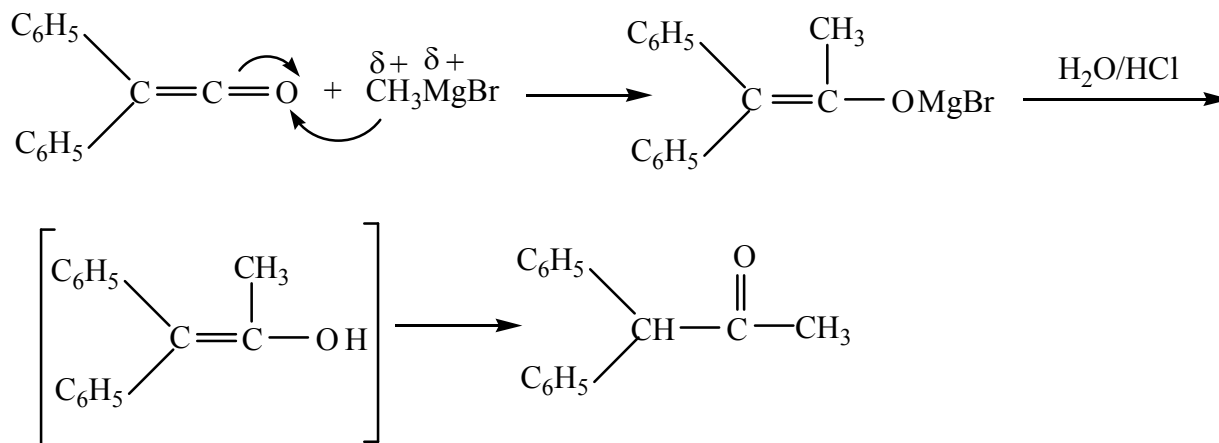
**(2) Nucleophilic addition reaction:****(a) Addition with Aldehydes and Ketones:**

The most important reaction of Grignard reagent is those in which it acts as nucleophile and attacks an unsaturated carbon, especially the carbon of the carbonyl group. In this reaction Grignard reagents react with carbonyl compounds (aldehydes and ketones) it gives corresponding alcohols.

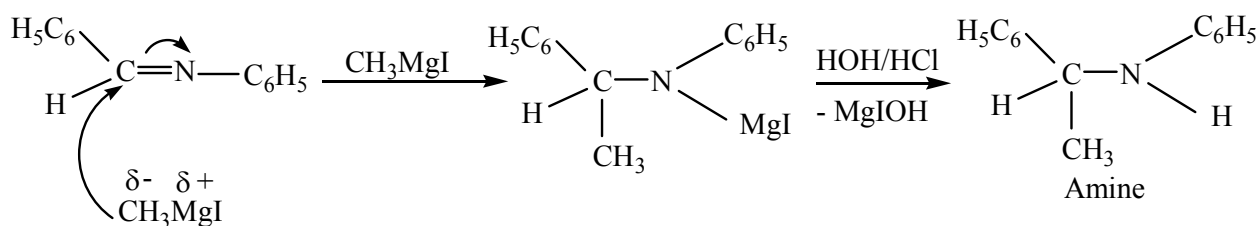
**Example:****Mechanism:****In case of ketone:****In case of aldehyde:**

**(b) Addition with ketenes and isocyanates:** Grignard Reagents react with ketene to give ketones.

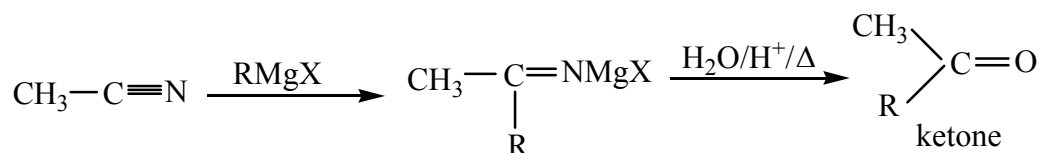
In this reaction nucleophilic attack occurs at carbonyl group to produce an enolate which on hydrolysis, gives ketone.



**(c) Addition with Imines and Nitriles:** Grignard reagents react with imines to form amines followed by hydrolysis.

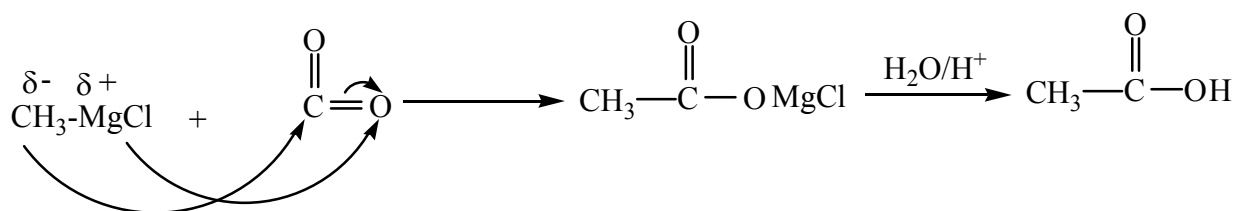


Similarly, Grignard reagents react with nitriles by nucleophilic addition. In this reaction Grignard reagents react with nitriles to give imine salt which on hydrolysis give ketones.

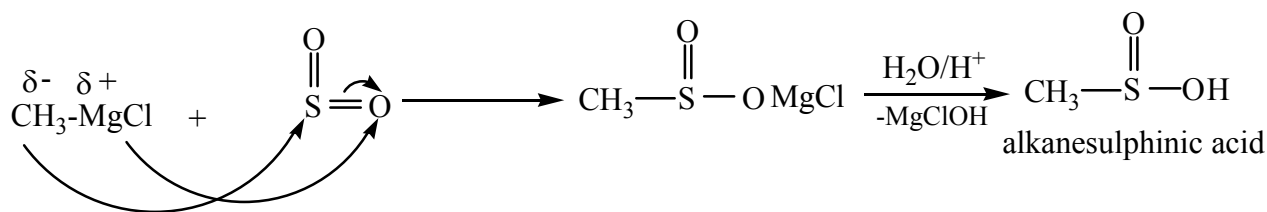


**(d) Addition reaction with CO<sub>2</sub>, SO<sub>2</sub> and CS<sub>2</sub>:**

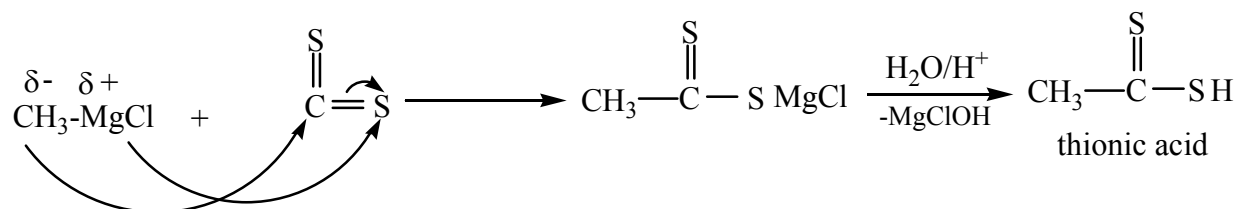
**(i) Reaction with CO<sub>2</sub>:** Grignard reagents react with carbon dioxide followed by hydrolysis gives carboxylic acid.



**(ii) Reaction with SO<sub>2</sub>:** Grignard reagents react with sulphur dioxide followed by hydrolysis gives alkanesulphonic acid.

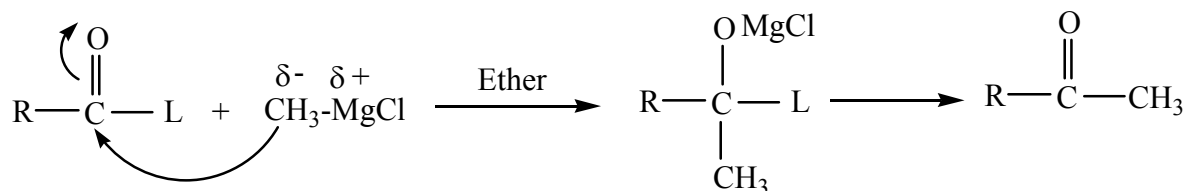


(ii) **Reaction with CS<sub>2</sub>:** Grignard reagents react with carbon disulphide followed by hydrolysis gives thionic acid.

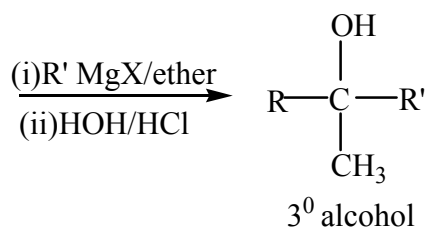


### (3) Nucleophilic Substitution Reactions at Sp<sup>2</sup> hybrid carbons:

(i) **Reaction with acid chlorides, Esters, Amides and Lactones:** Grignard reagents when react with acid chlorides, Esters and Amides, the following reaction takes place.



Where L = Cl, OR

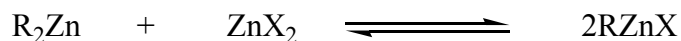


Grignard reagents when react with Lactones to give hydroxyl ketones or diols depending on the degree of hindrance of the lactone.

## 2.5 ORGANOZINC COMPOUND

Organozinc compounds are one of the most important of organometallic compounds. The first instance of an organozinc compound goes back to 1849 when Edward Frankland discovered that heating a mixture of zinc and ethyl iodide gives highly pyroporic diethyl zinc. Organozinc compounds in general are sensitive to oxidation; dissolve in a wide variety of solvents whereas protic solvents cause decomposition.

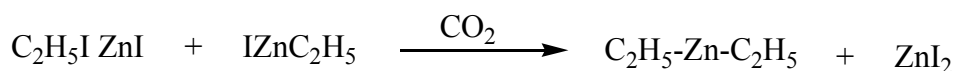
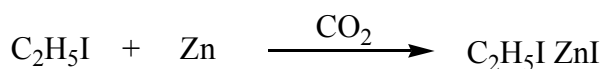




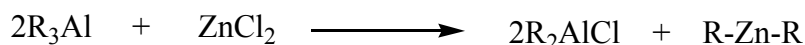
In terms of reactivity, organozinc compounds are less reactive than Grignard reagents. This can be explained on the basis of relative position of Mg and Zn in the periodic table. Since zinc is more electropositive than Mg thus the Zn-C bonds have a higher degree of covalency compared to the Mg-C bond. In a typical case, the electrons forming the C-Zn bond reside in two *sp* hybridized molecular orbitals resulting in linear geometry about the zinc centre.

#### Methods of formation:

1. When the zinc metal is treated with the alkyl iodine in the presence of CO<sub>2</sub> then there occurs the formation of di alkyl zinc organometallic compounds.



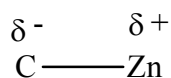
2. When the organo aluminium compound is treated with the ZnCl<sub>2</sub> then there can occur the formation of di alkyl zinc organo metallic compound.



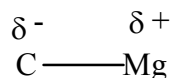
The above method is known as laboratory method for the synthesis of organo zinc compound.

**Chemical properties:** Organo zinc compound exhibit less reactivity than the organo magnesium compound.

**Explanation:** Organo zinc compound containing less amount of the ionic character (18%) while organo magnesium compound containing higher amount of ionic character (35%) in the C-M bond by this reason zinc compound exhibit less reactivity than the organo magnesium compound.



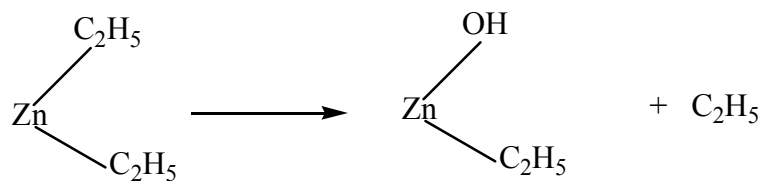
18% ionic character  
(Less reactive)



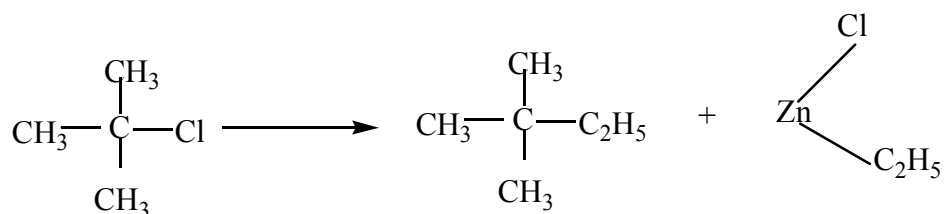
35% ionic character  
(More reactive)

Some of the chemical reactions which can be exhibited by the organo zinc compound can be represented as:

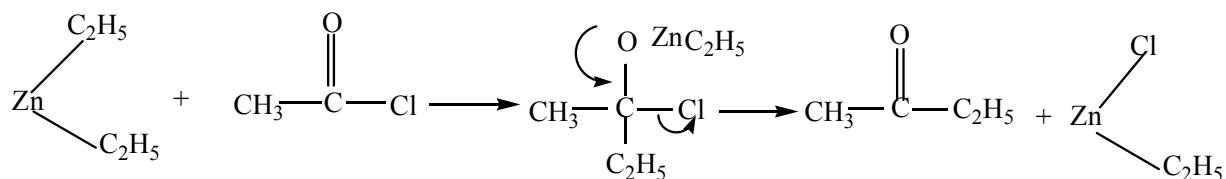
#### 1. Reaction with H<sub>2</sub>O:



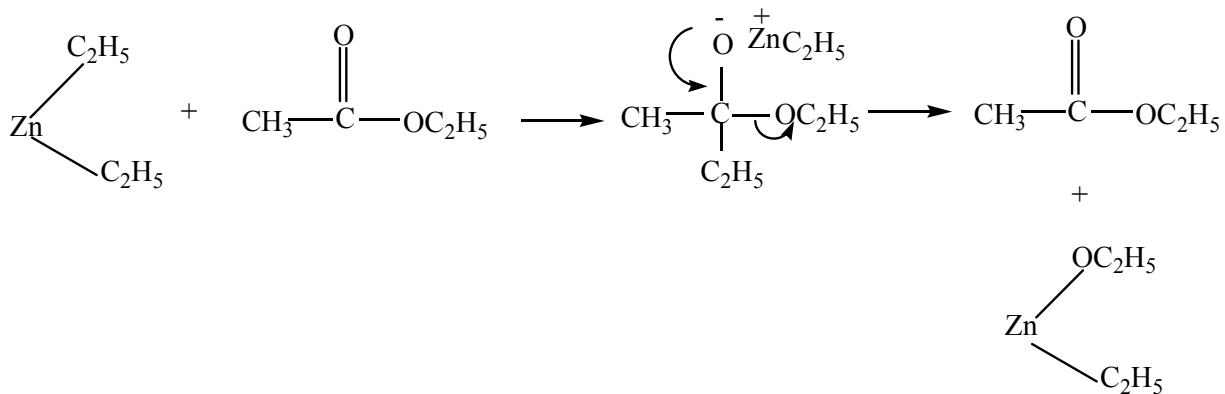
2. Reaction with alkyl halide:



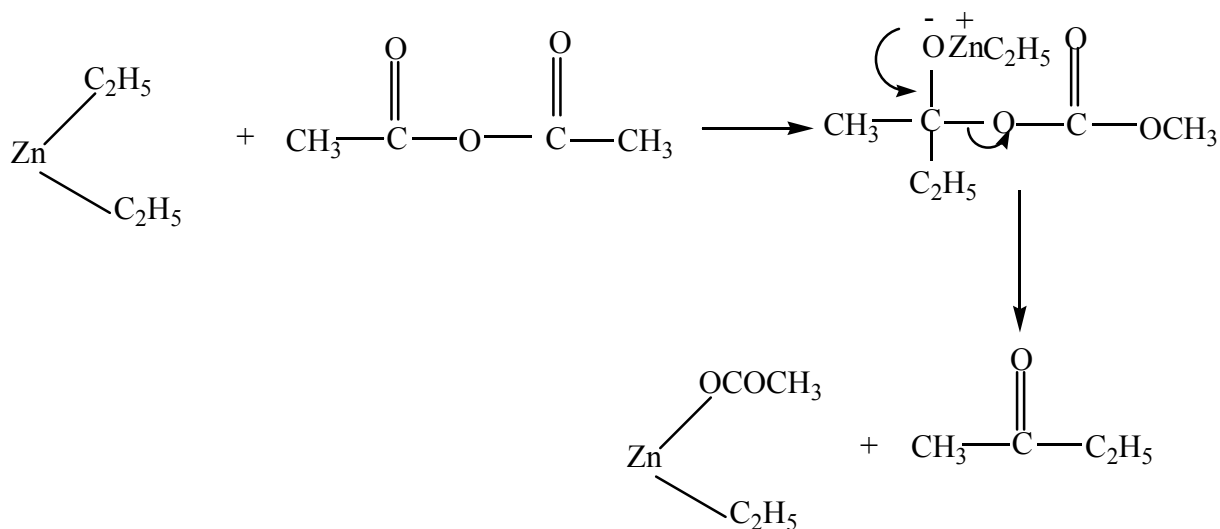
3. Reaction with acetyl chloride:



4. Reaction with the ester:



5. Reaction with acetic anhydride:




---

## 2.6 SUMMARY

---

Organometallic compounds are those organic compounds in which there is a bond between carbon and metal. The bonding nature of metal and carbon is totally different and having wide variation. Highly electropositive metals like sodium and potassium tend to make this bond ionic, with the metal containing a positive charge and carbon containing a negative charge. Organometallic compounds of magnesium and lithium have this bond with partial ionic character.

---

## 2.7 TIRMINAL QUESTIONS

---

1. Discuss the preparation and properties of Grignard reagent.
2. Discuss formation and reactions of organo zinc compound.
3. Arrange Grignard reagents, organolithium compound and organozinc compound in decreasing order of reactivity.
4. Write the structure of Grignard reagent formed by the reaction of p-bromofluorobenzene with magnesium in diethyl ether.
5. How can you obtain the following from Grignard reagent?
6. What happens when methyl magnesium bromide is reacted with (i)  $\text{CO}_2$ , (ii)  $\text{HCOOC}_2\text{H}_5$  (iii)  $\text{CH}_3\text{CHO}$ .

7. Using suitable RMgX prepare the following:  
(i)  $\text{CH}_3\text{CH}_2\text{CHOHCH}_3$  (ii)  $\text{CH}_3\text{CH}_2\text{CH}_2\text{COOH}$
8. How can you obtain the following from Grignard reagent?  
(i) Dithionic acid (ii) Tert. Butyl alcohol

**REFERENCES:** R. L. Madan, S. Chand and company Pvt. Ltd.

---

## UNIT-3 ORGANISULPHUR COMPOUNDS

---

### CONTENTS

3.1 Objectives

3.2 Introduction

3.3 Nomenclature

3.4 Organo sulphur compounds; thiols, thioethers, sulphonic acid, sulphonamides and sulphguanidine

- Structural features
- Methods of formation
- Chemical reactions

3.5 Summary

3.6 Terminal Question

3.7 Answers

---

### ***3.1 OBJECTIVES***

---

In this unit learner will be able to:

- Know about Organo sulphur compounds
- Understand and discuss the preparations and Properties of various Organo sulphur compounds.
- Understand the important physical and chemical properties of Organo sulphur compounds.

---

### ***3.2 INTRODUCTION***

---

**Organosulfur compounds** are organic compounds that contain sulfur. They are often associated with foul odors, but many of the sweetest compounds known are organosulfur derivatives, e.g., saccharin. Nature abounds with organosulfur compounds—sulfur is essential for life. Of the 20 common amino acids, two (cysteine and methionine) are organosulfur compounds, and the

antibiotics penicillin and sulfa drugs both contain sulfur. While sulfur-containing antibiotics save many lives, sulfur mustard is a deadly chemical warfare agent. Fossil fuels, coal, petroleum, and natural gas, which are derived from ancient organisms, necessarily contain organosulfur compounds, the removal of which is a major focus of oil refineries.

Organisulphur compounds are derivatives to organic compounds containing oxygen with the difference that oxygen has been replaced by sulphur. These compounds give the reactions similar to other oxygen containing compounds. The some of the common examples of the sulphur containing Organic compounds are given as:

R-S-H = Thiols

-S-H = Thiol group

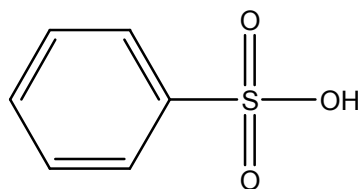
R-S-R = Thioethers

-S- = Thioether group

There are many Organisulphur compounds containing sulphur- oxygen bonds with double bond character; for example, sulphoxides such as dimethylsulphoxide and sulphonic acids.

$(\text{CH}_3)_2 \text{SO}$

(Dimethyl sulphoxide)



benzene sulphonic acid

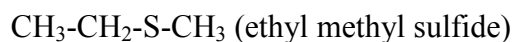
---

### 3.3 NOMENCLATURE

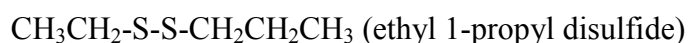
---

**Nomenclature of Mercaptans:** Mercaptans can be named by naming the parent compound immediately followed by the word thiol. The -SH group can also be named as a substituent using the group name, sulfhydryl. Mercaptans can also be named by naming the carbon group as a separate word followed by the word mercaptan. For example the names of  $\text{CH}_3\text{-SH}$  are methanethiol, sulfhydrylmethane and methyl mercaptan.

**Nomenclature of Sulfides:** Sulfides can be named most readily by naming each of the two carbon groups as a separate word followed by a space and the word sulfide.

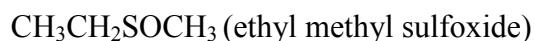


**Nomenclature of Disulfides:** Disulfides can be named most readily by naming each of the two carbon groups as a separate word followed by a space and the word disulfide.



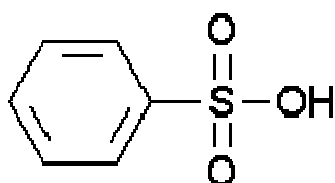
**Nomenclature of Sulfoxides:**

Sulfoxides can be named most readily by naming each of the two carbon groups as a separate word followed by a space and the word sulfoxide.



**Nomenclature of Sulfonic Acids:**

Sulfonic acids can be named most readily by naming the carbon group as a separate word followed by the words sulfonic acid.



*Phenyl sulfonic acid*

---

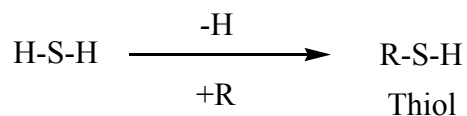
### **3.4 ORGANO SULPHUR COMPOUNDS; THIOLS, THIOETHERS, SULPHURIC ACID, SULPHONAMIDES AND SULPHGUANIDINE**

---

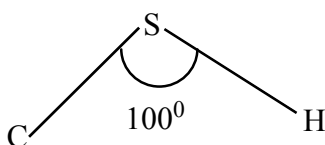
#### **A. THIOLS:**

Thiol is sulphur derivatives of alcohols in which the oxygen has been replaced by sulphur atom. The functional group of thiol is  $\text{-SH}$ . It is also known as mercapto group. It is weak acid like  $\text{H}_2\text{S}$

and they react with mercuric acid to form insoluble salt. Therefore, they were given the name mercaptans.

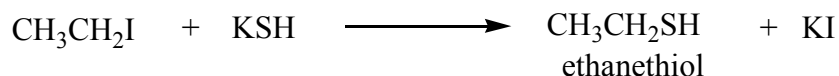


**Structure:** The structure of thiol is similar to alcohol. The properties of S-H bond are lower as compared to that of O-H bond in alcohols. This is due to low electronegativity of sulphur in comparison to oxygen. The shape of thiol is bent like structure and the bond angle is  $100^\circ$ .

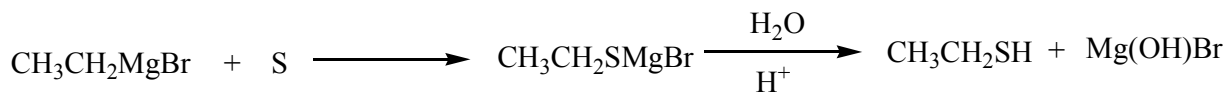


### Methods of Preparation:

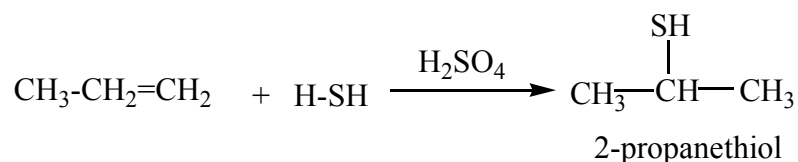
- 1. By the reaction of alkyl halides with potassium hydrosulphide (KSH) solution:** When ethyl iodide reacts with potassium hydrosulphide (KSH) in the presence of heat, it gives ethane thiol.



- 2. By the reaction of Grignard reagent with sulphur:** In this reaction Grignard reagents initially react with sulphur atom to give an addition product, which on further acidic hydrolysis forms ethanethiol.



- 3. By the addition of hydrogen sulphide to alkene in the presence of sulphuric acid:** When alkenes react with hydrogen sulphide in the presence of sulphuric acid to form thiol.

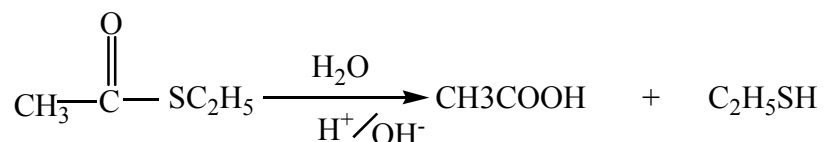




4. **By the reaction of alcohol with phosphorus pentasulphide:** When any alcohols react with phosphorus pentasulphide to give thiol.



5. **By hydrolysis of thioester:** Thioester when react with dilute acid or alkali to form thiol.

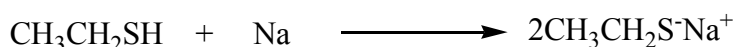


### Chemical properties of thiol:

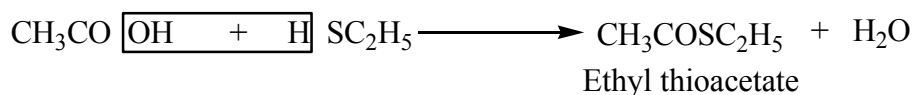
1. **Acidic Nature:** Thiols are weaker acid but more acidic than alcohols because sulphur has lower electronegative than oxygen. This could be due to following reasons:

- (1) The S-H bond is weaker than O-H bond due to which S-H easily donate  $\text{H}^+$  ion than alcohol
- (2) The  $\text{RS}^-$  anion obtained after the release the proton is more stable than  $\text{RO}^-$  ion obtained from alcohols, due to which negative charge accommodate the negative charge more easily than  $\text{RO}^-$  ion because of larger size of sulphur atom.

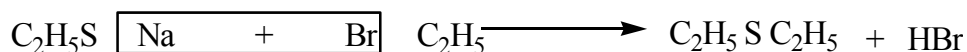
2. **Reactive with alkali and alkaline earth metals:** Thiol reacts with active metals like Na, K, Ca etc. releasing hydrogen gas.



3. **Reaction with acids and acid chloride:** Thiol reacts with acids and acid chlorides to form thioester.

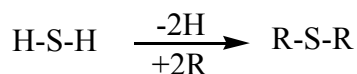


4. **Reaction with alkyl halides:** Sodium salt of thiols when react with alkyl halides to form diethyl thioether.

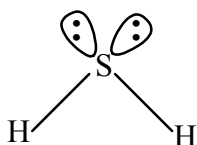


**B. THIOETHERS:**

Thioether is a functional group in organosulfur compounds with the connectivity C–S–C. A thioether is similar to an ether except that it contains a sulfur atom in place of the oxygen. The grouping of oxygen and sulfur in the periodic table suggests that the chemical properties of ethers and thioethers are somewhat similar.

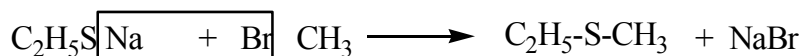
**Structure of Thioethers:**

Thioethers have tetrahedral structure with two positions occupied by lone pair of electrons as given below.

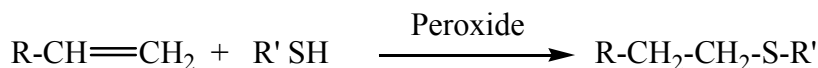


**Methods of preparation:** Some of the common methods used for the preparation of thioethers, which are given below.

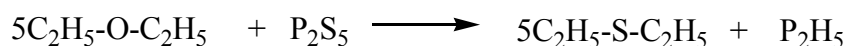
- 1. Reaction of alkyl halide with sodium or potassium mercaptide:** In this reaction sodium or potassium mercaptide react with alkyl bromide than it forms corresponding thioether.



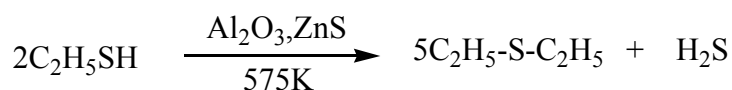
- 2. From alkenes:** Addition of thiols to alkenes in the presence of peroxide gives thioethers.



- 3. From ethers:** Ethers when heated with phosphorus penta sulphide to form thioether.

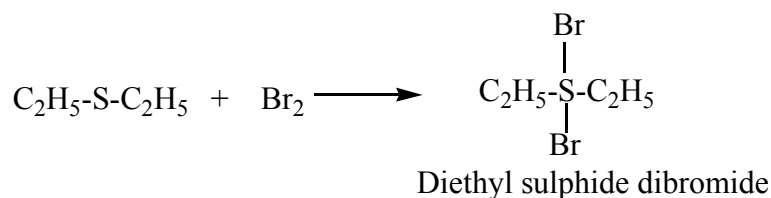


- 4. From thiols:** Vapours of thiol when passed through a mixture of aluminium tri oxides and zinc sulphide at 575K temperature to form thioether.

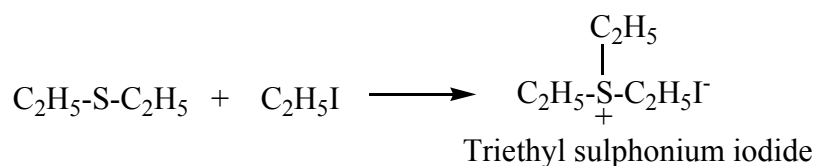
**Chemical reactions of Thioethers:**

Some of the important chemical reactions of thioethers are given below:

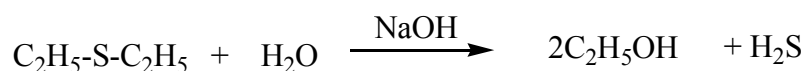
- 1. Reaction with halogens:** Thioethers when react with halogen like Cl, Br and I to form dihalide.



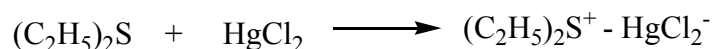
- 2. Reaction with alkyl halide:** Thioethers when react with alkyl halide to form sulphonium salts.



- 3. Hydrolysis reaction:** Thioether on hydrolysed with aqueous NaOH to form alcohols and H<sub>2</sub>S gas.



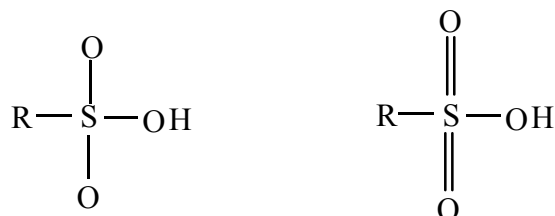
- 4. Reaction with metallic salts:** Thioethers react with metallic salt like HgCl<sub>2</sub> and SnCl<sub>4</sub> to form metallic salt.



### C. SULPHONIC ACID:

A sulfonic acid (or sulphonic acid) is a member of the class of organosulfur compounds with the general formula R-S(=O)<sub>2</sub>-OH, where R is an alkyl or aryl group and the S(=O)<sub>2</sub>(OH) group a sulfonyl hydroxide.

**Structure:** There are two main types of the representations of sulphonic acid are given below:



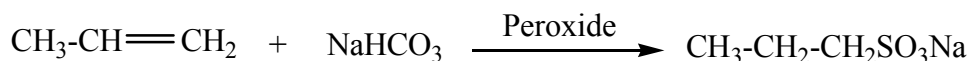
**Methods of preparation:**

1. **By oxidation of thiols:** Oxidation of thiol with strong oxidizing agents such as  $\text{HNO}_3$  and  $\text{KMnO}_4$  to form alkane sulphonic acid.

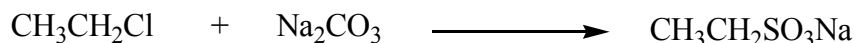


Where R = Alkyl groups

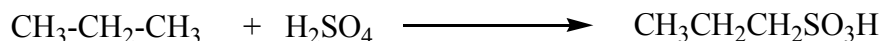
2. **By the addition of sodium sulphate with alkenes:** Addition of sodium bisulphate to alkenes in the presence of peroxide gives sodium salt of alkyl sulphonate.



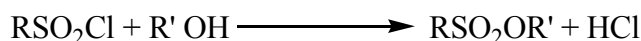
3. **By the reaction of sodium sulphate with alkyl halide:** When the mixture of sodium sulphate and alkyl halide is heated, sodium salt of alkane sulphonic acid is obtained.



4. **From sulphonation of alkane:** When any alkanes react with sulphuric acid than it gives alkyl sulphonic acid.

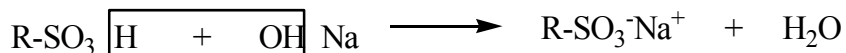
**Chemical properties of sulphonic acid:**

1. **Esterification:** Alkyl or aryl sulphonyl chloride when react with alcohol to form corresponding ester. This reaction is known as esterification reaction.



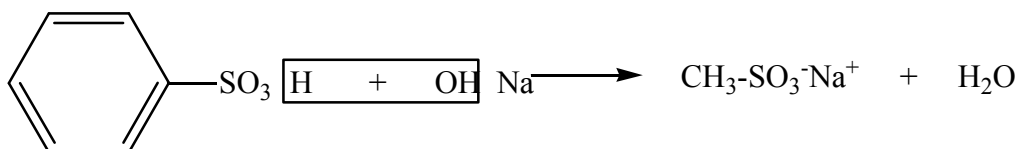
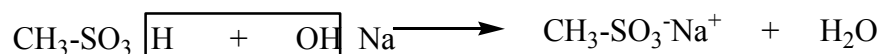
Where R= Alkyl or aryl groups

2. **Salt formation:** Sulphonic acid are strongly acidic, they form salt with hydroxide, carbonate and bicarbonates.



Where R = alkyl or aryl groups

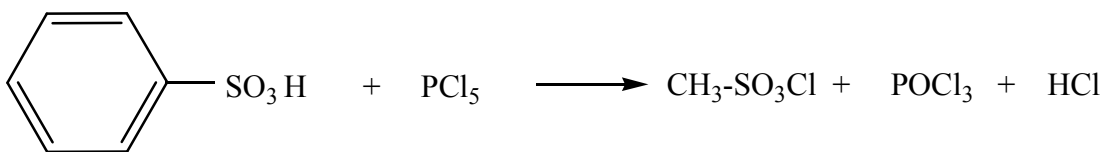
**Example:**



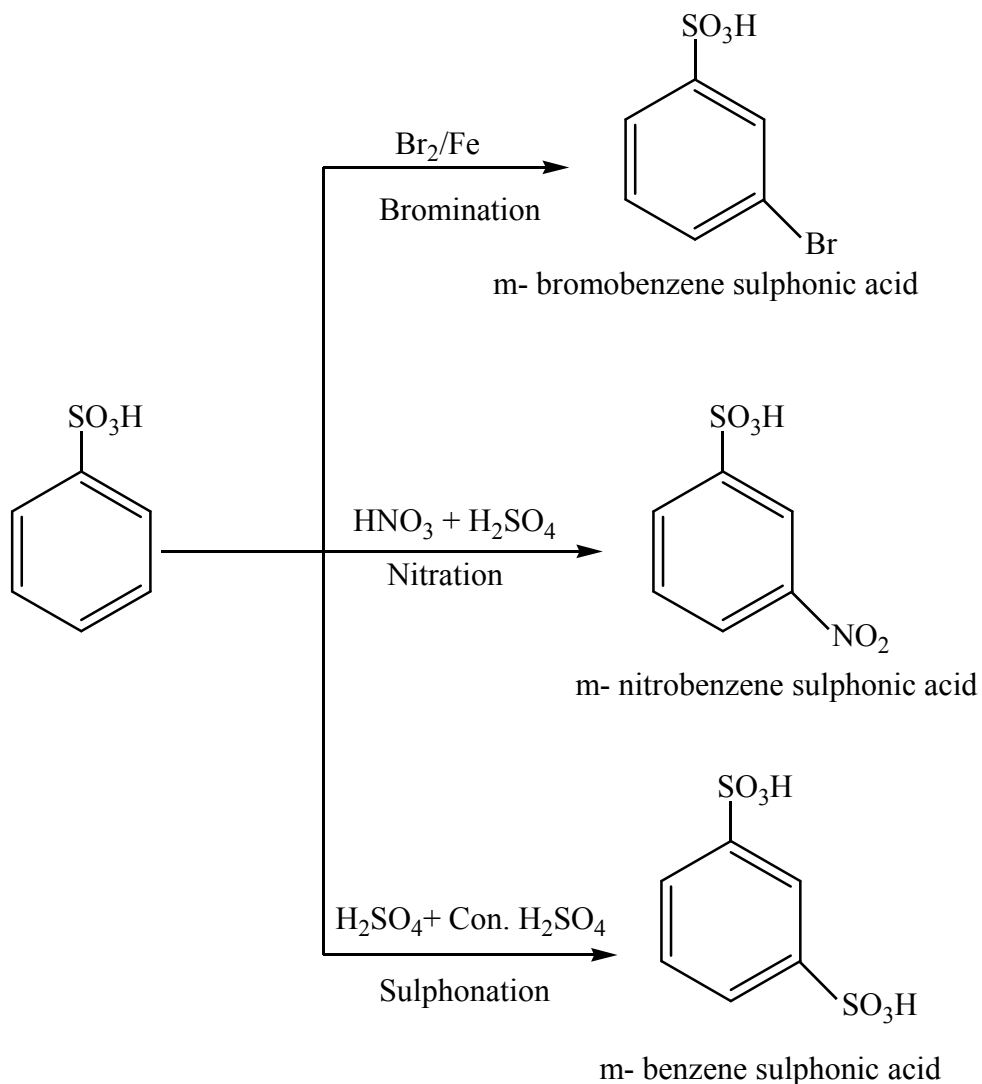
- 3. Formation of sulphonyl chloride:** Sulphonic acid forms sulphonyl chloride when reacted with phosphorus chloride or thionyl chloride.



**Example:**

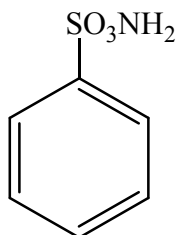


- 4. Electrophilic substitution reaction:** Aromatic sulphonic acid undergoes electrophilic substitution reactions giving different types of substituted products. Some common electrophilic substitution reactions are given below.



### SULPHONAMIDES (Benzene sulphonamides):

Sulphonamide is a functional group that is the main component of various groups of drugs, which are called sulphonamides, sulpha drugs.

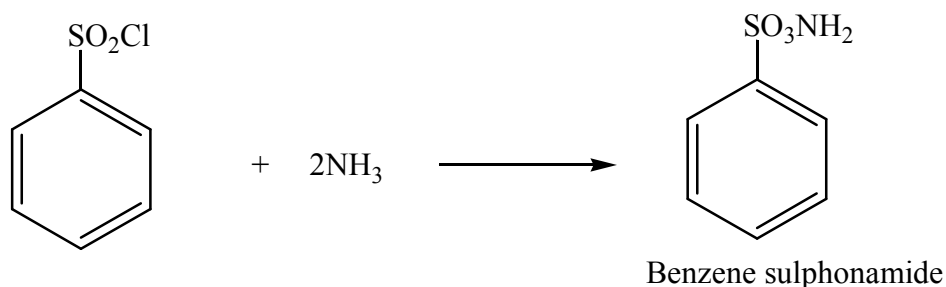


Benzene sulphonamide

Method of Preparation:

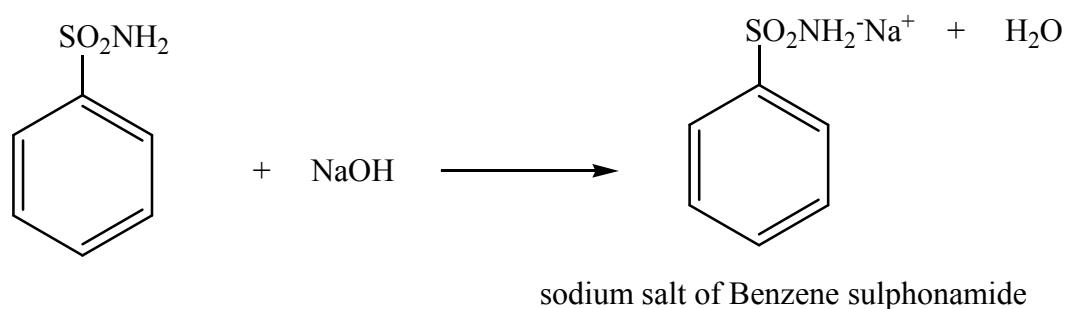
- 1. From benzene sulphonyl chloride:** Benzene sulphonamide is prepared by the reaction

of ammonia with benzene sulphonyl chloride.

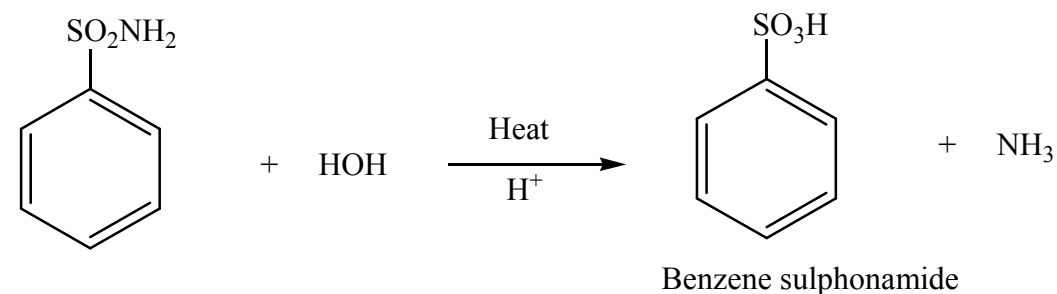


### Chemical properties:

1. **Acidic in nature:** It is weakly acidic in nature and hence react with strong base like NaOH or KOH gives corresponding salt.



2. **Hydrolysis reaction:**

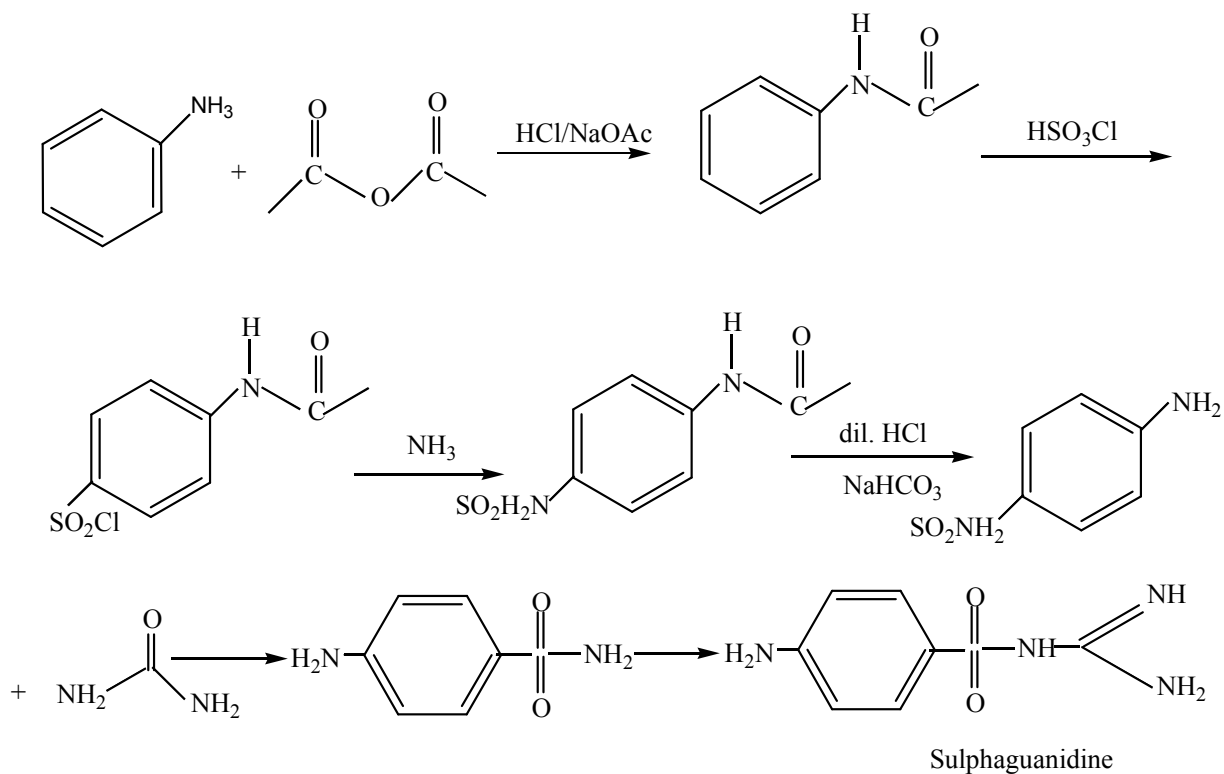


### SULPHGUANIDINE:

Sulphaguanidine is a sulfanilamide anti-infective agent. It is mostly used for antimicrobial action. It is used to treat bacillary dysentery, also as raw material of sulfadiazine drugs, as auxiliary material for other drugs.

### Preparation:

1. **From aniline:**



### 3.5 SUMMARY

- This unit comprises the detail study of Organo sulphur compounds like thiols, thioethers, sulphonic acid, sulphonamides and sulphguanidine
- Preparations, Structural feature and chemical properties of Organo sulphur compounds.

### 3.6 TERMINAL QUESTION

- Why are alcohol weaker acid than alcohol.
- Give two methods of formation of thioether.
- Give three methods of formation of thiol.
- What are organo sulphur compounds? Give two methods for the formation of sulphonamides.
- Give two general methods for the formation of sulphonic acid.
- Discuss the mechanism of nitration of benzene.
- Write short note on sulphonation.
- Give three methods of preparation of alkane sulphonic acids.
- What are mercaptanes? Describe their chemical reactions.
- What do mean by desulphonation? Give its mechanism.



11. Write an account of the preparation and properties of sulphonamide.
12. Bring out the following transformations:
  - (i) Benzene sulphonic acid in to benzene
  - (ii) Benzene in to benzenesulphonamide
  - (iii) Methyl phenyl thioether in to methyl phenyl sulphone.
13. What happens when:
  - (i) Diethyl sulphide react with ethyl iodide
  - (ii) Ethanethiol react with nitric acid
  - (iii) Ethyl mercaptane react with acetone

**References:** R. L. Madan, S. Chand and company Pvt. Ltd.

---

## UNIT 4: HETEROCYCLIC COMPOUNDS- I

---

### CONTENTS

- 4.1 Objectives
- 4.2 Introduction
- 4.3 Classification of heterocyclic compounds
- 4.4 Nomenclature of heterocyclic compounds
- 4.5 Molecular orbital picture
- 4.6 Structure and aromaticity of pyrrole, furan, thiophene and pyridine
- 4.7 Methods of synthesis properties and chemical reactions of Pyrrole, Furan, Thiophene and Pyridine
- 4.8 Comparison of basicity of Pyridine, Piperidine and Pyrrole
- 4.9 Summary
- 4.10 Terminal Question

---

### **4.1 OBJECTIVES**

---

**In this unit learner will be able to**

- Know about the most important simple heterocyclic ring systems containing heteroatom and their systems of nomenclature and numbering.
- Understand and discuss the reactivity and stability of hetero aromatic compounds.
- Study the important synthetic routes and reactivity for five and six member hetero aromatic compounds.
- Understand the important physical and chemical properties of five and six member hetero aromatic compounds.
- Know about the applications of these hetero aromatic compounds in the synthesis of important industrial and pharmaceutical compounds

---

## 4.2 INTRODUCTION

---

Heterocyclic compound is the class of cyclic organic compounds those having at least one hetero atom (*i.e.* atom other than carbon) in the cyclic ring system. The most common heteroatoms are nitrogen (N), oxygen (O) and sulphur (S). Heterocyclic compounds are frequently abundant in plants and animal products; and they are one of the important constituent of almost one half of the natural organic compounds known. Alkaloids, natural dyes, drugs, proteins, enzymes etc. are the some important class of natural heterocyclic compounds. Heterocyclic compounds can be easily classified based on their electronic structure. Heterocyclic compounds are primarily classified as saturated and unsaturated. The saturated heterocyclic compounds behave like the acyclic derivatives with modified steric properties. Piperidine and tetrahydrofuran are the conventional amines and ethers of this category. However, unsaturated heterocyclic compounds of 5- and 6- member rings have been studied extensively because of their unstrained nature. The unstrained unsaturated heterocyclic compounds include Pyridine, Thiophene, Pyrrole, Furan and their benzo fused derivatives. Quinoline, Isoquinoline, Indole, Benzothiophene, and Benzofuran are some important example of benzo fused heterocycles. Heterocyclic compounds have a wide application in pharmaceuticals, agrochemicals and veterinary products. Many heterocyclic compounds are very useful and essential for human life. Various compounds such as hormones, alkaloids antibiotic, essential amino acids, hemoglobin, vitamins, dyestuffs and pigments have heterocyclic structure.

In the present unit, students would be able to learn about the common five and six membered heterocyclic compounds, such as Pyrrole, Furan, Thiophene, Pyridine and Piperidine etc.

---

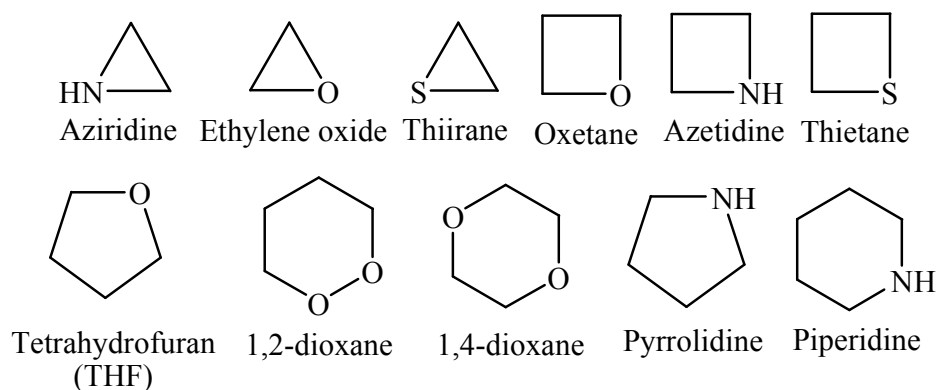
## 4.3 CLASSIFICATION OF HETEROCYCLIC COMPOUNDS

---

Based on the structural and electronic arrangement the heterocyclic compounds may be classified into two categories.

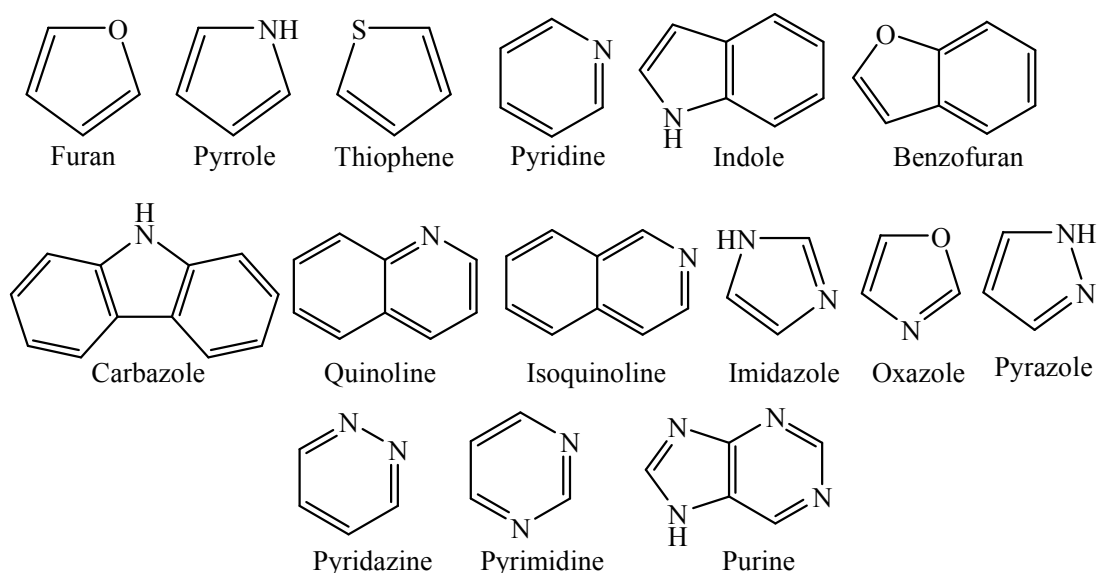
- i. Aliphatic heterocyclic compounds
- ii. Aromatic heterocyclic compounds

The aliphatic heterocyclic compounds are the cyclic amines, cyclic amides, cyclic ethers and cyclic thioethers. Aliphatic heterocycles those do not contain double bonds are called saturated heterocycles. The properties of aliphatic heterocycles are mainly affected by the ring strain. Examples of aliphatic heterocyclic compounds are shown in figure 1.



**Figure 1.** Examples of aliphatic heterocyclic compounds

However, aromatic heterocyclic compounds are analogous of benzene. The aromatic heterocyclic compounds also follow the Huckel's rule. According to Huckel's rule an aromatic compounds must be cyclic in nature with planar geometry due to conjugate double bonds and must have  $(4n+2)\pi$  electrons. Examples of aromatic heterocyclic compounds are shown in figure 2.



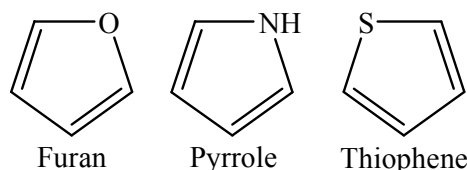
**Figure 2.** Examples of aromatic heterocyclic compounds

A hetero cyclic ring may comprise of three or more than three atoms, which may be saturated or unsaturated. Also heterocyclic ring may contain more than one heteroatom which may be either similar or different.

Based on the variety of structure, the heterocyclic compounds may also be divided in to three categories.

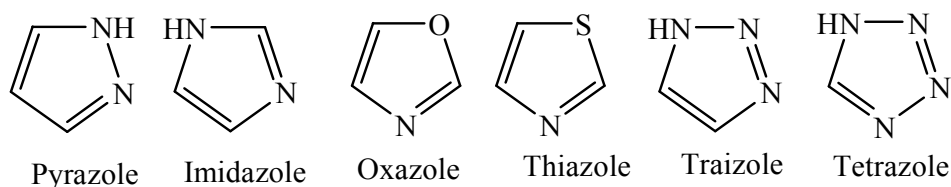
1. Five membered heterocyclic compounds: These heterocyclic compounds may be considered to be derived from benzene by replacing one C=C bond by a hetero atom with a lone pair of electron. Based on number of hetero atom present in the cyclic ring this class of heterocyclic compounds may be further subdivided in to following categories.

a). Heterocyclic compounds with one hetero atom: Common examples of this class of compounds are furan, thiophene and pyrrole (Figure 3).



**Figure 3.** Five member heterocyclic compounds with one hetero atom

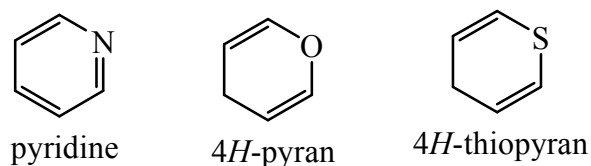
b). Heterocyclic compounds with more than one hetero atom: These hetero atoms may be same or different. Common examples of this category of heterocyclic compounds are pyrazole, imidazole, thiazole, oxazole, triazole and tetrazole etc (Figure 4).



**Figure 4.** Five member heterocyclic compounds with two hetero atom

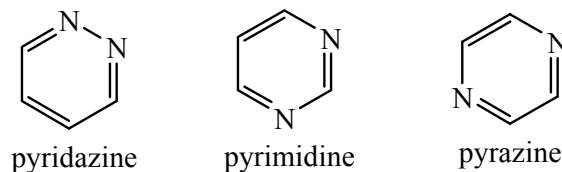
2. Six membered heterocyclic compounds: This class of compounds may be considered to be derived from the replacement of a carbon atom of benzene by an iso-electronic atom. Similar to the five membered heterocyclic compounds, the six membered heterocyclic compounds may also be subdivided in to following categories.

a). Heterocyclic compounds with one hetero atom: Common examples of this class of compounds are pyridine, pyran, thiopyran etc (Figure 5).



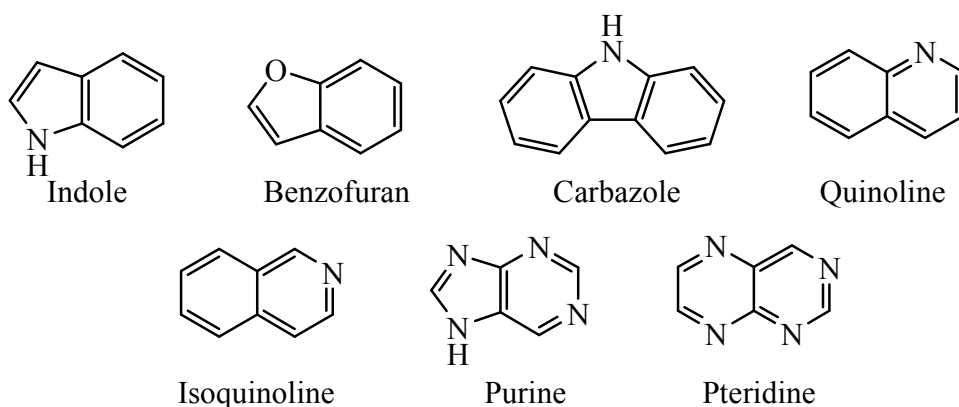
**Figure 5.** Six member heterocyclic compounds with one hetero atom

b). Heterocyclic compounds with more than one hetero atom: Common examples of this class of compounds are pyridazine, pyrimidine, pyrazine etc (Figure 6).



**Figure 6.** Six member heterocyclic compounds with more than one hetero atom

3. Fused or condensed heterocyclic compounds: This class of compound may consist two or more fused rings which may be partly carbocyclic and partly heterocyclic, common examples of this category of heterocyclic compounds are Indole, Quinoline, Isoquinoline, Cabazole etc; or may be completely heterocyclic, common examples of this category of heterocyclic compounds are purine, pteridine etc (Figure 7).



**Figure 7.** Fused or condensed heterocyclic compounds

---

## 4.4 NOMENCLATURE OF HETEROCYCLIC COMPOUNDS

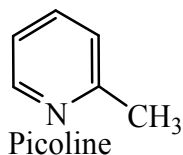
---

The nomenclature of heterocyclic compounds is divided into two categories, a) Trivial method of nomenclature and, b) Systematic method of nomenclature. However, most of the heterocyclic compounds are known by their common trivial names.

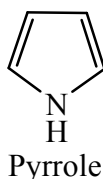
### 4.4.1 TRIVIAL METHOD OF NOMENCLATURE:

During the early days of organic chemistry, names of the heterocyclic organic compounds were given based on their occurrence, their first preparation and some characteristic properties.

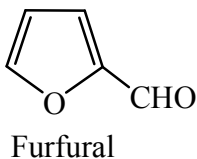
Heterocyclic compounds were named on the basis of their source from which the compound was obtained. Thus the name depended on the source of the compound. For example picoline; picoline is derived from coaltar. This is based on Latin word *pictus* means *tarry*.



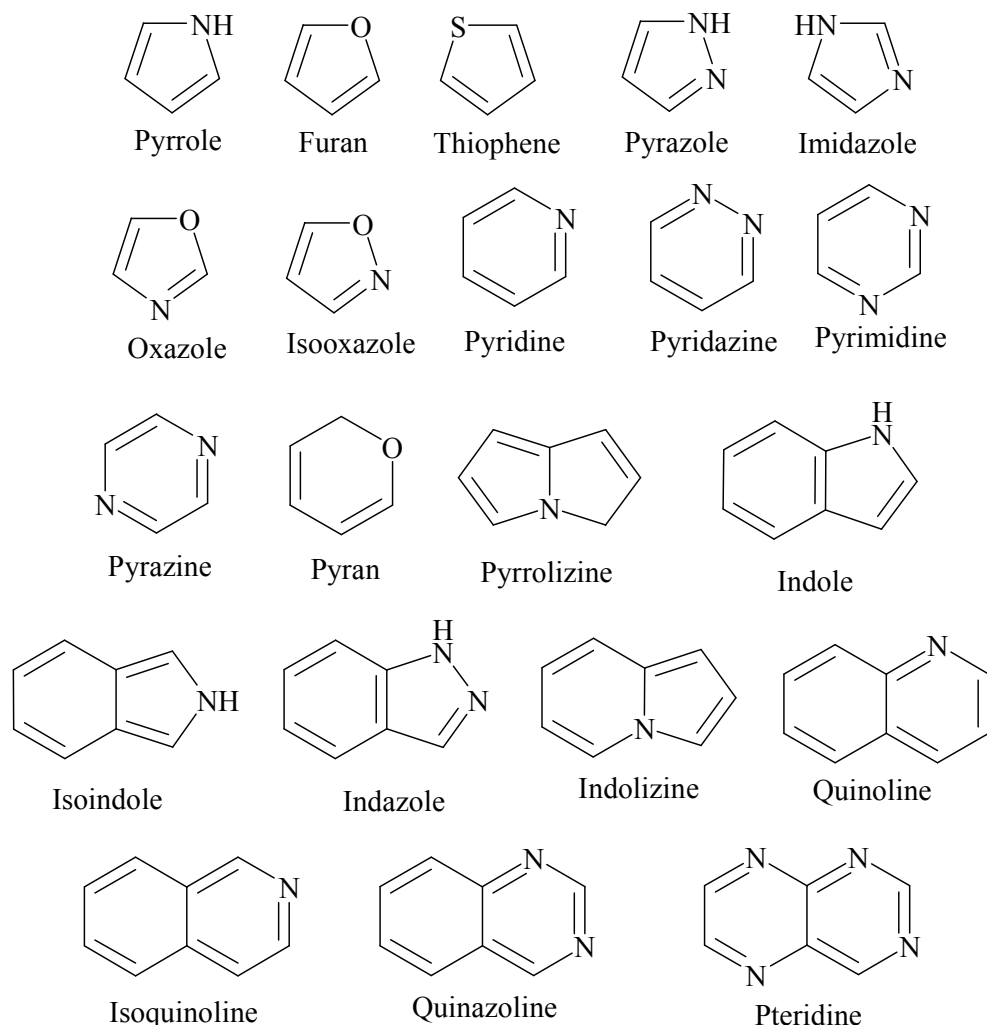
Heterocyclic compounds were also named on the basis of their characteristic properties. For example, pyrrole; which is basic in nature; the name of pyrrole was originated from the Greek word for fiery red because of characteristic colour which the compound gives with pine splint dipped in hydrochloric acid.



Similarly, the name Furfural is given based on its source. Furfural means barn oil. Furfural was isolated from the distillation of barn.



The trivial nomenclature was the first nomenclature method which has a significant role in the development of heterocyclic chemistry. However, this system has some disadvantages too. The trivial system does not give any structural information about the compound. At present just over 60 trivial names survive and recognized by IUPAC system of nomenclature. These recognized names are, however, significant because they are used as basis for constructing other compounds, more systematic names for polycyclic compounds and/or their derivatives. Examples of heterocyclic compounds with recognized trivial names are shown in figure 8.



**Figure 8.** Some heterocyclic compounds with recognized trivial names

#### 4.4.2 SYSTEMATIC METHOD OF NOMENCLATURE:

This is most widely used nomenclature system for monocyclic heterocyclic compounds especially for three to ten membered ring systems. These members have various degree of unsaturation containing one or more heteroatoms. The systematic nomenclature gives important structural information. The most relevant system that is recommended by IUPAC for nomenclature of heterocyclic compounds is the *Hantzsch-Widmann system* of nomenclature. This nomenclature system specifies the nature, position, ring size, number, and types of heteroatoms present in any heterocyclic compounds. This systematic method generally derived the nomenclature using the following syntax;



**Name: Prefix + Stem + Suffix**

Following are the important points to be remembered during the systematic nomenclature of heterocyclic compounds.

1. In this nomenclature the nomenclature of heterocyclic compounds are assigned by combining 'prefix' (that indicate the heteroatom present) with 'stem' (that indicate the ring size as well as the saturation and unsaturation in the ring) and 'suffixes'. The common prefixes are shown in Table 1. It should be noted that final 'a' is dropped when prefix is followed by vowel.
2. Nomenclature of heterocyclic compound starts with the heteroatom appears first in the table 1.
3. If more than two different heteroatoms are present in any heterocyclic compound the prefixes are listed in order in which they are appear in above table (Table 1).
4. If there are two or more than two hetero atoms of same types are present in a heterocyclic compound they are indicated by di-, tri- etc.
5. The position of saturated atom is numerically indicated with prefix '*H*-' as a part of the name of the ring system. It should be noted that where, there is a choice of numbering, the indicated position is given the lowest possible number.
6. The size of a monocyclic ring (three to ten membered rings) is indicated by stem. The common 'stem' nomenclature is given in Table 2.

**Table 1:** Common Prefix for Heteroatoms (arranged in the preferential order)

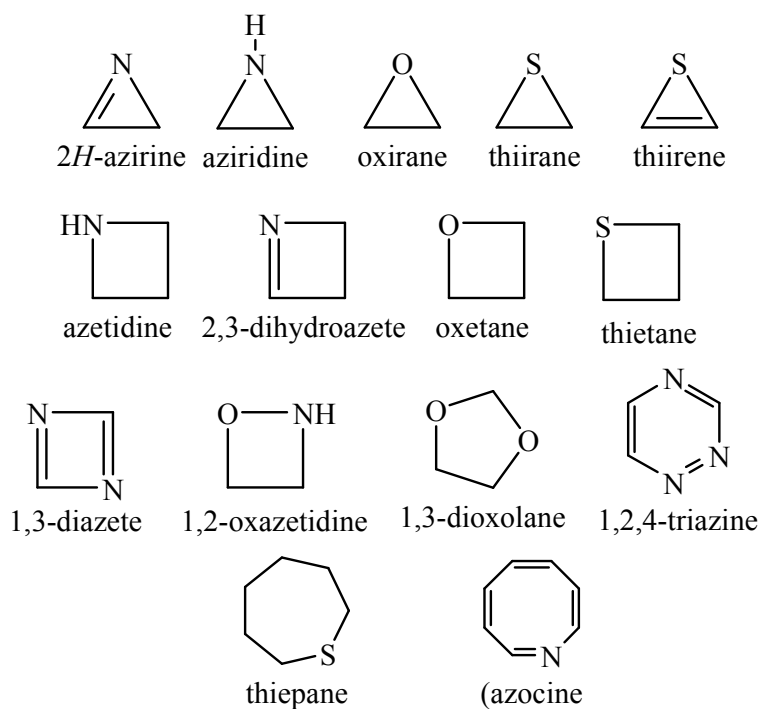
S. No.	Heteroatom	Symbol	Prefix
1	Oxygen	O	Oxa
2	Sulphur	S	Thia
3	Selenium	Se	Selena
4	Nitrogen	N	Aza
5	Phosphorous	P	Phospha
6	Arsenic	As	Arsa
7	Antimony	Sb	Stiba
8	Bismuth	Bi	Bisma
9	Silicon	Si	Silia

10	Tin	Sn	Stanna
11	Lead	Pb	Plumba
12	Boron	B	Bora
13	Mercury	Hg	Mercura

**Table 2:** Common Prefix for Heteroatoms (arranged in the preferential order)

S.No	Ring Size	Unsaturated Ring	Saturated Ring
1	3	iren	Irane
2	4	ete	Etane
3	5	ole	Olane
4	6	ine	Inane
5	7	epine	Epane
6	8	ocine	Ocane
7	9	onine	Onane
8	10	ecine	Ecane

Some examples of heterocyclic compounds with systematic nomenclature are shown in figure 9.

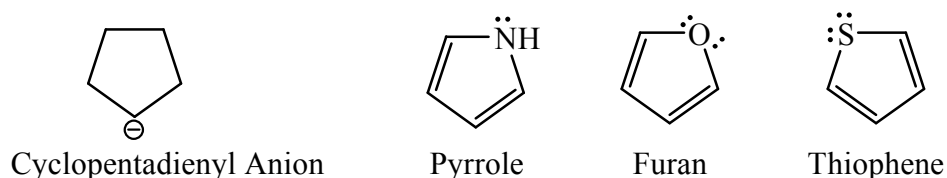
**Figure 9.** Examples of some heterocyclic compounds with systematic names

## 4.5 MOLECULAR ORBITAL PICTURE OF HETEROCYCLIC COMPOUNDS

Molecular orbital theory is widely used to interpret the structure of aromatic and hetero-aromatic compounds. According to Huckel approximation the electrons in the p-orbitals are treated separately from those electrons which are involved in the formation of the bonds in the plane of the ring. The six p-orbitals are combined to give six delocalized  $\pi$  molecular orbitals (3  $\pi$  bonding molecular orbitals and 3 antibonding  $\pi$  molecular orbitals). Each of the six  $\pi$ -molecular orbitals can accommodate a maximum of two electrons. The 3 bonding  $\pi$ -molecular orbitals are of lower energies than the 3 antibonding  $\pi$ -molecular orbitals. Thus the electrons will be filled in lower 3 bonding  $\pi$ -molecular orbitals first. We will be discussing here the  $\pi$ -molecular orbitals of pyrrole and pyridine as model compounds of five and six membered heterocyclic compounds.

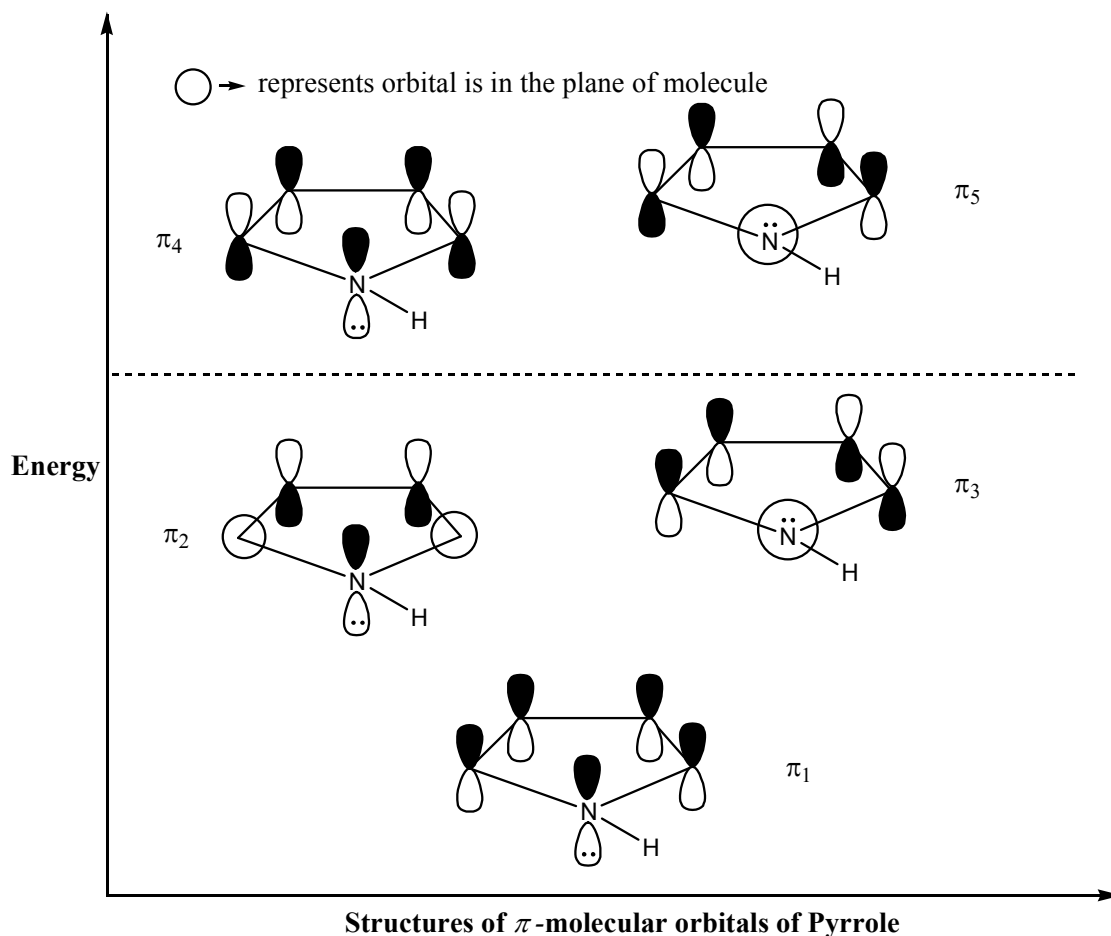
### 4.5.1 MOLECULAR ORBITAL PICTURE OF PYRROLE:

Five membered heterocyclic compounds with conjugated double bond can be considered as aromatic if the delocalization of  $\pi$  electrons is possible. Pyrrole, furan, thiophene etc are the most common examples of this class of compounds. These five membered heterocyclic compounds are structural homologue of cyclopentadienyl anion (Figure 10).



**Figure 10.** Examples of cyclopentadienyl anion structural homologue heterocyclic compounds

Pyrrole is the most fundamental member of this family. It is an aromatic compound with all 5  $sp^2$ - hybridized atoms. The lone pair of heteroatom (*e.g.* N in the case of pyrrole) participates in the delocalization and constitutes an aromatic compound with  $4n+2$   $\pi$  electrons (Huckel rule of aromaticity). The molecular orbital diagram of pyrrole is shown on figure 11.



**Figure 11.**  $\pi$ -Molecular orbital of Pyrrole

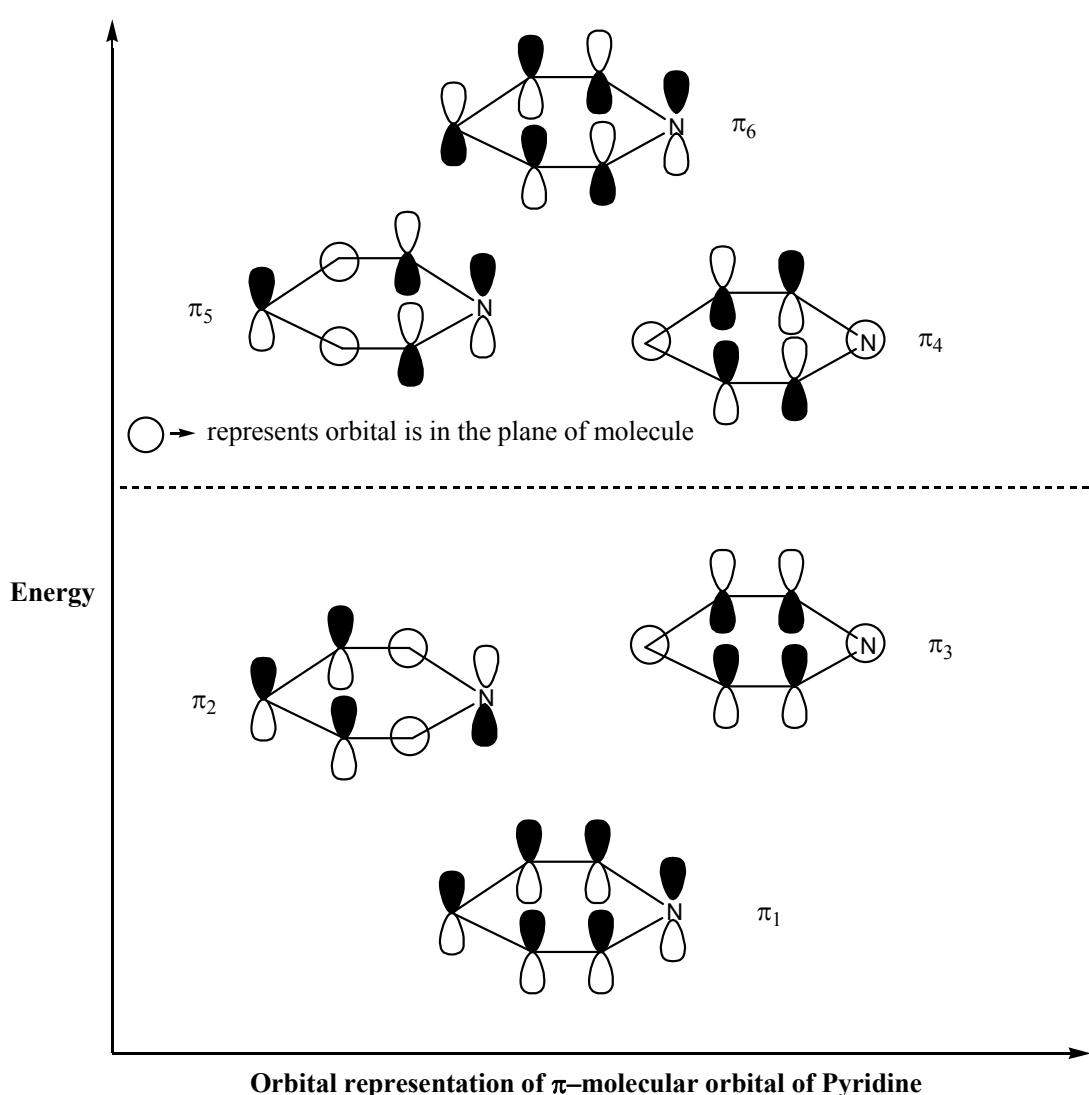
If we recall the  $\pi$ -molecular orbital of benzene that we have studied in undergraduate chemistry course of semester one; where you could see that the  $\pi$ -molecular orbitals of benzene follow the rule of degeneracy (set of orbitals with same energy, same symmetry and similar orientation). However, the introduction of heteroatom by replacement of ring carbon leads the formation of non-degenerated set of  $\pi$ -molecular orbital. For example, we can see from the figure 11, splitting of the  $\pi_2$  and  $\pi_3$  levels; the orbital  $\pi_2$  has a large orbital coefficient on nitrogen (due to more electro negativity of nitrogen than carbon) and thus lower in energy than  $\pi_3$ . The  $\pi_3$  molecular orbital, in which the lone pair of the nitrogen atom lies on the perpendicular plane of the  $p$ -orbitals of ring carbon atoms helps to create two nodal points, hence, do not participate in the formation of ring current. Thus the nitrogen atom of  $\pi_3$  has less orbital coefficient that  $\pi_2$ . In the five membered heterocyclic compounds six- $\pi$  electron are distributed over five atoms therefore the carbon atoms of such heterocyclic compounds have more electron density than that of

benzene. Among the five constituting atoms of pyrrole, the nitrogen has maximum electron density than four carbon atoms this is because of the more electro-negativity of nitrogen.

Similar description may also be made for the other five membered heterocyclic compounds like Furan and Thiophene.

#### 4.5.2 MOLECULAR ORBITAL PICTURE OF PYRIDINE:

Six membered heterocyclic compounds (with one heteroatom) are structural analogous to that of benzene but with a heteroatom replacing one of the carbon atom of the benzene ring. Pyridine is the most common example of this class of heterocyclic compounds. Pyridine is a planar molecule like benzene, since all the carbon atoms and nitrogen atom of the pyridine are of  $sp^2$ -hybridized. The lone pair of electrons of nitrogen atom lies in the plane of the ring. Pyridine is also an aromatic compound with  $(4n+2) \pi$ -electrons (Huckel rule of aromaticity). The molecular



orbitals of pyridine is shown on figure 12.

**Figure 12.**  
 $\pi$ -Molecular orbitals of

## Pyridine

The six p-orbitals are combined together to give six delocalized  $\pi$ -molecular orbitals. Each  $\pi$ -molecular orbital can contain two electrons. Out of six  $\pi$ -molecular orbitals three are called bonding  $\pi$ -molecular orbital and three are called antibonding  $\pi$ -molecular orbital. All six  $\pi$ -electrons are accommodated by three bonding  $\pi$ -molecular orbital. Similar to pyrrole, the  $\pi$ -molecular orbital of pyridine also have lower energy in comparison to benzene, this is because of the presence of nitrogen atom in place of a ring carbon. As already discussed in the previous section that the due to more electro-negativity of nitrogen than carbon the electron density at nitrogen atom is greater than the carbon, thus nitrogen have comparatively larger orbital coefficient than carbon, therefore, the  $\pi$ -molecular orbital of pyridine are of lower energy than that of benzene. Similar to pyrrole, in pyridine also the introduction of heteroatom by replacement of ring carbon leads the formation of non-degenerated set of  $\pi$ -molecular orbital. For example, we can see from the figure 12, splitting of the  $\pi_2$  and  $\pi_3$  levels; the orbital  $\pi_2$  has a large orbital coefficient on nitrogen (due to more electro negativity of nitrogen than carbon) and thus lower in energy than  $\pi_3$  (figure 12).

---

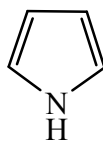
## ***4.6 STRUCTURE AND AROMATICITY OF PYRROLE, FURAN, THIOPHENE AND PHRIDINE***

---

### **4.6.1 STRUCTURE AND AROMATICITY OF PYRROLE:**

Structure and aromaticity of pyrrole can be discussed according to following points.

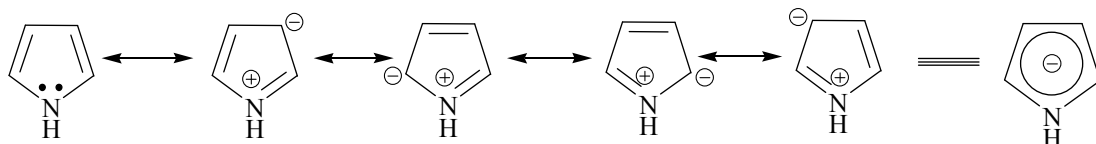
1. The molecular weight determination method and related analytical studies revealed that the molecular formula of Pyrrole would be  $C_4H_5N$ .
2. The possible structure of pyrrole can be given by considering the tetravalency of carbon and trivalency of nitrogen, and it is shown below



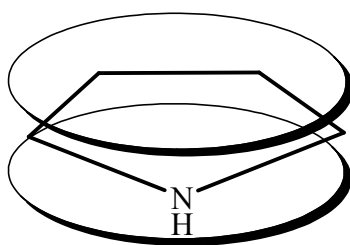
Pyrrole

3. Pyrrole usually does not explain the simple addition reactions like alkenes under normal conditions. This is because of the delocalization of lone pair of nitrogen atom through conjugation. This delocalization provides extra stability to the double bonds of pyrrole.

Also the proposed structure of pyrrole is considered as an aromatic compound since it follows the Huckel's aromaticity rules ( $4n+2$  electron rule). The aromatic nature and extra-stability of pyrrole can also be supported by the formation of its different resonating structures as shown in below figure. The structure of pyrrole is the resonance hybrid of all resonating structures.



4. The delocalization of lone pair of nitrogen in pyrrole through conjugation also suggests that the pyrrole molecule should have planar geometry. This is only possible when the orbitals of carbon and nitrogen in pyrrole are  $sp^2$ - hybridized. The three  $sp^2$ - hybridized orbitals of nitrogen contain one- one electron in each  $sp^2$ - hybridized orbital. The unhybridized  $p$ -orbital of nitrogen contains lone pair of electrons. Two  $sp^2$ - hybridized orbitals of nitrogen atom forms  $\sigma$ -bond with two carbon atoms of the ring whereas the third  $sp^2$ - hybridized orbital of nitrogen atom forms  $\sigma$ -bond with hydrogen atom. Similarly each  $sp^2$ - hybridized carbon forms two  $\sigma$ -bonds with neighboring carbon atoms and one  $\sigma$ -bond with hydrogen atom. The unhybridized orbitals of each carbon contain one electron. These unhybridized orbitals of carbon and nitrogen form a delocalized electron cloud above and below the pentagonal ring of pyrrole. The delocalized electron cloud is shown in figure 13.



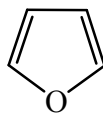
**Figure 13.** Delocalized electron cloud above and below the pyrrole ring

#### 4.6.2 STRUCTURE AND AROMATICITY OF FURAN:

Structure and aromaticity of furan can be discussed according to following points.

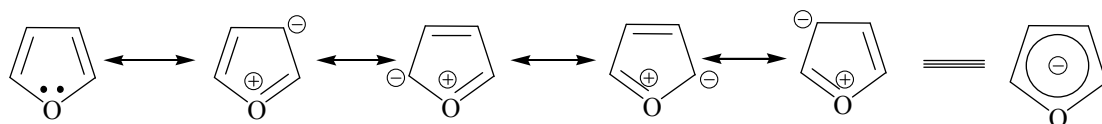
1. The molecular weight determination method and related analytical studies revealed that the molecular formula of Furan would be  $C_4H_4O$ .

2. The possible structure of Furan can be given by considering the tetravalency of carbon and bivalency of oxygen, and it is shown below



Furan

3. Like Pyrrole, due to delocalization of one of the lone pair of electron of oxygen in furan, it also does not explain the fundamental addition reactions like simple alkenes under normal condition. The proposed structure of furan is also considered as an aromatic compound since it follows the Huckel's aromaticity rules ( $4n+2$  electron rule). The aromatic nature and extra-stability of furan is also supported by the formation of its different resonating structures as shown in below figure. The structure of furan is the resonance hybrid of all resonating structures.



4. The delocalization of lone pair of oxygen in furan through conjugation also suggests that the furan molecule should have planar geometry. This is only possible when the orbitals of carbon and oxygen in furan are  $sp^2$ - hybridized. The two  $sp^2$ - hybridized orbitals of oxygen contain one- one electron in each  $sp^2$ - hybridized orbital; however, third  $sp^2$ - hybridized orbital contains one lone pair of electron. The unhybridized  $p$ -orbital of oxygen contains two electrons. Two  $sp^2$ - hybridized orbitals of oxygen atom forms  $\pi$  - bond with two carbon atoms of the ring, whereas the third  $sp^2$ - hybridized orbital of oxygen atom accommodate lone pair of electron. Similarly each  $sp^2$ - hybridized carbon forms two  $\pi$  -bonds with neighboring atoms and one  $\pi$  -bond with hydrogen atom. The unhybridized orbitals of each carbon contain one electron. These unhybridized orbitals of carbon and oxygen form a delocalized electron cloud above and below the pentagonal ring of furan. The delocalized electron cloud is shown in figure 14.



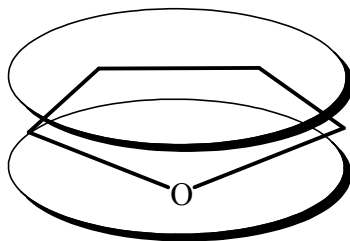
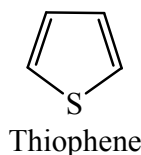


Figure 14. Delocalized electron cloud above and below the furan ring

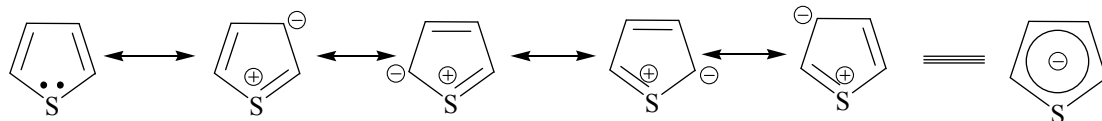
### 4.6.3 STRUCTURE AND AROMATICITY OF THIOPHENE:

Structure and aromaticity of Thiophene can be discussed according to following points.

1. The molecular weight determination method and related analytical studies revealed that the molecular formula of Thiophene would be  $C_4H_4S$ .
2. The possible structure of Thiophene can be given by considering the tetravalency of carbon and bivalency of sulphur, and it is shown below

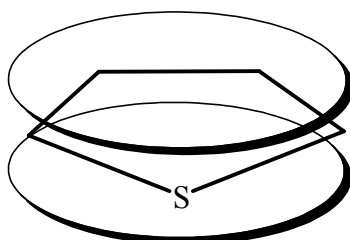


3. Like Pyrrole, due to delocalization of one of the lone pair of electron of oxygen in thiophene, it also does not explain the fundamental addition reactions like simple alkenes under normal condition. The proposed structure of thiophene is also considered as an aromatic compound since it follows the Huckel's aromaticity rules ( $4n+2$  electron rule). The aromatic nature and extra-stability of thiophene is also supported by the formation of its different resonating structures as shown in below figure. The structure of thiophene is the resonance hybrid of all resonating structures.



4. The delocalization of lone pair of sulphur in furan through conjugation also suggests that the thiophene molecule should have planar geometry. This is only possible when the orbitals of carbon and sulphur in thiophene are  $sp^2$ - hybridized. The two  $sp^2$ - hybridized orbitals of sulphur contain one- one electron in each  $sp^2$ - hybridized orbital; however, third  $sp^2$ - hybridized orbital contains one lone pair of electron. The unhybridized  $p$ -orbital of sulphur contains two electrons. Two  $sp^2$ - hybridized orbitals of sulphur atom forms  $\pi$  -

bond with two carbon atoms of the ring, whereas the third  $sp^2$ - hybridized orbital of sulphur atom accommodate lone pair of electron. Similarly each  $sp^2$ - hybridized carbon forms two  $\pi$  -bonds with neighboring atoms and one  $\pi$  -bond with hydrogen atom. The unhybridized orbitals of each carbon contain one electron. These unhybridized orbitals of carbon and sulphur form a delocalized electron cloud above and below the pentagonal ring of thiophene. The delocalized electron cloud is shown in figure 15.



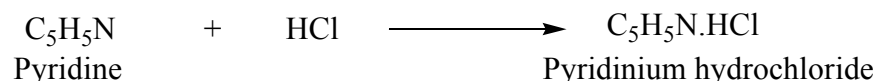
**Figure 15.** Delocalized electron cloud above and below the thiophene ring

#### 4.6.4 STRUCTURE AND AROMATICITY OF PYRIDINE:

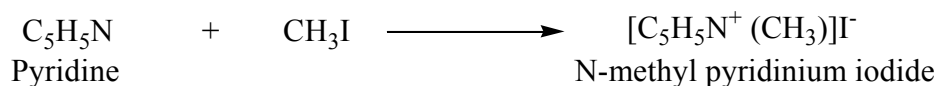
Structure and aromaticity of Thiophene can be discussed according to following points.

1. The molecular weight determination method and related analytical studies revealed that the molecular formula of Pyridine as  $C_5H_5N$ .

2. Pyridine was found to be basic in nature since it forms salt with acids



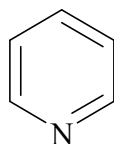
3. Pyridine does not react with acetyl chloride and nitrous acid it confirms that pyridine does not have primary or secondary amino group. The above fact also confirms that the pyridine is a mono-acidic tertiary base.
4. Pyridine also reacts with equimolar amount of methyl iodide to form a quaternary ammonium salt.



5. The molecular formula also indicates that it is a highly unsaturated compound; however, pyridine does not give the simple addition reactions like alkenes.
6. Pyridine is also found stable towards the oxidizing agents.
7. Pyridine exhibits aromatic character like benzene and give electrophilic substitution reactions such as halogenation, nitration and sulphonation.

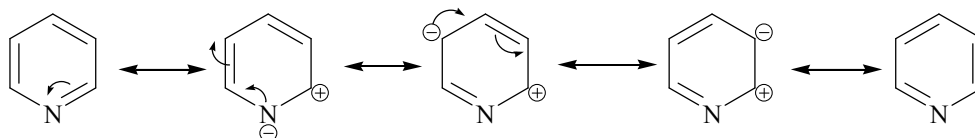
Last two reactions confirm the aromatic character of pyridine.

8. Based on above observations the possible structure of Pyridine can be given by considering the tetravalency of carbon and trivalency of nitrogen, and it is shown below



pyridine

This structure is considered to be the resonance hybrid of the following structures.



Resonance in pyridine molecule is supported by the following points:

- i. All the carbon, nitrogen and hydrogen atoms lie in the same plane all the carbon and nitrogen atoms of pyridine are  $sp^2$  hybridized.
  - ii. Each  $sp^2$ - hybridized carbon forms two  $\pi$  -bonds with neighboring atoms and one  $\sigma$ -bond with hydrogen atom.
  - iii. The unhybridized p-orbital of each carbon atom is involved to form the  $\pi$ -bond with neighboring atoms.
  - iv. The two of three  $sp^2$ - hybridized orbitals of nitrogen contain one- one electron in each  $sp^2$ - hybridized orbital; however, the third  $sp^2$ - hybridized orbital of nitrogen contains lone pair of electron. The unhybridized p orbital of nitrogen contains one electron which is involved to form  $\pi$  -bond with any of the neighboring carbon atoms.
  - v. All the carbon-carbon bonds in pyridine are of equal length (*i.e.* 1.39 Å).
  - vi. The carbon-nitrogen bonds are also of equal length (1.37 Å).
  - vii. These properties resist the pyridine from simple addition reaction of C=C double bond. Since in pyridine there is no true C=C double bond.
  - viii. The resonating structures represent that the more electron density at C-3, hence electrophilic substitution in pyridine takes place at C-3.
9. The delocalized electron cloud in pyridine is shown in figure 16.

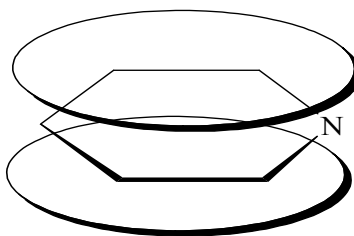


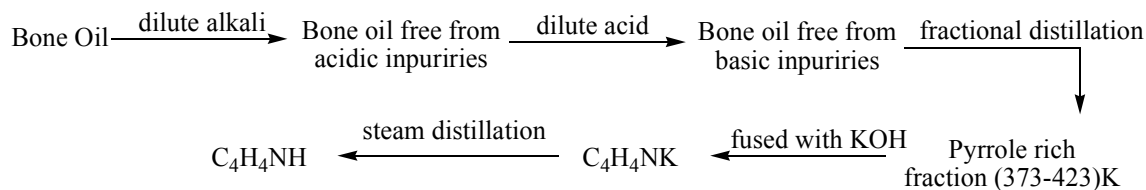
Figure 16. Delocalized electron cloud above and below the pyridine ring

## 4.7 METHODS OF PREPARATION AND CHEMICAL REACTIONS

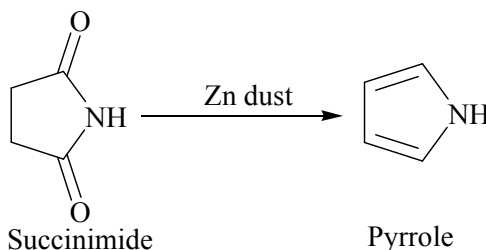
### 4.7.1 METHODS OF PREPARATION OF PYRROLE:

Following are the general methods of preparation of pyrrole:

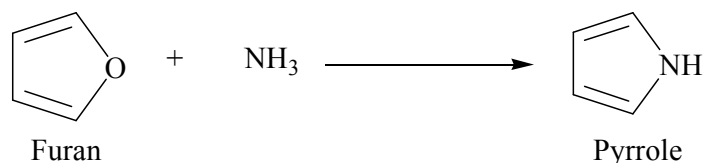
- i. **From bone oil:** Bone oil is rich of pyrrole. The basic and acidic impurities of Bone oil are removed by sequential treatment of it with dilute acidic and dilute basic solutions. The treated Bone oil is then subjected for fractional distillation, the fraction obtained between 373K and 423K is collected. The collected fraction is then purified with KOH to obtained potassipyrrole. Steam distillation of potassipyrrole gives pure pyrrole.



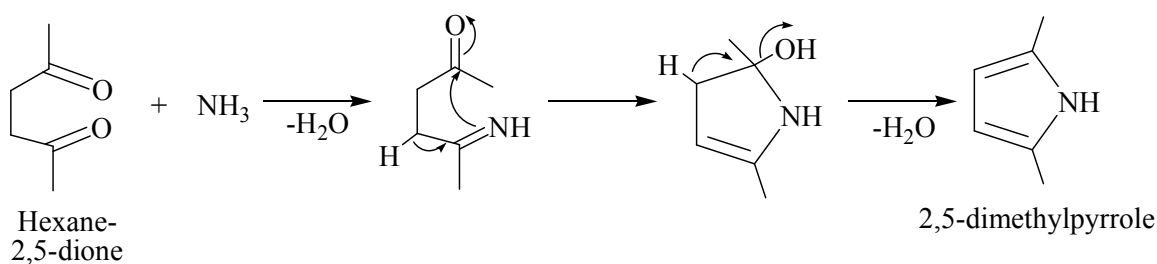
- ii. **From succinimide:** Succinimide when is distilled with Zn dust it reduces the succinimide to pyrrole.



- iii. **From Furan:** Industrially pyrrole is prepared by passing a mixture of furan and ammonia over alumina over 400° C.



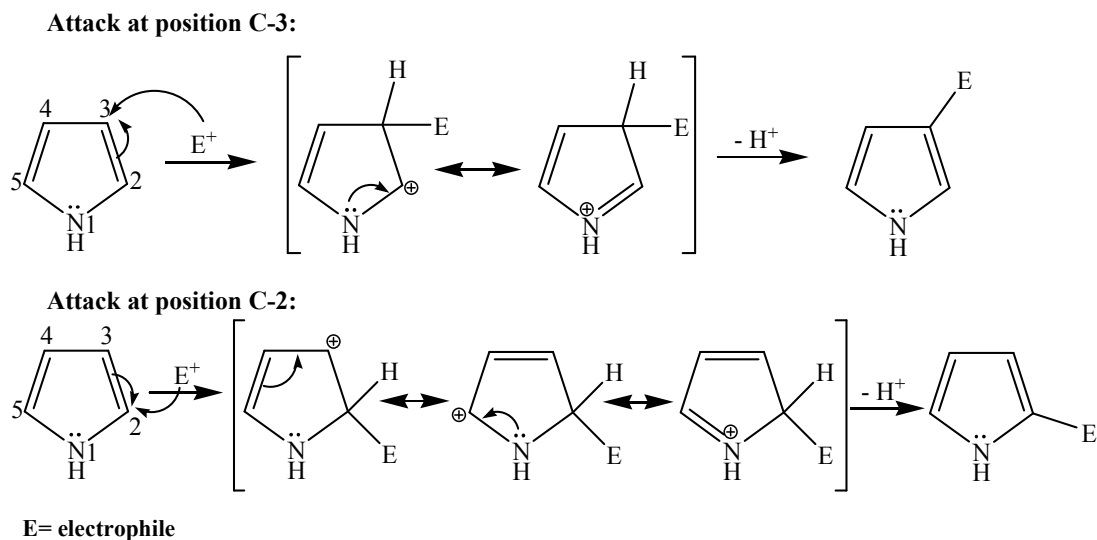
iv. **Pall-Knorr synthesis:** In this method, when a 1,4-diketone is heated with ammonia or a primary amine it gives the corresponding pyrrole derivatives.



#### 4.7.2 PROPERTIES OF PYRROLE:

- i. **Physical Properties of pyrrole:** Pyrrole is a colorless liquid with boiling point 131° C. It is highly sensitive to air, when pyrrole is exposed to air it turns brown and gradually resinifies. Pyrrole is slightly soluble in water but completely miscible in ether and ethanol.
- ii. **Chemical Properties:** Pyrrole is an aromatic compound and more reactive than benzene. Because of the aromatic nature pyrrole gives all characteristic reactions (electrophilic substitution reactions) of aromatic compounds such as halogenation, nitration, sulphonation, Friedel-Crafts reactions etc.

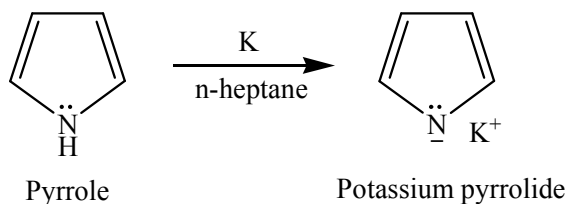
Pyrrole undergoes electrophilic substitution at the position C-2. Approach of the electrophile at position C-2 leads the formation of three resonating structures; however, only two resonating structures are obtained when the electrophile approaches at position C-3. Thus the intermediate obtained by the approach of electrophile at position C-2 is more stable than the intermediate obtained by the approach of electrophile at position C-3. This is the reason that electrophilic attack occurs at position C-2. Following mechanism is suggested for the electrophilic attack at position C-2.



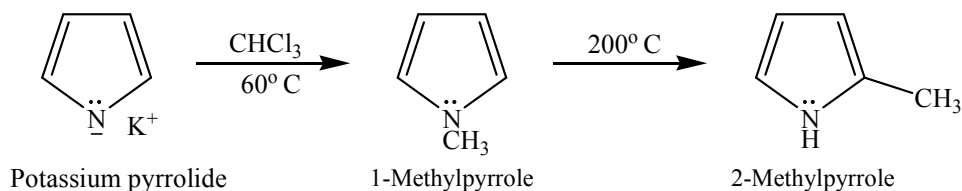
All the electrophilic substitution reactions of pyrrole occur at position C-2 and follow the similar mechanism as shown above.

- a) **Acidic Character of Pyrrole:** The lone pair of nitrogen usually participates in resonance and thus makes the pyrrole aromatic. That is the reason, the lone pair of nitrogen could not be available free to react with a proton.

However, pyrrole can behave as a weak acid. When pyrrole is heated with potassium in *n*-heptane as solvent, stable potassium pyrrolide is formed.

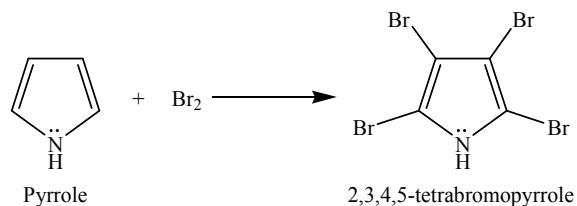


Potassium pyrrolide when reacts with alkyl halide at 60° C to give *N*-alkyl pyrrole. The *N*-alkyl pyrrole can easily rearrange to C-alkyl pyrrole.

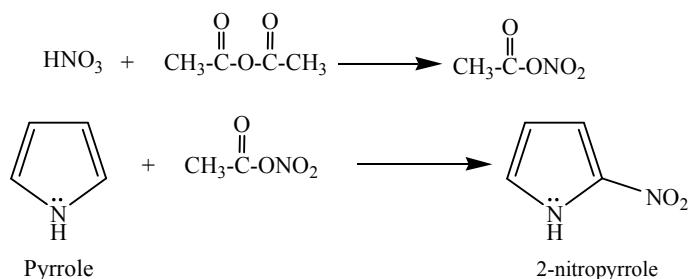


- b) **Electrophilic Substitution Reactions of Pyrrole:** Pyrrole undergoes electrophilic substitution reactions at position C-2.

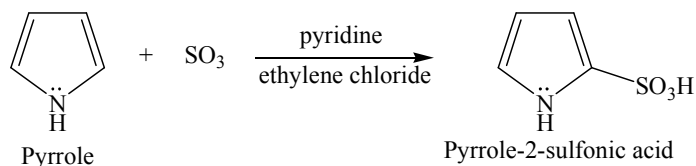
**i. Halogenation:** Pyrrole reacts with halogens [ $X_2$  ( $X_2 = Cl_2, Br_2$  and  $I_2$ )] to give tetrahalopyrrole. For example, Reaction of bromine with pyrrole gives tetrabromopyrrole.



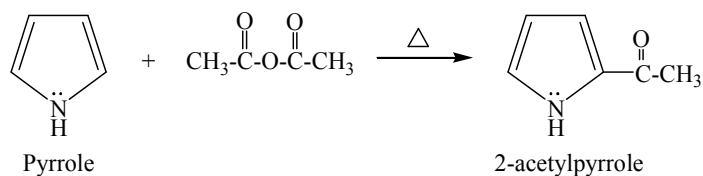
**ii. Nitration:** Nitration of pyrrole is achieved by reacting it with HNO<sub>3</sub> in acetic anhydride. The reaction of HNO<sub>3</sub> and acetic anhydride resulted acetyl nitrate in which –NO<sub>2</sub> acts as an electrophile.



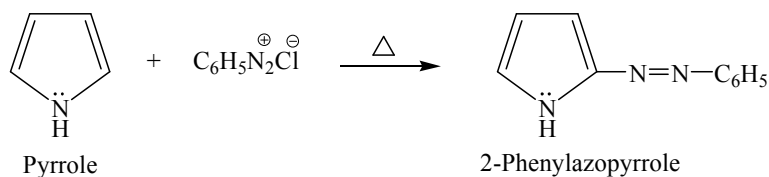
**iii. Sulphonation:** Sulphonation of pyrrole is achieved by reacting it with sulfur trioxide (SO<sub>3</sub>) – pyridine mixture in ethylene chloride.



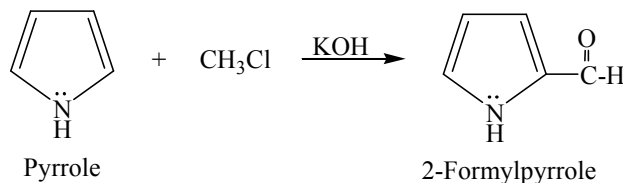
**iv. Friedel-Crafts Acylation:** Reaction of pyrrole with acetic anhydride under heating condition gives 2-acetylpyrrole.



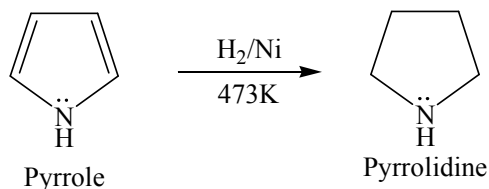
**v. Diazotization:** Pyrrole reacts with benzenediazonium chloride in acidic medium to give 2-phenylazopyrrole.



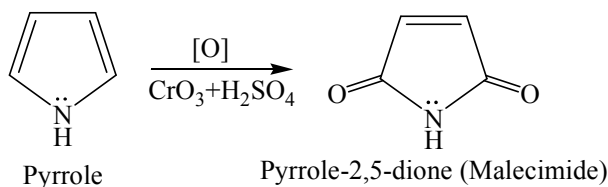
**vi. Reimer-Tiemann Reaction:** Pyrrole reacts with Chloroform in presence of KOH to give 2-Formylpyrrole. This reaction is known as Reimer-Tiemann reaction. It also takes place through electrophilic substitution reaction mechanism.



**c) Reduction:** Pyrrole can be reduced to pyrrolidine (tetrahydropyrrole) by  $\text{H}_2$  gas in Raney Ni at very high temperature (473K).



**d) Oxidation:** Pyrrole when oxidized with Chromium trioxide in  $\text{H}_2\text{SO}_4$ , it gives Malecimide.

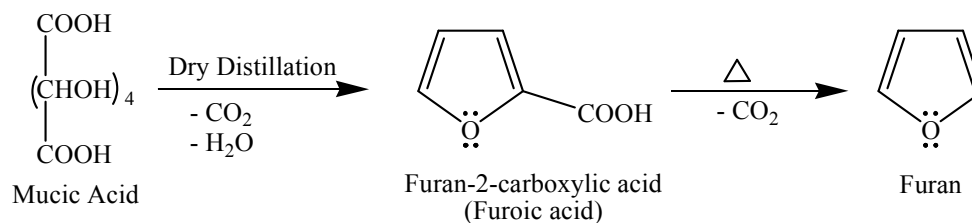


### 4.7.3 METHODS OF PREPARATION OF FURAN:

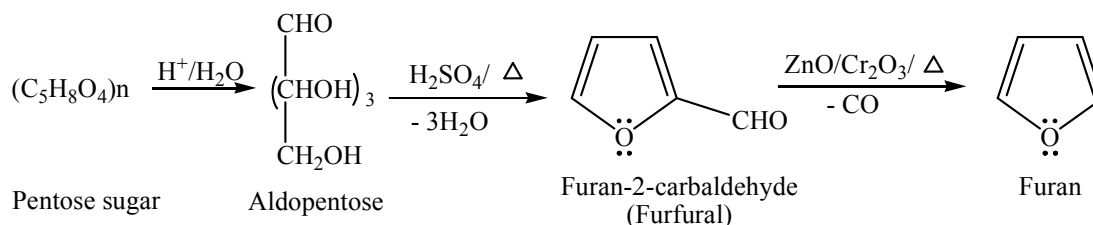
Following are the general methods of preparation of Furan:

**i. From Mucic acid:** Dry distillation of mucic acid first gives Furoic acid which on decarboxylation by heating gives Furan.

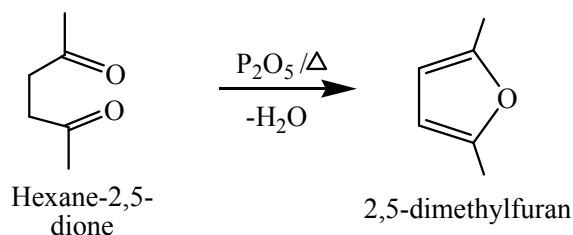




- ii. **From Furfural:** Furan is synthesized from furfural which is obtained by acid-hydrolysis of pentose sugars.



- iii. **Paal-Knorr Synthesis:** Dehydration of 1,4-diketone with  $\text{P}_2\text{O}_5$  (phosphorous Pentaoxide) gives derivatives of Furan.



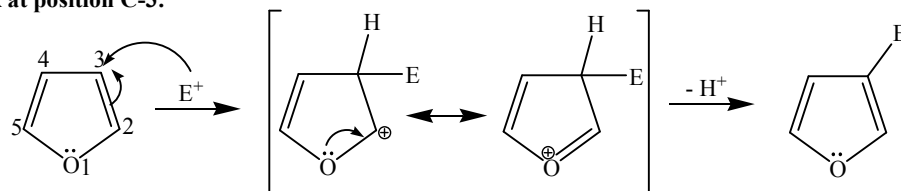
#### 4.7.4 PROPERTIES OF FURAN:

- i. **Physical Properties of Furan:** Furan is colorless liquid. Its boiling point is  $31.4^\circ \text{C}$ . It has an odor similar to Chloroform. It is insoluble in ether but soluble in most of the organic solvents.
- ii. **Chemical Properties of Furan:** furan is an aromatic compound and more reactive than benzene. Because of the aromatic nature, furan gives all characteristic reactions (electrophilic substitution reactions) of aromatic compounds such as halogenation, nitration, sulphonation, Friedel-Crafts reactions etc.

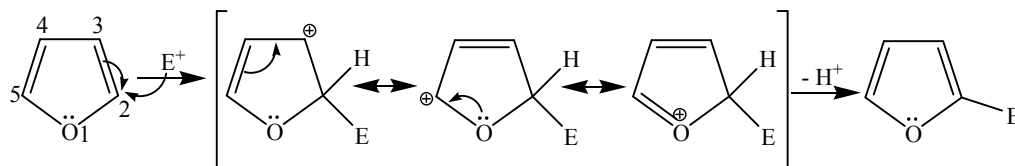
Similar to pyrrole, furan also undergoes electrophilic substitution at the position C-2. Approach of the electrophile at position C-2 leads the formation of three resonating structures; however, only two resonating structures are obtained when the electrophile approaches at position C-3. Thus the intermediate obtained by the approach of electrophile at position C-2 is more stable than the intermediate obtained by the approach of electrophile at position C-3. This is the reason

that electrophilic attack occurs at position C-2. Following mechanism is suggested for the electrophilic attack at position C-2.

**Attack at position C-3:**



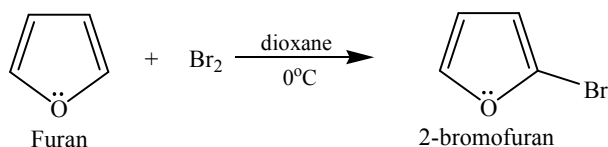
**Attack at position C-2:**



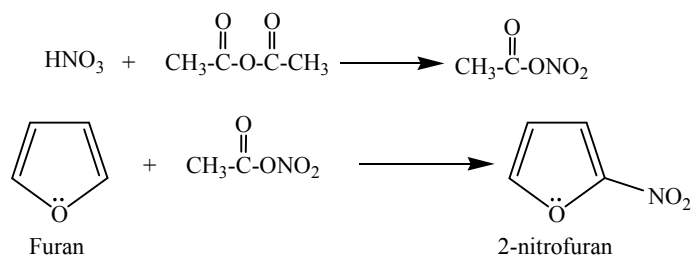
E= electrophile

**a) Electrophilic Substitution Reactions of Furan:** Furan undergoes electrophilic substitution reactions at position C-2.

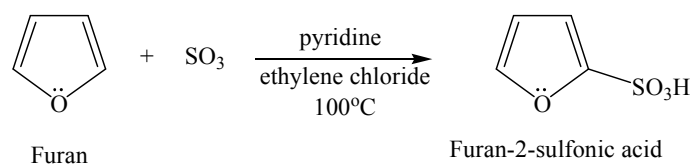
**i. Halogenation:** Furan reacts with halogens [ $X_2$  ( $X_2 = Cl_2, Br_2$  and  $I_2$ )] to give 2-halofuran. For example, reaction of bromine with Furan gives 2-bromofuran.



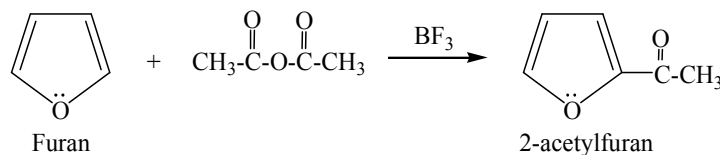
**ii. Nitration:** Nitration of furan is achieved by reacting it with  $HNO_3$  in acetic anhydride. The reaction of  $HNO_3$  and acetic anhydride resulted acetyl nitrate in which  $-NO_2$  acts as an electrophile.



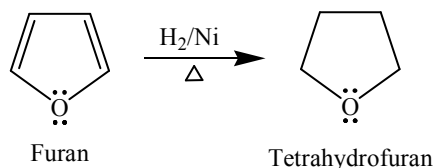
**iii. Sulphonation:** Sulphonation of Furan is achieved by reacting it with sulfur trioxide ( $SO_3$ ) – pyridine mixture in ethylene chloride at  $100^\circ C$ .



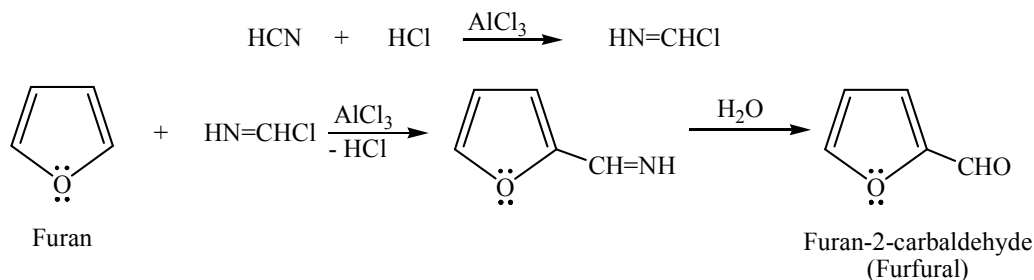
iv. **Friedel-Crafts Acylation:** Reaction of furan with acetic anhydride in presence of  $\text{BF}_3$  gives 2-acetylfuran.



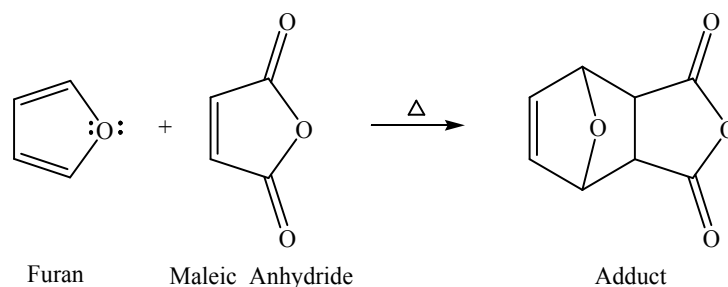
b) **Reduction:** On catalytic hydrogenation of furan, the tetrahydrofuran (THF) is obtained. THF is used as a solvent in place of ether in the Grignard reactions.



c) **Gattermann Koch Synthesis:** When furan is treated with a mixture of HCN and HCl in the presence of Lewis acid catalyst  $\text{AlCl}_3$ , furfural is obtained as final product.



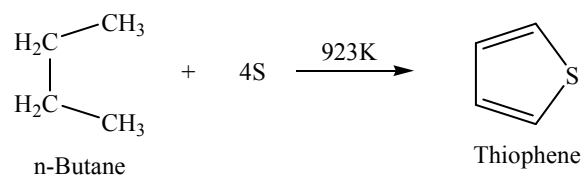
d) **Diels-Elder Reaction:** Furan is the only heterocyclic compound which undergoes Diels-Elder reaction. Diels-Elder reaction is a cycloaddition reaction of  $4\pi$ -system to  $2\pi$ -system.



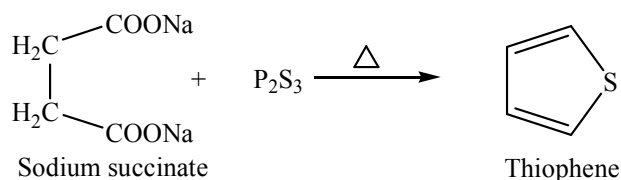
#### 4.7.5 METHODS OF PREPARATION OF THIOPHENE:

Following are the general methods of preparation of thiophene

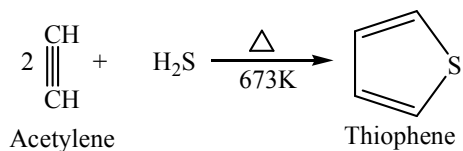
i. **From *n*-Butane:** Thiophene is obtained when *n*-butane is heated with elemental sulphur at very high temperature (923K).



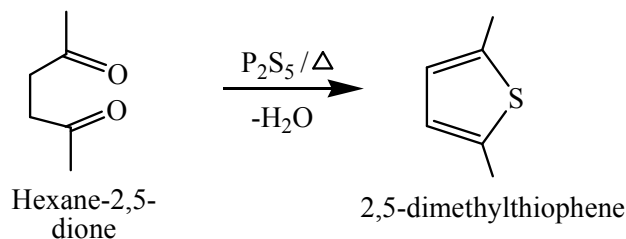
ii. **Laboratory Method:** When sodium succinate is heated with phosphorous sulphide, thiophene is obtained.



iii. **Industrial Method:** Industrially, thiophene is prepared by passing a mixture of acetylene and hydrogen sulphide through a tube containing alumina ( $\text{Al}_2\text{O}_3$ ) at 673K.



iv. **Pall-Knorr synthesis of thiophene derivatives:** In this method, dehydration of 1,4-diketone with  $\text{P}_2\text{S}_5$  (phosphorous Pentasulphide) gives derivatives of thiophene.



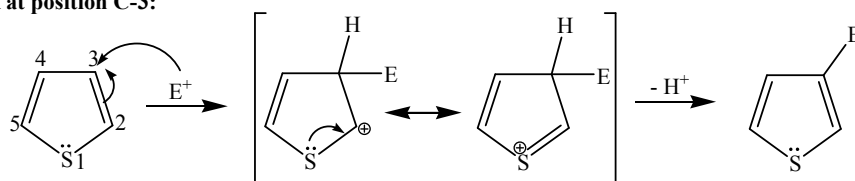
#### 4.7.6 PROPERTIES OF THIOPHENE:

- i. **Physical Properties of thiophene:** Thiophene is colorless liquid. Boiling point of thiophene is 357 K. It smells like benzene. It is soluble in alcohol and ether but insoluble in water.
- ii. **Chemical Properties of thiophene:** Thiophene is an aromatic compound and more reactive than benzene. Because of the aromatic nature, thiophene gives all characteristic reactions (electrophilic substitution reactions) of aromatic compounds such as halogenation, nitration, sulphonation, Friedel-Crafts reactions etc.

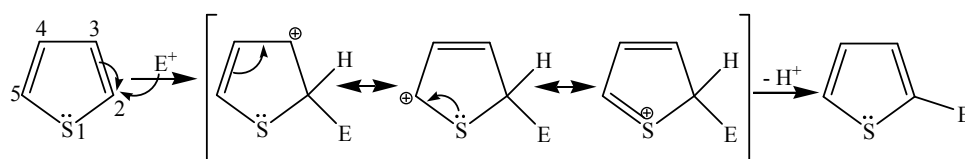
Similar to pyrrole and furan; thiophene also undergoes electrophilic substitution at the position C-2. Approach of the electrophile at position C-2 leads the formation of three resonating

structures; however, only two resonating structures are obtained when the electrophile approaches at position C-3. Thus the intermediate obtained by the approach of electrophile at position C-2 is more stable than the intermediate obtained by the approach of electrophile at position C-3. This is the reason that electrophilic attack occurs at position C-2. Following mechanism is suggested for the electrophilic attack at position C-2.

Attack at position C-3:



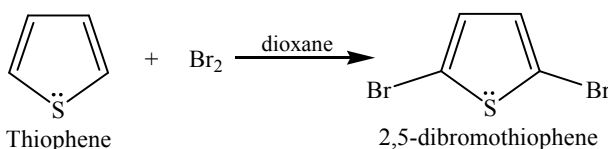
Attack at position C-2:



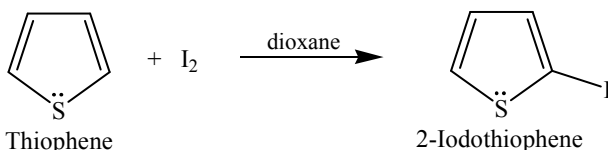
E = electrophile

**a) Electrophilic Substitution Reactions of Thiophene:** Thiophene undergoes electrophilic substitution reactions at position C-2.

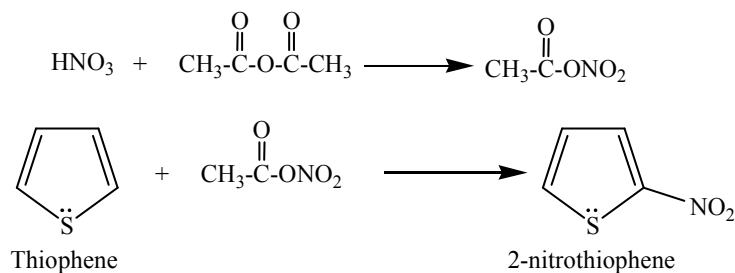
**i. Halogenation:** Thiophene reacts with halogens [ $X_2$  ( $X_2 = Cl_2, Br_2$  and  $I_2$ )] to give 2-halofuran. For example, reaction of bromine with Thiophene in absence of any halogen carrier gives 2,5-dibromothiophene.



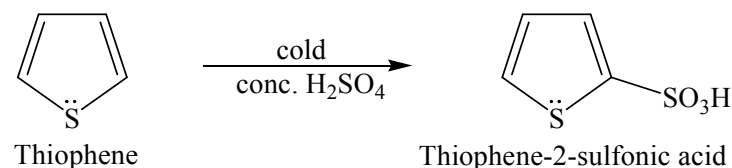
However, Iodination of thiophene in presence of yellow mercuric oxide gives 2-iodothiophene.



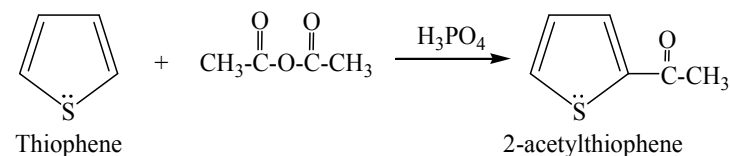
**ii. Nitration:** 2-Nitrothiophene is obtained when nitration of thiophene is performed by reacting it with fuming  $HNO_3$  in acetic anhydride. The reaction of  $HNO_3$  and acetic anhydride resulted acetyl nitrate in which  $-NO_2$  acts as an electrophile.



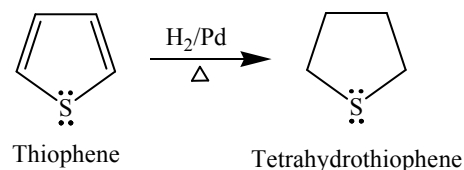
**iii. Sulphonation:** Sulphonation of thiophene is achieved by reacting it with cold concentrated  $\text{H}_2\text{SO}_4$ . Thiophene-2-sulphonic acid is obtained as product.



**iv. Friedel-Crafts Acylation:** Reaction of thiophene with acetic anhydride in presence of  $\text{H}_3\text{PO}_4$  gives 2-acetylthiophene.



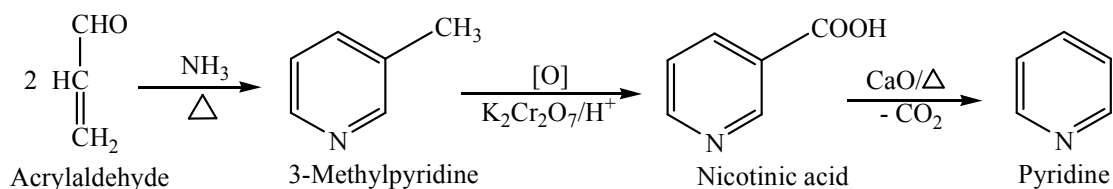
**b) Reduction:** On catalytic hydrogenation of thiophene, the tetrahydrothiophene (Thiophane) is obtained.



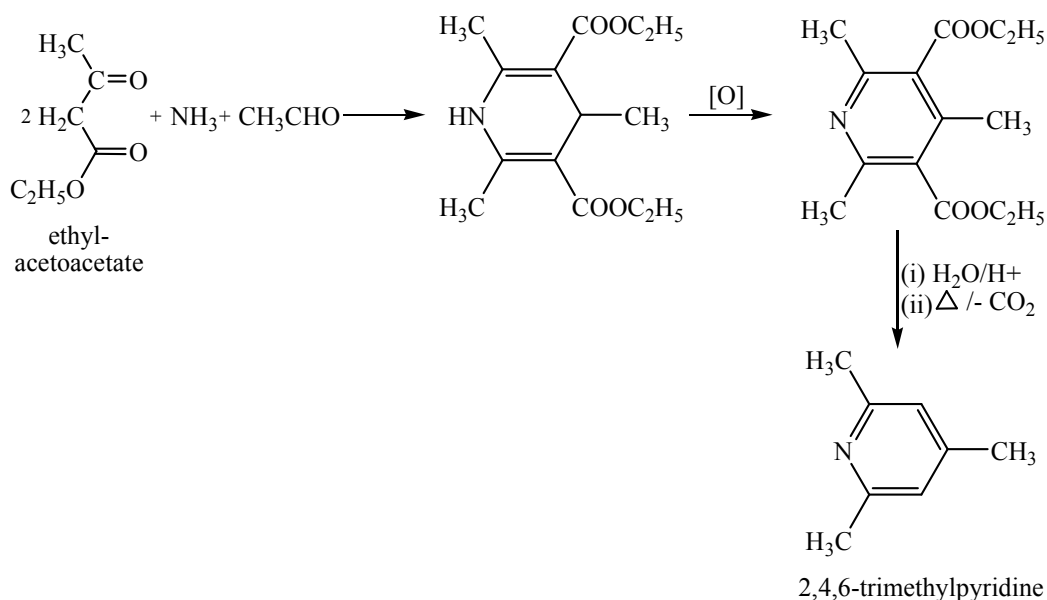
#### 4.7.7 METHODS OF PREPARATION OF PYRIDINE:

Following are the general methods of preparation of pyridine:

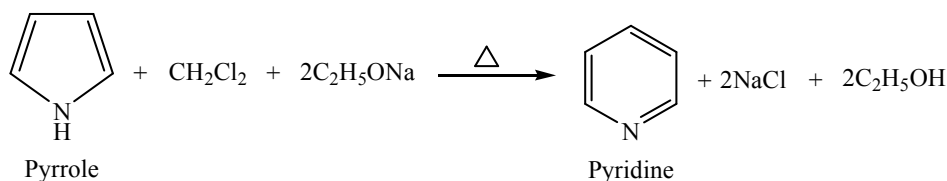
**i. From acrolein:** Pyridine can be prepared by the reaction of acrolein and ammonia according to following reaction steps.



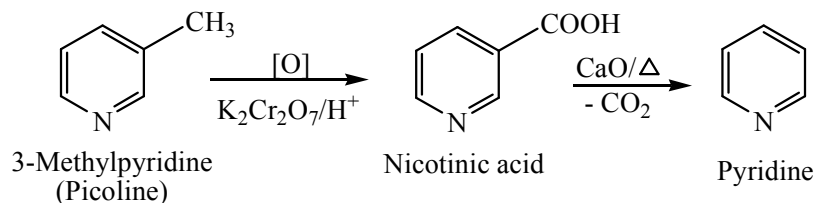
- ii. **Hantzsch Synthesis (1882):** In this method, the condensation of a beta-dicarbonyl compound, ammonia and an aldehyde lead the formation of 1,4-dihydropyridine derivative. The 1,4-dihydro pyridine derivative on oxidation with  $\text{HNO}_3$  yields the formation of pyridine derivative.



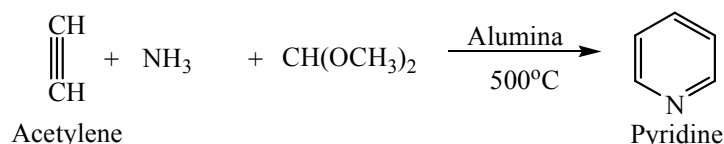
- iii. **From pyrrole:** Pyrrole when heated with methylene chloride in presence of sodium ethoxide, pyridine is formed.



- iv. **From Picoline:** Beta-picoline on oxidation with potassium dichromate and sulphuric acid gives nicotinic acid, which on decarboxylation with calcium oxide gives pyridine.

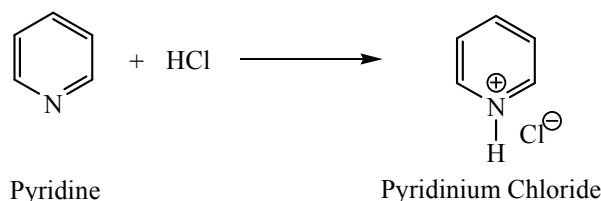


- v. **Industrial Method:** Industrially pyridine is prepared by heating the acetylene, ammonia and formaldehyde dimethylacetal in the presence of alumina at  $500^\circ\text{C}$ .



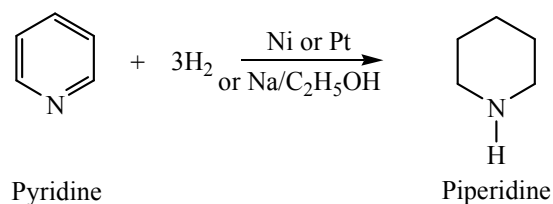
#### 4.7.8 PROPERTIES OF PYRIDINE:

- i. **Physical Properties of Pyridine:** Pyridine is a colourless liquid. Its boiling point is  $115.5^\circ\text{C}$ . It has a characteristic unpleasant odor. It is soluble in water and most organic solvents.
- ii. **Chemical properties of Pyridine:** Chemical properties of pyridine are discussed as follow:
  - a. **Basic character of pyridine:** Pyridine is basic in nature. Its  $\text{pK}_b$  is 8.75. It reacts with strong acids to form salts.



The basic nature of pyridine is due to the freely available lone pair of electrons in  $sp^2$  hybridized orbital pyridine, which does not participate in the formation of delocalized  $\pi$ -molecular orbital. Pyridine is less basic in comparison to aliphatic amines whereas, it is more basic than aniline and pyrrole. This is because the lone pair of electrons in aliphatic amines exists in  $sp^3$  hybridized orbital, however, in case of pyridine the lone pairs of electrons exists in  $sp^2$  hybridized orbital. Electrons are held more tightly by the nucleus in a  $sp^2$  hybridized orbital than an  $sp^3$  hybridized orbital. Hence the lone pair of electrons in pyridine is less available for protonation. The less basicity of pyrrole and aniline can be explained in terms of non-availability of these lone pair of electrons on nitrogen atom. These lone pair of electrons is involved in the formation of delocalized  $\pi$ -molecular orbital.

- b. **Reduction:** Under catalytic hydrogenation of pyridine hexahydropyridine is formed. It is also known as Piperidine.

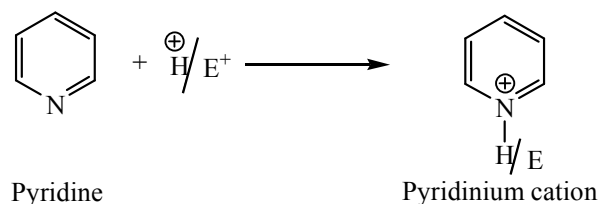




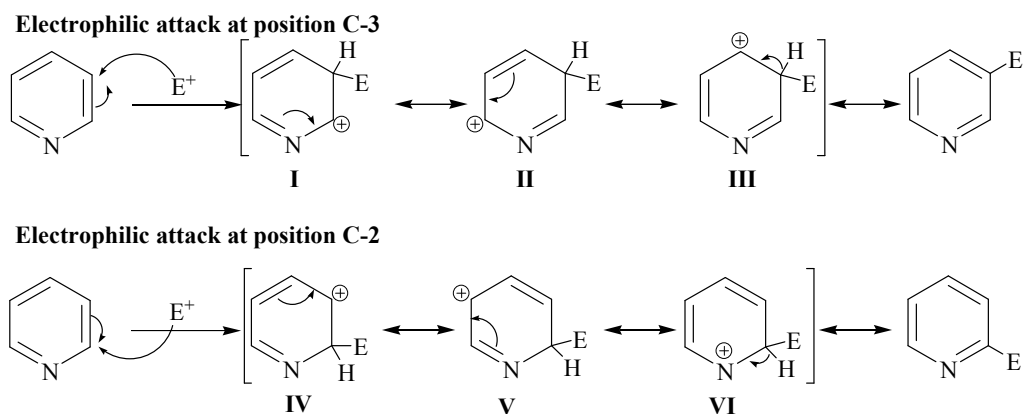
c. **Electrophilic substitution Reactions:** Pyridine is also an aromatic compound. It is less aromatic than benzene and pyrrole. Pyridine usually considered a highly deactivated aromatic nucleus towards electrophilic substitution reactions. Therefore highly vigorous reaction conditions should be used for these reactions to take place. The low reactivity of pyridine towards the electrophilic substitution reactions is due to the following reasons:

- The higher electro negativity of nitrogen atom reduces electron density on the ring, thus deactivate the ring.
- Pyridine is highly sensitive to acidic medium; it readily forms pyridinium cation with a positive charge on nitrogen atom. Similarly, electrophile itself may also react with pyridine to form corresponding pyridinium ion. This positive charge on nitrogen atom decreases electron density on nitrogen atom, consequently, the electron density on ring also decreases.

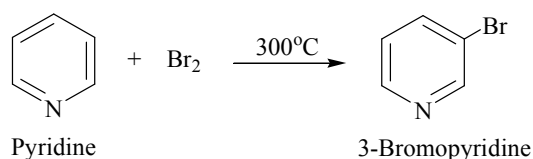
However, the effect of such deactivation is comparatively lower at position C-3. The position C-3 is thus, comparatively, the position of highest electron density in pyridine.



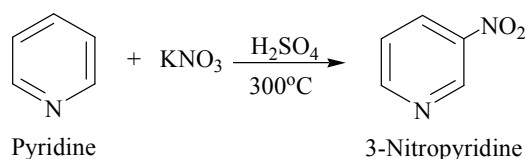
This is the reason that the pyridine undergoes electrophilic substitution at position C-3. Pyridine also gives electrophilic substitution like halogenation, nitration and sulphonation only under drastic conditions. Pyridine does not give Friedel-crafts reaction. Approach of the electrophile at position C-3 leads the formation of three resonating structures (I, II and III); similarly, approach of electrophile at position C-2 also leads the formation of three resonating structures (IV, V and VI). However, out of the three contributing resonating structures for the intermediate ion resulting from the attack of electrophile at position C-2, structures VI is considered as an unstable resonating form because in resonating structure VI the more electronegative nitrogen atom bears a +ve charge. Because of the unstable nature of one of the resonating structure of the intermediate ion formed during the attack of electrophile at position C-2 than that of the formed during the attack of electrophile at position C-3, the electrophilic substitution in pyridine at position C-3 is always favoured. Following mechanism is suggested for the electrophilic attack at position C-3.



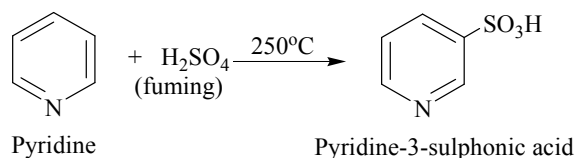
- i. Bromination:** Pyridine reacts with Bromine at high temperature to give 3-Bromopyridine.



- ii. Nitration:** 3-Nitropyridine is obtained when nitration of pyridine is performed by reacting it with KNO<sub>3</sub> in concentrated H<sub>2</sub>SO<sub>4</sub> at 300°C. The reaction of KNO<sub>3</sub> and concentrated H<sub>2</sub>SO<sub>4</sub> resulted–NO<sub>2</sub> which acts as an electrophile.



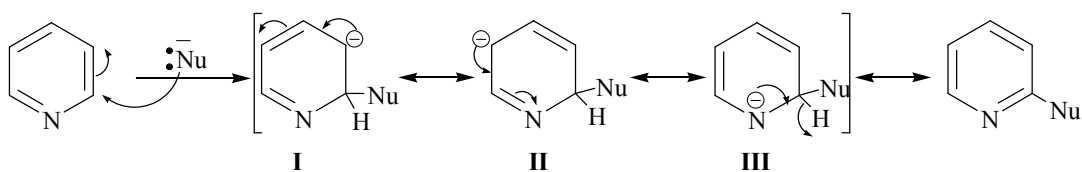
- iii. Sulphonation:** Sulphonation of pyridine is achieved by reacting it with fuming H<sub>2</sub>SO<sub>4</sub> at 250°C. Pyridine-3-sulphonic acid is obtained as product.



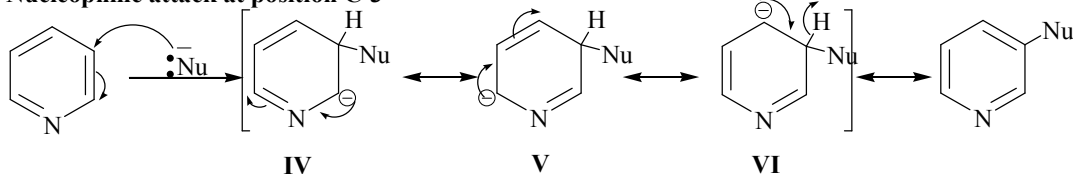
- d. Nucleophilic Substitution Reactions:** As we have discussed in previous section that pyridine generally deactivated the aromatic ring towards electrophilic substitution reaction. The deactivation of aromatic ring towards electrophilic substitution resulted due to the electron withdrawing nature of nitrogen atom. Due to such deactivation, pyridine also gives nucleophilic substitution reaction. Nucleophilic substitution in pyridine ring occurs at position C-2. Approach of the nucleophilic at position C-2 leads the formation

of three resonating structures (I, II and III); similarly, approach of nucleophilic at position C-3 also leads the formation of three resonating structures (IV, V and VI). The resonating structures for intermediate resulting from the attack of nucleophile at position C-2 are more stable than those of position C-3, since more electronegative nitrogen atom hold –ve charge in one of the resonating structure (III) obtained from the attack of nucleophile at position C-2. Hence, the nucleophilic substitution in pyridine at position C-2 is always favored. Following mechanism is suggested for the electrophilic attack at position C-2.

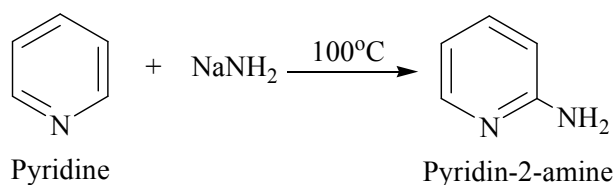
#### Nucleophilic attack at position C-2



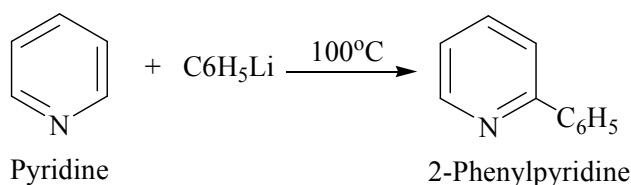
#### Nucleophilic attack at position C-3



- i. **Reaction with Sodium amide:** Pyridine reacts with sodium amide to give 2-aminopyridine via nucleophilic substitution.



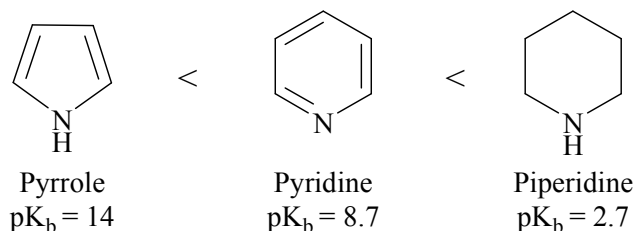
- ii. **Reaction with Phenyllithium:** Pyridine reacts with phenyllithium (an organometallic compound) to give 2-phenylpyridine.



## 4.8 COMPARISON OF BASICITY OF PYRROLE, PYRIDINE AND PIPERIDINE

From experimental studies it is observed that the  $pK_b$  values of pyrrole, pyridine and Piperidine are ~14, ~8.7 and ~2.7, respectively. Based on the suggested  $pK_b$  values the piperidine is found

as a stronger base than pyridine and pyrrole. Pyrrole is the weakest base among these three heterocyclic bases. The order of basicity of pyrrole, pyridine and piperidine is as given below:



The above order of basicity of pyrrole, pyridine and piperidine can be justified in terms of the structure of these compounds. As we know that the basicity of nitrogen compounds depends upon the availability of lone pair of electron on nitrogen atom. In pyrrole, the lone pair of electron on nitrogen atom exists in the  $sp^2$  hybridized orbital of nitrogen and participates in the delocalization, hence does not freely available to cause the basic character of pyrrole. Similar to pyrrole, the lone pair of electron on nitrogen atom of pyridine also exists in the  $sp^2$  hybridized orbital; however, it does not participate in the delocalization and available freely to cause the basic character. Although the lone pair of electron on nitrogen atom of pyridine available freely but due to more electronegative character of  $sp^2$  hybridized nitrogen atom (50% s-character) this lone pair is tightly bonded with nucleus, hence, less available for protonation. However, in piperidine, the lone pair of electron of nitrogen atom lies in  $sp^3$  hybridized orbital of nitrogen. These electrons are less tightly bonded with nucleus. Therefore, these electrons are readily available for protonation. Thus, piperidine is the strongest base among the three.

---

## 4.9 SUMMARY

---

- Heterocyclic compounds are those organic cyclic compounds which contains a hetero atom (N, O, S) as the part of ring.
- A hetero cyclic ring may comprise of three or more than three atoms, which may be saturated or unsaturated.
- Heterocyclic ring may contain more than one heteroatom which may be either similar or different.
- Heterocyclic compounds may be aliphatic or aromatic in nature.
- The aliphatic heterocyclic compounds are the cyclic amines, cyclic amides, cyclic ethers and cyclic thioethers.

- Aliphatic heterocycles those do not contain double bonds are called saturated heterocycles.
- The properties of aliphatic heterocycles are mainly affected by the ring strain.
- Aromatic heterocyclic compounds are analogous of benzene.
- The aromatic heterocyclic compounds also follow the Huckel's rule (*i.e.* aromatic compounds must be cyclic in nature with planar geometry due to conjugate double bonds and must have  $(4n+2)\pi$  electrons).
- The nomenclature of heterocyclic compounds is divided in to two categories, a) Trivial method of nomenclature and, b) Systematic method of nomenclature.
- The trivial nomenclature was the first nomenclature method which has a significant role in the development of heterocyclic chemistry.
- When heterocyclic compounds are named on the basis of their source from which the compound was obtained. This nomenclature pattern in known as trivial nomenclature.
- The trivial system does not give any structural information about the compound.
- Systematic nomenclature is the most widely used nomenclature system for monocyclic heterocyclic compounds especially for three to ten membered ring systems.
- The systematic nomenclature gives important structural information.
- The most relevant systematic nomenclature that is recommended by IUPAC for nomenclature of heterocyclic compounds is the *Hantzsch-Widmann system* of nomenclature.
- This nomenclature system specifies the nature, position, ring size, number, and types of heteroatoms present in any heterocyclic compounds.
- Molecular orbital model of heterocyclic compounds reveals that the heterocyclic compounds have less aromatic character in comparison to benzene and its derivatives.
- Molecular orbital model of heterocyclic compounds also suggested why there is asymmetrical electron density occurs in heterocyclic compounds.
- Due to less aromatic character then benzene, the rate of electrophilic substitution reactions of heterocyclic compounds is slower than benzene.
- Pyrrole, furan and thiophene undergo electrophilic substitution at position C-2.
- Pyridine undergoes electrophilic substitution at position C-3.
- Pyridine generally deactivated the aromatic ring towards electrophilic substitution reaction.

- The deactivation of aromatic ring towards electrophilic substitution resulted due to the electron withdrawing nature of nitrogen atom.
- Due to such deactivation, pyridine also gives nucleophilic substitution reaction.
- Nucleophilic substitution in pyridine ring occurs at position C-2.
- Among the three nitrogenous heterocyclic compounds (*i.e.* Pyrrole, Pyridine and Piperidine), Piperidine is the most basic; whereas, pyrrole is the least basic heterocyclic compound.

---

#### 4.10 TERMINAL QUESTION

---

Q1. What do you understand by heterocyclic compounds?

Q2. Why systematic nomenclature is more useful than trivial nomenclature of Heterocyclic compounds?

Q3. Discuss the aromaticity of pyrrole.

Q4. Why pyridine is more basic than pyrrole?

Q5. Discuss the general mechanism of electrophilic substitution reaction of pyrrole.

Q6. Why pyridine also gives nucleophilic substitution reactions?

---

#### 4.11 ANSWERS

---

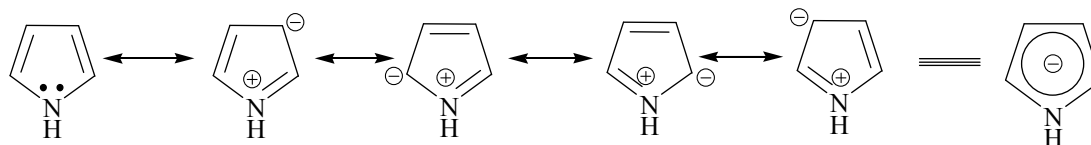
A1. Heterocyclic compound is the class of cyclic organic compounds those having at least one hetero atom (*i.e.* atom other than carbon) in the cyclic ring system. The most common heteroatoms are nitrogen (N), oxygen (O) and sulphur (S). Heterocyclic compounds are frequently abundant in plants and animal products; and they are one of the important constituent of almost one half of the natural organic compounds known. Alkaloids, natural dyes, drugs, proteins, enzymes etc. are the some important class of natural heterocyclic compounds. Heterocyclic compounds have a wide application in pharmaceuticals, agrochemicals and veterinary products. Many heterocyclic compounds are very useful and essential for human life. Various compounds such as hormones, alkaloids antibiotic, essential amino acids, hemoglobin, vitamins, dyestuffs and pigments have heterocyclic structure.

A2. The systematic nomenclature is more useful than trivial nomenclature because the systematic nomenclature gives important structural information. The most relevant system that is recommended by IUPAC for nomenclature of heterocyclic compounds is the *Hantzsch-Widmann*

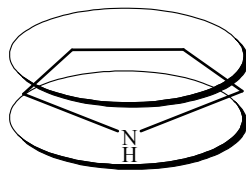
*system* of nomenclature. This nomenclature system specifies the nature, position, ring size, number, and types of heteroatoms present in any heterocyclic compounds. This systematic method generally derived the nomenclature using the following syntax;

Name: Prefix + Stem + Suffix

**A3.** Pyrrole usually does not explain the simple addition reactions like alkenes under normal conditions. This is because of the delocalization of lone pair of nitrogen atom through conjugation. This delocalization provides extra stability to the double bonds of pyrrole. Also the proposed structure of pyrrole is considered as an aromatic compound since it follows the Huckel's aromaticity rules ( $4n+2$  electron rule). The aromatic nature and extra-stability of pyrrole can also be supported by the formation of its different resonating structures as shown in below figure. The structure of pyrrole is the resonance hybrid of all resonating structures.



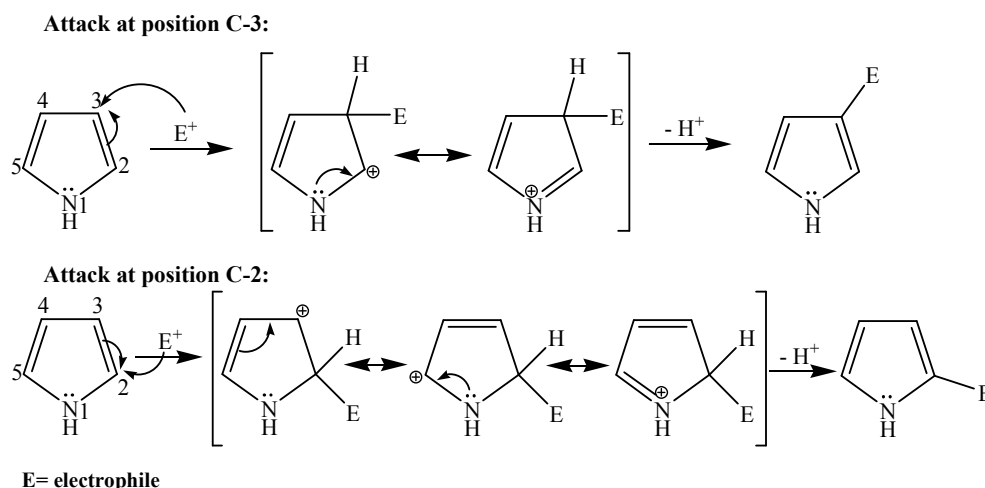
1. The delocalization of lone pair of nitrogen in pyrrole through conjugation also suggests that the pyrrole molecule should have planar geometry. This is only possible when the orbitals of carbon and nitrogen in pyrrole are  $sp^2$ - hybridized. The three  $sp^2$ - hybridized orbitals of nitrogen contain one- one electron in each  $sp^2$ - hybridized orbital. The unhybridized  $p$ -orbital of nitrogen contains lone pair of electrons. Two  $sp^2$ - hybridized orbitals of nitrogen atom forms  $\pi$ -bond with two carbon atoms of the ring whereas the third  $sp^2$ - hybridized orbital of nitrogen atom forms  $\pi$  -bond with hydrogen atom. Similarly each  $sp^2$ - hybridized carbon forms two  $\pi$  -bonds with neighboring carbon atoms and one  $\pi$  -bonds with hydrogen atom. The unhybridized orbitals of each carbon contain one electron. These unhybridized orbitals of carbon and nitrogen form a delocalized electron cloud above and below the pentagonal ring of pyrrole. The delocalized electron cloud is shown in figure.



**A4.** As we know that the basicity of nitrogen compounds depends upon the availability of lone pair of electron on nitrogen atom. In pyrrole, the lone pair of electron on nitrogen atom exists in

the  $sp^2$  hybridized orbital of nitrogen and participates in the delocalization, hence does not freely available to cause the basic character of pyrrole. Similar to pyrrole, the lone pair of electron on nitrogen atom of pyridine also exists in the  $sp^2$  hybridized orbital; however, it does not participate in the delocalization and available freely to cause the basic character. Therefore, pyridine is more basic than pyrrole.

**A5.** Pyrrole undergoes electrophilic substitution at the position C-2. Approach of the electrophile at position C-2 leads the formation of three resonating structures; however, only two resonating structures are obtained when the electrophile approaches at position C-3. Thus the intermediate obtained by the approach of electrophile at position C-2 is more stable than the intermediate obtained by the approach of electrophile at position C-3. This is the reason that electrophilic attack occurs at position C-2. Following mechanism is suggested for the electrophilic attack at position C-2. All the electrophilic substitution reactions of pyrrole occur at position C-2 and follow the similar mechanism as shown below.

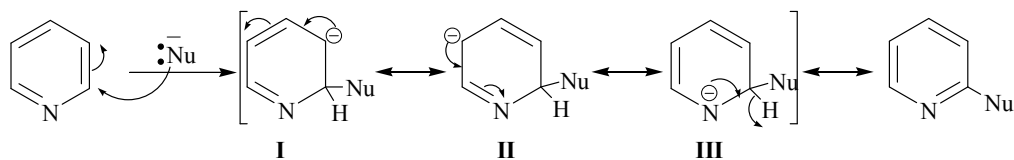


**A6.** Pyridine generally deactivated the aromatic ring towards electrophilic substitution reaction. The deactivation of aromatic ring towards electrophilic substitution resulted due to the electron withdrawing nature of nitrogen atom. Due to such deactivation, pyridine also gives nucleophilic substitution reaction. Nucleophilic substitution in pyridine ring occurs at position C-2. Approach of the nucleophilic at position C-2 leads the formation of three resonating structures (I, II and III); similarly, approach of nucleophilic at position C-3 also leads the formation of three resonating structures (IV, V and VI). The resonating structures for intermediate resulting from the attack of nucleophile at position C-2 are more stable than those of position C-3, since more electronegative nitrogen atom hold  $-ve$  charge in one of the resonating structure (III) obtained

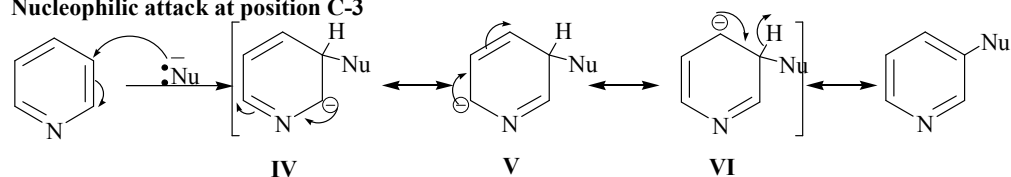


from the attack of nucleophile at position C-2. Hence, the nucleophilic substitution in pyridine at position C-2 is always favored. Following mechanism is suggested for the electrophilic attack at position C-2.

**Nucleophilic attack at position C-2**



**Nucleophilic attack at position C-3**



### Bibliography:

1. "Heterocyclic Chemistry" by Raj K. Bansal 5<sup>th</sup> Edn, New Age International Publisher, ISBN 978-81-224-3143-8.
2. "Heterocyclic Chemistry" 5<sup>th</sup> Edn. by J. A. Joule, K. Mills and G. F. Smith, Wiley International Publications, ISBN: 978-1-4051-3300-5.
3. "Heterocyclic Chemistry" (3rd Edition) by Thomas. L. Gilchrist, Prentice Hall Publication, ISBN 978-0-5822-7843-1.
4. "Organic Chemistry" Vol. 1 by I L Finar, Published by Pearson Education; ISBN 10: 8177585428.
5. "Organic Chemistry" by T. W. Graham Solomons, Published by John Wiley; ISBN-10: 1118133579.

---

## UNIT 5: HETEROCYCLIC COMPOUNDS- II

---

### CONTENTS

- 5.1 Objectives
- 5.2 Introduction
- 5.3 Preparation and reactions of indole, quinoline and isoquinoline
  - 5.3.1 Indole
  - 5.3.2 Quinoline
  - 5.3.3 Isoquinoline
- 5.4 Summary
- 5.5 Terminal Question
- 5.6 Answers
- 5.7 Bibliography

---

### ***5.1 OBJECTIVES***

---

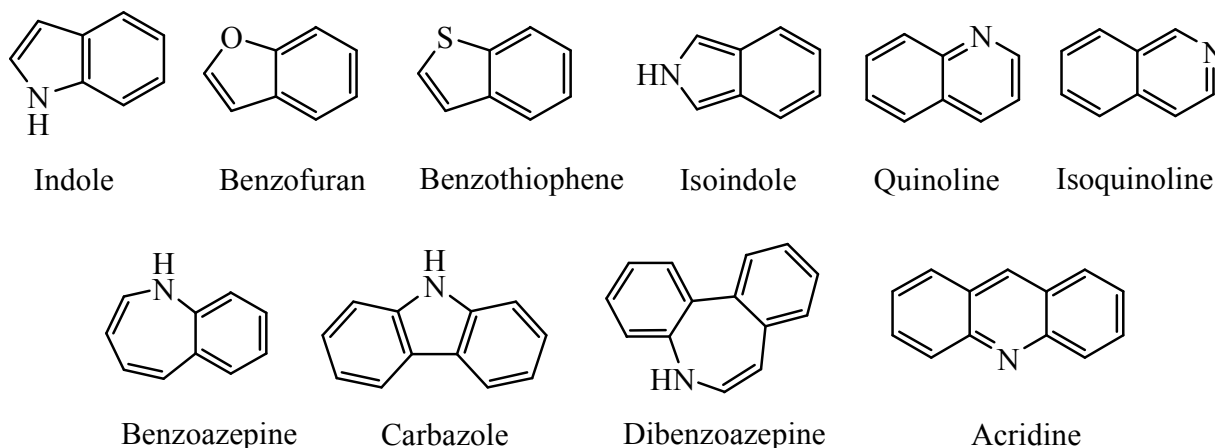
#### **In this unit learner will be able to**

- Know about the most important condensed heterocyclic compounds containing five and six membered fused rings.
- Understand and discuss the reactivity and stability of such bicyclic hetero aromatic compounds.
- Study the important synthetic routes and reactivity for five and six membered benzo fused hetero aromatic compounds.
- Understand the important physical and chemical properties of five and six membered benzo fused hetero aromatic compounds.
- Know about the applications of these five and six membered benzo fused hetero aromatic compounds in the synthesis of important industrial and pharmaceutical compounds.

## 5.2 INTRODUCTION

In unit 4 we have discussed that the heterocyclic compound is the class of cyclic organic compounds those having at least one hetero atom (*i.e.* atom other than carbon) in the cyclic ring system. The most common heteroatoms are nitrogen (N), oxygen (O) and sulphur (S). Heterocyclic compounds are frequently abundant in plants and animal products; and they are one of the important constituent of almost one half of the natural organic compounds known. Alkaloids, natural dyes, drugs, proteins, enzymes etc. are the some important class of natural heterocyclic compounds. Heterocyclic compounds can be easily classified based on their electronic structure. Heterocyclic compounds are primarily classified as saturated and unsaturated. The saturated heterocyclic compounds behave like the acyclic derivatives with modified steric properties. Piperidine and tetrahydrofuran are the conventional amines and ethers of this category. However, unsaturated heterocyclic compounds of 5- and 6- member rings have been studied extensively because of their unstrained nature. The unstrained unsaturated heterocyclic compounds include Pyridine, Thiophene, Pyrrole, Furan and their benzo fused derivatives.

Heterocyclic rings systems that are formally derived by fusion with other rings, either carbocyclic or heterocyclic, have a variety of common and systematic names. For example, with the benzo-fused unsaturated nitrogen heterocycles, pyrrole provides Indole or isoindole depending on the orientation. Various other important examples of benzofused heterocyclic compounds are Quinoline, Isoquinoline, Benzothiophene, Benzazepine, Dibenzazepine, Carbazole, Acridine, and Benzofuran. Figure 1 shows the structural representation of various important 5 and 6 membered benzofused heterocyclic compounds.



**Figure 1:** Examples of various important benzo fused heterocyclic compounds

In the present unit, students would be able to learn about the most important five and six membered benzo fused heterocyclic compounds, such as Indole, Quinoline and Isoquinoline.

---

## 5.3 PREPARATION AND REACTIONS OF INDOLE QUINOLINE AND ISOQUINOLINE

---

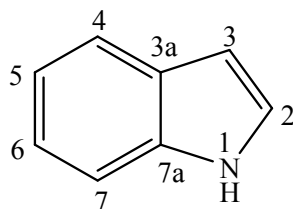
### 5.3.1 INDOLE

Indole is an aromatic heterocyclic organic compound with formula  $C_8H_7N$ . It has a bicyclic structure, consisting of a six-membered benzene ring fused to a five membered nitrogen-containing pyrrole ring. Chemistry of Indole was developed with the study of the dye indigo. Indigo can be converted to Isatin and then to Oxindole. Indole was first synthesized in 1866, when Adolf von Baeyer reduced Oxindole to Indole using zinc dust. The name Indole is a combined name of the words indigo and oleum, since Indole was first isolated by treatment of the indigo dye with oleum.

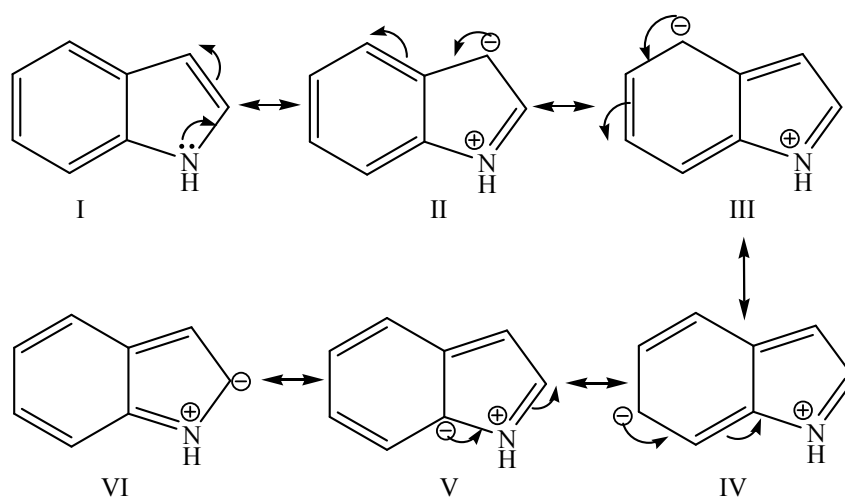
Indole is widely distributed in the natural environment and can be produced by a variety of bacteria. As an intercellular signal molecule, it regulates various aspects of bacterial physiology, including spore formation, plasmid stability, drugs resistance, bio-film formation, and virulence. The amino acid tryptophan is an Indole derivative and the precursor of the neurotransmitter serotonin.

Certain Indole derivatives were important dyestuffs until the end of the 19<sup>th</sup> century. In the 1930s, interest in Indole intensified when it became known that the Indole substituent is present in many important alkaloids (e.g., tryptophan and auxins), and it remains an active area of research today. Indole is found in coal tar and in essential oils (Jesamine oil, orange oil) of many plants. It also occurs in amino acids as a plant growth hormone in alkaloids.

**Structure of Indole:** The IUPAC name of Indole is 1H-benzo[b] pyrrole, it is being the b-face benzo-fused isomer. The atoms are numbered as shown in below structure. The numbering begins from the Nitrogen atom and going counter clock wise around the two condensed rings.



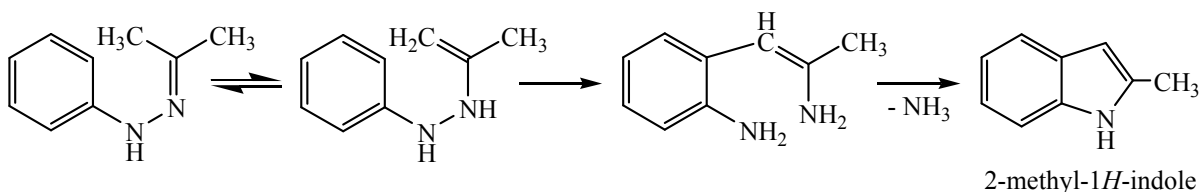
All the ring atoms in Indole are  $sp^2$  hybridized. The  $sp^2$  orbitals of all carbon and nitrogen atom overlap with each other and also with the  $s$  orbitals of hydrogen to form C-C, C-N, C-H and N-H  $\sigma$  bonds. Each ring atom also possesses a  $p$  orbital. These are perpendicular to the plane of the ring. Lateral overlap of these  $p$ -orbitals produce a  $\pi$  molecular orbital containing 10 electrons. Indole is an aromatic compound since it follows the Huckel's rule (*i.e.*  $4n+2\pi$  electron rule) for  $n=2$ . Indole is a resonance hybrid of several canonical forms. The different possible canonical forms of Indole are shown in Figure 2. Structures IV, V and VI involve the formation of a non-benzenoid system in which the aromaticity of benzene ring dose not retained. Hence, these structures contribute less in the resonance.



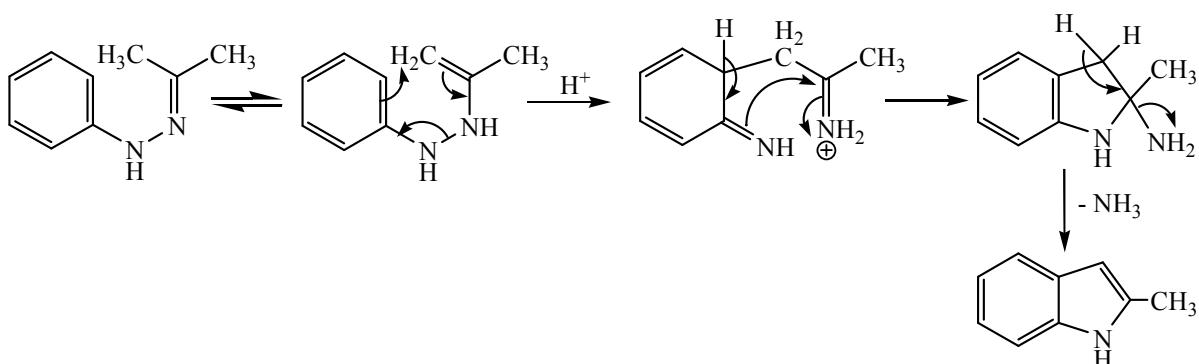
**Figure 2:** Different possible canonical forms of Indole

**Synthesis or preparation of Indole:** There are different methods available for the synthesis of Indole and its derivatives. These methods differ in their range of applicability. However, a number of general methods are also known in which the pyrrole ring formed through the ring closure reactions. The important methods for the synthesis of Indole are discussed below.

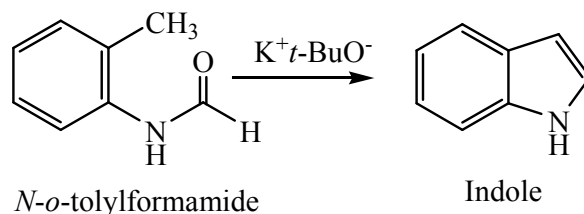
1. **The Fisher-Indole synthesis:** This is the most widely used method for the synthesis of Indole. It involves an acid (Lewis acid) catalyzed rearrangement of a phenylhydrazone of an aldehyde or ketone, with the elimination of a molecule of ammonia. The conventional catalysts used in this process are zinc chloride, polyphosphoric acid or a Lewis acid ( $\text{BF}_3$ ). Synthesis of 2-methyl indole can be achieved by taking the phenylhydrazone of acetone. The reaction is as shown below.



**Mechanism:** Fisher-Indole synthesis is supposed to take place through the acid catalyzed rearrangement of the tautomeric form of the starting phenylhydrazone as shown below.

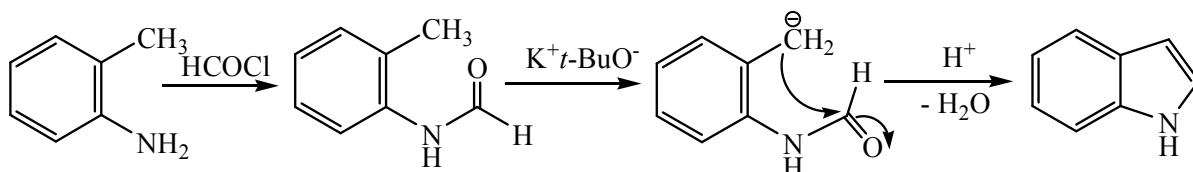


2. **The Madelung Synthesis:** This involves the cyclic dehydration of an acyl o-toluidine in presence of a strong base and at high temperature. Indole itself can be prepared by this method. 2-alkylindole can be synthesized by the cyclodehydration of o-acyl aminotoluene by treatment with strong base such as potassium tertiary butoxide or sodamide. The reaction is shown as below.

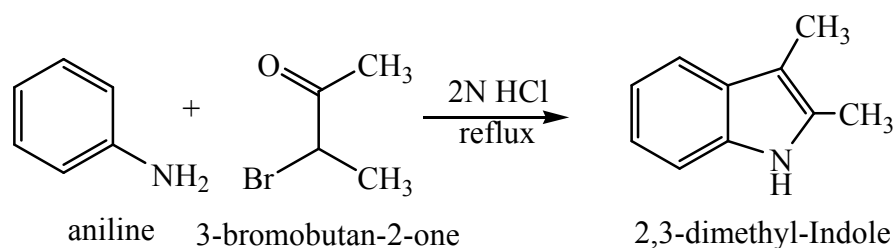


**Mechanism:** o-amino toluene forms o-acyl aminotoluene on treatment with formylchloride. The o-acyl aminotoluene on reaction with strong base gives the

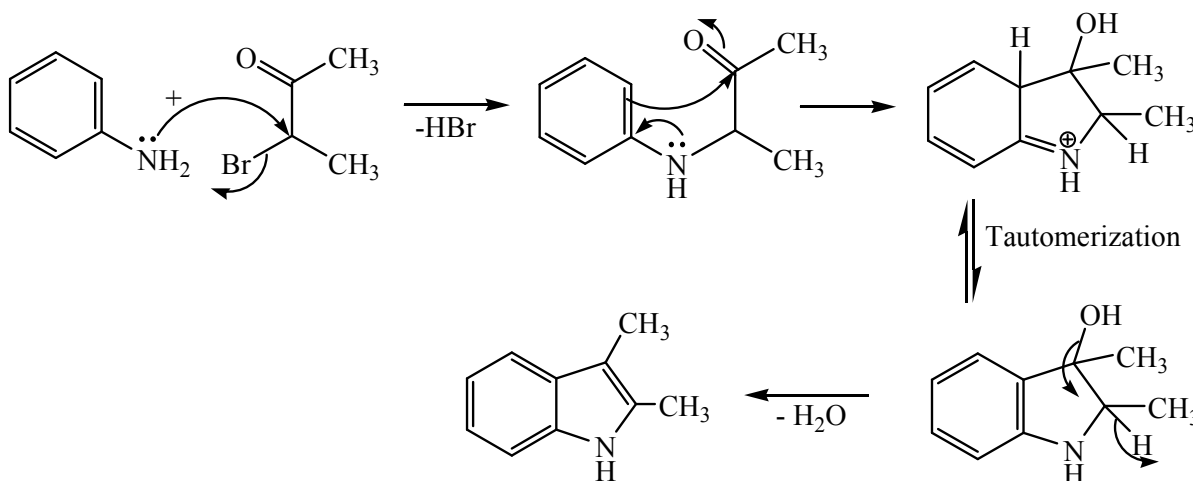
corresponding carbanion. The subsequent protonation followed by elimination of water molecule lead the formation of Indole. The overall mechanism is shown as follow.



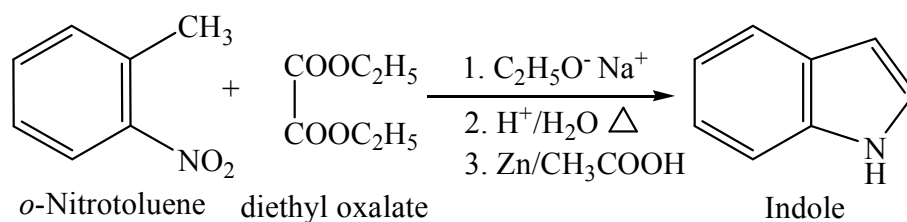
**3. The Bischler's synthesis:** This method involves the reaction of an aryl amine and  $\alpha$ -halo ketone or  $\alpha$ -haloaldehyde in presence of zinc chloride under thermal or heating condition. The reaction is shown as follow.



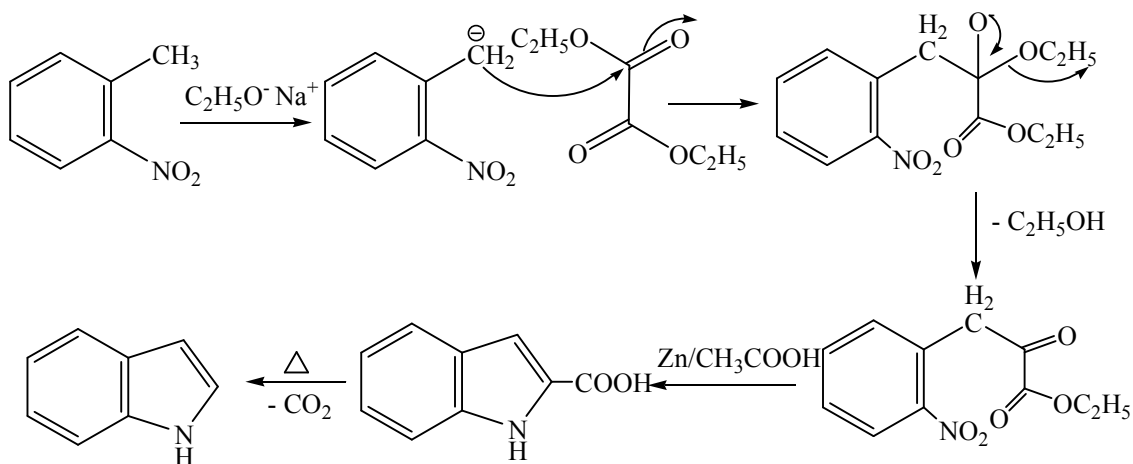
**Mechanism:** The mechanism of Bischler's Indole synthesis involves the following steps. Reaction of aniline with  $\alpha$ -bromoketone (3-Bromo-2-butanone) in presence of acid under reflux condition gives the condensed product with elimination of HBr molecule. Which on thermal cyclization and subsequent aromatization leads the formation of 2,3-dimethyl Indole.



- 4. The Reissert Synthesis:** This method also provides a very simple and convenient procedure for the synthesis of Indole and its derivatives. This method involves the base catalyzed condensation of *o*-nitrotoluene with oxalic acid ethyl ester (diethyl oxalate) in presence of strong base like sodium ethoxide. This condensation leads the formation of *o*-nitro-phenylpyruvate which on hydrolysis gives the corresponding acid. The resultant acid on reductive cyclization in presence of Zn/CH<sub>3</sub>COOH yields the Indole. The reaction is shown as follows



**Mechanism:** *o*-Nitrotoluene on reaction with sodium ethoxide produces a carbanion which on condensation with diethyl oxalate yields the *o*-nitro-phenylpyruvate. The acidic hydrolysis converts the *o*-nitro-phenylpyruvate in to corresponding acid. The reductive cyclization followed by the decarboxylation gives the formation of Indole.



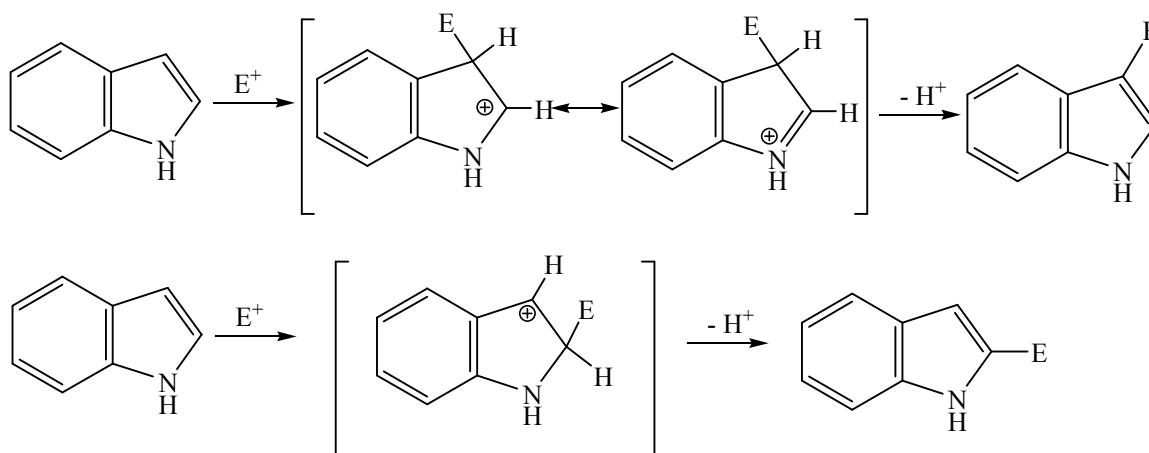
**PHYSICAL PROPERTIES OF INDOLE:** Indoles and simple alkyl Indoles are colourless crystalline solids. The melting point of Indole is 52°C and boiling point is 254°C. Indole is soluble in most of the organic solvents. The pure form of Indole has very pleasant smell and this is the reason it is used as a perfumery base, however, the impure Indole has very unpleasant smell. The main commercial source of Indole comes from the 220-260°C fraction of coal tar distillation.



The  $^1\text{H}$  NMR spectra of Indole feature all the resonances for the hydrogen in the aromatic region. The upfield shift observed for H3 and C3 in the  $^1\text{H}$  and  $^{13}\text{C}$  NMR indicate the higher electron density around C3.

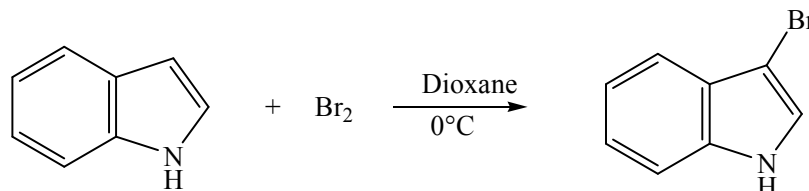
## CHEMICAL PROPERTIES OF INDOLE

**Electrophilic substitution reactions:** Indole is a  $\pi$ -excessive aromatic heterocycles with ten  $\pi$ -electron. Indole is an aromatic compound. It involves the  $4n+2$   $\pi$  electrons and hence follows the Huckel rule of aromaticity. The lone pair of  $\text{sp}^2$  hybridized nitrogen atom participates in the delocalization process and thus helps to complete the ten  $\pi$ -electron across the ring. Like pyrrole, the  $\pi$  excessive nature of the aromatic ring governs the reactivity and chemical properties of Indole. Indole is a weak base ( $\text{pK}_a = -2.4$ ). In presence of a strong acid protonation of the nitrogen atom would disrupt the aromaticity of the five-membered ring. Like other aromatic compounds, Indole also gives the electrophilic substitution (the characteristic reactions of aromatic compounds). However, unlike pyrrole, electrophilic substitution in Indole takes place preferentially at C<sub>3</sub>. A simple explanation for this can be made by analysis of the Wheland intermediates resulting from the attack of an electrophile at C<sub>3</sub> and C<sub>2</sub> positions. For a reaction at C-3, the energy of activation of the intermediate is lowered because it is possible to delocalize the positive charge through resonance involving the nitrogen lone pair of electrons. This favourable situation is not possible in the corresponding intermediate for attack at C-2.



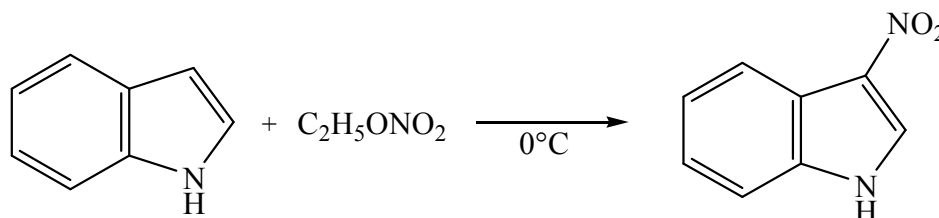
The intermediate of the attack at C<sub>3</sub> is stabilized by delocalization of the positive charge. However, no delocalization is possible in the intermediate derived from attack at C<sub>2</sub> position without disrupting the aromaticity of the six membered rings. The common electrophilic substitution reactions of Indole are discussed as follow.

- 1. Bromination:** Indole undergoes bromination at very low temperature (0°C) in dioxane. The bromination occurs at C3 position.

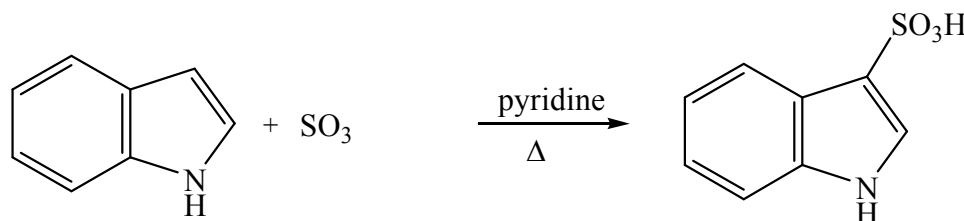


The mechanism of bromination is similar as discussed above the general mechanism of electrophilic substitution. In above mechanism the E can be replaced by Br.

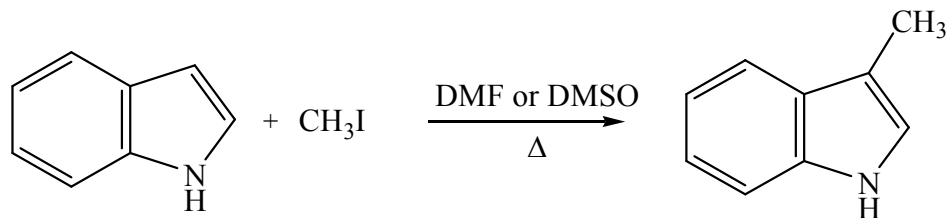
- 2. Nitration:** Indole undergoes nitration in presence of ethyl nitrate at low temperature (0 - 5°C). Nitration of Indole also occurs at C3 with the similar mechanism as discussed above.



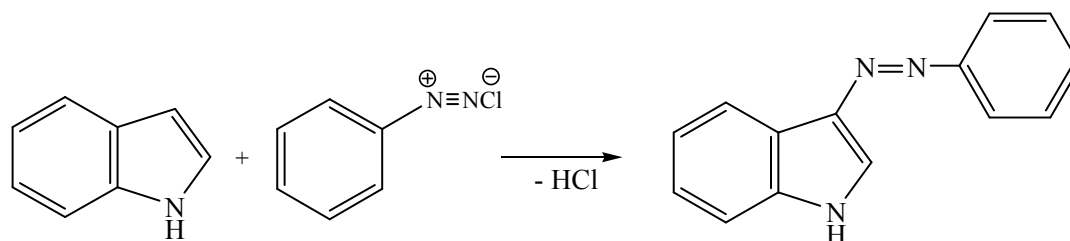
- 3. Sulphonation:** Sulphonation of Indole is carried out only under milder conditions using pyridine-sulphur trioxide complex in order to minimize the acidity of the reagent.



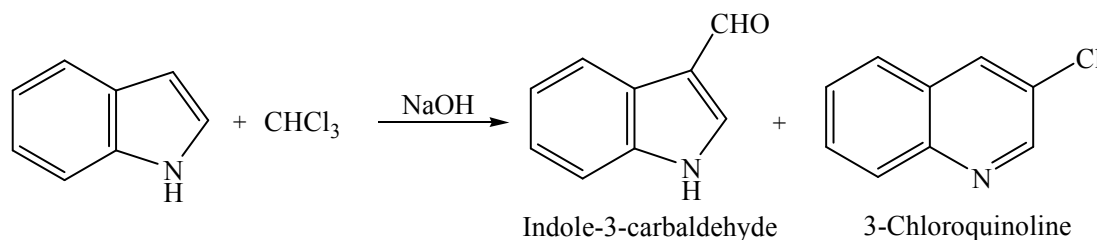
- 4. Friedel crafts alkylation:** Indole undergoes alkylation at C3 position with alkyl iodide in N,N-dimethyl formamide (DMF) or dimethyl sulphoxide (DMSO) as solvent.



5. **Diazocoupling or Diazotization reaction:** Indole reacts with benzene diazonium chloride to give 3-phenylazoindole, a diazotized coupled product.



6. **Reimer Tiemann formylation:** Indole, like other aromatic compounds, reacts with Chloroform ( $\text{CHCl}_3$ ) in presence of alkali to give formylated product at C3 position. This reaction proceeds via carbene intermediate. In general two products are obtained in this reaction, first, the C3 formylated product (Indole-3-carbaldehyde) and second, the rearranged product (3-Chloroquinoline).



## APPLICATIONS OF INDOLE AND ITS DERIVATIVES

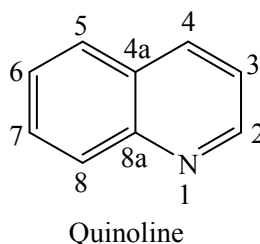
Indole and its derivatives are being extensively used in medicinal and pharmaceutical industry. Indole derivative Indigo is also used as a dyestuff called in Textile industry.

### 5.3.2 QUINOLINE

Quinoline is a heterocyclic aromatic organic compound with the chemical formula  $\text{C}_9\text{H}_7\text{N}$ . It is a colorless hygroscopic liquid with a strong odor. It is a bicyclic heterocycle having a benzene ring fused with a pyridine ring at 2, 3-positions. It is also called 1-azanaphthalene or

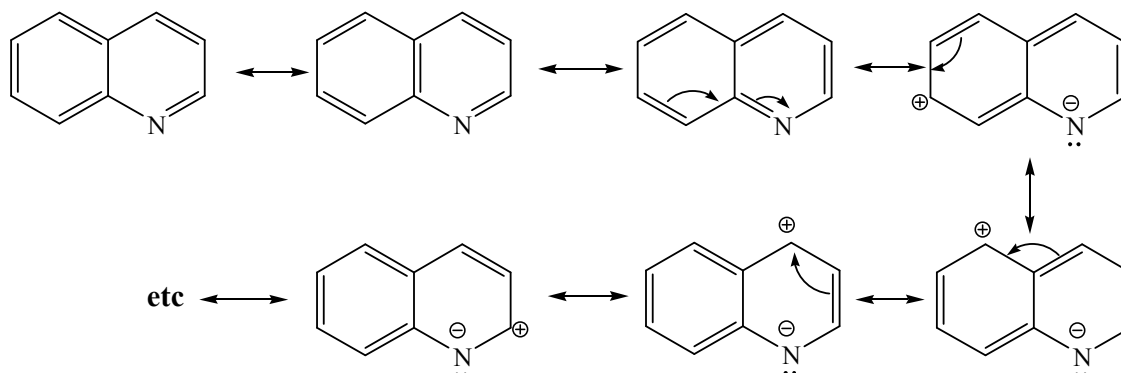
benzo[b]pyridine. Quinoline was first extracted from coal tar in 1834 by German chemist Friedlieb Ferdinand Runge; he called quinoline leukol ("white oil" in Greek). Coal tar remains the principal source of commercial quinoline. In 1842, French chemist Charles Gerhardt obtained a compound by dry distilling quinine, strychnine, or cinchonine with potassium hydroxide; he called the compound Chinoilin or Chinolein. Runge's and Gerhardt's compounds seemed to be distinct isomers because they reacted differently. However, the German chemist August Hoffmann eventually recognized that the differences in behaviors were due to the presence of contaminants and that the two compounds were actually identical. Like other nitrogen heterocyclic compounds, such as pyridine derivatives, quinoline is often reported as an environmental contaminant associated with facilities processing oil shale or coal, and has also been found at legacy wood treatment sites. Owing to its relatively high solubility in water quinoline has significant potential for mobility in the environment, which may promote water contamination. Quinoline is readily degradable by certain microorganisms, such as *Rhodococcus* species Strain Q1, which was isolated from soil and paper mill sludge. Quinolines are present in small amounts in crude oil within the virgin diesel fraction. It can be removed by the process called hydrodenitrication. Quinoline is only slightly soluble in cold water but dissolves readily in hot water and most organic solvents. Quinoline itself has few applications, but many of its derivatives are useful in diverse applications. A prominent example is quinine, an alkaloid found in plants. 4-Hydroxy-2-alkylquinolines (HAQs) are involved in antibiotic resistance.

**Structure of Quinoline:** The IUPAC name of quinoline is benzo[b] pyridine, it is being the b-face benzo-fused isomer. The atoms are numbered as shown in below structure. The numbering begins from the Nitrogen atom and going counter clock wise around the two condensed rings. The structure of quinoline is shown as follow.



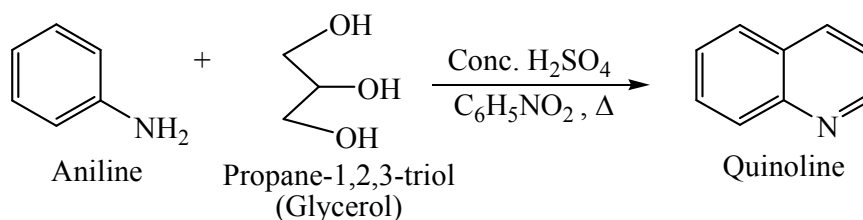
All the ring atoms in Quinoline are  $sp^2$  hybridized. The  $sp^2$  orbitals of all carbon and nitrogen atom overlap with each other and also with the s orbitals of hydrogen to form C-C, C-N, and C-H

$\pi$  bonds. Each ring atom also possesses a p orbital. These p orbitals are perpendicular to the plane of the ring. Lateral overlap of these p-orbitals produce a  $\pi$  molecular orbital containing 10 electrons. Quinoline is an aromatic compound since it follows the Huckel's rule (i.e.  $4n+2 \pi$  electron rule) for  $n=2$ . Unlike Indole, the lone pair of nitrogen of quinoline does not participate in the delocalization. Quinoline is a resonance hybrid of several canonical forms as shown below.

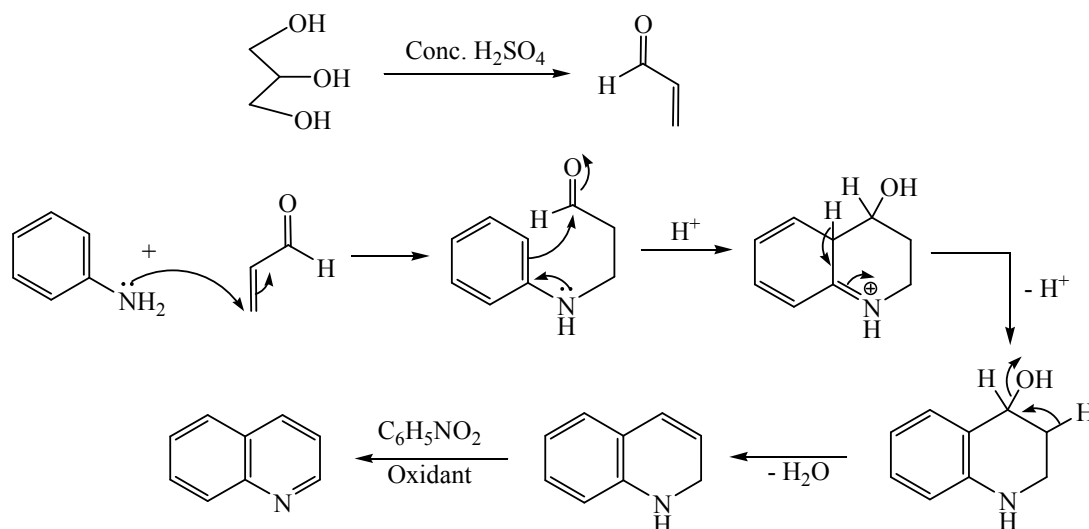


**Synthesis or preparation of Quinoline:** There are different methods available for the synthesis of quinoline and its derivatives. These methods may differ in their range of applicability. However, a number of general well known methods have been used for the preparation of quinoline. The important methods for the synthesis of quinoline are discussed below.

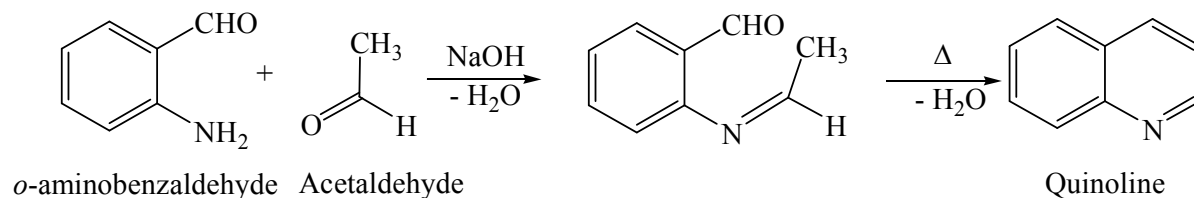
- 1. The Skraup synthesis:** This is one of the most important methods for the preparation of quinoline. In this method the aniline and its derivatives having vacant ortho position is when heated with glycerol, concentrated  $H_2SO_4$  and an oxidizing agent the resultant product is obtained as quinoline or its derivatives. The nitrobenzene is generally used as mild oxidizing agent in Skraup synthesis. Glycerol when heated with concentrated  $H_2SO_4$  it gives the acrolein after dehydration. Condensation of acrolein thus obtained with aniline or its derivatives followed by oxidation gives the quinoline. The reaction is shown as follow.



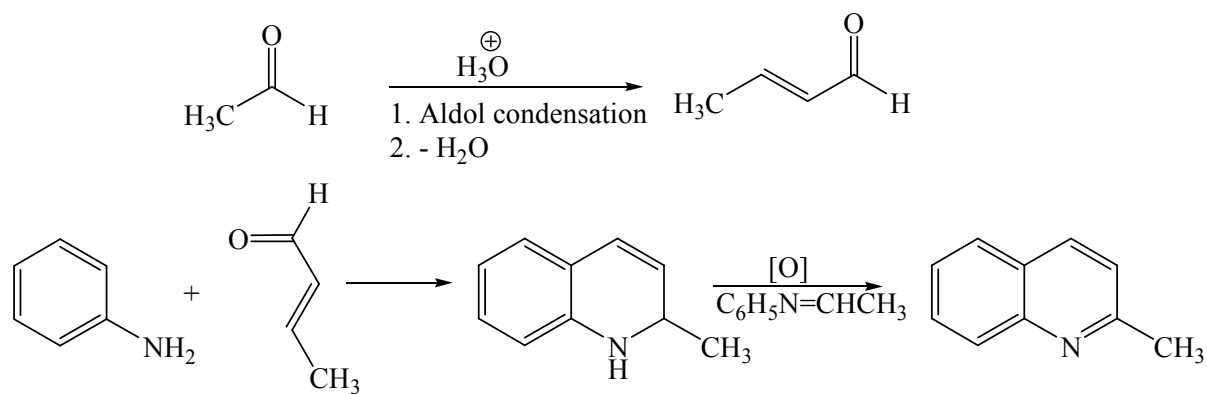
**Mechanism:** The step wise mechanism of Skraup synthesis of quinoline is given as follow.



2. **The Friedlander's synthesis:** Quinoline can also be prepared by the condensation of *o*-amino Benzaldehyde with acetaldehyde in sodium hydroxide solution. The reaction mechanism is shown as follow.



3. **The Dobner-Miller Synthesis:** This is a modified form of the Skraup synthesis. In this reaction the simple aldehydes and ketones act as precursor of  $\alpha, \beta$ -unsaturated carbonyl compounds. The reaction follows the similar reaction course as in the Skraup synthesis to produce derivatives of quinoline. When acetaldehyde is used as precursor of  $\alpha, \beta$ -unsaturated carbonyl compound 2-methylquinoline is formed. The reaction mechanism is shown as follow.

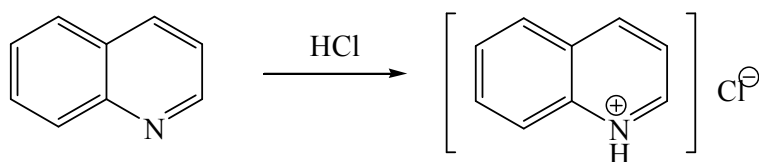


**PHYSICAL PROPERTIES OF QUINOLINE:** Quinoline is colourless hygroscopic liquid. Its boiling point is 237 °C. It has a characteristic smell similar to that of pyridine. On exposure to air quinoline turns in to yellow coloured. It is miscible in organic solvents. Quinoline is highly aromatic in nature and it has resonance energy 47.3 kcal/mole. Quinoline is a weak base having pKa 4.94. The basicity of quinoline is intermediate between aniline (pKa 4.58) and pyridine (pKa 5.17).

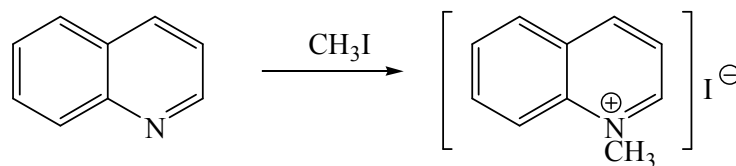
**CHEMICAL PROPERTIES OF QUINOLINE:** The important chemical properties of quinoline are discussed as follow.

- Basicity:** Due to availability of lone pair of electrons on nitrogen, quinoline acts as a base and forms salts with acids and quaternary salts with alkyl halides.

a. Reaction with acids:

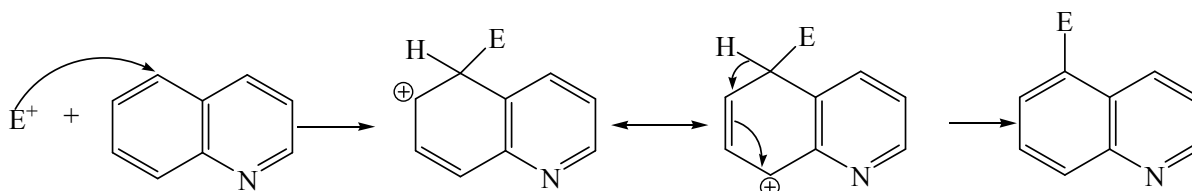


b. Reaction with methyl iodide:

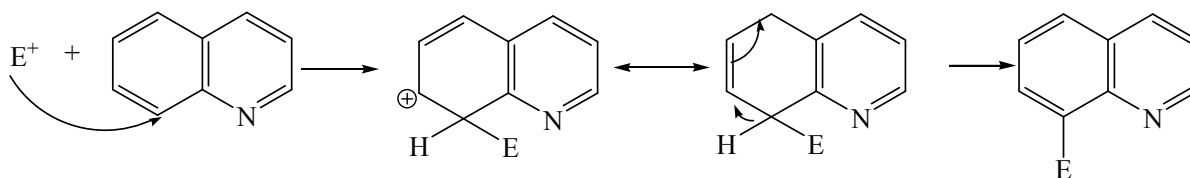


- Electrophilic substitution:** Out of the two fused rings in quinoline, the carbocyclic (benzene) ring is relatively more electron rich and resembles benzene ring while the nitrogen containing ring (less electron rich) resembles with pyridine ring. Therefore the electrophilic substitution in quinoline takes place more readily at benzene ring (at position 5 and 8 of benzene ring) rather than the pyridine ring. Thus if both the positions in benzene ring are vacant than mixture of substituted product is obtained. The general mechanism of electrophilic substitution on quinoline is shown below.

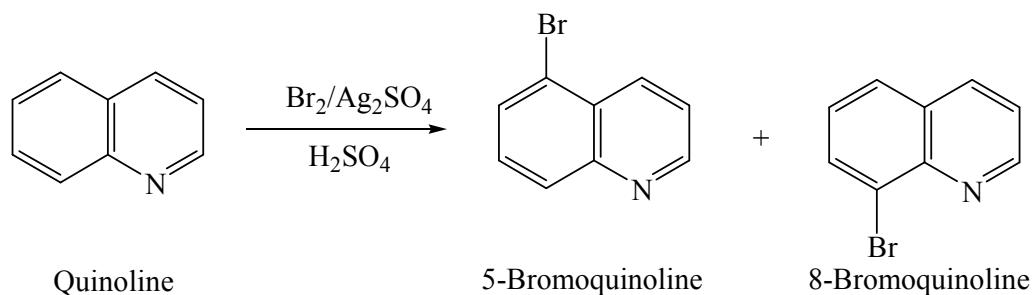
a. At position 5



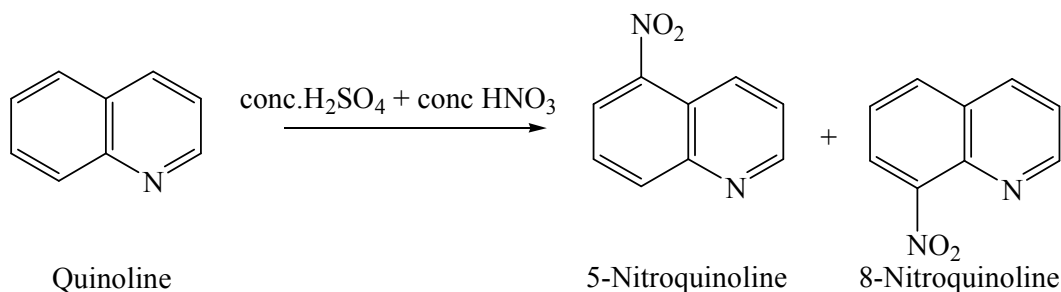
b. At position 8



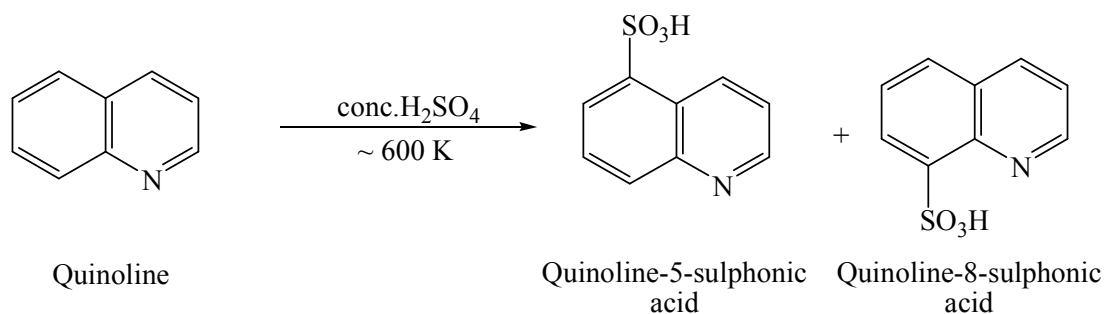
**i. Bromination:** Quinoline undergoes bromination with  $\text{Br}_2$  in presence of silver sulphate ( $\text{Ag}_2\text{SO}_4$ ) and  $\text{H}_2\text{SO}_4$ . Bromination occurs at position 5 and 8 hence mixture of products is formed.



**ii. Nitration:** Quinoline can undergo nitration by reacting with the well known nitrating agent (Conc.  $\text{H}_2\text{SO}_4$  + conc.  $\text{HNO}_3$ ). Nitration of quinoline occurs at position 5 and 8.

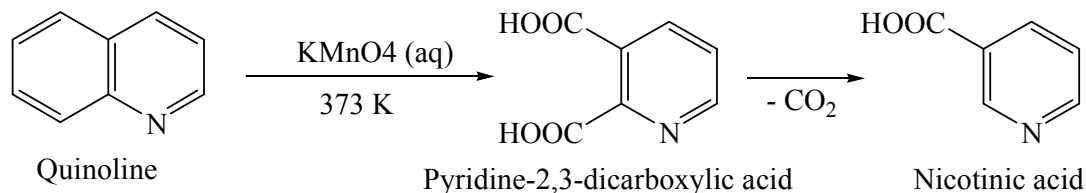


**iii. Sulphonation:** In presence of Conc.  $\text{H}_2\text{SO}_4$  at high temperature ( $\sim 600\text{K}$ ) sulphonation of quinoline takes place. Like nitration or bromination, the sulphonation of quinoline occurs at position 5 and 8.

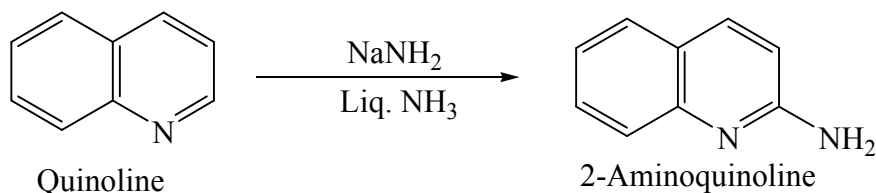




iv. **Oxidation:** In presence of  $\text{KMnO}_4$  quinoline get oxidized to pyridine-2,3-dicarboxylic acid which on decarboxylation gives nicotinic acid.



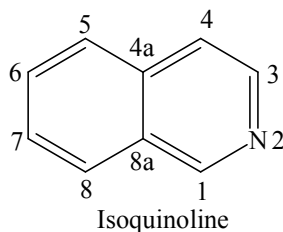
3. **Nucleophilic substitution:** Quinoline also gives nucleophilic substitution reactions. Since, pyridine ring of quinoline is comparatively lesser electron rich in comparison to the benzene ring, therefore, nucleophilic substitution in quinoline takes place on pyridine ring. The nucleophilic substitution on pyridine ring takes place at position 2 of pyridine ring. If position 2 is occupied then the substitution takes place at position 4. Reaction of quinoline with strong base sodium amide (sodamide,  $\text{NaNH}_2$ ) in liquid ammonia gives 2-aminoquinoline.



**Applications of Quinoline:** Quinoline is used

- As a high boiling basic solvent in organic reactions
- Quinoline is used in the manufacture of dyes, the preparation of hydroxyquinoline sulfate and niacin. It is also used as a solvent for resins and terpenes.
- Quinoline is mainly used as in the production of other specialty chemicals.
- Its principal use is as a precursor to 8-hydroxyquinoline, which is a versatile chelating agent and precursor to pesticides.
- Its 2- and 4-methyl derivatives are precursors to cyanine dyes.
- Oxidation of quinoline affords quinolinic acid (pyridine-2,3-dicarboxylic acid), a precursor to the herbicide sold under the name "Assert".
- The reduction of quinoline with sodium borohydride in the presence of acetic acid is known to produce Kairolin A.
- The piperazine antidepressant quipazine is also leucoline based.

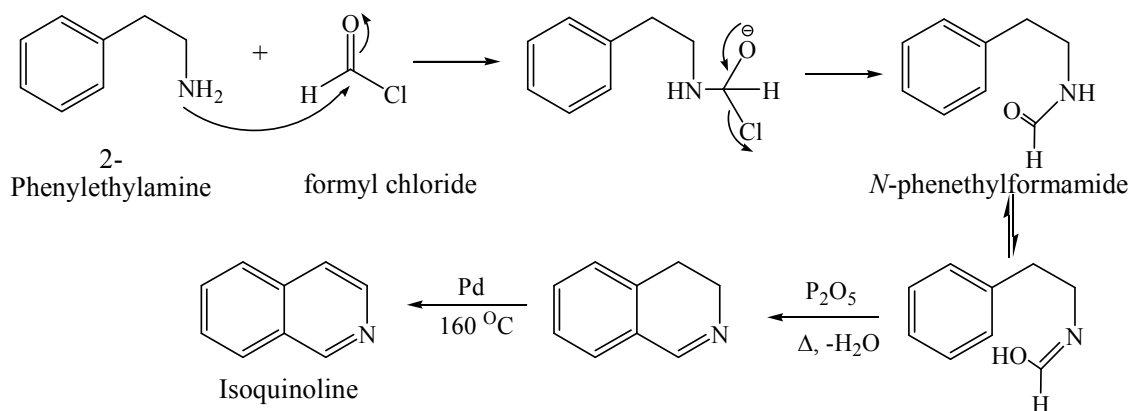
### 5.3.3 ISOQUINOLINE



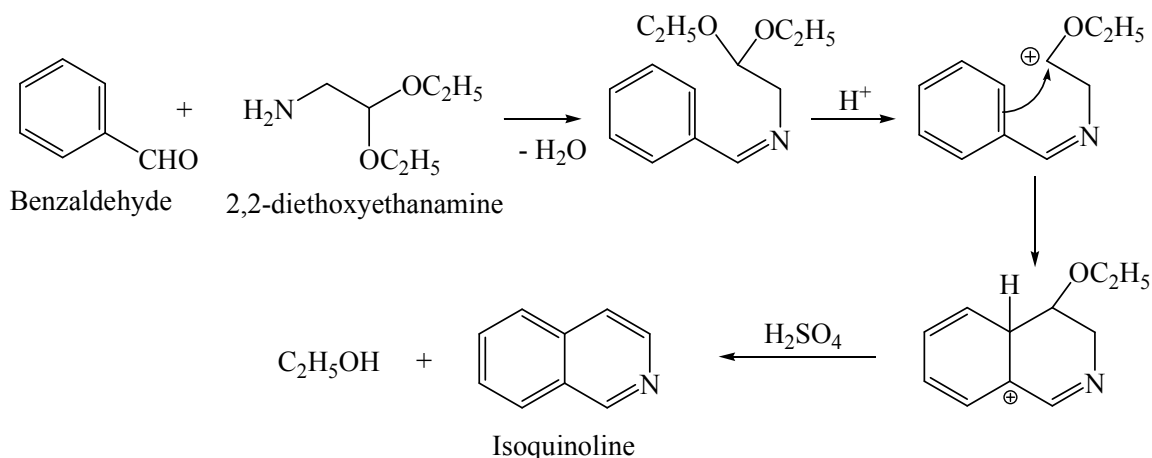
Isoquinoline is a heterocyclic aromatic organic compound. It is a structural isomer of quinoline. Isoquinoline is also obtained by ring fusion of pyridine and with a benzene ring. It was first isolated by Hoogewerff and Drop from the quinoline fraction of coal tar in 1885. Several derivatives of Isoquinoline also occur in coal tar. Isoquinoline does not occur free in nature but finds frequently in several alkaloids. It is called 2-azanaphthalene or benzo[b]pyridine. The numbering of the atoms in Isoquinoline is similar as followed in quinoline; however, the nitrogen atom is assigned position-2. Isoquinoline has close similarities in the structure with quinoline; therefore both have a close relationship in their physical and chemical properties.

**SYNTHETIC METHODS OF ISOQUINOLINE:** Following are the important synthetic methods for the preparation of Isoquinoline.

- 1. The Bischler Napieralski synthesis:** This synthesis was first suggested by the Bischler and Napieralski and has been subjected to a number of improvements later on. This method involves the cyclodehydration of an acyl derivative of B-phenylethylamine to give 3,4-dihydroisoquinoline, in the presence of Lewis acids such as polyphosphoric acid, zinc chloride or phosphorous pentoxide. The 3,4-dihydroisoquinoline is then dehydrogenated by Pd at 160 °C to Isoquinoline. It must be noted that the yields of this reaction are excellent if electron donating groups are present on benzene ring however if the electron withdrawing groups are present on benzene ring the yields are very poor. This is because of the electrophilic ring closure nature of the ring.

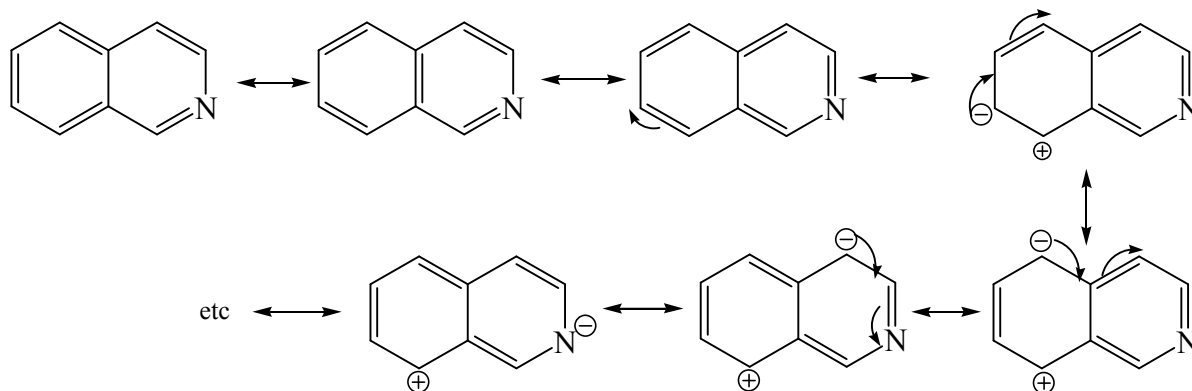


**2. The Pomeranz Fritsch synthesis:** In this synthesis an aromatic aldehyde or a substituted Benzaldehyde is condensed with aminoacetal to give Schiff's base. The Schiff's base thus formed is cyclized in the presence of  $H_2SO_4$  or  $P_2O_5$ . The last step of this reaction is similar to the Skraup synthesis of quinoline.



### PHYSICAL PROPERTIES OF ISOQUINOLINE:

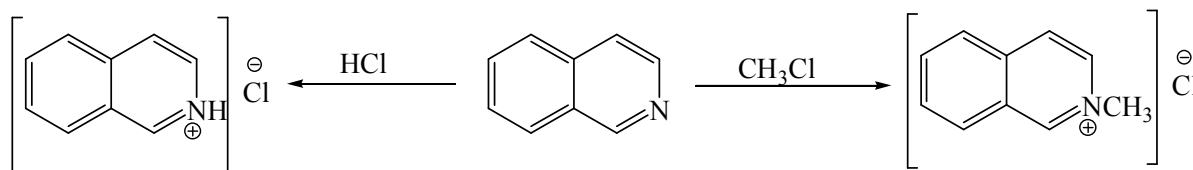
Isoquinoline is a colourless solid with melting point  $243^\circ C$ . It has a smell resembling that of Benzaldehyde. It is steam volatile and sparingly soluble in water but soluble in most of the organic solvents such as ethanol, acetone, diethyl ether, carbon disulfide, and other common organic solvents. It is also soluble in dilute acids as the protonated derivative. Isoquinoline is highly aromatic and may be considered a resonance hybrid of following structures. Similar to pyridine the lone pair of electrons on the nitrogen atom is not conjugated with the ring and therefore, Isoquinoline behaves as weak base.



The pKa of Isoquinoline is 5.14 in compare to quinoline (pKa 4.94). It gets protonated to form salts upon treatment with strong acids, such as HCl. It forms adducts with Lewis acids, such as BF<sub>3</sub>.

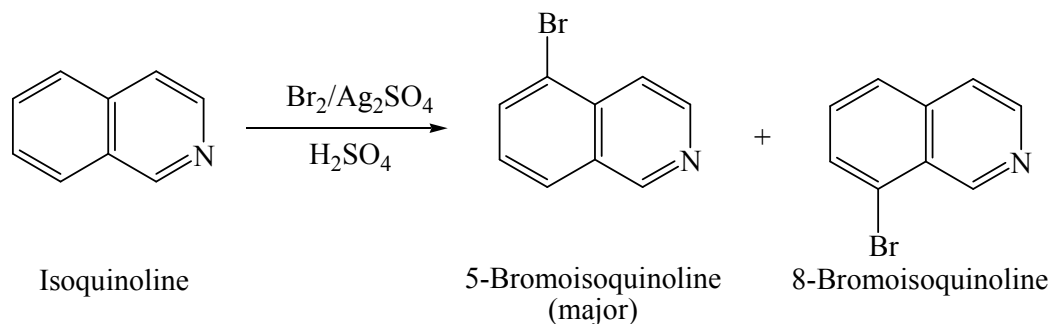
**CHEMICAL PROPERTIES OF ISOQUINOLINE:** The important chemical properties of Isoquinoline are discussed as follow.

- 1. Basicity:** Isoquinoline is moderately basic compound. It reacts with protic acid to form salts, and with alkyl halides to form quaternary ammonium salt.

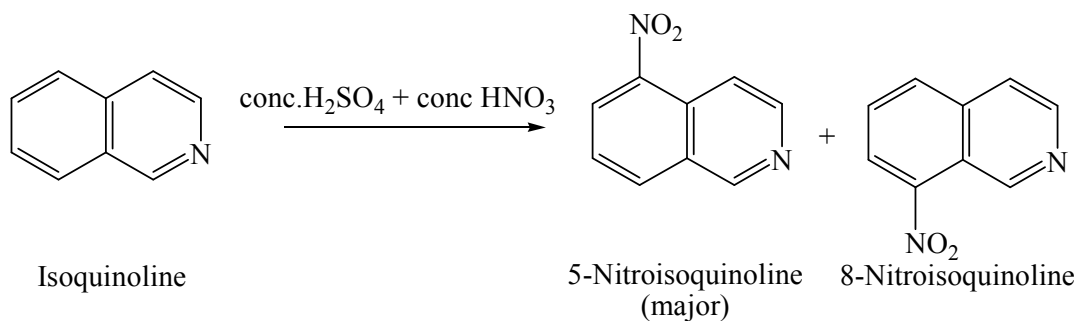


- 2. Electrophilic substitution:** Isoquinoline also gives electrophilic substitution like quinoline. Electrophilic substitution on Isoquinoline takes place more preferentially at position 5 however small amount of substitution also occurs at position 8. The different types of electrophilic substitution reactions of Isoquinoline are discussed as follow.

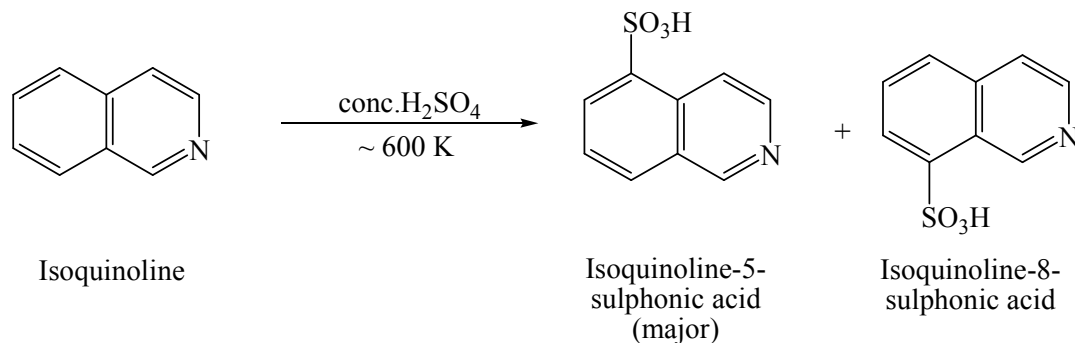
- i. Bromination:** Isoquinoline undergoes bromination with Br<sub>2</sub> in presence of silver sulphate (Ag<sub>2</sub>SO<sub>4</sub>) and H<sub>2</sub>SO<sub>4</sub>. Bromination occurs preferentially at position 5; small amount of product is also formed with substitution at position 8.



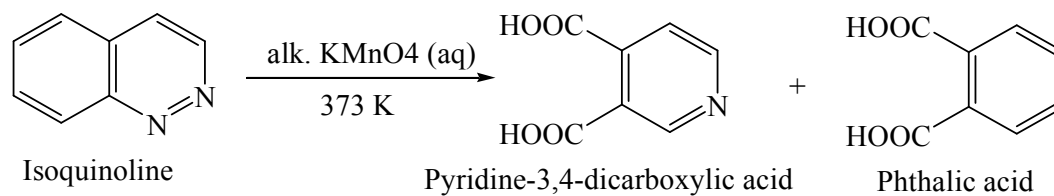
**ii. Nitration:** Isoquinoline can undergo nitration by reacting with the well known nitrating agent (Conc.  $\text{H}_2\text{SO}_4$  + conc.  $\text{HNO}_3$ ). Nitration of Isoquinoline occurs preferentially at position 5; small amount of product is also formed with substitution at position 8.



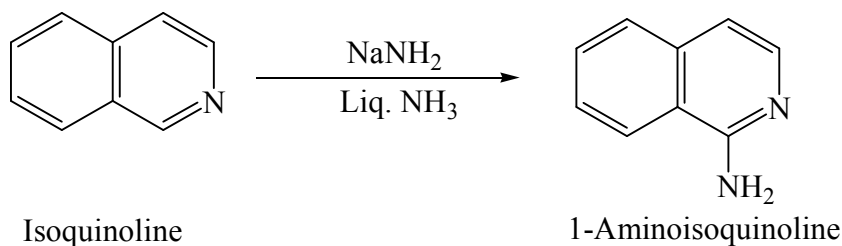
**iii. Sulphonation:** In presence of Conc.  $\text{H}_2\text{SO}_4$  at high temperature ( $\sim 600\text{K}$ ) sulphonation of Isoquinoline takes place. Like nitration or bromination, the sulphonation of Isoquinoline occurs preferentially at position 5; small amount of product is also formed with substitution at position 8.



**v. Oxidation:** In presence of alkaline  $\text{KMnO}_4$  Isoquinoline get oxidized to equimolar mixture of phthalic acid and pyridine-3,4-dicarboxylic acid.



3. **Nucleophilic substitution:** Like Quinoline, Isoquinoline also gives nucleophilic substitution reactions. Since, pyridine ring of Isoquinoline is comparatively lesser electron rich in comparison to the benzene ring, therefore, nucleophilic substitution in Isoquinoline takes place on pyridine ring. The nucleophilic substitution on pyridine ring takes place at position 1 of pyridine ring. Reaction of Isoquinoline with strong base sodium amide (sodamide,  $\text{NaNH}_2$ ) in liquid ammonia gives 1-aminoisoquinoline.



**Applications of Isoquinoline:** Isoquinolines have various applications as:

1. Isoquinoline and its derivatives are used in the manufacture of dyes, paints, insecticides, disinfectants, anesthetics, antihypertension agents and antifungal agents.
2. It is also used as a solvent for the extraction of resins and terpenes, and as a corrosion inhibitor.

## 5.4 SUMMARY

- This unit comprises the detail study of three important bicyclic fused heterocyclic compounds namely Indole, Quinoline and Isoquinoline.
- Indole is an aromatic heterocyclic organic compound with formula  $\text{C}_8\text{H}_7\text{N}$ .
- The name Indole is a combined name of the words **indigo** and **oleum**, since Indole was first isolated by treatment of the indigo dye with oleum.
- Indole is widely distributed in the natural environment.
- Indole is found in coal tar and in essential oils (Jesamine oil, orange oil) of many plants.
- The IUPAC name of Indole is 1H-benzo[b] pyrrole, it is being the b-face benzo-fused isomer.

- All the ring atoms in Indole are  $sp^2$  hybridized.
- Indole is an aromatic compound since it follows the Huckel's rule (*i.e.*  $4n+2\pi$  electron rule) for  $n=2$ .
- The pure form of Indole has very pleasant smell and this is the reason it is used as a perfumery base.
- Indole is a  $\pi$ -excessive aromatic heterocycles with ten  $\pi$ -electrons. Indole is an aromatic compound.
- Indole also gives the electrophilic substitution (the characteristic reactions of aromatic compounds).
- Electrophilic substitution in Indole takes place preferentially at C3.
- Indole and its derivatives are being extensively used in medicinal and pharmaceutical industry.
- Quinoline is a heterocyclic aromatic organic compound with the chemical formula  $C_9H_7N$ .
- It is also called 1-azanaphthalene or benzo[b]pyridine.
- Quinoline was first extracted from coal tar in 1834 by German chemist Friedlieb Ferdinand Runge.
- All the ring atoms in Quinoline are  $sp^2$  hybridized.
- Quinoline is an aromatic compound since it follows the Huckel's rule (*i.e.*  $4n+2\pi$  electron rule) for  $n=2$ .
- Unlike Indole, the lone pair of nitrogen of quinoline does not participate in the delocalization.
- Quinoline also gives the electrophilic substitution (the characteristic reactions of aromatic compounds).
- The electrophilic substitution in quinoline takes place more readily at benzene ring (at position 5 and 8 of benzene ring) rather than the pyridine ring.
- Quinoline and its derivatives are being extensively used in medicinal and pharmaceutical industry.
- Isoquinoline is a heterocyclic aromatic organic compound.
- It is a structural isomer of quinoline.

- It was first isolated by Hoogewerff and Drop from the quinoline fraction of coal tar in 1885.
- It is called 2-azanaphthalene or benzo[b]pyridine.
- Isoquinoline is an aromatic compound since it follows the Huckel's rule (i.e.  $4n+2\pi$  electron rule) for  $n=2$ .
- Isoquinoline also gives the electrophilic substitution (the characteristic reactions of aromatic compounds).
- Electrophilic substitution on Isoquinoline takes place more preferentially at position 5 however small amount of substitution also occurs at position 8.
- Isoquinoline and its derivatives are used in the manufacture of dyes, paints, insecticides, disinfectants, anesthetics, antihypertension agents and antifungal agents.
- It is also used as a solvent for the extraction of resins and terpenes, and as a corrosion inhibitor.

---

### 5.5 *TERMINAL QUESTIONS*

---

1. Give the general introduction of Indole.
2. Discuss the structure of Indole.
3. Explain the Fischer Indole synthesis with mechanism.
4. Why Indole gives electrophilic substitution reactions?
5. Discuss the structure of Quinoline.
6. Explain the Skraup synthesis of Quinoline with mechanism.
7. Explain the Bischler Napieralski synthesis of Isoquinoline with mechanism.
8. What happens when Quinoline and Isoquinoline undergo oxidation with aqueous  $\text{KMnO}_4$ ?

---

### 5.6 *TERMINAL ANSWERS*

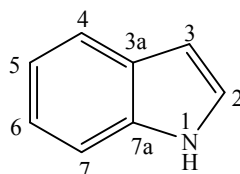
---

1. Indole is an aromatic heterocyclic organic compound with formula  $\text{C}_8\text{H}_7\text{N}$ . It has a bicyclic structure, consisting of a six-membered benzene ring fused to a five membered nitrogen-containing pyrrole ring. Chemistry of Indole was developed with the study of the dye indigo. Indigo can be converted to Isatin and then to Oxindole. Indole was first

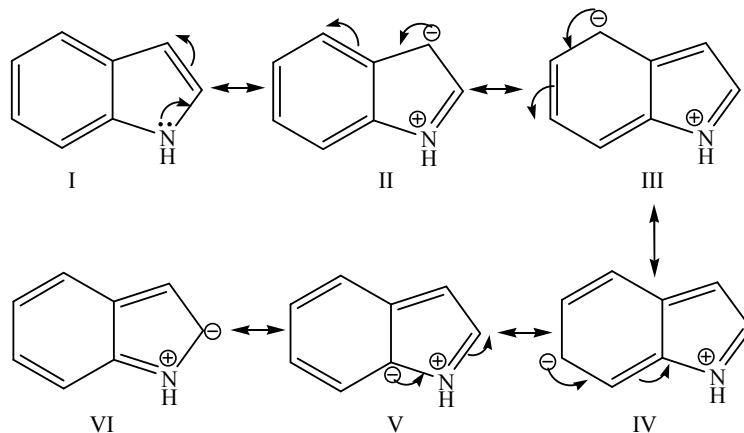


synthesized in 1866, when Adolf von Baeyer reduced Oxindole to Indole using zinc dust. The name Indole is a combined name of the words **indigo** and **oleum**, since Indole was first isolated by treatment of the indigo dye with oleum. Indole is widely distributed in the natural environment and can be produced by a variety of bacteria. As an intercellular signal molecule, it regulates various aspects of bacterial physiology, including spore formation, plasmid stability, drugs resistance, bio-film formation, and virulence. The amino acid tryptophan is an Indole derivative and the precursor of the neurotransmitter serotonin. Indole is found in coal tar and in essential oils (Jesamine oil, orange oil) of many plants. It also occurs in amino acids as a plant growth hormone in alkaloids.

2. The IUPAC name of Indole is 1H-benzo[b] pyrrole, it is being the b-face benzo-fused isomer. The atoms are numbered as shown in below structure. The numbering begins from the Nitrogen atom and going counter clock wise around the two condensed rings.

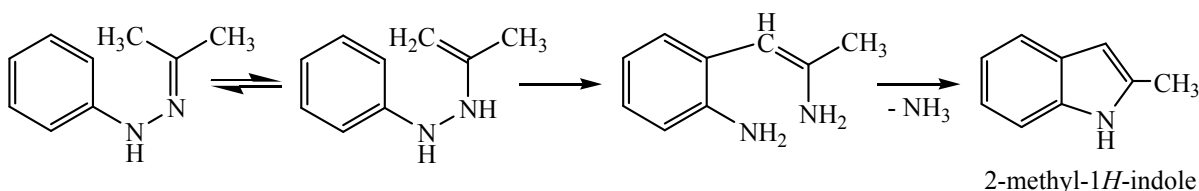


All the ring atoms in Indole are  $sp^2$  hybridized. The  $sp^2$  orbitals of all carbon and nitrogen atom overlap with each other and also with the s orbitals of hydrogen to form C-C, C-N, C-H and N-H  $\sigma$  bonds. Each ring atom also possesses a p orbital. These are perpendicular to the plane of the ring. Lateral overlap of these p-orbitals produce a  $\pi$  molecular orbital containing 10 electrons. Indole is an aromatic compound since it follows the Huckel's rule (*i.e.*  $4n+2\pi$   $\pi$  electron rule) for  $n=2$ . Indole is a resonance hybrid of several canonical forms. The different possible canonical forms of Indole are shown in Figure 2. Structures IV, V and VI involve the formation of a non-benzenoid system in which the aromaticity of benzene ring dose not retained. Hence, these structures contribute less in the resonance.

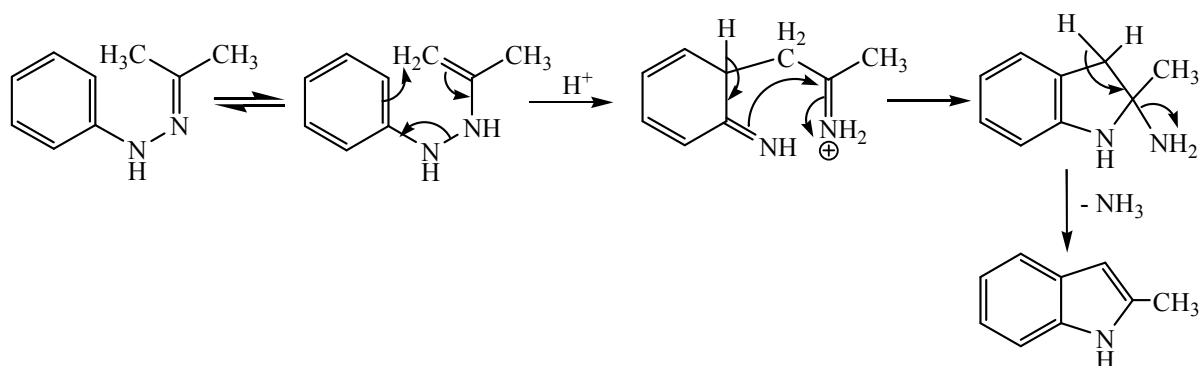


**Figure 2:** Different possible canonical forms of Indole

- 3. The Fisher-Indole synthesis:** This is the most widely used method for the synthesis of Indole. It involves an acid (Lewis acid) catalyzed rearrangement of a phenylhydrazone of an aldehyde or ketone, with the elimination of a molecule of ammonia. The conventional catalysts used in this process are zinc chloride, polyphosphoric acid or a Lewis acid ( $\text{BF}_3$ ). Synthesis of 2-methyl indole can be achieved by taking the phenylhydrazone of acetone. The reaction is as shown below.

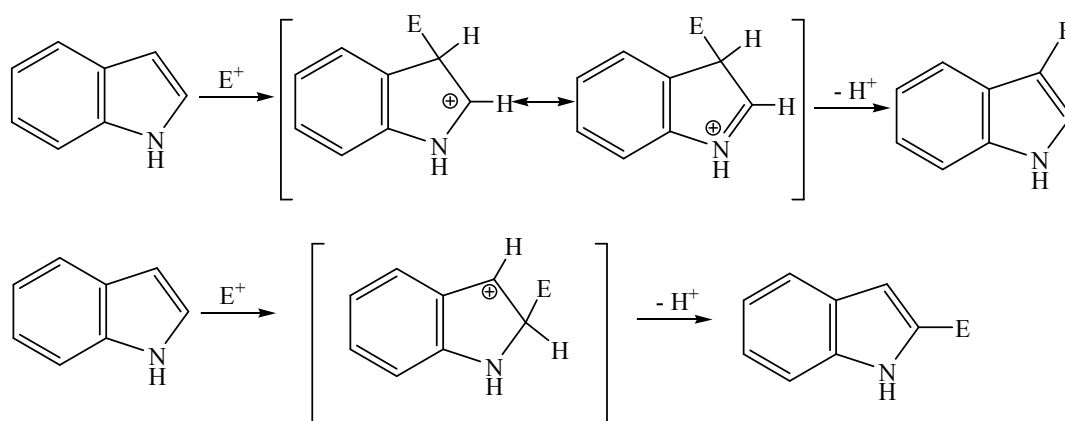


**Mechanism:** Fisher-Indole synthesis is supposed to take place through the acid catalyzed rearrangement of the tautomeric form of the starting phenylhydrazone as shown below.

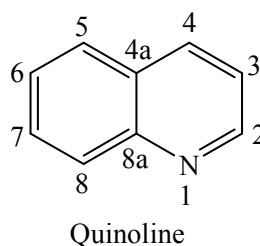


4. Indole is a  $\pi$ -excessive aromatic heterocycles with ten  $\pi$ -electrons. Indole is an aromatic compound. It involves the  $4n+2\pi$  electrons and hence follows the Huckel rule of

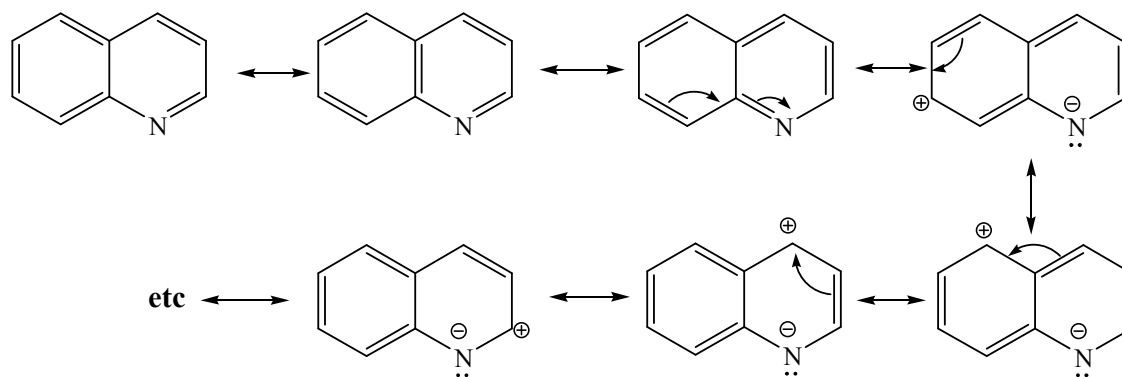
aromaticity. The lone pair of  $sp^2$  hybridized nitrogen atom participates in the delocalization process and thus helps to complete the ten  $\pi$ -electron across the ring. Like pyrrole, the  $\pi$  excessive nature of the aromatic ring governs the reactivity and chemical properties of Indole. Indole is a weak base ( $pK_a = -2.4$ ). In presence of a strong acid protonation of the nitrogen atom would disrupt the aromaticity of the five-membered ring. Like other aromatic compounds, Indole also gives the electrophilic substitution (the characteristic reactions of aromatic compounds). However, unlike pyrrole, electrophilic substitution in Indole takes place preferentially at  $C_3$ . A simple explanation for this can be made by analysis of the Wheland intermediates resulting from the attack of an electrophile at  $C_3$  and  $C_2$  positions. For a reaction at  $C_3$ , the energy of activation of the intermediate is lowered because it is possible to delocalize the positive charge through resonance involving the nitrogen lone pair of electrons. This favourable situation is not possible in the corresponding intermediate for attack at  $C_2$ .



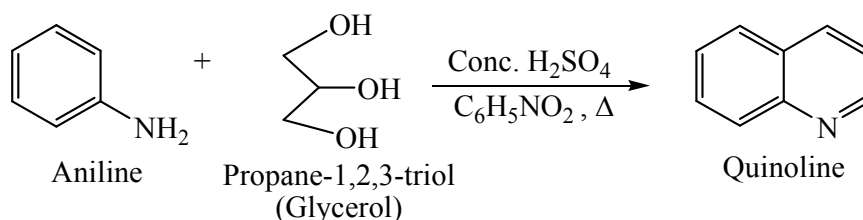
5. The IUPAC name of quinoline is benzo[b]pyridine; it is being the b-face benzo-fused isomer. The atoms are numbered as shown in below structure. The numbering begins from the Nitrogen atom and going counter clock wise around the two condensed rings. The structure of quinoline is shown as follow.



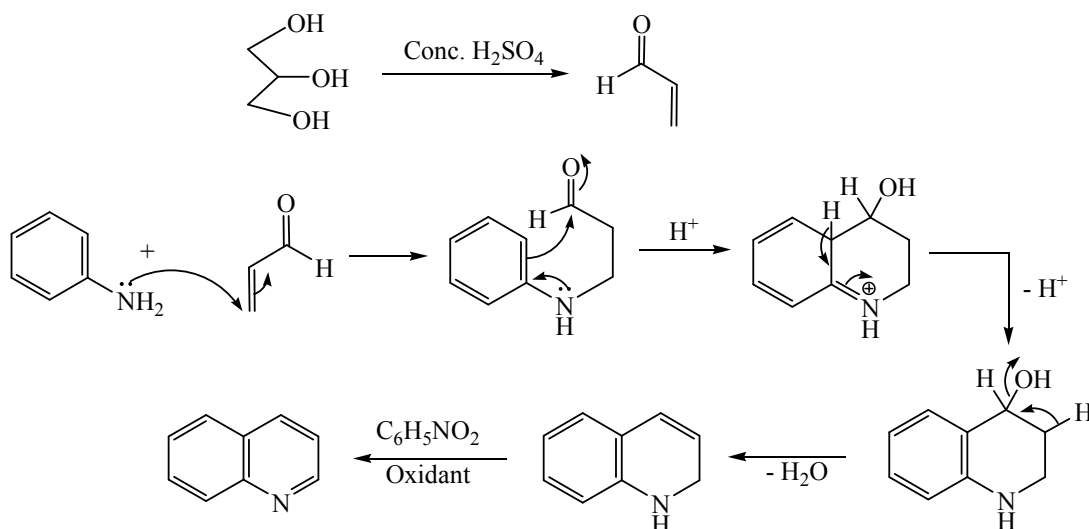
All the ring atoms in Quinoline are  $sp^2$  hybridized. The  $sp^2$  orbitals of all carbon and nitrogen atom overlap with each other and also with the s orbitals of hydrogen to form C-C, C-N, and C-H  $\pi$  bonds. Each ring atom also possesses a p orbital. These p orbitals are perpendicular to the plane of the ring. Lateral overlap of these p-orbitals produce a  $\pi$  molecular orbital containing 10  $\pi$  electrons. Quinoline is an aromatic compound since it follows the Huckel's rule (i.e.  $4n+2\pi$  electron rule) for  $n=2$ . Unlike Indole, the lone pair of nitrogen of quinoline does not participate in the delocalization. Quinoline is a resonance hybrid of several canonical forms as shown below.



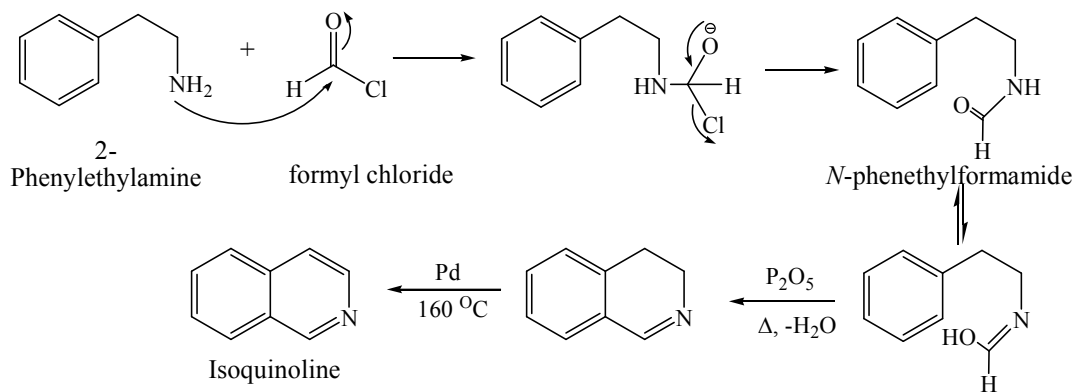
6. **The Skraup synthesis:** This is one of the most important methods for the preparation of quinoline. In this method the aniline and its derivatives having vacant ortho position is when heated with glycerol, concentrated  $H_2SO_4$  and an oxidizing agent the resultant product is obtained as quinoline or its derivatives. The nitrobenzene is generally used as mild oxidizing agent in Skraup synthesis. Glycerol when heated with concentrated  $H_2SO_4$  it gives the acrolein after dehydration. Condensation of acrolein thus obtained with aniline or its derivatives followed by oxidation gives the quinoline. The reaction is shown as follow.



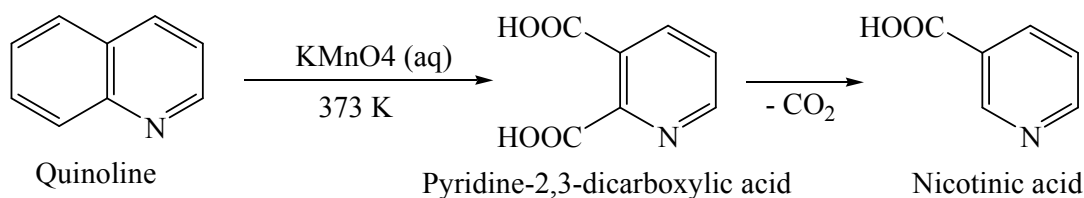
**Mechanism:** The step wise mechanism of Skraup synthesis of quinoline is given as follow.



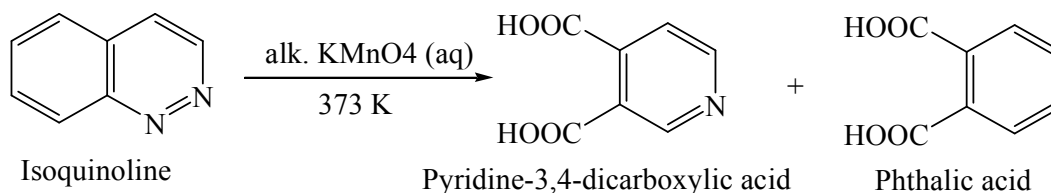
7. **The Bischler Napieralski synthesis:** This synthesis was first suggested by the Bischler and Napieralski and has been subjected to a number of improvements later on. This method involves the cyclodehydration of an acyl derivative of B-phenylethylamine to give 3,4-dihydroisoquinoline, in the presence of Lewis acids such as polyphosphoric acid, zinc chloride or phosphorous pentoxide. The 3,4-dihydroisoquinoline is then dehydrogenated by Pd at  $160\text{ }^\circ\text{C}$  to Isoquinoline. It must be noted that the yields of this reaction are excellent if electron donating groups are present on benzene ring however if the electron withdrawing groups are present on benzene ring the yields are very poor. This is because of the electrophilic ring closure nature of the ring.



8. **Oxidation:** In presence of  $\text{KMnO}_4$  quinoline get oxidized to pyridine-2,3-dicarboxylic acid which on decarboxylation gives nicotinic acid.



However, in presence of alkaline  $\text{KMnO}_4$  Isoquinoline get oxidized to equimolar mixture of phthalic acid and pyridine-3,4-dicarboxylic acid.



## 5.7 BIBLIOGRAPHY

6. "Heterocyclic Chemistry" by Raj K. Bansal 5<sup>th</sup> Edn, New Age International Publisher, ISBN 978-81-224-3143-8.
7. "Heterocyclic Chemistry" 5<sup>th</sup> Edn. by J. A. Joule, K. Mills and G. F. Smith, Wiley International Publications, ISBN: 978-1-4051-3300-5.
8. "Heterocyclic Chemistry" (3rd Edition) by Thomas. L. Gilchrist, Prentice Hall Publication, ISBN 978-0-5822-7843-1.
9. "Organic Chemistry" Vol. 1 by I L Finar, Published by Pearson Education; ISBN 10: 8177585428.
10. "Organic Chemistry" by T. W. Graham Solomons, Published by John Wiley; ISBN-10: 1118133579.

---

## UNIT-6 AMINO ACIDS, PEPTIDES, PROTEINS

---

### CONTENTS:

- 6.1 Objectives
- 6.2 Introduction
- 6.3 Classification
- 6.4 Structure and stereochemistry of amino acids
- 6.5 Acid base behavior
- 6.6 Isoelectric point and electrophoresis
- 6.7 Selective hydrolysis of peptides and proteins
- 6.8 Level of protein structure
- 6.9 Protein denaturation.
- 6.10 Enzymes, Coenzymes, Cofactors and Vitamins
- 6.11 Summary
- 6.12 Terminal Question
- 6.13 Answers

---

### ***6.1 OBJECTIVE***

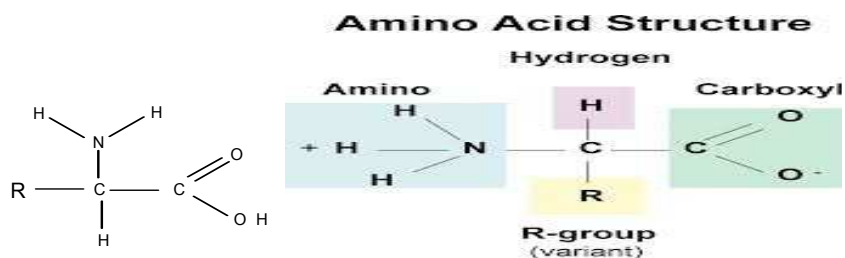
---

- After completion of this unit, the student should be able to:
- Define terms associated with amino acids and protein.
- Classification of Amino Acids
- Explain the difference between essential and nonessential amino acids.
- Acids and Bases behaviour of an amino acid.
- Classification of protein.
- Structure of protein.
- Functions of protein.
- Describe the biological value of protein
- Enzymes, Coenzymes, Cofactors and Vitamins

## 6.2 INTRODUCTION

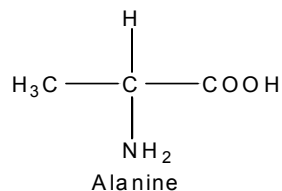
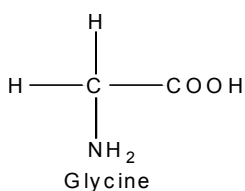
Proteins are very big molecules made up of smaller units known as ‘amino acids’. Amino acids are organic molecules that contain an amino group and a carboxylic acid group. All amino acids have a simple chemical backbone with an amine group (the nitrogen containing part) at one end. At the other end is the acid part. This backbone is the same for all amino acids. The difference between them depends on a distinctive structure, the chemical side chain that is attached to the backbone. It is the nature of the side chain that gives identity and chemical nature to each amino acid. There are about 20 different naturally occurring amino acids that combine to form proteins of all living tissue. The amino acids that make up proteins differ from fats and carbohydrates in that they contain the element nitrogen.

The amino acids in proteins are called alpha ( $\alpha$ )-amino acids because the amino group is attached to the  $\alpha$ -carbon. A carbon connected to any carboxylic acid carbon is termed a  $\beta$ -carbon. Amino acids are generally represented using the following formula:



‘R’ varies from one amino acid to another. The  $\text{NH}_2$  part is the amino group and  $\text{COOH}$  the acid group. The simplest amino acid is glycine, where ‘R’ is a hydrogen atom. In alanine, ‘R’ is  $\text{CH}_3$ , known as the methyl group.





All amino acids (except proline) contain –H, –NH<sub>2</sub>, and –COOH bound to the α-carbon. They are differentiated by the side chains (called R-groups) also bound to the α-carbon. Amino acids occur widely in nature and have a number of uses in the human body.

---

### 6.3 CLASSIFICATION OF AMINO ACIDS

---

The difference between amino acids depends on their side-chain R groups because this is the only point of difference (all amino acids contain a carboxyl group, an amino group, and an H). The most important characteristic of R groups is polarity. As a result, amino acids are classified into four groups: nonpolar, polar acidic, polar basic, and polar-neutral amino acids. Amino acids are known by common names and each is abbreviated using a three-letter code.

The 20 amino acids commonly used to make proteins in the human body are listed in the following table. Essential amino acids cannot be made in the body and must be obtained in the diet. Non-essential amino acids are needed but don't have to be obtained from the diet because the body produces them.

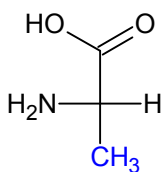
#### Essential Amino Acids:

- Histidine
- Isoleucine
- Leucine
- Lysine
- Methionine
- Phenylalanine
- Threonine
- Tryptophan
- Valine

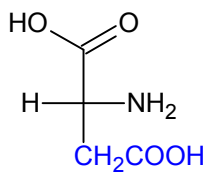
**Non-Essential Amino Acids:**

- Alanine
- Arginine
- Asparagine
- Aspartic Acid
- Cysteine
- Glutamic Acid
- Glutamine
- Glycine
- Proline
- Serine
- Tyrosine

You need all of the essential amino acids in adequate amounts in order for protein synthesis to occur in the body. If one essential amino acid is not present, the protein cannot be made.



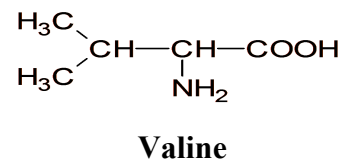
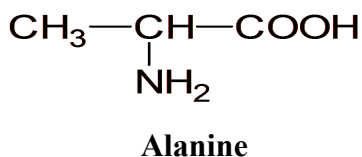
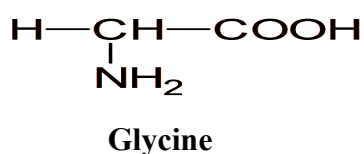
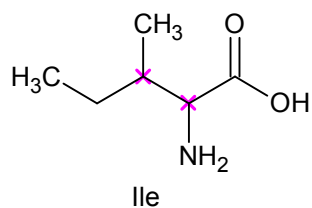
**Alanine(Ala)**



**Aspartic Acid (Asp)**

1. Name an amino acid besides threonine = Thr that has more than one asymmetric center.

**Isoleucine = Ile**



## 6.4 STRUCTURE AND STEREOCHEMISTRY OF AMINO ACIDS

In amino acid, there is a central carbon atom attached to hydrogen, a carboxylic acid group, an amine group and an alkyl group. Amino acids are thus all chiral except for glycine, in which the R is another H atom.

### Optical activity:

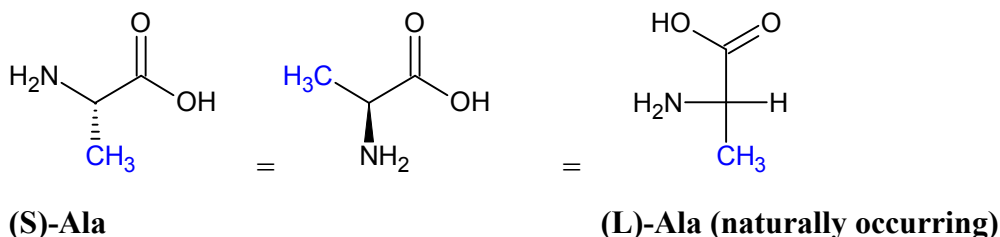
- All amino acids except glycine are optically active due to asymmetric  $\alpha$ -C atom.
- They occur in D and L forms the naturally occurring amino acids in proteins are of the L- $\alpha$  amino acid form. D-amino acids are found in some antibiotics and bacteria.

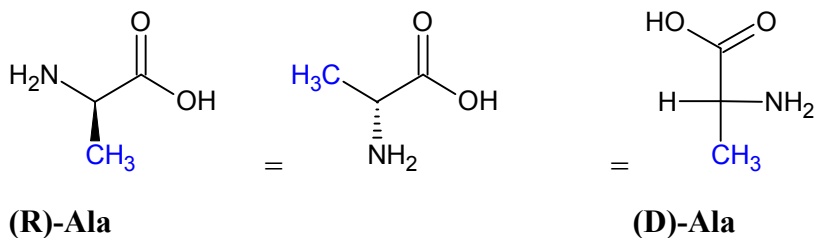
All  $\alpha$ -amino acids, except glycine, are **chiral** because the  $\alpha$ -carbon is bound to *four different* groups. Glycine is exempt because it has two hydrogen atoms attached to the  $\alpha$ -carbon (recall chiral carbons must have four different groups attached).

As chiral molecules, amino acids can exist as D or L isomers. When writing Fischer projections for amino acids, the -COOH group is always written at the top and the R group at the bottom. If the  $\text{NH}_2$  is on the Left we have the L- isomer, if it is on the right, we have the D- isomer. In biological systems, only L isomers are found in proteins.

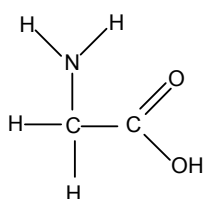
An example: L-Alanine, and D-Alanine

2.



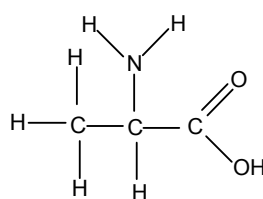


Some simple examples are:



glycine

aminoethanoic acid



alanine

2-aminopropanoic acid

## 6.5 ACIDS AND BASES BEHAVIOUR

Amino acids contain an acidic group ( $\text{-COOH}$ ) and a basic group ( $\text{NH}_2$ ). The carboxylic acid ( $\text{COOH}$ ) has a tendency to donate  $\text{H}^+$  and the amine group ( $\text{NH}_2$ ) has a tendency to accept  $\text{H}^+$ .

The product of this “internal” acid-base reaction is a dipolar ion (two poles) called a *zwitterion* (from the German meaning “double ion”). When the carboxylic acid donates  $\text{H}^+$  it becomes carboxylate ( $\text{COO}^-$ ). Therefore, the name indicates whether  $\text{H}^+$  is present (carboxylic acid) or absent (carboxylate).

For example: glutamic acid ( $\text{H}^+$  present on carboxylic acid) and glutamate ( $\text{H}^+$  absent).

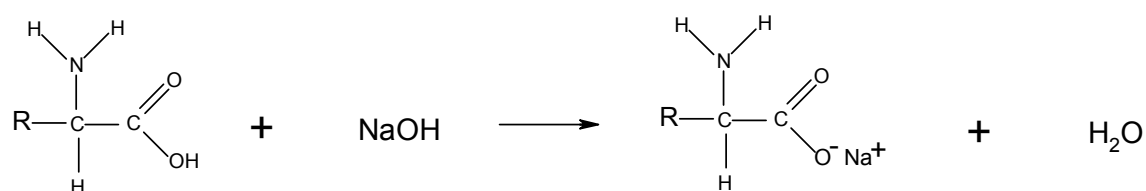
### Zwitterion:

Every amino acid has a carboxyl group and an amino group, and each group can exist in an acidic form or a basic form, depending on the pH of the solution in which the amino acid is dissolved. Zwitterions are simultaneously electrically charged and electrically neutral. They contain positive and negative charges that cancel resulting in a net charge of zero. A **zwitterion** is a compound that has a negative charge on one atom and a positive charge on a nonadjacent

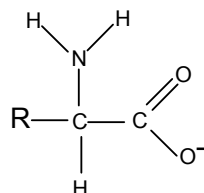
atom. (The name comes from *zwitter*, German for “hermaphrodite” or “hybrid.”). Zwitterions are the neutral form of the amino acid despite the presence of “ion” in the name.

Zwitterions gain  $H^+$  in acidic solutions and lose  $H^+$  in basic solutions. Carboxylic acids have acidic properties and react with bases. Amines have basic properties and react with acids. It therefore follows that amino acids have both acidic and basic properties.

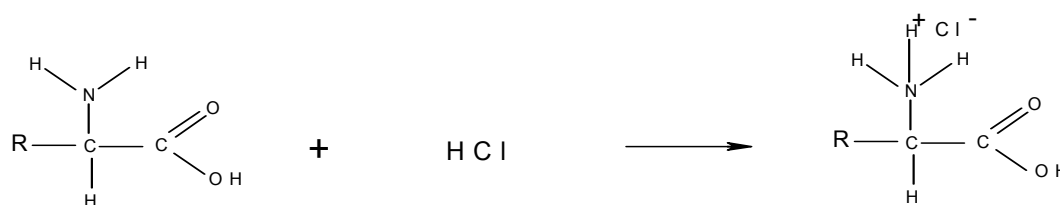
i) Reaction with bases: Amino acids react with strong bases such as sodium hydroxide:



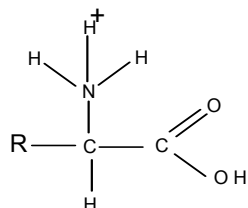
In **high pH**, therefore, amino acids exist in anionic form:



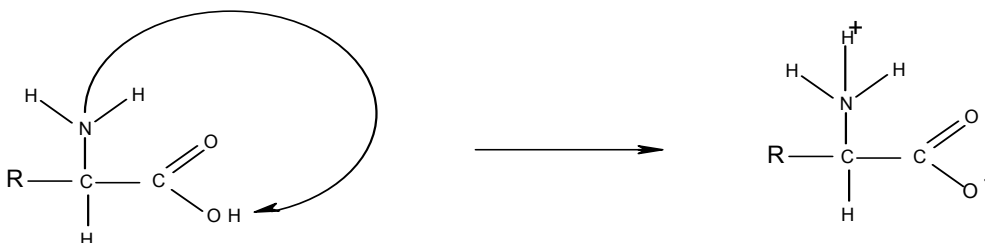
ii) Reaction with acids: Amino acids react with strong acids such as hydrochloric acid:



In **low pH**, therefore, amino acids exist in cationic form:

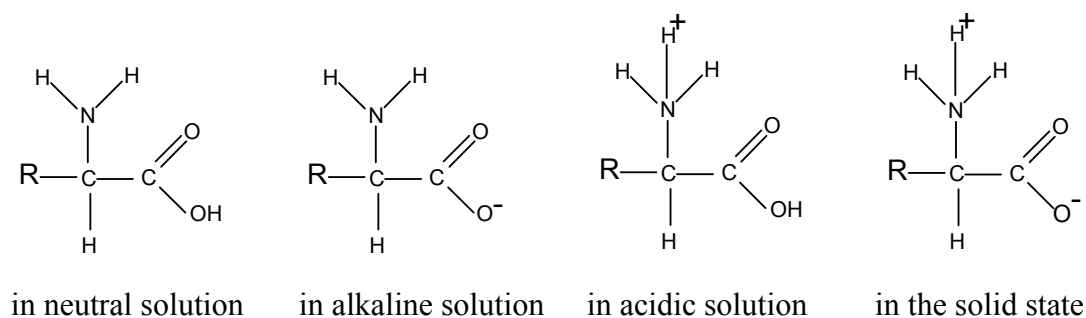


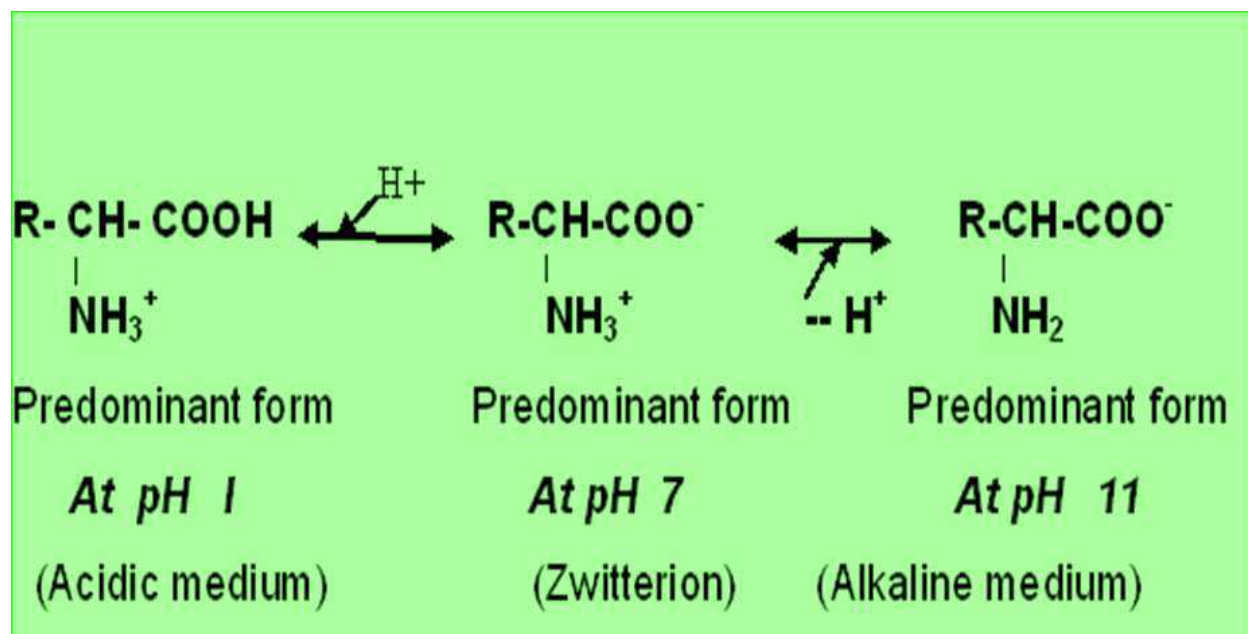
iii) Reaction with itself: Since amino acids have a proton donating group and a proton accepting group on the same molecule, it follows that each molecule can undergo an acid-base reaction with itself:



The double ion that is formed as a result of this reaction is called a **Zwitterion**. This reaction happens in the solid state. In the solid state, therefore, amino acids are ionic. This explains why they are solids with a high melting point.

iv) Summary: Amino acids can exist in molecular form, in cationic form, in anionic form or in Zwitterion form depending on the environment:





Since amino acids can react with acids and alkalis, they make very effective **buffer solutions**.

## 6.6 ISOELECTRIC POINT AND ELECTROPHORESIS

The **isoelectric point** (pI) of an amino acid is the pH at which it has no net charge. It is the pH at which the protein carries equal positive and negative charges i.e. electrically neutral i.e. protein molecule occurs as a zwitterion. In other words, it is the pH at which the amount of positive charge on an amino acid exactly balances the amount of negative charge:

**pI (isoelectric point) = pH at which there is no net charge**

At some intermediate pH, the amino acid is present in an electrically neutral form. At this pH, called the isoelectric point (pI), the amino acid exists almost exclusively in the dipolar form. The isoelectric point depends on the structure of an amino acid. Neutral amino acids have isoelectric points in the pH range of 5.

Aspartic and glutamic acids contain an extra carboxyl group and at neutral pH values they are mainly present in anionic form. To convert this anion into a neutral dipolar ion (in other words to reach the p~ some quantity of an acid must be added. Thus, the isoelectric point of dicarboxylic amino acids is in the range of 3.

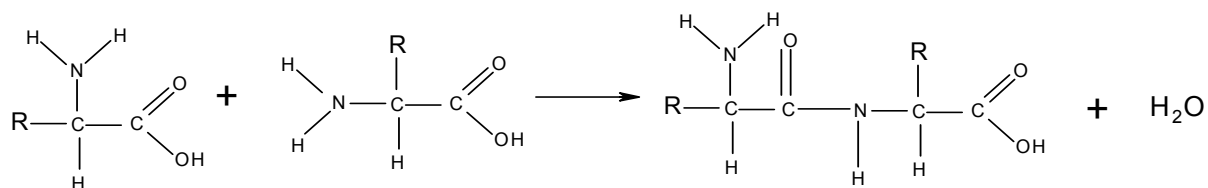
For a similar reason, the isoelectric points of basic amino acids are in the basic region of pH. Due to amphoteric nature of amino acids they are able to neutralize small quantities of acids or bases,

thus maintaining a constant pH of the solution. Such compounds are termed buffers and are used in biochemical investigations.

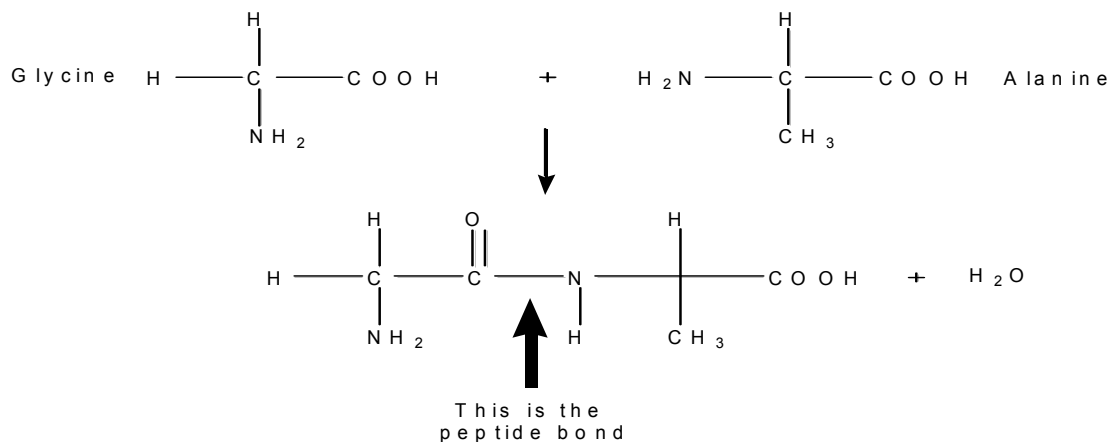
A mixture of amino acids can be separated by **electrophoresis method**, which separates amino acids on the basis of their isoelectric point values. In this method, a few drops of a solution of an amino acid mixture are applied to the middle of a piece of filter paper or to a gel. When the paper or the gel is placed in a buffered solution between two electrodes and an electric field is applied, an amino acid with a pI greater than the pH of the solution will have an overall positive charge and will migrate toward the cathode (the negative electrode). The farther the amino acid's pI is from the pH of the buffer, the more positive the amino acid will be and the farther it will migrate toward the cathode in a given amount of time. An amino acid with a pI less than the pH of the buffer will have an overall negative charge and will migrate toward the anode (the positive electrode). If two molecules have the same charge, the larger one will move more slowly during electrophoresis because the same charge has to move a greater mass.

### Peptide bond

Since amino acids have both acid and amine groups, two molecules can therefore react with each other to form a molecule containing a peptide or amide link. Amino acids can link together to form chains of variable length. To do this, the acid group of one amino acid interacts with the amino group of an adjacent amino acid. The linkage formed is known as a peptide bond. Peptide bond is formed between the amino group of one amino acid and the carboxylic group of another amino acid with the removal of water. Two amino acids are linked together they form a dipeptide; if 3 they form tripeptides and so on. Polypeptides may contain more than 10 and up to 100 amino acid residues, while peptides containing more than 100 amino acid residues are called proteins.

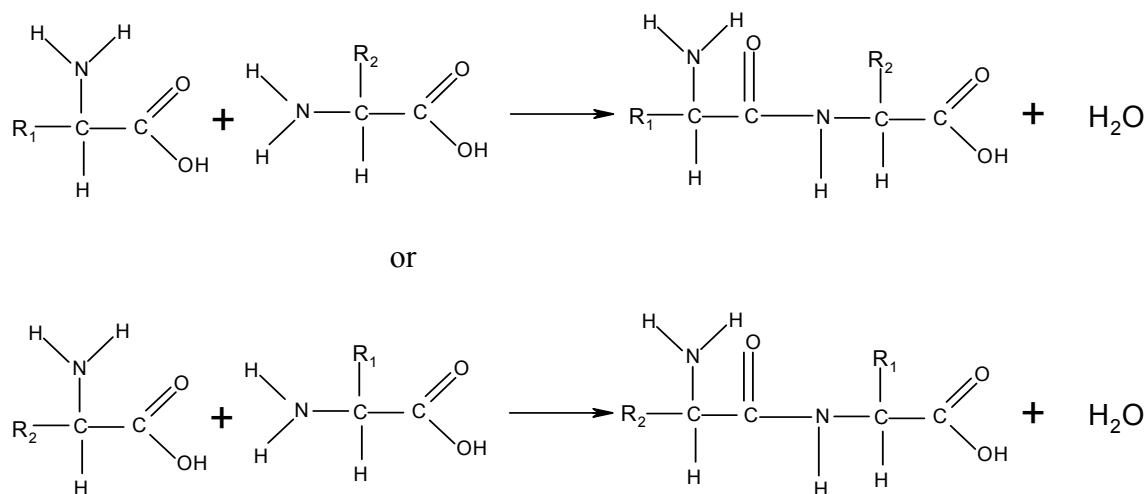




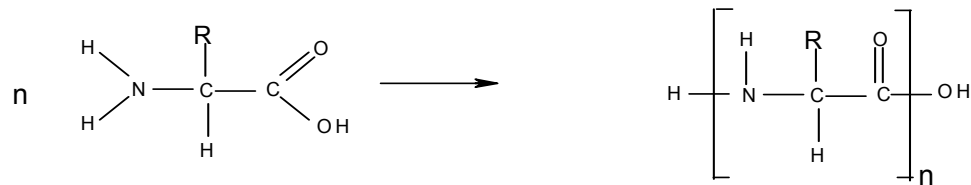


This dipeptide (two amino acids linked together) is known as glycylalanine and is represented as Gly-Ala using the three-letter amino acid coding system. This reaction is called a condensation reaction because two amino acid molecules join together and one molecule of water is eliminated.

Dipeptides can also be formed by the condensation of two different amino acids. In this case two different molecules can be formed:



Since the resulting dipeptides also have both amine groups and carboxylic acid groups, they can undergo further condensation reactions, eventually forming polymers:



## PROTEINS

The word protein is derived from the Greek word proteios, meaning "protein" a "first". The word indicates the importance of these substances. Proteins are formed of amino acid residues linked together by peptide bonds. The resulting polymer is called a **protein**, and is an essential component of living organisms.

Proteins are naturally occurring polyamides formed by the condensation of many amino acid molecules under carefully controlled conditions. Proteins are naturally occurring polymers of amino acid monomer units joined by a peptide bond. Chemically, polymerization of amino acids into protein is a dehydration reaction. They are of high molecular weight (more than 5000), colloidal in nature, non dialysable and heat labile.

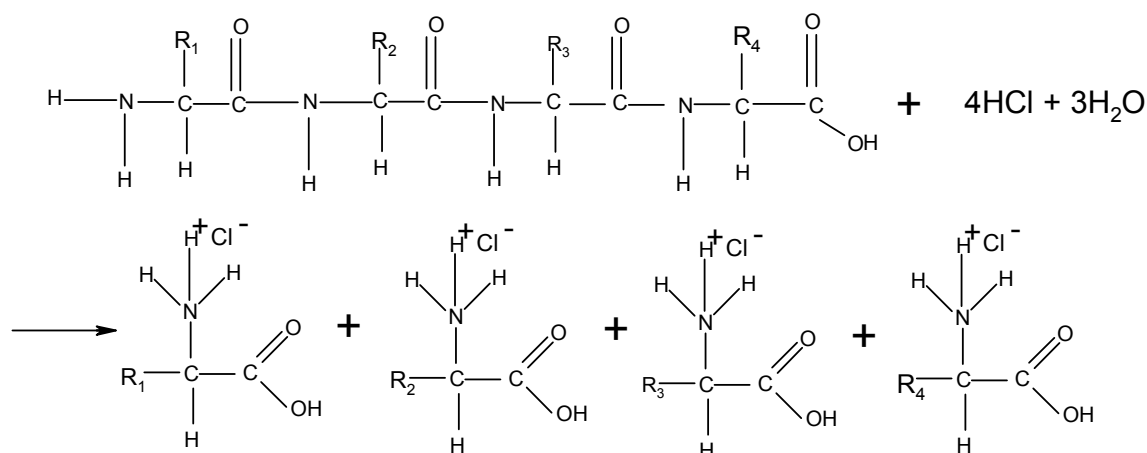
**Proteins** are naturally occurring organic polymers that are composed of monomer units called amino acids. Amino acids contain a carbon atom with two functional groups, an amino group, (NH<sub>2</sub>), and a carboxylic acid group, (COOH) attached. This central carbon atom also has a hydrogen atom and another organic group, an "R" group, attached. The identity of the R group determines the identity of the amino acid.

Proteins play an important role in a variety of biological systems, i.e.: oxygen transport, components of skin and hair, muscle movement, as biological catalysts (enzymes), regulate metabolic processes (hormones), and the list goes on and on and on. Proteins are large complex polymers of amino acids, the monomeric unit of proteins. Amino acids are connected by an amide linkage called a peptide bond. Our study of proteins begins with a survey of amino acids commonly found in proteins. It has been estimated that about 18% of the human body is made up of protein. Like carbohydrates and fats, proteins are made up of the elements carbon (C), hydrogen (H) and (O) but they also contain nitrogen (N).

The sequence of the amino acids dictates the properties of a protein. Examples of proteins include keratin in hair, hemoglobin, insulin, antibodies, and enzymes.

## 6.7 SELECTIVE HYDROLYSIS OF PEPTIDES AND PROTEINS

The peptide link in proteins is the same as the peptide link in N-substituted amides. As a result it can be broken by heating in strong acid or strong alkali. Proteins can thus be broken down into their constituent amino acids by heating in strong acid or strong alkali; in practice  $6 \text{ mol dm}^{-3}$  HCl is generally used. This reaction is an example of a hydrolysis reaction. In acidic conditions the amino acids are produced in cationic form:



This hydrolysis reaction enables chemists to deduce which amino acids are present in a sample of protein. The different amino acids can be identified by chromatography. If a sample of the amino acid mixture is placed onto chromatography paper and allowed to separate, it is possible to identify the different amino acids present in the sample by comparing their  $R_f$  values (the distance each amino acid moves up the paper compared to the solvent) with those of known amino acids.

## 6.8 LEVEL OF PROTEINS STRUCTURE

Proteins differ from each other in the sequence of the amino acids that form a particular chain. They also differ in the way that the protein chain (also called a peptide chain) is linked, coiled, or twisted. Protein molecules are described by several levels of structure. It can be explained under four headings.

**6.8.1 Primary structure:** refers to sequence of amino acids in a poly peptide chain. If this sequence changes then nature and function of protein changes. The sequence of amino acids in a protein is known as the **primary** structure of the protein. It varies from protein to protein, depending on the function that the protein needs to perform.

Eg: gly – ala – leu – iso – gln

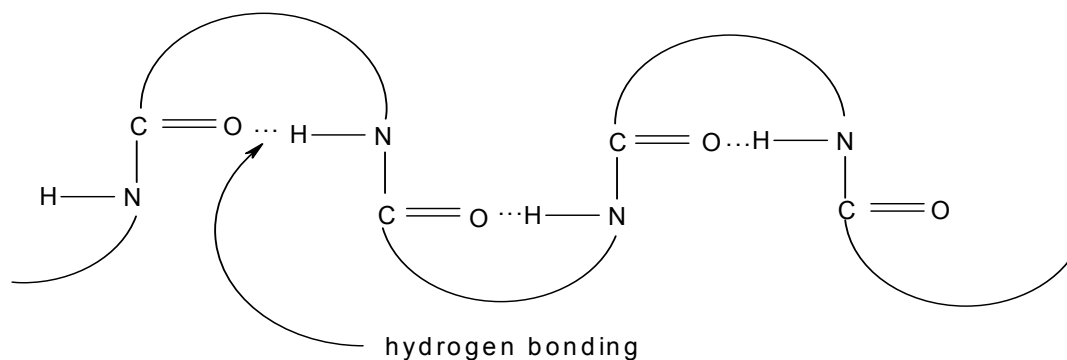
(each of these three-letter symbols is the code for an amino acid)

A protein can have several thousand amino acids, all arranged in a specific order.

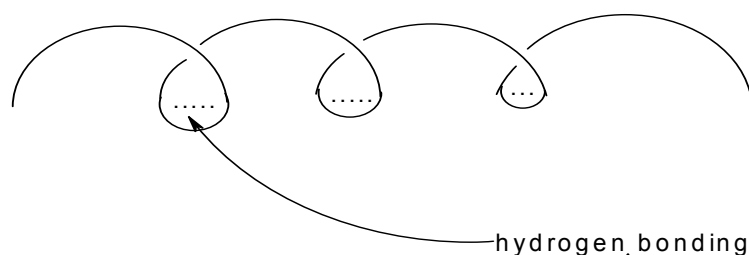
Chemically, the backbone of every chain is -C-C-N-. This backbone is also called a peptide chain. If two amino acids join in a chain, it is called a dipeptide. A number of amino acids in a chain are called polypeptide. Molecules of water bind to both the backbone and polar groups of proteins. Polypeptide and proteins are formed from amino acids by a condensation reaction in which one amino acid loses -OH from -COOH and another loses -H from -NH<sub>2</sub> to form a peptide bond. Repetition of this reaction (polymerization) converts dipeptide to polypeptide and these in turn to proteins. A strand formula for an amino acid, with the variable group R, has been used in the diagram. Breakdown of proteins to polypeptide to amino acids is the reverse process, an enzyme-catalyzed hydrolysis.

**6.8.2. Secondary structure:** *Secondary structure* refers to the shape in which a long polypeptide chain can exist. This describes the conformation of segments of the backbone chain of a peptide or protein. This structure is resulted due to regular folding of long polypeptide chain. This folding is caused due to H-bonding between H atom of -NH group and oxygen atom of CO group of different amide same or different polypeptide chain. To minimize energy, a polypeptide chain tends to fold in a repeating geometric structure such as an  $\alpha$ - or a  $\beta$ -sheet. Chain exists in two different forms.

Protein molecules are not straight as there is hydrogen bonding within the molecule; the hydrogen atom on one peptide link can form a hydrogen bond with the nitrogen or oxygen atoms on another peptide link; causing the structure to coil up:

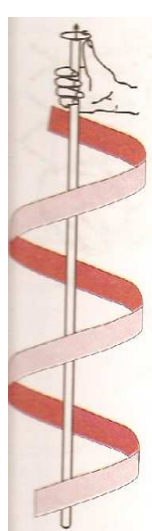
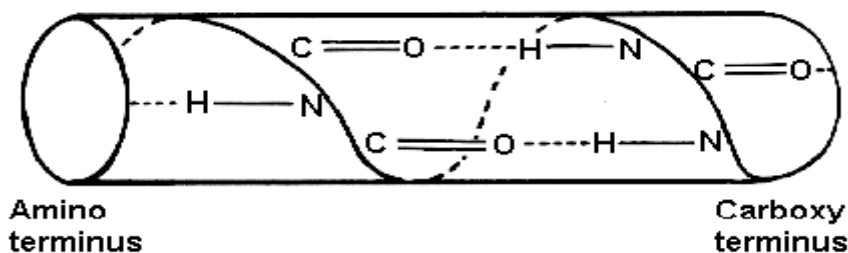


The result of this coiling is a helical structure known as the **secondary** structure of the protein:

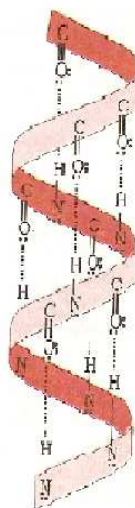


(i)  **$\alpha$ -helix structure:** a structure resulted due to twisting of polypeptide chain into a right handed screw (helix). In this case  $\text{-NH}$  group of each amino acid residue is hydrogen bonded to the  $\text{CO}$  of an adjacent turn of helix. The structure repeats itself every  $5.4 \text{ \AA}$  along the helix axis, i.e. we say that the  $\alpha$ -helix has a pitch of  $5.4 \text{ \AA}$ .  $\alpha$ -helices have 3.6 amino acid residues per turn, i.e. a helix 36 amino acids long would form 10 turns. The separation of residues along the helix axis is  $5.4/3.6$  or  $1.5 \text{ \AA}$ , i.e. the  $\alpha$ -helix has a rise per residue of  $1.5 \text{ \AA}$ . Every main chain  $\text{C=O}$  and  $\text{N-H}$  group is hydrogen-bonded to a peptide bond 4 residues away (i.e.  $\text{O}_i$  to  $\text{N}_{i+4}$ ). This gives a very regular, stable arrangement. The peptide planes are roughly parallel with the helix axis and the dipoles within the helix are aligned, i.e. all  $\text{C=O}$  groups point in the same direction and all  $\text{N-H}$  groups point the other way. Side chains point outward from helix axis and are generally oriented towards its amino-terminal end.

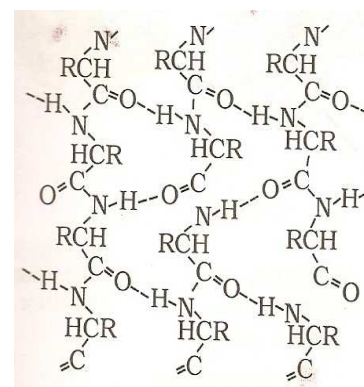
Toilet roll representation of the main chain hydrogen bonding in an alpha-helix.



$\alpha$ -helix structure



$\beta$ -pleated structure



A human hair strand is made up of many alpha helices. As the diagram below shows, three alpha helices are interwoven to make a protofibril. Eleven protofibrils are bonded and coiled together to make a microfibril. Hundreds of these microfibrils are combined together into an irregular bundle called a macrofibril. These, in turn, are mixed with dead and living cells to make a complete strand of hair. Fibroin is a fibrous protein found in silk. It has a pleated sheet structure in which polypeptide chains line up in a parallel arrangement and are held together by hydrogen bonds.

(ii)  **$\beta$ -pleated structure**: Structure of protein in which polypeptide chains are stretched out to nearly maximum extension and then laid side by side and held together by hydrogen bond. In a  $\beta$ -sheet two or more polypeptide chains run alongside each other and are linked in a regular manner by hydrogen bonds between the main chain C=O and N-H groups. Therefore all

hydrogen bonds in a  $\alpha$ -sheet are between different segments of polypeptide. This contrasts with the  $\alpha$ -helix where all hydrogen bonds involve the same element of secondary structure. The R-groups (side chains) of neighbouring residues in a  $\beta$ -strand point in opposite directions. The axial distance between adjacent residues is 3.5 Å. There are two residues per repeat unit which gives the  $\beta$ -strand a 7 Å pitch. This compares with the  $\alpha$ -helix where the axial distance between adjacent residues is only 1.5 Å. Clearly, polypeptides in the  $\beta$ -conformation are far more extended than those in the  $\alpha$ -helical conformation.

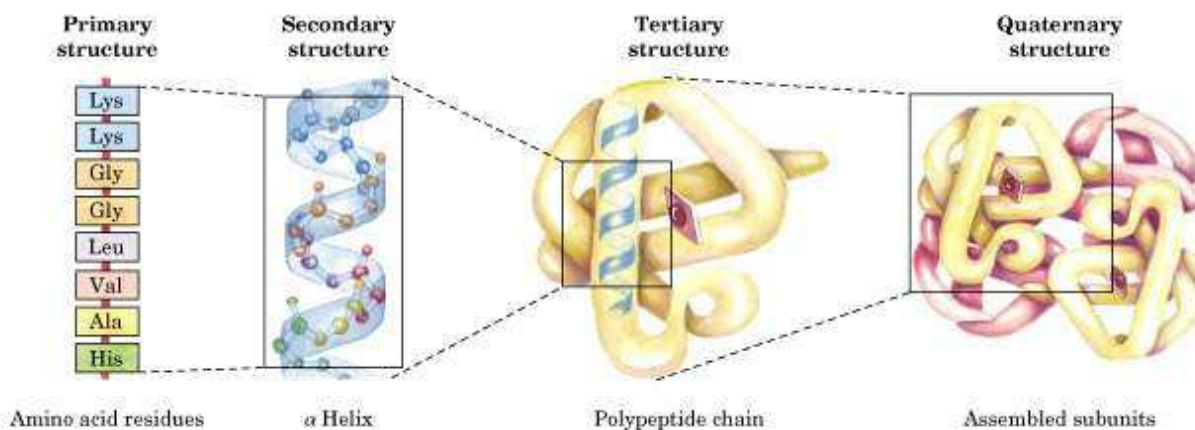
(iii) **Tertiary structure:** This structure of a protein is the three-dimensional arrangement of all the atoms in the protein. Proteins fold spontaneously in solution in order to maximize their stability. Every time there is a stabilizing interaction between two atoms, free energy is released. The more free energy released, the more stable the protein. So a protein tends to fold in a way that maximizes the number of stabilizing interactions. It refers to overall folding of polypeptide chain i.e. further folding of 2<sup>o</sup> structures. 2<sup>o</sup> and 3<sup>o</sup> structures are stabilized by

- H –bonding
- Disulphide linkage
- Vander Wall's force
- Electrostatic force

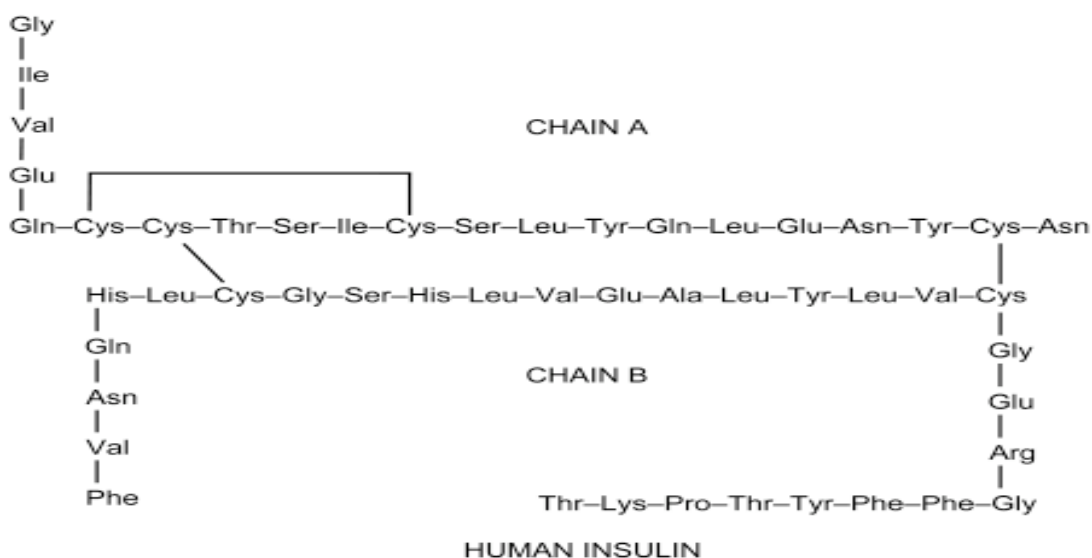
Tertiary structure describes the folding of the polypeptide chain to assemble the different secondary structure elements in a particular arrangement. As helices and sheets are units of secondary structure, so the domain is the unit of tertiary structure. In multi-domain proteins, tertiary structure includes the arrangement of domains relative to each other as well as that of the chain within each domain.

(iv) **Quarternary structure:** It refers to spatial arrangement of two or more polypeptide chains i.e sub-units with respect to each other. The quaternary structure is that level of form in which units of tertiary structure aggregate to form homo- or hetero- multimers. Proteins that have more than one peptide chain are called **oligomers**. The individual chains are called **subunits**. A protein with a single subunit is called a monomer, one with two subunits is called a dimer; one with three subunits is called a trimer, and one with four subunits is called a tetramer. Hemoglobin is an example of a tetramer. It has two different kinds of subunits and two of each kind. The

subunits are held together by the same kinds of interactions that hold the individual protein chains in a particular three-dimensional conformation: hydrophobic interactions, hydrogen bonding, and electrostatic attractions. This is found to be remarkably common, especially in the case of enzymes.



Insulin is a protein hormone that is involved in maintaining blood sugar levels. It consists of 51 amino acids organised into two chains that link into a 3D structure.



**Classification of proteins:** Various classifications are used.



I- According to shape

II- According to the biological value

III- According to structure

**I- According to shape:** On the basis of axial ratios of proteins (the ratios of length to breadth) and their three dimensional shape two classes of proteins are found:

**(a) Fibrous** – consisting of polypeptide chains arranged side by side. They have an axial ratio of more than 10 e.g. keratin, myosin, fibrin and collagen.

Keratin is a protein found in hair and skin. It is a fibrous protein and has a coiled structure similar to that of a telephone cord. The structure is described as an alpha helix. This confers on it properties such as toughness, rigidity, and water insolubility.

**(b) Globular** – consisting of coiled polypeptide chains that form compact roughly spherical shapes. They have an axial ratio of less than 10 (usually about 3 or 4) e.g. *plasma albumins and globulins* and many enzymes. They have spheroidal shape. Insulin is a globular protein with a roughly spherical shape that is soluble in water.

**II- According to the biological value:**

**(a) Proteins of high biological value:** i.e. contain all the essential amino acids. e.g. animal proteins as albumin and globulins in milk and in egg-white.

**(b) Proteins of low biological value:** i.e. deficient in one or more essential amino acid. e.g. plant proteins as Zein in maize.

**III- According to structure:**

1- Simple proteins: Formed only of amino acids

2- Conjugated proteins (compound proteins)

3. Derived proteins

**1- Simple proteins:**

a- Protamines and histones: These are water soluble basic proteins rich in histidine, arginine and lysine. They are present in nucleoproteins. Protamines are present in fish and histones are present in plants and animals. Globin; the protein moiety of Hb and myoglobin is considered as histone.

b- Albumins and globulins: These are heat coagulable. Globular proteins have high biological value. Globulins have larger molecular weight compared to albumins. They are present mainly in blood plasma, egg white and milk.

c- Scleroproteins (ALBUMINOIDS): These are fibrous structural proteins.

- They are insoluble in most protein solvent
- They include:

**i. Keratins** (epidermal proteins).

They are rich in sulphur containing amino acid (Cysteine).

They are the proteins of the outer surface of the skin, hair and nails.

It is an  $\alpha$ -helical polypeptide chain.

**ii. Collagen:**

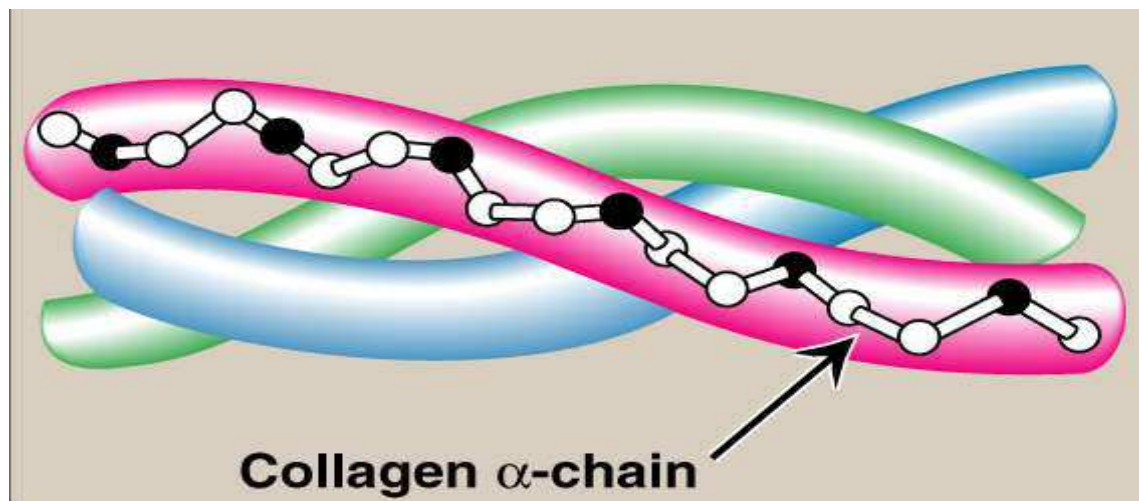
It is present mainly in skin, cartilage, tendons and ligaments (hard tissues). It has a special structure; the unit structure of its fibers is the tropocollagen. The tropocollagen is formed of three polypeptide chains; each chain is in a helical conformation different from the  $\alpha$ -helix in that:

- a. It is left handed of three residues per turn.
- b. No hydrogen bonds in each helix while the three helices are hydrogen bonded to each other. In each polypeptide chain glycine occurs in 3rd position, the other amino acids are mainly proline and hydroxyproline, also lysine and hydroxylysine are present.

**iii. Elastin:** Found in yellow elastic tissue.

**iv. Ossein:** The main protein of bone and teeth.

**4. Gliadin and glutelin:** are plant proteins of low biological value e.g. protein of maize and wheat.



**Fig: Collagen**

**2- Conjugated proteins (compound proteins):** Those contain in addition to the protein moiety some other groups called the prosthetic group attached by covalent bonds. According to the prosthetic group; they are classified into:

**a. Phosphoproteins:** They contain *phosphoric acid* as prosthetic group; conjugated to hydroxyl group of *serine or threonine*. They are of animal origin *e.g. caseinogen* of milk and *vitellin* of egg yolk. Caseinogen is converted by rennin to soluble casein which is precipitated by Ca as caseinate (cheese).

**b. Glycoproteins:** They are proteins that have carbohydrates (glycan) covalently attached to their polypeptide backbones.

**c. Lipoproteins:** These are combinations of proteins with lipids. They are present in *cell membranes and plasma lipoproteins*.

**d. Nucleoproteins:** They contain nucleic acids (DNA or RNA) as prosthetic groups attached to *protamines or histones*. They are found in cell nuclei and also in cytoplasm.

**e. Chromoproteins:** These are proteins that contain colored prosthetic groups. Haemoglobin is composed of globin and haem (red), (myoglobin is similar to Hb, but present in skeletal muscle). Rhodopsin is composed of opsin (protein) and 11-cis retinal. It gives purple color (visual purple). It is present in retina and responsible for vision in dim light.

**f. Metalloproteins:** They contain metals as prosthetic groups.

*e.g.:* Hb and ferritin contain iron.

Ceruloplasmin contains copper.

Carboxypeptidase and carbonic anhydrase contain zinc

**3. Derived Proteins:** They are hydrolytic products of proteins as a result of acids, alkalis or enzymes. According to molecular weight they are classified into:

a. Metaproteins.

b. Proteoses.

c. Peptones.

Where metaproteins have the higher molecular weight, while peptones have the smallest molecular weight. Gelatin which is a hydrolytic product of collagen is considered as a proteose. It is poor in essential amino acids, but it is used as a supplementary protein as it is easily digested.

### Functions of proteins:

#### I. Dynamic functions include:

1. Transport molecules or ions across membrane or between cells. *e.g.:*

- Albumin carries **calcium, free fatty acid and bile pigment**.

- Haemoglobin carries **oxygen**.

2. Catalytic role: chemical reactions are carried by enzymes (protein).

3. Metabolic regulations are carried by some protein hormones *e.g.* Insulin.

4. Contraction of muscles produced by myosin and actin.

5. Protection:

- Immunoglobulins act against invasion by bacteria and viruses.

- Blood clotting factors protect against hemorrhage.

- Mucin protects the respiratory and gastrointestinal tracts.

6. Fluid balance
7. Acid/base balance
8. Immune function
9. Enzymes
10. Cells in intestine replaced, skin cells, red blood cells
11. Tendons, bones, skin teeth - collagen
12. Fluids - albumin keeps balance between cells extracellular fluid and intracellular and BLOOD VESSELS - or else swelling
13. Can lower or raise pH - and act as buffers
14. Immune - antibodies, mucus - kill pathogens
15. Enzymes - lactose intolerance
16. Hormones- like insulin

## II. Structural functions: (static function)

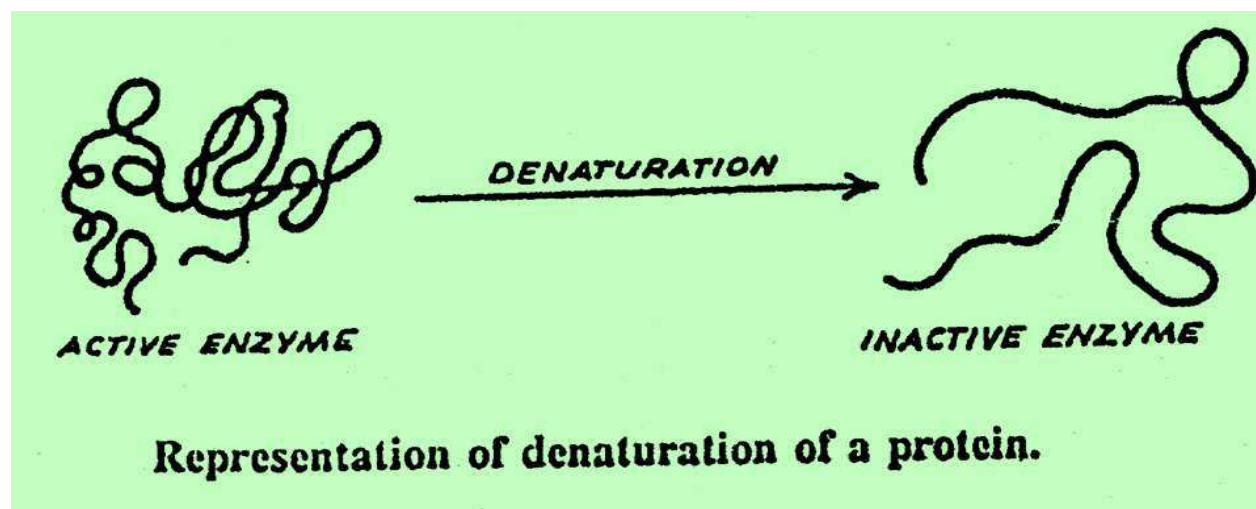
1. Proteins are structural components of cell membrane, cytoplasm, cell organelles and nuclei.
2. Mechanical support: collagen and elastin enter in the structure of ligaments, tendons and blood vessels. Keratin has an essential structural role in skin, hair and nail. Ossein enters in the structure of bone.

---

## 6.9 PROTEIN DENATURATION

---

The tertiary structure of a globular protein is the result of many intramolecular attractions that can be disrupted by a change of the environment, causing the protein to become denatured. Destroying the highly organized tertiary structure of a protein is called **denaturation**. A change in the secondary, tertiary and quaternary structure of proteins is due to *rupture of the non-covalent bonds (hydrogen bonds, hydrophobic bonds and electrostatic bond*. Anything that breaks the bonds responsible for maintaining the three-dimensional shape of the protein will cause the protein to denature (unfold). Because these bonds are weak, proteins are easily denatured. The totally random conformation of a denatured protein is called a **random coil**. Denaturation disrupts all orders of protein structure except primary structure.



Solubility is drastically decreased as in heating egg white, where the albumins unfold and coagulate. Enzymes also lose all catalytic activity when denatured.

**Causes of denaturation:** The following are some of the ways that proteins can be denatured:

**1. Physical agents:**

- Heating above 70°C. Heating increase molecular motion, which can disrupt the attractive forces. A well-known example is the change that occurs to the white of an egg when it is heated or whipped.
- Vigorous shaking
- Stirring
- Repeated freezing and thawing
- Ultraviolet rays
- X-rays.

**2. Chemical agents:**

- Salts of heavy metals as  $Mg^{2+}$  and  $Pb^{2+}$  disrupt ionic bonds
- Strong acids and bases (extreme pH). Changing the pH denatures proteins because it changes the charges on many of the side chains. This disrupts electrostatic attractions and hydrogen bonds.
- Sulfhydryl reagents e.g. mercaptoethanol (destroys S-S bonds by reduction).
- Alkaloidal reagents e.g. picric acid and phosphotungstic acid
- Alcohol.

- Certain reagents such as urea and guanidine hydrochloride denature proteins by forming hydrogen bonds to the protein groups that are stronger than the hydrogen bonds formed between the groups.
- Detergents such as sodium dodecyl sulfate denature proteins by associating with the nonpolar groups of the protein, thus interfering with the normal hydrophobic interactions.
- Organic solvents denature proteins by disrupting hydrophobic interactions.

### Effects of denaturation

#### 1. Physical changes:

- Decreased solubility (due to exposure of internal non-polar groups) and decreased rate of diffusion through membranes.
- Increased viscosity of proteins (due to unfolding of chains and increase of their molecular size).

#### 2. Chemical changes:

- Rupture of non-covalent bonds (and may be disulfide bonds).
- Exposure of some groups which are present in the interior of the protein molecule e.g. – SH.

#### 3. Biological changes:

- Loss of biological activity of enzymes and protein hormones.
- Changes of antigenic property of proteins.
- Denatured proteins are easily digested due to unfolding of the peptide chains.

---

## 6.10 ENZYMES, COENZYMES, COFACTORS AND VITAMINS

---

Enzymes are Biomolecules that catalyze, increase the rates of chemical Reactions. Almost all enzymes are proteins. In enzymatic reactions, the molecules at the beginning of the process are called substrates, and the enzyme converts them into different molecules, the products.

Almost all processes in a biological cell need enzymes in order to occur at significant rates.

- Most enzyme reaction rates are millions of times faster than those of comparable uncatalyzed reactions.
- However, enzymes do differ from most other catalysts by being much more specific.
- Activators are molecules that increase activity. Many drugs and poisons are enzyme inhibitors.
- Activity is also affected by temperature, chemical environment (e.g. pH).
- Some enzymes are used commercially, for example, in the synthesis of antibiotics.

- In addition, some household products use enzymes to speed up biochemical reactions.

### Naming of Enzymes

Enzymes are usually named according to the reaction they carry out. Typically the suffix *-ase* is added to the name of the substrate (*e.g.*, lactase is the enzyme that cleaves lactose) or the type of reaction (*e.g.*, DNA polymerase forms DNA polymers).

### Specificity

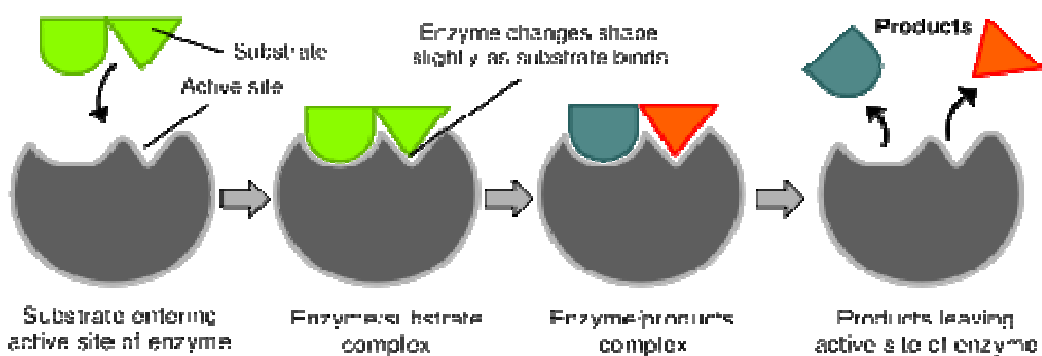
Enzymes are usually very specific as to which reactions they catalyze and the substrates that are involved in these reactions.

### "Lock and key" model

Enzymes are very specific, because both the enzyme and the substrate possess specific complementary geometric shapes that fit exactly into one another. This is often referred to as "the lock and key" model.

However, while this model explains enzyme specificity, it fails to explain the stabilization of the transition state that enzymes achieve.

### Induced fit model



**Fig: Diagrams to show the induced fit hypothesis of enzyme action.**

### Cofactors and coenzymes:

#### Cofactors

- Some enzymes do not need any additional components to show full activity.
- However, others require non-protein molecules called cofactors to be bound for activity.



- Cofactors can be either inorganic (*e.g.*, metal ions and iron-sulfur clusters) or organic compounds, (*e.g.*, flavin and heme).

**Organic cofactors can be either:**

Most cofactors are not covalently attached to an enzyme, but are very tightly bound. However, organic prosthetic groups can be covalently bound.

**Coenzymes**

Coenzymes are small organic molecules that transport chemical groups from one enzyme to another. Some of these chemicals such as riboflavin, thiamine and folic acid are vitamins, (acquired).

“Cofactor” usually refers to a substance that is noncovalently bound to the enzyme; “coenzyme” usually refers to a covalently bound substance.

**Enzyme Deficiency**

A variety of metabolic diseases are now known to be caused by deficiencies or malfunctions of enzymes. **Albinism**, for example, is often caused by the absence of tyrosinase, an enzyme essential for the production of cellular pigments. The hereditary lack of phenylalanine hydroxylase results in the disease phenylketonuria (PKU) which, if untreated, leads to severe mental retardation in children.

**Enzyme Inhibitors:**

Competitive Inhibitors: Are molecules that are chemically similar to the substrate and can compete with the substrate for access to the active site (like putting the wrong key in a lock, blocking the correct key but not destroying the keyhole).

Noncompetitive Inhibitors: Are substances that chemically interact with the protein that the enzyme is made of, altering the enzymes chemical structure and destroying the active site's ability to bind to its substrate. A noncompetitive inhibitor may acts on a part of the enzyme other

than its active site (like hitting a lock with a sledgehammer, bending the keyhole out of shape so that the key doesn't fit any more).

**Vitamins:** These are a group of Organic compounds required in small quantities of a variety of biological functions, for proper metabolism; protect health, for normal growth and activity of the body.

Vitamins are also required for the prevention of a number of diseases. Most vitamins cannot be synthesized by the body. They must be supplied in the diet. Vitamins are usually classified as water soluble or fat soluble.

### Types of Vitamins:

#### 1. Fat-Soluble Vitamins:

Properties:

- Fat soluble vitamins often have very specialized functions
- Necessary for the function or structural integrity of specific body tissues and membranes.
- Can be retained in the body, and are not leached out quickly.
- Apolar hydrophobic compounds that can only be absorbed efficiently when there is normal fat absorption.
- Unlike water soluble vitamins, an excess of a fat soluble vitamin can be just as harmful as a deficiency

#### 2. Water-Soluble Vitamins:

Properties:

- Act as catalysts and enzyme cofactors in metabolic processes and energy transfer.
- Are not stored in the body (excreted fairly rapidly) and must be replaced each day.
- These vitamins are easily destroyed or washed out during food storage and preparation (overcooking)
- Water soluble vitamins do not accumulate in the body, so regular supplies are necessary

**FAT – SOLUBLE VITAMINS**

**Vitamin A:** Vitamin A is also known as retinol

**Vitamin A Sources:**

- Commonly found in cod liver oil, green vegetables, fruit dairy products, eggs, and liver
- Carrots indirectly serve as a source of vitamin A since they contain b carotene which the body readily converts to vitamin A

**Vitamin A Functions:**

- Role in aiding in night vision.
- Retinol is oxidized to retinal, which combines with the protein opsin to form rhodopsin. Rhodopsin is the active agent which converts light signals to electrical impulses that the optic nerve transmits to the brain

**Vitamin A Deficiencies:**

- A deficiency in vitamin A results in night blindness.
- The most serious deficiency results in a condition known as Xerophthalmia, a severe form of conjunctivitis or blindness.

**Excess of Vitamin A:**

- Carotenemia; Bleeding; Hepatosplenomegaly (rare)

**2-Vitamin D (Calciferol)****Sources:**

- Dairy products, eggs, Fish liver oils. Synthesized by sunlight action on skin.
- Unlike other vitamins, the body synthesizes vitamin D in the skin through the action of ultraviolet light on 7-dehydrocholesterol

**Vitamin D Functions:**

- Vitamin D is an important regulator of calcium metabolism.
- It is involved in the uptake of calcium and phosphate ions from food into the body.
- It is necessary for the proper formation of bone structures and teeth.

**Vitamin D Deficiencies:**

- Rickets (children)
- Osteomalacia (adults)

**Excess of Vitamin D :**

- Hypercalcemia leading to metastatic calcification and renal damage (rare).

**3- Vitamin K:****Function:**

- Blood clotting, Required for synthesis of Prothrombin (II) and clotting factors VII, IX and X.

**Sources:**

- Green leafy vegetables, liver; Naturally produced by bacteria in the intestine.

**Deficiencies:**

- Hemorrhagic disease

**Water-Soluble Vitamins:****1- B12 (Cyanocobalamin)****Food source:**

Red meats, Liver, eggs, dairy products and fish

**Function:**

Nucleic acid production

**Deficiency:**

Megaloblastic anemia (Pernicious anemia);neuropathy.

**2- Vitamin C (Ascorbic Acid)****Sources:**

- Citrus fruits, green leafy vegetables, tomatoes

**Function:**

- Collagen formation in teeth, bone, and connective tissue of blood vessels
- May help in resisting infection
- Absorption of iron, calcium, folacin
- Ascorbic acid is a great antioxidant

- Works with vitamin E as a free-radical scavenger.

**Deficiency:**

- Scurvy (breakdown of skin, blood vessels, and teeth)
- Impaired wound healing.
- \*Vitamin C deficiency- often results secondary to hyperparathyroidism

**Excess:**

- None known, minimal-possibly urinary calculi, gastrointestinal complaints including diarrhea, nausea and abdominal cramps

**3. Folic Acid (Folacin)****Source:**

Whole-wheat foods, green vegetables, legumes, organ meats, fish, citrus fruits.

**Function:**

Nucleic acid metabolism

**Deficiency:**

Megaloblastic anemia (Pernicious anemia)

**Other vitamins:**

1. **Vitamin P** (bioflavonoids, citrin):
  - a. Helps increase strength of capillaries found in the mesocarp (tasteless, spongy, white layer beneath the rind) of lemon fruit.
2. **Vitamin F** (unsaturated fatty acids):
  - a. Is important in respiration of vital organs.
    - i. -helps maintain resilience and lubrication of cells.
    - ii. -helps regulate blood coagulation.
    - iii. -is essential for normal glandular activity.
3. **Vitamin B13** (Orotic acid):
  - a. is needed for the metabolism of some B-vitamins

- b. **Vitamin B15** (Pangamic acid): Helps eliminate hypoxia helps promote CHON metabolism stimulates nervous and glandular system
- 4. **Vitamin B17** (Laetrile): has been linked to cancer prevention

---

## 6.11 SUMMARY

---

Peptides and proteins are polymers of amino acids linked together by peptide (amide) bonds. A dipeptide contains two amino acid residues, a tripeptide contains three, an oligopeptide contains three to 10, and a polypeptide contains many amino acid residues. Proteins have 40 to 4000 amino acid residues. The amino acids differ only in the substituent attached to the Most amino acids found in nature have the L configuration. The carboxyl groups of the amino acids have values of and the protonated amino groups have values of At physiological pH, an amino acid exists as a zwitterion. A few amino acids have side chains with ionizable hydrogens. The isoelectric point (pI) of an amino acid is the pH at which the amino acid has no net charge. A mixture of amino acids can be separated based on their pI's by electrophoresis or based on their polarities by paper chromatography or thin-layer chromatography.

The amide bonds that link amino acid residues are called peptide bonds. A peptide bond has about 40% double bond character. By convention, peptides and proteins are written with the free amino group (the N-terminal amino acid) on the left and the free carboxyl group (the C-terminal amino acid) on the right. The primary structure of a protein is the sequence of its amino acids and the location of all its disulfide bridges. The secondary structure of a protein describes how local segments of the protein's backbone folds. A protein folds so as to maximize the number of stabilizing interactions: covalent bonds, hydrogen bonds, electrostatic attractions (attraction between opposite charges), and hydrophobic interactions (interactions between nonpolar groups). An  $\alpha$  and  $\beta$ -helix and a coil conformation are types of secondary structure. The tertiary structure of a protein is the three-dimensional arrangement of all the atoms in the protein. Proteins with more than one peptide chain are called oligomers. The individual chains are called subunits. The quaternary structure of a protein describes the way the subunits are arranged with respect to each other in space.

Enzymes are biological substances that regulate the rates of the chemical reactions in living organisms; most enzymes are proteins (covered in some detail later in this course).

---

## 6.12 TERMINAL QUESTIONS

---

1. Define the following terms used in relation to proteins:  
(i) Denaturation (ii) Peptide linkage (iii) Primary
2. What are nucleotides and nucleotides?
3. Define the following terms (i) Essential amino acids (ii) Non- essential amino acids
4. Enumerate the structural difference between DNA and RNA. Write down the structure of sugar present in DNA.
5. Where does the water present in the egg go after boiling the egg?
6. Define the following as related to proteins (i) peptide linkage (ii) Primary structure (iii) Denaturation
7. What are the common types of secondary structure of proteins?  
(i)  $\alpha$  -helix structure (ii)  $\beta$  - pleated structure
8. What type of bonding helps in stabilizing the  $\alpha$  - helix structure of protein?
9. Differentiate between globular and fibrous proteins. How do you explain the amphoteric behaviour of amino acids.
10. What is the effect of denaturation on the structure of proteins?
11. What are nucleic acids? Mention their two important functions.
12. Write the important structural and functional differences between DNA and RNA.
13. Protein requirements are higher for athletes than for non-athletes: True/False

### MCQ: Choose the correct answer:

1. Proteins  
(a) are macromolecules whose name means first or foremost.  
(b) constitute 50% or more of the dry weight of the cell.  
(c) are hundreds of different molecules in the living tissue.  
(d) all the above
- 2- An average protein is how many folds larger than a glucose molecule?  
(a) 2-10. (b) 10-20. (c) 20-50. (d) More than 500.
- 3- Diet proteins are important because they are the main source of  
(a) carbon. (b) carbon and hydrogen. (c) hydrogen and oxygen. (d) nitrogen and sulfur.
- 4- Complex proteins may include

- (a) glycoproteins and lipoproteins. (b) hemeproteins and nucleoproteins.  
(c) phosphoproteins and metalloproteins. (d) all the above.

5- Aminoacids of proteins

- (a) have the amino group and the carboxyl group attached to the same carbon atom.  
(b) have the amino group attached to the alpha-, beta-, or gamma-carbon.  
(c) both (a) and (b).  
(d) neither (a) nor (b).

6- How many aminoacids share in the biosynthesis of all known proteins?

- (a) 10 (b) 20 (c) 30 (d) 50

7- Alpha-aminoacids of proteins

- (a) all have the D configuration. (b) all have the L configuration.  
(c) have D or L configuration. (d) None of the above is true.

8- Regarding aminoacids that share in protein structure,

- (a) all have optical activity. (b) all contain at least one asymmetric carbon atom.  
(c) both (a) and (b). (d) neither (a) nor (b).

9- Proteins differ from each other in

- (a) the number of forming aminoacids. (b) the types of forming aminoacids.  
(c) the sequence of forming aminoacids. (d) all the above.

10- Which of the following statements best describes the difference between essential and non-essential aminoacids?

- (a) Essential aminoacids should be supplied in the diet.  
(b) Non-essential aminoacids should be avoided in the diet.  
(c) Essential aminoacids are important for body function, while non-essential aminoacids are not.  
(d) Non-essential aminoacids can be synthesized in the body, while the essential aminoacids cannot.

11- High biological value proteins

- (a) contain some of the essential aminoacids. (b) come from animal source only.  
(c) are hard to digest and metabolize. (d) are necessary in the diet, especially for children and pregnant women.

12- High biological value proteins are those proteins that

- (a) contain all the essential aminoacids. (b) have high caloric value.



(c) are not hydrolyzed by digestive enzymes. (d) are obtained usually from plants.

13- Metabolic classification of aminoacids dictates that

- (a) the majority of aminoacids are ketogenic.
- (b) leucine and lysine are purely glucogenic aminoacids.
- (c) isoleucine, threonine, phenyl alanine, tyrosine, and tryptophan are mixed.
- (d) all the above.

14- Regarding the solubility of aminoacids in the plasma,

- (a) all are soluble.
- (b) only the aminoacids with charged groups are soluble.
- (c) the aminoacids with non-polar groups need a carrier.
- (d) the aminoacids with charged or polar groups are the only soluble ones.

15- Aminoacids are amphoteric molecules, so they

- (a) have both acidic and basic groups.
- (b) can react with acids or alkalis, forming salts in either case.
- (c) can act as buffers at more than one pH.
- (d) all the above.

16- Isoelectric point is

- (a) acidic pH for basic aminoacids. (b) alkaline pH for dicarboxylic aminoacids.
- (c) neutral pH for neutral aminoacids. (d) the pH at which the aminoacid carries no net charge.

17- Isoelectric point is defined as

- (a) the pH at which the aminoacid or protein carries no net charge.
- (b) the pH at which the aminoacid or protein does not migrate in a direct current electric field.
- (c) both (a) and (b).
- (d) neither (a) nor (b).

18- At isoelectric point, an aminoacid carries

- (a) one or more positive charges. (b) one or more negative charges.
- (c) equal positive and negative charges. (d) no electric charges.

19- At a pH above its isoelectric point, an aminoacid

- (a) migrates towards the anode. (b) migrates towards the cathode.
- (c) does not migrate in either direction. (d) migrates according to the charge on the amino group.

20- Zwitter ion is



- (b) is necessary for determining the primary structure of protein molecules.
- (c) can be seen in the  $\alpha$  -helix of protein between the hydrogen of a peptide N and the carbonyl O of the residue fourth in line behind.
- (d) all the above.

27- Regarding protein structure,

- (a) Only peptide bonds are necessary for the proper biological function of a protein.
- (b) Peptide bonds can be broken by acid hydrolysis or by the proteolytic action of proteases.
- (c) Disulfide bond is a strong covalent bond which cannot be broken by oxidation or reduction in the lab.
- (d) None of the above is true.

28- Primary structure of a protein

- (a) is the number, types, and order of aminoacids.                      (b) is maintained by peptide bonds.
- (c) Cannot be disrupted by heating or mild acid treatment.      (d) all the above.

29- Regarding secondary structure of a protein,

- (a) it is the folding of the polypeptide chain in the form of  $\alpha$ -helices,  $\beta$ -pleated sheets or nonrepetitive elements.
- (b) It is maintained entirely by the disulfide bonds.
- (c)  $\alpha$ -helix,  $\beta$ -pleated sheets, and non-repetitive elements cannot exist together in the same molecule.
- (d) All the above.

30- Tertiary structure of a protein

- (a) Gives the tridimensional shape of a protein.
- (b) Describes the relationship between different domains of the molecule.
- (c) Brings together aminoacids far apart in the primary structure.
- (d) All the above.

31- Quaternary structure

- (a) Is seen only in some proteins, which are called oligomeric proteins, e.g. hemoglobin.
- (b) Is the aggregation of two or more polypeptide chains called monomers, protomers, or subunits held together by covalent bonds.
- (c) Both (a) and (b).
- (d) Neither (a) nor (b).

32- Hemoglobin is

- (a) a pentamer.            (b) a homodimer.  
(c) a homotetramer.      (d) none of the above.

33- Intra-chain hydrogen bonds may not stabilize which of the following?

- (a) Alpha helix.            (b) Beta-pleated sheets.  
(c) Tertiary structure.      (d) Quaternary structure.

34- The final shape of a protein is determined by

- (a) the aminoacid sequence.  
(b) the disulfide and non-covalent forces between aminoacid residues.  
(c) the steric hindrance and electrostatic repulsion exerted by side groups of aminoacids.  
(d) all the above.

35. When a peptide bond is formed there is removal of:

- (a) CO<sub>2</sub>                      (b) H<sub>2</sub>O                      (c) NH<sub>3</sub>                      (d) H<sup>+</sup>

36. All amino acids are optically active except:

- (a) Glycine                      (b) Serine                      (c) Threonine                      (d) Tryptophan

37. The major linkage between amino acids in protein is the:

- (a) Hydrogen bond      (b) Ionic bond      (c) Sulphide bond      (d) Peptide bond

38. Essential amino acids are so named because:

- (a) They are essential for life process      (b) Cannot be synthesized in the body  
(c) Deficiency leads to genetic diseases      (d) Important in cell growth

---

### **6.13 ANSWERS**

---

1- d; 2- d; 3- d; 4- d; 5- a; 6- b; 7- d; 8- d; 9- d; 10- a; 11- d; 12- a; 13- c; 14- a; 15- d;  
16- d; 17- c; 18- c; 19- a; 20- d; 21- c; 22- b; 23- b; 24- d; 25- d; 26- c; 27- b; 28- d;  
29- a; 30- d; 31- a; 32- d; 33- d; 34- d; 35-b; 36-a; 37- d; 38- b.

---

## UNIT- 7 CARBOHYDRATES-I

---

### CONTENTS

- 7.1. Objectives
- 7.2. Introduction
- 7.3. Classification and Nomenclature
- 7.4. Monosaccharides
- 7.5. Mechanism of osazone formation
- 7.6. Interconversion of glucose and fructose
- 7.7. Chain lengthening and chain shortening of glucose
- 7.8 Summary
- 7.9. Model examination questions

---

### ***7.1 OBJECTIVES***

---

After going through this unit you will be able to:

- Define carbohydrates,
- Differentiate and classify the three major groups of carbohydrates,
- Define anomers, mutarotation, configuration and mechanism of osazone formation,
- Describe ether and ester formation,
- Differentiate between reducing and non reducing sugars,
- Define interconversion of glucose and fructose,
- Describe the chain lengthening and chain shortening of aldose
- Discuss about Erythro and threo distereomers conversion of glucose
- Determination of ring size of monosaccharides,

---

### ***7.2 INTRODUCTION***

---

Carbohydrates are a class of naturally occurring organic compounds of carbon, hydrogen and oxygen which are primarily produced by plants. They are extremely widespread in plants comprising upto 80% of dry weight. These are ultimate source of our food. In higher animals the simple sugar glucose is an essential constituent of blood and occurs in a polymeric form as glycogen in the liver and muscle.

In the green plants, carbohydrates are produced by a process called photosynthesis. This process involves the conversion of simple compounds  $\text{CO}_2$  and  $\text{H}_2\text{O}$  into glucose ( $\text{C}_6\text{H}_{12}\text{O}_6$ ) and is catalysed by green colouring pigment chlorophyll present in the leaves of plants. The energy required for this conversion is supplied by sun in the form of sunlight.

Carbohydrates are very useful for human beings. They provide us all the three basic necessities of life i.e., food (starch containing grain), clothes (cellulose in the form of cotton, linen and rayon) and shelter (cellulose in the form of wood used for making our houses and furniture etc.). Carbohydrates are also important to the economy of many nations. For example, sugar is one of the most important commercial commodities.

The term carbohydrates arose because the general formula for most of them could be written as  $\text{C}_x (\text{H}_2\text{O})_y$  and thus they may be regarded as hydrates of carbon. However, this definition was not found to be correct e.g., rhamnose, a carbohydrate, is having the formula  $\text{C}_6\text{H}_{12}\text{O}_5$  while acetic acid having formula  $\text{C}_2\text{H}_4\text{O}_2$  is not a carbohydrate. Simple carbohydrates are also known as sugars or saccharides (Latin: Saccharum; Greek : Sakcharon, Sugar) and the ending of the names of most sugars is -ose. Examples: glucose, fructose, sucrose, maltose, arabinose, etc.

Chemically, carbohydrates contain mainly two functional groups, carbonyl group (aldehyde or ketone) and a number of hydroxyl groups. Accordingly carbohydrates are now defined optically active polyhydroxy aldehydes or polyhydroxy ketones or the compound that can be hydrolysed to either of them.

---

## 7.3 CLASSIFICATION AND NOMENCLATURE

---

### 7.3.1 Classification

Carbohydrates, in general, may be classified into two classes:

- (i) **Sugars.** These are crystalline substances which are sweet and water soluble. For examples, glucose, fructose and cane sugar.
- (ii) **Non-sugars.** These are tasteless, insoluble in water and amorphous. For example. Starch, cellulose, etc.

However, these days Carbohydrates are systematically classified into three major group:

- (a) Monosaccharides.** The simplest carbohydrates that cannot be hydrolysed into simpler carbohydrates, are called monosaccharides. depending upon whether they contain an aldehyde or keto groups, they may be called aldoses or ketoses. For example, a five carbon monosaccharide having aldehyde group is called aldopentose and six carbon monosaccharide containing a keto group is called keto-hexose. A few examples of monosaccharides are given below:

Aldotetroses. Erythrose and Threose;  $\text{CH}_2\text{OH}(\text{CHOH})_2 \text{CHO}$ .

Ketotetroses. Erythrulose,  $\text{CH}_2\text{OHCOCHOHCH}_2\text{OH}$ .

Aldopentoses. Ribose, arabinose, Xylose and Lyxose.  $\text{CH}_2\text{OH}(\text{CHOH})_3 \text{CHO}$ .

All have a common molecular formula but different structures.

Ketopentoses. Ribulose and Xylulose;  $\text{CH}_2\text{OHCO}(\text{CHOH})_2 \text{CH}_2\text{OH}$ .

Aldohexoses. Glucose, mannose, galactose;  $\text{CH}_2\text{OH}(\text{CHOH})_4 \text{CHO}$ .

Ketohexoses. Fructose, Sorbose etc.  $\text{CH}_2\text{OHCO}(\text{CHOH})_3 \text{CH}_2\text{OH}$ .

- (b) Oligosaccharides.** These are the carbohydrates which can be hydrolysed into a definite number of monosaccharide molecules. Depending upon the number of monosaccharides that are obtained from them on hydrolysis, they may be called di-, tri- or tetra-saccharides: For example:

Disaccharides: sucrose, lactose, maltose. All these have the same molecular formula  $C_{12}H_{22}O_{11}$ .

Trisaccharides: raffinose ( $C_{18}H_{32}O_{16}$ ).

Tetrasaccharides: stachyose ( $C_{24}H_{42}O_{21}$ ).

(c) **Polysaccharides.** Carbohydrates that yield a large number of molecules (more than ten molecules) of monosaccharides on hydrolysis are called polysaccharides. The common examples are starch, cellulose, glycogen, etc.

### 7.3.2 Nomenclature

Carbohydrates contain hydroxy and aldehydic or ketonic groups. They are named according to IUPAC system of nomenclature

Compound	Common name	IUPAC name
$CH_2OHCHOHCHO$	Glyceraldehyde	2, 3-dihydroxy propanol
$CH_2OHCOCH_2OH$	Dihydroxyacetone	1,3-dihydroxy propanone
$CH_2OH(CHOH)_4CHO$	Glucose	2,3,4,5,6-pentahydroxyhexanal
$CH_2OH(CHOH)_3COCH_2OH$	Fructose	1,3,4,5,6-pentahydroxyhexan-2-one

---

## 7.4 MONOSACCHARIDES

---

The monosaccharides are again classified on the basis of two factors:

(1) By the carbonyl function. Those containing the aldehydic function, -CHO, are called aldoses. Others containing the keto group, -CO-, are called ketoses.

(2) By the number of Carbonyl atoms in the molecule. These monosaccharides containing 3,4,5,6 etc., carbon atoms are designated as trioses, tetroses, pentoses, hexoses, and so on.

Monosaccharides are polyhydric aldehydes and ketones which cannot be hydrolysed into simpler carbohydrates.

### 7.4.1 Structures of monosaccharides

The common monosaccharides are given in table.



Table. Monosaccharides

No of carbon atoms	Class	Molecular formula aldoses	Structural formula	Examples
3	aldotrioses	$C_3H_6O_3$	$CH_2OHCHOHCHO$	Glyceraldehyde
4	aldotetroses	$C_4H_8O_4$	$CH_2OH(CHOH)_2CHO$	Erythrose, Threose
5	Aldopentose	$C_5H_{10}O_5$	$CH_2OH(CHOH)_3CHO$	Arabinose, Ribose, Xylose, Lyxose
6	aldohexoses	$C_6H_{12}O_6$	$CH_2OH(CHOH)_4CHO$	Glucose, galactose, mannose, allose, talose, gulose, iodose, etc.
3	ketotrioses	$C_3H_6O_3$	$CH_2OHCOCH_2OH$	dihydroxyacetone
4	ketotetroses	$C_4H_8O_4$	$CH_2OHCOCHOHCH_2OH$	erythrulose
5	ketopentoses	$C_5H_{10}O_5$	$CH_2OHCO(CHOH)_2CH_2OH$	Ribulose, Xylulose
6	ketohehexoses	$C_6H_{12}O_6$	$CH_2OHCO(CHOH)_3CH_2OH$	Fructose, Sorbose, Tagatose, Psicose

### 7.4.2 Glucose

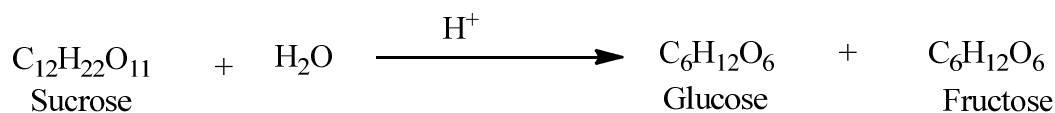
Glucose is most common monosaccharide. It is known as Dextrose because it occurs in nature principally as optically dextrorotatory isomer. Glucose is found in most sweet fruits, especially grapes (20-30%), and honey. It is an essential constituent of human blood. The blood normally contains 65 to 110 mg (0.06 to 0.1%) of glucose per 100 ml. In diabetic persons the

level may be much higher. In combined form glucose occurs in abundance in cane sugar and polysaccharides such as starch and cellulose.

### Preparation of Glucose

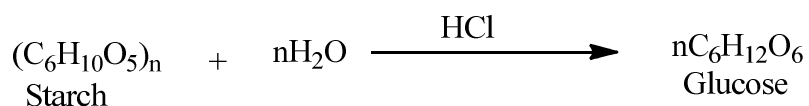
#### 1. From sucrose (Cane sugar)

When sucrose is boiled with dilute HCl or H<sub>2</sub>SO<sub>4</sub> in alcoholic solution, glucose and fructose are obtained in equal amounts.



#### 2. From Starch

Glucose is produced commercially by the hydrolysis of starch by boiling it with dilute H<sub>2</sub>SO<sub>4</sub> at high temperature under pressure.



In this process, an aqueous solution of starch obtained from corn is acidified with dilute H<sub>2</sub>SO<sub>4</sub>. It is then heated with high pressure steam in an autoclave. When the hydrolysis is complete, the liquid is neutralized with sodium carbonate to pH of 4-5. The resulting solution is concentrated under reduced pressure to get the crystals of glucose.

### Physical properties of glucose

Some important physical properties of glucose are mentioned as under:

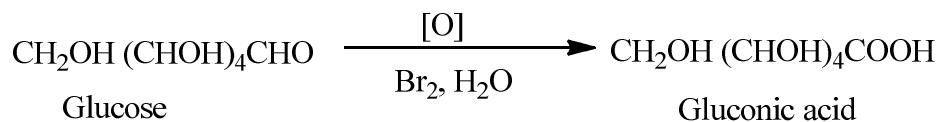
1. It is colourless sweet crystalline compound having m.p. 419 K.
2. It is readily soluble in water, sparingly soluble in alcohol and insoluble in ether.
3. It forms a monohydrate having m.p. 391 K.
4. It is optically active and its solution is dextrorotatory. The specific rotation of fresh solution is + 112° C.
5. It is about three fourth as sweet as sugarcane i.e., sucrose.

### Chemical properties of glucose

Chemical properties of glucose can be studied under the following headings:

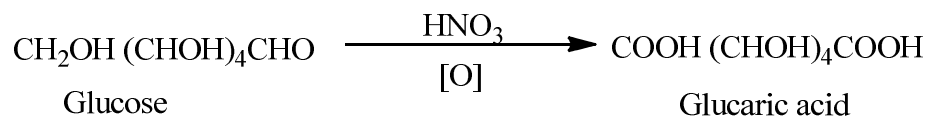
**(A) Reactions of aldehydic group**

1. **Oxidation.** (a) Glucose gets oxidized to gluconic acid with mild oxidizing agents like bromine water



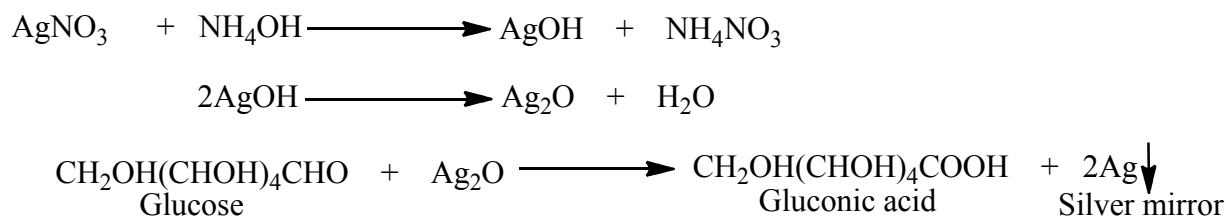
Only-CHO group is affected.

- (b) A strong oxidizing agent like nitric acid oxidizes both the terminal groups viz.  $-\text{CH}_2\text{OH}$  and  $-\text{CHO}$  groups and saccharic acid or glucaric acid is obtained.

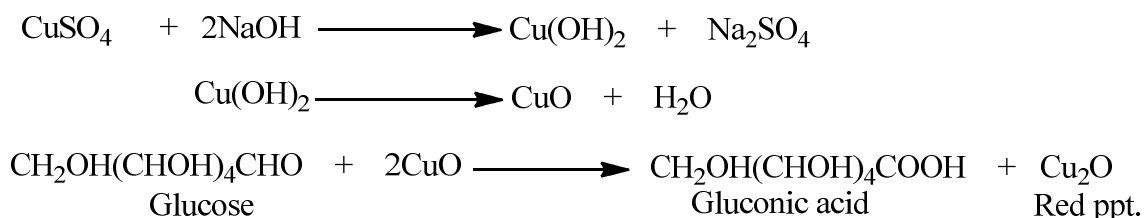


- (d) Glucose gets oxidized to gluconic acid with ammonical silver nitrate (Tollen's reagent) and alkaline copper sulphate (Fehling solution). Tollen's reagent is reduced to metallic silver (silver mirror) and Fehling solution to cuprous oxide which is a red precipitate.

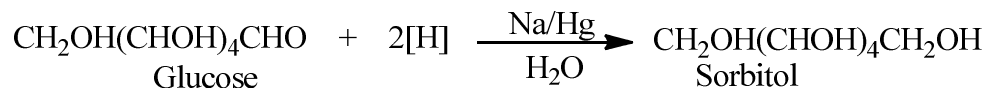
- (i) With Tollen's reagent



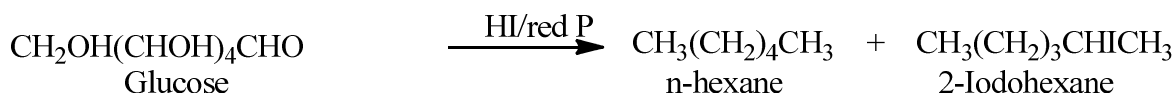
- (ii) With Fehling solution



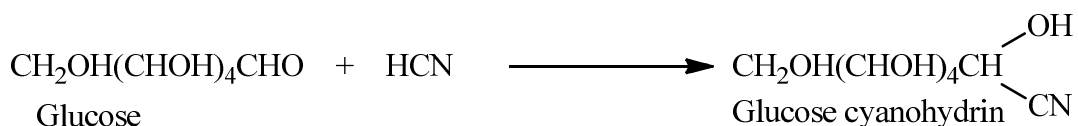
2. **Reduction** (a) glucose is reduced to sorbitol or Glucitol on treatment with sodium amalgam and water.



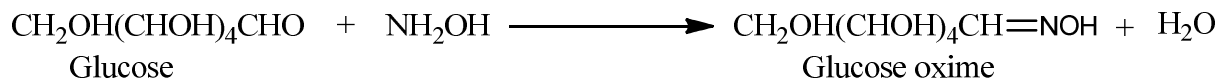
- (b) On reduction with conc. HI and red P at 373 K glucose gives a mixture of n-hexane and 2-iodohexane



3. **Reaction with HCN.** Like aldehydes, glucose reacts with HCN forming cyanohydrins.

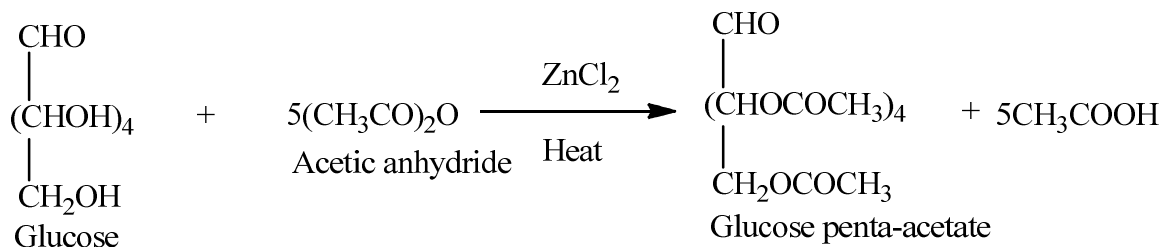


4. **Reaction with hydroxylamine.** Glucose forms glucose oxime.



### (B) Reactions of hydroxyl groups

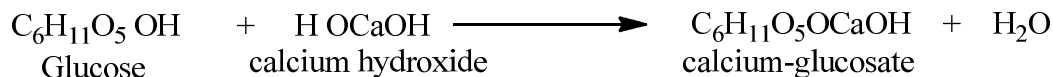
1. **Reaction with acetic anhydride or acetyl chloride.** Glucose forms penta acetate with acetic anhydride or acetyl chloride.



2. **Reaction with methyl alcohol.** Glucose reacts with methyl alcohol in the presence of dry HCl gas to form methyl glucoside.

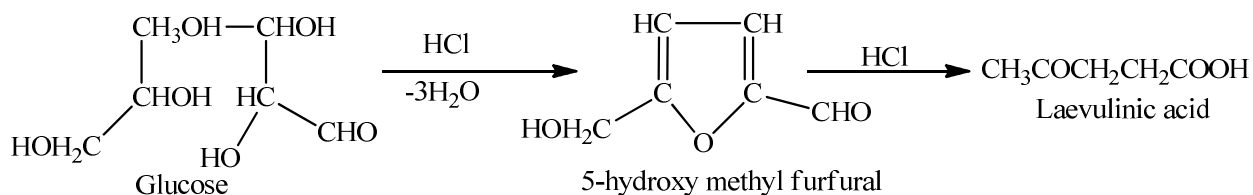


3. **Reaction with metallic hydroxides.** Glucose reacts with calcium hydroxide to form calcium glucosate which is water soluble.

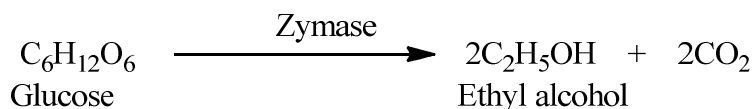


**(C) Miscellaneous reactions**

1. Action of acids. On warming with conc.HCl, glucose forms 5-hydroxy methyl furfural, which on further reaction gives laevulinic acid.

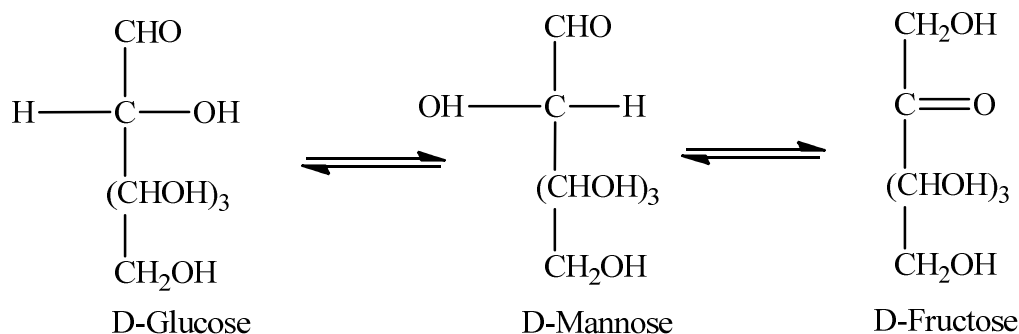


2. Fermentation. Glucose undergoes fermentation into ethyl alcohol in the presence of the enzyme zymase.

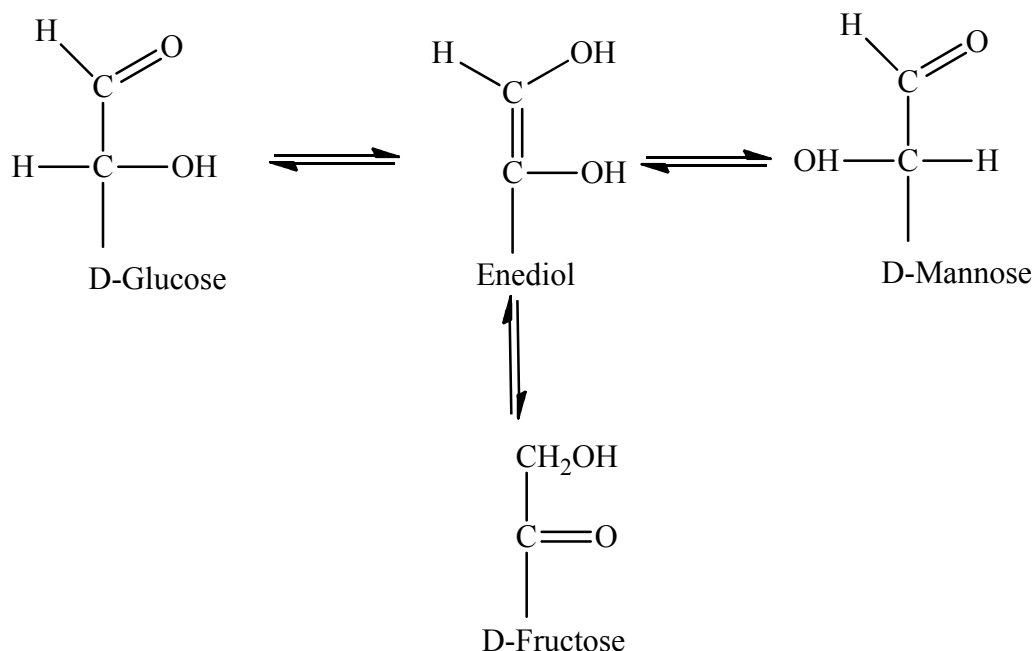


This reaction called alcoholic fermentation is the basis of manufacture of wines and alcohol.

3. Reaction with Alkalies. When warmed with strong sodium hydroxide solution, glucose forms a brown resinous product. In dilute alkali solution, D-glucose rearranges to give a mixture of D- glucose, D-mannose and d-fructose.



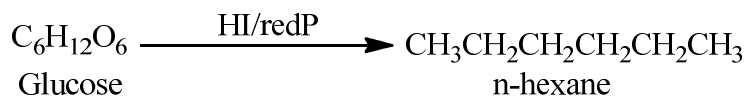
The above equilibrium is established via the enediol starting from any of these three hexoses.



That is why D-Fructose, although it has a ketonic C=O group, reduces Fehling's solution or Tollen's reagent. The rearrangement reaction of a monosaccharides in weakly alkaline solutions to give a mixture of isomeric sugars, is named as Lobry de Bruyn Van Ekestein rearrangement.

### Structure of glucose

1. On the basis of elemental analysis and molecular weight determination the molecular formula of glucose is  $\text{C}_6\text{H}_{12}\text{O}_6$ .
2. The reduction of glucose with red phosphorus and HI gives n-hexane.



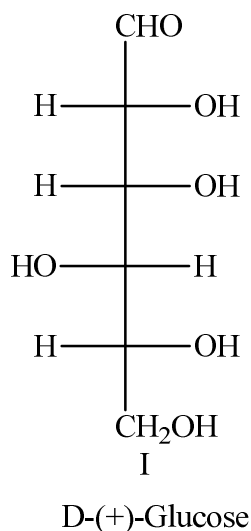
Therefore, the six carbon atoms of glucose form a straight chain.

3. It forms penta acetate on treatment with acetic anhydride which indicates the presence of five hydroxyl groups in the molecule.
4. Glucose reacts with hydroxyl amine to form an oxime and with hydrogen cyanide to form cyanohydrins. It indicates the presence of a carbonyl group. It also forms phenylhydrazone on treatment with phenylhydrazine.

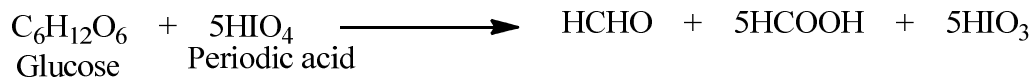
- The mild oxidation of glucose with bromine water or sodium hypobromide yields a monocarboxylic acid (gluconic acid) containing same number of carbon atoms as in glucose, i.e., six. This indicates that the carbonyl group must be aldehyde group.
- The catalytic reduction of glucose gives a hexahydric alcohol (sorbitol) which gives hexaacetate on treatment with acetic anhydride. The sixth hydroxyl group must be obtained by the reduction of aldehyde group, thus further confirming the presence of an aldehyde group and five hydroxyl groups in glucose.
- Oxidation of gluconic acid with nitric acid yields a dicarboxylic acid (glucaric acid) with the same number of carbon atoms as in glucose. Thus besides aldehyde group, glucose must contain a primary alcoholic group also, which generates the second carboxylic group on oxidation.
- Glucose is a stable compound and does not undergo dehydration easily, indicating that not more than one hydroxyl group is bonded to a single carbon atom. Thus all the hydroxyl groups are attached to different carbon atoms.

### Open –chain structure of glucose

On the basis of above reactions, Fisher assigned an open chain structure of glucose shown below as structure I



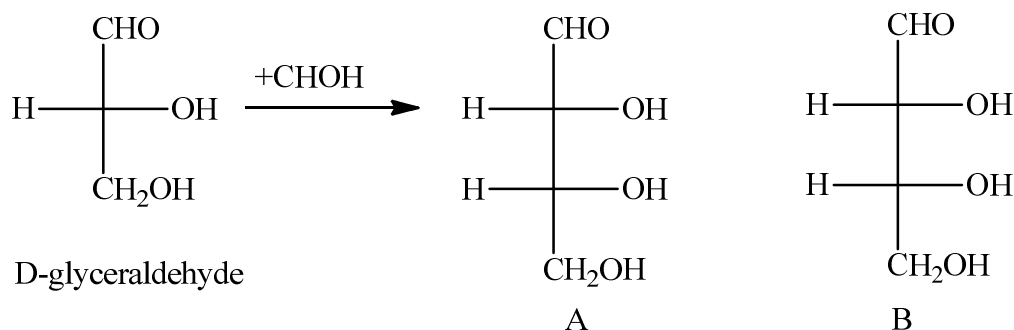
The above structure of glucose is also confirmed by the cleavage reaction of glucose with periodic acid. Five moles of periodic acid are consumed by one mole of glucose giving five moles of formic acid and one mole of formaldehyde.



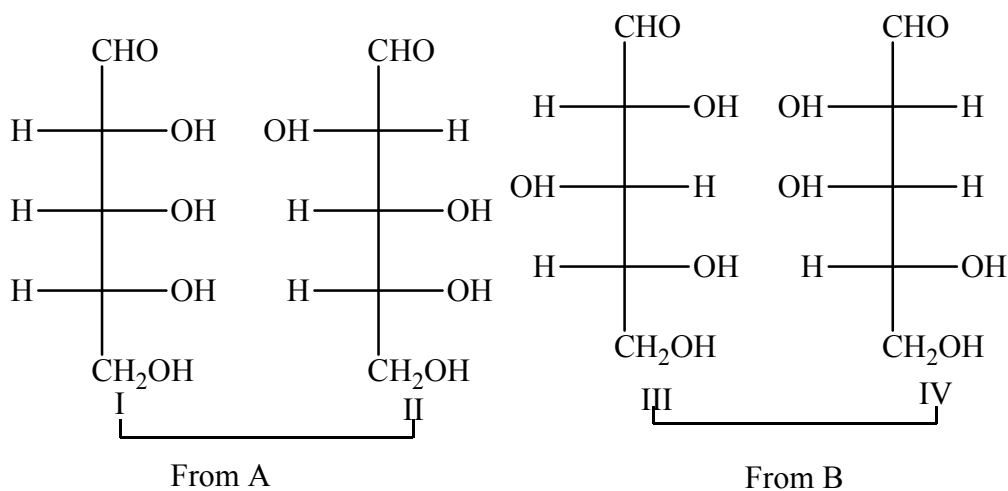
### Configuration of D-Glucose

The configuration of D-glucose was proved by Emil Fisher by arguments similar to the ones stated below.

1. Construction of four possible D-pentoses. Taking the configuration of D-glyceraldehyde as the standard, two possible D-aldotetroses (A and B) may be constructed by adding a CHOH just below CHO, placing OH to the right and then to the left.

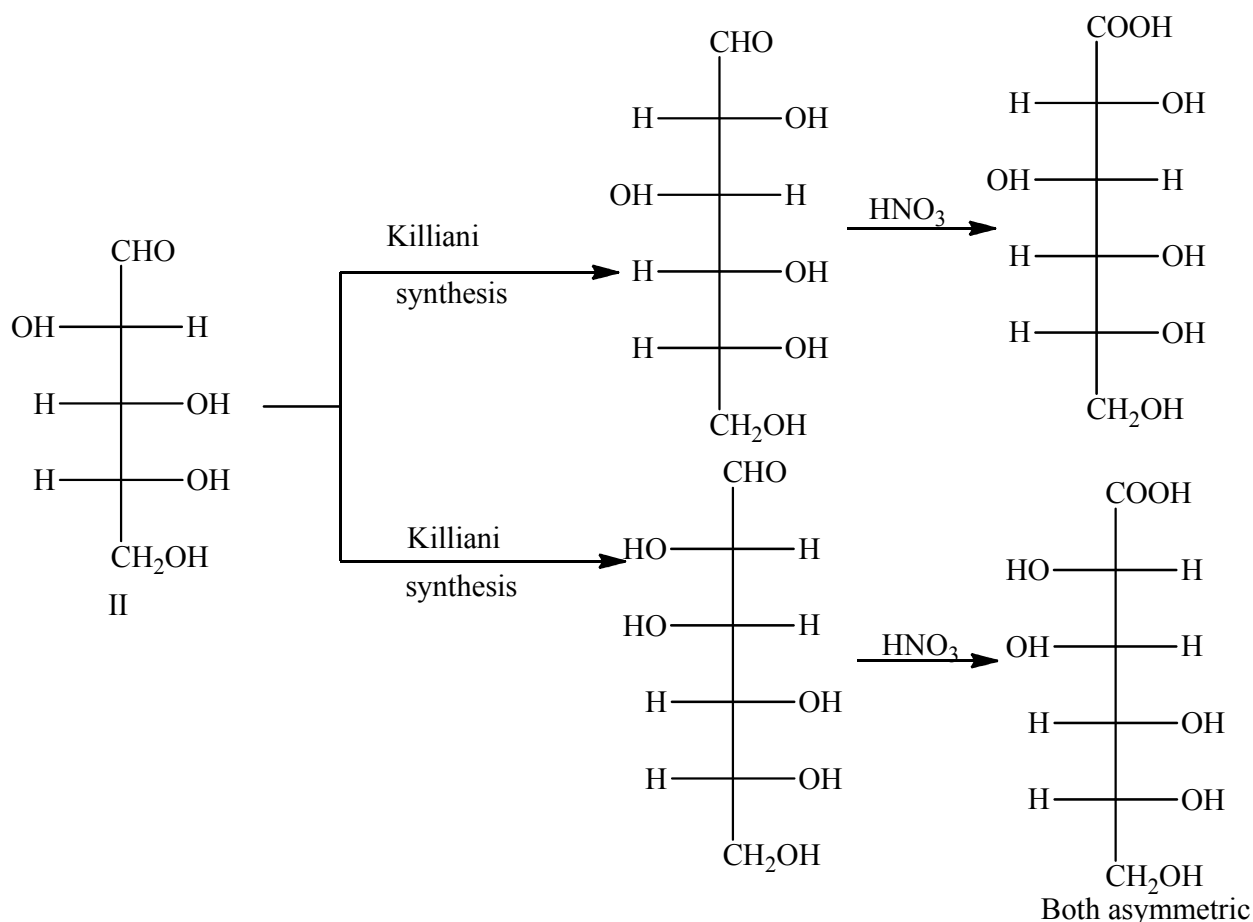


Similarly, each of the two D-tetroses (A and B) gives two D-aldopentoses. Thus four possible D-aldopentoses are:





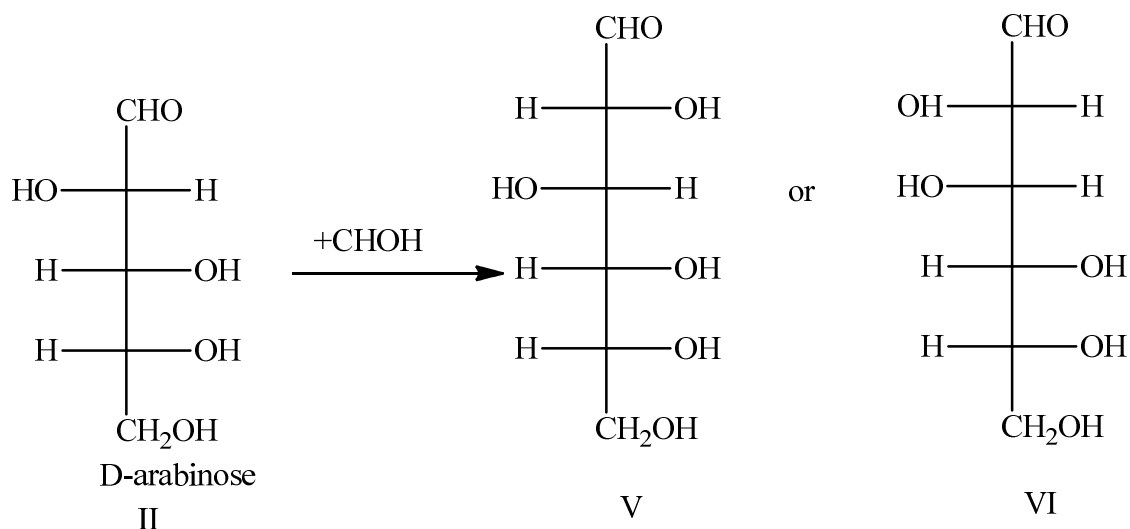
- D-Arabinose has configuration II or IV. Oxidation of D-arabinose with nitric acid oxidizes the terminal CHO and CH<sub>2</sub>OH groups yielding two optically active dicarboxylic acids. The forms II and IV can form two optically active diacids, while I and III can give meso acids only that have a plane of symmetry, therefore, D-arabinose is either II or IV.
- Configuration II confirmed for D-arabinose. D-arabinose by Killiani-Fisher synthesis yields two epimeric aldohexoses, D-glucose and D-mannose. These of oxidation with nitric acid form two optically active dicarboxylic acids. This is theoretically possible only if D-arabinose has the configuration II and not IV.



Proceeding similarly, you will find that if D-arabinose had configuration IV, of the two dicarboxylic acids derived from it, one would be meso and one asymmetric. Hence D-arabinose has the configuration II.

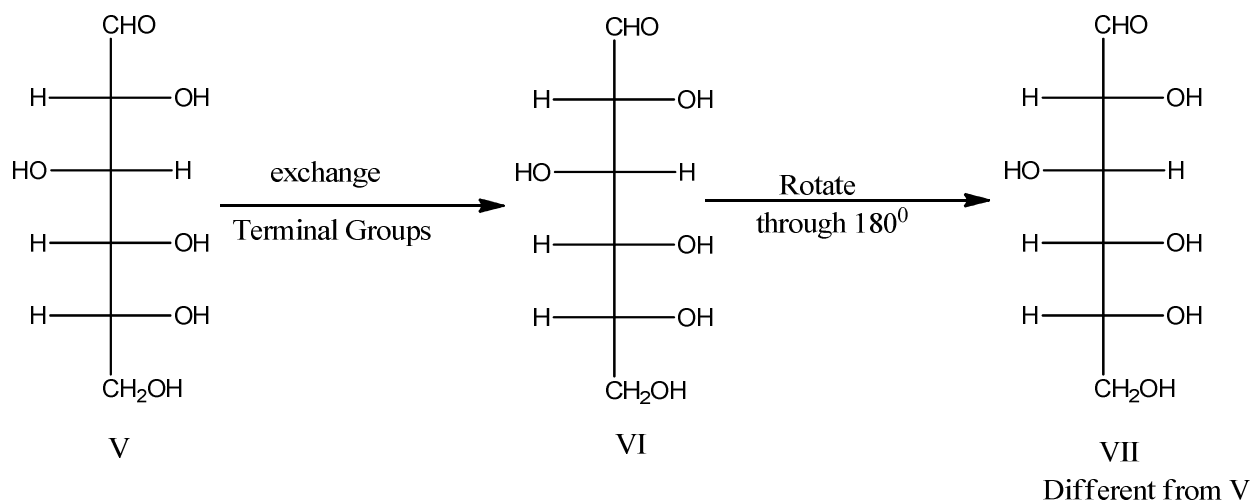
- Ruff degradation of D-glucose and D-mannose produces D-arabinose in each case. In Ruff degradation the CHOH below CHO is destroyed. Therefore, the configuration of the two

aldohexoses, D-glucose and D-mannose, can be derived by adding a new CHOH below CHO in form II of D-arabinose.



Hence D-glucose has configuration V or VI.

5. D-Glucose and L-Glucose yield the same dicarboxylic acid. This means that two sugars differ only in respect of the position of the terminal groups (CHO and CH<sub>2</sub>OH). Therefore, the exchange of the terminal groups in D-glucose should be able to give a different aldohexose (L-glucose). Let us now examine configuration formula V and VI (one of which is D-glucose) from the angle.



If VII is rotated through 180° in the plane of paper, it gives an aldohexose VII, different from V. a similar procedure with formula VI does not give rise to a different sugar.

From the above arguments it is evident that D-glucose has the configuration as shown by the form V.

### Cyclic structure of D-Glucose

The open chain structure of glucose explained most of its properties. However, it could not explain the following facts.

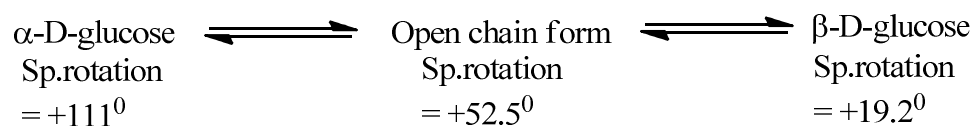
1. Despite having an aldehyde group, glucose does not undergo certain characteristic reactions of aldehyde,
  - (a) Glucose does not react with sodium bisulphate to form addition product.
  - (b) Glucose does not react with ammonia.
  - (c) Glucose does not give Schiff's test and 2, 4-DNP test like other aldehydes.
2. Glucose reacts with hydroxylamine to form an oxime but glucose pentaacetate does not react with hydroxylamine. This shows that  $-CHO$  group is not present in glucose pentaacetate.
3. **D (+)-Glucose exist in two stereoisomeric forms i.e.,  $\alpha$ - D (+)-Glucose and  $\beta$ - D (+)-Glucose.** These two forms are crystalline and have different m.p and optical rotations. When glucose was crystallized from a concentrated solution at 303 K, it gave  $\alpha$ -form of glucose having m.p 419 K and  $[\alpha]_D = +111^\circ$ . On the other hand, the  $\beta$ -form of glucose is obtained on crystallization of glucose from a hot saturated solution of at a temperature above 371 K. The  $\beta$ -form of glucose has m.p 423 K and  $[\alpha]_D = +19.2^\circ$ .
4. **Mutarotation.** When either of two forms of glucose ( $\alpha$ - D-glucose and  $\beta$ - D-glucose) are dissolved in water and allowed to stand, these get slowly converted into other form and a equilibrium mixture of both  $\alpha$ - D-glucose (36 %) and  $\beta$ - D-glucose (about 64%) is formed.

The formation of equilibrium mixture can be explained as:

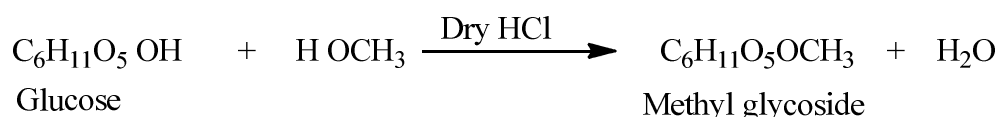
The  $\alpha$ - D-glucose has a specific rotation of  $+111^\circ$ , while  $\beta$ - D-glucose has a specific rotation of  $+19.2^\circ$ . When  $\alpha$ -form is dissolved in water, its specific rotation falls until a constant value of  $+52.5^\circ$  is reached. On the other hand, when  $\beta$ -form is dissolved in water, its specific rotation increases and becomes constant at  $52.5^\circ$ .

This spontaneous change in specific rotation of an optically active compound with time to an equilibrium value is called mutarotation. (Latin, *mutare* means to change).

Thus, there is an equilibrium mixture of  $\alpha$ - and  $\beta$ -forms in the solution



5. Glucose forms isomeric methyl glucosides. When glucose is heated with methanol in the presence of dry HCl, it gives two isomeric monomethyl derivatives known as  $\alpha$ -D-glucoside (m.p. = 438 K) and  $\beta$ -D-glucoside (m.p. 380 K).



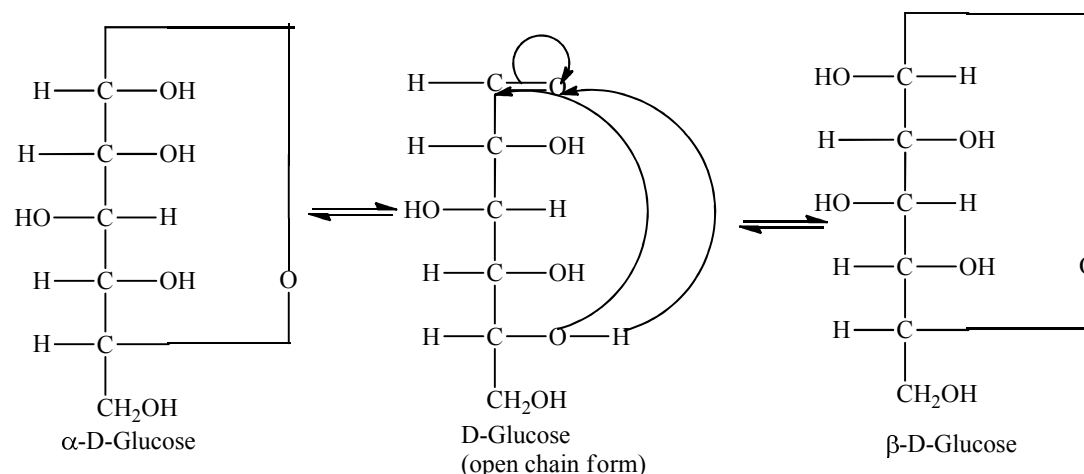
These two glucosides do not reduce Fehling's solution and also do not react with HCN or  $\text{NH}_2\text{OH}$  indicating that the free  $-\text{CHO}$  group is not present but it is converted to  $-\text{COOH}$  group.

### Cyclic structure of Glucose

#### Anomers:

Glucose forms a hemiacetal between the  $-\text{CHO}$  group and the  $-\text{OH}$  group on the  $\text{C}_5$  atom. As a result, of cyclisation,  $\text{C}_1$  becomes asymmetric (chiral) and the newly formed  $-\text{OH}$  group may be either on the left or on the right in Fisher projection formulae. These results in the formation of two isomers which differ in the orientation of H and  $-\text{OH}$  groups around  $\text{C}_1$  atom. These isomers are known as  $\alpha$ - D-glucose and  $\beta$ - D-glucose. The isomer having the  $-\text{OH}$  group on the right is called  $\alpha$ - D-glucose and one having the  $-\text{OH}$  group on the left is called  $\beta$ - D-glucose. Such pairs of optical isomers which differ in the configuration only around  $\text{C}_1$  atom are called anomers.

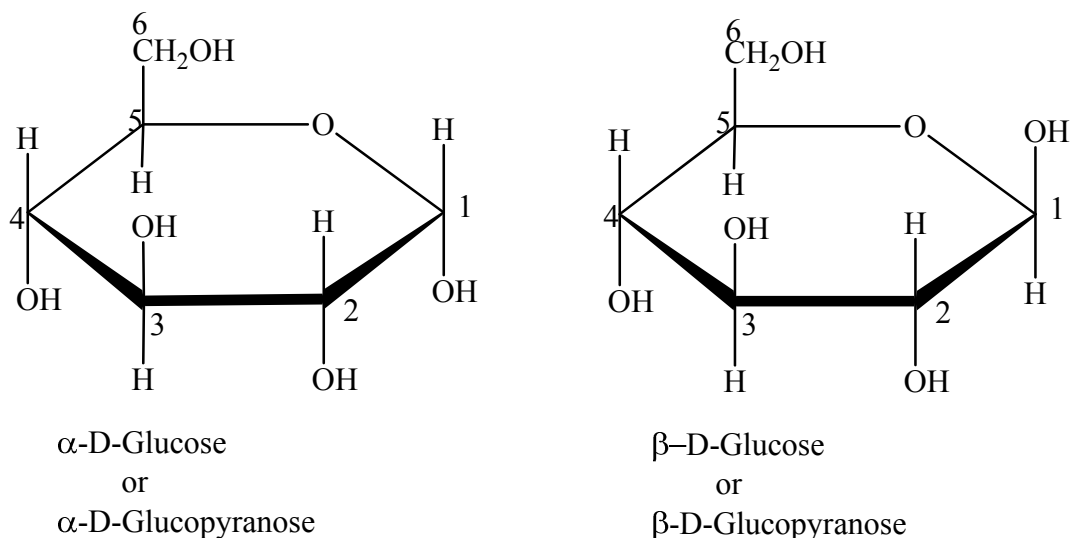
These two forms are not mirror image of each other, hence are not enantiomers. The  $\text{C}_1$  carbon is known as anomeric carbon or glycosidic carbon.



The above representations are called Fisher projection formulae.

### Haworth projection formulae or pyranose structures of D-Glucose.

In Haworth structures drawn with the heterocyclic oxygen in the upper right corner, the  $\alpha$ -form has the  $-\text{OH}$  group on  $\text{C}_1$  pointing “down”. The  $\beta$ -form has the same group pointing “up”. For D-sugars, the free  $-\text{CH}_2\text{OH}$  group of an aldohexose is drawn above the plane of ring when ring oxygen is in the upper right. The rest is the simple, the groups on the left of the Fisher projection are up and those on the right are down in the Haworth structure.



**Fructose**

Fructose is another commonly known monosaccharide having the same molecular formula as glucose. It is laevorotatory because it rotates plane polarized light towards the left. It is present abundantly in fruits. That is why it is called fruit-sugar also.

**Physical properties**

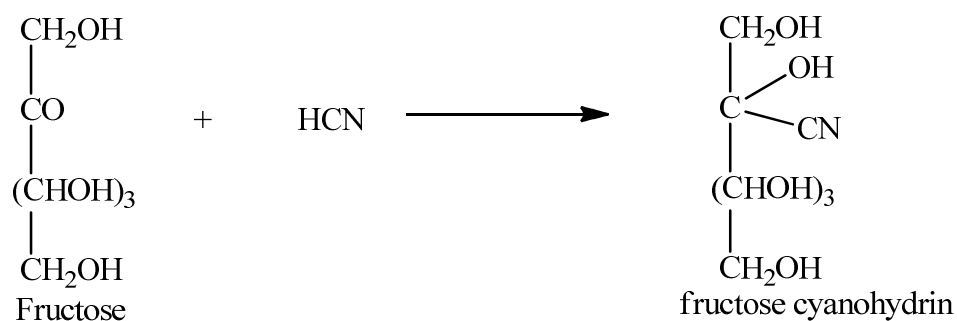
1. It is sweetest of all known sugars.
2. It is readily soluble in water, sparingly soluble in alcohol and insoluble in ether.
3. It is white crystalline solid with m.p. 375 K.
4. Fresh solution of fructose has a specific rotation  $-133^{\circ}$ .

**Chemical properties of fructose**

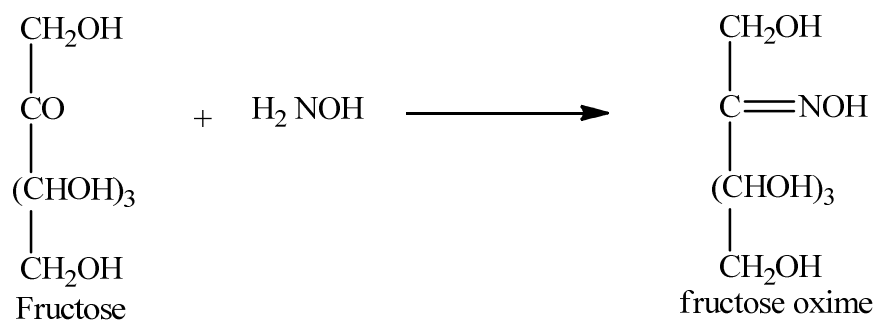
Chemical properties of fructose can be studied under the following heads:

**(A) Reactions due to ketonic group**

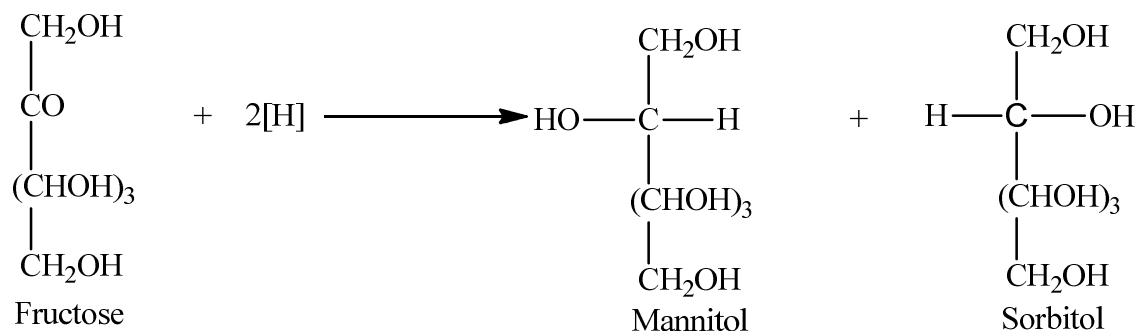
1. **Reaction with HCN.** Fructose reacts with HCN to form cyanohydrins.



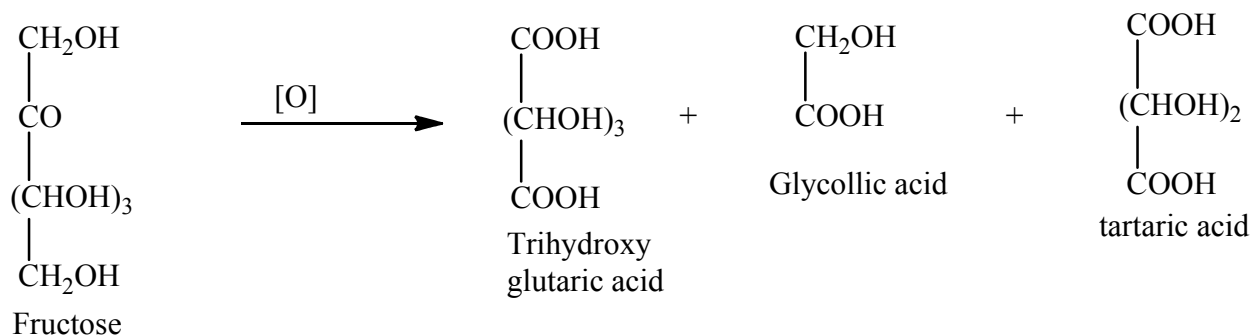
2. **Reaction with hydroxylamine.** Fructose reacts with hydroxylamine to form an oxime.



3. **Reduction.** Fructose gives a mixture of sorbitol and mannitol on reduction with Na-Hg and water or catalytic hydrogenation.



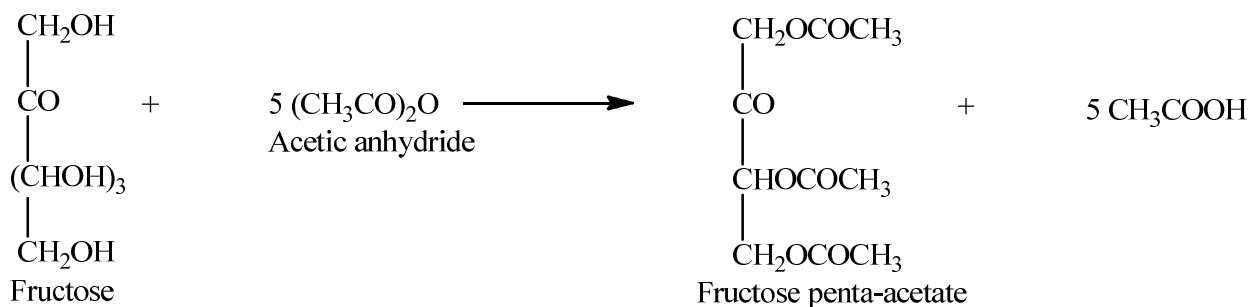
4. **Oxidation.** (i) there is no action of mild oxidizing agent like bromine water on fructose.  
 (ii) Strong oxidizing agents like nitric acid oxidize fructose into a mixture of trihydroxy glutaric, glycolic and tartaric acids.



- (iii) Unlike other ketones, it reduces Tollen's reagent and Fehling solution. This is due to the presence of traces of glucose in alkaline medium.

### [B] reactions of the alcoholic group

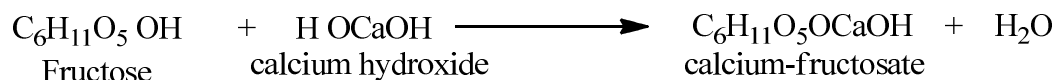
1. **Acetylation** . with acetic anhydride or acetyl chloride, fructose forms penta-acetate.



**2. Reaction with methyl alcohol (glucoside formation).** Fructose reacts with methyl alcohol in the presence of dry HCl gas forming methyl fructoside.



**3. Reaction with metallic hydroxides (fructosate formation)**



### Structure of Fructose

1. elemental analysis and molecular weight determination of fructose show that it has the molecular formula  $\text{C}_6\text{H}_{12}\text{O}_6$ .

2. fructose on reduction gives sorbitol which on reduction with HI and red P gives a mixture of n-hexane and 2-Iodohexane. This reaction indicates that six carbon atoms in fructose are in a straight chain.

3. Fructose reacts with hydroxylamine, HCN and phenylhydrazine. It shows the presence of  $\text{-CHO}$  or  $\text{C=O}$  group in the molecule of fructose.

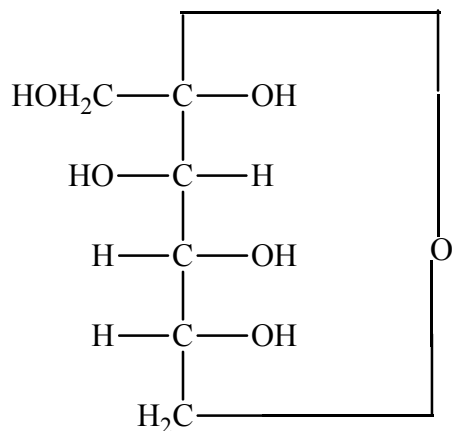
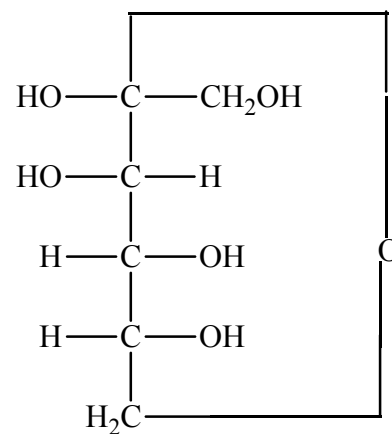
4. On treatment with bromine water, no reaction takes place. This rules out the possibility of presence of  $\text{-CHO}$  group.

5. on oxidation with nitric acid, it gives glycollic acid and tartaric acids which contain smaller number of carbon atoms than fructose. This shows that a ketonic group is present at position 2. It is at this point that the molecule is broken.

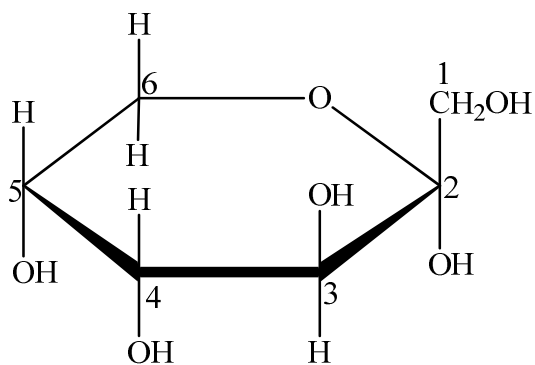
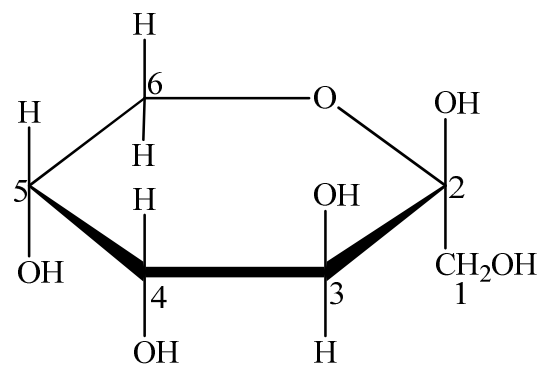
### Cyclic structure of D-Fructose

Fructose shows the property of mutarotation. This means that it exists in two forms  $\alpha$ -fructose and  $\beta$ -fructose which are cyclic in structure and change into each other via the open chain structure. The cyclic and pyranose structures of  $\alpha$ -D-fructose and  $\beta$ -D-fructose are represented below:

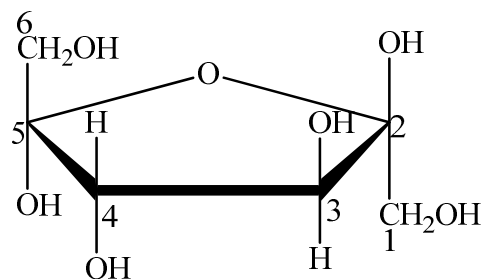


 $\alpha$ -D-fructose $\beta$ -D-fructose

Haworth Pyranose structure

 $\alpha$ -D-fructopyranose $\beta$ -D-fructopyranose

However, when fructose is linked to glucose in a sucrose molecule, it has the furanose structure as shown below:

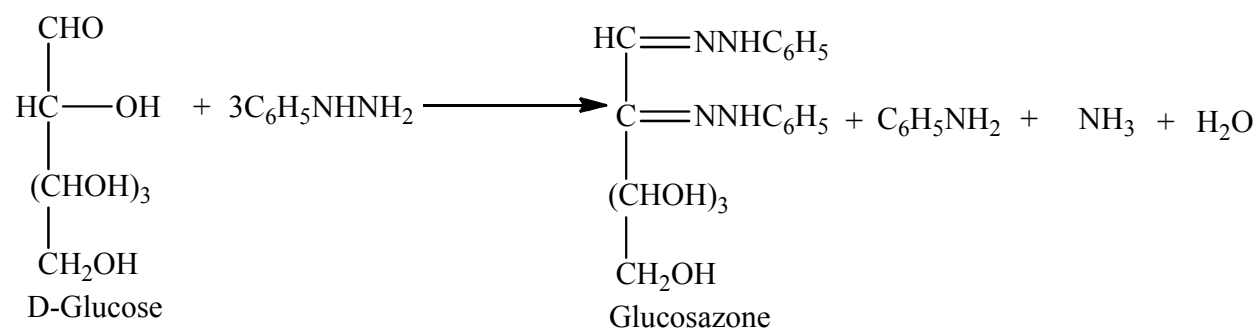
 $\beta$ -D-fructofuranose

---

## 7.5 MECHANISM OF OSAZONE FORMATION

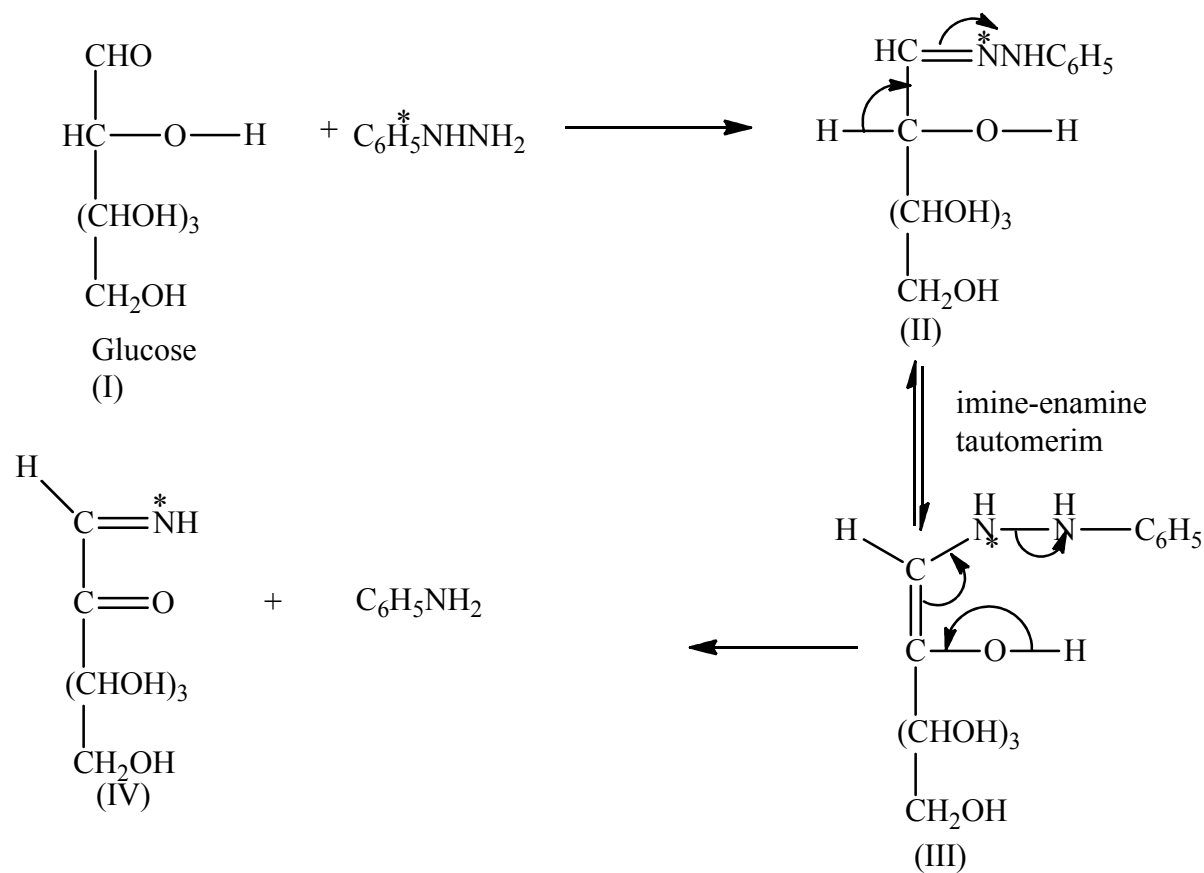
---

Glucose and fructose react with one equivalent of phenylhydrazine, forming phenylhydrazone. In contrast,  $\alpha$ -hydroxy carbonyl compounds react with three equivalents of phenylhydrazine to form bis-phenylhydrazones, commonly called osazones.



Phenylosazones crystallize readily and are useful derivatives for identifying sugars.

**Mechanism:** the first equivalent of phenylhydrazine forms phenylhydrazone with the aldehyde or ketone group as expected. Phenylhydrazone then undergoes the rearrangement, known as Amadori rearrangement, to give  $\alpha$ -iminoketone (IV) with the loss of aniline.



Subsequent attack of two moles of phenylhydrazine on the iminoketone (scheme-a) or on the ketoaldehyde (scheme-b) results in the formation of osazone accompanied by the elimination of ammonia.

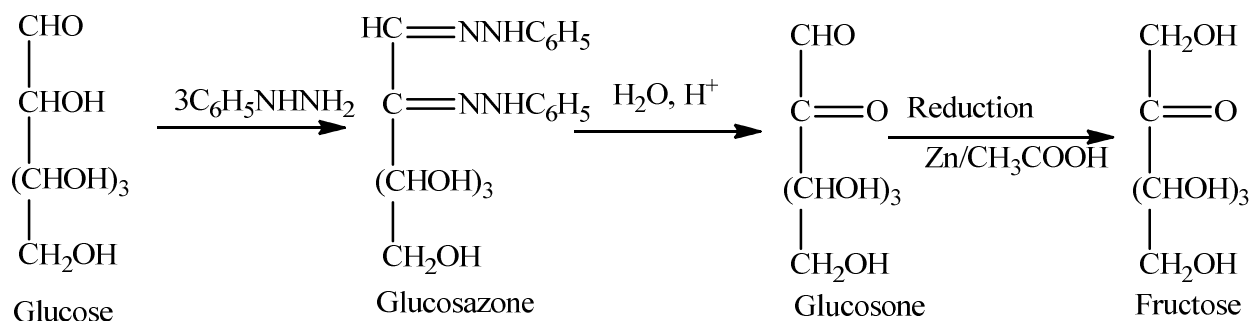
The given mechanism is supported by the observation that when phenyl hydrazone prepared by the reaction of glucose with  $\text{N}^{15}$  ( $\text{N}^*$ ) labeled phenylhydrazine is treated with ordinary phenylhydrazine, unlabelled osazone is obtained accompanied by the expulsion of labelled ammonia.

---

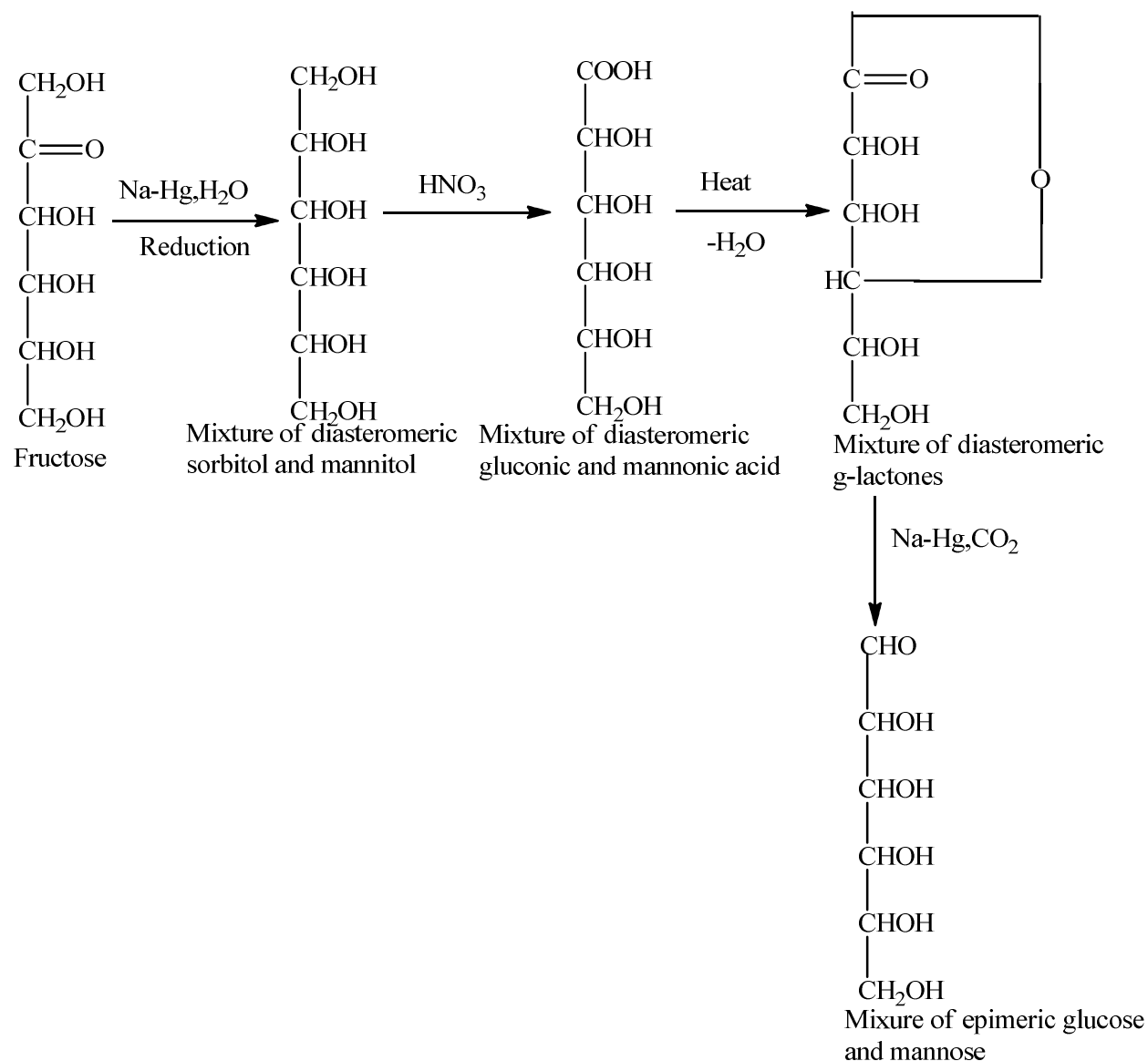
## 7.6 INTERCONVERSION OF GLUCOSE AND FRUCTOSE

---

(a) Conversion of an aldose into an isomeric ketose. The procedure used for this purpose may be illustrated by taking into account the conversion of glucose into fructose.



(b) Conversion of ketose into an isomeric aldose. The procedure used here may be illustrated by taking into account the conversion of fructose into a mixture of epimeric aldoses, viz., glucose and mannose.

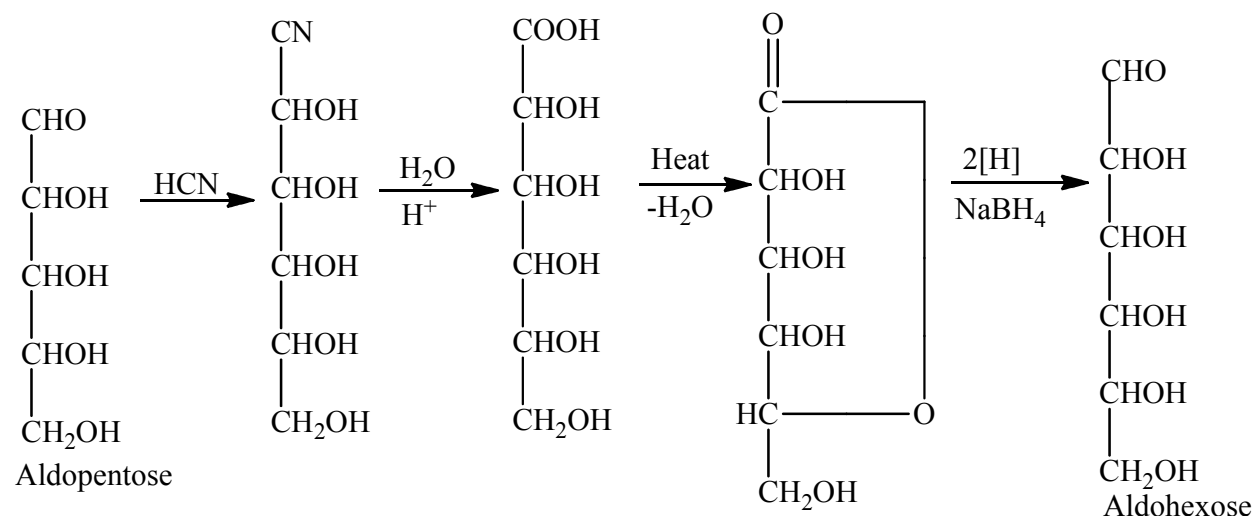


## 7.7 CHAIN LENGTHENING AND CHAIN SHORTENING OF ALDOSE

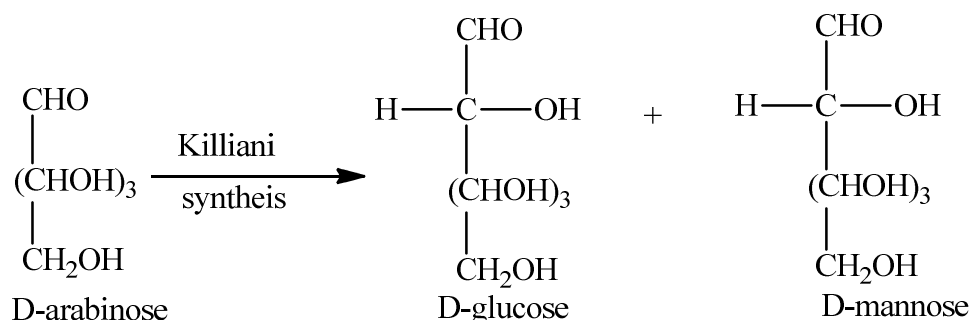
### (a) Lengthening of aldoses: Killiani-Fisher synthesis

The aldose chains may be lengthened by one carbon atom by a procedure known as **Killiani-Fisher synthesis**. Thus an aldose may be converted to the next higher member by the following steps: (1) Formation of cyanohydrins; (2) hydrolysis of -CN to -COOH, giving aldonic acid; (3)

conversion of aldonic acid to lactone by heating; (4) reduction of lactone with sodium borohydride,  $\text{NaBH}_4$ , to get higher aldose. For illustration, the overall change is the creation of an asymmetric centre at C-2 where a new  $\text{CHOH}$  has been added. Therefore their result two aldoses with one carbon more and differing only in configuration at C-2.



Taking a specific example, D-arabinose by killiani-Fisher synthesis gives two isomeric aldohexoses, D-glucose and D-mannose which differ only in the configuration at C-2

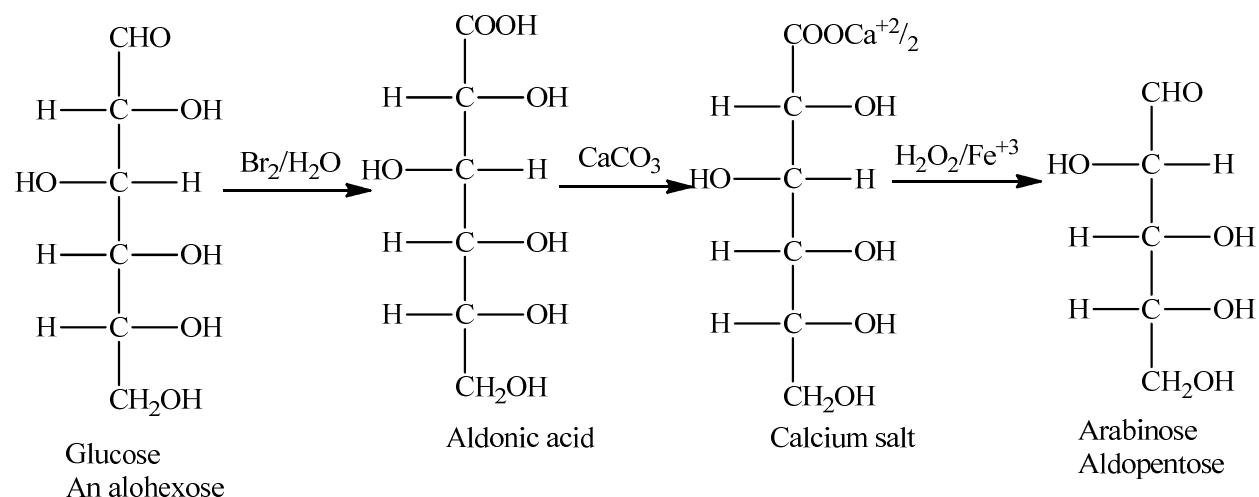


Such sugars which differ in configuration only at one asymmetric centre (C-2) are called Epimers.

### (b) Shortening of aldoses

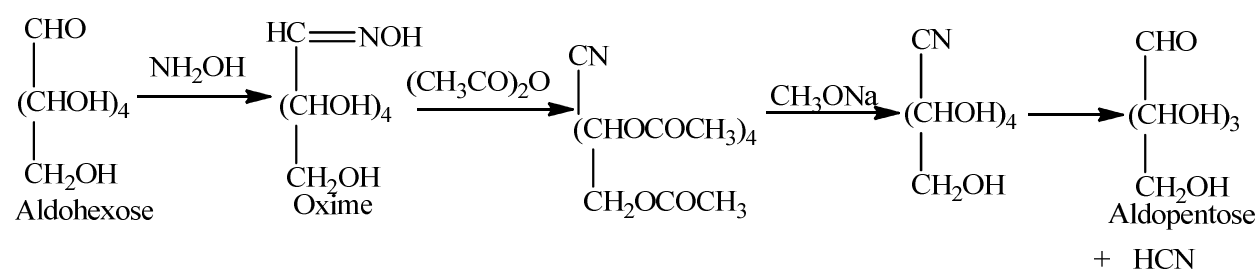
**(1) Ruff degradation.** An aldose may be converted into a lower aldose having one carbon atom less, i.e., the carbon chain may be shortened by Ruff degradation.

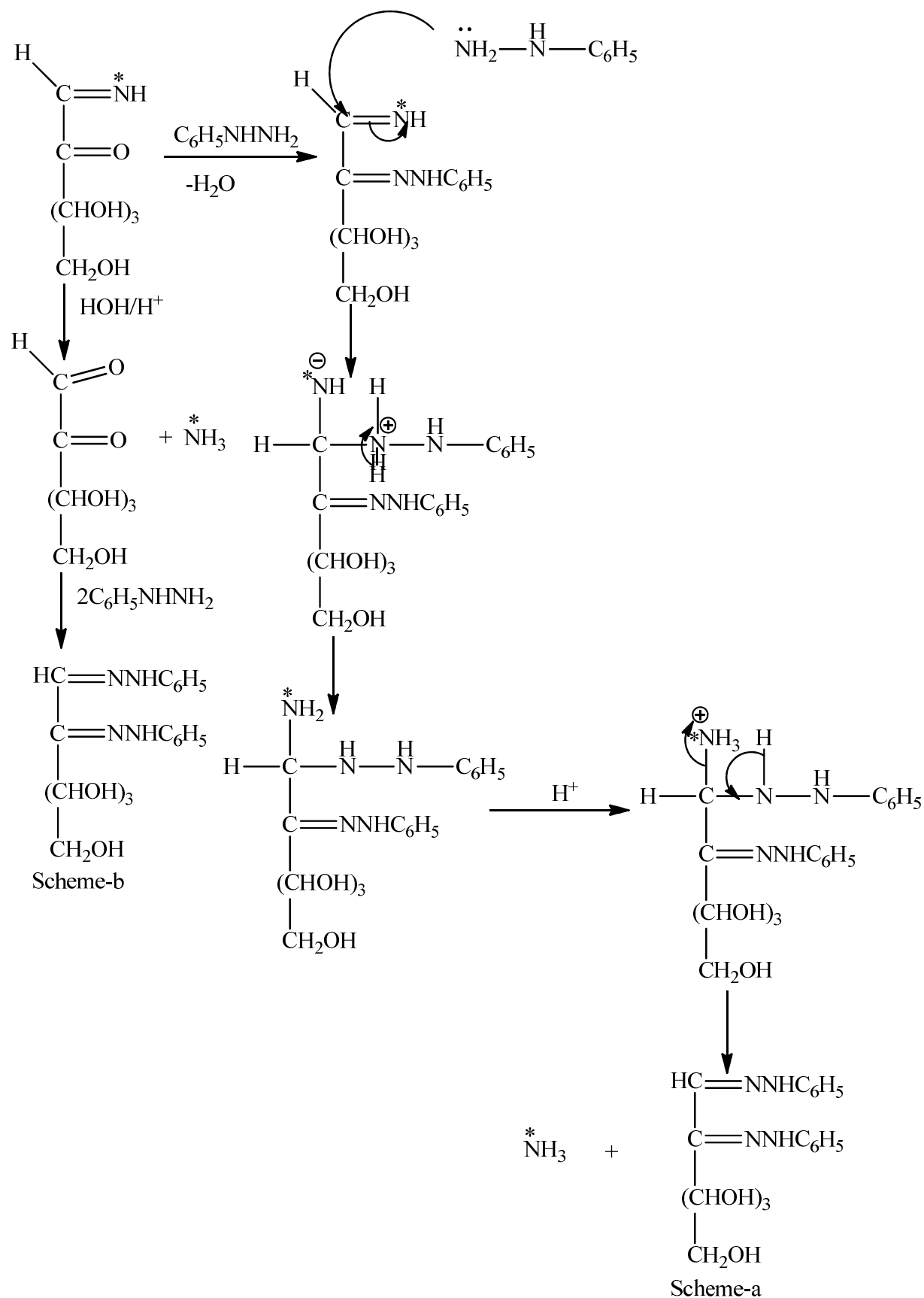
The method involves the oxidation of starting aldose into the corresponding aldonic acid. The acid is converted into its calcium salt which is treated with Fenton's reagent ( $\text{H}_2\text{O}_2$  in presence of  $\text{Fe}^{+3}$  ion) to get the lower aldose. This method is illustrated as follows:



## (2) Wohl's degradation for chain shortening in aldoses

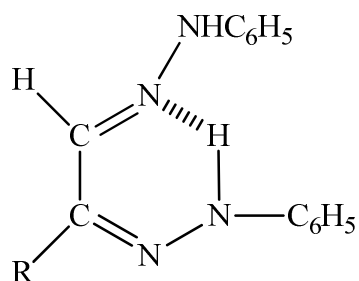
In this degradation, the aldose is converted into its oxime by treatment with hydroxylamine. The oxime is treated with acetic anhydride when the oxime is dehydrated to nitrile. The nitrile is then treated with sodium methoxide. The cyanohydrin obtained undergoes degradation to a lower aldose. The reaction are written as under.







The osazone so formed does not undergo further Amadori rearrangement. This is the reaction with phenylhydrazine stops at this stage; thus further reaction at C-3 –OH group does not occur. This is because the osazone so formed, does not react further via intramolecular Amadori rearrangement involving C-3 –OH group because of the intramolecular hydrogen bonding as shown below:




---

## 7.8. SUMMARY

---

- Carbohydrates are poly hydroxy aldehydes and ketones.
- Monosaccharides containing an aldehyde group are called aldoses and those with a keto group are called ketoses.
- Carbohydrates can also be classified as disaccharides, oligosaccharides, and polysaccharides consist of monosaccharides linked by glycosidic bonds.
- The most abundant monosaccharide in nature is 6- carbon sugar, D-glucose. It exists as  $\alpha$  and  $\beta$  anomers with different optical rotations.
- If two monosaccharides isomers differ in configuration around one specific carbon atom [With exception of carbonyl carbon] they are called epimers of each other.

---

## 7.9. MODEL EXAMINATION QUESTIONS

---

1. Define and classify carbohydrates with suitable examples.
2. Explain Kiliani-Fischer synthesis and Ruff's degradation.
3. Explain the limitations of open chain D-glucose structure.
4. Establish the structure of glucose and fructose.

---

***REFERENCES***

---

1. A text book of organic chemistry, A. Bahl and B.S.Bahl, S.Chand & Compant Ltd.
2. Chemistry for degree students, R.L.madan, S.Chand & Compant Ltd.
3. Organic chemistry, Vol.III, Jagdamba singh and L.D.S Yadav, Prgati Prakashan.
4. Modern chemistry, S.P.Jauhar, Modern Publishers.
5. Organic chemistry, Francis A.Carey, Tata McGraw-Hill Company Ltd.

---

## UNIT-8 CARBOHYDRATES-II

---

### CONTENTS

- 8.1 Objectives
- 8.2 Introduction
- 8.3. Configuration of monosaccharides
- 8.4. Erythro and threo distereomers conversion of glucose
- 8.5 ethers and esters
- 8.6. Determination of ring size of monosaccharides
- 8.7. Cyclic structure of D-glucose
- 8.8. Mechanism of mutarotation
- 8.9. General study of disaccharides
- 8.10. General introduction of structure of ribose and deoxyribose
- 8.11. General study of polysaccharides
- 8.12 Summary
- 8.13. Model examination questions

---

### ***8.1 OBJECTIVES***

---

After going through this unit you will be able to:

- Know about configuration of monosaccharides
- Discuss about Erythro and threo distereomers conversion of glucose
- Describe ether and ester formation,
- Determination of ring size of monosaccharides,
- Cyclic structure of D-glucose

- Mechanism of mutarotation
- Types of disaccharides and their properties
- Structure of ribose and deoxyribose
- Polysaccharides and its types

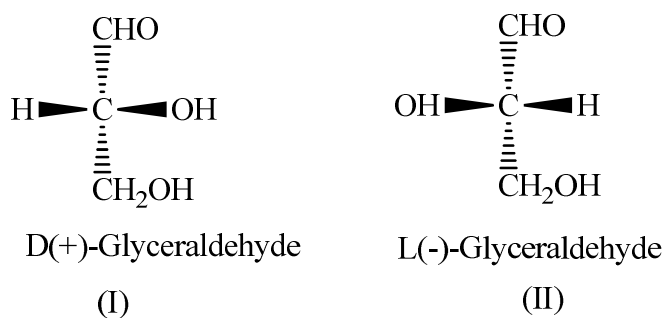
## 8.2 INTRODUCTION

The carbohydrates are an important class of naturally occurring organic compounds. They occur naturally in plants (where they are produced photosynthetically), when the word "carbohydrate" was coined, it originally referred to compounds of general formula  $C_n(H_2O)_n$ . However, only the simple sugars or monosaccharides fit this formula exactly. The other types of carbohydrates, oligosaccharides, and polysaccharides, are based on monosaccharide units and have slightly different general formula. Carbohydrates also called "saccharides" which means sugar in Greek.

Many commonly encountered carbohydrates are polysaccharides, including glycogen, which is found in animals, and starch and cellulose, which occur in plant.

## 8.3 CONFIGURATION OF MONOSACCHARIDES

In early days of development of stereochemistry of organic compounds, it was not possible to determine the absolute configurations. The chemists were only interested in knowing the relative configurations. To decide about configurations, Emil Fisher in 1885 chose glyceraldehyde ( $CHOCHOHCH_2OH$ ) as the standard substance and fixed its relative configurations arbitrarily. This compound exists in two enantiomeric forms, as given below:



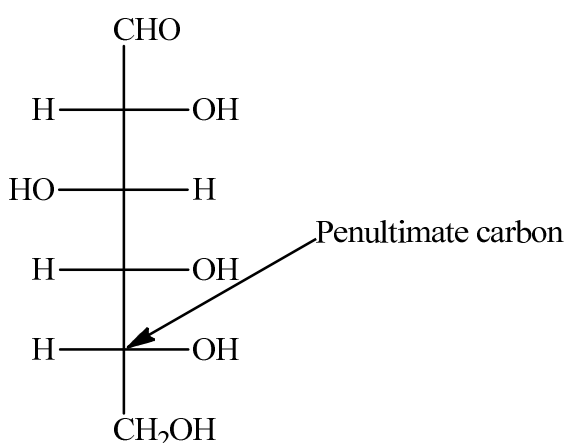
Compound I was found to be dextrorotatory and compound II was found to be laevorotatory. The difference between configuration of the two compounds is that in compound (I), -H is located

on the L.H.S and  $\text{-OH}$  is located on the R.H.S. of the Fisher projection formula while in compound (II), this is in reverse order.

Configuration of other compounds was then assigned by relating their configuration to that of D- or L-Glyceraldehyde.

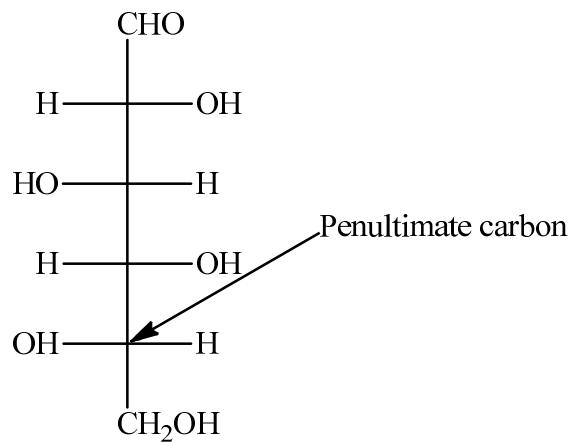
In 1951 Bijvoet using x-ray crystallography established that the arbitrarily assigned configurations of glyceraldehydes actually represented their correct absolute configurations. Thus, if the configuration of glyceraldehydes were correct, the derived relative configurations of other compound must also be their correct absolute configuration.

Thus D- and L- glyceraldehydes serve as reference molecule for all the monosaccharides. A monosaccharide whose penultimate carbon (farthest chiral carbon atom from most oxidizing end i.e,  $\text{-CHO}$ ) has the same configuration as D-Glyceraldehyde has L-configuration. Similarly , amonosaccharide whose penultimate carbon has the same configuration as L-Glyceraldehyde has L-configuration. This is illustrated with the help of following examples.



#### **D-configuration**

(because the configuration at penultimate carbon is the same as that of D-Glyceraldehyde)



#### **L-configuration**

(because the configuration at penultimate carbon is the same as that of L-Glyceraldehyde)

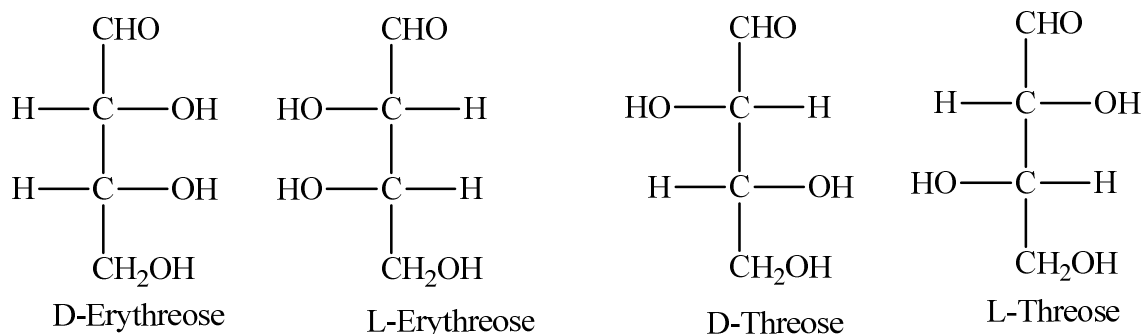
---

### ***8.4. ERYTHRO AND THREO DIASTEROMERS CONVERSION OF GLUCOSE***

---

Erythro and Threo system of nomenclature is used only in aldotetroses. Aldotetrose have two chirality centres and therefore four stereoisomers. Two of the sttereoisomers are D-sugars

and two are L-sugars. When Fischer projections are drawn for stereoisomers with two adjacent chirality centres, the pair of enantiomers with similar groups on the same side of the carbon chain is called the erythro enantiomers. The pair of enantiomers with similar groups on opposite sides are called the threo enantiomers. The names of erythro and threo pairs of enantiomers in fact, originated from the name of aldotetroses, erythrose and threose.



Erythrose and threose are diastereomers.

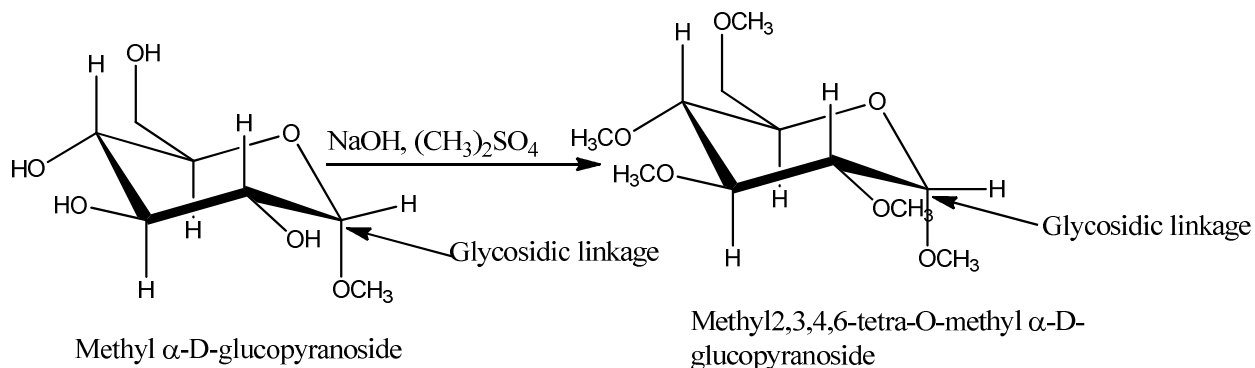
---

## 8.5. ETHERS AND ESTERS

---

### (a) Formation of ethers

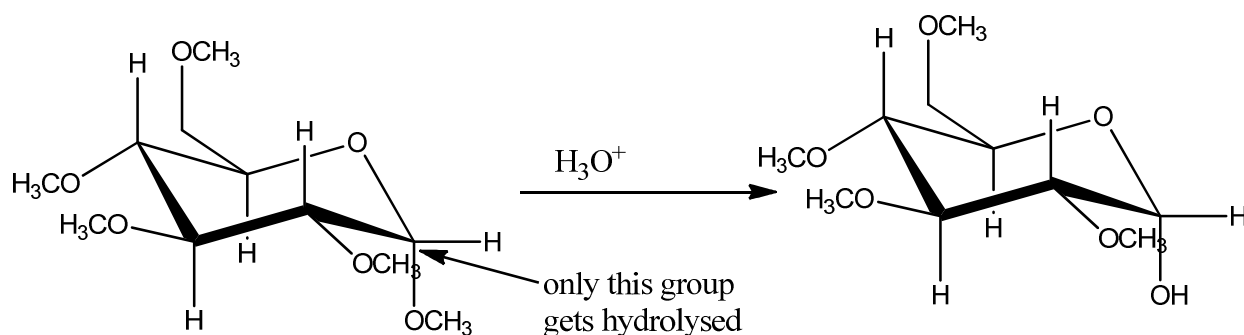
It is possible to convert the -OH groups attached to carbons other than anomeric carbon into alkyl derivatives having ordinary ether C-O-C linkages. For example methyl glucoside can be converted into pentamethyl derivative by treatment with excess dimethyl sulphate in aqueous sodium hydroxide. The function of sodium hydroxide is to convert hydroxyl groups into alkoxide ions which then react with dimethyl sulphate by an  $S_N2$  reaction to form methyl ethers.



Since all the  $-OH$  groups are converted into  $-OCH_3$  groups, the process is called exhaustive methylation or permethylation.

For naming these compounds, each  $-OCH_3$  group except that of glycosidic linkage is named as an O-methyl group.

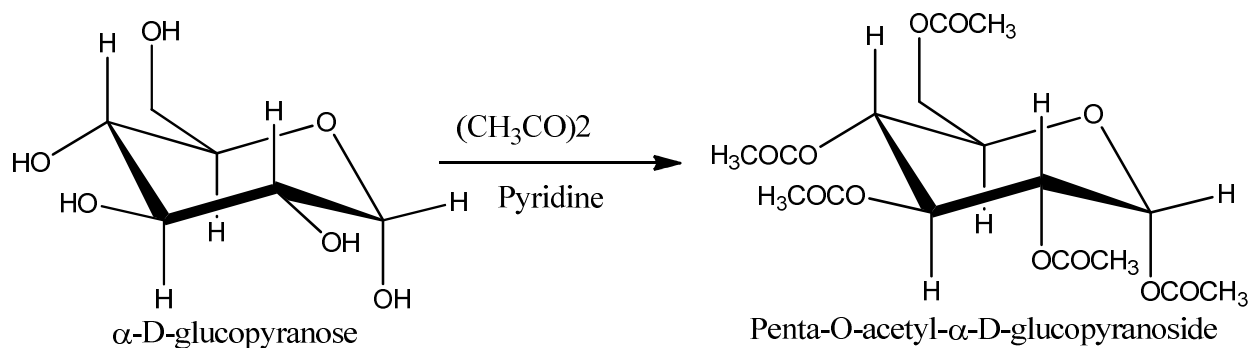
When permethylated glycoside is treated with dilute aqueous acid, the methyl glycoside bond gets hydrolysed (since acetals are hydrolysed in acidic solution). But the other methyl groups remain unaffected. This is because ordinary ether groups are stable in dilute aqueous acids. This is shown as under:



The process of permethylation of glycosides followed by acidic hydrolysis of glycosidic linkage forms an important method for determining the ring size of monosaccharides. This has been illustrated in the case of cyclic structure of glucose.

### (b) Formation of esters

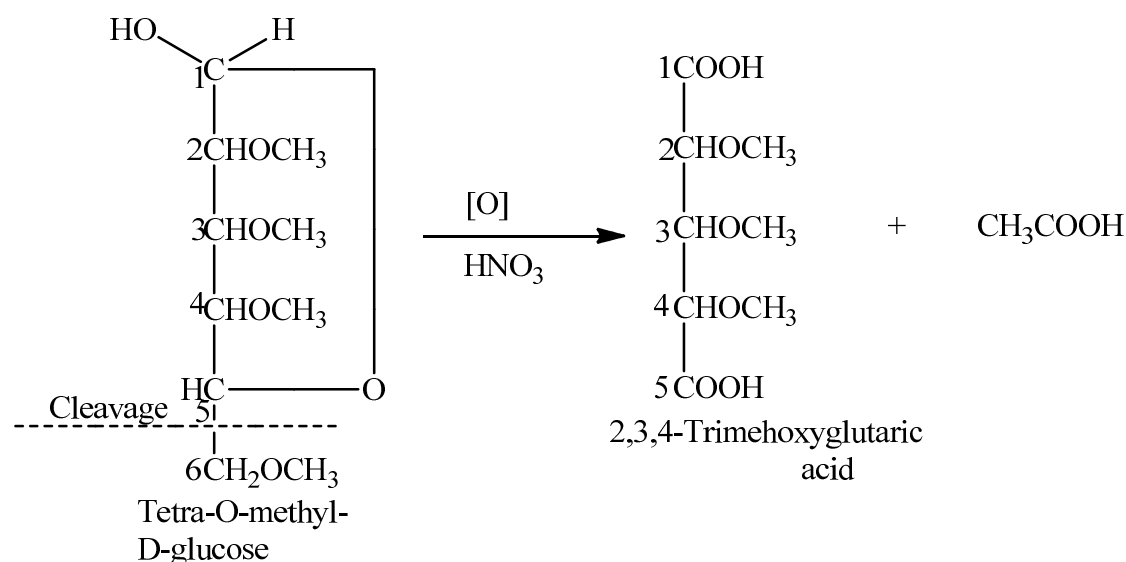
Monosaccharides on treatment with acetic anhydride are converted into ester derivatives which are very useful crystalline compounds. The monosaccharide is treated with acetic anhydride and pyridine when all the hydroxyl groups are converted to ester groups. When carried out at low temperature (273 K), the reaction takes place stereospecifically,  $\alpha$ -anomer gives the  $\alpha$ -acetate and the  $\beta$ -anomer gives the  $\beta$ -acetate. For example:



### **8.6. DETERMINATION OF RING SIZE OF MONOSACCHARIDES**

So far we have represented structure of cyclic hemiacetals or anomers of D-glucose as having a ring of six members, five carbons and one oxygen. This has been proved to be correct and a five membered ring has been ruled out.

Hirst (1926) prepared tetra-O-methyl-D-glucose with dimethyl sulphate and subsequent acid hydrolysis of the pentamethyl derivative formed. The oxidation of tetra-O-methyl-D-glucose with nitric acid yielded trimethoxyglutaric acid.



Obviously, the two carboxylic carbons (1, 5) of the trimethoxyglutaric acid are the one's originally involved in ring formation. Hence, there must have existed an oxide ring between C-1 and C-5. Tracing back the reaction sequence, it stands proved that D-glucose has a six membered



ring. The presence of a 6-membered ring in D-glucose has also been confirmed by X-ray analysis.

---

### 8.7. CYCLIC STRUCTURE OF D-GLUCOSE

---

The open chain structure of glucose explained most of its properties. However, it could not explain the following facts.

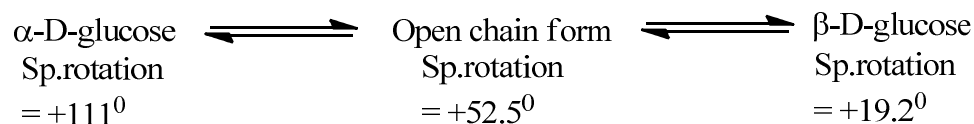
6. Despite having an aldehyde group, glucose does not undergo certain characteristic reactions of aldehyde,
  - (d) Glucose does not react with sodium bisulphate to form addition product.
  - (e) Glucose does not react with ammonia.
  - (f) Glucose does not give Schiff's test and 2, 4-DNP test like other aldehydes.
7. Glucose reacts with hydroxylamine to form an oxime but glucose pentaacetate does not react with hydroxylamine. This shows that  $-CHO$  group is not present in glucose pentaacetate.
8. **D (+)-Glucose exist in two stereoisomeric forms i.e.,  $\alpha$ - D(+)-Glucose and  $\beta$ - D(+)-Glucose.** These two forms are crystalline and have different m.p and optical rotations. When glucose was crystallized from a concentrated solution at 303 K, it gave  $\alpha$ -form of glucose having m.p 419 K and  $[\alpha]_D = +111^\circ$ . On the other hand, the  $\beta$ -form of glucose is obtained on crystallization of glucose from a hot saturated solution of at a temperature above 371 K. The  $\beta$ -form of glucose has m.p 423 K and  $[\alpha]_D = +19.2^\circ$ .
9. **Mutarotation.** When either of two forms of glucose ( $\alpha$ - D-glucose and  $\beta$ - D-glucose) are dissolved in water and allowed to stand, these get slowly converted into other form and a equilibrium mixture of both  $\alpha$ - D-glucose (36 %) and  $\beta$ - D-glucose (about 64%) is formed.

The formation of equilibrium mixture can be explained as:

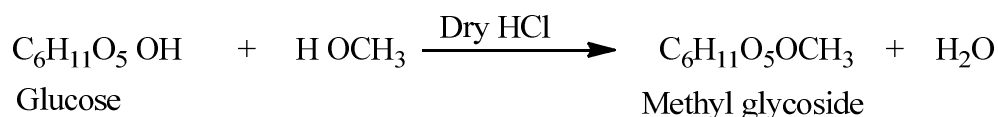
The  $\alpha$ - D-glucose has a specific rotation of  $+111^\circ$ , while  $\beta$ - D-glucose has a specific rotation of  $+19.2^\circ$ . When  $\alpha$ -form is dissolved in water, its specific rotation falls until a constant value of  $+52.5^\circ$  is reached. On the other hand, when  $\beta$ -form is dissolved in water, its specific rotation increases and becomes constant at  $52.5^\circ$ .

This spontaneous change in specific rotation of an optically active compound with time to an equilibrium value is called mutarotation. (Latin, muto means to change).

Thus, there is an equilibrium mixture of  $\alpha$ - and  $\beta$ -forms in the solution



10. Glucose forms isomeric methyl glucosides. When glucose is heated with methanol in the presence of dry HCl, it gives two isomeric monomethyl derivatives known as  $\alpha$ -D-glucoside (m.p. = 438 K) and  $\beta$ -D-glucoside (m.p. 380 K).



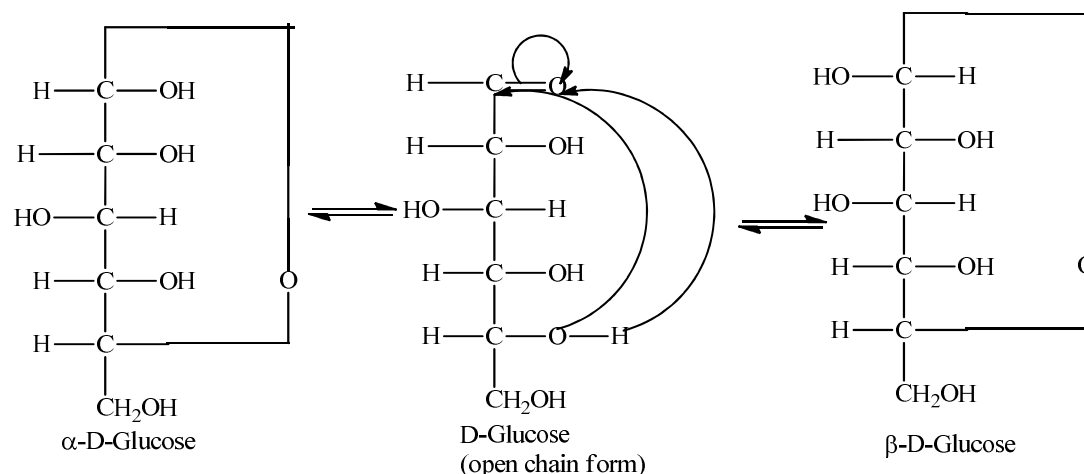
These two glucosides do not reduce Fehling's solution and also do not react with HCN or  $\text{NH}_2\text{OH}$  indicating that the free  $-\text{CHO}$  group is not present but it is converted to  $-\text{COOH}$  group.

### Cyclic structure of Glucose

#### Anomers.

Glucose forms a hemiacetal between the  $-\text{CHO}$  group and the  $-\text{OH}$  group on the  $\text{C}_5$  atom. As a result, of cyclisation,  $\text{C}_1$  becomes asymmetric (chiral) and the newly formed  $-\text{OH}$  group may be either on the left or on the right in Fisher projection formulae. This result in the formation of two isomers which differs in the orientation of H and  $-\text{OH}$  groups around  $\text{C}_1$  atom. These isomers are known as  $\alpha$ - D-glucose and  $\beta$ - D-glucose. The isomer having the  $-\text{OH}$  group on the right is called  $\alpha$ - D-glucose and one having the  $-\text{OH}$  group on the left is called  $\beta$ - D-glucose. Such pairs of optical isomers which differ in the configuration only around  $\text{C}_1$  atom are called anomers.

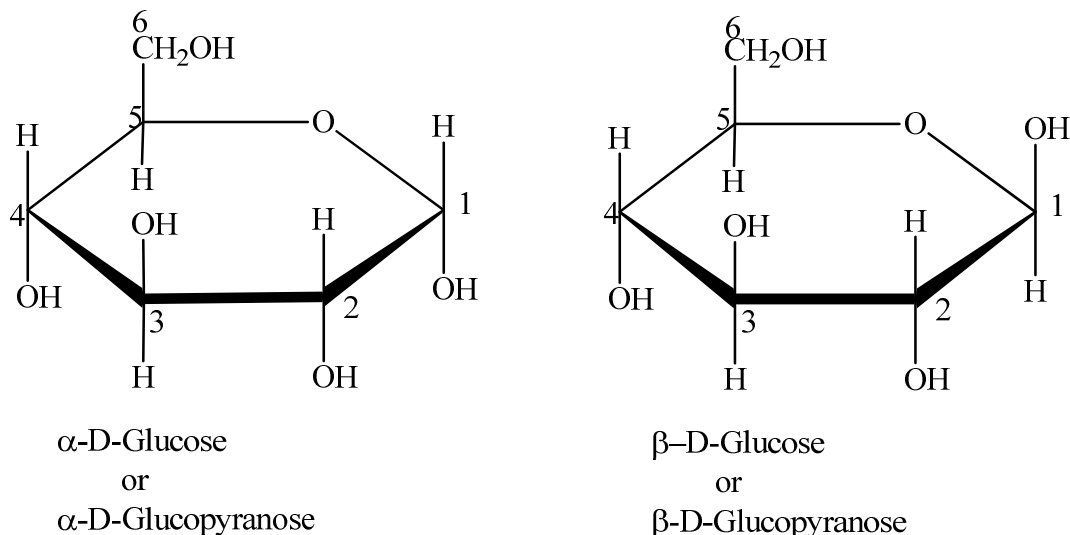
These two forms are not mirror image of each other, hence are not enantiomers. The  $\text{C}_1$  carbon is known as anomeric carbon or glycosidic carbon.



The above representations are called Fisher projection formulae.

### Haworth projection formulae or pyranose structures of D-Glucose.

In Haworth structures drawn with the heterocyclic oxygen in the upper right corner, the  $\alpha$ -form has the  $-\text{OH}$  group on  $\text{C}_1$  pointing “down”. The  $\beta$ -form has the same group pointing “up”. For D-sugars, the free  $-\text{CH}_2\text{OH}$  group of an aldohexose is drawn above the plane of ring when ring oxygen is in the upper right. The rest is the simple, the groups on the left of the Fisher projection are up and those on the right are down in the Haworth structure.



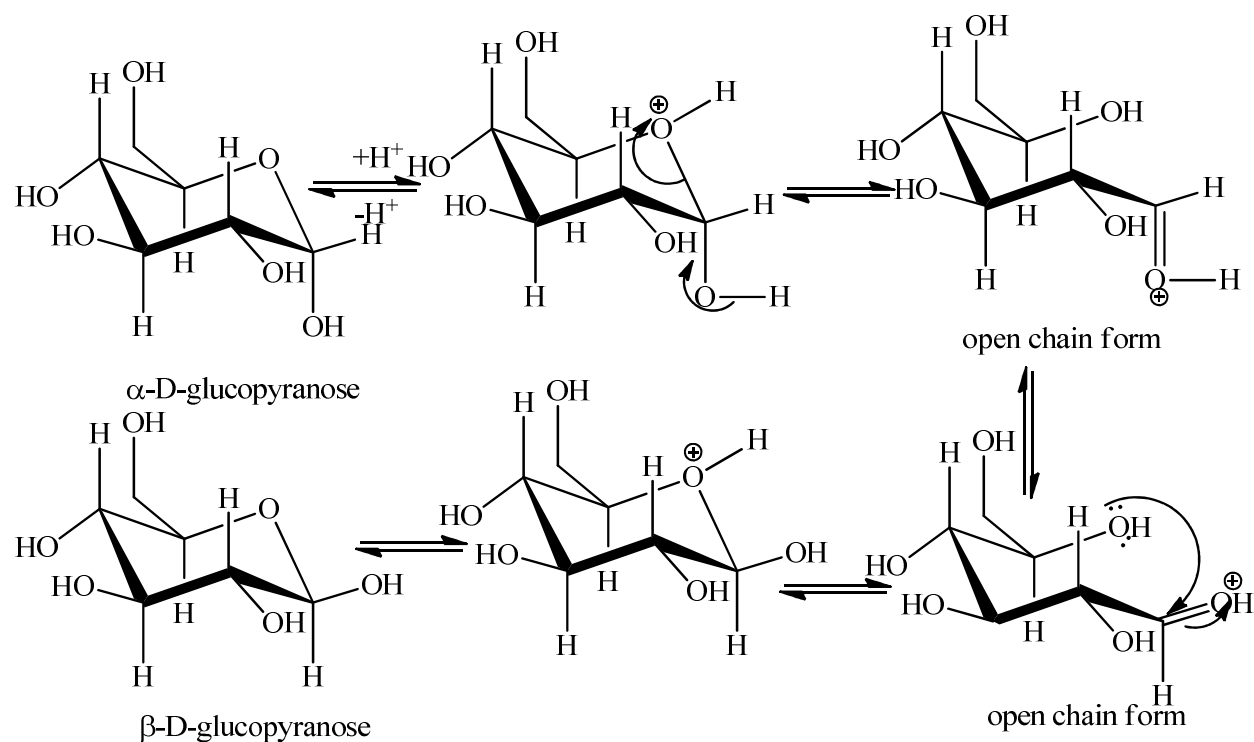

---

## 8.8. MECHANISM OF MUTAROTATION

---

Mutarotation occurs by opening of the ring to the free carbonyl form. The mechanism shown in Scheme I begins as the reverse of hemiacetal (or hemiketal) formation. An  $180^\circ$  rotation about the bond to the carbonyl group permits attack of the hydroxyl group at C-5 on the opposite face of the carbonyl carbon. Hemiacetal formation then gives the other anomer. Mutarotation is catalysed by both acid and base.

Thus, the easy opening and closing of hemiacetal or hemiketal linkage is responsible for mutarotation.



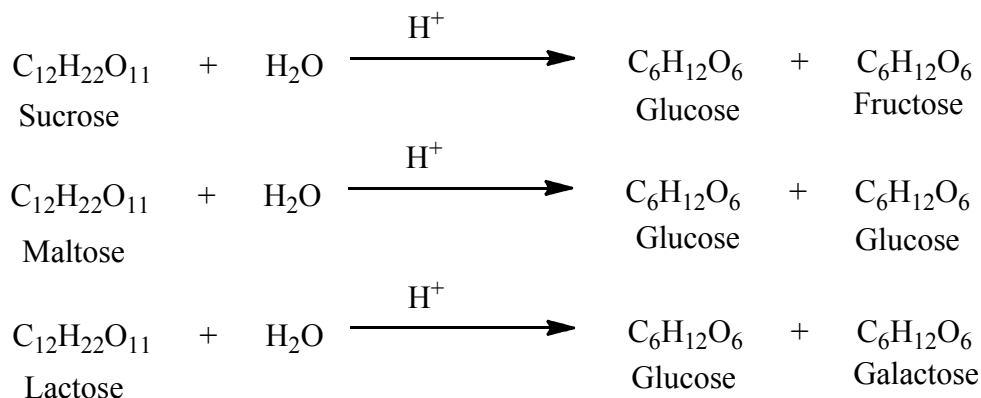
**Scheme I. Acid catalysed mechanism of mutarotation**

---

## 8.9. GENERAL STUDY OF DISACCHARIDES

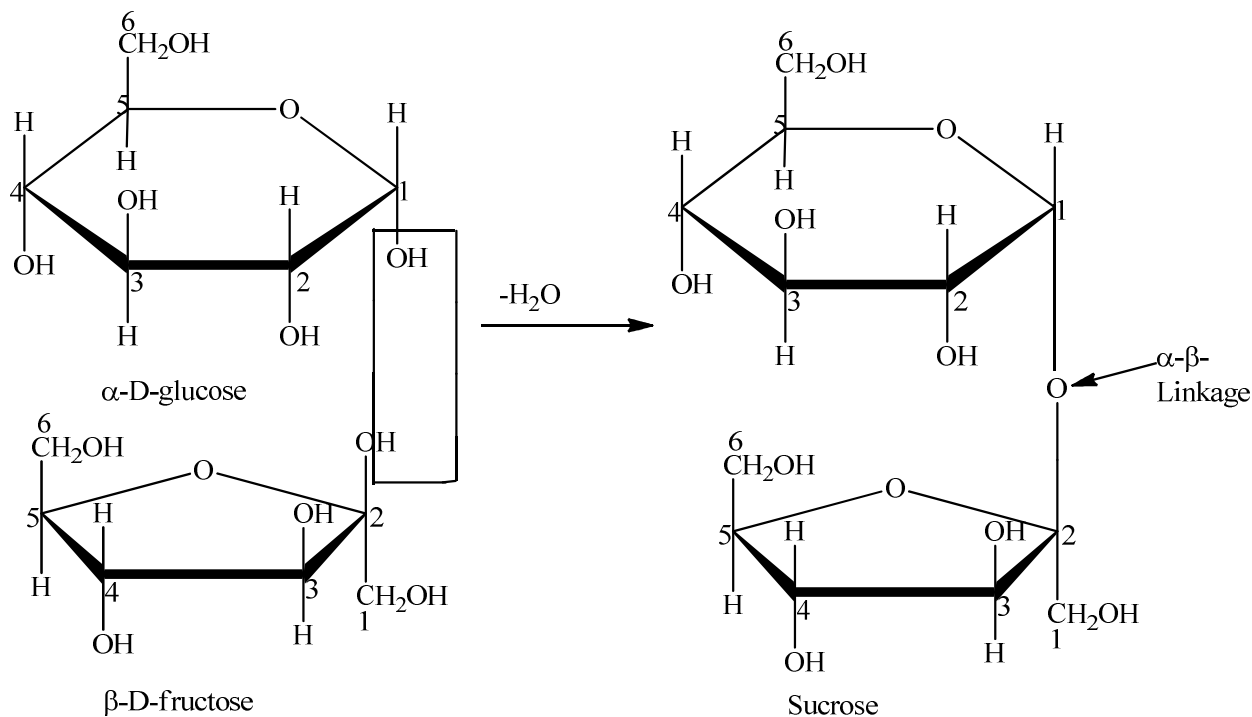
---

Disaccharides are the carbohydrates which on hydrolysis give two same or different monosaccharides. Their general formula is  $C_{12}H_{22}O_{11}$ . The important members belonging to disaccharides are sucrose, maltose, and lactose. On hydrolysis with dilute acids or enzymes these give the following two molecules of monosaccharides.



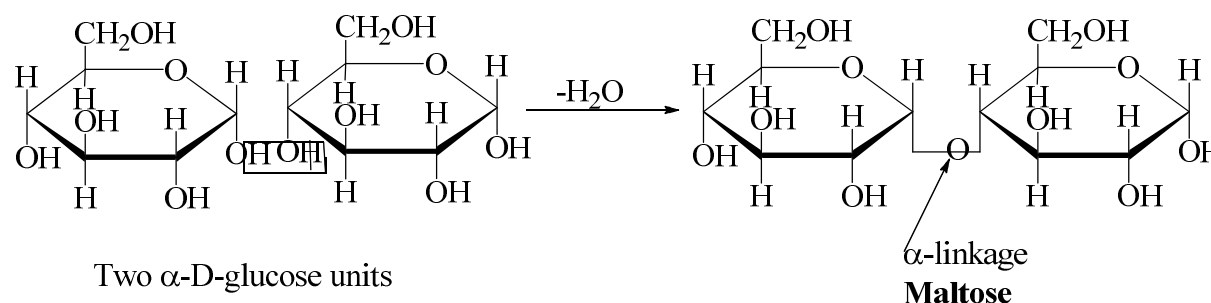
In disaccharides, the two monosaccharides are joined together by acetal or glycosidic formation. The hemiacetal OH of one monosaccharide and an OH of second monosaccharide, dehydrate to establish the bond (called glycosidic bond) between the two monosaccharides. That is, disaccharides are composed of two units of monosaccharides joined by glycosidic linkage.

**Sucrose (Cane Sugar).** Sucrose is ordinary table sugar. It is obtained from cane sugar. Sucrose is composed of  $\alpha$ -D-glucose and  $\beta$ -D-fructose unit. These units are joined by  $\alpha,\beta$ -glycosidic linkage between C-1 of glucose and C-2 of fructose unit.



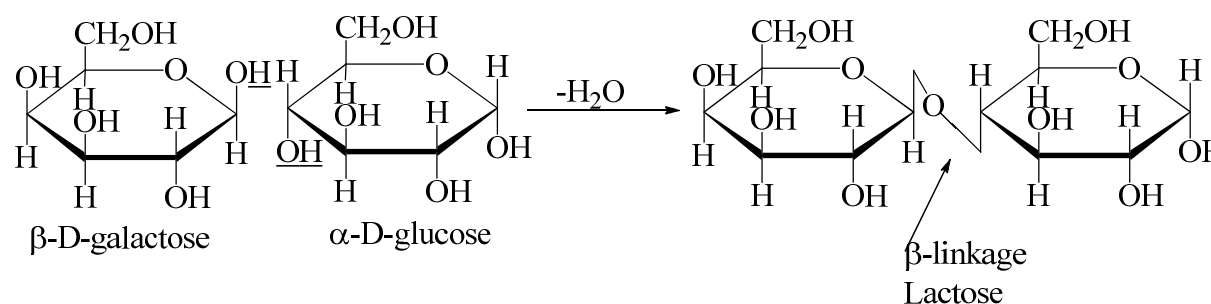
Notice that in the above structure of sucrose, hemiacetal structure is missing. That is why sucrose: (a) does not form an osazone with phenylhydrazine (b) does not reduce Tollen's reagent or Fehling's solution (sucrose is a non reducing sugar) (c) does not exhibit mutarotation.

**Maltose:** It is obtained from starch. It is composed of two  $\alpha$ -D-glucose units joined by a  $\alpha$ -glycosidic linkage between C-1 of one unit and C-4 of the other unit.



Notice that C-1 of the second glucose unit in the maltose structure is a hemiacetal carbon. Consequently, it is in equilibrium with the open chain aldehyde form. Thus maltose can exist in  $\alpha$  and  $\beta$  forms. Since it has a potential aldehyde group, maltose shows mutarotation, forms osazone and reduces Fehling's solution (Maltose is a reducing sugar).

Lactose (Milk Sugar). It is found in milk of all animals. Cow's milk contains 4-5 % and human milk 6-7 % lactose. Lactose is composed of  $\beta$ -D-galactose unit and  $\alpha$ -D-glucose unit joined by  $\beta$ -D-glycosidic linkage between C-1 of the galactose and C-4 of the glucose unit.

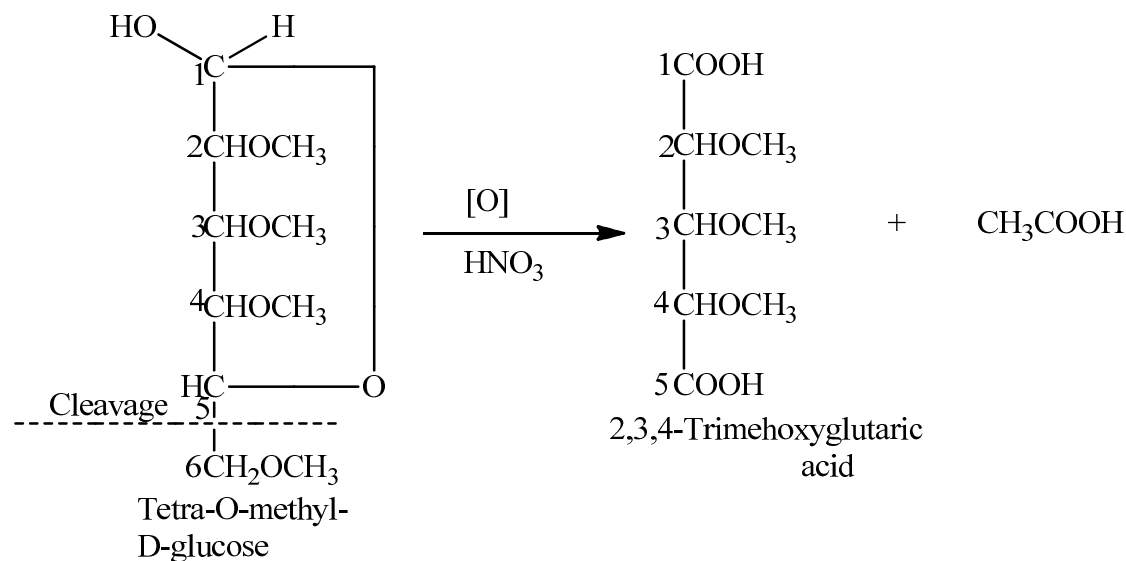


Like maltose, lactose can also exist in  $\alpha$  and  $\beta$  forms. Lactose is a reducing sugar and shows mutarotation. It reacts with Tollen's reagent and Fehling's solution.

**Determination of ring size of monosaccharides:**

So far we have represented structure of cyclic hemiacetals or anomers of D-glucose as having a ring of six members, five carbons and one oxygen. This has been proved to be correct and a five membered ring has been ruled out.

Hirst (1926) prepared tetra-O-methyl-D-glucose with dimethyl sulphate and subsequent acid hydrolysis of the pentamethyl derivative formed. The oxidation of tetra-O-methyl-D-glucose with nitric acid yielded trimethoxyglutaric acid.



Obviously, the two carboxylic carbons (1,5) of the trimethoxyglutaric acid are the one's originally involved in ring formation. Hence, there must have existed an oxide ring between C-1 and C-5. Tracing back the reaction sequence, it stands proved that D-glucose has a six membered ring. The presence of a 6-membered ring in D-glucose has also been confirmed by X-ray analysis.

### SUCROSE, Cane Sugar, (C<sub>12</sub>H<sub>22</sub>O<sub>11</sub>):

Sucrose is ordinary table sugar. It occurs chiefly in sugar cane and sugar beets. In smaller amounts it is present in maple sap, honey, and several fruits.

### Manufacture of Sucrose (Table Sugar):

In India and other tropical countries, the main source of sucrose is sugar cane. The modern method for the manufacture of 'Direct Consumption' sugar from cane consists of the following steps. (Fig 8.1).

**(1) Juice Extraction.** The crushed cane is passed through a roller mill to squeeze out juice. The partially exhausted 'cane mat' emerging from the mill is passed on to a tank, called Diffuser, by a chain conveyer. Here the maximum extraction of sucrose is done by washing with hot water and dilute juice on counter-current principle. This technique gets sugar extraction upto 98%. The cellulosic material discharged from the diffuser is called Bagasse and is used as fuel under boilers.

**(2) Juice Purification:** The raw juice contains 14-25% sucrose and much impurity such as organic acids, inorganic salts. Proteins and colouring matter. It is purified by the operations listed below:

**(i) Defecation:** The juice is heated with high pressure steam and treated with 2-3 % lime in a steel tank. This operation called defecation throws out organic acids as insoluble calcium salts, coagulated protein and colouring matter. The precipitate is removed by filtration.

**(ii) Carbonation:** Through the filtered juice is then  $\text{CO}_2$ . This operation known as carbonation, removes the excess, of lime as calcium carbonate which entraps colouring matter, colloidal and some inorganic salts. The 'mud' that settles is separated by filtration.

**(iii) Decolorisation:** In India, the clarified juice is decolorized by treating with  $\text{SO}_2$ . This operation called Sulphitation while it bleaches the brown colour of the juice, completes the neutralization of lime. The insoluble calcium sulphite is removed by filtration.

**(3) Concentration and Crystallisation:** The clear solution is then concentrated by boiling under reduced pressure in Multiple Effect Evaporators. In these, the steam produced in the first evaporator is used to boil the juice in the second maintained at a lower pressure; the second being used to boil the juice in the third kept at a still lower pressure; and son on.

The concentrated juice is finally passed to the Vacuum Pan where further evaporation reduces the water content to 6-8%. Here partial separation of crystals takes place. The mixture of



syrup and crystals, known as Massecuite, is then discharged into a large tank, the Crystallising Tank, fitted with cooling pipes. The crystals grow and form a thick crop.

**(4) Separation of Crystals by Centriguagation, and Drying.** The massecuite is then sent to centrifuges wherby sugar crystals are separated from the syrup. The crystals are here sprinkled with a little water to wash any syrup sticking to the surface. The wet sugar is dried by passing down a rotating drum with stream of hot air flowing counter-current to it. The residual mother liquor, from which the crystals have been removed, is called molasses. In India, it is valuble raw material for alcohol manufacture by fermentation.

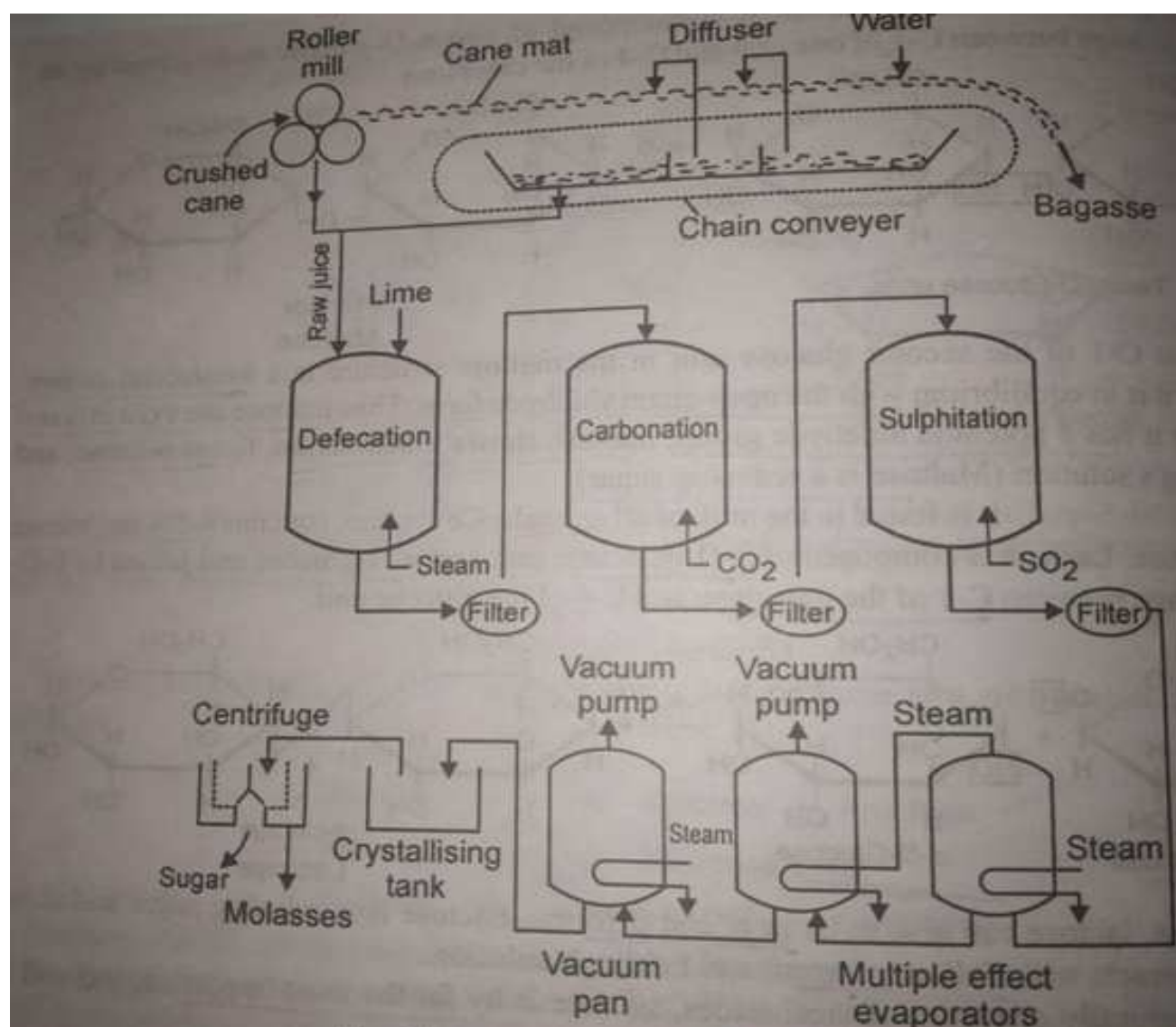


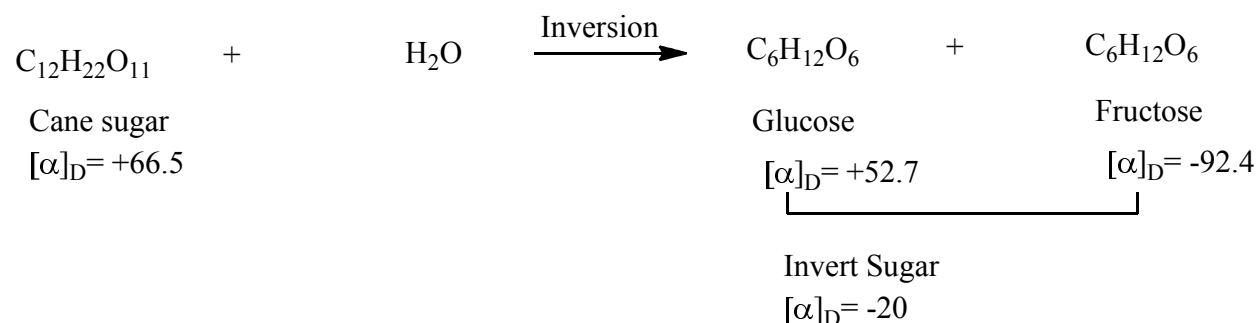
Fig 8.1. sugar manufacture (Flow sheet)

**Properties of Cane Sugar, C<sub>12</sub>H<sub>22</sub>O<sub>11</sub>:**

1. It is colourless, crystalline substance, sweet in taste. It is very soluble in water and the solution is dextrorotatory  $[\alpha]_D = +66.5$ .
2. Effect of heat. Sucrose on heating slowly and carefully melts and then if allowed to cool, it solidifies to pale-yellow glassy mass called 'barley sugar'.

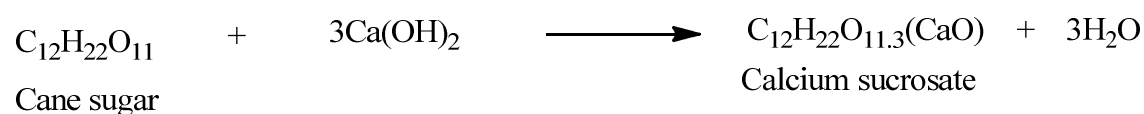
When heated to 473K, it loses water to form a brown amorphous mass called caramel. On strong heating it chars to almost pure carbon giving characteristic smell of burnt sugar.

3. Hydrolysis or Inversion of Sucrose (Sugar). Sucrose when boiled with mineral acids, or by the enzyme invertase, yields an equimolar mixture of glucose and fructose.



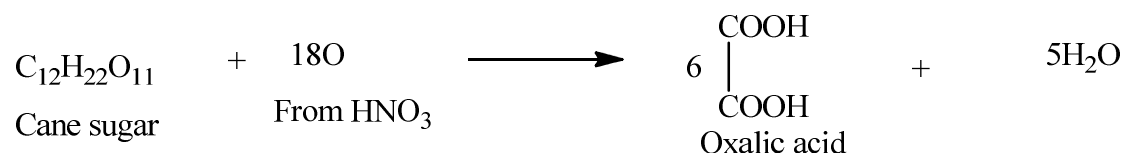
Sucrose is dextrorotatory and on hydrolysis produces dextrorotatory glucose and laevorotatory fructose. With greater laevorotation of fructose the mixture is laevorotatory. Thus, there is a change (inversion) in the direction of rotation of the reaction mixture from dextro to laevo. This phenomenon is called inversion and the enzyme which brings about this inversion is called invertase.

4. **Formation of Sucrosates:** Sucrose solution reacts with calcium, barium and strontium hydroxides to form sucrosates.

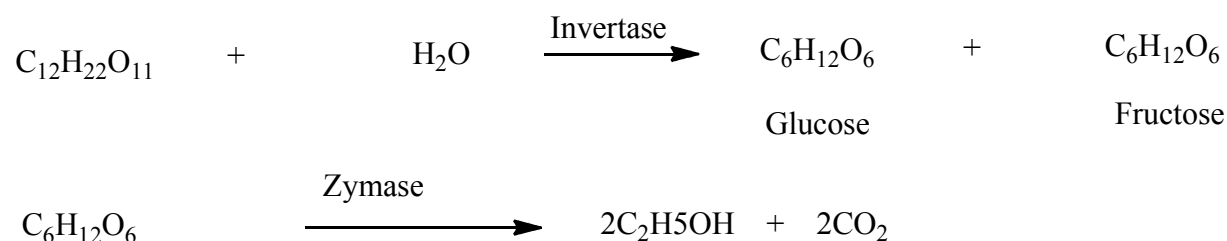


The sucrosate decomposes when carbon dioxide is passed in the solution.

5. **Action of nitric acid:** Concentrated nitric acid oxidizes cane sugar to oxalic acid.



6. **Fermentation:** Fermentation of Sucrose is brought about by yeast when the enzymes invertase hydrolysed sucrose to glucose and fructose and zymase converts them to ethyl alcohol.




---

### ***8.10. GENERAL INTRODUCTION OF STRUCTURE OF RIBOSE AND DEOXYRIBOSE***

---

Ribose and deoxyribose are two well known aldopentoses. Their structures are discussed as under.

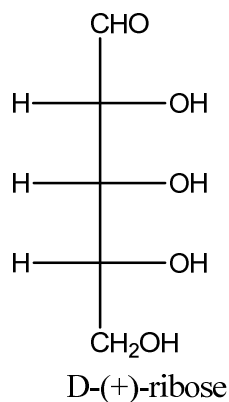
#### **Structure of D-(+)- Ribose:**

D-(+)- Ribose occurs naturally in plant nucleic acids and in liver and pancreas nucleic acids. It gives properties similar to glucose.

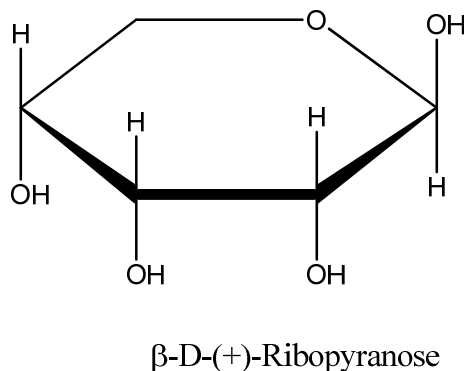
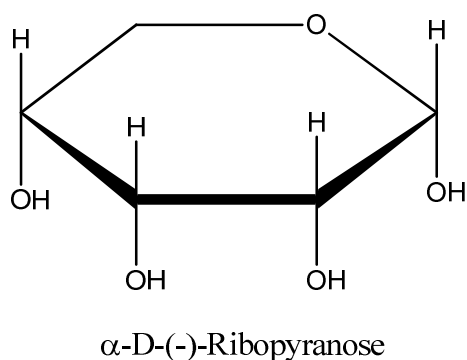
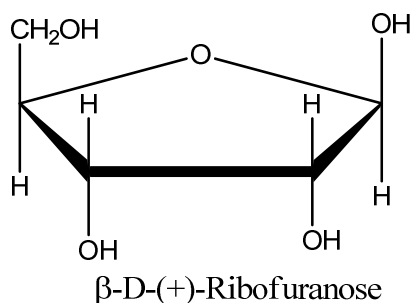
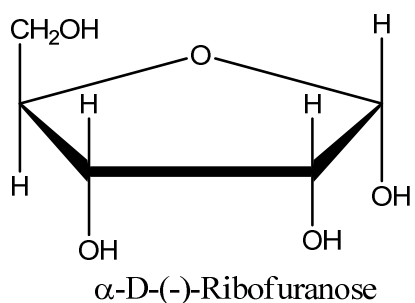
Ribose has the molecular formula (C<sub>5</sub>H<sub>10</sub>O<sub>5</sub>) and shows the presence of an aldehyde group, four hydroxyl groups (one primary and three secondary) and a straight chain of carbon atoms. Therefore, it was assigned an open chain formula as given below:



The configuration of D-ribose has been established as follows.



As in the case of glucose, D-ribose is now assigned a ring structure and is known to exist both in furanose and pyranose forms as depicted below:

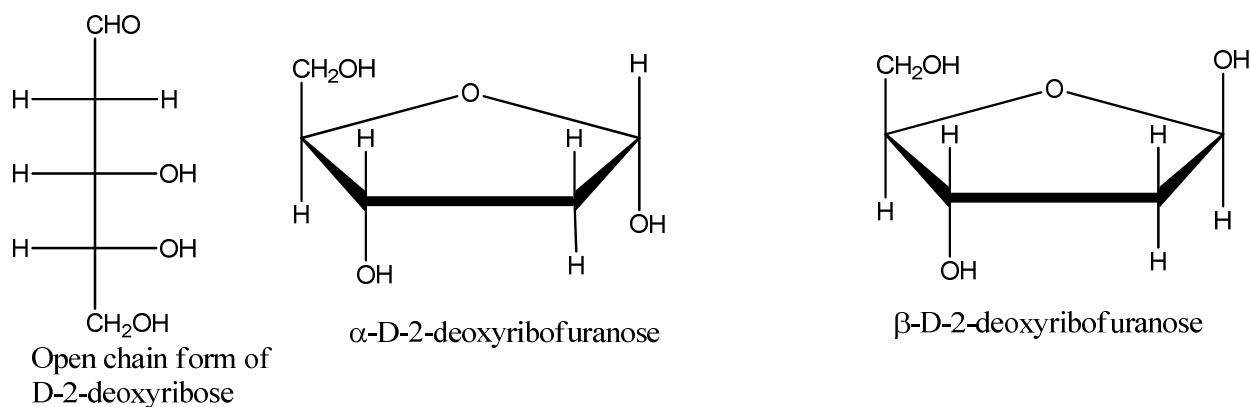


Pyranose form is more stable than the furanose form. Equilibrium mixture of ribose contains 56%  $\beta$ -D-ribose, 20%  $\alpha$ -D-ribose, 18%  $\beta$ -D-ribofuranose and 6%  $\alpha$ -D-ribofuranose. In RNA ribose is present in furanose form.

### Structure of deoxyribose:

In this aldopentose the hydroxyl group at C-2 of ribose has been replaced by hydrogen. That is why it is named as deoxyribose. It is fundamental constituent of deoxyribonucleic acid (DNA).

The structure of D-2-deoxyribose is derived from that of D-ribose and may be represented in the open chain and ring forms as follows.




---

## 8.11 GENERAL STUDY OF POLYSACCHARIDES

---

These are neutral polymeric compounds in which hundreds or even thousands of monosaccharide units are joined by glycosidic linkages. They have the general formula  $(C_5H_{10}O_5)_n$ , where n has very large value. They are colourless, tasteless and are insoluble in water. They play very important role in plant and animal life as food storage and structural role. They are usually made up of pentoses or hexoses. The important polysaccharides are cellulose, starch, glycogen and dextrans.

### Starch:

Starch is most widely distributed in vegetable kingdom. In nature, it is transformed into complex polysaccharides like gum and cellulose and into simpler mono and disaccharides by enzymes working in vegetable kingdom. Its rich sources are potatoes, wheat, maize, rice, barley and arrow root. It is interesting to note that no two sources give identical starch.

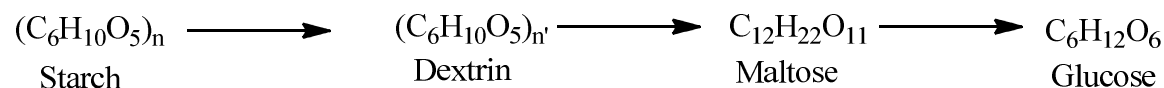
### Physical properties:

It is a white, amorphous substance with no taste or smell. It is insoluble in water but when starch is added to boiling water the granules swell and burst forming colloidal, translucent suspension.

**Chemical properties of starch:**

(i) When heated to a temperature between 200-250<sup>0</sup> it changes into dextrin. At higher temperature charring takes place.

(ii) Starch, when boiled with dilute acids, yielded ultimately glucose



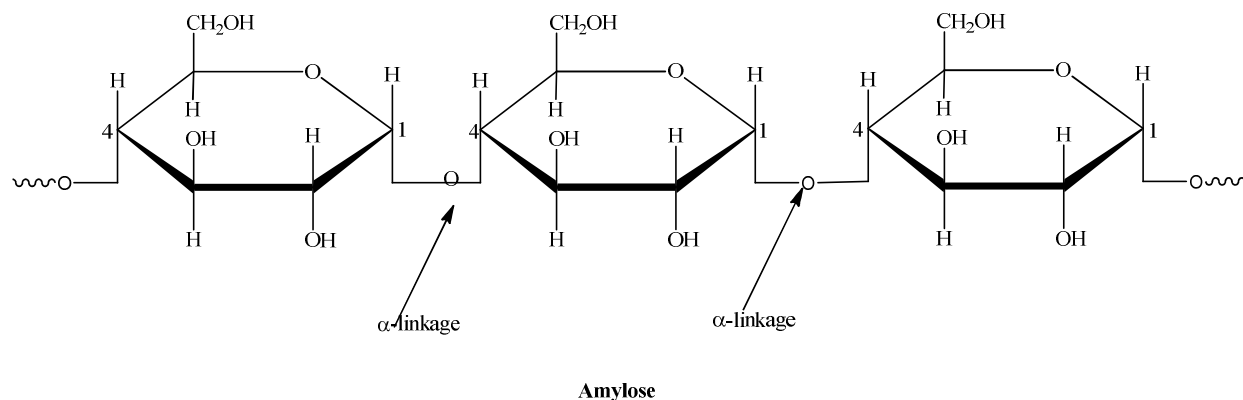
When hydrolysed with enzyme diastase, maltose is obtained.

(iii) Starch solution gives a blue colour with a drop of iodine solution. The blue colour disappears on heating and reappears on cooling. In fact it is the amylose that gives colour with iodine; the amylopectin gives a red brown colour with iodine.

Starch is a non reducing saccharide. It does not reduce Fehling's solution or Tollen's reagent. It also does not form an osazone indicating that all hemiacetal hydroxyl groups of glucose units (C<sub>1</sub>) are not free but are linked with glycosidic linkages.

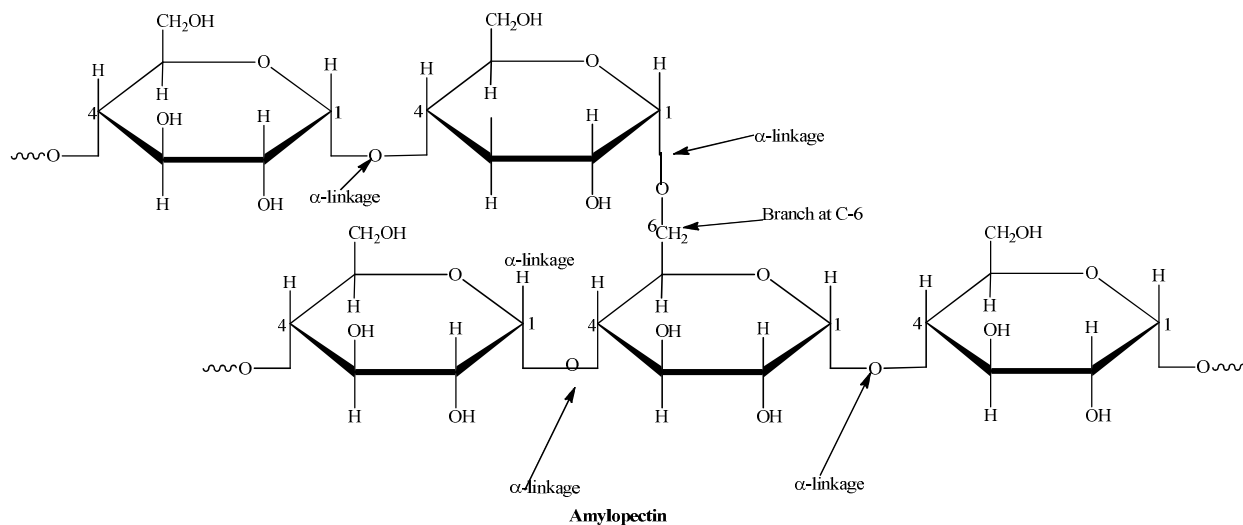
Starch is polymer of α-D-glucose and consists of two components (15-20%) amylose and 80-85%) amylopectin.

**(i) Amylose.** It is white soluble fraction. It is linear polymer of α-D-glucose. It contains about 200-1000 α-D-glucose units which are linked to one another through α-glycosidic linkage involving C-1 of one glucose and C-4 of the next as shown below.



Its molecular mass can range from 10, 0000 to 500,000.

**(ii) Amylopectin.** It is water insoluble fraction. It is a highly branched chain polymer which does not give blue colour with iodine. It consists of a large number of short chains of 25-30 D-glucose units. In this case the main chain involves  $\alpha$ -linkages between C-1 of one  $\alpha$ -D-glucose unit and C-4 of the other. The C-1 of terminal glucose in each chain is further linked to C-6 of the other glucose unit in the next chain through C-1-C-6  $\alpha$ -linkage. This gives highly branched structure.

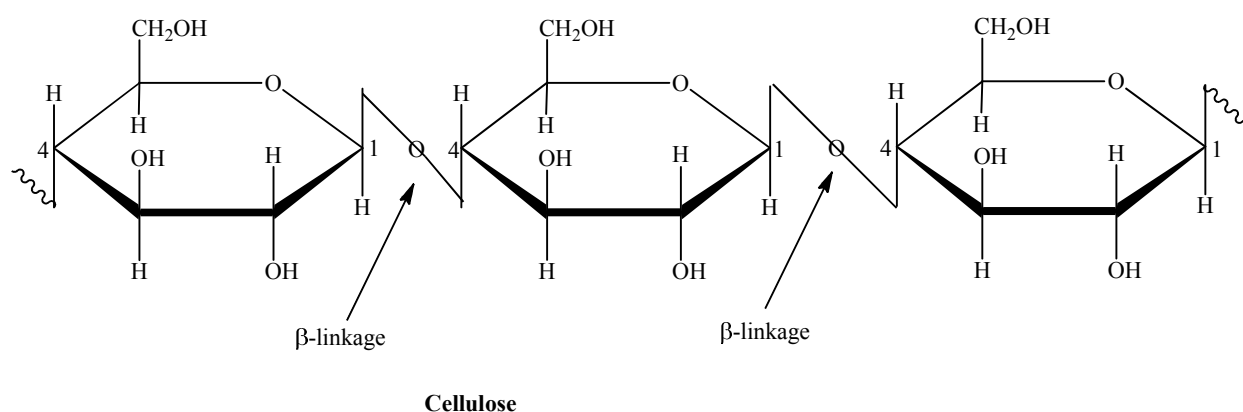


Starch is used as the principal food storage of glucose energy. It is hydrolysed by enzyme amylase present in saliva. The end product of glucose which is an essential nutrient.

### Cellulose

Cellulose is the main structural material of trees and other plants. Wood is 50% cellulose, while cotton wool is almost pure cellulose. Other sources of cellulose are straw, corncobs, bagasse, and similar agriculture wastes.

**Manufacture:** Cotton wool is about 97% cellulose. It is ready for use after washing away the waxes and fats associated with it. The cellulose required for making paper is obtained from wood. Lignin and resinous substances present along with cellulose are removed by digesting the wood chips under pressure with a solution calcium hydrogen sulphite. The cellulose separates as insoluble fibres which are washed with water, bleached and dried.



**Structure.** Cellulose is a straight chain polysaccharide composed of D-glucose units. These units are joined by  $\beta$ -glycosidic linkages between C-1 of one glucose unit and C-4 of the next glucose unit. The number of D-glucose units in cellulose ranges from 300-2500.

**Properties:** Cellulose is a colourless amorphous solid having no m.p. it decomposes on strong heating. It is insoluble in water and most organic solvents. However, it dissolves in S. reagent which is an ammoniacal solution of cupric hydroxide.

**Hydrolysis:** Cellulose when hydrolysed by heating with dilute acids, gives D-glucose. Cellobiose is formed in case of incomplete hydrolysis.

The cattle, goats, and other ruminants have digestive enzymes (Cellulases) capable of hydrolyzing cellulose into glucose. Consequently, these can feed directly on cellulose. Man and many other mammals lack the necessary enzymes in their digestive tract, and they cannot use cellulose as foodstuff.



---

### 8.12. SUMMARY

---

- Glyceraldehydes are the simplest carbohydrate and it serves as a reference molecule to write the configuration (D and L) of all other monosaccharides.
- The pair of enantiomers with similar groups on the same side of the carbon chain is called the erythro enantiomers while pair of enantiomers with similar groups on opposite sides is called the threo enantiomers.
- Mutarotation is defined as the interconversion of  $\alpha$  and  $\beta$  anomeric forms with the change in the optical rotation.
- Disaccharides are the carbohydrates which on hydrolysis give two same or different monosaccharides.
- Disaccharides are composed of two units of monosaccharides joined by glycosidic linkage.
- Polysaccharides are neutral polymeric compounds in which hundreds or even thousands of monosaccharide units are joined by glycosidic linkages.

---

### 8.13. MODEL EXAMINATION QUESTIONS

---

1. How will you convert glucose into fructose?
2. Discuss the mechanism of mutarotation.
3. How is sucrose manufactured from sugar cane.
4. Discuss the structure of sucrose, lactose and maltose.
5. Write a short note on polysaccharides

---

### REFERENCES

---

1. A text book of organic chemistry, A. Bahl and B.S.Bahl, S.Chand & Compant Ltd.
2. Chemistry for degree students, R.L.madan, S.Chand & Compant Ltd.
3. Organic chemistry, Vol.III, Jagdamba singh and L.D.S Yadav, Prgati Prakashan.
4. Modern chemistry, S.P.Jauhar, Modern Publishers.
5. Organic chemistry, Francis A.Carey, Tata McGraw-Hill Company Ltd.

---

## UNIT-9 LIPIDS

---

### CONTENTS

- 9.1 Objectives
- 9.2 Introduction
- 9.3 Classification
- 9.4 Types of Lipids
- 9.5 Important Structural features
- 9.6 Summary
- 9.7 Terminal Question
- 9.8 Answers

---

### ***9.1 OBJECTIVES***

---

After completion of this unit, the student should be able to:

- Idea about lipids
- Classification of lipids
- Types of Fatty acids
- Structural feature of lipids

---

### ***9.2 INTRODUCTION***

---

**Lipids** are also biochemical compounds that contain carbon, hydrogen, and oxygen. But lipids, unlike carbohydrates, share no common structural features.

Lipids are a category of natural organic substances, heterogeneous as structure and physico-chemical properties, with a universal spread in all living organisms; they have a high biological significance. Lipids are biomolecules that are *insoluble in water* but *soluble in organic solvents*.

A general characteristic of these substances and mean time an essential difference of carbohydrates and proteins, is their solubility in organic solvents (chloroform, tetrachlorocarbon, acetone, benzene, ethyl-ether, etc) an insolubility in water and mineral salt solutions. Due to the

length of the hydrocarbon chain, which does not permit the formation of hydrogen bonds, fatty acids have a marked tendency to associate each other or with other hydrophobic structures as sterols or hydrophobic chains of amino acids. It was calculated that the van der Waals forces between the fatty acid molecules with a long chain, and which are compacted in lipids, can be as strong as a covalent bond. Lipids hydrophobicity makes them essential for the realization of cellular structures and for the compartmentalization of certain sectors in which distinct metabolic pathways take place.

In living organisms, lipids fulfill energetic, functional and structural roles.

Neutral fats (acylglycerols) have a high energetic value; they liberate, by oxidation, approx. 9 kcal/gram, comparing with the energy liberated by the oxidation of the same quantity of glycogen or starch, which is around 4 kcal/gram. The energetic role can be direct, fatty acids in lipid composition representing energetic substrates for most tissues, and indirect, energetic deposit role (the case of simple lipids in adipose tissue).

Also, triacylglycerols represent the most efficient form of energy deposit. Comparing, glycogen, which is the storage form of carbohydrates, has a storage capacity of almost two and a half lower at the same mass. The total quantity of glycogen in the organism ensures the energy for only few hours. In plus, due to the hydrophilic character, glycogen binds water in ratio of 1:2. Triacylglycerols, due to the hydrophobic character, do not bind water and are deposited in a compact form in the adipose tissue; the adipose tissue of a person of 70 kg ensures the energy needed to survive for several weeks.

The functional role can be mechanic (organs are sustained) or interfering as a buffer layer to mechanic challenges, It has also an thermo insulating role, shrinking the body from cold, and maintaining the hydric insulation (skin, hair).

Certain phospholipids easy and permit the transport of electrons along the nervous trunk, participating to the transmission of nervous impulse. In the biological liquids, lipids can function as transporting system for nonpolar liposoluble substances (certain vitamins, hormones).

Complex lipids (sometime together with proteins, in lipoproteic complexes) have structural role also being found in the structures of cellular and subcellular components. In association with proteins they form the basic structural unit of cell and subcell particle membranes, having role in regulation of permeability and transport through biomembranes; they

are implied directly in the organization and the maintaining of intracellular compartmentalization, needed for biochemical processes and their regulation.

Other lipids, although present in relatively small quantities, play crucial roles as enzyme cofactors, electron carriers, light-absorbing pigments, hydrophobic anchors for proteins, “chaperones” to help membrane proteins fold, emulsifying agents in the digestive tract, hormones, and intracellular messengers. This chapter introduces representative lipids of each type, with emphasis on their chemical structure and physical properties.

Generally, lipids contain long chain carboxylic acids, or **fatty acids**, esterified to a “backbone” molecule, which is either glycerol, or fatty alcohol or sphingosine.

---

### 9.3 CLASSIFICATION

---

Chemical heterogeneity imposes a classification more or less arbitrary. It has to be mentioned that most of the lipids are esters. Structurally speaking, there are three big lipid categories: simple, complex and derivatives.

Simple lipids are composed only of carbon, hydrogen and oxygen; function of the alcohol nature, they are subdivided in fats and oils (triacylglycerols) and waxes. These are esters of fatty acids with alcohols. According to the alcohol they are subclassified into:

1. **Neutral fats:** These are esters of fatty acids with glycerol. They are also called triglycerides & triacylglycerols.

2. **Waxes:** These are esters of fatty acids with monohydric alcohols higher than glycerol.

**Complex lipids** are at least quaternary, containing also phosphorous or/and nitrogen or both, in some cases containing sulfur. This category contains glycerophospholipids and sphingolipids. These are esters of fatty acids with alcohols & contain other groups. According to these groups they are subclassified into:

1. **Phospholipids:** These contain, in addition to fatty acids and alcohols, a phosphate radical.

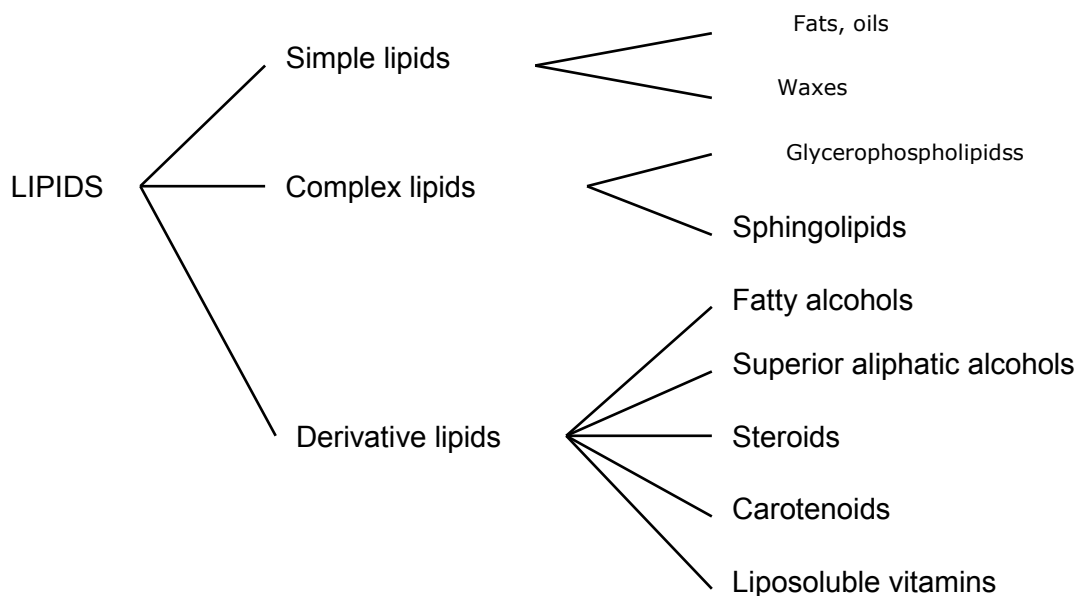
2. **Glycolipids:** These contain, in addition to fatty acids and alcohols, a carbohydrate radical.

3. **Proteolipids:** These contain, in addition to fatty acids and alcohols, a protein radical.

**Derivative lipids** include compounds resulting during simple or complex lipids hydrolysis and which manifest the same type of solubility as lipids. These include substances obtained by the

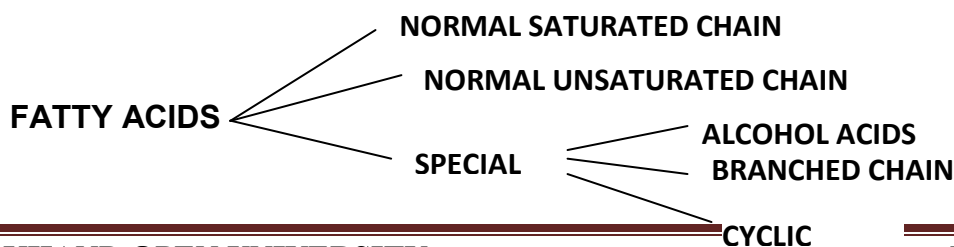
hydrolysis of the above groups. They also include substances associated with them in nature and related to them in properties and metabolism.

That category includes fatty acids, superior aliphatic alcohols, sterols, carotenoids and liposoluble vitamins.



### Fatty acids

Fatty acids are carboxylic acids with hydrocarbon chains ranging from 4 to 36 carbons long ( $C_4$  to  $C_{36}$ ). In some fatty acids, this chain is unbranched and fully saturated (contains no double bonds, Table 1); in others the chain contains one or more double bonds (Table 2). A few contain three-carbon rings, hydroxyl groups, or methyl group branches. A schematic classification can be:



For all saturated and unsaturated fatty acids, the counting of carbon atoms starts with the carboxyl carbon (number 1). In the degrading metabolic processes, some times another notation is used, with Greek letters – the first three carbon atoms following the carboxyl carbonate noted as  $C_{\alpha}$ ,  $C_{\beta}$ ,  $C_{\gamma}$  and the latest one as  $C_{\omega}$ .

### Saturated fatty acids

Saturated fatty acids, with linear chain, have the general formula  $\text{CH}_3(\text{CH}_2)_n\text{COOH}$ , where  $n = 2 - 30$ . They contain an alkyl hydrophobic chain (responsible for solubility in organic solvents as chloroform) and an acidic hydrophilic function that dissociates in alkaline medium.

The most important saturated fatty acids (as frequency in mammals and humans) are: palmitic acid (16 C), stearic acid (18 C) and miristic acid (14 C). Table 1 presents fatty acids with their systematic and common name.

**Table 1. Common biological saturated fatty acids**

No. C atoms	Common name	Systematic name	Structure	Melting point
4	Butiric acid	n-Butanoic acid	$\text{CH}_3(\text{CH}_2)_2\text{COOH}$	- 8,0
6	Capronic acid	n-Hexanoic acid	$\text{CH}_3(\text{CH}_2)_4\text{COOH}$	- 1,5
8	Caprilic acid	n-Octanoic acid	$\text{CH}_3(\text{CH}_2)_6\text{COOH}$	+16,5
10	Caprinic acid	n-Decanoic acid	$\text{CH}_3(\text{CH}_2)_8\text{COOH}$	+31,0
12	Lauric acid	n-dodecanoic acid	$\text{CH}_3(\text{CH}_2)_{10}\text{COOH}$	+44,0
14	Myristic acid	n-tetradecanoic acid	$\text{CH}_3(\text{CH}_2)_{12}\text{COOH}$	+53,8
16	Palmitic acid	n-Hexadecanoic acid	$\text{CH}_3(\text{CH}_2)_{14}\text{COOH}$	+62,5
18	Stearic acid	n-Octadecanoic acid	$\text{CH}_3(\text{CH}_2)_{16}\text{COOH}$	+69,6
20	Arachidic acid	n-Eicosanoic acid	$\text{CH}_3(\text{CH}_2)_{18}\text{COOH}$	+71,6
22	Behenic acid	n-Docosanoic acid	$\text{CH}_3(\text{CH}_2)_{20}\text{COOH}$	+80,3
24	Lignoceric acid	n-Tetracosanoic acid	$\text{CH}_3(\text{CH}_2)_{22}\text{COOH}$	+84,5

Unbranched fatty acids, presented in Table 1, are solid at room temperature, except butyric, capronic and caprilic acids that are liquids.

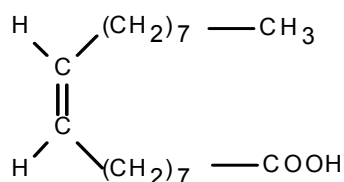
**Unsaturated fatty acids**

Unsaturated fatty acids can be monounsaturated (with a single double bond) or polyunsaturated (with several double bonds). They are characterized by the hydrocarbon chain length ( $C_n$ :  $n$ =number of carbon atoms in molecule) and the position of the double bonds, which is specified by the number of carbon atom the double bonds starts with ( $C_{n:m}$ ).

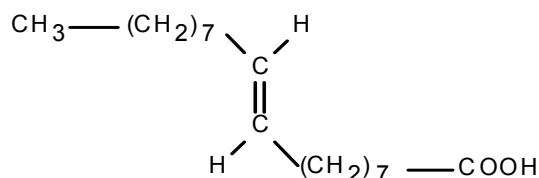
**Table 2. Common biological unsaturated fatty acids**

Symbol	Common name	Systematic name	Structure
16:9	Palmitoleic acid	Hexadecenoic acid	$CH_3(CH_2)_5CH=CH-(CH_2)_7COOH$
18:9	Oleic acid	9-Octadecenoic acid	$CH_3(CH_2)_7CH=CH-(CH_2)_7COOH$
24:15	Nervonic acid	15-tetracosenoic acid	
18:9,12	Linoleic acid	9,12-octadecadienoic acid	$CH_3(CH_2)_4(CH=CHCH_2)_2(CH_2)_6COOH$
18:9,12,15	Linolenic acid	9,12,15-Octadecatrienoic acid	$CH_3CH_2(CH=CHCH_2)_3(CH_2)_6COOH$
20:5,8,11,14	Arachidonic acid	5,8,11,14-Eicosatetraenoic acid	$CH_3(CH_2)_4(CH=CHCH_2)_4(CH_2)_2COOH$

In nearly all naturally occurring unsaturated fatty acids, the double bonds are in the cis configuration. Trans fatty acids are produced by fermentation in the rumen of dairy animals and are obtained from dairy products and meat. They are also produced during hydrogenation of fish or vegetable oils. Because diets high in trans fatty acids correlate with increased blood levels of LDL (bad cholesterol) and decreased HDL (good cholesterol), it is generally recommended that one avoid large amounts of these fatty acids. Unfortunately, French fries, doughnuts, and cookies tend to be high in trans fatty acids.



oleic acid (cis)

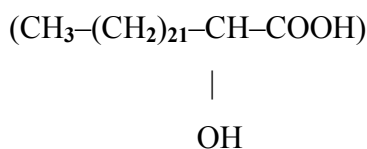


elaidic acid (trans)

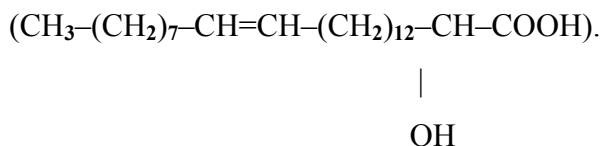
The C<sub>18</sub> polyunsaturated acids, linoleic acid (18:2) and *alpha*-linolenic acid (18:3) are major components of most plant lipids, including many of the commercially important vegetable oils. They are essential fatty acids in that they cannot be synthesized in animal tissues. On the other hand, as linoleic acid is almost always present in foods, it tends to be relatively abundant in animal tissues. In turn, these fatty acids are the biosynthetic precursors in animal systems of C<sub>20</sub> and C<sub>22</sub> polyunsaturated fatty acids, with three to six double bonds, via sequential desaturation and chain-elongation steps. Those fatty acids derived from linoleic acid, especially arachidonic acid, are important constituents of the membrane phospholipids in mammalian tissues, and are also the precursors of the prostaglandins and other eicosanoids. In fish, linolenic acid is the more important essential fatty acid, and polyunsaturated fatty acids of the (*n*-3) series are found in greater abundance.

### Hydroxylated fatty acids

This type of fatty acids is rare. They are saturated or unsaturated and contain a secondary hydroxyl group.. Example: cerebronic acid has 24 carbon atoms in the hydrocarbon chain:



Hydroxynervonic acid (24 carbon atoms) is unsaturated, having a double bond.



Both these acids are found in cerebrosides.

### Properties of fatty acids

The **physical properties** of fatty acids (and of compounds that contain them) are largely determined by the length and degree of unsaturation of the hydrocarbon chain. The nonpolar hydrocarbon chain accounts for the poor solubility of fatty acids in water. The longer the fatty acyl chain and the fewer the double bonds, the lower is the solubility in water. The carboxylic acid group is polar (and ionized at neutral pH) and accounts for the slight solubility of short-



chain fatty acids in water. Fatty acids with a short chain (less than 12 carbon atoms) are soluble in water – an important fact for the explanation of a different absorption of lipids.



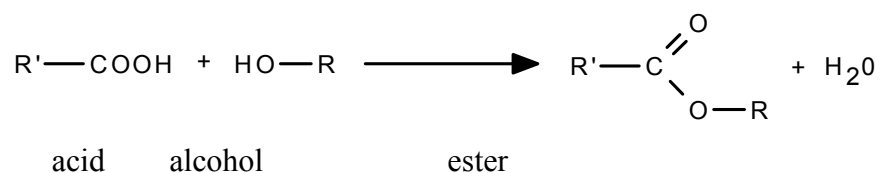
In vertebrates, free fatty acids (unesterified fatty acids, with a free carboxyl group) circulate in the blood bound noncovalently to a protein carrier, serum albumin. However, fatty acids are present in blood plasma mostly as carboxylic acid derivatives such as esters or amides. Lacking the charged carboxyl group, these fatty acid derivatives are generally even less soluble in water than are the free fatty acids.

Melting points are also strongly influenced by the length and degree of unsaturation of the hydrocarbon chain. At room temperature (25°C), the saturated fatty acids from 12 to 24 carbon atoms have a waxy consistency, whereas unsaturated fatty acids of these lengths are oily liquids.

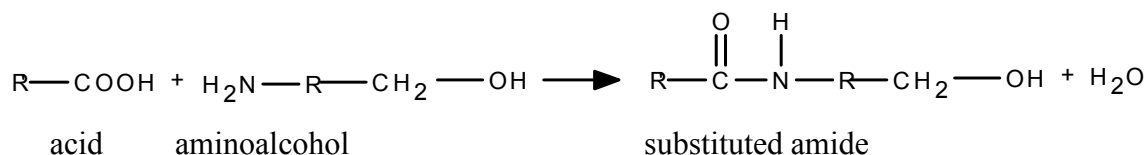
**Chemical Properties** are related to the carboxyl group and the hydrocarbon chain.

**Carboxyl group function:** Fatty acids react with bases forming salts or soaps (water soluble for alkaline metals and insoluble for second group metals and lead). Soaps decrease the superficial tension of solutions and behave as excellent emulsifying agents.

Fatty acids react with alcohols, forming esters (most majorities of lipids are formed in that manner):

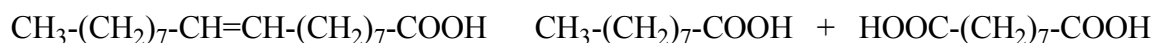


They form substituted amides with amines (see some of the complex lipids):

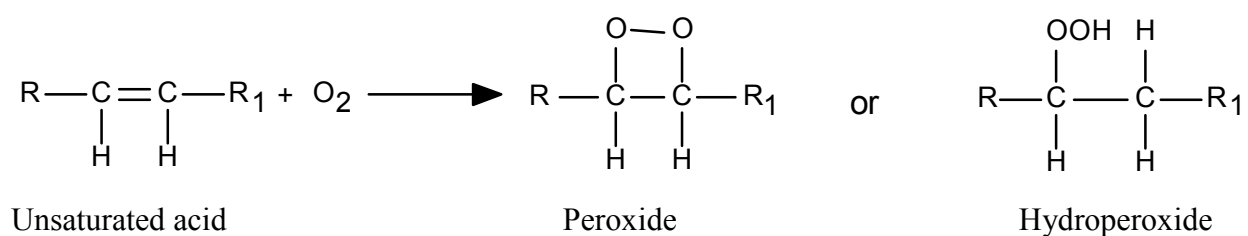


**Aliphatic chain reactions:** In vitro only the unsaturated chain is reactive. Saturated fatty acids suffer but very little oxidation, only the unsaturated acids can be oxidized. In vivo, fatty acid oxidation is specific ( $\beta$ -oxidation pathway).

In vitro, gentle oxidation of unsaturated acids forms hydroxyacids and a strong oxidation will break the double bond, forming two acids:

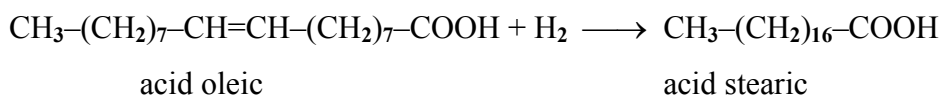


In the presence of oxygen and light, free unsaturated acids or the one found in lipids are oxidized at the level of the double bond, forming peroxides or hydroperoxides, unstable compounds:



These substances are unstable and decompose, forming alcohols, aldehydes, hydroxyacids, and volatile acids, having unpleasant taste and smell. Condensing products can be also formed, which have a toxic effect on the organism. The phenomenon is called rancidity and is produced by physical, photochemical factors or microorganisms. The phenomenon does not take place in the oxygen absence. Rancidity can be prevented or blocked by the presence of corresponding quantities of natural antioxidant substances (vitamin E) or synthetic.

Fatty unsaturated acids can suffer hydrogen addition, forming saturated fatty acids:



Hydrogenation needs, in vitro, a catalyst: Ni, Pt or Pd.

### Alcohols in lipid constitution

The following types of alcohol are found in lipid structure:

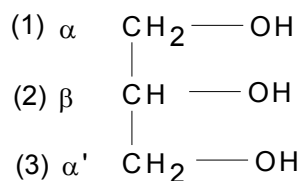
- aliphatic alcohols without nitrogen,
- amino alcohols,
- cyclic alcohols.

An important number of lipids (those that can suffer saponification) are formed with the participation of a molecule containing the alcohol function. Neutral fats are esters of fatty acids

with glycerol; cerides are esters of fatty acids with fatty alcohols. Cholamine, an amino alcohol, appears esterified in cephalins, choline in lecithins, and sphingosine in sphingolipids.

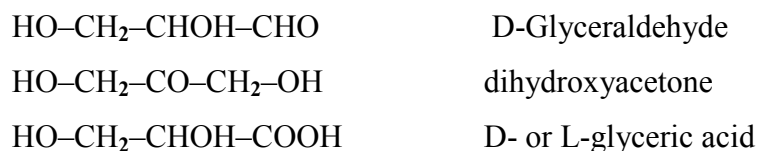
### Aliphatic alcohols without nitrogen

Glycerol (propantriol), is the main alcohol in lipid structure. It is a colorless, viscous, lightly sweet liquid, easily soluble in water and non-soluble in organic solvents like benzene and chloroform. It contains two primary and one secondary alcohol functions:



Glycerol can form mono-, di- and triesters. Monoesters can be isomers  $\alpha$  or  $\beta$  (1 or, respectively 2).

Glycerol oxidation can give different biologically interesting derivatives:



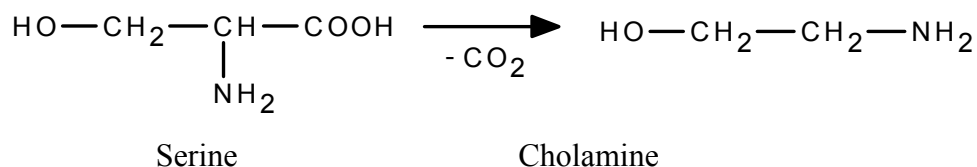
In organism, glycerol appears as esters and not free. Phosphoric esters of glyceraldehydes and glyceric acid are important metabolites that appear in glucose catabolism and represents important connections between carbohydrates and lipids metabolism.

Fatty alcohols, usually found in waxes, are long chain monoalcohols (C<sub>16</sub>-C<sub>32</sub>) straight chain, with an even carbon atom number.

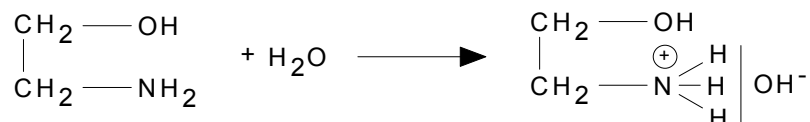
### Aminoalcohols:

Cholamine, choline, and serine are the most important substances found in glycerophospholipids. Sphingosine, a fatty, unsaturated amino-alcohol is found in ceramides and sphingolipids. They are not esterified to fatty acids but with phosphoric acid.

Cholamine (2-aminoethanol or monoethanolamine) is the amine corresponding to ethanol: HO—CH<sub>2</sub>—CH<sub>2</sub>—NH<sub>2</sub>. Its biological precursor is serine, which is decarboxylated:

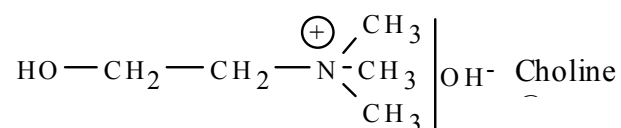


Cholamine properties are due to the groups  $-\text{NH}_2$  and  $-\text{OH}$ . In solution, cholamine can fix a water molecule, forming a quaternary ammonium combination:

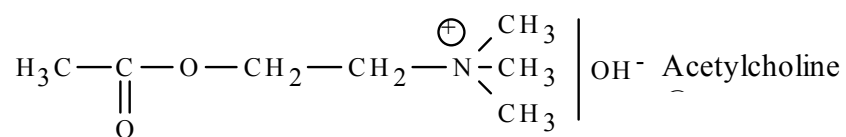


It has a basic character in water solution. Free cholamine is found in small quantities in cells and tissues. It appears in combinations like phosphatidylcholamine (cephalins).

Choline is a cholamine derivative, formed in a trimethylation reaction to the nitrogen atom:



It has a strong basic character. Choline is found in organism both free and in combinations (lecithin). Acetylcholine, its acetic ester, acts as a chemical mediator in the nervous influx transmitter process (ex. neuromuscular junction):

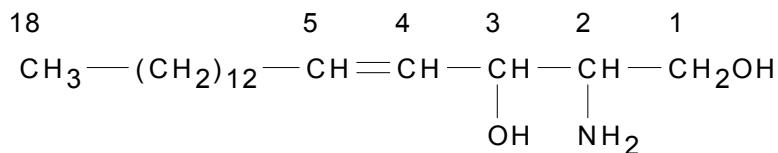


Choline main biological role is as constituent of glycerophospholipids, having a lipotrope function.

Serine (2-amino-3-hydroxypropionic acid or  $\alpha$ -amino- $\beta$ -hydroxy-propionic) It is a hydroxyl-amino acid and replaces cholamine in phosphatidylserine.

Sphingosine is a complex amino alcohol (18 carbon atoms and a double bond). It has two hydroxyl groups ( $\text{C}_1$  and  $\text{C}_3$ ) and an amino group ( $\text{C}_2$ ). It is insoluble in water but soluble in

alcohol, acetone and ether. Dihydrosphingosine is obtained by hydrogenation of sphingosine's double bond. Both are found in cerebral and medullar tissues.



## 9.4 TYPES OF LIPIDS

### Simple lipids

Simple lipids classification follows the nature of alcohol in lipid composition, and they can be:

- Acylglycerols: esters of glycerol with fatty acids;
- Cerides: esters of superior (fatty) monoalcohols with fatty acids.

### Lipids, Derivatives of Glycerol

According to the alcohol they contain, simple lipids can be:

- Acylglycerols: Glycerol esters with fatty acids;
- Waxes: fatty monoalcohol esters with fatty acids.

### Acylglycerols (triglycerides)

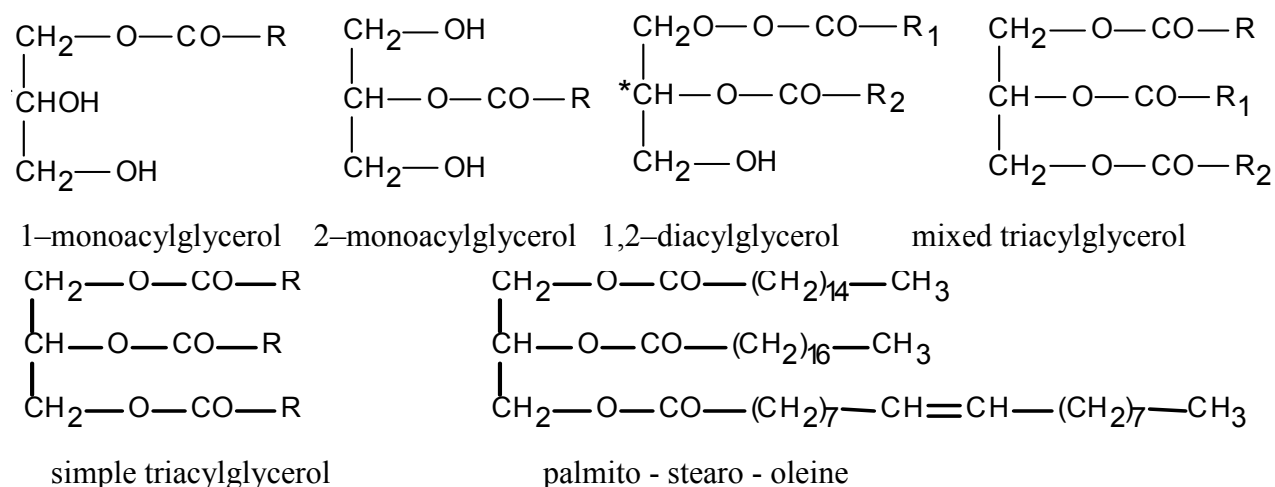
Acylglycerols are esters of fatty acids with glycerol. They are still called glycerides or neutral lipids, although this name is chemically improper.

Triacylglycerols are the most spread simple lipids, being found in the composition of all cells, animal or vegetal. They have an important biochemical and physiological role and they represent the deposit form of lipids in both animals and plants.

## 9.5 IMPORTANT STRUCTURAL FEATURE AND ISOMERISM

In naturally occurring fats, the proportion of triacylglycerol molecules containing the same fatty acid residues in all three ester positions is very small. They are nearly all mixed acylglycerols. Partial acylglycerols consisting of mono- and diacylglycerols wherein a single

fatty acid or two fatty acids are esterified to glycerol are also found in the tissues. They can present different isomers:  $\alpha$ - or  $\beta$ -monoacylglycerols and 1,2 or 1,3-diacylglycerols.



(\*C - asymmetric carbon, R—CO—, fatty acid radical).

### Acylglycerol physical properties

They are soluble in organic solvents and not soluble in water. They are light-less dense than water. They present no osmotic problems to the cell, even when stored in large amount, due to their water insolubility.

Their melting points depend on their molecular weight and the degree of unsaturation. A triacylglycerol containing all saturated fatty acids of 12 carbon atoms or more is solid at body temperature, whereas if all 3 fatty acids are 18C and double unsaturated, it is liquid below 0<sup>0</sup>C. In practice, natural acylglycerols contain a mixture of fatty acids tailored to suit their functional roles. The membrane lipids, which must be fluid at all environmental temperatures are more unsaturated than storage lipids. Lipids in tissues that are subject to cooling, e.g. in hibernators or in the extremities of animals, are more unsaturated.

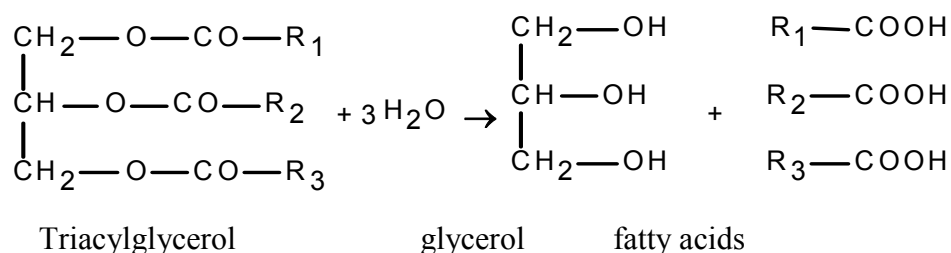
According to their melting points, acylglycerols can be classified as:

- fats and butters – animal triacylglycerols, solid or semisolid, with melting points between +20 and +30°C;
- tallows – solid animal triacylglycerols, with the melting points more than 35°C;
- Oils – vegetal triacylglycerols (except fish oils) which are liquids at room temperature.

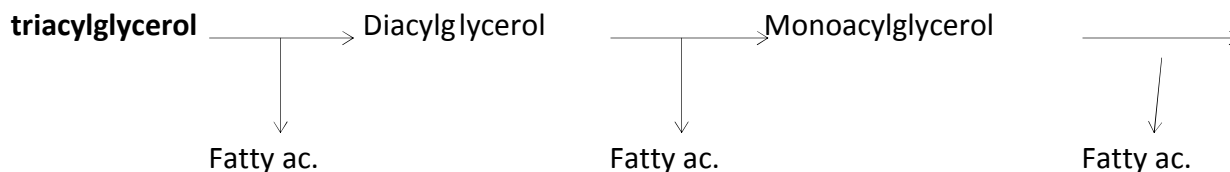
Being mixtures of triacylglycerols, natural fats have no a fix melting point, but a melting interval.

### Chemical properties

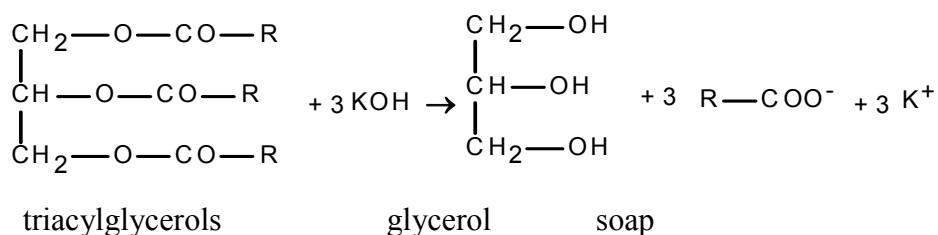
Chemical (acids or bases) or enzymatic (lipases) hydrolysis releases the components of triacylglycerols: fatty acids and glycerol.



The hydrolysis process, specially the enzymatic one, takes place in steps:



Basic hydrolysis (saponification) will form glycerol and soaps (salts):



Hydrogen addition to the double bonds (saturation of fats) transforms the liquid fats (oils) into solid fats (margarine). Double bonds in fats can react with iodine. Iodine index (iodine grams used per 100 grams of fat) gives an indication of the unsaturation degree.

In the presence of air oxygen, radiation or microorganisms, triacylglycerols suffer a rancidity process (see the discussion at unsaturated fatty acids).

### Triacylglycerols roles

Especially animal triacylglycerols have the main functions:

- Main deposits of energy for the organism;
- They are thermal and mechanic insulators, having a protection role for different organs.
- Combined with proteins as lipoproteic complexes, triacylglycerols helps in fat transporting in organism.

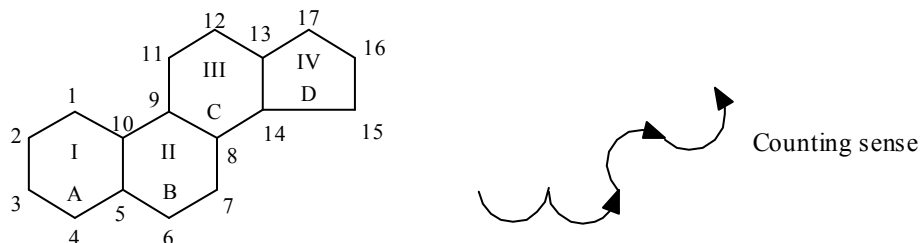
### Waxes:

**Waxes** are esters of fatty acids with fatty monohydroxyalcohols (16 to 32 carbon atoms). They are mostly found in vegetal structures, but also in animals (red blood cell membrane, etc.)

### Steroidal compounds

Steroids form a class of natural substances with solubility characters of lipids. Steroidal compounds with hydroxyl functions are found also as esters with fatty acids (sterides). There are several steroids in the biological system. These include cholesterol, bile acids, vitamin D, sex hormones, adrenocortical hormones, sitosterols, cardiac glycosides and alkaloids.

Steroids are the compounds containing a cyclic steroid nucleus (or ring) namely cyclopentanoperhydrophenanthrene. It consists of a phenanthrene nucleus (rings A, B, and C) to which a cyclopentane ring (D) is attached. The structure and numbering is the following:

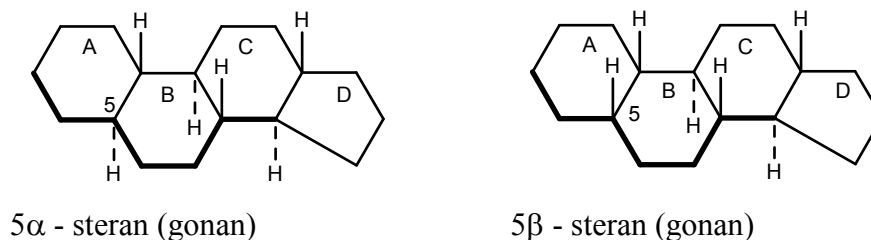


The compound can exist as 64 stereoisomers, according to the orientation of hydrogen atoms, fixed to carbon atoms at cycle junctions (C<sub>5</sub>, C<sub>10</sub>, C<sub>8</sub>, C<sub>9</sub>, C<sub>13</sub> și C<sub>14</sub>).

The carbons atoms are not coplanar (Hexagon cycles have chair conformation). Even so, an anterior face can be defined (the nucleus imagined perpendicularly on the sheet plan) and a posterior one of the tetracycle nucleus. The bonds directed to the anterior site (superior to cycle) are drawn as plain lines (—) and called  $\beta$ . Substituents found on the opposite site (posterior) are bound to nucleus by  $\alpha$  bonds, and drawn as pointed lines (....). Carbon atoms at the cycles junctions bear a single substituent, with the two orientations ( $\alpha$  or  $\beta$ ), which creates the possibility of 64 stereoisomers.



But, in nature, there are found only derivatives of two of these, respectively stereoisomers differentiated by the binding mode of hydrogen atom to  $C_5$ . These two fundamental compounds are called gonan  $5\alpha$  and  $5\beta$ . The configurations of the rest 5 centers of isomerism ( $C_8$ ,  $C_9$ ,  $C_{10}$ ,  $C_{13}$ ,  $C_{14}$ ) are the same to all natural steroids.



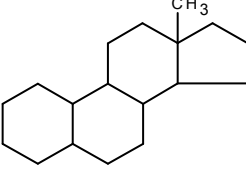
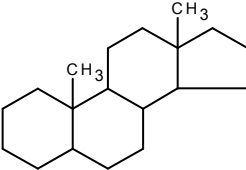
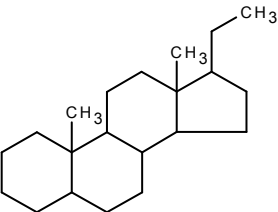
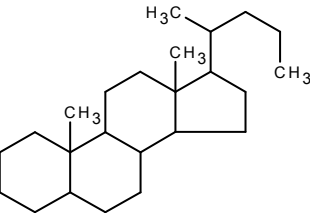
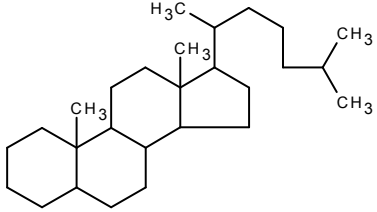
In all natural steroids, the bonds between the rings B, C, and D are trans, and the bonds between the rings A and B are trans in  $\alpha$  forms and cis in  $\beta$  ones.

Substitution of a hydrogen atom in gonan  $-CH_2-$  groups with a functional group or a certain radical, gives the possibility that the substituted group to be bound  $\alpha$  or  $\beta$ . It is necessary in these cases to indicate the orientation of the substituent towards the general plan of molecule.

The steroid nucleus represents saturated carbons, unless specifically shown as double bonds. The methyl side chains (19 and 18) attached to carbons 10 and 13 are shown as single bonds. At carbon 17, steroids usually contain a side chain.

Steroids with the same type of biological action have related structures and same number of carbon atoms. By the substitution of hydrogen atom in position  $C_{10}$ ,  $C_{13}$  and  $C_{17}$  with different saturated hydrocarbon radicals, a series of saturated cyclic hydrocarbons are formed, considered “fundamental”. Natural steroidal compounds derive from these structures. There are 5 groups of steroids, with distinct biological actions, which correspond to commune basic structures, and can be considered as derivatives of a certain fundamental hydrocarbon.

Different types of steroidal basic structures are shown in the following table:

No. of carbon atoms	Basic hydrocarbon	Derived natural compounds
C <sub>18</sub>	 estrane	estrogen hormones
C <sub>19</sub>	 androstane	androgen hormones
C <sub>21</sub>	 pregnane	corticosteroids and gestagens hormones
C <sub>24</sub>	 colan	Bile acids
C <sub>27</sub>	 colestane	Cholesterol and other animal sterols

If a steroid contains one or more hydroxyl groups it is commonly known as **sterol** (means solid alcohol).

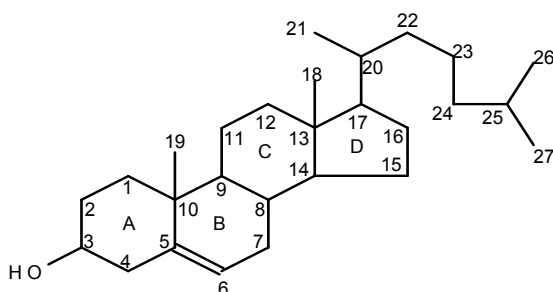
### Cholesterol

The main animal sterol is cholesterol. It is largely distributed in the free form or esterified, in all cell. Structurally is  $\Delta^5$ -3-hydroxycostan and is present in higher quantities in nervous system, bile (6 g/l) and egg yolk.

It presents the following structural characteristics:

- It derives from the polycyclic nucleus steran, containing three hexaatomic cycles (A, B, C) and a pentaatomic cycle (D);
- It contains 27 carbon atoms and the brute formula is  $C_{27}H_{45}-OH$ ;
- It is a cyclic alcohol, the hydroxyl group is bound to carbon number 3 in cycle A, position  $\beta$ ;
- It is unsaturated, having a double bond in cycle B, position  $C_5 - C_6$ ;
- It has 2 methyl radicals ( $-CH_3$ ), called “angular methyl” in position  $C_{13}$  and  $C_{10}$ , with  $\beta$  orientation ( $C_{18}$ ;  $C_{19}$ );
- In position  $C_{17}$  has a side chain with 8 carbon atoms ( $C_{20} - C_{27}$ ).

The presence of cholesterol in organism has exogenous or endogenous origin. Cholesterol synthesis in organism is very active especially at liver level, then in suprarenal glands, and in more reduced proportions in all tissues. The synthesis steps are very well defined.



**Cholesterol**

In organism cholesterol is found in free form, and esterified to superior fatty acids, saturated or unsaturated; this fraction is called esterified cholesterol.

In blood serum its concentration is 150-250 mg/100 ml, one third free and two thirds esterified (in higher concentration in the  $\beta$ -lipoproteic fraction).

Cholesterol is a solid, crystalline, white substance, insoluble in water (even the  $-OH$  group is polar, the rest, tetracyclic nucleus and the side chain are nonpolar), and soluble in organic solvents. It is optically active, levorotatory and has the hydroxyl group at  $C_3$  in  $\beta$  position (that makes it to precipitate with digitonin). Its melting point is  $148.5^\circ C$ .

### Biochemical role of cholesterol

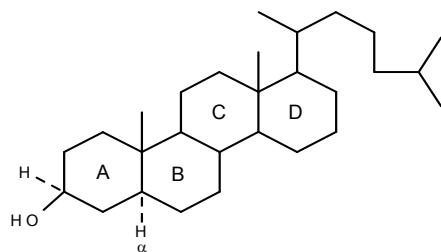
- Esterified to superior fatty acids, it is found in the constitution of lipids called sterides (frequently with palmitic, oleic and linoleic acids);
- It participates to the membranes structures and implicit to their permeability;
- It participates to the formation of plasma lipoproteins;
- It is the primary metabolic precursor of certain important steroids as bile acids and steroidal hormones;
- As 7-dehydrocholesterol is precursor of vitamin  $D_3$ ;
- It participates to the lipid emulsifying at intestine level, decreasing the superficial tension between water and lipids (due to its hydrophylic  $-OH$  group).

### Other natural sterols

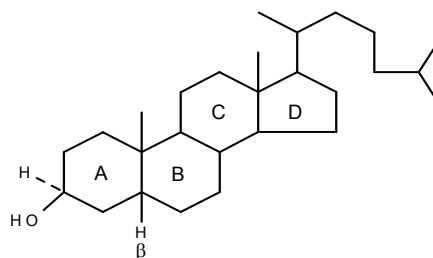
Sterols differ by number and position of double bonds, number of carbons in side chain and the position and orientation of hydroxyl group at  $C_3$ , of hydrogen at  $C_5$  (for those without double bond in this position).

Reducing cholesterol, cholestanol ( $5\alpha$ -cholestanol), is obtained. Cholestanol is found, beside cholesterol, in all type of cells, but in lower proportions.

Coprostanol ( $5\beta$ -cholestanol) results in intestine by the action of microorganism flora upon cholesterol. Coprostanol is found in feces and is one of the elimination forms of cholesterol.



Cholestanol  
(trans)

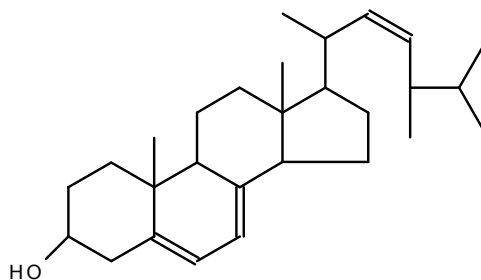


Coprostanol  
(cis)

7-dehydrocholesterol is provitamin  $D_3$  (it has another double bond in position 7-8).

Stigmasterol and sitosterol are found especially in superior plants, but they were identified also in animals.

Ergosterol has a vegetal origin and is found in skin (35-40% from the total sterols). It is the precursor (provitamin) of ergocalciferol or vitamin D<sub>2</sub>.



Ergosterol

### Biological derivatives of sterols:

Natural derivatives of sterols are vitamins D (calciferols), steroidal hormones and bile acids.

#### Vitamins D (calciferols):

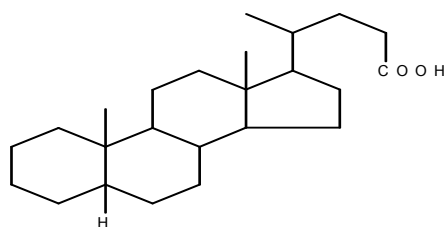
They are not really steroidal compounds (B nucleus is open), but have genetic relation to sterols, provitamins D are sterols. (See Vitamins chapter).

#### Bile acids:

They represent an assembly of compounds with steroidal structure, but are not proper lipids. As alkaline salts, with bile, they arrive in intestine where they intervene in lipid digestion and absorption. During the digestion process, they contribute to lipids emulsifying. The biochemical precursor of their synthesis is cholesterol, at the liver level and then delivered to the gall bladder.

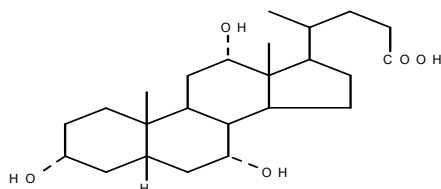
Round 50% of cholesterol, synthesized in the organism, is transformed in the liver into bile acids, which are poured out into bile.

The basic chemical structure is cholic acid.

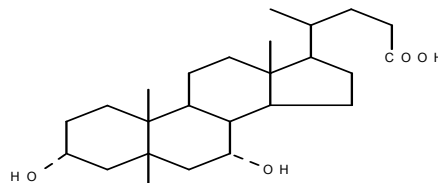


Cholic Acid

In the liver, cholanic acid is oxidized to cholic and chenodeoxycholic acids, namely primary bile acids.



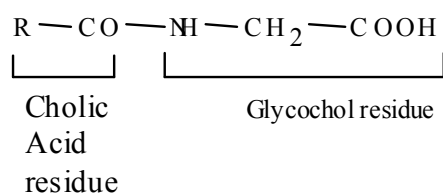
Cholic acid  
(3,7,12-trihydroxycholanic acid)



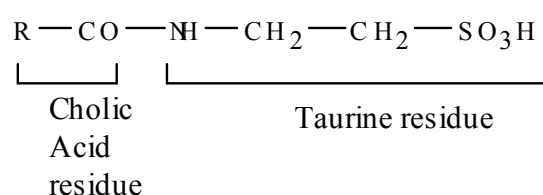
chenodeoxycholic acid  
(3,7-dihydroxycholanic acid)

Primary bile acids are conjugated with glycochol or taurine, forming conjugated primary bile acids: glycocholic acid, taurocholic acid, glycochenodeoxycholic and taurochenodeoxycholic acids.

An amide bond is form during conjugation.



← glycocholic acid



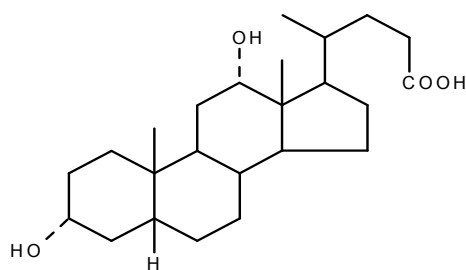
← taurocholic acid

Among the conjugated primary bile acids, glycocholic and taurocholic acids are the most quantitatively important. After their synthesis in liver, primary conjugated bile acids are secreted into bile, where, in contact with the alkaline pH and ions  $\text{Na}^+$ ,  $\text{K}^+$ , they are transformed in bile salts as sodium glycocholate, etc.

Bile salts arrive in intestine, where, due to the surfactant properties, act as emulsifying agents of food lipids, favoring their digestion and absorption.

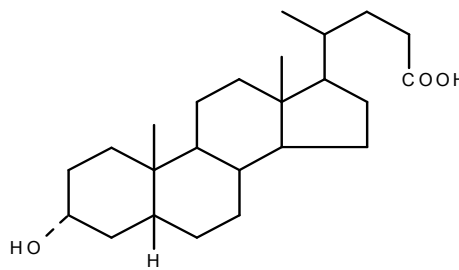
During their presence in intestine, part of primary bile acids are modified, due to the intestinal flora, by unconjugation and 7-hydroxylation, forming secondary bile acids:

deoxycholic acid, derivative of cholic acid and lithocholic acid, derivative of chenodeoxycholic acid.



deoxycholic acid

(3,12 - dihydroxycholanic acid)



lithocholic acid

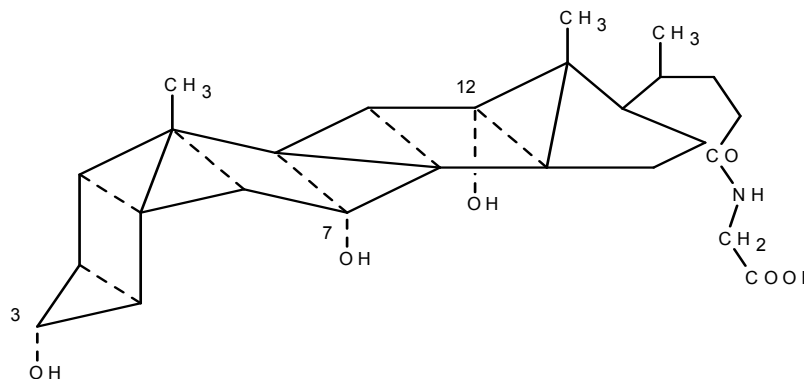
(3 - hydroxycholanic acid)

Both primary and secondary bile acids and their conjugates form salts in a light basic medium ( $\text{pH} > 7$ ), bile salts (ex. with  $\text{Na}^+$  or  $\text{K}^+$ ) which are more soluble than the corresponding acids.

Primary and secondary bile acids, which have participated in the small intestine to the food lipid digestion and absorption, are reabsorbed by intestinal mucosa at ileum level and are transported through portal vein to liver, in 98-99% proportion. Here a series of processes takes place: secondary bile acids are transformed in primary bile acids by hydroxylation at carbon in position 7, and then they are conjugated with taurine and glycol, then secreted again in bile and then in intestine. This circuit is called "enterohepatic circuit" of bile salts.

### Properties and role

Surfactant, detergent behavior of bile salts is explained by their tridimensional molecular model.



Tridimensional molecular model of glycocholic acid

All hydroxyl groups, with water affinity are situated on the same part of the molecule, the other part having a hydrophobic character. The side chain at C<sub>17</sub> can freely rotate, occupying different positions.

Bile acids are easily soluble in water, even they contain in molecule hydrophobic portions.

The most used identifying reactions are:

- Hay reaction (it is used for bile salts in urine) with sulphurous, based on their surfactant properties;
- Pettenkofer reaction, based on the reaction with hydroxymethylfurfurol (resulted from glucose under the action concentrated sulphuric acid) that forms red-violet coloured compounds of conjugation.

Bile acids are present in urine in pathological conditions. Cholaluria is found in hepatitis with extrahepatic biliary obstruction and parenchymatous hepatitis, but do not appear in hemolytic hepatitis.

### **Lipid structures with particular biological significance:**

#### **Lipoproteins:**

Lipoproteins are proteins in which the prosthetic component has a lipid nature: fatty acids, triacylglycerols, free and/or esterified cholesterol, phospholipids. Lipoproteic complexes have a macromolecular character, being implied in the constitution of certain subsellular structures (cell and mitochondrion membranes) and circulating lipids, as in blood plasma. Composition and percentage ratio between proteic and lipid components vary in large limits. In lipoproteins constitutions, both polar and nonpolar (neutral) lipids are found.

Lipoproteins serve as vehicles for lipid transport from small intestine to tissues and from liver to fatty deposits of other tissues. Plasma lipoproteins are classified according to their density, which reflects their content in lipids. The higher the lipid content, the lower their density is.

The main binding forces between the proteic component and the lipidic one are the hydrophobic and electrostatic forces; van der Waals forces can also participate.

#### **Lipidic micelles:**

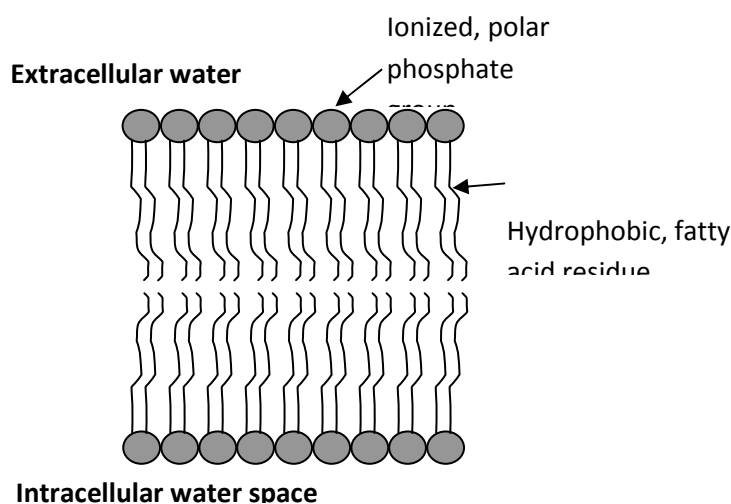
In aqueous systems, polar lipids (amphiphilic or amphipathic molecules, with a hydrophilic and a hydrophobic part) disperse rapidly (as soaps do), forming micelles in which



hydrocarbon parts of lipids are kept from aqueous medium; the hydrophilic part is exposed to surface. Such micelles can contain thousands of lipid molecules.

Polar lipids spread spontaneously on the surface of aqueous solutions to form a layer with the thickness of one molecule (monolayer), with the hydrocarbon (with hydrophobic properties) parts exposed to air, and hydrophilic parts extend in the water phase.

Polar lipids form easily double layers. In these structures, the hydrocarbon parts of polar lipid molecules are arranged toward interior, forming a continuous hydrocarbon phase; the hydrophilic heads are directed on the external faces, found in contact with aqueous phase. These structures have approx 70 Å thicknesses (Figure 1). Formation of the double lipid layer (favoured for majority of phospholipids and glycolipids in aqueous media) is a rapid and spontaneous process, and auto-assembling one. Double lipid layers are cooperative structures, which can have macroscopic dimensions up to 1 mm; they can serve as permeability barriers. The major forces that determine the forming of double lipid layers are the hydrophobic interactions.



**Figure: Arrangement of polar lipids in micelles and double layers**

Certain energetic factors can have significant biologic consequences for the double lipid layers, as the inherent tendency to be extensive and to auto-close, forming compartments. Finally, double lipid layers can close along discontinuities – a „hole” in the double layer is, energetically, unfavorable.

**Lipids in cell membrane:**

The properties of such double lipid layers resemble to those of natural membranes. It is known that natural membranes are formed of a double phospholipids layer, with specific proteins and enzymes attached to surface, or penetrating into or through the hydrocarbon layer. Several modes have been proposed for biological membranes, the accepted one being the mosaic model, presented in Figure 2.

As defining biological membranes, we appreciate that these are structures composed mainly of proteins and lipids, which realize compartmentalization of living matter and having characteristic properties of selective permeability. Biomembranes delimit the internal medium of cell, also the intracellular particles.

Organization and structural stability of biomembranes is realized by two types of interactions:

- hydrophobic interactions (lipid – lipid);
- electrostatic interactions (lipid-proteins).

---

**9.6 SUMMARY**

---

- I. lipids are fats and fat-like substances
  - A. lipids are a heterogeneous group of compounds defined by solubility, not structure
  - B. oily or fatty compounds
  - C. lipids are principally hydrophobic, and are relatively insoluble in water (some do have polar and nonpolar regions)
    1. lipids consist mainly of carbon and hydrogen
    2. some oxygen and/or phosphorus, mainly in the polar regions of lipids that have such regions
  - D. roles of lipids include serving as membrane structural components, as signaling molecules, and as energy storage molecules
  - E. major classes of lipids that you need to know are triacylglycerols (fats), phospholipids, and terpenes
  - F. triacylglycerols contain glycerol joined to three fatty acids
    1. glycerol is a three carbon alcohol with 3 -OH groups
    2. a fatty acid is a long, unbranched hydrocarbon chain carboxyl group at one end

- saturated fatty acids contain no carbon-carbon double bonds (usually solid at room temp)
  - unsaturated fatty acids contain one or more double bonds (usually liquid at room temp)
    - monounsaturated – one double bond
    - polyunsaturated – more than one double bond
  - about 30 different fatty acids are commonly found in triacylglycerols; most have an even number of carbons
3. condensation results in an **ester linkage** between a fatty acid and the glycerol
    - one attached fatty acid = monoacylglycerol
    - two = diacylglycerol
    - three = triacylglycerol
  4. triacylglycerols (also called triglycerides) are the most abundant lipids, and are important sources of energy
- G. **phospholipids** consist of a diacylglycerol molecule, a phosphate group esterified to the third -OH group of glycerol, and an organic molecule (usually charged or polar) esterified to the phosphate
1. Phospholipids are **amphipathic**; they have a nonpolar end (the two fatty acids) and a polar end (the phosphate and organic molecule)
  2. This is often drawn with a polar “head” and two nonpolar “tails”
  3. The nonpolar (or hydrophobic) portion of the molecule tends to stay away from water and the polar (or hydrophilic) portion of the molecule tends to interact with water
  4. Because of this character phospholipids are important constituents of biological membranes.

---

### ***9.7 TERMINAL QUESTIONS***

---

1. What two chemicals combine to form a lipid?
2. What elements are found in lipids?
3. What is the name given to that type of chemical reaction?
4. Name three uses of lipids in living things.

5. What is the chemical difference between a saturated and an unsaturated fat?
6. What is the biological importance of unsaturated fats?
7. Name one unsaturated fat.
8. Why would a 'fat-free' diet kill you?
9. What do 'omega-3 oils' do for you?
10. Name a good source of 'omega-3 oils.

---

## UNIT-10 NUCLEIC ACIDS

---

### CONTENTS

- 10.1 Objectives
- 10.2 Introduction
- 10.3 Structure of Nuclcosides
- 10.4 Structure of Nucleotides
- 10.5 Constituents of nucleic acids
- 10.6 Ribonucleic acid (RNA)
- 10.7 Function of Nucleic Acids
- 10.8 Genetic Code
- 10.9 Differences Between DNA and RNA
- 10.10 Summary
- 10.11 Terminal Question
- 10.12 Answers

---

### ***10.1 OBJECTIVES***

---

Nucleic acids occur in all living cells as a major component of the nucleus and also as a component of cytoplasmic structures such as the ribosomes. They are generally associated with protein to form nucleoproteins. Genes are made up of Nucleic acids. Genes are strung in a linear arrangement along chromosome. In humans there are 46 chromosomes that carry the genes responsible for heredity (Discovered by Mendal, lateron by T.H. Morgan and others). The objective of this unit is the study of structure of Nucleic acid with their chemical constitution. In this unit we also studied structure of DNA and RNA in detail.

---

### ***10.2 INTRODUCTION***

---

Nucleic acids are colors, complex, amorphous compounds made up of three units : Nitrogenous bases (Purine or pyrimidine), sugar and phosphoric acid. These are obtained by the hydrolysis of

nucleoproteins which is a class of conjugated proteins. Nucleic acids constitute the prosthetic group of nucleoproteins, whereas the protein part consists of protamines and histones. These are macromolecules of high molecular weight and are present in every living cell.

The nucleic acids are generally divided into two main groups, according to the nature of the sugar present:

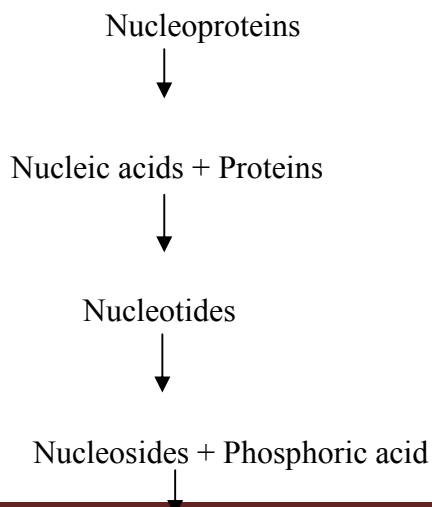
### **The pentose nucleic acids or ribonucleic acids (RNA)**

### **Deoxypentose nucleic acids or deoxyribonucleic acids (DNA).**

RNA is found in all subdivisions of the cell, nucleus and cytoplasm, in particles and supernatant fluid. However, ribosomes are the richest in RNA followed by mitochondria. Because of their abundance in yeast, RNA is also called yeast nucleic acids or plasmonucleic acids; similarly DNA is called thymus nucleic acids or chromonucleic acids, because of their abundance in chromosomes (thymus).

The nucleic acids contain only six fundamental units. All the RNA contain ribose, a phosphoric acid group, and four nitrogen bases (adenine, guanine, cytosine, and uracil). All the DNAs contain-deoxyribose, a phosphoric acid group, and four nitrogen bases (adenine, guanine, cytosine, and thymine). The DNAs are macromolecules with molecular weight ranging from 6 million to 16 million, although in some cases very high molecular weight (120 million) has been reported. On the other hand, RNAs are generally much smaller with the molecular weight range of 20,000 to 40,000.

The following chart shows the nature of the products obtained by the stepwise hydrolysis of nucleic acids.

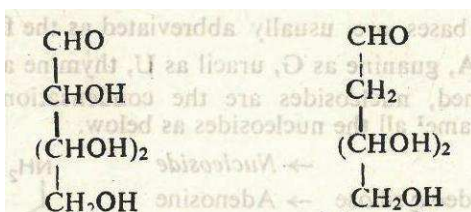


Sugar-1-phosphate + Bases (Purines + Pyrimidines)

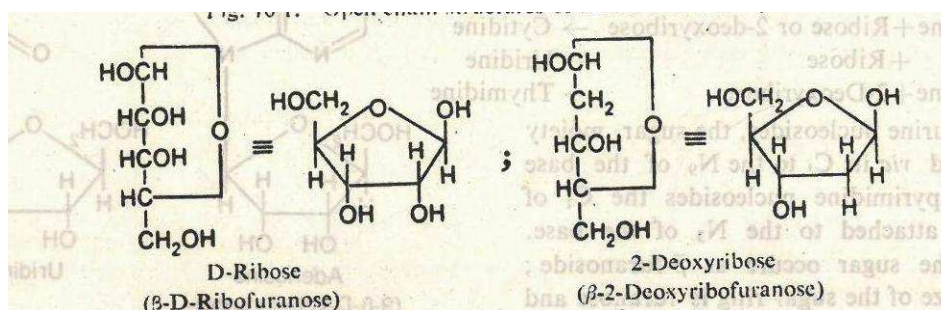
### 10.3 STRUCTURE OF NUCLOCOSIDES

These are the condensation products of a sugar and a base (nitrogenous) and are obtained by hydrolysis of nucleotides. Since we know that nucleosides on acidic hydrolysis give basis and sugar, therefore for knowing the structure of nucleosides we must have some knowledge about the structures of the various bases and sugars present in the nucleosides. It must be noted that pyrimidine nucleosides are much more stable to hydrolysis, unless the 4, 5-double bond is hydrogenated first by Raney nickel.

**i) Sugars:** Only two sugars have been isolated from the hydrolysates of nucleic acids ; both are pentoses : D-ribose and 2 - deoxy-D-ribose is present only in RNA whereas 2-deoxy-D-ribose is present only in DNA. The structure of these pentoses can be represented as below.



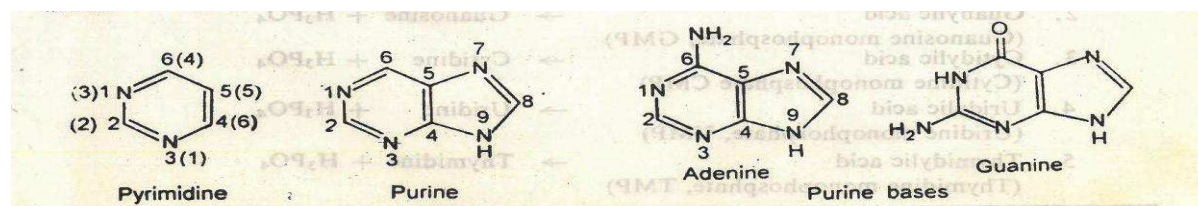
*Open chain structures of ribose and 2-deoxyribose.*



In the nucleic acids, both of the pentoses exists in the B-furanose form.

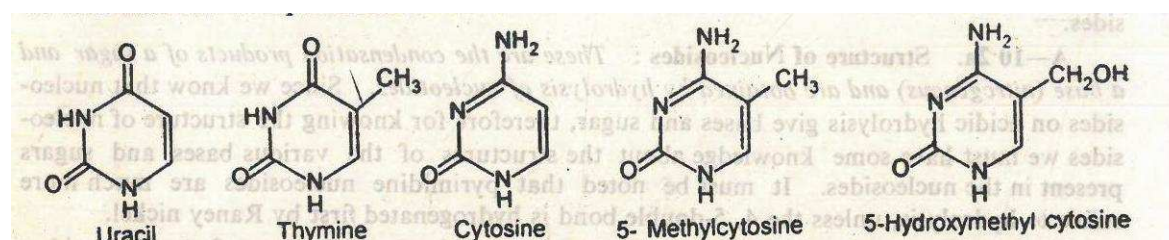
**ii) Bases:** Two types of bases have been isolated from the hydrolysis products of nucleosides; purines and pyrimidines.

The purine and pyrimidine bases are derivatives of the respective compounds purine and pyrimidine. The letter (pyrimidine) is a six-membered ring with two nitrogen and four carbon atoms, while the former (purine) consists of a pyrimidine ring fused with an imidazole ring. The structures and the numbering in the nuclei of the two present bases are given above.



The most common purine bases found in nucleic acids are adenine and guanine.

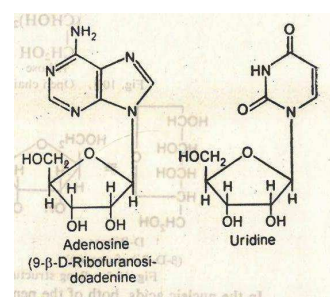
Similarly, the pyrimidine bases are uracil, thymine, cytosine, 5-methylcytosine and 5-hydroxymethyl cytosine. The last two pyrimidine bases are rarely found. The structure of each base can be represented as below.



Out of the five important bases (adenine, guanine, uracil, thymine and cytosine), adenine, guanine and cytosine occur in both types of the acids, i.e. R.N.A. as well as in D.N.A. whereas uracil is present only in R.N.A. and thymine only in D.N.A. for convenience, the purine and pyrimidine bases are usually abbreviated as the first letter of the name. Thus adenine is designated as A, guanine as G, uracil as U, thymine as T, and cytosine as C.

As already mentioned, nucleosides are the condensation products of the bases with sugar; so we can now name all the nucleosides as below.

Base	+Sugar	→	Nucleoside
1. Adenine	+ Ribose or 2-deoxyribose	→	Adenosine
2. Guanine	+ Ribose or 2-deoxyribose	→	Guanosine
3. Cytosine	+ Ribose or 2-deoxyribose	→	Cytidine
4. Uracil	+ Ribose	→	Uridine
5. Thymine	+ 2-deoxyribose	→	Thymidine



Structure of Nucleoside

In purine nucleosides, the sugar moiety is attached via its C1 to the N9 of the base while in pyrimidine nucleosides the C1 of sugar is attached to the N3 of the base. Further the sugar occurs as B-furanoside; i.e. the size of the sugar ring is furanose and its configuration is B.



---

## 10.4 STRUCTURE OF NUCLEOTIDES

---

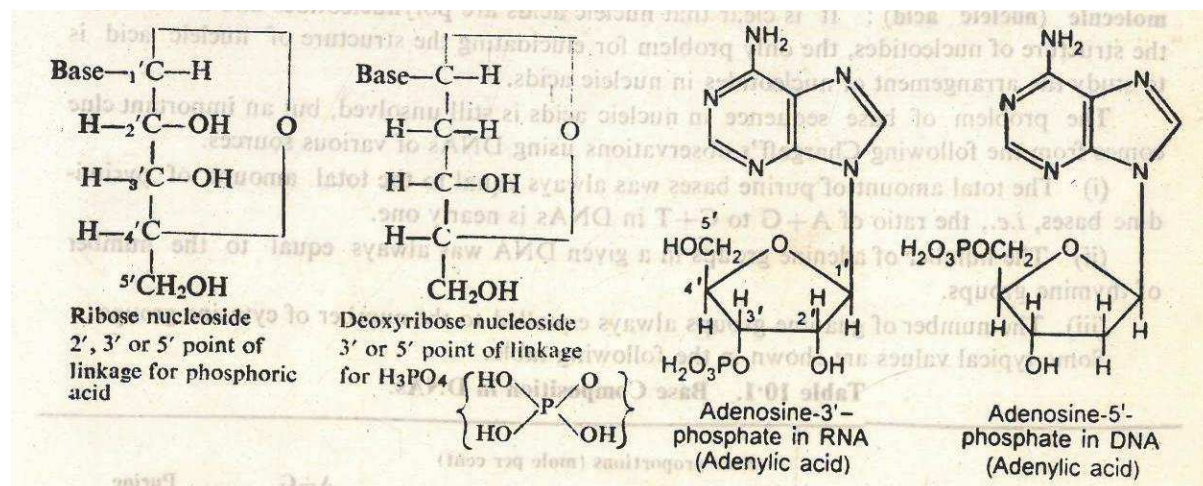
Nucleotides are phosphoric esters of nucleosides. These are obtained by the controlled hydrolysis of nucleic acids. On hydrolysis in neutral solution they give nucleosides and phosphoric acid. Thus the composition of the various important nucleotides can be represented as below.

Nucleotides		Nucleosides + H <sub>3</sub> PO <sub>4</sub>
1. Adenylic Acid (Adenosine monophosphate, AMP)	—————>	Adenosine + H <sub>3</sub> PO <sub>4</sub>
2. Guanylic acid (Guanosine monophosphate, GMP)	—————>	Guanosine+ H <sub>3</sub> PO <sub>4</sub>
3. Cytidylic acid (Cytidine monophosphate CMP)	—————>	Cytidine+ H <sub>3</sub> PO <sub>4</sub>
4. Uridylic acid (Uridine monophosphate UMP)	—————>	Uridine+ H <sub>3</sub> PO <sub>4</sub>
5. Thymidylic acid (Thymidine monophosphate UMP)	—————>	Thymidine+ H <sub>3</sub> PO <sub>4</sub>

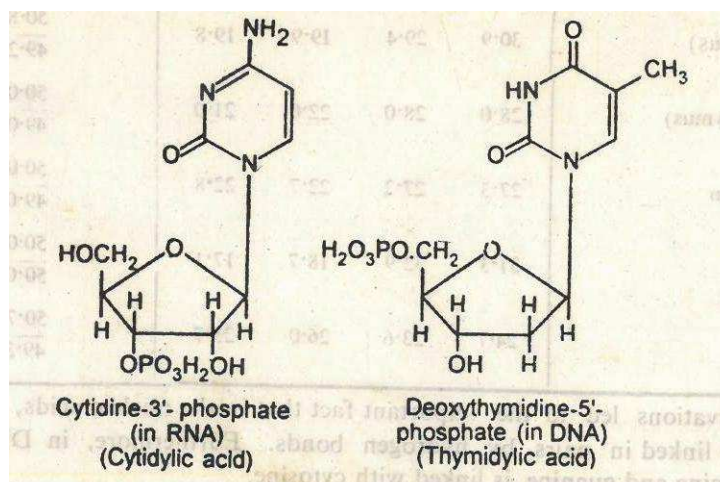
When nucleotides are carefully hydrolysed, ribose monophosphate may be isolated from the products which proves that the phosphate group is attached to the ribose and not to the purine or pyrimidine base which are found to be free in the product. Thus the nucleotides may be represented as below.

Base-Pentose (Ribose or Deoxyribose) - Phosphoric acid.

It is clear from the structures of nucleosides that the point of attachment may be 2',3' or 5' in case of ribose<sup>1</sup> molecule and only 3' or 5' in case of deoxyribose molecule depending upon the nature of the source of nucleotides.



It is also shown experimentally that either of the above mentioned positions may be point of linkage. The position (point of linkage) of the phosphate is indicated by a numeral, e.g. adenosine-3' phosphate, adenosine-5' phosphate, etc.



In addition to the above mentioned nucleotides, cyclic nucleoside phosphates (cyclic nucleotides) have been identified from the enzymatic hydrolysates of RNA. The cyclic nucleoside phosphates may be 2',3'- or 3',5'.

### ***10.5 ARRANGEMENT OF NUCLEOTIDES IN NUCLEIC ACID AND THE STRUCTURE OF THE RESULTING MOLECULE (CONSTITUENTS OF NUCLEIC ACIDS)***

It is clear that nucleic acids are polynucleotides and as we know the structure of nucleotides, the only problem for elucidating the structure of nucleic acid is to study the arrangement of nucleotides in nucleic acids.

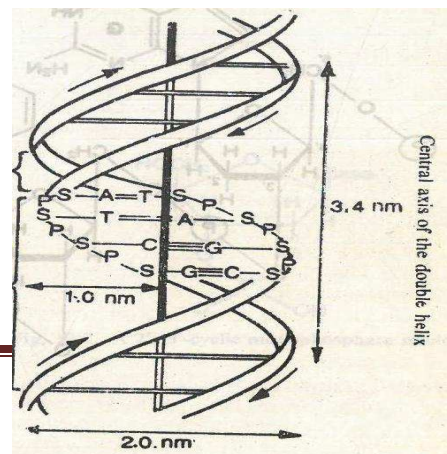
The problem of base sequence in nucleic acids is still unsolved, but an important clue comes from the following Chargaff's observation using DNAs of various sources.

- (i) The total amount of purine bases was always equal to the total amount of pyrimidine bases, i.e. the ratio of A+G to C+T in DNAs is nearly one.
  - (ii) The number of adenine groups in a given DNA was always equal to the number of thymine groups.
  - (iii) The number of guanine groups always equaled to the number of cytosine groups.
- Some typical values are shown in the following table.

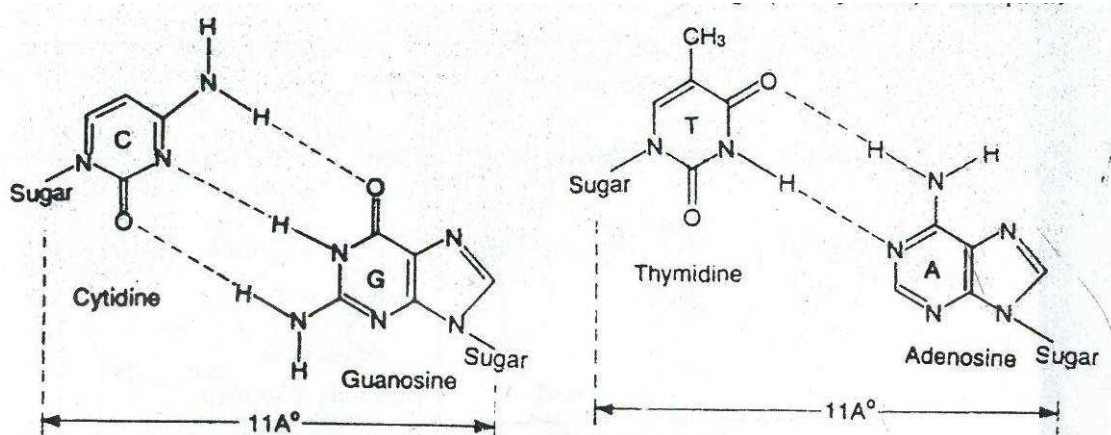
Source of DNA	Base Proportions (mole per cent)				$\frac{A+G}{C+T}$ i.e., $\frac{\text{Purine}}{\text{Pyrimidine}}$
	A	T	G	C	
Man (thymus)	30.9	29.4	19.9	19.8	$\frac{50.8}{49.2} = 1.03$
Bovine (thymus)	28.0	28.0	22.0	21.0	$\frac{50.0}{49.0} = 1.02$
Wheat germ	27.3	27.2	22.7	22.8	$\frac{50.0}{49.0} = 1.02$
Yeast	31.3	32.9	18.7	17.1	$\frac{50.0}{50.0} = 1.00$
<i>Esch. col.</i>	24.7	23.6	26.0	25.7	$\frac{50.7}{49.3} = 1.03$

This observation led to the important fact that in the nucleic acids, pyrimidine and purine bases are linked in pairs by hydrogen bonds. Furthermore, in DNAs adenine is linked with thymine and guanine is linked with cytosine.

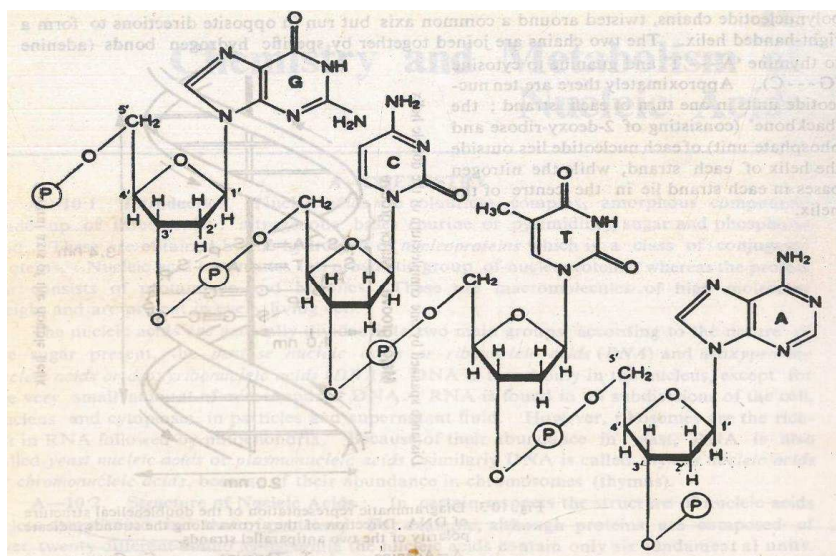
On the basis of the above fact and the X-ray analysis of DNA, J.D. Watson and F.H.C. Crick (shared Nobel Prize in 1962 in medicine and physiology) proposed a model structure for DNA in 1953. They suggested that the DNA molecule consists of two polynucleotide chains, twisted



around a common axis but run in opposite directions to form a right-handed helix. The two chains are joined together by specific hydrogen bonds (adenine to thymine) 'A ----T' and guanine to cytosine (G----C). Approximately there are ten nucleotide units in one turn of each stand; the 'backbone' (consisting of 2-deoxy-ribose and phosphate unit) of each strand, while the nitrogen bases in each strand lie in the centre of the helix.



On an average, the DNA content of a single gene is said to be about 74 nucleotide pairs while that of a cell it is about  $10^9$  nucleotide pairs. In case the DNA molecules of all the cells in the adult human body are stretched out and arranged end to end, it will have a length of  $10^{10}$  miles which is more than the distance between the earth to the sun ( $9 \times 10^7$  miles).



**The double strand structure of DNA is further proved by denaturation:** dilute, buffered, neutral solution of DNA is heated at  $100^{\circ}\text{C}$ ; cooled rapidly and the mol. Wt. of DNA is

measured. It is found to have been halved. Density in cesium ohloride solution also shows that two molecular species are present.

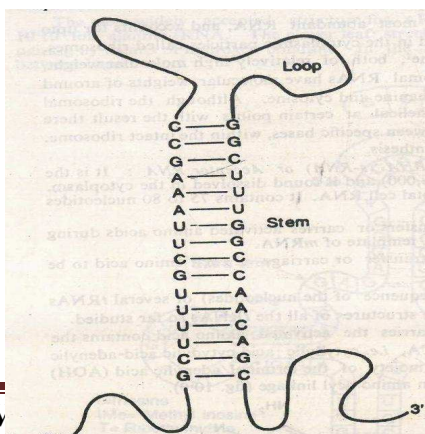
---

## 10.6 RIBONUCLEIC ACID (RNA)

---

Ribonucleic acid, like DNA, is a long unbranched macro-molecule consisting of nucleotides joined by 3' – 5' phosphodiester bonds. Although, RNA shares many features with DNA, it has several specific differences.

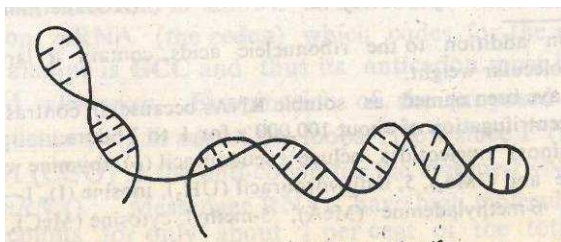
1. In RNA, the sugar moiety to which the phosphate and nitrogen bases are attached is ribose. (Recall that in DNA, the sugar moiety is 2-dioxy – ribose).
2. In RNA, one of the pyrimidine base is uracil (In place of thymine of DNA), although other three bases) *viz*, adenine, guanine and cytosine) are common in RNA as well as DNA. Uracil, like thymine of DNA, can form a base pair with adenine by two hydrogen bonds.
3. RNA exists as a single-strand, whereas DNA exists as a double-stranded molecule. However, given the proper complementary base sequence with opposite polarity (direction), the single strand of RNA may fold back on itself like a hairpin (Stem loop) and thus acquire the double-standard pattern. In the region of hairpin loops, A pairs\* with U and G pairs\* with C. However, the base pairing in RNA hairpins is frequently imperfect. Some of the opposing bases may not be complementary and one or more base along a single strand may be lcoped out to facilitate the pairing of others.
4. Since RAN is a single stranded molecule, its guanine content does not necessary equal its cytosine content and its adenine content does not necessarily equal its uracil content



***Digammatic representation of the secondary structure of single-stranded RNA molecule.***

5. RNA can be hydrolyzed by alkali to 2',3'-cyclic diesters of the mononucleotides via an intermediate compound called 2',3',5'-triesther. This intermediate can't be formed in alkali-treated DNA because of the absence of a 2'-hydroxyl group in its molecule. Thus RNA is alkali labile, while DNA is alkali stable. The alkali lability of RNA is useful dia-gnostically and analytically.

The structure of RNA is believed to be similar to that of DNA, except for the difference in its pentose (D-ribose) unit and the heterocyclic base (uracil in place of thymine). Like DNA, these are also polynucleotides linked together by phosphate diester bonds between 3' and 5' position of ribose moieties. The purine bases adenine and guanine and the pyrimidine base cytosine and uracil are present. But they are not present in equimolar amounts. The molecule is less organized than the DNA molecule and with a few exceptions occurs as a single strand. There is internal hydrogen bounding within the chain to keep it in a coiled position. A helical pattern is formed not between two strands, but by the same coiled strand folding back on itself.



***Single stranded RNA molecule.***

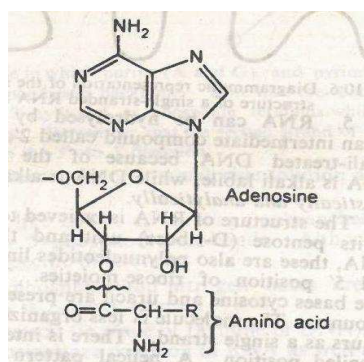
Although RNA exists mainly in the cytoplasm, about 10-20 per cent of cell RNA is found in the nucleus of the cell nucleus. There are three classes of ribonucleic acids which differ chiefly in molecular weight and base composition.

- a) **Ribosomal RNA (r-RNA)** : This the most abundant R.N.A. and accounts for upto 80 percent f the total cell RNA. It is located in the cytoplasmic particles called ribosome's.

Two molecules of RNA occur in each ribosome, both of relatively high molecular weight, two molecules of RNA occurs in each ribosome, both of relatively high molecular weight, viz  $0.7 \times 10^6$  and  $1.6 \times 10^6$ . In general, ribosomal RNAs have molecular weights or around 0.5 to 1 million and contain relatively much guanine and cytosine. Although the ribosomal RNAs are also single-standard, the strands are helical at certain points with the result there is tight packing owing to hydrogen bonding between specific bases, within the intact ribosome. Ribosomal RNAs provide the site of protein synthesis.

b) **Transfer RNA (t-RNA) or Soluble RNA (s-RNA) or Acceptor**

**RNA:** It is the smallest molecular species of RNA (mol. Wt.-6,000) and is found dissolved in the cytoplasm. It accounts for about 15 to 20 per cent of the total cell RNA. It contains 75 to 80 nucleotides and relatively a lot of the more unusual bases<sup>3</sup>.



*Attachment of amino acid to adenosine (AOH) terminus of RNA*

As the name indicates, transfer RNA transfers or carries activated amino acids during protein synthesis to the proper site on the RNA template of mRNA.

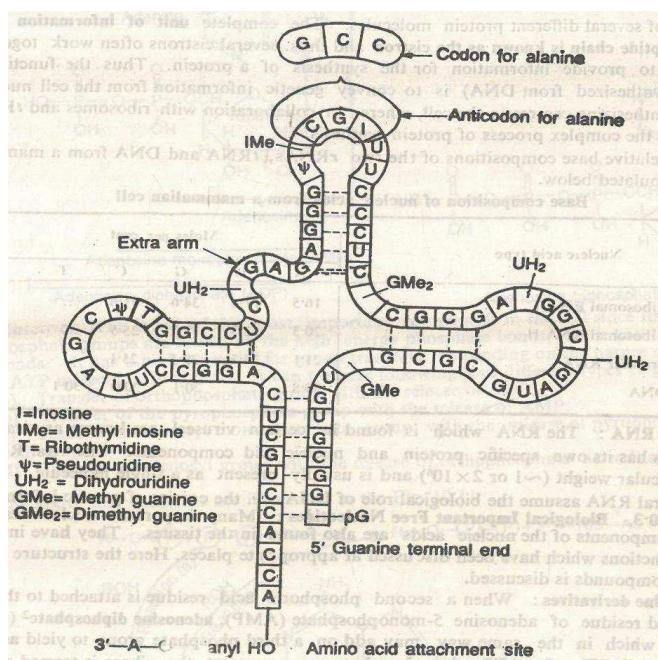
There is specific tRNA molecule for the transfer or carriage of each amino acid to be incorporated into proteins.

The entire primary structure (that is the sequence of the nucleotides) of several tRNAs are known. There are certain similarities in the structures of all the tRNAs so far studied.

- (i) The 3' – end of the molecules which carries the activated amino acid contains the same trinucleotide with the base sequence CCA, i.e. cytydylic acid-cytydylic acid-adenylic acid. The C<sub>3</sub> hydroxyl group of the ribose moiety of the terminal adenylic acid (AOH) attaches the amino acid (to be transferred) via an amino acyl linkage as show in figure.

- (ii) A guanine nucleotide (designated as pG) frequently occurs at the 5' phosphate terminus of the tRNA molecule.
- (iii) Although thymine is generally found only in DNA, a thymine containing nucleotide is found at the 23<sup>rd</sup> position in the tRNA molecule.
- (iv) The nucleotide composition of tRNA is characterized by the presence of several minor base-containing nucleotides.

The most widely accepted structure for t-RNA is clover leaf which is shown in fig. for alanine tRNA. The clover leaf structure provides a maximum amount of base pairing by means of hydrogen bonding. In the loop regions, there is no hydrogen bonding between bases.



*General clover leaf structure for alanine-tRNA from yeast.*

Alanine-tRNA consists of 77 nucleotides (Holley and co-workers) and has 17 GC, 2 AU, and 1 GU base pairs. The trinucleotide which is specific for the amino acid to be carried is present in one of the three bases on mRNA (the codon) which codes for the amino acid carried. For example, the Codon for alanine is GCC and thus its anticodon must be CGG because G is complementary to C and vice versa. Examination of the proposed structure for the alanine-tRNA shows the sequence CGI (CGG) is the anti-codon for the alanine-tRNA.



**(c) Messenger RNA (mRNA):** Messenger RNA have high molecular weight (Perhaps upto several million) and accounts for only about 1 percent of the total RNA of the cell. These RNAs are unstable and short lived and their synthesis is directed by DNA, and thus in base composition they resemble a strand of DNA. These are synthesized in the nucleus and then get transferred to cytoplasm.

One of the strands of DNA acts as a template for synthesis of mRNA and thus a message may be derived only from certain discrete sections of the DNA strand. In other words. An active strand of DNA carries information for the synthesis of several different protein molecules. The complete unit of information for the protein peptide chain is known as the cistron and thus several of a protein. Thus the function of a mRNA (synthesized from DNA) is to convey genetic information from the cell nucleus to protein-synthesizing centers in the cell, where, in collaboration with ribosome and tRNA, it engages in the complex process of protein synthesis.

**6. Viral RNA:** The RNA which is found in certain viruses<sup>1</sup> are known as viral RNA. Each virus has its own specific protein and nucleic acid components. The viral RNA has high molecular weight ( $-1$  or  $2 \times 10^6$ ) and is usually present as a single molecule. In these viruses viruses viral RNA assume the biological role of DNA, i.e. the carrier of genetic information.

---

## ***10.7 FUNCTION OF NUCLEIC ACIDS***

---

**The main functions of nucleic acids are:**

1. DNA replication.
2. Protein synthesis

**1. Replication of DNA:** One of the most important properties of DNA is that it can make exact copies of itself. This process is called replications.

Replication is not quite the same as duplication. A duplicate is simply an exact copy of an original; a replica is a newly created structure made by using the original as a model or guide. The replication process is the very basis of life.

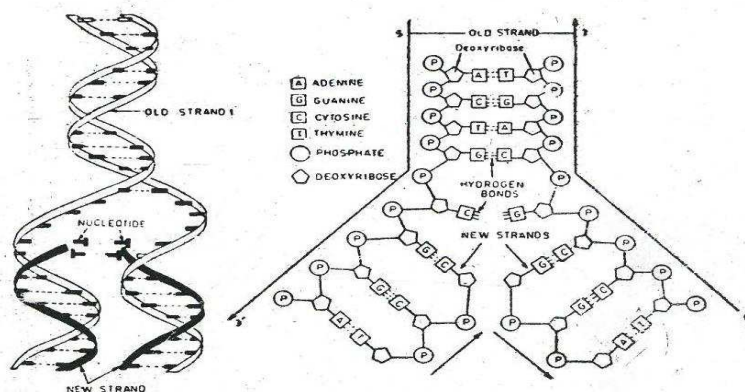
The replication of DNA can be explained most simply by assuming that the two strands separate by breaking the hydrogen bonds. Each single strand (also called primer) has now an exposed row of bases that serves as a template. The bases of free deoxyribonucleotides

(monomers) form hydrogen bonds with these exposed bases. The template strand dictates the sequence in which the free nucleotides are assembled, i.e. the bonds can only be made between complementary base pairs (A-T, T-A, C-G, G-C) and thus a complementary chain to the template is formed. For example, if a segment of the template has the arrangement ATTGACAA from the free 5' to the free 3' end, the newly synthesized chain will be TAACTGGT from the free 3' to the free 5' end. As each strand produces its complementary strand, the two newly formed strands combine into a DNA molecule identical to the original.

The complex chemistry of replication is catalyzed by several DNA polymerases and DNA ligase.

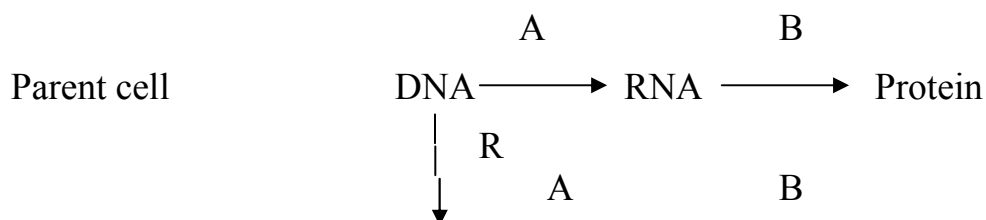
Replication ensures that the genes, which are segments of the DNA molecule, are present in identical sets in all cells of the body or an individual. DNA fulfills the requirement of a genetical material, i.e., the ability to replicate.

Replication of DNA is shown diagrammatically as :



1. **Protein Synthesis:** Proteins are built up from about 20 amino acids. The sequence of amino acids has a bearing on the properties of a protein and is characteristic for a particular protein.

The basic mechanism of protein synthesis is that DNA makes RNA which in turn makes protein. The various essential steps of protein synthesis may be expressed as follows.





C	Leu Leu Leu Leu	Pro Pro Pro Pro	His His Gln Gln	Arg Arg Arg Arg	U C A G
A	Ile Ile Ile Met <sup>1</sup>	Thr Thr Thr Thr	Asn Asn Lys Lys	Ser Ser Arg Arg	U C A G
G	Val Val Val Val	Ala Ala Ala Ala	Asp Asp Glu Glu	Gly Gly Gly Gly	U C A G

It was found that the triplet code is degenerate, i.e. there may be more than one triplet code for a particular amino acid. For example, UUU and UUC both are the codons for phenylalanine, while there are six codons : UUA, UUG, CUU, CUC, CUA and CUG, for leucine.

---

### ***10.9 DIFFERENCES BETWEEN DNA AND RNA***

---

1.	DNA is the usual genetic material.	It is the genetic material of some viruses.
2.	Most DNA is found in the cytoplasm of the cell.	Most RNA, although synthesized in the nucleus by DNA, is found in the cytoplasm of the cell.
3.	DNA is usually double-stranded. In certain viruses, DNA is single strands, e.g., X174.	Most cellular RNA is single stranded. However, some viruses, e.g., Reovirus have double-stranded RNA.
4.	There is only one general structure for the	There are three distinct RNA species.

	DNA molecule.	
5.	DNA is composed of a large number of nucleotides upto 4.3 million.	RNA is composed of fewer nucleotides, up to 12,000.
6.	In DNA, the pentose sugar is deoxyribose.	In RNA, the pentose sugar is ribose.
7.	The common organic bases found in DNA are adenine, guanine, cytosine and thymine.	The common organic bases found in RNA are adenine, guanine cytosine and uracil.
8.	In DNA, adenine pairs with thymine and guanine with cytosine.	In RNA, adenine pairs with uracil and guanine with cytosine.
9.	Pairing of bases is found throughout the length of the molecule.	Pairing of bases is found only in the helical region.
10.	DNA on replication forms DNA and on transcription forms RNA.	Generally, RNA does not replicate or transcribe. In certain cases, RNA can synthesize a RNA chain.
11.	Genetic messages are generally encoded in DNA.	The main function of RNA is to translate messages encoded in DNA into proteins.
12.	Most of the DNA has been found in the chromosomes. Some DNA has also been found in the cytoplasm, e.g., in mitochondria and chloroplasts.	Most of the RNA has been found on the chromosomes and found in the nucleolus and cytoplasm. rRNA and rRNA are also found on the chromosomes and found in cytoplasm.

---

### ***10.10 SUMMARY***

---

Nucleic acids are high molecular weight polymers; they are constituents of practically all cells. In this unit we study the structure of nucleic acid. As nucleic acids are complex compound thus their structure studied with the structure of their component. In this unit we studied the structure

of each component of nucleic Acid. We also discuss the different types of RNA present in the cells. In this unit we studied the DNA as a genetic material with structure also.

---

### ***10.11 TERMINAL QUESTIONS***

---

1. What is nucleic Acid? How do you say that nucleotides are energy carriers?
2. What do DNA and RNA stand for? What are points of different between the two?
3. What do you know about the structure of DNA? What is meant by replication of DNA?
4. What are various functions of DNA?
5. Define two following terms. (a) Nucleotide (b) Nucleoside.
6. Draw the structure of Nucleotide base.
7. Briefly outline the functional role of:  
(a) Messenger RNA                      (b) Transfer RNA                      (c) Ribosomal RNA?
8. What is the relationship between each of the following?  
(a) Ribose and deoxyribose.  
(b) A nucleoside and a nucleotide.  
(c) A nucleotide and nucleic Acid.
9. Name the various bases present in DNA and RNA.
10. Write a note on the structure of RNA and DNA.

---

## UNIT-11 FATS OILS AND DETERGENTS

---

### CONTENTS

- 11.1 Objectives
- 11.2 Introduction
- 11.3 Properties and uses of oils and fats
- 11.4 Hydrogenation of Oils
- 11.5 Analysis of oils and Fats
- 11.6 Classification of oils
- 11.7 Distinction between Animal and Vegetable Fats
- 11.8 Waxes
- 11.9 Soaps and soapless detergents
- 11.10 Some Special Varieties of Soap
- 11.11 Cleansing Action of Soap
- 11.12 Synthetic Detergents
- 11.13 Methods of Preparation
- 11.14 Application of Detergents
- 11.15 Synthetic Detergents versus Soaps
- 11.16 Summary
- 11.17 Terminal Question
- 11.18 Answers

---

### ***11.1 OBJECTIVE***

---

Fats and oils make up over 90% percent of the lipid of adipose tissue in mammals. Fats and oils are predominantly the glyceryl esters of various higher fatty acids; mainly palmitic, stearic, oleic, and linolenic. Common examples of naturally occurring fat and oils are lard (pig fat), tallow (beef and mutton fat), olive oil, linseed oil, coconut oil and sesame oil. Fats and oils are of tremendous importance in nutrition. In calorie value they rank highest among the food. 1 gm of fat produces 9.3 Kcal. In addition to the above use, they are also used for cooking, soap making, candle manufacture, glycerol manufacture, lubrication and for medicinal purposes. So it is very important to study the fats and oils. These are also used in the paint and varnish industry leather

industry and also the production of synthetic detergents and fatty acid. In this unit we studied oil and fats for their so many importance with manufacture of soap and detergent.

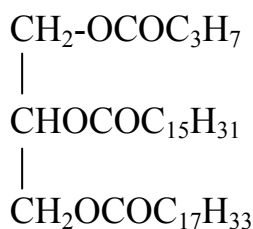
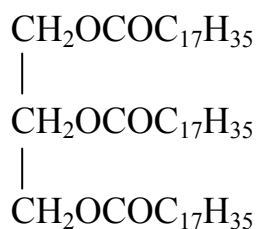
---

## 11.2 INTRODUCTION

---

Oils and fats are glyceryl esters and glycerides of higher fatty acids. Those which are liquids at ordinary temperatures are called oils. These contain a larger proportion of unsaturated acids than do fats which are solid at ordinary temperatures.

Some common simple glycerides are tristearin, tripalmitin and triolein & mixed glyceride as:



Tristearin (Simple Glyceride)

$\alpha$  - palmito -  $\alpha'$ : $\beta$  diolein (Mixed glyceride)

All natural fats and oils invariably consist of a mixture of mixed glycerides, e.g. lard is a mixture of the oleo-palmito-stearin, palmito- distearin, stereo-dipalmitin and palmito-diolein.

Oils and fats may be of animal or vegetable origin as whale oil (an oil) and tallow (a fat) have an animal origin. While linseed oil (an oil) and coconut oil (a fat) have vegetable origin. They differ from minerals and essential oils, as :

**Mineral Oils** - have a mineral origin and are a mixture of hydrocarbons. Kerosene is a mineral oil.

**Essential Oils** - are found in various plants. These are highly volatile pleasant - smelling liquids. Clove oil, lemon oil and turpentine are examples of essential oils.

Common methods employed for the extraction of oils and fats are -



**(i) Melting** - Animal fats are generally separated from tissue by heating when the fat melts and flows down.

**(ii) Crushing** - Vegetable oils, for example cottonseed oil, ground nut oil, are extracted from oils seeds by crushing followed by pressing in a hydraulic press. The residue called oil cake is used as cattle food.

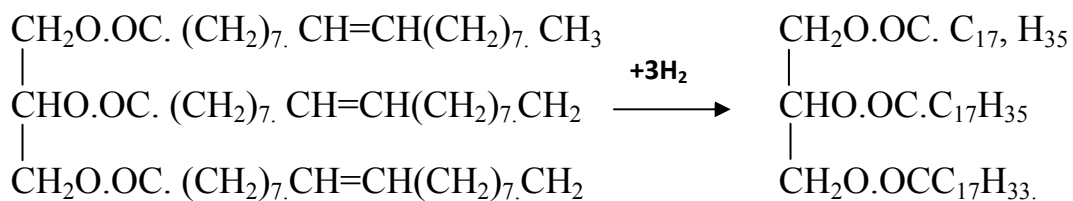
**(iii) Extraction with solvents** - Fats and oils being soluble in organic solvents e.g. Petroleum ether, are more carefully extracted by means of these.

### 11.3 PROPERTIES AND USES OF OILS AND FATS

**Properties:** Physical. When pure, these are colorless, odorless, neutral liquids or solids. They are lighter than water and immiscible with it but dissolve in organic solvents, e.g., ether and benzene. When agitated with water in the presence of soap, gelatin, etc. (emulsifiers) they form emulsions.

**Chemical (i) Hydrolysis.** Oils and fats are hydrolysed when heated with water alone or in the presence of acids and yield glycerol and higher fatty acids. With alkalis they give glycerol and soap.

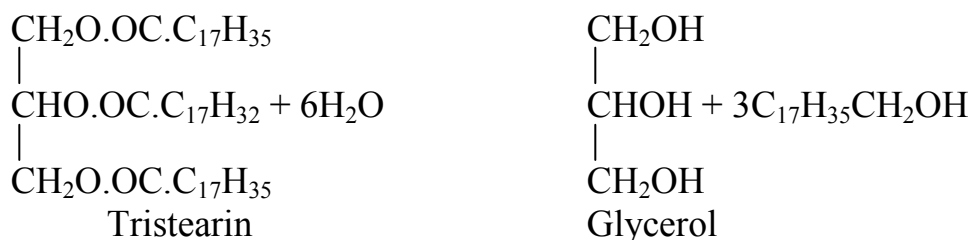
**ii) Hydrogenation.** Oils are glycerides of unsaturated fatty acids. These are changed to solids fats when hydrogen gas is passed into them under pressure and in the presence of finely-divided nickel as a catalyst. For example,



Triolein (m.p. 256K)

Tristearin (m.p. 333 K)

**(iii) Hydrogenolysis.** On passing excess of hydrogen through an oil or fat, it yields glycerol and a higher alcohol. For example,.



This splitting up of the fat molecule by hydrogen is called hydrogenolysis.

**(iv) Drying.** Certain oils like linseed oil change into hard solids on exposure to air. These are called Drying oils and find use in paint and varnish industry. Drying is catalyzed by litharge and various other metallic oxides. Some other oils like cottonseed oil thicken slowly and contain a smaller percentage of the glycerides of unsaturated acids than the drying oils. These are called semidrying oils.

Drying involves oxidation, polymerization and colloidal gel formation. The mechanism of the process is, however, complicated and not definitely known.

**(v) Rancidification.** The unpleasant smell which fats and oils develop on long exposure to moist air is due to rancidity. This results from partial saponification (hydrolysis) which sets free strongly smelling fatty acids.

For example, butter on hydrolysis yields volatile fatty acid having unpleasant odour.

Another form of rancidity is due to oxidation of unsaturated fats promoted by heat and light. The oxidation yields aldehydes and acids which have a strong smell.

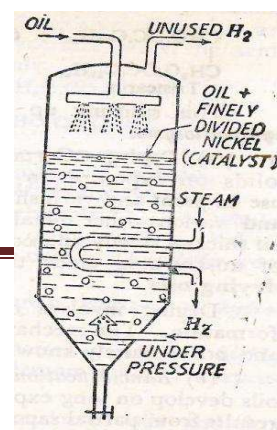
**Uses.** These are largely used (i) as articles of food, (ii) for toilet purposes, (iii) in medicine, (iv) as lubricants, (v) as illuminants, and (vi) in the manufacture of soap, glycerine and paints.

---

## 11.4 HYDROGENATION OF OILS

---

Generally liquid oils used for cooking purposes. Accordingly, millions of kilograms of groundnut oil or cottonseed are changed to solid edible fat each year by hydrogenation in the presence of a suitable catalyst. Hydrogenation converts only a part



oil  
of

the glycerides of unsaturated acids into those of saturated acids. Different steps involved in the actual manufacture of vegetable ghee are :

**(i) Removal of Free Acids.** The oil is warmed in a pan and treated with a calculated quantity of sodium hydroxide to neutralize the free fatty acids. The salts formed as a result of neutralization come up in the form of a scum along with some of the suspended matter.

**(ii) Bleaching.** The oil from the first tank is decanted into the second and treated with animal charcoal at 356K or so. The colouring matter is adsorbed by animal charcoal and the oil is filtered.

**(iii) Deodorising.** The bleached oil is treated with superheated steam for deodorising.

**(iv) Hydrogenation or hardening of oil.** The oil purified above is taken in an iron tank surrounded by heating jacket at 423-473K. Some finely divided nickel is suspended in the oil and hydrogen gas is passed in under pressure. Finely divided nickel acts as a catalyst in hydrogenation.

The hydrogenation is continued until a fat of the desired consistency is obtained. The hardened oil is taken out and freed from the catalyst by filtration. Some flavoring material somewhat resembling genuine ghee is then added to this before placing it.

---

### ***11.5 ANALYSIS OF OILS AND FATS***

---

The composition and purity of a given fat is determined by means of a number of physical and chemical tests. Various physical tests involve the determination of its physical contaminants such as melting point, specific gravity and refractive index. Various chemical tests which give an indication of the type of fatty acids present in the fat or oil are :

**(i) Acid value:** It is the number of milligrams of potassium hydroxide required to neutralize 1 g of the fat or oil. The acid value indicates the amount of the free acid present in the fat or oil.

To determine acid valued, a weighed quantity of the fat is dissolved in alcohol and titrated against a standard alkali using phenolphthalein as indicator.

**(ii) Saponification Value:** It is the number of milligrams of potassium hydroxide required to neutralize the fatty acids resulting from the complete hydrolysis of 1 g of the oil or fat.

To determine the saponification value, a weighted quantity of the given fat is refluxed with a known volume of standard alcoholic potash solution. The unused alkali is then titrated against some standard acid. Saponification value of coconut oil is about 250 while for Olive oil, it is about 200.

**(iii) Iodine Value:** It is the number of grams of iodine which combine with 100 grams of oil or fat. It indicates the degree of unsaturation of acids in the fat or oil.

In Hubl's method for the determination of iodine value, a known weight of oil or fat is dissolved in carbon tetrachloride and treated with a known volume of standard solution of iodine and mercuric chloride in ethanol. The unused iodine is titrated against an standard thiosulphate solution.

**Table- Saponification number and Iodine number of some fats**

	<b>Saponification number</b>	<b>Iodine number</b>
Coconut fat	250-260	8-10
Butter fat	210-230	26-28
Tallow	190-200	30-48
Lard	193-200	46-70
Olive oil	187-196	79-90
Cottonseed oil	190-198	105-114
Sunflower oil	188-194	140-156
Linseed oil	187-195	170-185

**(iv) Reichert Meissl value (R/M value):** It is the number of milliliters of 0.1 N potassium hydroxide solution required to neutralize the distillate of 5 g of hydrolysed fat. It represents the amount of steam volatile fatty acids present in the oil or fat.

5 g of the fat is hydrolysed with sodium hydroxide and the mixture is acidified with dilute sulphuric acid and steam distilled when acids with carbon content up to 10 being volatile in steam distil over. The distillate is cooled and filtered and titrated against 0.1 N-alkali.

Reichert - Meissl values of some common fats and oils are:

Butter = 20; Coconut oil = 80; Cottonseed oil = Less than 1.

---

## ***11.6 CLASSIFICATION OF OILS***

---

On the basis of iodine value, the oils have been sub-divided into the following three groups 1.

**i) Drying oils:** These are oils with iodine values above 120. They harden slowly on exposure to air with which it forms a resinous solid. These are glycerides of highly unsaturated acids, e.g., linoleic and linolenic acid. Linseed oil is a typical drying oil and consists of : Linolenic acid ester (80%), Linoleic acid ester (15%) and Triolein (5%).

Tung oil (China-wood oil) is another example of an excellent drying oil.

Drying oils find use in paints and in the manufacture of oil cloth, rexis and linoleum (mixture of ground cork and boiled linseed oil rolled into sheet which hardens on standing).

**(ii) Semi-drying oils:** These are oils with iodine values 90 to 120. They thicken very slowly when exposed to air. Cottonseed oil and sesame oil are examples of semi-drying oils.

**iii) Non-drying oils:** These have iodine values less than 90. They do not thicken when exposed to air. They consist of mainly triolein. Some examples of this class are olive oil, coconut oil and castor oil.

---

## ***11.7 DISTINCTION BETWEEN ANIMAL AND VEGETABLE FATS***

---

Animal fats contain cholesterol an unsaturated alcohol with molecular formula  $C_{27}H_{46}O$ . Cholesterol forms rhombic plates (m.p. 421K).

Vegetable fats contain phytosterol which crystallizes as needles (m.p. 405-417K). This makes the distinction between animal and vegetable fats possible.

---

## 11.8 WAXES

---

These are also esters of higher fatty acids. They, however, differ from oils and fats which are glycerides of higher fatty acids in being esters of higher homologues of monohydric alcohols, e.g.,

Paraffin wax (a petroleum product) is, however, a mixture of higher hydrocarbons and thus is entirely different from natural waxes.

Waxes are used in the manufacture of boot polishes, furniture polishes and varnishes.

---

## 11.9 SOAPS AND SOAPLESS DETERGENTS

---

**i) Saponification or Soap** Common soap are sodium or potassium salts of higher fatty acids, e.g., stearic, palmitic and oleic acids. The sodium salts are termed hard soaps whereas the potassium salts give soft soap. These are obtained from oils and fats, e.g., tristearin is obtained from beef and mutton tallow, tripalmitin is present in palm oil and triolein is found in lard, olive oil and cottonseed oil. In India soap is generally manufactured from coconut oil, groundnut oil, till oil and mahua oil. If we treat tristearin with sodium hydroxide solution called lye, they react to form soap and glycerin. The process is called saponification.

**A) Manufacture of Soap:** Two processes generally employed for the manufacture of soap are:

**(1) The Hot process:** Different steps involved in the manufacture of soap by hot process are:

**(a) Saponification.** The oil or fat is taken in a giant iron-pan (soap kettle) and heated with open steam. The alkali solution 10 per cent caustic soda solution (lye) - is added in thin stream while steam keeps the mass boiling and also ensures thorough mixing. After several hours the saponification is complete and a frothy mixture of sodium salts (soap) and glycerine is obtained.

**(b) Salting out of soap:** Slight excess of the alkali in the reaction mixture indicates that saponification is complete, Common salt or brine is then added to precipitate soap and heating is continued. After some hours of heating, soap forms the upper layer as thick mass. This is called salting out of soap.

**(c) Finishing:** The soap so obtained is boiled again with caustic soda for complete saponification of any unsaponified fat and the spent lye again drawn off. The solid soap is next boiled with water to dissolve out the excess alkali and allowed to settle when the impure soap called nigre form layer. The upper layer of pure soap is transferred through a swing pipe to a steam jacketed tank called crutcher.

Then it is shredded into small chips, dried to the requisite moisture content and mixed with colouring matter and perfumes. In the case of laundry soap some fillers, e.g., rosin, sodium silicate, borax and sodium carbonate, are also added. These have some detergent value and are cheaper than soap.

It is next run into moulds and permitted to solidify. The bigger blocks are cut into slabs by means of steel wires. The slabs are finally cut into cakes of desired size and stamped.

**(2) The cold Process:** The oil or the molten fat is taken in an iron pan little with a stirrer and treated with caustic soda solution (Lye). The charge is stirred until the soap begins to set. It is solidified in frames and cut into slabs as given above. All the glycerine set free remains in the soap. Usually starch or some other filling material is thoroughly mixed with the oil prior to the addition of caustic soda. The usual proportions of the various ingredients are: alkali (1 part), water (7 parts) and starch (1 part). The process is, however, not as economical as the hot process and does not yield pure stuff. The hot process is, therefore, decidedly superior to this.

**(3) Modern Process:** In the processes, recently developed fat is hydrolysed with hot water under pressure in the presence of catalyst, e.g., dilute sulphuric acid and aromatic sulphonic acids. The free acid obtained as a result of hydrolysis, is neutralized with caustic soda or sodium carbonate. The methods are cheaper and simpler.

Large-scale apparatus built for continuous hydrolysis of fats consists of a tower about 65 feet high. Fat is introduced into the tower at the bottom while hot water at about 523 K enters at the top. Fat rises up through water and gets hydrolysed in the presence of a catalyst which is also added.

Fatty acids from the top of the tower are neutralized to soap in a continued for recovery of glycerol.

---

### 11.10 SOME SPECIAL VARIETIES OF SOAP

---

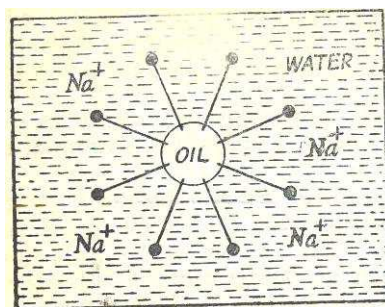
There are many kinds of soap e.g., floating soaps made by pumping in large quantities of air into soap in a crutcher while it is in the creamy stage. Transparent soap may contain glycerol or alcohol and may be obtained by dissolving soap in alcohol and evaporating the solvent. Medicated soaps contain some substances of medicinal value added to them, e.g., neem soap, carbolic soap. Shaving soaps are potassium sodium stearates (which produce lasting lather) containing gum and glycerine to prevent rapid drying of lather.

---

### 11.11 CLEANSING ACTION OF SOAP

---

Soap has two dissimilar ends. At one end is the hydrocarbon chain which is non-polar and oil-soluble (lyophilic or lyophilic) whereas at the other end is the carboxylate ion which is polar and water soluble (hydrophilic).



When soap is added to water, its molecules make a unimolecular film on the surface of water with their carboxyl groups embedded in water and the hydrocarbon chains standing on end to form a hydrocarbon layer.

When a cloth with dirty spots is soaked with soap solution, soap dissolves the dirt (fat or oil with dust etc. adsorbed in it) by forming micelles in which oil or fat is at the centre of the sphere with fat-soluble hydrocarbon chain of soap dissolved in it. The water-soluble carboxylate ions make a hydrophilic surface around this sphere around this sphere and render the entire aggregate containing oil or fat water soluble which is washed away.

It has been observed that soap tends to concentrate on the surface of solution and, therefore, lowers its surface tension which causes foaming. This helps it to penetrate the fabric.



It emulsifies fat in dirt forming micelles and renders all the micelles water-soluble. The dirt is thus washed away by water.

---

## 11.12 SYNTHETIC DETERGENTS

---

Development of synthetic detergents is a big achievement in the field of cleansing. These possess the desirable properties of ordinary soaps and can be used with hard water and also in acidic solution. These are salts of sulphonic acids or alkyl hydrogen to soap which are salts of carboxylic acids. Their calcium or magnesium salts are soluble in water.

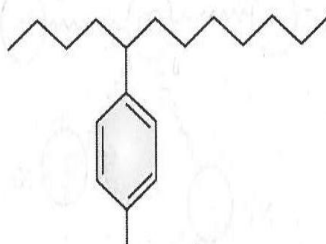
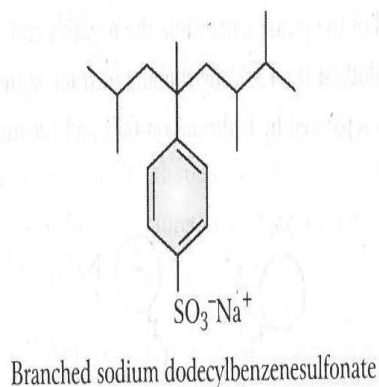
### a. Classification of Detergents

Detergents are classified into three broad groupings, depending on the electrical charge of the surfactants.

#### i) Anionic Detergents

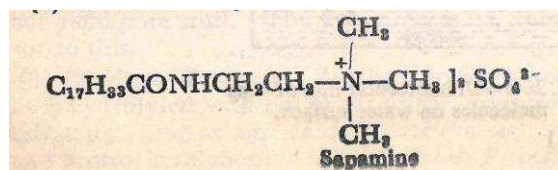
Typical anionic detergents are alkylbenzenesulphonates. The alkylbenzene portion of these anions is hydrophobic and the sulphonate is hydrophilic. Bile acids, such as deoxycholic acid (DOC), are anionic detergents produced by the liver to aid in digestion and absorption of fats and oils.

**Some of anionic detergents:** a branched sodium dodecylbenzenesulphonate, linear sodium dodecylbenzenesulphonate, and soap are shown below.

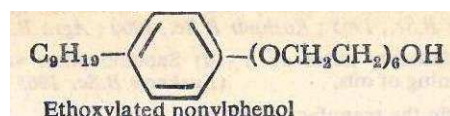


**ii) Cationic Detergents**

Cationic detergents are similar to the anionic ones, with a hydrophobic component, but instead of the anionic sulphonate group, the cationic surfactants have quaternary ammonium ion as the polar end. The ammonium center is positively charged.

**iii) Non-Ionic and Zwitterionic Detergents**

Non-ionic detergents are characterized by their uncharged, hydrophilic head groups. Typical non-ionic detergents are based on polyoxyethylene or a glycoside. Zwitterionic detergents possess a net zero charge arising from the presence of equal numbers of + and - charged chemical groups.




---

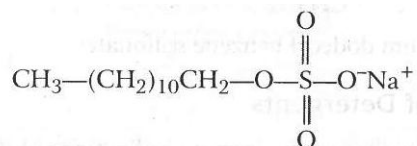
**11.13 METHODS OF PREPARATION**


---

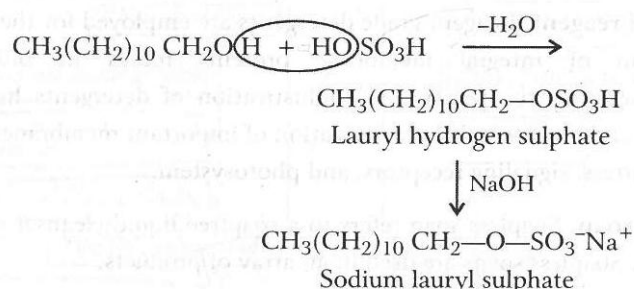
The synthetic detergents are substitutes of soaps. These are also called syndets.

Their development is a recent innovation but syndets have already replaced about 75-85% of the world's demand for soap. The two chief types of detergents are:

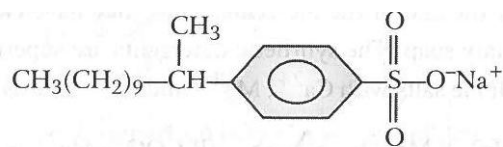
1. **Sodium Alkyl Sulphates:** One of the chief examples is sodium lauryl sulphate.



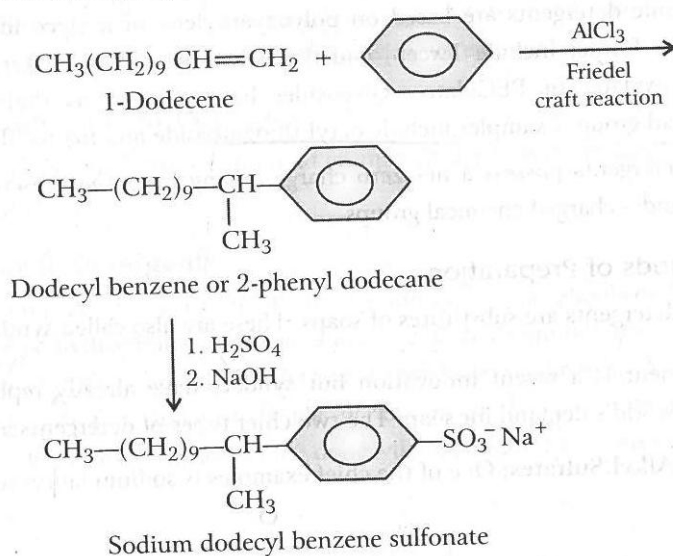
Sodium lauryl sulfate, one of the earliest synthetic detergents, is made from lauryl alcohol obtained by the hydrogenolysis of fats. The hydrogenolysis of fats is discussed earlier in this chapter.



2. **Sodium Alkylbenzenesulphonates:** Sodium dodecylbenzenesulphonate is one example of the sulphonate category detergent.



Sodium dodecyl benzene sulphonate is produced from 1-dodecene by Friedel-Crafts reaction.



---

## 11.14 APPLICATION OF DETERGENTS

---

- 1. Laundry detergents:** One of the largest applications of detergents is for cleaning clothing. In general, laundry detergents contain water softeners, surfactants, bleach, enzymes, brighteners, fragrances, and many other agents. The formulation is strongly affected by the temperature of the cleaning water.
- 2. Biological reagent:** Reagent Grade detergents are employed for the isolation and purification of integral membrane proteins found in biological cells. Advancements in the purity and sophistication of detergents have facilitated structural and biophysical characterization of important membrane proteins such as transporters, signaling receptors, and photo system.
- 3. Soapless soap:** Soapless soap refers to a soap free liquid cleanser with a slightly acidic pH. Soapless soaps are used in an array of products.

Synthetic detergents have wonderful dirt dissolution properties but some of them have very low biodegradability. They are resistant to bacterial attack and are not fully degraded in sewage treatment plants. Their discharge into the river causes a serious pollution problem.

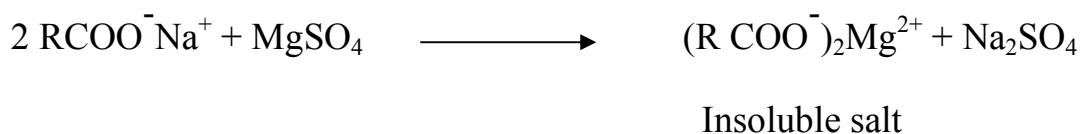
Detergents can also be considered as wetting agents which lower the surface tension of water and act as cleansing agent as explained above in the case of soap. These can be used for delicate fabrics as they do not hydrolyse to give hydroxyl ions and work equally well with hard and soft water.

---

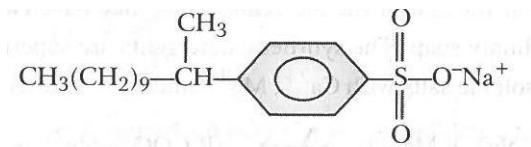
## 11.15 SYNTHETIC DETERGENTS VERSUS SOAPS

---

Like soaps, synthetic detergents have a non polar hydrocarbon chain and a highly polar group like sulphonate at the end of the molecule. Thus they have cleansing power more efficient than an ordinary soap. The Synthetic detergents are superior to soaps because they do not form insoluble salts with  $\text{Ca}^{2+}$ ,  $\text{Mg}^{2+}$ , and  $\text{Fe}^{2+}$  and  $\text{Fe}^{3+}$  ions as soaps do.



Detergents forms soluble salts with hard water



Soluble salt

Thus detergents can be used in either soft water or hard water, while ordinary soaps are precipitated in hard water and go waste. A comparative study of soaps and detergents is shown below:

Soap	Detergent
1. Sodium and Potassium salts of higher fatty acids (carbon atoms 12 + or higher)	1. Are sodium and potassium salts of sulphuric acids of alkenes.
2. Works well with Soft Water to clean cloths.	2. Works well with hard water and can be used in Saline or acidic water.
3. Soaps are 100% bio degradable	3. Detergents are not fully bio degradable.
4. These are cheaper and easily available.	4. These are most expensive than soap.

### Candles:

Mixture of fatty acids obtained by hydrolysis of fats with superheated steam is heated to 333K and pressed when liquid acids are separated. The solid cake obtained is known as stearin and is mainly a mixture of stearic and palmitic acids. Stearin is mixed with about 90% paraffin wax and melted. The molten mass is poured into metal tubes each carrying a cotton thread stretched along its axis. On cooling the mixture solidifies and candles are obtained.

---

### 11.16 SUMMARY

---

As mentioned earlier fats and oils act as storage of energy in plants and animals. As for weight is concerned, storage of fat is the most economical way for the body to maintain the

reserve energy supply. In this unit we discuss about vegetable and animal fat, their acid value, saponification etc. We also studied soaps and detergents. In this unit classification of fats and oil with their acid value iodine value and soap manufacture also explained.

---

### ***11.17 TERMINAL QUESTIONS***

---

1. What are oils and fats? Define the various oil constants and state their significance in significance and evaluating the quality of oil.
2. Write explanatory notes on (a) saponification value (b) iodine value and (c) Hardening of oils.
3. Give briefly the manufacture of soap.
4. Define saponification value of a fat explain its significance.
5. Write notes on - (a) Hydrogen action of oils (b) iodine value (c) cleansing action of soap.
6. Whats are detergents? How do they differ form soap? Characterize the structural feature necessary to make a good detergent.
7. Whats are synthetic detergents? Why they are soopless soap?
8. Explain soap and detergents.
9. Idintify some of the detergents used in shampoos and dish washing liquids. Are they primarily anionic neutral or cationic detergents?
10. Write the structural formula and names of any their common fatty acids.

---

## UNIT-12 SYNTHESIS DYES

---

### CONTENTS

- 12.1 Objectives
- 12.2 Introduction
- 12.3 Dyes and dyeing
- 12.4 Colour and constitution
- 12.5 Valence bond theory of colour
- 12.6 Classification of dyes
- 12.7 Summary
- 12.8 Terminal Question
- 12.9 Answers

---

### ***12.1 OBJECTIVE***

---

Colour has always played an important role in the life of human being. Dyes and pigments have been important articles of commerce since time immemorial let us understand how do, we get a sensation of colour.

As white light is made of seven different colours. These are violet, indigo, blue, green, yellow, orange and red having wave length between 400nm and 750nm. In this unit we discuss about the relationship between the wave length of the light bond absorbed and visible colour of the substance. We should studied in dye and colour constitution, also for the knowledge of different type dyes and their made of applications, this play very important role in dyes industry. Few of then like Congo red directly used on cotton fabrics. Bismark brown mainly consits of II with small amount of I, used in boot polish and for staining wood before polishing, it is a direct dye for dyeing wool. Similarly phthalein dyes are used also as indication is a dye used for dyeing wool or for preparing red ink. Mercurochrome is an intense red dye and its 2% solution is used as an antiseptic. The objectives of this unit are to given ideal to student about the impotence, constitution, classification and process of making different dyes.

---

## 12.2 INTRODUCTION

---

A dye is a coloured substance that has an affinity to the substrate to which it is being applied. The dye is generally applied in aqueous solution and may require a mordant to improve the fastness of the dye on the fiber. Both dye & pigment are coloured because they absorb some wavelength of light more than others. In contrast to dyes, pigments are insoluble and have no affinity for the substrate. Some dyes can be precipitated with an inert salt to produce a lake pigment and based on the salt, used they could be aluminium lake, calcium lake or borium lake pigments. These dyes may be natural or synthetic. The first human made organic aniline dye, mauveine, was discovered by William Henry Perkin in 1856. Many thousands of synthetic dyes have since been prepared.

One other class that describes the role of dyes rather than their mode of use, is the food dye. Because food dyes are classed as food additives, they are manufactured to a higher standard than some industrial dyes. Many are azo dyes, although anthraquinone and triphenyl methane compounds are used for colour such as green and blue. Some naturally occurring dyes are also used.

Weave length absorbed	Colour absorbed	Visible colour (Complementary)
400-435	violet	yellow-green
435-480	blue	yellow
480-490	green-blue	orange
490-500	blue-green	red
500-560	green	purple
560-580	yellow-green	violet
580-595	yellow	blue
595-605	orange	green-blue
605-750	red	blue-green

When the white light is totally reflected, the substance appears white and when it is totally absorbed, the substance appears to be black. When a part of the incident light is absorbed and the rest reflected the colour of the substance is the colour of the reflected light. If only a single band is absorbed, the colour of the substance is the complementary colour of the absorbed light band. Relationship between the wave lengths of the light band absorbed and the visible colour of the substance is given in the table below:



If only one of the bands is reflected and all the rest are absorbed, the colour of the substance is that of the reflected band. For example, if a substance absorbs all the bands except blue, it will appear blue. Thus the substance may appear blue -

- i) Either because it absorbs only the yellow band (wave length nm) of the incident white light and reflects all the rest,
- ii) Or because it absorbs all the bands except blue (wavelength 435-430 nm) which it reflects.

In practice, substances do not reflect only one band of wavelengths but reflect a mixture of them. For example, malachite green reflects in addition to green light, small amounts of red, blue and violet.

---

### ***12.3 DYES AND DYEING***

---

Coloured substances used for coloring various fabrics are called dyes. All coloured substances, however, are not dyes. Requisites of a true dye are:

- (i) It must have a suitable colour.
- (ii) It must be able to attach itself to the material from solution to be capable of being fixed on it.
- (iii) When fixed it must be fast to light and washing. For this it must be resistant to the action of water, acids and alkalis, particularly the latter due to the alkaline nature of washing soda and washing soap.

Previously, dyes were obtained from animal and vegetable sources. Today most of available dyes are synthetic dyes prepared from aromatic compounds.

The mechanism of dyeing differs with the nature of the material whether it is protein, cellulose or synthetic fiber. Dyeing of wool and silk was once considered to be a chemical process. Here in the acidic or basic groups in a dye combined with basic or acidic groups in the protein. At present it is believed that acidic or basic groups to the dye help in the initial

adsorption of the dye on the surface of the fiber. This is followed by solution and diffusion of the dye into the fiber.

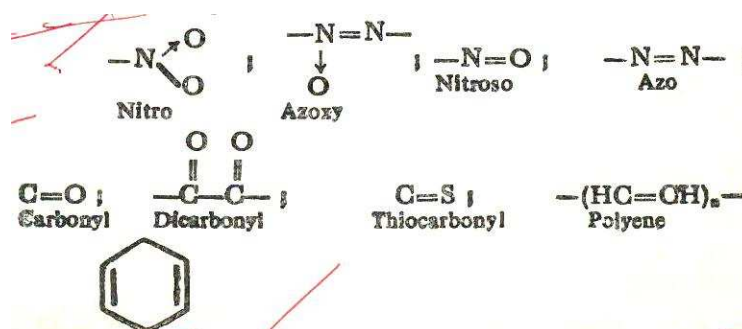
## 12.4 COLOUR AND CONSTITUTION

It was observed by Graebe and Liebermann (1868) that organic coloring matter on reduction gave colorless product which regained colour on oxidation.

The relationship between colour and constitution was, however, pointed out for the first time in 1876 by the German chemist Otto Witt. He put forward his chromophore auxochrome theory of colour and constitution. According to him -

- i) Colour usually appeared in an organic compound when it contained certain which should more appropriate be called groups with multiple bonds.

With called these groups with multiple bonds as chromophores. A few important chromophore are:



- ii) The compound containing the chromophoric group is called chromogen. It has been noticed that chromogens containing only one chromophore are usually yellow. Depth of the colour increases with the number of the chromophores.

A single  $\text{C} = \text{C}$  group, as in ethylene ( $\text{CH} = \text{CH}$ ) does not produce any colour. The colour, however, develops if a number of these groups are present in conjugation. For example, is yellow in colour.

- iii) Certain groups, which could not cause any colour effects in the absence of chromophore groups, do have an important effect on the development of colour when they are introduced into a compound containing a chromophore group. Witt described such groups as auxochromes or colour augmenters or deepeners.

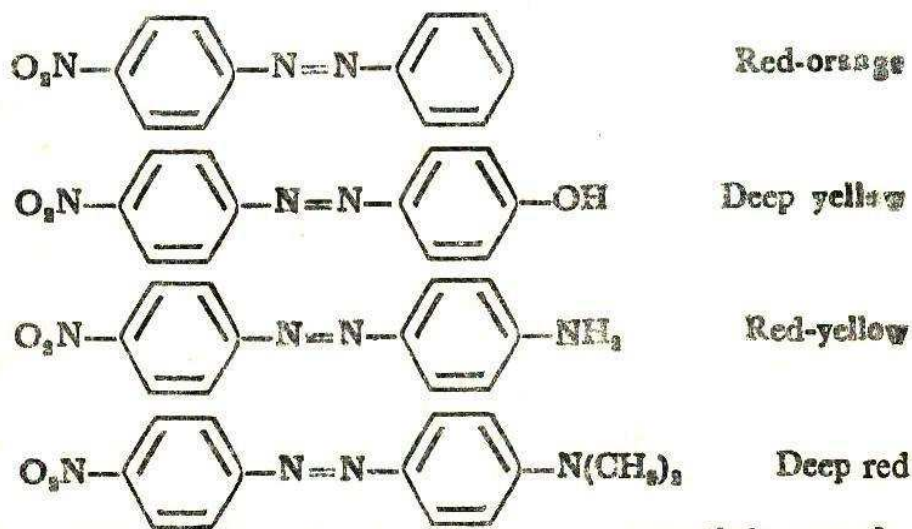
Some important auxochromes are :



Auxochromes are salt - forming groups and perform two functions.

- They deepen the colour of the chromogen.
- Their presence is necessary to make the chromogen a dye.

An interesting example of the effect of auxochrome groups may be noted with the following compounds:



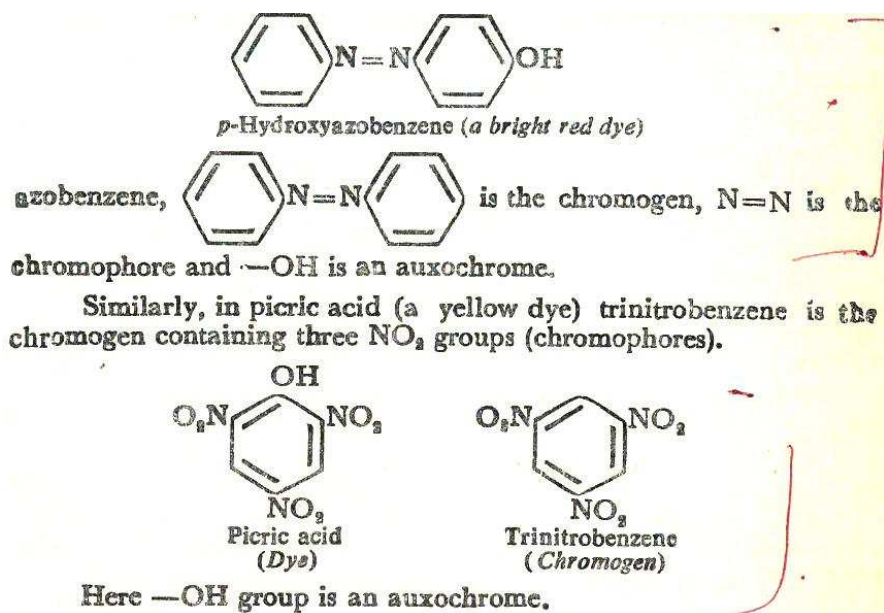
The sulphonic and carboxyl acid groups possess little auxochromic properties but their presence makes chromogen a dye. Due to the presence of carboxyl acid group several dyes form lakes.

From practical experience, several empirical observations have been made. For example, in the case of phenols it has been observed that

- Salts of phenols are more strongly coloured than free phenols from which they have been made.
- Auxochromes do not affect the colour when present in the position to the chromophore.

Thus according to witt's theory of colour and constitution.

**Chromogen:** is a chromophore-bearing compound, and the dye can be considered to be equivalent to a chromogen containing an auxochrome. For example, in p-hydroxy azobenzene.



Some other terms introduced later are called bathochromic and hypsochromic groups. The bathochromic groups bring about deepening of colour in a dye whereas the hypsochromic groups bring about the lightening of colour. The term deepening of colour in dye chemistry is being used for the following changes in colour:

***Yellow - orange - red - purple - blue - green - black***

This is exactly the order of visible complementary colours of the colour absorbed with increase in the wave lengths of the absorbed light. Thus we have seen that longer the wavelength of the absorbed light, the deeper will be the colour of the dye.

Since visible colour is a complementary colour of the absorbed band, bathochromic groups (which bring about deepening of colour) will help absorption of longer wavelengths, i.e. the colour absorbed will be one lying near the lower or red end of the column. The bathochromic groups are, therefore, said to have a red shift.

On the other hand, hypsochromic groups (which bring about lightening of colour) will help absorption of shorter wavelengths, i.e., the colour absorbed will be one lying near the upper or blue end of the column. The hypsochromic groups are, therefore, said to have a blue shift.

---

## 12.5 VALENCE BOND THEORY OF COLOUR

---

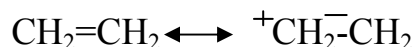
According to the valence bond theory, the electron pairs of a molecule in its ground state are in a state of oscillation. When this molecule is placed in the path of a beam of light, it absorbs a photon of appropriate energy and gets excited and the amplitude of oscillation of its electron pair is increased. The wavelength of the photon absorbed depends on the energy difference between the excited and ground states of the molecule. The smaller the difference between the two states, the longer is the wavelength of the photon absorbed. It further states that

- i) The energies of both the ground and excited states are lowered as a result of resonance among the charged structures.
- ii) Charged structures contribute more to the excited state than the ground state.
- iii) The larger the number of electrons involved in resonance, the smaller is the energy difference between the excited state and the ground state.

Ethylene is colourless but a polyene is coloured. In fact, intensity of colour increases as the number of double bonds in a molecule increases. Let us understand this fact in the light of valence bond Theory.

Ethylene is colourless but a polyene is coloured. In fact, intensity of colour increase as the number of double bonds in a molecule increases. Let us understand this fact in the light of valence bond theory.

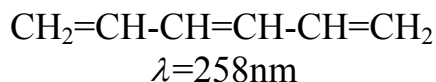
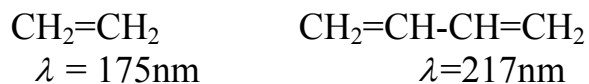
Ethylene may be regarded as a resonance hybrid of (I) and (II)



Ground state of ethylene is represented predominantly by (I) and the excited state by (II). The energy difference between the two beings very large, the energy of the photon required to excite ethylene is very high, i.e. its wavelength is very short. The colour produced by absorption of these very short wavelengths will be very light.

In 1, 3 butadiene and 1, 3, 5-hexatriene, there is greater contribution of charged structures to the resonance hybrid due to extended conjugation in these molecules. Since larger number of

electrons are involved in resonance, the energy difference between the ground and excited states is smaller and longer wavelength of the photon is required to excite the molecule, e.g.,



nm stands for nanometers,  $1\text{nm}=10^{-9}$  meter

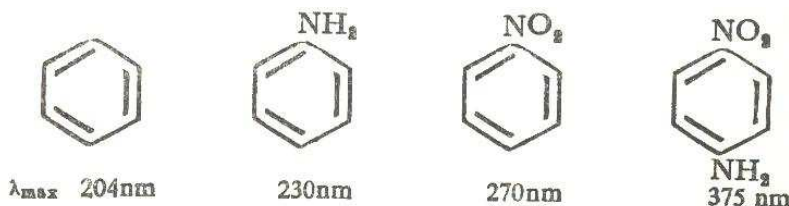
The longer the wavelength of the photon required for excitation, the greater the tendency for colour.

Presence of groups with inductive and resonance effects at the ends of a conjugated system will extend the conjugation as well as increase the contribution of charged structures to the resonance hybrid. As a result of it, the wavelengths of the photons required produce sensation of colour and become longer as illustrated by the following examples:

Benzene is a resonance hybrid of two Kekulé structures and small amount of charged cononical structures (dipolar ions).



The benzene itself is a chromophore. Presence of certain groups like  $\text{NH}_2$ ,  $\text{NO}_2$ , etc., increases the wavelength of the photon required for excitation of the molecule, e.g.,



Resonance in a conjugated system is maximum when the system is completely planar or almost so. If resonance is inhibited due to some steric effects, the depth of colour which depends on resonance will diminish and the compound may even become colorless.

The valence bond theory of colour and constitution has now been modified by the molecular orbital theory which considers molecule as a whole for its contribution to the colour and it has been possible to theoretically calculate the max of a dye from its structure. The detailed discussion of the molecular orbital theory of relationship of colour with constitution is outside the scope of this unit.

---

## ***12.6 CLASSIFICATION OF DYES***

---

Dyes are classified according to their chemical constitution or by their application to the fiber. The chemist prefers to classify dyes according to its structure but the dyer is mainly concerned with the reaction of dyes towards the fiber being dyed. Based on these two ways of classification, different forms of dyes have been described below:

### **A) Classification of dyes according application**

(1) **Direct or Substantive Dyes:** A compound is classified as a direct dye if it can be applied directly by immersing the animal and vegetable fibers or cloth in a hot solution of the dye in water.

Dyes suitable for dyeing animal fibers directly are subdivided into acid dyes and basic dyes.

(a) Acid dyes are sodium salts of sulphonic acids and nitro-phenols and can readily dye animal fibres (wool and silk) but not vegetable fibers. Wool and silk are dyed by dipping in the solution of acid dyes after acidifying with sulphonic or acetic acid.

(b) Basic dyes are the salts of colour bases with hydrochloric end or zink chloride. Basic dyes can dye animal fibres directly and vegetable fibres after these have been mordanted with tannin. Basic dyes are mostly used for dyeing silk and cotton.

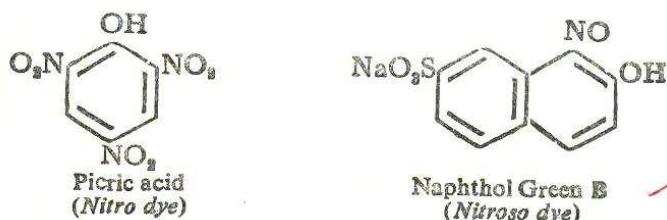
(2) **Mordant or Adjective dyes:** A mordant is any substance which can be fixed to the fiber and which can be dyed later on commonly used mordents are hydroxides or basic salts of chromites, aluminum or iron. Tannic acid is used as mordant with basic dyes. The fabric is mordant by dipping into the dye when coloured lake is obtained which being insoluble is fast to washing. Alizarin and other anthraquinone dyes are applied in this way.

(3) **Ingrain Dyes:** These are dyes produced in the fiber itself during the process of dyeing. For example, a piece of cloth may be soaked in an alkaline solution. Coupling takes place to produce an azo-dye in and on the fiber.

(4) **Vat Dyes:** These are water-insoluble coloured impounds which can be reduced to colorless (leuco) derivatives which are soluble in alkali and readily get reoxidized to the dye. After treatment in an alkaline bath the cloth is subjected to air oxidation which causes a return to the insoluble coloured form. Vat dyes in the causes a return to the insoluble coloured from Vat dyes in the leuco condition dye both animal and vegetable fibers directly but they are mostly used for cotton fibers. Indigo is an outstanding example of vat dye.

## B) Classification of Dyes According to Chemical Structure:

(1) **Nitre and Nitroso Dyes:** These dyes are among the oldest synthetic dyes but are not important commercially. A few examples are:

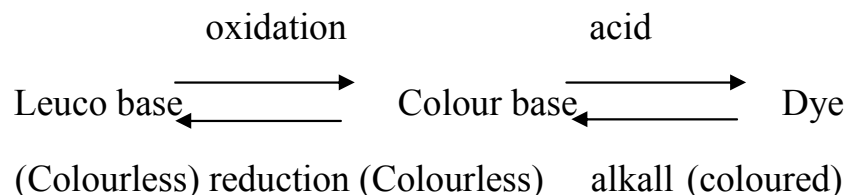


(2) **Triphenylmethane Dyes:** Triphenylmethane dyes have brilliant colours but they fade with washing and on exposure to light. These are used for colouring paper and typewriter ribbons.

These dyes are obtained by introducing -NH<sub>2</sub>, -NR<sub>2</sub>, or ----- OH groups, (auxochromes) into the triphenylmethane ring (chromogen) when the colorless leuco compound is obtained. The leuco compound on oxidation gives the corresponding tertiary alcohol called the colour base (colorless

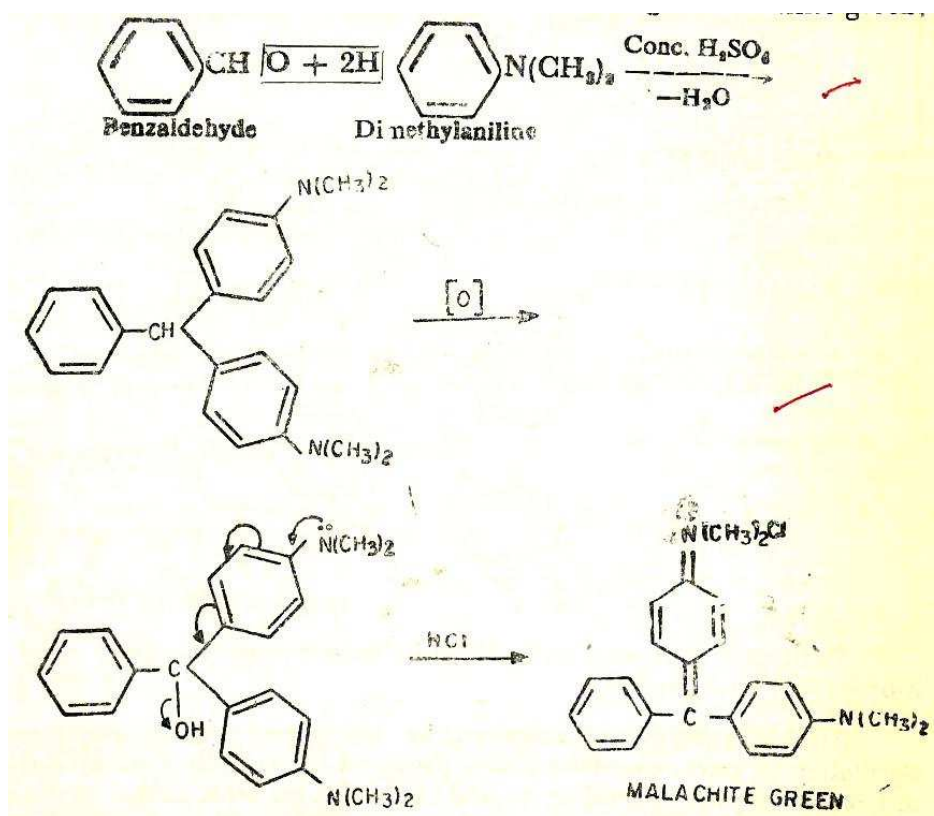


benezenoid), which in the presence of acid readily changes to the quinonoid dye due to salt formation, the changes are reversible.



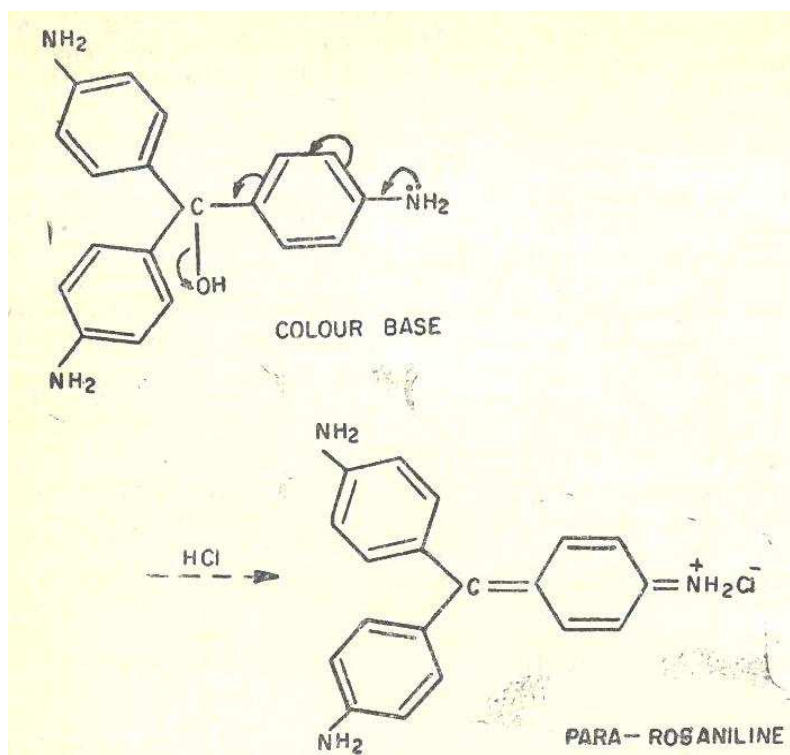
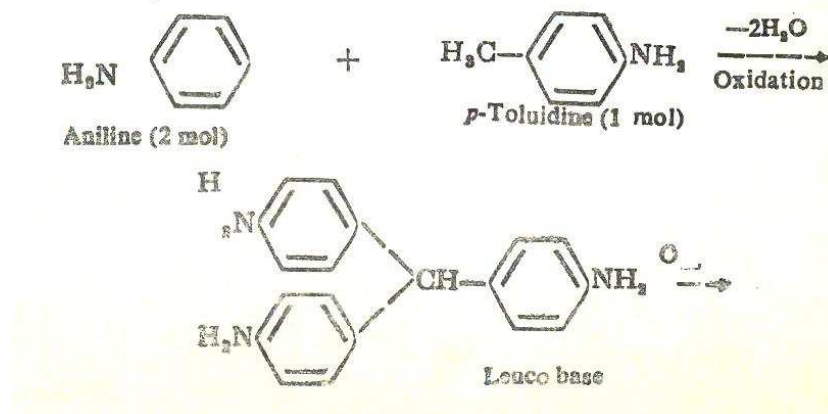
*Some important dyes of this class are:*

(i) **Malachite Green:** It is prepared by condensing benzaldehyde (1 molecule) with dimethylaniline (2 molecules) in the presence of concentrated sulphuric acid followed by oxidation of the leuco base with dioxide and hydrochloric acid to yield a colour base which reacts further with hydrochloric acid to give malachite green.



It directly dyes wool and silk but cotton can be dyed after mordanting with tannin.

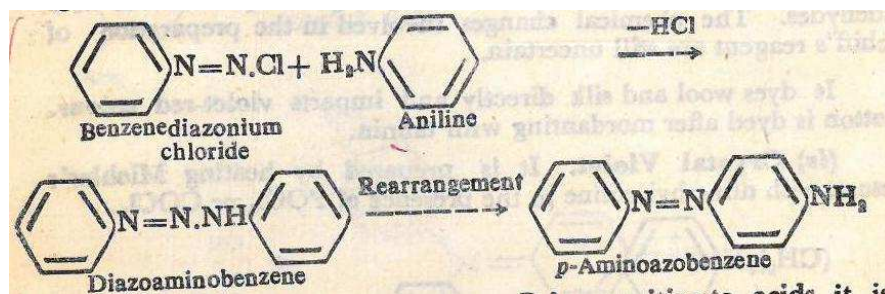
(ii) **Para resaniline:** It is prepared of a mixture of aniline (2 molecules) and p-toluidine (1 molecule) with nitrobenzene or arsenic acid.



It directly dyes wool and silk while cotton can be dyed after mordanting with tannin.

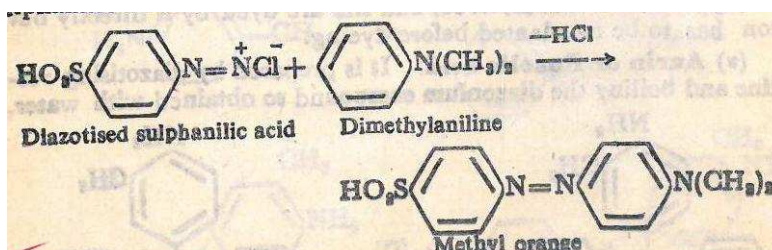
**(iii) Azo-dyes:** All azo-dyes have the same chromophore  $\text{N}=\text{N}$  the azo-group, but the auxochromes may be different. Common auxochromes are groups, Some important members of this class of dyes are:

**(a) Aniline yellow:** It is prepared by coupling benzenediazonium chloride with aniline:

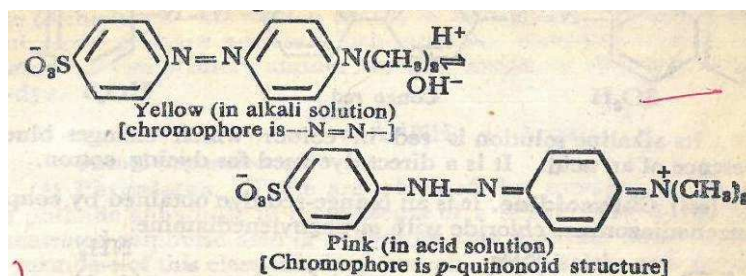


It is the simplest basic azo-dye. Being sensitive to acids it is of very little value as a dye.

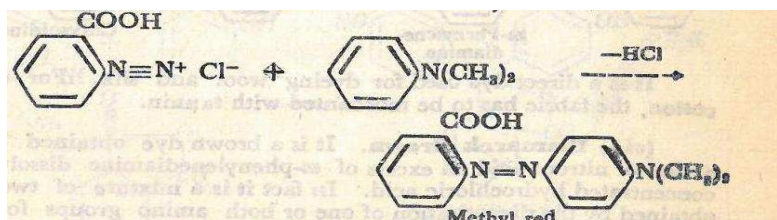
**(b) Methyl Orange:** It is prepared by coupling diazotized sulphanilic acid with dimethylaniline.



It is an acid dye. It dyes wool and silk and imparts them orange colour but the colour is not fast to light or washing. It is used as an indicator in acid alkali titrations as it gives yellow colour with alkali and pink with acid. The change in colour at the end point is due to the change in the structure of the ion.



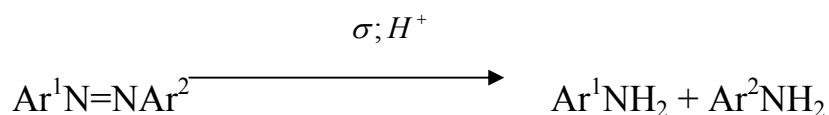
**(c) Methyl Red:** This is another acid dye prepared by coupling diazotized ortho-aminobenzoic acid with dimethylaniline.



It is used as an indicator in acid - alkali titration.

**Structure determination of azo-dyes:**

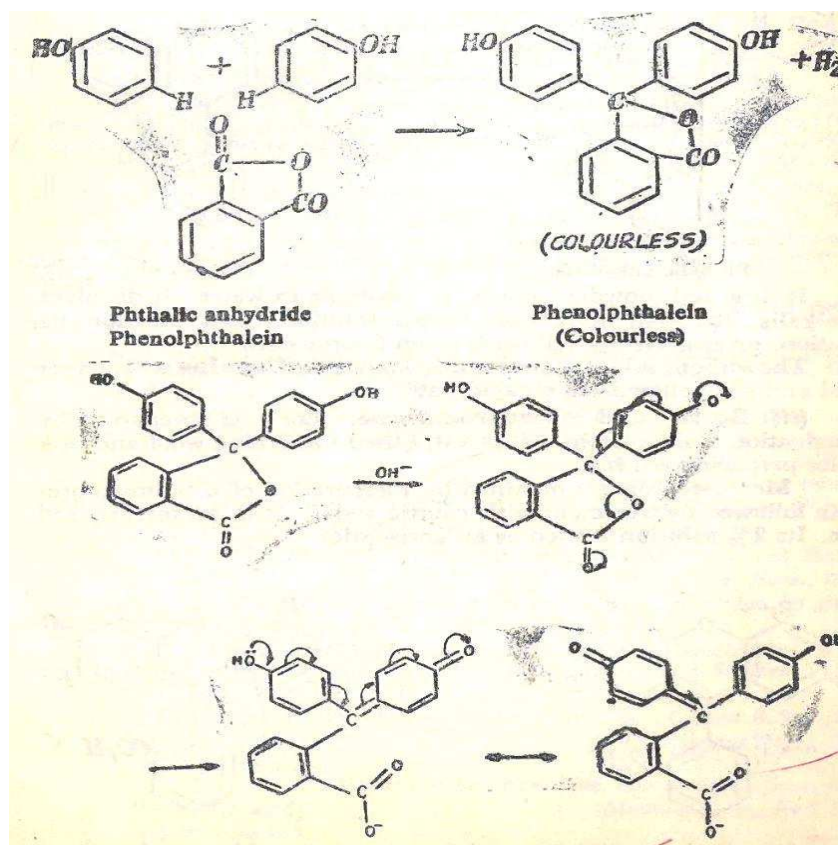
The structure of an azo-dye can be readily determined by its reduction with stannous chloride and hydrochloric acid or with sodium hyposulphite (dithionite). Reduction results in rupture of the azo group forming two primary amines which are then identified. From the structure of two primary amines we can assign a structure to the azo-dye.



Phenol (Two molecules)

(4) **Phthaleins:** These are obtained by condensing phenol with phthalic anhydride in the presence of a dehydrating agent like concentrated sulphuric acid or anhydrous zinc chloride. Some important members of this class of dyes are phenolphthalein and fluorescein which are discussed below:

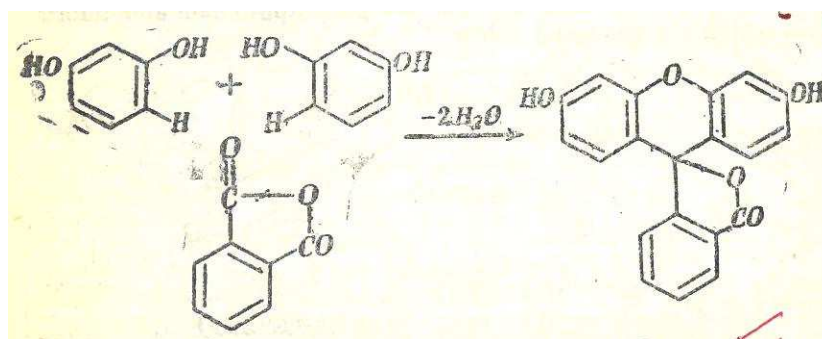
(i) **Phenolphthalein:** It is obtained by heating a mixture of phthalic anhydride (1 mol) and phenol (2 mol) with a concentrated sulphuric acid



It is a white crystalline solid insoluble in water but soluble in alcohol. With alkalis it gives a pink colour which disappears on addition of an acid. The change in colour is due to change in its structure as shown on the last page.

It is used as an indicator.

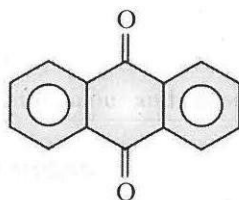
**(ii) Fluorescein:** It is obtained by heating a mixture of anhydride (1 mol) and 1, 3 benzenediol (Two molecule), conc. sulphuric acid 1,3-dihydroxy benzene (Two molecules)



It is a red powder which is insoluble in water. It dissolves in alkalis to give a reddish brown solution. On dilution its solution gives a strong yellowish green fluorescence.

### 5. Anthra quinoid dyes:

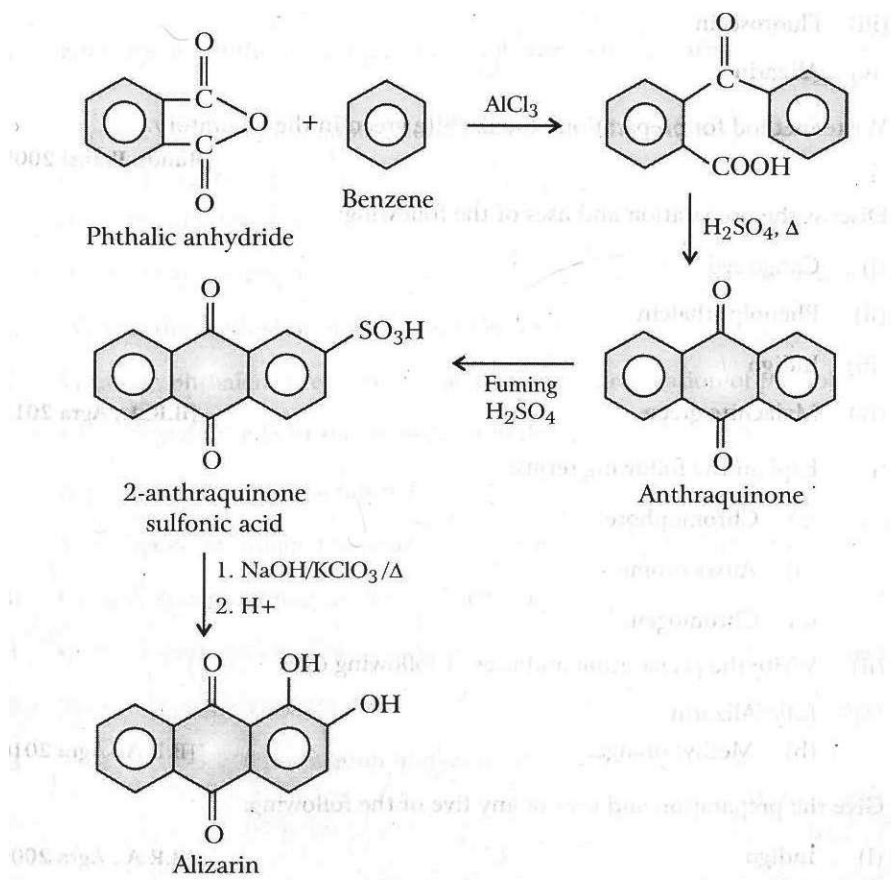
These dyes are easily identified by their p-quinoid structure, which is flanked on both sides by two benzene rings.



Alizarin is one of the most important members of this family.

### Alizarin:

It is produced by condensing phthalic anhydride with benzene in the presence of fuming  $\text{H}_2\text{SO}_4$ .

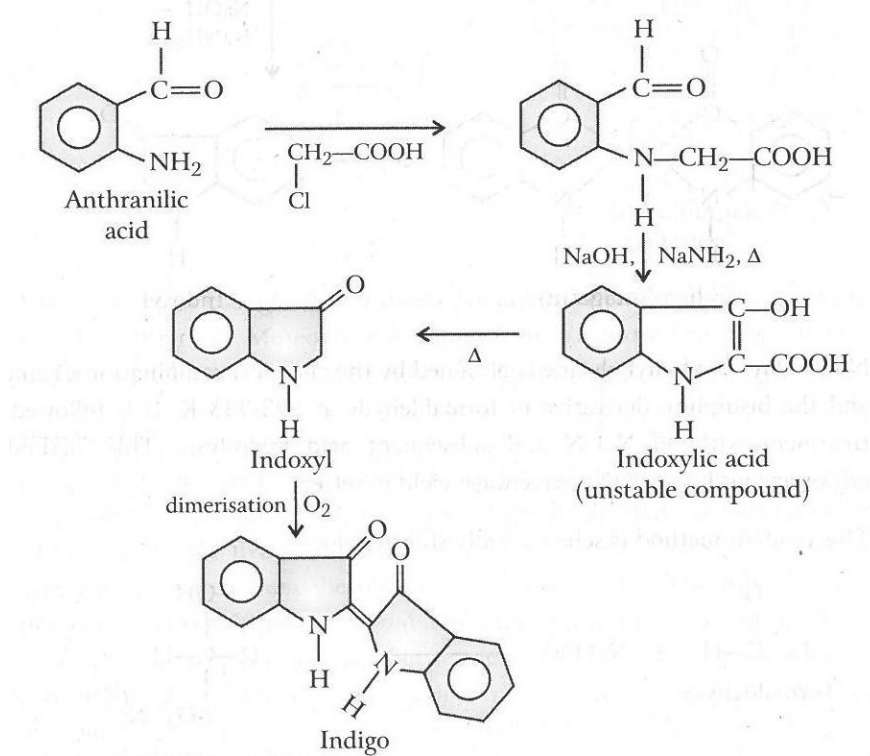


It forms a ruby red crystal. Alizarin is insoluble in water and ethanol. It is soluble in alkalis to give a purple colour solution. Alizarin is mainly used for dyeing cotton, silk, wool, paper and leather as well as for making printing inks.

## 6. Indigo

Indigo is the parent compound indigoid based dye and has been used from long time. Indigo was originally extracted from the plant of indigoera group. The leaves from these plants were covered with water and allowed to stand for several hours. Enzymes present in the plants brought about fermentation. The fermentation eventually converts indoxyl of the leaves into indoxyl which on exposure of air oxidised into indigo.

**Indigo can be synthesized as:** Anthranilic acid when treated with chloroacetic acid, it gives an intermediate, which further fused with NaOH and sodamide gives indoxylic acid. It is an unstable compound, on further decarboxylation gives indoxyl, which on oxidation and dimerisation gives dye.



Indigo is a dark blue crystalline solid. This is insoluble in water and insoluble in most of the organic solvents. It is very useful in dyeing cotton by vat process.

---

### ***12.7 SUMMARY***

---

In this unit we discussed about the electronic concept of colour and constitution according to the concept colour usually appeared in an organic compound. When it contained certain unsaturated groups which should more appropriately be called groups with multiple bonds as chromophores, also about the shifts we also studied the classification of dyes. Applications of dyes are well known so it should be studied in detail. As phenolphthalein gives different colour in different medium because of change in its structure. Similarly Bismark Brown is a direct dye for dyeing wool for dyeing cotton it has to be mordant before dyeing.

---

### ***12.8 TERMINAL QUESTION***

---

1. What is Witt's theory of colour and constitution? Illustrate its application with reference to the use of phenolphthalein as an indicator in acid alkali titrations.
2. Write short note on valence bond approach to colour.
3. a. Explain the terms direct and indirect dyes.  
b. Give the synthesis of any two of the following.  
i) Methyl orange                      ii) Malachite green                      iii) Alizarin.
4. What is a dye? What are the requisites of a true dye? How are they classified? Mention a few important members of each class.
5. Give an account of triphenylmethane dyes.
6. Write a short note on azo-dyes.
7. Explain the term chromophore chromogen, and auxochrome. What is meant by deepening of colour in dye chemistry?
8. How will you prepare the following?  
i) Phenolphthalein                      ii) Fluorescein                      iii) Indigo



9. Give the structure of phenolphthalein. Account for its colour in an acid and a strong base solution.
10. Discuss briefly the relationship between colour of organic compounds and their constitution. Explain on the basis of:
  - a) Resonance theory
  - b) Molecular orbital theory

---

## UNIT- 13 NATURAL PRODUCTS

---

### CONTENTS

- 13.1 Objectives
- 13.2 Introduction
- 13.3 Classification
- 13.4 General properties of terpenoids
- 13.5 Extraction and general methods of structure determination of terpenoids
  - 13.5.1 Limonene,
  - 13.5.2 Citral
  - 13.5.3 Alkaloids
  - 13.5.4 Nicotin
  - 13.5.5 Cocaine
- 13.5 Summary
- 13.6 Terminal Question

---

### ***13.1 OBJECTIVES***

---

A natural product is a chemical compound or substance produced by a living organism - that is found in nature. In broad sense, natural products can also be prepared by chemical synthesis (both) semi synthesis and total synthesis and have played a central role in the development of field of organic chemistry by providing challenging synthetic targets. Natural products has also been important to study as they extended for commercial/purposes to refer to cosmetics, dietary supplements and food produced from natural sources with out added. Artificial ingredients.

"These some times have pharmacological or biological activity that can be of therapeutic benefit in treating disease. For example-Terpenoid are well known natural products for essential oils having a strong and pleasant odour? Due to their pleasant odour these essential oils, have been used as perfumes since long. Some essential oils, eg. Lemon, orange and turpentine oil are almost exclusive mixtures of terpenoids.

In alkaloids; the poisonous and therapeutic properties of various plants have been known and utilized form early times, the first alkaloid (morphine) was isolated by Serturmer only in

1817 from opium, this was further following by discovery strychnine (1818), burcine (1819), quinine (1820) and many other alkaloids.

So many of the Natural products possess curative properties and are of great value in medicine. In this unit we are discuss the natural product especially terpenoid & alkaloids. Objective of this unit is the study of occurrence synthesis and chemistry of terpenoids and alkaloids.

## 13.2 INTRODUCTION

### TERPENOIDS

Terpene was employed to describe a mixture of isomeric polyhydrocarbons of the molecular formula  $C_{10}H_{16}$  occurring in the turpentine and many essential oils which are obtained from in sap and tissues of certain plants and trees. The oxygenated derivations like alcohols, aldehydes, ketones etc at that time were called camphor's.

## 13.3 CLASIFICATION

Terpenoid polyhydrocarbons with few exceptions have the molecular formula  $(C_5H_8)_n$  and the value of n have been used as a basis for the classification of terpenoids.

S.No.	Value of n	formula	classes
1.	2	$C_{10}H_{16}$	monoterpenoid
2.	3	$C_{15}H_{24}$	sesquiterpenoid
3.	4	$C_{20}H_{32}$	diterpenoid
4.	5	$C_{25}H_{40}$	sester terpenoid
5.	6	$C_{30}H_{48}$	triterpenoid
6.	8	$C_{40}H_{64}$	tera terpenoid (carotenoids)
7.	>8	$(C_5H_8)_n$	Polyterpenoids

The simpler mono-and sesqui-terpenoid and the related oxygen containing substance are highly widespread in the plant kingdom. Volatile oils contained in different parts of the plants are separated by steam distillation. These are called essential oils and have a strong and. Pleasant

odour. This oil is responsible for the odour and flavour associated with plants. Essential oils are mixtures of terpenoid hydrocarbons and their oxygenated derivatives. Some essential oils, for e.g. lemon, orange and turpentine oil, are almost exclusive mixtures of terpenoids.

Terpenoids are most widespread, chemically interesting and provide structures of great diversity. Although the majority of terpenoids occur in the plant kingdom a few of them have also been obtained from other sources.

---

### ***13.4 GENERAL PROPERTIES OF TERPENOIDS***

---

Terpenoids are lighter than water and boil between 410K and 460K. A few of them are solids these are usually lighter than water, volatile in steam usually high refractive index. These are insoluble in water but soluble in organic solvent. Most of the terpenoids are optically active.

The various general chemical properties of terpenoids are as follows:

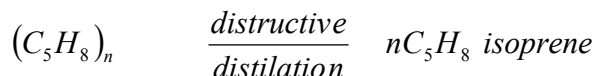
1. They are unsaturated compounds (open chain or cycles) with one or more carbon atom rings having one or more double bonds. Consequently, terpenoids undergo addition reaction with hydrogen, halogens, halogen acids etc. some of them forms hydrates. They also form characteristic addition products with  $\text{NO}_2$ ,  $\text{NOCl}$  and  $\text{NOBr}$ . These addition products are found to be useful in the identification of terpenoid. A number of addition products have antiseptic properties.
2. They undergo polymerization, also dehydrogenation in the ring.
3. As they have olefinic bonds, they are very easily oxidized nearly by the entire oxidizing agent.
4. A number of terpenoids are labile and hence readily isomerised in the presence of and into more stable forms.
5. On thermal decomposition, most of the terpenoids yield isoprene as one of the products.

#### **Isoprene Rule:**

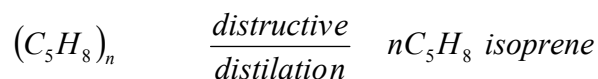
Wallach, in 1887 enunciated the famous isoprene rule, which stated as follows: "The skeleton structures of all naturally occurring terpenoids are built up of isoprene units."

From the above rule it follows that the divisibility into isoprene units is regarded as a necessary condition to be satisfied by every naturally occurring terpenoid. The isoprene rule has been deduced from the following facts.

a) The empirical formula of almost all the naturally occurring terpenoid is  $C_5H_8$ :

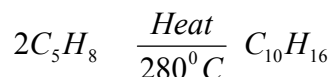


b) The thermal decomposition of almost all terpenoids gives isoprene as one of the products. For example rubber on destructive distillation field isoprene as one of the decomposition products.

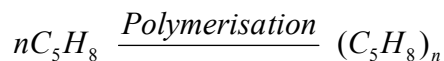


Isoprene rule has been confirmed by the fact that under special experimental conditions, isoprene undergoes polymerisation to yield various terpenoids. For example.

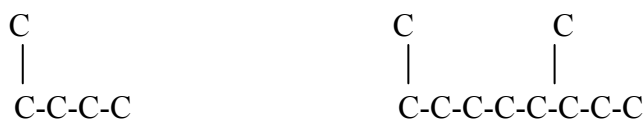
i) Isoprene when heated to  $280^\circ C$  gets dimerised to yield a widely distributed terpenoid called dipentene.



ii) Isoprene may be polymerised to yield a rubber like product

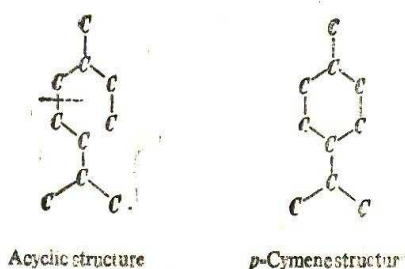


**Special isoprene rule:** - According to Ingold (925) molecules of terpenoids are built of isoprene units joined head to tail. The branched end of the isoprene molecule is termed the head and the other end is called the tail.



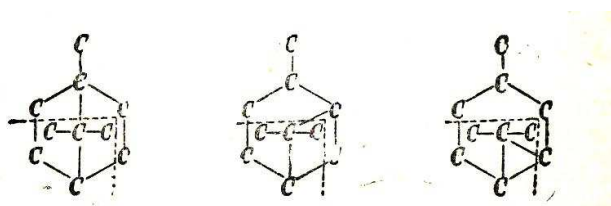
This divisibility of terpenoids into isoprene units and their head to tail union is referred to as Ingold's special isoprene rule: this rule is a very suitable tool to limit the number of carbon skeletons of the structure of unknown terpenoids.

Monocyclic monoterpenoid contain a six membered ring. Ingold point out that the presence of a gem-dialkyls group renders the cyclohexane ring more stable this gem-dialkyle rule, stated by Ingold, limits the number of possible structures obtained by classing the open chain to a cyclohexane ring. Thus the monoterpenoid open chains give rise to only one monocyclic monoterpenoid like p-cymene structure. Most of the naturally occurring monocyclic monoterpenoids are derivations of P- cymene.



The acyclic structure written above is also presented in the conventional ring shape.

Bicyclic monoterpenoids contain a six member ring along with another three, four or five member ring. Presence of a gem-dimethyl group in these cyclo propane and cyclobutane ring is essential to render them sufficiently stable for occurrence in nature. Three possible skeletons of a bicyclic monoterpenoid are:



The dotted lines in the above skeletons indicate the two isoprene units.

Terpenoids with all the three types of skeletons given above are known. Thus gem-dialkyl group tends to render the cyclohexane ring unstable whereas it stabilizes the three four and five membered rings.

---

### ***13.5 EXTRACTION AND GENERAL METHODS OF STRUCTURE DETERMINATION OF TERPENOIDS***

---

Due to their wide occurrence in nature, all the terpenoids could not be isolated and separated by a general method. However, mono- and sesqui-terpenoids have a common source, i.e., essential oils and, therefore, their isolation has been generalised. This is carried out in two steps as follows:

1. Isolation of essential oils.
2. Separation of terpenoids from essential oils.

Let us discuss these steps one by one.

a) **Extraction by means of volatile solvents.** This method is widely used in perfume industry. This method is generally used for such plants which yield an oil or give low quantities of oil on steam distillation due to decomposition of essential oils. In such cases, the plant material is directly treated with light petrol at 50°C. Under these conditions the oil is taken up by the solvent along with the soluble colouring materials. The essential oils from this extract are separated by removing the solvent by distillation under reduced pressure.

(b) **Adsorption in purified fats.** This method is also known as enfleurage method and is widely employed in France. By this method, the yield of the essential oil is generally higher. This method is used to extract a large number of essential oils like rose and jasmine.

In this method, the fat is warmed to 50°C in glass plates. Then, the surface of the fat is covered with flower petals and it is allowed to be kept as such for several days until it becomes saturated with essential oils. Then, the old petals are replaced by fresh petals and this process is repeated. After removing the petals, the fat is digested with ethyl alcohol when all the oil present in fat is dissolved in alcohol. Some quantity of fat is also dissolved in alcohol. This can be removed by cooling the alcohol extract to 20°C, when the fat separates out. The alcoholic distillate is then finally fractionally distilled under reduced pressure to remove the solvent.

Recently, the fat has been replaced by coconut charcoal due to its greater stability and higher adsorptive capacity. After keeping the coconut charcoal in contact with petals for a number of

days, the charcoal is submitted to steam to get essential oils. This method is superior to the enfleurage method.

**2. Separation of Terpenoids from Essential Oils.** The essential oils obtained from the step 1 generally contain a number of terpenoids and these are separated by various physical and chemical methods.

**a) Physical methods.** The various physical methods are as follows:

**(i) Fractional distillation methods.** The various terpenoids present in essential oils are separated by fraction distillation method. The terpenoid hydrocarbons distil over first followed by the oxygenated derivatives. Distillation of the residue under reduced pressure yields the sesquiterpenoids and these are separated by fractional distillation.

On an industrial scale, specially designed stills are employed and an efficient condensing system is necessary to minimize loss of more volatile hydrocarbons.

**(ii) Chromatography** More recently chromatography in its various forms has been widely used both for isolation and separation of terpenoids.

In adsorption chromatography, the essential oil is made to flow through a particular adsorbent when the different types of terpenoids are adsorbed at different places on the adsorbent to form different chromatograms. Then, the various chromatograms are eluted by different solvent systems to get different eluates (each eluate is having terpenoids of a single group). Each eluate is then subjected separately to adsorption chromatography when different subjected separately to adsorption chromatography when different bands due to the various terpenoids present in eluate are obtained which are then eluted to yield different terpenoids.

In adsorption chromatographic method, alumina and silica gel are generally used as adsorbents for separating the terpenoids, particularly triterpenoids.

Gas chromatography has been particularly useful for isolating pure configurationally forms of a given terpenoid from mixtures produced by synthesis.

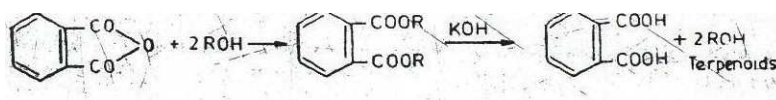
**b) Chemical methods.** These methods are not used these days to separate various terpenoids from essential oils. However, the various chemical methods are as follows:



i) When essential oils containing terpenoid hydrocarbons are treated with nitrosyl chloride in chloroform, crystal line adducts of hydrocarbons having sharp melting points are obtained. These are separated and decomposed into their corresponding hydrocarbons.

ii) When essential containing alcohols are treated with phthalic anhydride to form diesters, the primary alcohols react with phthalic anhydride readily, secondary alcohols less readily and tertiary alcohol does not react at all.

After extracting with sodium bicarbonate, diesters are decomposed by alkali to the parent terpenoid alcohols.



iii) Terpenoid aldehydes and ketones are separated from essential oils by forming their adducts with the common carbonyl reagents like  $\text{NaHSO}_3$ , 2-dinitrophenylhydrazine, phenylhydrazine, semicarbazide, etc. After separation, these are decomposed to regenerate terpenoid aldehydes and ketones.

## 6. General methods for the determination of structure of terpenoids.

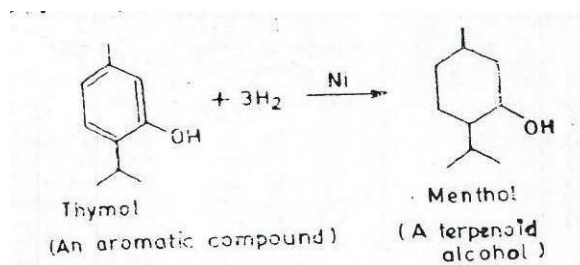
The fundamental researches done by Wallach, Baeyer, Perkin, Semmler, Simonson, Ruzicka, etc. are of great importance in elucidating the complicated structures of terpenoids. All the methods used for these have been grouped into four classes:

1. Analytical methods.
2. Synthetical methods.
3. Physical methods.
4. Knowledge of a molecular rearrangement.
5. Synthesis.

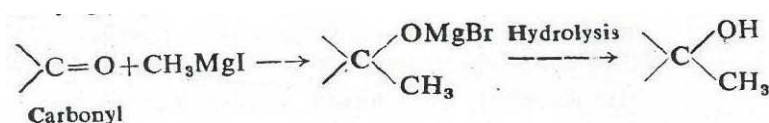
We will discuss these some methods

**1. Synthetically Method:** the following synthetical reactions have been found to be great value in elucidating the structure of terpenoids.

a) **Catalytic hydrogenation:** When aromatic compounds are hydrogenated catalytically under suitable conditions, It is possible to obtain synthetic terpenoids. For example, a terpenoid alcohol menthol may be prepared from thymol, an aromatic compound, by catalytic hydrogenation.

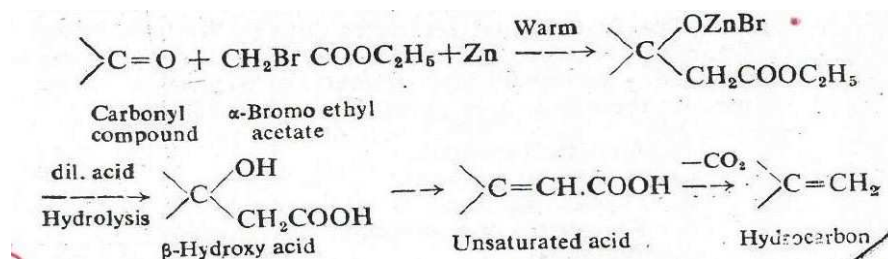


(b) **Grignard's reaction.** This reaction is of wide importance in the chemistry of terpenoids. This reaction was successfully employed by Perkin et al. to synthesise a large number of compounds which are related to terpenoids. By Grignard's reagent, methyl or isopropyl groups can be introduced into a compound having carbonyl group.



By the direct application of Grignard's reaction,  $\alpha$ -terpineol, a naturally occurring terpenoid tertiary alcohol, can be readily prepared.

(c) **Reformatsky reaction.** Similar to Grignard's reaction, Reformatsky reaction is very useful in synthesising many terpenoids this reaction;  $\alpha$ -halogen substituted ester is treated with a carbonyl compound (aldehyde, ketone or ester) in the presence of zinc to form a  $\beta$ -hydroxy ester. The latter compound when treated with dilute acid yields  $\beta$ -hydroxy acid which may be further converted into an unsaturated acid or a hydrocarbon.



## 2. Physical Methods

A number of physical methods have been employed in elucidating the structure of natural terpenoids. All complicated structural problems in terpenoids have been solved successively by physical methods. These methods also help to confirm the results of degradative studies.

The various methods for elucidating the structures of terpenoids are as follows:

**(a) Ultraviolet spectroscopy.** This technique is widely used in terpenoid chemistry for the detection of conjugation. The values of  $\lambda_{\max}$  for various types of terpenoids have been calculated. Thus:

(i) For simple acyclic dienes,  $\lambda_{\max}$  has been found to be 217-228 nm. If the conjugated double bonds are not present in the same ring, i.e. heteroannular diene,  $\lambda_{\max}$  has been found to be 230-240 nm. If the diene is homoannular in which both double bonds are present in the same ring,  $\lambda_{\max}$  has been found to be 256-265 nm.

(ii) For  $\alpha,\beta$  unsaturated carbonyl systems,  $\lambda_{\max}$  has been found to be 220-250 nm. Such systems also show a weak band at  $\lambda_{\max}$  315-330 nm.

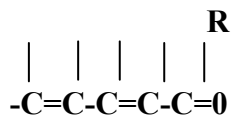
The values of  $\lambda_{\max}$  for various polyenes and the increment values for substituents are given in Table:

**TABLE**

**Absorption value for Various Polyenes and the increment values for substituent's**

S.No.	Polyenes	Absorption value
1	Basic value of homoannular dienes	253 nm
2	Basic value of heteroannular (and acyclic) dienes	214 nm
3	Increment for each C-substituent	5 nm
4	Increment for each exocyclic double bond	5 nm
5	Increment for each double bond that extends conjugation	30 nm

**The general formula of  $\alpha,\beta$  unsaturated ketenes is**



Where R is an alkyl group or a ring residue and the parent system. The various values of these systems are given in Table

### Absorption Values of Unsaturated Ketones and Increment Absorption Values for Various Substituents'

S.No.	Polyenes	Absorption value
1	Basic value of homoannular dienes	215 nm
2	Basic value of heteroannular (and acyclic) dienes	10 nm
3	Increment for each C-substituent	12 nm
4	Increment for each exocyclic double bond	5 nm
5	Increment for each double bond that extends conjugation	30 nm

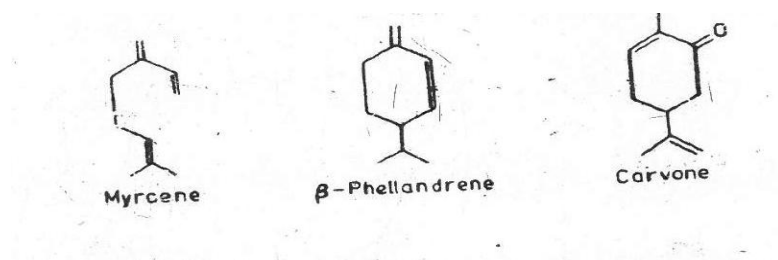
The above mentioned rules have been successfully applied to various terpenoids. For example,

i) The observed  $\lambda_{\max}$  value for myrcene is 224 nm whereas the calculated  $\lambda_{\max}$  value (an cyclic diene with one C-substituent) is  $214+5-219$  nm.

ii) The observed  $\lambda_{\max}$  value for phellandrene is 232 nm whereas the calculate  $\lambda_{\max}$  value (a heteroannular diene with two substituents and one exocyclic double bond) is  $214+2 \times 5+5$  or 229 nm.

iii) The observed  $\lambda_{\max}$  value for carvone is 235 nm whereas the calculated  $\lambda_{\max}$  value is 237 nm which is obtained as follows:

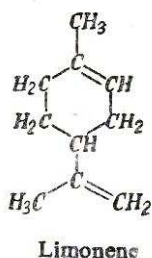
Parent system	215 nm
C-substituent at $\alpha - c$	10 nm
C-substituent at $\beta - c$	12 nm
	$\lambda_{\max}$ 237 nm



Ultraviolet spectroscopy has also been used to recognize unsaturated acids esters and lactones. These compounds have in the region of 220 nm.

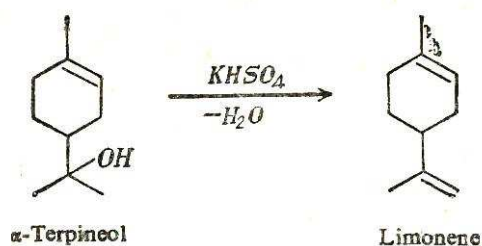
### 13.5.1 LIMONENE:

**Introduction:** It is the most important monoterpenoid which is widely distributed in nature. Its (+) form occurs in lemon and orange oils the (-) form occurs in peppermint oil where as the (+) form occurs in turpentine oil. The racemic modification of limonene is known as dependence. This name was give to the inactive form before its relation to the active form (limonene) was established.



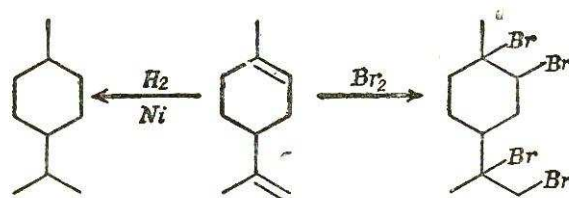
**Preparation** (i) From Essential Oils. (+) - Limonene is obtained from oranges. Dipentene is extracted from turpentine oil.

(ii) By dehydration of  $\alpha$  - terpineol with  $\text{KHSO}_4$ .

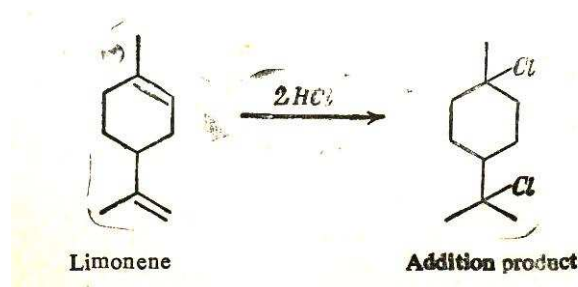


**Properties:** Limonene is a pleasant-smelling liquid with citrus-like odour (b.p. 450K). It is insoluble in water. Chemically it gives the reactions of a diolefin. For example,

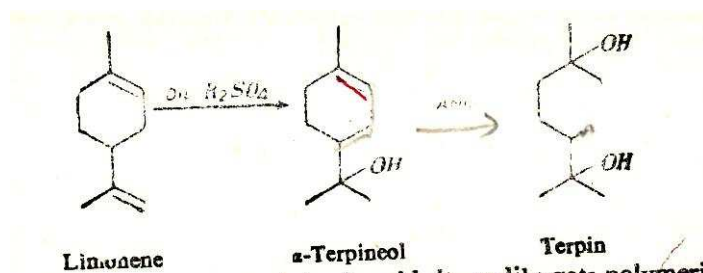
(i) It forms addition products with hydrogen and bromine to give p-menthane and its crystalline tetrabromide respectively.



(ii) It gives an addition product with two molecules of halogen acid.



(iii) With dilute sulphuric acid, it gives  $\alpha$ -terpineol and terpin hydrate.



**Uses:** (i) Limonene is used as flavoring agent in beverages and foods.

(ii) Dipentene is used in medicine and in making synthetic resins and high pressure lubricating oil additives.

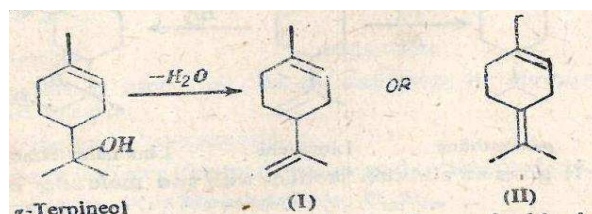
(iii) It is also used in the synthesis of isoprene, cymene and menthane.

**Constitution of limonene:** This has been elucidated on the basis of following analytical and synthetic evidences.

**1. Molecular formula.** From analytical data, the molecular formula of limonene has been found to  $C_{10}H_{16}$ .

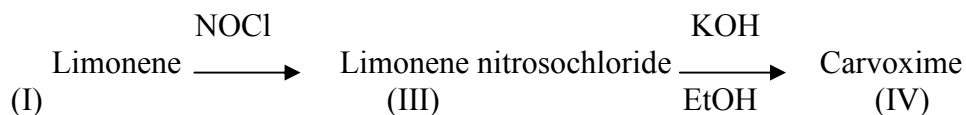
**2. Presence of two olefinic bonds.** This has been revealed on the basis of following facts.

- It adds on four bromine atoms to form a tetra bromide.
- On catalytic reduction, it adds on four atoms of hydrogen to form tetrahydro derivative.
- With hydrochloric acid, a dihydrochloride is formed.
- With hydrobromic acid, it yields a dihydrobromide.

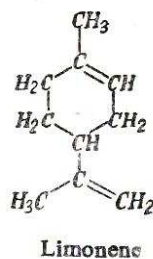
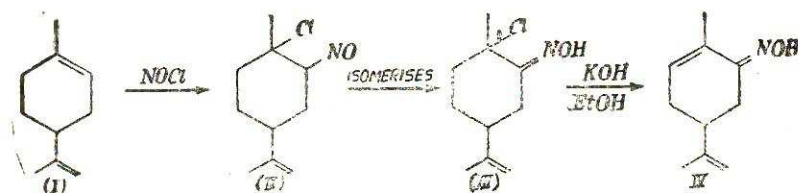


**3. As a monocyclic derivative.** The molecular formula of the saturated parent hydrocarbon corresponding to limonene is  $C_{10}H_{20}$  which corresponds to the general formula  $C_nH_{2n}$  ( $n=10$ ) for the monocyclic compound. Hence, the limonene contains monocyclic system.

**4. Position of the double bonds.** Chemical proof for double bond at position-8(9) is afforded by the following reactions



Structure of carvoxime is known and it has a double bond in Position 8(9). It, therefore, follows that limonene must have the structure I with double bond in position 8(9). Thus the above reaction may be written as follows:



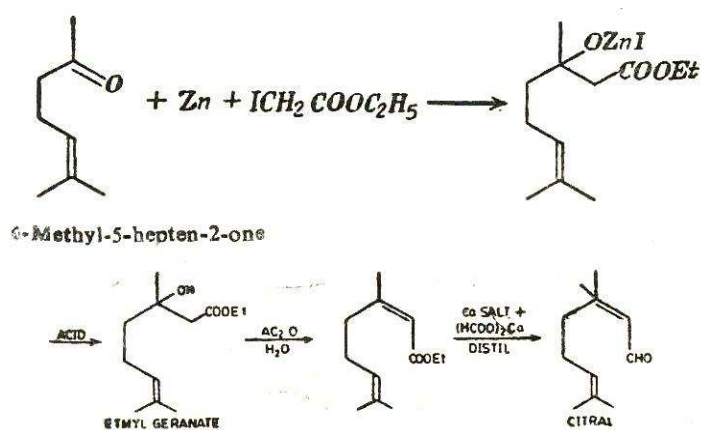
Thus Structure of limonene is 1, 8(9) menthadiene (I).

### 13.5.2 Citral ( $C_{10}H_{16}O$ ):

This is the most important acyclic terpenoids since the structures of most of the other monoterpenoids are based on the structure of citral. It occurs in oil of lemon grass (70-80%) and oils of lime, lemon, citronella, etc.

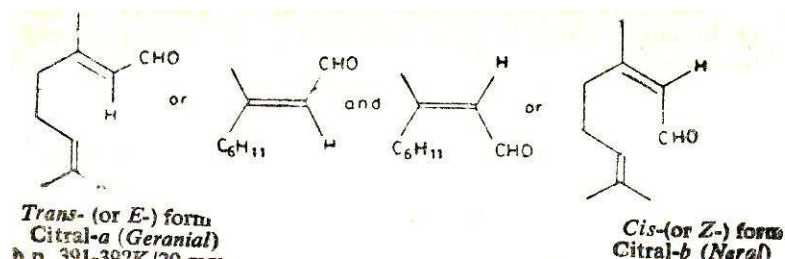
**Extraction:** It is obtained from lemon-grass oil by fractional distillation under reduced pressure and purified through the formation of bisulphite compound which is decomposed with sodium carbonate to get free citral.

**Synthesis:** Citral may be synthesised from 6-methyl-5-hepten-2-one by Reformatsky reaction using  $Zn + ICH_2COOEt$ , as follows:



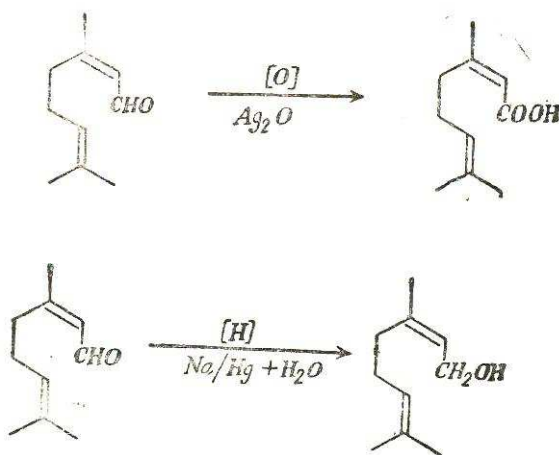


**Properties:** Citral is a pale yellow oily liquid (b.p. 497-501 K) with a pleasant odour of lemons. Chemical formula of citral is.

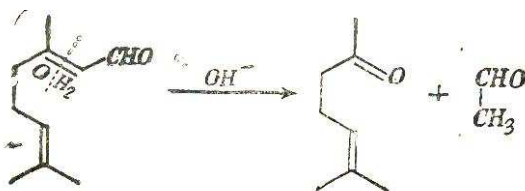


**Chemical Properties:** Some chemical reactions of citral are:

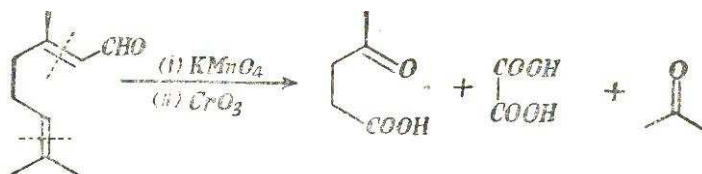
- (i) **Reduction** Citral on reduction with sodium amalgam and water gives geranial.
- ii) **Oxidation.** On oxidation with silver oxide, it gives geranic acid.



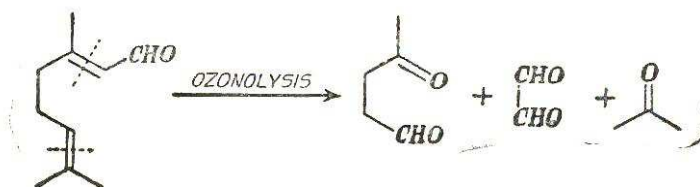
iii) **Hydrolysis.** When heated with potassium carbonate solution, citral undergoes hydrolysis and yields 6-methyl-5 hepten-2-one and acetaldehyde. During this reaction citral undergoes cleavage at the double bond. This cleavage by alkaline reagents is a general reaction of unsaturated carbonyl compounds.



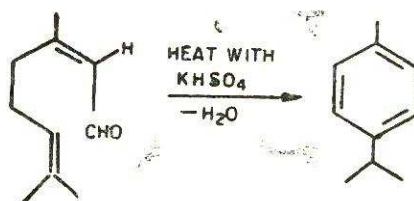
(iv) **Oxidation with alkaline  $\text{KMnO}_4$**  followed by chromic acid oxidation, gives acetone, oxalic acid and laevulic acid.



(v) **Ozonolysis.** On ozonolysis it gives acetone, laevula dehyde and glyxol.



(vi) **Dehydration:** On heating with  $\text{KHSO}_4$  citral loses two molecules of water and gives p-cymene.



These reactions confirm the structure assigned to citral.

**Use** It is widely used as flavouring agent and in preparing synthetic perfumes e.g., and ionone. It is also employed for the manufacture of geraniol.

#### Constitution of Citral:

(a) Molecular formula of citral as deduced from its analytical data is  $\text{C}_{10}\text{H}_{16}\text{O}$ .

b) **Presence of CHO group** it gives the typical reaction of an aldehydic function e.g.,

i) It gives bisulphite compound and an oxime.

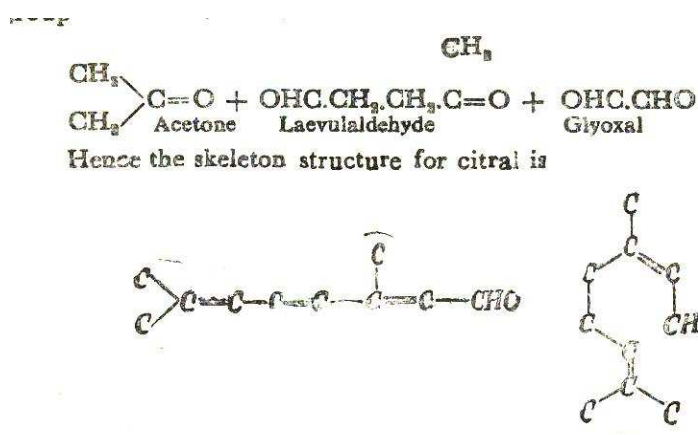
ii) On oxidation with silver oxide it gives geranic acid, an acid with same number of carbon atoms as citral.

c) **Positions of methyl and isopropyl groups.** On heating with potassium hydrogen sulphate, citral forms p-cymene (II), (p-methyl isopropylbenzene). It is concluded from this that citral molecule was acyclic and assigned it the structure (I), having two isoprene units joined head to tail.

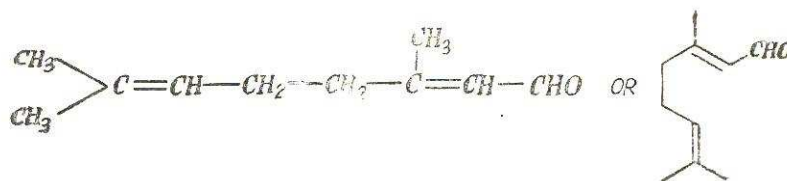


(d) **Presence of two double bonds.** On ozonolysis it gives acetone, laevulaldehyde and glyoxal, i.e., the chain breaks at two points. This suggests the presence of two double bonds.

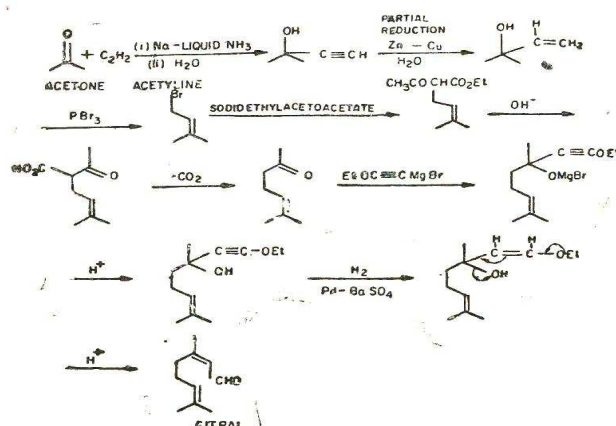
(e) **Location of two double bonds.** The carbon atoms in the molecule are arranged as in the above three products and with CHO group at one end.



(f) **Structural formula.** From this we can write the structural formula of as



**g) Final confirmation.** The structure of citral was finally confirmed by its synthesis from methyheptemone whose synthesis is given below:



### 13.5.3 ALKALOIDS:

**Introduction:** These are the basic nitrogenous compounds of vegetable usually having a marked physiological action and which may be regarded divided form parole, pyridine quinoline, isoquinoline or similar cyclic nitrogenous nuclei. Many of them possess curative properties and are of great value in medicine.

**Occurrence:** Generally they are usually found in plants in the form of their salts- in which they are either combined with organic acids such as lactic, citric, malic, oxalic commonly found plants or with certain characteristic acid such as quinic acid and meconic acid.

In some case they exist glycoside. Generally they accumulate in the first and seeds and some times in the break of the trees.

**Isolation of Alkaloids Plants:** Alkaloids are extracted form plarite the plant material is finally powdered and treated with water acidified with HCL, when alkaloids form salts with HCL dissolve in water. The water extract contains the hydrochlorides of the Alkaloids together with Carbohydrates and other products form the plant tissue and free alkaloids are obtained from the acidified water extract which when treated with alkali precipitate out the alkaloids (being sparingly soluble in water) in the case of volatile alkaloids, the acidulated water extract is treated with alkali and stream - distilled.

Purification of the crude product obtained above is carried out by special methods or frequently by crystallization of the freed compounds or their salts.

**General Properties:**

**(i) State:** Most of the alkaloids are crystalline solids which cannot be distilled. Only a few of them are liquids and can volatilize without decomposition, e.g., coniine and nicotine.

**(ii) Physiological action:** Most of them are bitter in taste and often exert a marked physiological action.

**(iii) Solubility:** Almost all of them are either insoluble or sparingly soluble in water. Liquids alkaloids (coniine and nicotine are notable exceptions (being readily soluble in water and appreciably volatile in steam.) Alkaloids are generally less soluble in chloroform, ether and benzene but are readily soluble in alcohol.

**(iv) Optical activity:** Most of them are optically active and usually laevo-rotatory.

**(v) Basic nature:** In a number of cases their solutions give a strong alkaline reaction. All of them form salts with acids, among these salts the chlorides, sulphates and oxalates crystallize well, their chlorides give double salts with chlorides of gold, platinum and mercury.

**(vi) Precipitation :** Alkaloids are precipitated from their aqueous or acid solution by a number of substances such as picric acid, tannic acid, perchloric acid, potassium mercuric iodide, potassium bismuth iodide, potassium bismuth iodide, phosphomolybdic acid and phosphotungstic acid. Precipitation with these reagents is often employed for the isolation and purification of alkaloids. This procedure cannot, however, be used for quantitative analysis since the resulting compounds are not sufficiently insoluble and because the reagents precipitate some other organic substances as well.

**Determination of the Chemical constitution of Alkaloids:** Different steps involved in the determination of constitution of an alkaloid are:

**(a) Determination of Molecular Formula:** The sample is purified and subjected to qualitative analysis. Carbon, hydrogen and nitrogen are invariably present while oxygen is rarely absent. This is followed by quantitative analysis, determination of molecular weight and then calculation of empirical and molecular formula.

**(b) Ditection of Groups:** Knowing the presence of nitrogen and/or oxygen in the alkaloid, the functional nature of these elements is determined.

### FUNCTIONAL NATURE OF OXYGEN

**(1) Hydroxyl Group:** The alkaloid is treated with acetic anhydride, acetyl chloride or benzoyl chloride to detect the presence of hydroxyl group.

The hydroxyl group present may be phenolic or alcoholic. It is phenolic if the alkaloid -

- (i) Gives a colour with ferric chloride:
- (ii) Is soluble in sodium hydroxide and is reprecipitated by carbon dioxide.

If the hydroxyl group is not phenolic, it must be alcoholic this is confirmed by treatment with dehydrating agents (eg.  $\text{H}_2\text{SO}_4$  or  $\text{P}_2\text{O}_5$ ) or by oxidation.

**(2) Carboxyl group:** Presence of a carboxyl group is indicated by the solubility of the alkaloid in aqueous sodium carbonate or formation of esters.

**(3) Ester group:** Identification of the products of hydrolysis of alkaloid indicates the presence or absence of an ester group.

**(4) Methoxy group:** The presence of methoxy groups and their number is determined by Zeisel method which is described under Estimation of groups.

### FUNCTIONAL NATURE OF NITROGEN

#### **(5) Amino Group.**

(i) The reactions of the alkaloid with acetic anhydride, benzoyl chloride, nitrous acid and methyl iodide show whether the amino group is primary, secondary or tertiary.

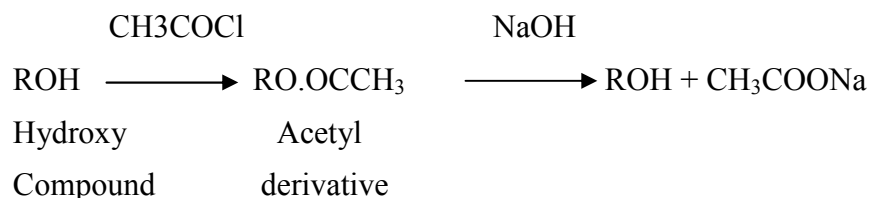
(ii) Formation of methylamine, dimethylamine, trimethylamine (volatile products) on distillation with aqueous potassium hydroxide indicates the nature and number of methyl groups attached to nitrogen atom.

**(6) Amide group:** Products of hydrolysis (acid and ammonia) of the alkaloid will show the presence of an amide group.

**(7) Presence of Unsaturation:** It's in an alkaloid sample is indicated by the treatment with bromine water or dilute alkaline permanganate.

(c) **Estimation of Groups:** The estimation of various groups, detected as above, is carried out as follows.

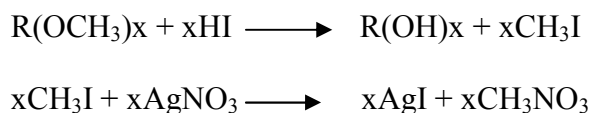
(1) **Hydroxyl groups:** The number of hydroxyl groups is determined by acetylating the alkaloid followed by hydrolysis of the acetyl derivative with a known volume of N-NaOH. The excess of the alkali left unused is estimated by back titration with a standard acid.



From the volume of N-NaOH used, the number of acetyl groups or hydroxyl groups can be calculated.

(2) **Carboxyl groups.** The number of carboxyl groups in a given sample may be determined volumetrically by titration against standard barium hydroxide solution using phenolphthalein as an indicator or gravimetrically by the silver self method.

(3) **Methoxy groups:** The presence of methoxy groups and their number many are determined by the Zeisel's method. The alkaloid is treated with concentrated hydroiodic acid at 399 K (boiling point of HI). The methoxy groups present in the molecule are thereby changed into methyl iodide which is absorbed in alcoholic silver nitrate when silver iodide precipitated.



The precipitate of AgI is boiled with HNO<sub>3</sub>, filtered, washed, dried and weighed.

From the weight of silver iodide, we calculate the number of methoxy groups as illustrated in the solved example given below:

**Example:** When treated according to Zeisel's method 0.226 gram of an alkaloid C<sub>20</sub>H<sub>21</sub>O<sub>4</sub>N yielded 0.626 gram of silver iodide. Calculate the number of methoxy groups present in the molecule of the alkaloid.

**SOLUTION**

Mol. mass of the alkaloid,  $C_{20}H_{21}O_4N = 240 + 21 + 64 + 14 = 339$

Wt of alkaloid taken = 0.226 g

Wt of AgI obtained = 0.626 g

The wt of AgI that will be produced by 1 mole, i.e., 339g of alkaloid =  $\frac{0.626}{0.226} \times 339 = 939$  gm.

Mol. mass of AgI =  $107.88 + 127 = 234.88$

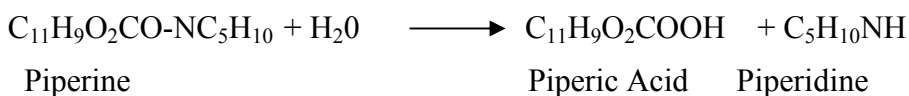
It is clear from the equations given above that corresponding to each methoxy group present, one molecule of AgI is obtained at the end. Hence the number of methoxy group in the

molecule of the alkaloid =  $\frac{939}{234.88} = 4$

**(d) Degradation:** The complex molecule is broken into relatively simple fragments whose nature gives useful information about the type of nuclei present in the molecule. Various methods employed for degradation of an alkaloid are:

**(i) Hydrolysis:** Molecules containing an ester or amide group break on hydrolysis into simpler products. For example, piperine on hydrolysis splits up to give piperic acid and piperidine.

From this we infer that piperine is a piperidinamide of piperic acid.



**(ii) Oxidation:** Alkaloids on oxidation give a variety of products depending the nature of oxidizing agents-mild ( $H_2O_2$  or alkaline potassium ferricyanide), moderate (acid or alkaloid  $KMnO_4$ ) or vigorous ( $K_2Cr_2O_7$   $H_2SO_4$ ; conc.  $HNO_3$  or  $MnO_2 + H_2SO_4$ )

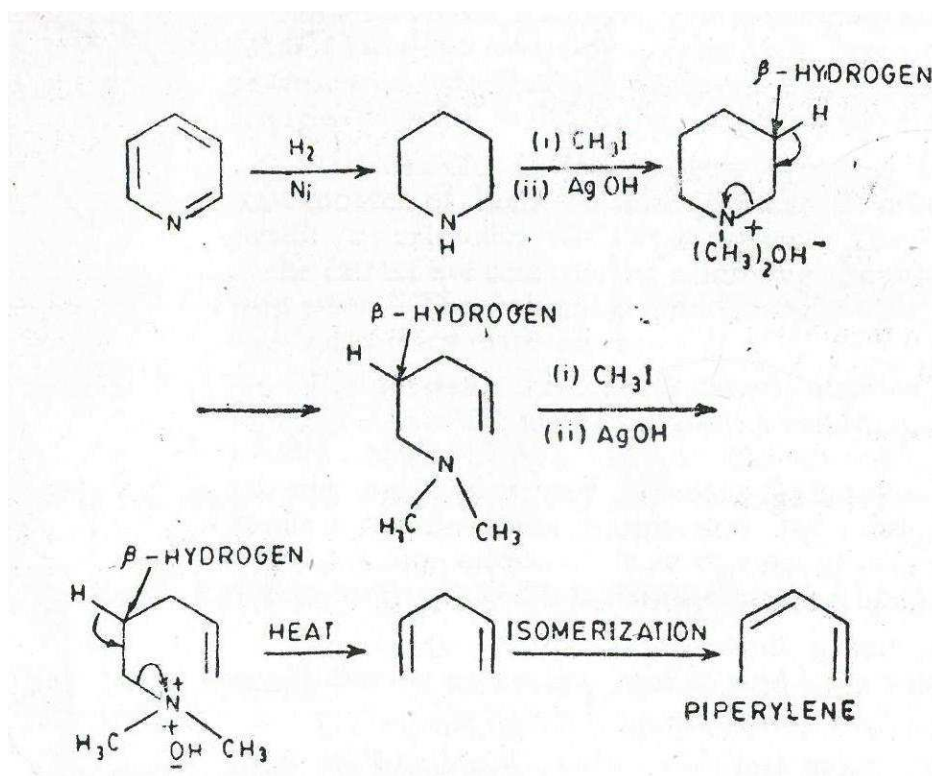
**(iii) Distillation with Zinc dust:** This brings about degradation or dehydrogenation of the alkaloid under study. When the alkaloid contains oxygen it is removed during distillation. For example, on distillation with zinc dust morphine yields phenanthrene (parent compound) while coniine undergoes dehydrogenation to give conyryne.

**(iv) Hofmann Exhaustive Methylation:** Heterocyclic rings containing nitrogen are opened with the elimination of nitrogen when subjected to exhaustive methylation. It thus helps us in knowing the nature of the carbon skeleton.

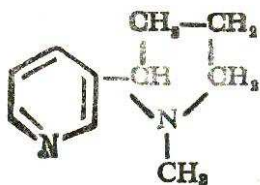


The heterocyclic, if unsaturated, is hydrogenated, and converted to the quaternary methylammonium hydroxide. This on heating loses a molecule of water by combination of -OH group with a hydrogen atom in B-position with respect to the nitrogen atom and the ring is opened at the nitrogen atom.

On repeating the process with the product, nitrogen atom is completely removed and an unsaturated hydrocarbon is left behind which generally isomerises to a conjugated diene. For example, starting with pyridine we have:



(e) **Synthesis.** The alkaloid under investigation is assigned a tentative structure on the basis of the foregoing analytical data. This is finally proved only if it could be synthesised by a suitable unambiguous method.



### 13.5.4 NICOTINE (C<sub>10</sub>H<sub>14</sub>N<sub>2</sub>):

It is the chief alkaloid of the tobacco plant (*Nicotiana tobacco*) where in it is present as a salt of malic or citric acid. In leaves of tobacco its concentration is the highest. It varies from 0.6 to 8% depending upon the kind of tobacco.

The alkaloids are conveniently prepared from tobacco leaves. Raw tobacco of high nicotine is crushed and its soluble constituent extracted with cold water. The hydrocarbons present in the extract are removed by acidifying the solution and extracting with ether. The residual solution is made alkaline and nicotine free is extracted with ether.

**Properties:** Freshly prepared nicotine is a colourless oily liquid. (b.p. 519.K under 730 mm pressure) readily soluble in water. Unlike tobacco, pure nicotine has an unpleasant smell. It has a burning taste and is very poisonous (lethal dose being 30 to 50 mg). In air it rapidly turns brown and resinifies and can be distilled without decomposition only in vacuum or in a current of hydrogen. The natural alkaloid is laevo-rotatory and has  $[\alpha]$  of  $-169^\circ$

In a mixture with soap solution it is one of the most effective exterminating agents for green fly and other insect pests.

#### **Constitution:**

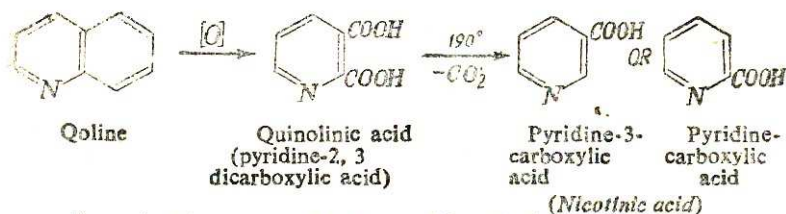
(1) Molecular formula of nicotine as deduced from its analytical data and molecular mass determination is C<sub>10</sub>H<sub>14</sub>N<sub>2</sub>.

(2) Nicotine reacts with methyl iodide to form dimethiodide and two monomethiodides but it does not form an acetyl or benzyl derivative. This shows that the two nitrogen atoms in nicotine are tertiary.

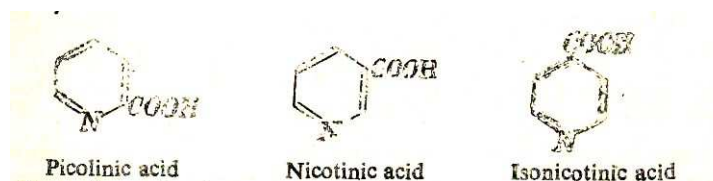
(3) Nicotine on oxidation with chromic acid or permanganate gives nicotinic acid (C<sub>6</sub>H<sub>4</sub>N<sub>2</sub>COOH). Three pyridine carboxylic acids are known with COOH group in 2-,3- or 4-position. These are named picolinic acid, nicotinic acid. Their orientation was proved as follows:

Quinoline on oxidation with alkaline permanganate gives quinolinic acid which must be pyridine-2,3-dicarboxylic acid. Quinolinic acid on being heated to 360K loses one carboxyl

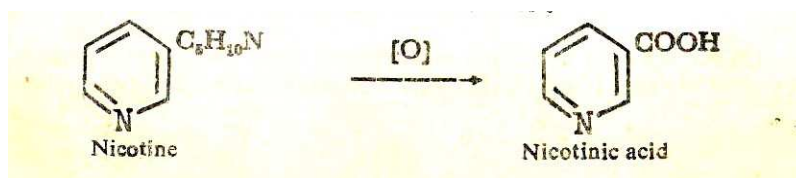
group and gives nicotinic acid. Hence nicotinic acid must be either pyridine-2-carboxylic acid or pyridine-3-carboxylic acid.



By elimination, therefore, picolinic acid is pyridine 2-carboxylic acid.



Now since nicotine on oxidation followed by heating at 460K yields nicotinic acid (pyridine-3-carboxylic acid), it suggests that nicotine contains a pyridine ring with some sort of group attached to it at the B-position. This group attached to pyridine ring is  $C_5H_{10}N$  and the oxidation can be formulated as follows:

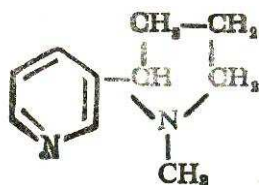


Nicotine hydriodide on treatment with methyl iodide gives a methiodide. This on oxidation yields hygrinic acid (N-methylpyrrolidine- $\alpha$ -carboxylic acid).

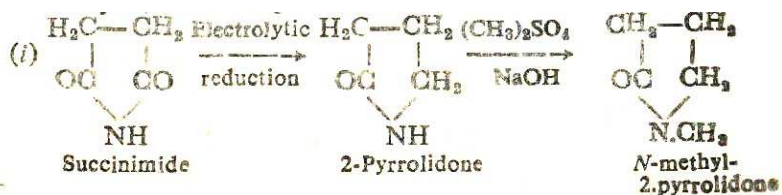


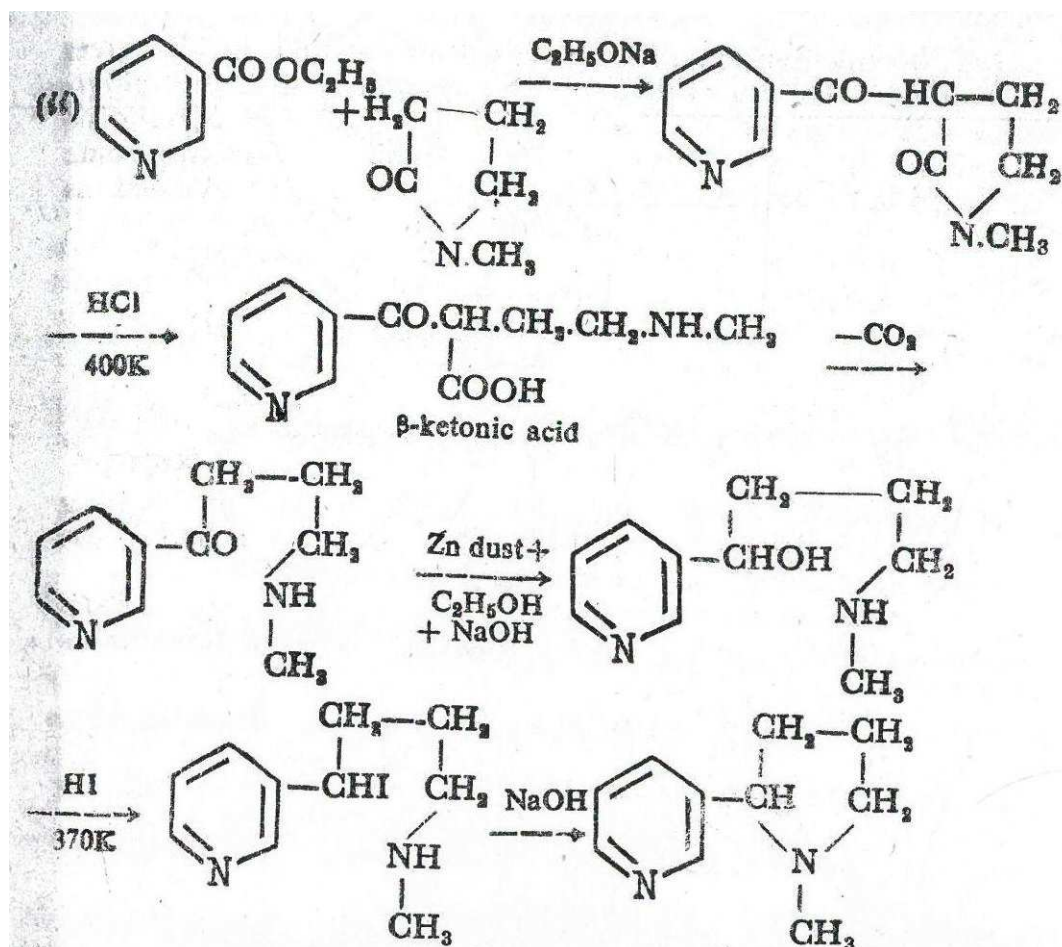
This indicates that pyridine ring has been destroyed during the above transformation and the group-C<sub>5</sub>H<sub>10</sub>N attached to the pyridine ring in B-position is N-methylpyrrolidine.

Pyridine and pyrrolidine nuclei are joined through carbon atoms at B-position in pyridine and 2-position in pyrrolidine. This gives the structure of nicotine as:



This formula has been further confirmed by its synthesis by Spath and Bpetchneider (1928):

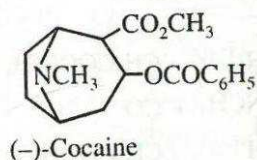




The (+/-) - mixture of nicotine obtained by the above synthesis was resolved by forming salts with (+/-) -tartaric acid and (-) - nicotine thus obtained was found to be identical with the natural product.

### 15.5.5 COCAINE:

It was first isolated in 1860 from the leaves of *Erythroxylon coca L.*, (Coca Plant) which is mainly grown in South America, particularly in Peru and Bolivin and now grown in java and Ceylon. However, the plant from which cocaine is obtained (*i.e.* coca plant) should not be confused with *Theobrama cocoa*, the beans of which are source of cocoa and chocolate.



**Isolation:** In order to obtain the crude cocaine, the Peruvian leaves are powdered and thoroughly digested with lime or sodium carbonate and a little water. The digested solution is then extracted with light petroleum when the alkaloids get dissolved in the light petroleum layer. From the organic layer, the alkaloids are removed by shaking with a controlled amount of dilute sulphuric acid (avoiding excess). This acid solution when evaporated yields a crystalline precipitate of a larger portion of the cocaine which can be further purified by crystallization of its hydrochloride.

Cocaine can also be extracted directly from the leaves with high boiling petroleum.

**Properties:**

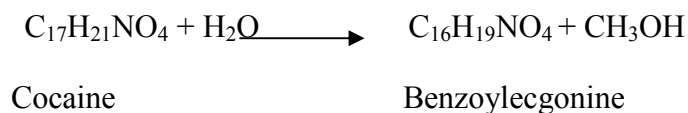
1. It forms colourless crystals (m.p.  $98^{\circ}\text{C}$ ). It is sparingly soluble in water, but its hydrochloride is quite soluble. It is a strong tertiary base ( $\text{p}K_{\text{a}}$  8.7).
2. The hydrochloride of cocaine is used as a local anaesthetic in eye surgery and dentistry. Usually, cocaine is injected along with adrenaline.
3. Cocaine is the habit forming drug and is, therefore, used with great care. Taken internally, it increases physical and mental power but the after-effects is deep depression.

**Constitution:**

1. **Molecular Formula.** From analytical data and molecular weight determination, it follows that the empirical and molecular formula of cocaine i.e.,  $\text{C}_{17}\text{H}_{21}\text{NO}_4$ .
2. **Nature of the Nitrogen Atom.** It is a strong tertiary base ( $\text{p}K_{\text{a}}$  8.7) and adds on one molecule of methyl iodide to form a methiodide. It also reacts with cyanogens bromide to give methyl bromide and cyanonorcocaine and thus contains a N-methyl group.

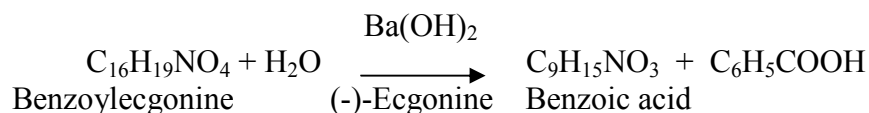


3. **Hydrolysis.** When cocaine is heated with water, it is hydrolysed to methanol and benzoylecgonine.



But benzoylecgonine contains a carboxyl group. Therefore, cocaine is the methyl ester of benzoylecgonine which is also proved by the fact that benzoylecgonine when heated with methyl alcohol in presence of hydrochloric acid yields cocaine.

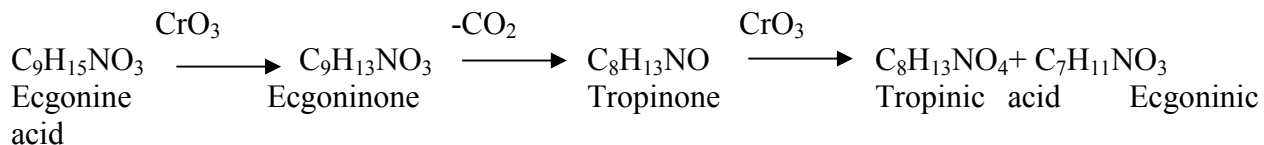
When benzoylecgonine is boiled with barium hydroxide solution. It undergoes further hydrolysis, yielding benzoic acid and ecgonine.



From the above reactions, it is evident that the constitution of cocaine depends on the constitution of ecgonine.

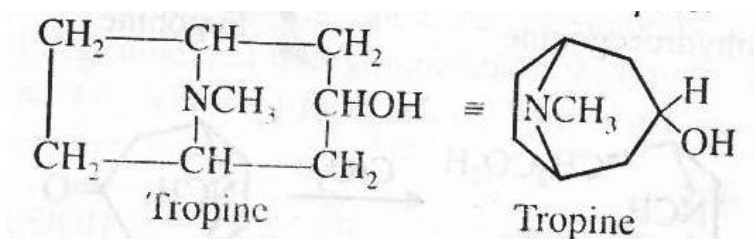
**4. Constitution of Ecgonine.** It is established as follows:

- Its molecular formula is  $\text{C}_9\text{H}_{15}\text{NO}_3$ .
- It is a tertiary base because it gives the crystalline additive compound  $\text{C}_9\text{H}_{15}\text{NO}_3 \cdot \text{CH}_3\text{I}$  with methyl iodide. This reaction shows that ecgonine contains tertiary nitrogen atom.
- As ecgonine forms ester and salt with alcohol and alkali respectively, it means that it contains one *carboxyl group*.
- The presence of -OH group is indicated by the fact that it reacts with acid chloride and anhydride to form acyl derivatives. Since this acyl derivative can be further esterified, it shows that ecgonine is both an alcohol and an acid.
- Ecgonine when oxidised with  $\text{CrO}_3$  yields a ketone ecgoninone which soon loses a molecule of carbon dioxide to yield tropinone. The latter compound when further oxidised yields a mixture of tropinic acid and ecgoninic acid, former of which is also obtained from tropine.

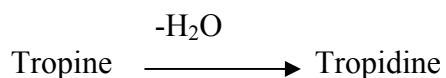


From the nature of products obtained by oxidation of ecgonine, following conclusions are drawn :

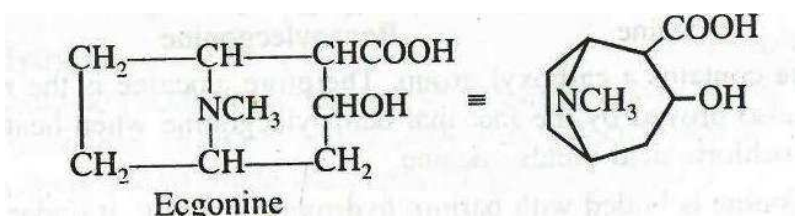
- The reaction which involves the oxidation of ecgonine first to tropinone and then to tropinic acid reveals that ecgonine contains the tropane skeleton and furthermore position of the secondary alcoholic group in ecgonine remains the same as in tropine.



The close similarity between the structures of ecgonine and tropine is further proved by the fact that the dehydration of ecgonine yields anhydroecgonine which on decarboxylation yields tropidine. The latter compound is also formed by the dehydration of tropine.

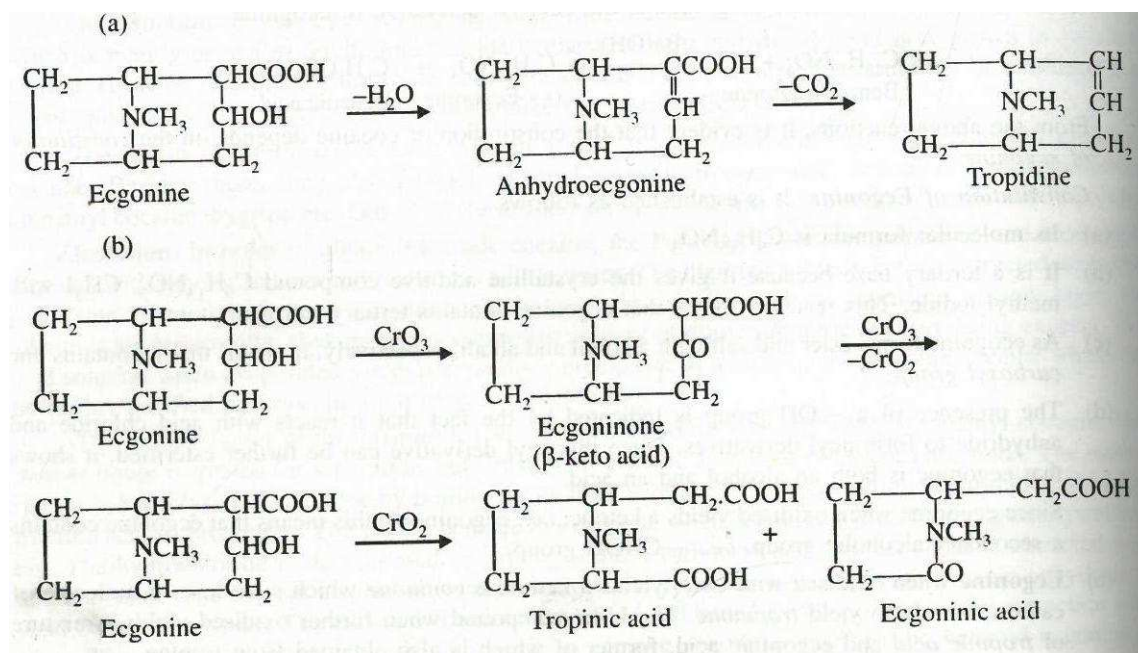


(ii) The easy decarboxylation of the ecgonine reveals that it is a  $\beta$ -keto acid. This interpretation is confirmed by the fact that Willstatter actually observed the formation of an unstable ketonic acid which lost carbon dioxide to yield tropinone. Thus, ecgonine is :



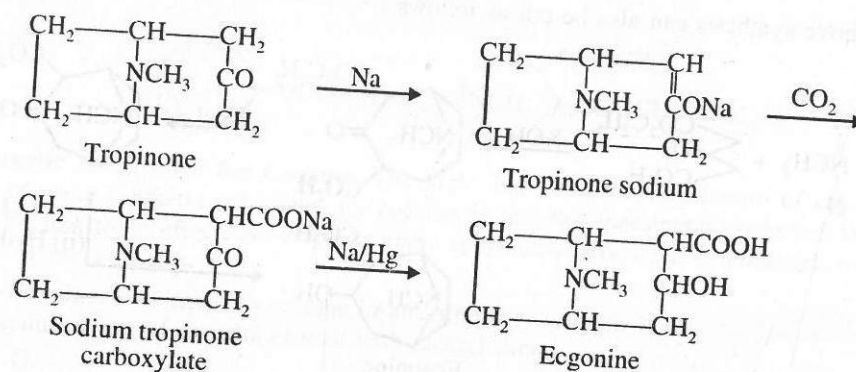
f) The above structure of ecgonine explains all its reactions :





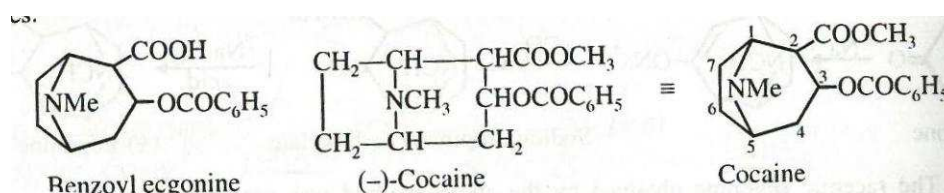
g) Finally the structure of ecgonine is proved by its synthesis:

The starting material is tropinone.

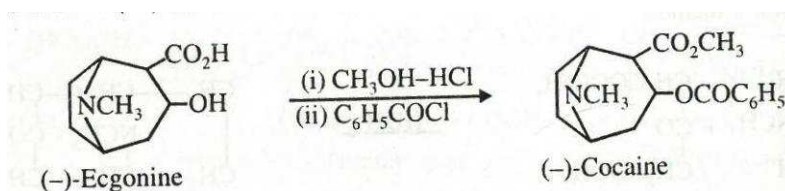


The racemic ecgonine obtained by the above method was not identical with (-) ecgonine obtained from (-) cocaine. However, its chemical properties were the same.

**5. Constitution of Cocaine.** Now since we know that cocaine is methyl ester of benzoyl ecgonine having a free carboxylic group; the benzoyl ecgonine and cocaine will be having the following structures.



The above structure of cocaine has been proved by its synthesis which consists in the resolution of the racemic ecgonine, esterification of (-). ecgonine followed by benzylation to give cocaine identical to natural (-). form.



Similarly, (+) and (-) cocaines were obtained from the corresponding - ecgonines.

### 13.5 SUMMARY

In this unit we discuss natural product for i.e. Terpenoids and alkaloids. Natural products are usually found in plants in the form of their salts in which they are either combined with organic compounds. We studied their extraction from plant material in the form of crude and then their purification.

In Terpenoid we studied the limonene and citral with their physical and chemical properties, Also discuss their commercial value. as citral widely used as a flavoring agent and in preparing synthetic perfumes, eg. a and b-ionone.

Similarly limonene is principal terpene in lemon, orange, bergamot, caraway and celery oils. The inactive (+/-) mixtures, called dipentene, occurs in lemon-grass oil and trupertene oil.

In alkaloid we will discuss isolation of alkaloid from plants and their purification, we also discuss general properties and therapeutic value of alkaloid like morphine, nicotine etc. physical and chemical properties of nicotine and cocaine are also explained.

We should studied natural product much wider ways.

### 13.6 TERMINAL QUESTION

#### Terpenoids:

1. What are terpenoids? How are they classified? How are these extracted? Write a short note on their chemical nature.

2. (a) What are terpenoids? How are they classified?  
(b) How is the structure of citral established?
3. (a) Describe the preparation, properties and uses of menthol as limonene.  
(b) Discuss the constitution, properties and uses of menthol as limonene.
4. Give the synthesis of methyl heptanone. Starting from methyl heptanone outline the synthesis of citral using Reformatsky reaction.
5. How will you convert: 3 di-bromo -3-methyl butane into citral?
6. What sort of a terpene is limonene? Give its structure.
7. What do you understand by the term terpenoids?
8. How terpenoids are classified.
9. How will you convert.
  - (i) Limonene to corvoxime.
  - (ii) L-terpineol to limonene.
10. What is isoprene rule? How is the structure of citral Established?

**Alkaloids:**

1. Define an alkaloid and outline methods for the extraction of alkaloids from plant materials. What are their uses?
2. Write an explanatory note on general characteristics of alkaloids.
3. What do you understand by the term alkaloid? Describe synthesis of Nicotine.
4. Describe the various steps involved in establishing the structure of Nicotine.
5. Discuss the constitution of Cocaine.
6. Suggest the heterocyclic units occurring in Nicotine. Outline the method for synthesis of dl. Nicotine.
7. What are alkaloids? How is cocaine isolated?
8. How could you prove that nicotine molecule has a pyrrolidine nucleus? Write the structure of Nicotine. Is it optically active? If so, is it dextro rotatory or levo - rotatory?

9. Discuss the degradation evidence for in structure of cocaine.
10. Explain natural products with special reference of alkaloids.