



B42 Series Regulator

Residential and Light Commercial Regulator

The B42 is a spring loaded self-operated regulator with internal relief option. The B42 features a molded diaphragm, 6:1 lever ratio and one inch vent. The benefit is a lighter more compact unit that provides the power, capacity and relief performance of larger regulators.

APPLICATIONS

Consistent pressure reduction of gas for typical domestic and light commercial applications.

OPTION DESIGNATIONS

- » N No Internal Relief
- » R Internal Relief
- » HP Available – See spring chart

B42N

» The B42N is a spring-loaded, self-operated regulator with no internal relief (N) valve. This model can be used on low or intermediate inlet pressures where an internal relief or other type of over-pressure protection device is not required.

B42 CAST IRON

» The B42 Cast Iron is a version of the B42 with a cast iron diaphragm case that can be used in a pit or curb vault application.

B42R

» The B42R is the internal relief (R) version of the B42 Series. The large 1" internal relief valve provides exceptional relief capacity.

DESIGNED TO INCREASE YOUR CUSTOMER'S SATISFACTION AND REDUCE YOUR TOTAL COSTS

» The model B42 is uniquely constructed to give utilities the edge they need in an increasingly complex and competitive market place. The model B42 excels with benefits of size, safety, performance, and cost. The B42 also offers three connection versions providing the greatest flexibility for your regulations needs. In addition, due to inventory and manufacturing enhancements, this product can be delivered with unparalleled speed and scheduling dependability.

COMPACT SIZE

» While the model B42 is more compact than traditional regulators, it was also designed to meet customer expectations for safety and long field life. The B42 is designed to consolidate product usage for both residential and light commercial applications

FEATURES

- » Interchangeable aluminum orifice
- » 12.6 sq. in. of diaphragm area
- » Molded deep convolution diaphragm with o-ring seal
- » Plated steel 6:1 lever
- » One piece molded Buna-N valve seat
- » Delrin® vent valve with Buna-N seat
- » Spring-loaded internal relief valve assembly
- » 1" and ¾" threaded vent with stainless steel screen
- » Fiberglass reinforced polyethylene seal cap with integral relief valve stop
- » Field interchangeable adjustment spring



Model B42 Series regulators exceed all AGA/ANSI, B109.4/CSA 6.18, and Z21.80/CSA 6.22 specifications.

SHIPPING WEIGHT

B42: 12 regulators per box Box weight: 48 lbs.

B42 cast iron: 4 regulators per box Box weight: 32 lbs.

B42 DIMENSIONS (INCHES)/OPERATIONAL SCHEMATIC

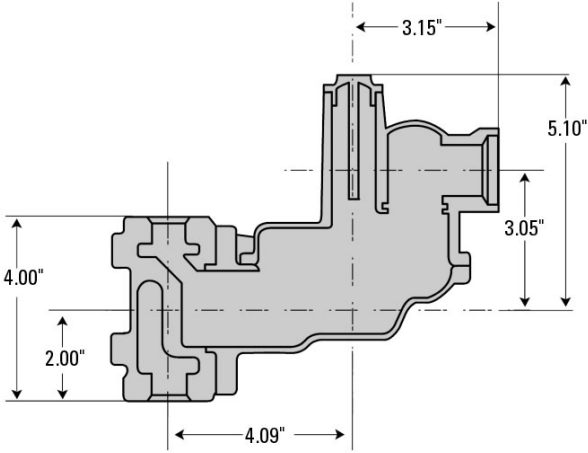

Straight body connection

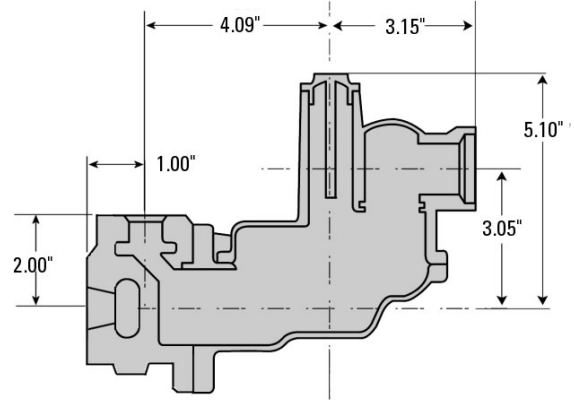

90° Angle body connection

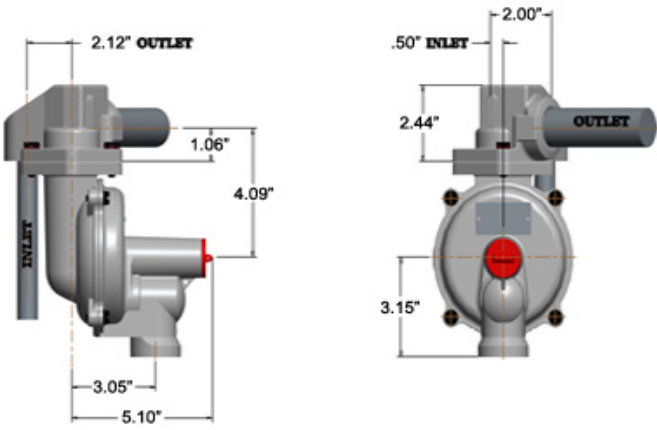

Compact body connection

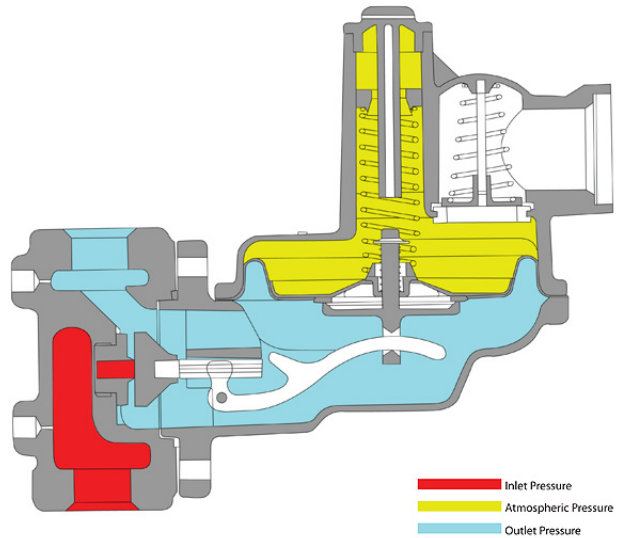

Operational schematic

SPRING DATA, SPRING COLOR OUTLET PRESSURE RANGE

Colors	Outlet Pressure Range**
Standard Spring Data	
Green	5 - 7" w.c.
Brown	6 - 8" w.c.
Blue	8 - 14" w.c.
Silver	12 - 28" w.c.
Yellow/Black	1 - 2 PSIG
Purple	1.25 - 2.25 PSIG
Alternate Spring Data	
Orange	5.5 - 9" w.c.
Dark Green	4 - 9" w.c.
High Pressure Spring Data	
Yellow	2 - 4 PSIG
White	4 - 5 PSIG
Relief Spring Data	
Purple	7" w.c. above set point
Orange	5" w.c. above set point
Red	6" w.c. above set point
Black	9" w.c. above set point

*Note Ranges are approximations. Please contact manufacturer to obtain the best spring for your application.

**Warning Adjustment springs are not interchangeable between B42 and B42HP.

ORIFICE DATA, WIDE OPEN FLOW COEFFICIENTS AND MAXIMUM PRESSURES

Orifice Size (inches)	K-Factor	MAOP	Emergency Inlet Pressure (PSIG)	Emergency Outlet Pressure (PSIG)	
				No damage++	Containment++
1/8	30	125 PSIG	300	30	60
1/8 x 3/16	30	125 PSIG	300	30	60
3/16	71	125 PSIG	200	30	60
1/4	127	60 PSIG	150	30	60
5/16	193	35 PSIG	100	30	60
3/8	290	20 PSIG	75	30	60
1/2	416	10 PSIG	40	30	60
1/2 x 9/16	416	10 PSIG	40	30	60

+ B42 cast iron regulator have a MAOP limited to 90 PSIG.

++ For maximum pressures, see the *Itron Regulator Pressure Ratings* brochure (TDC-0988-XXX).

OPERATING TEMPERATURE RANGE

- -20°F to 150°F
- Silicone valve seats available for applications below -20°F

ADDITIONAL SPECIFICATIONS

Available Vent Sizes	1" NPT, 3/4" NPT
Other Available Options	Seal wire to indicate unapproved tampering
	1/8" pipe plug tap on inlet side of valve body
	1/8" pipe plug tap on outlet side of valve body

CONSTRUCTION

Itron takes pride in delivering products with the utmost concern for safety, quality, and customer satisfaction.

Construction materials

Valve body	High tensile strength cast iron (ASTM A-126, Class A)
Orifice	Aluminum or brass
Valve seat	Buna-N or silicone
Valve stem	Die cast zinc
Lever pin	Stainless steel (Type 303)
Lever	Zinc and dichromate plated steel (AISI C1010)
Upper diaphragm plate	Zinc and dichromate plated steel (14 gage steel)
Lower diaphragm plate	Polyester
Diaphragm	Buna-N with reinforcing fabric
Vent valve/seat	Neoprene
Vent screen	Stainless steel (16 mesh)
Adjustment ferrule	Delrin
Seal cap	Fiberglass reinforced polyethylene
Diaphragm case	B42 N and R Regulator: Die cast aluminum (ASTM B85 Alloy SC84A) Cast Iron Regulator: High tensile strength cast iron (ASTM A-126, Class A)
Fastener plating	Dacromet with Plus Black

VALVE BODY SIZES

Inlet (inches)	Outlet (inches)	Compact	90° Angle	Straight
1/2	1/2	---	X	X
1/2	3/4	---	X	X
1/2	1	---	X	X
3/4	3/4	X	X	X
3/4	1	X	X	X
3/4	1-1/4	---	---	X
1	1	---	X	X
1	1-1/4	---	---	X
1-1/4	1-1/4	---	---	X

Note X indicates that the valve body is available in that configuration.

COMPLIANCE

B42 (internal relief model) compliance with ANSI Z21.80, Line Pressure Regulators

Model B42R used with a 1" vent connection is compliant with ANSI Z21.80 in the configurations noted and shown in the following tables.

With inlet pressures up to 2 PSIG, the B42R is compliant in any configuration.

With inlet pressures up to 5 PSIG:

Orifice Size	Set Point	Maximum Vent Line Length (ft.)*	Number of Elbows**
1/8"	Up to 1 PSIG	50	4 or less
1/8" x 3/16"	Up to 1 PSIG	50	4 or less
3/16"	Up to 1 PSIG	40	4 or less
1/4"	Up to 7" w.c.	40	4 or less
5/16"	Up to 7" w.c.	15	4 or less

*Clean 1" black steel pipe

** For each elbow greater than 4 elbows, subtract 2.6 ft. from the maximum vent line length.

With inlet pressures up to 10 PSIG:

Orifice Size	Set Point	Maximum Vent Line Length (ft.)*	Number of Elbows**
1/8"	Up to 14" w.c.	50	4 or less
1/8" x 3/16"	Up to 14" w.c.	50	4 or less
3/16"	Up to 14" w.c.	50	4 or less
1/4"	Up to 7" w.c.	10	4 or less

*Clean 1" black steel pipe

** For each elbow greater than 4 elbows, subtract 2.6 ft. from the maximum vent line length.

CORRECTION FACTORS FOR NON-NATURAL GAS APPLICATIONS

The B42 may be used to control gases other than natural gas. To determine the capacity for gases other than natural gas, multiply the values within the capacity tables by a correction factor. The table below lists the correction factors for some of the more common gases:

Gas Type	Specific Gravity	Correction Factor (CF)
Air	1.00	0.77
Butane	2.01	0.55
Carbon Dioxide (Dry)	1.52	0.63
Carbon Monoxide (Dry)	0.97	0.79
Natural Gas	0.60	1.00
Nitrogen	0.97	0.79
Propane	1.53	0.63
Propane-Air-Mix	1.20	0.71

To calculate the correction factor for gases not listed in the table above, use the gases' specific gravity and insert it in the formula listed below:

$$\text{Correction Factor (CF)} = \sqrt{\frac{SG_1}{SG_2}}$$

Where:

SG_1 = Specific gravity of the gas in which the capacity is published.

SG_2 = Specific gravity of the gas to be controlled.

Wide Open Flow Calculations

For wide-open orifice flow calculations use the following equations:

For $\frac{P_1}{P_2} < 1.89$ use: $Q = K\sqrt{P_2(P_1 - P_2)}$

For $\frac{P_1}{P_2} > 1.89$ use: $Q = \frac{KP_1}{2}$

Where: P_1 = Absolute Inlet Pressure (PSIA)

P_2 = Absolute Outlet Pressure (PSIA)

Q = Flow Rate (SCFH)

K = Orifice Coefficient (SCFH/PSI)

B42 SERIES RESIDENTIAL REGULATOR, MODELS N AND R

7" w.c. (17 mbar) Capacity Table (1" Droop*), 3/4" Outlet Valve Bodies

Capacities in SCFH (m3/hr) of 0.6 S.G. gas; base conditions of 14.7 PSIA and 60° F.

Typical Capacity Info.		Inlet Pressure		Orifice Size							
Manufacturer	Itron	PSIG	BAR	1/8"	1/8 x 3/16"	3/16"	1/4"	5/16"	3/8"	1/2"	1/2 x 9/16"
Type and model	B42 R	0.5	0.038	55 (1.6)	60 (1.7)	70 (2.0)	80 (2.3)	95 (2.7)	210 (5.9)	270 (7.6)	280 (7.9)
Regulator		1	0.069	60 (1.7)	80 (2.3)	85 (2.4)	200 (5.7)	275 (7.8)	300 (8.5)	360 (10.2)	385 (10.9)
Inlet size:	3/4" NPT	2	0.1	80 (2.3)	95 (2.7)	225 (6.4)	250 (7.1)	365 (10.3)	425 (12.0)	495 (14.0)	485 (13.7)
Outlet size	3/4" NPT	3	0.2	105 (3.0)	225 (6.4)	290 (8.2)	350 (9.9)	470 (13.3)	525 (14.9)	595 (16.8)	595 (16.8)
Spring color	Brown	5	0.3	210 (5.9)	280 (7.9)	400 (11.3)	500 (14.2)	600 (17.0)	715 (20.2)	805 (22.8)	830 (23.5)
Position	5	10	0.7	340 (9.6)	390 (11.0)	600 (17.0)	850 (24.1)	940 (26.6)	1085 (30.7)	1300 (36.8)	1310 (37.1)
		15	1.0	425 (12.0)	470 (13.3)	850 (24.1)	1100 (31.1)	1300 (36.8)	1415 (40.1)		
		20	1.4	550 (15.6)	550 (15.6)	1045 (29.6)	1300 (36.8)	1500 (42.5)	1420 (40.2)		
		30	2.1	700 (19.8)	700 (19.8)	1400 (39.6)	1600 (45.3)	1800 (51.0)			
		40	2.8	850 (24.1)	870 (24.6)	1700 (48.1)	1900 (53.8)				
		50	3.5	1000 (28.3)	1020 (28.9)	1900 (63.8)	200 (56.6)				
		60	4.1	1150 (32.6)	1190 (33.7)	2000 (56.6)	2100 (59.5)				
		80	5.5	1500 (42.5)	1475 (41.8)	2200 (62.3)					
		100	6.9	1800 (51.0)	1475 (41.8)	2000 (56.6)					
		125	8.6	2150 (62.3)	1475 (41.8)	2000 (56.6)					

Inlet Effect A (inches w.c.)	0.1	0.2	0.3	0.4	0.4	0.6	0.8	1.0
Lock Up B (inches w.c.)	0.4	0.4	0.4	0.5	0.6	0.6	0.9	1.1

Notes:

A. Change in outlet pressure for 10 PSIG inlet pressure change.

B. Outlet pressure increase required for lock up.

*Individual regulator performance may vary from data shown.

Do not operate orifice in shaded inlet pressure area.

B42 SERIES RESIDENTIAL REGULATOR, MODELS N AND R

7" w.c. (17 mbar) Capacity Table (1" Droop*), 1" Valve Bodies

Capacities in SCFH (m3/hr) of 0.6 S.G. gas; base conditions of 14.7 PSIA and 60° F.

Typical Capacity Info.

Manufacturer	Itron
Type and model	B42 R
Regulator	
Inlet size:	3/4" NPT
Outlet size	1 NPT
Spring color	Brown
Position	5

Inlet Pressure		Orifice Size							
PSIG	BAR	1/8"	1/8 x 3/16"	3/16"	1/4"	5/16"	3/8"	1/2"	1/2 x 9/16"
0.5	0.038	65 (1.8)	70 (2.0)	90 (2.5)	140 (3.9)	175 (4.9)	210 (5.9)	270 (7.6)	280 (7.9)
1	0.069	80 (2.3)	110 (3.1)	140 (3.9)	200 (5.7)	275 (7.8)	300 (8.5)	400 (11.3)	450 (12.7)
2	0.1	100 (2.8)	180 (5.1)	225 (6.4)	250 (7.1)	375 (10.6)	425 (12.0)	600 (17.0)	700 (19.8)
3	0.2	170 (4.8)	225 (6.4)	310 (8.8)	350 (9.9)	500 (14.2)	575 (16.3)	800 (22.7)	910 (25.8)
5	0.3	215 (6.1)	280 (7.9)	400 (11.3)	500 (14.2)	725 (20.5)	825 (23.4)	1100 (31.1)	1230 (34.8)
10	0.7	340 (9.6)	390 (11.0)	625 (17.7)	850 (24.1)	1100 (31.1)	1300 (36.8)	1550 (43.9)	1720 (48.7)
15	1.0	425 (12.0)	470 (13.3)	850 (24.1)	1200 (34.0)	1550 (43.9)	1650 (46.7)		
20	1.4	550 (15.6)	550 (15.6)	1100 (31.1)	1450 (41.1)	1850 (52.4)	2000 (56.6)		
30	2.1	700 (19.8)	700 (19.8)	1400 (39.6)	2000 (56.6)	2300 (65.1)			
40	2.8	850 (24.1)	870 (24.6)	1750 (49.6)	2200 (62.3)				
50	3.5	1000 (28.3)	1020 (28.9)	2150 (60.9)	2500 (70.8)				
60	4.1	1150 (32.6)	1190 (33.7)	2300 (65.1)	2500 (70.8)				
80	5.5	1500 (42.5)	1590 (45.0)	2400 (68.0)					
100	6.9	1800 (51.0)	1870 (53.0)	2500 (70.8)					
125	8.6	2200 (62.3)	2280 (63.0)	2500 (70.8)					

Inlet Effect A (inches w.c.)	0.13	0.13	0.20	0.36	0.67	0.77	2.20	2.20
Lock Up B (inches w.c.)	0.5	0.5	0.6	0.7	0.8	0.9	1.2	1.2

Notes:

- A. Change in outlet pressure for 10 PSIG inlet pressure change.
- B. Outlet pressure increase required for lock up.

*Individual regulator performance may vary from data shown.

Do not operate orifice in shaded inlet pressure area.

B42 SERIES RESIDENTIAL REGULATOR, MODELS N AND R

7" w.c. (17 mbar) Capacity Table (1" Droop*), 1-1/4" Outlet Valve Bodies

Capacities in SCFH (m3/hr) of 0.6 S.G. gas; base conditions of 14.7 PSIA and 60° F.

Typical Capacity Info.		Inlet Pressure		Orifice Size								
		PSIG	BAR	1/8"	1/8 x 3/16"	3/16"	1/4"	5/16"	3/8"	1/2"	1/2 x 9/16"	
Manufacturer	Itron											
Type and model	B42 R											
Regulator												
Inlet size:	3/4" NPT											
Outlet size:	1-1/4" NPT											
Spring color:	Brown											
Position	5											
		0.5	0.038	65 (1.8)	70 (2.0)	90 (2.5)	140 (3.9)	175 (4.9)	300 (8.4)	310 (8.7)	320 (9)	
		1	0.069	80 (2.3)	110 (3.1)	140 (3.9)	300 (8.4)	320 (9)	325 (9.2)	400 (11.3)	450 (12.7)	
		2	0.1	100 (2.8)	180 (5.1)	320 (9)	330 (9.3)	410 (11.6)	460 (13.0)	530 (15.0)	535 (15.1)	
		3	0.2	170 (4.8)	310 (8.7)	340 (9.6)	430 (12.1)	520 (14.7)	580 (16.4)	800 (22.7)	910 (25.7)	
		5	0.3	300 (8.4)	410 (11.6)	470 (13.3)	510 (14.4)	725 (20.5)	870 (24.6)	1100 (31.1)	1230 (34.8)	
		10	0.7	380 (10.7)	550 (15.5)	700 (19.8)	850 (24.1)	1130 (31.9)	1500 (42.5)	1560 (44.1)	1720 (48.7)	
		15	1.0	500 (14.1)	670 (18.9)	970 (27.5)	1210 (34.3)	1560 (44.1)	1750 (49.5)			
		20	1.4	600 (16.9)	800 (22.7)	1250 (35.4)	1540 (43.6)	2060 (58.3)	2400 (67.9)			
		30	2.1	770 (21.8)	1020 (28.8)	1650 (46.7)	2300 (65.1)	2500 (70.8)				
		40	2.8	960 (26.3)	1230 (34.8)	1760 (49.8)	2500 (70.8)					
		50	3.5	1120 (31.7)	1470 (41.6)	2260 (63.9)	2500 (70.8)					
		60	4.1	1270 (35.9)	1720 (48.7)	2500 (70.8)	2500 (70.8)					
		80	5.5	1580 (44.7)	2180 (61.7)	2500 (70.8)						
		100	6.9	1900 (53.8)	2500 (70.8)	2500 (70.8)						
		125	8.6	2300 (65.1)	2500 (70.8)	2500 (70.8)						

Inlet Effect A (inches w.c.)	0.13	0.13	0.20	0.36	0.67	0.77	2.20	2.20
Lock Up B (inches w.c.)	0.5	0.5	0.6	0.7	0.8	0.9	1.2	1.2

Notes:

A. Change in outlet pressure for 10 PSIG inlet pressure change.

B. Outlet pressure increase required for lock up.

*Individual regulator performance may vary from data shown.

Do not operate orifice in shaded inlet pressure area.

B42 PERFORMANCE CURVES

7" w.c. Set Point

Type and model	B42 R
Inlet size	3/4" NPT
Outlet size	1" NPT
Orifice size	3/16"
Spring	Brown

All test results are reported at a base of 14.7 PSIA at 60° F and with 0.6 S.G. gas.

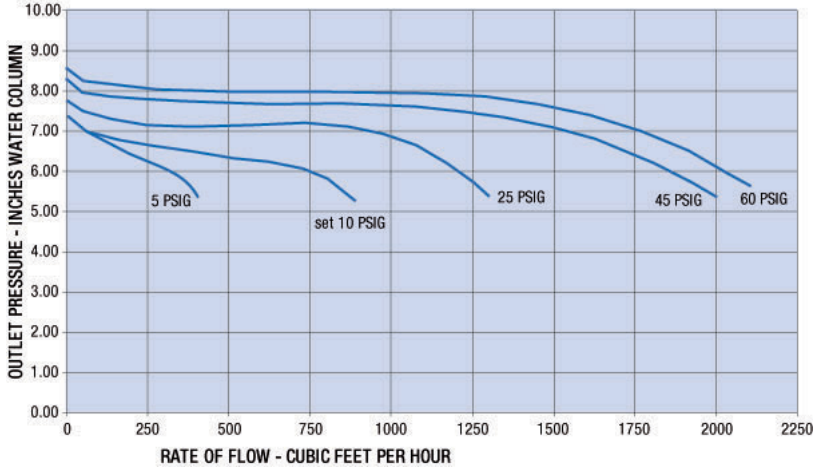

RELIEF CURVES

7" w.c. Set Point

Inlet size	3/4" NPT
Outlet size	1" NPT
Vent size	3/4" NPT

All test results are reported at a base of 14.7 PSIA at 60° F and with 0.6 S.G. gas.

Regulator set at 7.0" w.c. for relief testing with 40 PSI inlet pressure @ 50 SCFH as per ANSI B109.4.

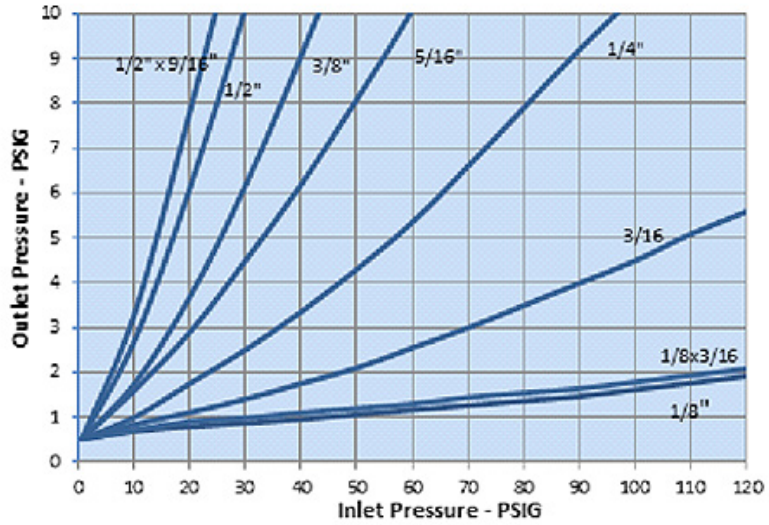

7" w.c. Set Point

Inlet size	3/4" NPT
Outlet size	1" NPT
Vent size	1" NPT

All test results are reported at a base of 14.7 PSIA at 60° F and with 0.6 S.G. gas.

Regulator set at 7.0" w.c. for relief testing with 40 PSI inlet pressure @ 50 SCFH as per ANSI B109.4.

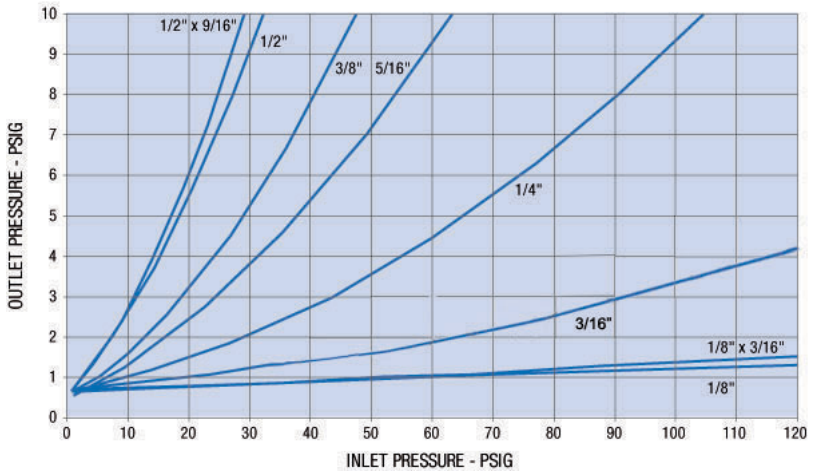

B42 SERIES COMMERCIAL REGULATOR, MODELS N AND R

14" w.c. (34 mbar) Capacity Table (2" Droop*), 3/4" Outlet Valve Bodies

Capacities in SCFH of 0.6 S.G. gas; base conditions of 14.7 PSIA and 60° F.

Typical Capacity Info.

Manufacturer	Itron
Type and model	B42 N, R
Regulator	
Inlet size	3/4" NPT
Outlet size	3/4" NPT
Spring color	Silver
Position	5

Inlet Pressure		Orifice Size							
PSIG	BAR	1/8"	1/8 x 3/16"	3/16"	1/4"	5/16"	3/8"	1/2"	1/2 x 9/16"
1	0.069	-	-	-	105 (3.0)	270 (7.6)	230 (6.5)	365 (10.3)	420 (11.9)
2	0.1	-	100 (2.8)	220 (6.2)	300 (8.5)	385 (10.9)	450 (12.7)	550 (15.6)	590 (16.7)
3	0.2	95 (2.7)	110 (3.1)	270 (7.6)	445 (12.6)	445 (12.6)	515 (14.6)	650 (18.4)	720 (20.4)
5	0.4	150 (4.2)	280 (7.9)	390 (11.0)	540 (15.3)	625 (17.7)	740 (21.0)	880 (24.9)	930 (26.3)
10	0.7	360 (10.2)	390 (11.0)	570 (16.1)	820 (23.2)	960 (27.2)	1100 (31.1)	1225 (34.7)	1270 (36.0)
15	1.0	460 (13.0)	500 (14.2)	780 (22.1)	1070 (30.3)	1250 (35.4)	1350 (38.2)		
20	1.4	560 (15.9)	590 (16.7)	1000 (28.3)	1320 (37.4)	1425 (40.4)	1575 (44.6)		
30	2.1	740 (21.0)	750 (21.2)	1320 (37.4)	1640 (46.4)	1750 (49.6)			
40	2.8	910 (25.8)	920 (26.1)	1600 (45.3)	1950 (55.2)				
50	3.5	1050 (29.7)	1100 (31.1)	1800 (51.1)	2080 (58.9)				
60	4.1	1230 (34.8)	1260 (35.7)	1950 (55.2)	2200 (62.3)				
80	5.5	1550 (43.9)	1550 (43.9)	2000 (56.6)					
100	6.9	1640 (46.4)	1880 (53.2)	2000 (56.6)					
125	8.6	2150 (60.9)	2150 (60.9)	2150 (60.9)					

Inlet Effect A (inches w.c.)	0.2	0.4	0.4	0.5	0.7	0.7	2.3	2.3
Lock Up B (inches w.c.)	0.6	0.6	0.7	0.8	0.9	1.0	1.3	1.3

Notes:

- A. Change in outlet pressure for 10 PSIG inlet pressure change.
- B. Outlet pressure increase required for lock up.

*Individual regulator performance may vary from data shown.

Do not operate orifice in shaded inlet pressure area.

B42 SERIES RESIDENTIAL REGULATOR, MODELS N AND R

14" w.c. (34 mbar) Capacity Table (2" Droop*) , 1" Outlet Valve Bodies

Capacities in SCFH of 0.6 S.G. gas; base conditions of 14.7 PSIA and 60° F.

Typical Capacity Info.

Manufacturer	Itron
Type and model	B42 N, R
Regulator	
Inlet size	3/4" NPT
Outlet size	1" NPT
Spring color	Silver
Position	5

Inlet Pressure		Orifice Size								
		1/8"	1/8 x 3/16"	3/16"	1/4"	5/16"	3/8"	1/2"	1/2 x 9/16"	
PSIG	BAR									
1	0.069	-	-	-	190 (5.4)	270 (7.7)	280 (7.9)	550 (15.6)	575 (16.3)	
2	0.1	-	190 (5.4)	220 (6.2)	300 (8.5)	430 (12.2)	450 (12.7)	820 (23.2)	860 (24.4)	
3	0.2	160 (4.5)	215 (6.1)	300 (8.5)	380 (10.8)	550 (15.6)	560 (15.9)	1030 (29.1)	1080 (30.6)	
5	0.4	230 (6.5)	280 (7.9)	390 (11.0)	550 (15.6)	710 (20.1)	740 (21.0)	1230 (34.8)	1310 (37.1)	
10	0.7	370 (10.5)	390 (11.0)	600 (17.0)	820 (23.2)	1050 (29.7)	1130 (32.0)	1650 (45.5)	1680 (47.6)	
15	1.0	460 (13.0)	525 (14.9)	800 (22.7)	1070 (30.3)	1340 (37.9)	1460 (41.3)			
20	1.4	610 (17.3)	700 (19.8)	1000 (28.3)	1320 (37.4)	1630 (46.1)	1800 (51.0)			
30	2.1	800 (22.7)	890 (25.2)	1340 (37.9)	1750 (49.6)	1950 (55.2)				
40	2.8	1030 (29.1)	1150 (32.6)	1750 (49.6)	2050 (58.1)					
50	3.5	1200 (34.0)	1300 (36.8)	2010 (56.9)	2300 (65.1)					
60	4.1	1310 (37.1)	1425 (40.4)	2250 (63.7)	2500 (70.8)					
80	5.5	1900 (53.8)	2000 (56.6)	2580 (73.1)						
100	6.9	2200 (62.3)	2275 (64.4)	2700 (76.5)						
125	8.6	2200 (62.3)	2275 (64.4)	2900 (82.1)						

Inlet Effect A (inches w.c.)	0.12	0.12	0.22	0.33	0.50	0.71	2.3	2.3
Lock Up B (inches w.c.)	0.6	0.6	0.7	0.8	0.9	1.0	1.3	1.3

Notes:

- A. Change in outlet pressure for 10 PSIG inlet pressure change.
- B. Outlet pressure increase required for lock up.

*Individual regulator performance may vary from data shown.

 Do not operate orifice in shaded inlet pressure area.

B42 SERIES RESIDENTIAL REGULATOR, MODELS N AND R

14" w.c. (34 mbar) Capacity Table (2" Droop*) , 1-1/4" Outlet Valve Bodies

Capacities in SCFH of 0.6 S.G. gas; base conditions of 14.7 PSIA and 60° F.

Typical Capacity Info.

Manufacturer	Itron
Type and model	B42 N, R
Regulator	
Inlet size	3/4" NPT
Outlet size	1-1/4" NPT
Spring color	Silver
Position	5

Inlet Pressure		Orifice Size							
PSIG	BAR	1/8"	1/8 x 3/16"	3/16"	1/4"	5/16"	3/8"	1/2"	1/2 x 9/16"
1	0.069	-	-	-	270 (7.6)	285 (8.1)	300 (8.5)	560 (15.8)	590 (16.7)
2	0.1	-	250 (7.1)	300 (8.5)	320 (9.1)	380 (10.8)	460 (13)	830 (23.5)	875 (24.8)
3	0.2	160 (4.5)	270 (7.6)	320 (9.1)	420 (11.9)	480 (13.6)	570 (16.1)	1040 (29.4)	1090 (30.8)
5	0.4	230 (6.5)	370 (10.5)	400 (11.3)	560 (15.8)	720 (20.3)	750 (21.2)	1400 (39.6)	1510 (42.7)
10	0.7	370 (10.5)	560 (15.8)	610 (17.3)	830 (23.5)	1100 (31.1)	1170 (33.1)	1670 (47.3)	1700 (48.1)
15	1.0	465 (13.1)	680 (19.2)	820 (23.2)	1120 (31.7)	1360 (38.5)	1630 (46.1)		
20	1.4	620 (17.5)	800 (22.7)	1010 (28.6)	1380 (39)	1670 (47.3)	2020 (57.2)		
30	2.1	810 (22.9)	1020 (28.8)	1480 (41.9)	2060 (58.3)	2300 (65.1)			
40	2.8	1040 (29.4)	1260 (35.6)	2080 (36.2)	2700 (76.5)				
50	3.5	1210 (34.2)	1470 (41.6)	2400 (67.9)	3100 (87.7)				
60	4.1	1320 (37.4)	1720 (48.7)	2740 (77.5)	3400 (96.2)				
80	5.5	1950 (55.2)	2170 (61.4)	3410 (96.5)					
100	6.9	2210 (62.5)	2540 (71.9)	4000 (113.2)					
125	8.6	2250 (63.7)	2600 (73.6)	4300 (121.7)					

Inlet Effect A (inches w.c.)	0.12	0.12	0.22	0.33	0.50	0.71	2.3	2.3
Lock Up B (inches w.c.)	0.6	0.6	0.7	0.8	0.9	1.0	1.3	1.3

Notes:

- A. Change in outlet pressure for 10 PSIG inlet pressure change.
- B. Outlet pressure increase required for lock up.

*Individual regulator performance may vary from data shown.

 Do not operate orifice in shaded inlet pressure area.

B42 PERFORMANCE CURVES

14" w.c. Set Point

Type and model B42 N, R

Inlet size 3/4" NPT

Outlet size 1" NPT

Orifice size 3/16"

Spring Silver

All test results are reported at a base of 14.7 PSIA at 60° F and with 0.6 S.G. gas.

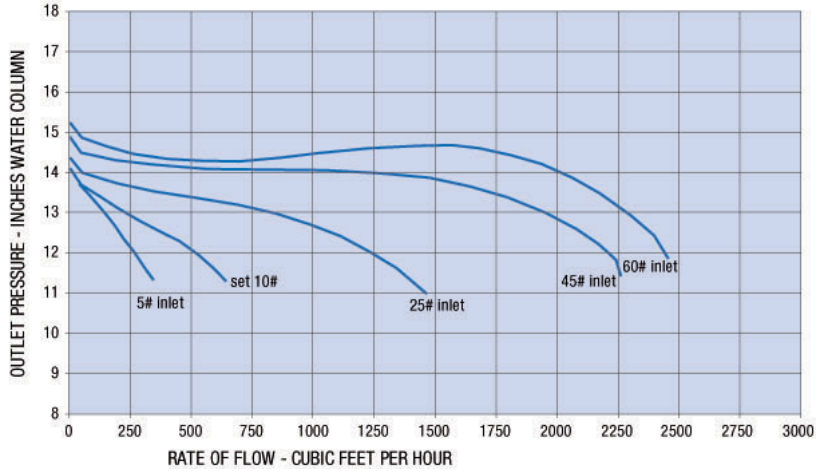

RELIEF CURVES

14" w.c. Set Point

Inlet size 3/4" NPT

Outlet size 1" NPT

Vent size 3/4" NPT

All test results are reported at a base of 14.7 PSIA at 60° F and with 0.6 S.G. gas.

Regulator set at 14.0" w.c. for relief testing with 10 PSIG @ 50 SCFH inlet pressure

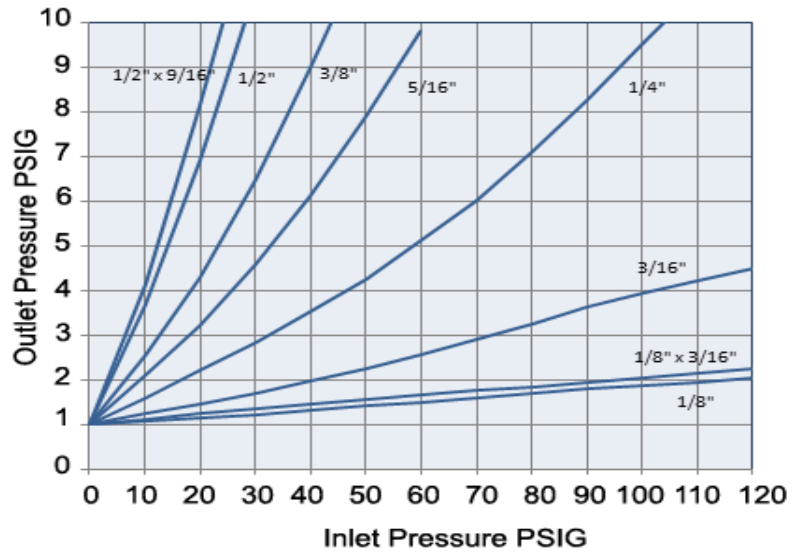

14" w.c. Set Point

Inlet size 3/4" NPT

Outlet size 1" NPT

Vent size 1" NPT

All test results are reported at a base of 14.7 PSIA at 60° F and with 0.6 S.G. gas.

Regulator set at 14.0" w.c. for relief testing with 10 PSIG @ 50 SCFH inlet pressure.

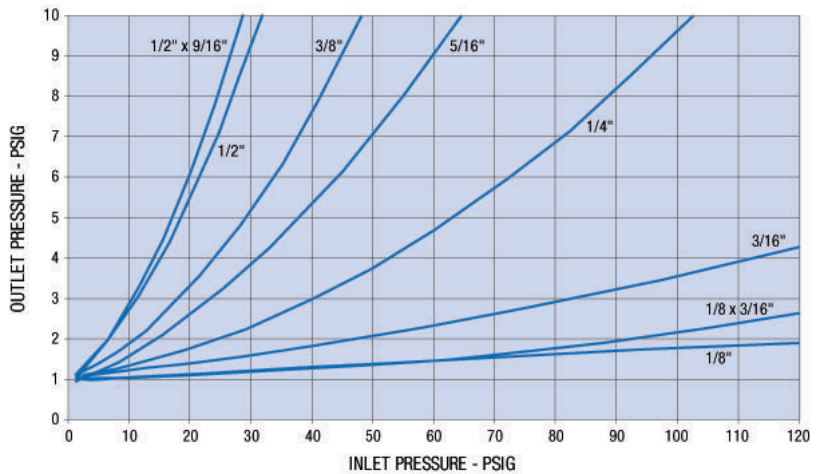

B42 SERIES COMMERCIAL REGULATOR, MODELS N AND R

1 PSIG (69 mbar) Capacity Table (1% Absolute Droop*), 3/4" Outlet Valve Bodies

Capacities in SCFH (m3/hr) of 0.6 S.G. gas; base conditions of 14.7 PSIA and 60° F.

Typical Capacity Info.

Manufacturer	Itron
Type and model	B42 R
Inlet size	3/4" NPT
Outlet size	3/4" NPT
Spring color	Silver
Position	5

Inlet Pressure		Orifice Size								
PSIG	BAR	1/8"	1/8 x 3/16"	3/16"	1/4"	5/16"	3/8"	1/2"	1/2 x 9/16"	
2	0.1	89 (2.5)	115 (3.3)	230 (6.5)	300 (8.5)	330 (9.3)	420 (11.9)	455 (12.9)	475 (13.5)	
3	0.2	115 (3.3)	160 (4.5)	280 (7.9)	350 (9.9)	410 (11.6)	540 (15.3)	615 (17.4)	670 (19.0)	
5	0.4	230 (6.5)	275 (7.8)	340 (9.6)	490 (13.9)	580 (16.4)	700 (19.8)	790 (22.4)	975 (27.6)	
10	0.7	365 (9.5)	410 (11.6)	520 (14.7)	770 (21.8)	870 (24.6)	1130 (32.0)	1145 (32.4)	1330 (37.7)	
15	1.0	440 (12.5)	510 (14.4)	730 (20.7)	1050 (29.7)	1190 (33.7)	1390 (39.4)			
20	1.4	535 (15.1)	590 (16.7)	890 (25.2)	1290 (36.5)	1400 (39.6)	1620 (45.9)			
30	2.1	715 (20.2)	760 (21.5)	1150 (32.6)	1630 (46.2)	1740 (49.3)				
40	2.8	910 (25.8)	930 (26.3)	1525 (43.2)	1900 (53.8)					
50	3.5	1080 (30.6)	1100 (31.1)	1740 (49.3)	2140 (60.6)					
60	4.1	1235 (35.0)	1260 (35.7)	1910 (54.1)	2250 (63.7)					
80	5.5	1550 (43.9)	1580 (44.7)	2100 (59.5)						
100	6.9	1660 (47)	1850 (52.4)	2150 (60.9)						
125	8.6	1760 (49.8)	1950 (55.2)	2160 (61.2)						

Inlet Effect A (PSIG)	0.03	0.03	0.03	0.03	0.04	0.04	0.05	0.05
Lock Up B (PSIG)	0.05	0.05	0.07	0.08	0.09	0.11	0.13	0.13

Notes:

A. Change in outlet pressure for 10 PSIG inlet pressure change.

B. Outlet pressure increase required for lock up.

*Individual regulator performance may vary from data shown.

Do not operate orifice in shaded inlet pressure area.

B42 SERIES RESIDENTIAL REGULATOR, MODELS N AND R

1 PSIG (69 mbar) Capacity Table (2% Droop*), 3/4" Outlet Valve Bodies

Capacities in SCFH (m3/hr) of 0.6 S.G. gas; base conditions of 14.7 PSIA and 60° F.

Typical Capacity Info.		Inlet Pressure		Orifice Size							
		PSIG	BAR	1/8"	1/8 x 3/16"	3/16"	1/4"	5/16"	3/8"	1/2"	1/2 x 9/16"
Manufacturer	Itron	2	0.1	100 (2.8)	130 (3.7)	250 (7.1)	460 (13.0)	550 (15.6)	670 (19.8)	790 (19.0)	850 (24.1)
Type and model	B42R	3	0.2	170 (4.8)	225 (6.4)	390 (11.0)	570 (16.1)	690 (19.5)	850 (24.1)	1030 (29.2)	1120 (31.7)
Inlet size	3/4" NPT	5	0.4	260 (7.4)	315 (8.9)	520 (14.7)	760 (21.5)	950 (26.9)	1120 (31.7)	1265 (35.8)	1440 (40.8)
Outlet size	3/4" NPT	10	0.7	380 (10.8)	420 (11.9)	760 (21.5)	1200 (34.0)	1350 (38.2)	1600 (45.3)	1790 (50.7)	1830 (51.8)
Spring color	Silver	15	1.0	490 (13.9)	510 (14.4)	1030 (29.2)	1490 (42.2)	1700 (48.1)	1890 (53.5)		
Position	5	20	1.4	575 (16.3)	600 (17.0)	1250 (35.4)	1750 (49.6)	1930 (54.7)	2110 (59.7)		
		30	2.1	735 (20.8)	760 (21.5)	1600 (45.3)	2100 (59.5)	2300 (65.1)			
		40	2.8	910 (25.8)	930 (26.3)	1935 (54.8)	2400 (68.0)				
		50	3.5	1075 (30.4)	1100 (31.1)	2205 (62.4)	2680 (75.9)				
		60	4.1	1235 (35.0)	1260 (35.7)	2430 (68.8)	2830 (80.1)				
		80	5.5	1555 (44.0)	1595 (45.2)	2700 (76.5)					
		100	6.9	1880 (53.2)	1925 (54.5)	2700 (76.5)					
		125	8.6	2100 (59.5)	2260 (64.0)	2700 (76.5)					

Inlet Effect A (PSIG)	0.03	0.03	0.03	0.03	0.04	0.04	0.05	0.05
Lock Up B (PSIG)	0.05	0.05	0.07	0.08	0.09	0.11	0.13	0.13

Notes:

A. Change in outlet pressure for 10 PSIG inlet pressure change.

B. Outlet pressure increase required for lock up.

*Individual regulator performance may vary from data shown.

Do not operate orifice in shaded inlet pressure area.

B42 SERIES COMMERCIAL REGULATOR, MODELS N AND R

1 PSIG (69 mbar) Capacity Table (1% Absolute Droop*), 1" Outlet Valve Bodies

Capacities in SCFH (m3/hr) of 0.6 S.G. gas; base conditions of 14.7 PSIA and 60° F.

Typical Capacity Info.

Manufacturer	Itron
Type and model	B42 R
Inlet size	3/4" NPT
Outlet size	1" NPT
Spring color	Silver
Position	5

Inlet Pressure		Orifice Size							
PSIG	BAR	1/8"	1/8 x 3/16"	3/16"	1/4"	5/16"	3/8"	1/2"	1/2 x 9/16"
2	0.1	-	-	230 (6.5)	300 (8.5)	330 (9.3)	420 (11.9)	455 (12.9)	475 (13.5)
3	0.2	160 (4.5)	225 (6.4)	300 (8.5)	400 (11.3)	450 (12.7)	540 (15.3)	615 (17.4)	670 (19.0)
5	0.3	230 (6.5)	300 (8.5)	385 (10.9)	490 (13.9)	650 (18.4)	700 (19.8)	790 (22.4)	1035 (29.3)
10	0.7	365 (10.3)	425 (10.9)	570 (16.1)	770 (21.8)	1020 (28.9)	1130 (32.0)	1145 (32.4)	1575 (44.6)
15	1.0	460 (13.0)	550 (16.1)	770 (21.8)	1050 (29.7)	1270 (36.0)	1410 (39.9)		
20	1.4	570 (16.1)	675 (21.8)	980 (27.8)	1350 (38.2)	1550 (43.9)	1710 (48.4)		
30	2.1	780 (22.1)	875 (27.8)	1330 (37.7)	1850 (52.4)	2000 (56.6)			
40	2.8	980 (27.8)	1100 (31.2)	1760 (49.8)	2250 (63.7)				
50	3.5	1150 (32.6)	1225 (34.7)	2000 (56.6)	2600 (73.6)				
60	4.1	1270 (36.0)	1350 (38.2)	2400 (68.0)	2850 (80.7)				
80	5.5	1700 (48.1)	1900 (53.8)	2890 (81.8)					
100	6.9	1900 (53.8)	2150 (60.9)	3150 (89.2)					
125	8.6	2100 (59.5)	2275 (64.4)	3300 (93.5)					

Inlet Effect A (PSIG)	0.01	0.01	0.01	0.02	0.03	0.04	0.05	0.05
Lock Up B (PSIG)	0.05	0.05	0.07	0.08	0.09	0.11	0.13	0.13

Notes:

A. Change in outlet pressure for 10 PSIG inlet pressure change.

B. Outlet pressure increase required for lock up.

*Individual regulator performance may vary from data shown.

 Do not operate orifice in shaded inlet pressure area.

B42 SERIES RESIDENTIAL REGULATOR, MODELS N AND R

1 PSIG (69 mbar) Capacity Table (2% Absolute Droop*), 1" Outlet Valve Bodies

Capacities in SCFH (m3/hr) of 0.6 S.G. gas; base conditions of 14.7 PSIA and 60° F.

Typical Capacity Info.		Inlet Pressure		Orifice Size							
		PSIG	BAR	1/8"	1/8 x 3/16"	3/16"	1/4"	5/16"	3/8"	1/2"	1/2 x 9/16"
Manufacturer	Itron	2	0.14	-	-	250 (7.1)	480 (13.6)	610 (17.3)	700 (19.8)	790 (22.4)	850 (24.1)
Type and model	B42R	3	0.21	170 (4.8)	225 (6.4)	400 (11.3)	620 (17.6)	880 (24.9)	980 (27.8)	1070 (30.0)	1120 (31.7)
Inlet size	3/4" NPT	5	0.34	260 (7.4)	325 (9.2)	570 (16.1)	810 (22.9)	1060 (30.0)	1200 (34.0)	1265 (35.8)	1600 (45.3)
Outlet size	1" NPT	10	0.69	410 (11.6)	500 (14.2)	840 (23.8)	1270 (36.0)	1600 (45.3)	1850 (52.4)	2020 (57.2)	2220 (62.9)
Spring color	Silver	15	1.03	510 (14.4)	600 (17.0)	1050 (29.7)	1600 (45.3)	2000 (56.6)	2175 (61.6)		
Position	5	20	1.38	610 (17.3)	750 (21.2)	1260 (35.7)	2020 (57.2)	2400 (68.0)	2500 (70.8)		
		30	2.07	780 (22.1)	875 (24.8)	1630 (46.2)	2600 (73.6)	2900 (82.1)			
		40	2.76	980 (27.8)	1100 (31.2)	2000 (56.6)	3000 (85.0)				
		50	3.45	1150 (32.6)	1200 (33.9)	2410 (68.2)	3300 (93.5)				
		60	4.14	1270 (36.0)	1350 (38.2)	2750 (77.9)	3450 (97.7)				
		80	5.52	1700 (48.1)	1900 (53.8)	3410 (96.6)					
		100	6.89	1900 (53.8)	2150 (60.9)	3600 (101.9)					
		125	8.62	2100 (59.5)	2275 (64.4)	3800 (107.6)					

Inlet Effect A (PSIG)	0.01	0.01	0.01	0.02	0.03	0.04	0.05	0.05
Lock Up B (PSIG)	0.05	0.05	0.07	0.08	0.09	0.11	0.13	0.13

Notes:

A. Change in outlet pressure for 10 PSIG inlet pressure change.

B. Outlet pressure increase required for lock up.

*Individual regulator performance may vary from data shown.

[REDACTED] Do not operate orifice in shaded inlet pressure area.

B42 SERIES COMMERCIAL REGULATOR, MODELS N AND R

1 PSIG (69 mbar) Capacity Table (1% Absolute Droop*), 1-1/4" Outlet Valve Bodies

Capacities in SCFH (m3/hr) of 0.6 S.G. gas; base conditions of 14.7 PSIA and 60° F.

Typical Capacity Info.		Inlet Pressure		Orifice Size							
		PSIG	BAR	1/8"	1/8 x 3/16"	3/16"	1/4"	5/16"	3/8"	1/2"	1/2 x 9/16"
Manufacturer	Itron										
Type and model	B42 R	2	0.14	-	-	280 (7.9)	320 (9)	330 (9.3)	425 (12)	510 (14.4)	580 (16.4)
Inlet size	3/4" NPT	3	0.21	160 (4.5)	225 (6.4)	310 (8.7)	400 (11.3)	455 (12.8)	550 (15.5)	650 (18.4)	690 (19.5)
Outlet size	1-1/4" NPT	5	0.34	270 (7.6)	300 (8.5)	395 (11.1)	500 (14.1)	660 (18.6)	715 (20.2)	800 (22.6)	1045 (29.5)
Spring color	Silver	10	0.69	365 (10.3)	425 (10.9)	580 (16.4)	780 (22.1)	1030 (29.1)	1140 (32.2)	1270 (36)	1600 (45.3)
Position	5	15	1.03	465 (13.1)	560 (15.8)	775 (21.9)	1060 (30)	1275 (36.1)	1425 (40.3)		
		20	1.38	570 (16.1)	680 (19.2)	1000 (28.3)	1360 (38.5)	1575 (44.5)	1725 (48.8)		
		30	2.07	785 (22.2)	890 (25.2)	1350 (38.2)	1875 (53)	2030 (57.4)			
		40	2.76	985 (27.8)	1120 (31.7)	1775 (50.2)	2270 (64.2)				
		50	3.45	1155 (32.7)	1250 (35.3)	2100 (59.9)	2625 (74.3)				
		60	4.14	1280 (36.2)	1370 (38.7)	2570 (72.7)	2875 (81.4)				
		80	5.52	1710 (48.4)	2000 (56.6)	3380 (95.7)					
		100	6.89	1925 (54.5)	2200 (62.2)	3400 (96.2)					
		125	8.62	2200 (62.2)	2280 (64.5)	3600 (101.9)					

Inlet Effect A (PSIG)	0.01	0.01	0.01	0.02	0.03	0.04	0.05	0.05
Lock Up B (PSIG)	0.05	0.05	0.07	0.08	0.09	0.11	0.13	0.13

Notes:

A. Change in outlet pressure for 10 PSIG inlet pressure change.

B. Outlet pressure increase required for lock up.

*Individual regulator performance may vary from data shown.

 Do not operate orifice in shaded inlet pressure area.

B42 SERIES RESIDENTIAL REGULATOR, MODELS N AND R

1 PSIG (69 mbar) Capacity Table (2% Absolute Droop*), 1-1/4" Outlet Valve Bodies

Capacities in SCFH (m3/hr) of 0.6 S.G. gas; base conditions of 14.7 PSIA and 60° F.

Typical Capacity Info.		Inlet Pressure		Orifice Size							
		PSIG	BAR	1/8"	1/8 x 3/16"	3/16"	1/4"	5/16"	3/8"	1/2"	1/2 x 9/16"
Manufacturer	Itron	2	0.14	-	-	320 (9)	485 (13.7)	625 (17.6)	725 (20.5)	890 (25.2)	1000 (28.3)
Type and model	B42R	3	0.21	210 (5.9)	250 (7.1)	410 (11.6)	580 (16.4)	890 (25.2)	990 (28)	1100 (31.1)	1240 (35.1)
Inlet size	3/4" NPT	5	0.34	280 (7.9)	330 (9.3)	590 (16.7)	830 (23.5)	1075 (30.4)	1240 (35.1)	1400 (39.6)	1625 (46)
Outlet size	1-1/4" NPT	10	0.69	420 (11.8)	525 (14.8)	855 (24.2)	1290 (36.5)	1650 (46.7)	1890 (53.5)	2080 (58.9)	2300 (65.1)
Spring color	Silver	15	1.03	510 (14.4)	620 (17.5)	1075 (30.4)	1650 (46.7)	2100 (59.5)	2280 (64.5)		
Position	5	20	1.38	620 (17.5)	775 (21.9)	1270 (35.9)	2075 (58.7)	2450 (69.3)	2800 (79.2)		
		30	2.07	785 (22.2)	900 (25.4)	1660 (47)	2650 (75)	3000 (84.9)			
		40	2.76	990 (28)	1130 (31.9)	2020 (57.2)	3100 (87.7)				
		50	3.45	1175 (33.2)	1225 (34.6)	2450 (69.3)	3400 (96.2)				
		60	4.14	1275 (36.1)	1375 (38.9)	2800 (79.2)	3500 (99.1)				
		80	5.52	1710 (48.4)	2100 (59.5)	3550 (100.5)					
		100	6.89	1910 (54)	2200 (62.2)	4100 (116)					
		125	8.62	2150 (60.8)	2400 (67.9)	4300 (121.7)					

Inlet Effect A (PSIG)	0.01	0.01	0.01	0.02	0.03	0.04	0.05	0.05
Lock Up B (PSIG)	0.05	0.05	0.07	0.08	0.09	0.11	0.13	0.13

Notes:

A. Change in outlet pressure for 10 PSIG inlet pressure change.

B. Outlet pressure increase required for lock up.

*Individual regulator performance may vary from data shown.

Do not operate orifice in shaded inlet pressure area.

B42 PERFORMANCE CURVES

1 PSIG Set Point

Type and model B42 R

Inlet size 3/4" NPT

Outlet size 1" NPT

Spring Silver

All test results are reported at a base of 14.7 PSIA at 60° F and with 0.6 S.G. gas.

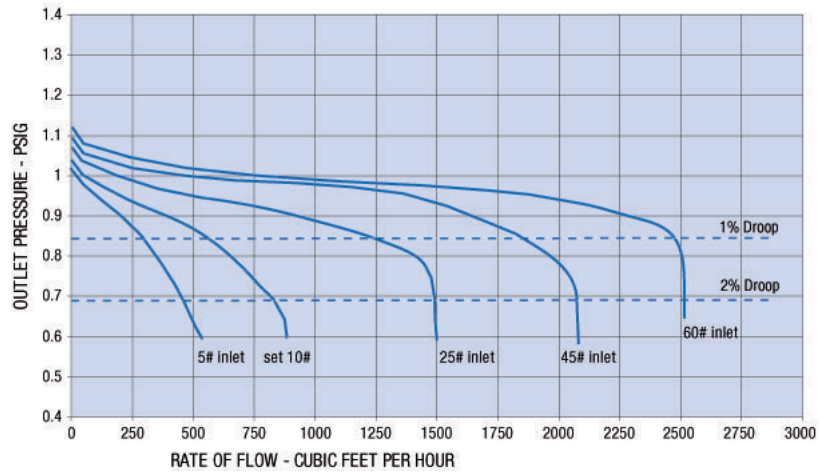

RELIEF CURVES

1 PSIG Set Point

Inlet size 3/4" NPT

Outlet size 1" NPT

Vent Size 3/4" NPT

All test results are reported at a base of 14.7 PSIA at 60° F and with 0.6 S.G. gas.

Regulator set at 1 PSIG for relief testing with 10 PSIG @ 50 SCFH inlet pressure

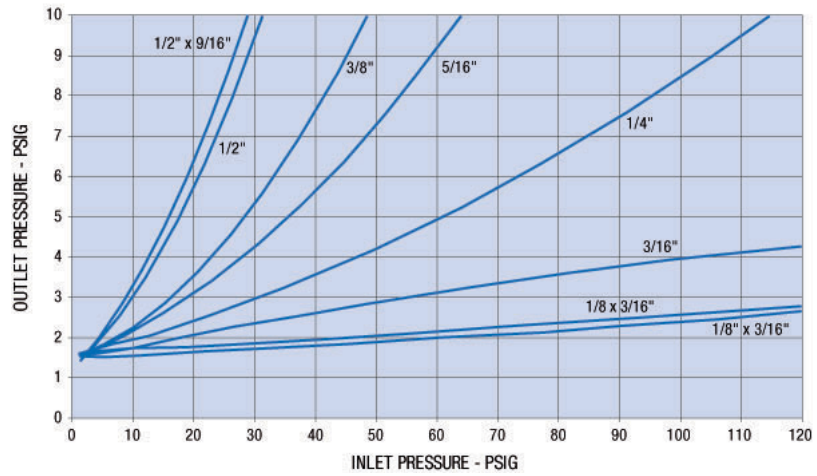

Inlet size 3/4" NPT

Outlet size 1" NPT

Vent size 1" NPT

All test results are reported at a base of 14.7 PSIA at 60° F and with 0.6 S.G. gas.

Regulator set at 1 PSIG for relief testing with 10 PSIG @ 50 SCFH inlet pressure.

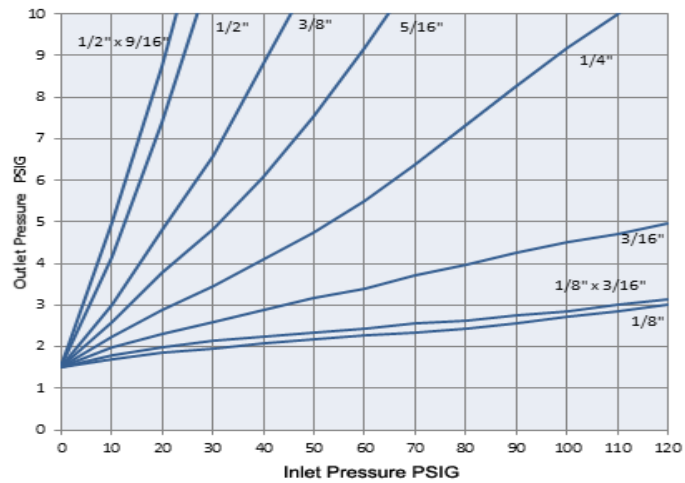

B42 SERIES RESIDENTIAL REGULATOR, MODELS N AND R

2 PSIG (0.14 mbar) Capacity Table (1% Absolute Droop*), 3/4" Outlet Valve Bodies

Capacities in SCFH (m3/hr) of 0.6 S.G. gas; base conditions of 14.7 PSIA and 60° F.

Typical Capacity Info.		Inlet Pressure		Orifice Size							
		PSIG	BAR	1/8"	1/8 x 3/16"	3/16"	1/4"	5/16"	3/8"	1/2"	1/2 x 9/16"
Manufacturer	Itron	3	0.21	75 (2.1)	105 (3.0)	105 (3.0)	200 (5.7)	230 (6.5)	280 (7.9)	320 (9.1)	340 (9.6)
Type and model	B42 R	5	0.34	135 (3.8)	170 (4.8)	220 (6.2)	290 (8.2)	370 (10.3)	420 (11.9)	480 (13.6)	575 (16.3)
Inlet size	3/4" NPT	10	0.69	230 (6.5)	295 (8.4)	370 (10.5)	490 (13.9)	730 (20.7)	750 (21.2)	840 (23.8)	1075 (30.4)
Outlet size	3/4" NPT	15	1.03	300 (8.5)	415 (11.8)	490 (13.9)	650 (18.4)	1000 (28.3)	1000 (28.3)		
Spring color	Yellow/black	20	1.38	370 (10.5)	540 (15.3)	600 (17.0)	840 (23.8)	1200 (34.0)	1200 (34.0)		
Position	5	30	2.07	500 (14.2)	700 (19.8)	860 (24.4)	1230 (34.8)	1600 (45.3)			
		40	2.76	600 (17.0)	880 (25.0)	1100 (31.2)	1575 (44.6)				
		50	3.45	800 (22.7)	1075 (30.4)	1400 (39.6)	1900 (53.8)				
		60	4.14	950 (27.0)	1250 (35.4)	1600 (45.3)	2120 (60.0)				
		80	5.52	1200 (34.0)	1530 (43.3)	1900 (53.8)					
		100	6.89	1600 (45.3)	1675 (47.4)	1900 (53.8)					
		125	8.62	1750 (49.5)	1900 (53.8)	2100 (59.5)					

Inlet Effect A (PSIG)	0.01	0.01	0.02	0.03	0.03	0.04	0.06	0.06
Lock Up B (PSIG)	0.06	0.06	0.08	0.09	0.10	0.12	0.14	0.14

Notes:

A. Change in outlet pressure for 10 PSIG inlet pressure change.

B. Outlet pressure increase required for lock up.

*Individual regulator performance may vary from data shown.

Do not operate orifice in shaded inlet pressure area.

B42 SERIES RESIDENTIAL REGULATOR, MODELS N AND R

2 PSIG (0.14 mbar) Capacity Table (2% Absolute Droop*), 3/4" Outlet Valve Bodies

Capacities in SCFH (m3/hr) of 0.6 S.G. gas; base conditions of 14.7 PSIA and 60° F.

Inlet Pressure		Orifice Size								
		PSIG	BAR	1/8"	1/8 x 3/16"	3/16"	1/4"	5/16"	3/8"	1/2"
Typical Capacity Info. Manufacturer Itron Type and model B42R Inlet size 3/4" NPT Outlet size 3/4" NPT Spring color Yellow/black Position 5	3	0.21	100 (2.8)	125 (3.5)	240 (6.8)	320 (9.1)	440 (12.5)	490 (13.9)	560 (15.9)	645 (18.3)
	5	0.34	175 (5.0)	255 (7.2)	340 (9.6)	460 (13.0)	650 (18.4)	730 (20.7)	925 (26.2)	1085 (30.7)
	10	0.69	320 (9.1)	410 (11.6)	600 (17.0)	850 (24.1)	1085 (30.7)	1280 (36.3)	1485 (42.1)	1600 (45.3)
	15	1.03	440 (12.5)	500 (14.2)	840 (23.8)	1150 (32.6)	1410 (39.9)	1600 (45.3)		
	20	1.38	530 (15.0)	580 (16.4)	1040 (29.5)	1420 (40.2)	1580 (44.7)	1870 (53.0)		
	30	2.07	710 (20.1)	750 (21.8)	1375 (38.9)	1810 (51.3)	2050 (58.0)			
	40	2.76	875 (24.8)	930 (26.3)	1690 (47.9)	2180 (61.7)				
	50	3.45	1050 (29.7)	1100 (31.1)	2020 (57.2)	2500 (70.8)				
	60	4.14	1200 (34.0)	1260 (35.7)	2200 (62.3)	2750 (77.9)				
	80	5.52	1500 (42.5)	1595 (45.2)	2540 (71.9)					
	100	6.89	1850 (52.4)	1905 (53.9)	2720 (77.0)					
	125	8.62	2100 (59.5)	2250 (63.7)	2720 (77.0)					

Inlet Effect A (PSIG)	0.01	0.02	0.03	0.03	0.04	0.04	0.06	0.06
Lock Up B (PSIG)	0.06	0.06	0.08	0.09	0.10	0.12	0.14	0.14

Notes:

- A. Change in outlet pressure for 10 PSIG inlet pressure change.
- B. Outlet pressure increase required for lock up.

*Individual regulator performance may vary from data shown.

Do not operate orifice in shaded inlet pressure area.

B42 SERIES RESIDENTIAL REGULATOR, MODELS N AND R

2 PSIG (0.14 mbar) Capacity Table (1% Absolute Droop*), 1" Outlet Valve Bodies

Capacities in SCFH (m3/hr) of 0.6 S.G. gas; base conditions of 14.7 PSIA and 60° F.

Typical Capacity Info.		Inlet Pressure		Orifice Size							
		PSIG	BAR	1/8"	1/8 x 3/16"	3/16"	1/4"	5/16"	3/8"	1/2"	1/2 x 9/16"
Manufacturer	Itron										
Type and model	B42 R	3	0.21	100 (2.8)	120 (3.4)	160 (4.5)	200 (5.7)	230 (6.5)	280 (7.9)	320 (9.1)	340 (9.6)
Inlet size	3/4" NPT	5	0.34	135 (3.8)	170 (4.8)	230 (6.5)	290 (8.2)	400 (11.3)	420 (11.9)	480 (13.6)	575 (16.3)
Outlet size	1" NPT	10	0.69	230 (6.5)	295 (8.4)	370 (10.5)	490 (13.9)	730 (20.7)	750 (21.2)	840 (23.8)	1075 (30.4)
Spring color	Yellow/black	15	1.03	300 (8.5)	415 (11.8)	500 (14.2)	650 (18.4)	1000 (28.3)	1000 (28.3)		
Position	5	20	1.38	370 (10.5)	550 (15.6)	600 (17.0)	840 (23.8)	1200 (34.0)	1200 (34.0)		
		30	2.07	500 (14.2)	700 (19.8)	900 (25.5)	1230 (34.8)	1600 (45.3)			
		40	2.76	600 (17.0)	880 (25.0)	1100 (31.2)	1600 (45.3)				
		50	3.45	800 (22.7)	1090 (30.9)	1400 (39.6)	1940 (54.9)				
		60	4.14	950 (27.0)	1250 (35.4)	1600 (45.3)	2240 (63.4)				
		80	5.52	1200 (34.0)	1730 (49.0)	2000 (56.6)					
		100	6.89	1600 (45.3)	1900 (53.8)	2400 (68.0)					
		125	8.62	2100 (59.5)	2500 (70.8)	3300 (93.5)					

Inlet Effect A (PSIG)	0.01	0.01	0.02	0.03	0.03	0.04	0.06	0.06
Lock Up B (PSIG)	0.06	0.06	0.08	0.09	0.10	0.12	0.14	0.14

Notes:

A. Change in outlet pressure for 10 PSIG inlet pressure change.

B. Outlet pressure increase required for lock up.

*Individual regulator performance may vary from data shown.

Do not operate orifice in shaded inlet pressure area.

B42 SERIES RESIDENTIAL REGULATOR, MODELS N AND R

2 PSIG (0.14 mbar) Capacity Table (2% Absolute Droop*), 1" Outlet Valve Bodies

Capacities in SCFH (m3/hr) of 0.6 S.G. gas; base conditions of 14.7 PSIA and 60° F.

Typical Capacity Info.		Inlet Pressure		Orifice Size							
		PSIG	BAR	1/8"	1/8 x 3/16"	3/16"	1/4"	5/16"	3/8"	1/2"	1/2 x 9/16"
Manufacturer	Itron	3	0.21	130 (3.7)	150 (4.3)	240 (6.8)	320 (9.1)	450 (12.7)	490 (13.9)	560 (15.9)	645 (18.3)
Type and model	B42R	5	0.34	180 (5.1)	255 (7.2)	340 (9.6)	460 (13.0)	680 (19.3)	730 (20.7)	925 (26.2)	1085 (30.7)
Inlet size	3/4" NPT	10	0.69	320 (9.1)	420 (11.9)	600 (17.0)	850 (24.1)	1240 (35.1)	1280 (36.3)	1540 (43.6)	1710 (48.4)
Outlet size	1" NPT	15	1.03	440 (12.5)	530 (15.0)	850 (24.1)	1150 (32.6)	1600 (45.3)	1600 (45.3)		
Spring color	Yellow/black	20	1.38	530 (15.0)	590 (16.7)	1040 (29.5)	1420 (40.2)	2000 (56.6)	2000 (56.6)		
Position	5	30	2.07	710 (20.1)	770 (21.8)	1430 (40.5)	1920 (54.4)	2400 (68.0)			
		40	2.76	875 (24.8)	930 (26.3)	1700 (48.1)	2390 (67.7)				
		50	3.45	1050 (29.7)	1140 (32.3)	2100 (59.5)	2800 (70.8)				
		60	4.14	1200 (34.0)	1300 (36.8)	2400 (68.0)	3130 (88.6)				
		80	5.52	1500 (42.5)	1825 (51.7)	2700 (76.5)					
		100	6.89	1850 (52.4)	1950 (55.2)	3000 (85.0)					
		125	8.62	2100 (59.5)	2600 (73.6)	3500 (99.1)					

Inlet Effect A (PSIG)	0.01	0.02	0.03	0.03	0.04	0.04	0.06	0.06
Lock Up B (PSIG)	0.06	0.06	0.08	0.09	0.10	0.12	0.14	0.14

Notes:

A. Change in outlet pressure for 10 PSIG inlet pressure change.

B. Outlet pressure increase required for lock up.

*Individual regulator performance may vary from data shown.

Do not operate orifice in shaded inlet pressure area.

B42 SERIES RESIDENTIAL REGULATOR, MODELS N AND R

2 PSIG (0.14 mbar) Capacity Table (1% Absolute Droop*), 1-1/4" Outlet Valve Bodies

Capacities in SCFH (m3/hr) of 0.6 S.G. gas; base conditions of 14.7 PSIA and 60° F.

Typical Capacity Info.		Inlet Pressure		Orifice Size							
		PSIG	BAR	1/8"	1/8 x 3/16"	3/16"	1/4"	5/16"	3/8"	1/2"	1/2 x 9/16"
Manufacturer	Itron	3	0.21	100 (2.8)	125 (3.5)	165 (4.6)	220 (6.2)	260 (7.3)	280 (7.9)	370 (10.4)	400 (11.3)
Type and model	B42 R	5	0.34	135 (3.8)	230 (6.5)	260 (7.3)	350 (9.9)	410 (11.6)	430 (12.1)	510 (14.4)	580 (16.4)
Inlet size	3/4" NPT	10	0.69	250 (7)	390 (11)	400 (11.3)	570 (16.1)	740 (20.9)	760 (21.5)	860 (24.3)	1100 (31.1)
Outlet size	1-1/4" NPT	15	1.03	370 (10.4)	510 (14.4)	525 (14.8)	670 (18.9)	1050 (29.7)	1100 (31.1)		
Spring color	Yellow/black	20	1.38	430 (12.1)	580 (16.4)	620 (17.5)	850 (24)	1275 (36.1)	1300 (36.8)		
Position	5	30	2.07	530 (15)	720 (20.3)	920 (26)	1250 (35.3)	1700 (48.1)			
		40	2.76	660 (18.6)	900 (25.4)	1150 (32.5)	1650 (46.7)				
		50	3.45	810 (22.9)	1100 (31.1)	1425 (40.3)	2000 (56.6)				
		60	4.14	950 (27.0)	1320 (37.3)	1650 (46.7)	2290 (64.8)				
		80	5.52	1290 (36.5)	1750 (49.5)	2100 (59.5)					
		100	6.89	1700 (48.1)	1950 (55.2)	2475 (70)					
		125	8.62	2150 (60.8)	2600 (73.6)	3400 (96.2)					

Inlet Effect A (PSIG)	0.01	0.02	0.03	0.03	0.04	0.04	0.06	0.06
Lock Up B (PSIG)	0.06	0.06	0.08	0.09	0.10	0.12	0.14	0.14

Notes:

A. Change in outlet pressure for 10 PSIG inlet pressure change.

B. Outlet pressure increase required for lock up.

*Individual regulator performance may vary from data shown.

Do not operate orifice in shaded inlet pressure area.

B42 SERIES RESIDENTIAL REGULATOR, MODELS N AND R

2 PSIG (0.14 mbar) Capacity Table (2% Absolute Droop*), 1-1/4" Outlet Valve Bodies

Capacities in SCFH (m3/hr) of 0.6 S.G. gas; base conditions of 14.7 PSIA and 60° F.

Typical Capacity Info.		Inlet Pressure		Orifice Size							
		PSIG	BAR	1/8"	1/8 x 3/16"	3/16"	1/4"	5/16"	3/8"	1/2"	1/2 x 9/16"
Manufacturer	Itron	3	0.21	130 (3.7)	200 (5.6)	320 (9)	380 (10.7)	470 (13.3)	570 (16.1)	700 (19.8)	720 (20.3)
Type and model	B42R	5	0.34	180 (5.1)	280 (7.9)	420 (11.9)	580 (16.4)	700 (19.8)	770 (21.8)	1020 (28.8)	1100 (31.1)
Inlet size	3/4" NPT	10	0.69	350 (9.9)	420 (11.9)	630 (17.8)	930 (26.3)	1260 (35.6)	1300 (36.8)	1590 (45)	1750 (49.5)
Outlet size	1-1/4" NPT	15	1.03	480 (13.6)	535 (15.1)	875 (24.7)	1200 (33.9)	1675 (47.4)	1700 (48.1)		
Spring color	Yellow/black	20	1.38	570 (16.1)	610 (17.2)	1070 (30.3)	1470 (41.6)	2100 (59.4)	2200 (62.3)		
Position	5	30	2.07	730 (20.6)	800 (22.6)	1460 (41.3)	1980 (56.1)	2500 (70.8)			
		40	2.76	910 (25.8)	960 (27.2)	1850 (52.4)	2525 (71.5)				
		50	3.45	1060 (30)	1150 (32.6)	2200 (62.3)	2900 (82.1)				
		60	4.14	1240 (35.1)	1320 (37.4)	2600 (73.6)	3200 (90.6)				
		80	5.52	1580 (44.7)	1875 (53.1)	3350 (94.9)					
		100	6.89	1890 (53.5)	2000 (56.6)	3500 (99.1)					
		125	8.62	2230 (63.1)	2675 (75.7)	3650 (103.4)					

Inlet Effect A (PSIG)	0.01	0.02	0.03	0.03	0.04	0.04	0.06	0.06
Lock Up B (PSIG)	0.06	0.06	0.08	0.09	0.10	0.12	0.14	0.14

Notes:

A. Change in outlet pressure for 10 PSIG inlet pressure change.

B. Outlet pressure increase required for lock up.

*Individual regulator performance may vary from data shown.

Do not operate orifice in shaded inlet pressure area.

B42 PERFORMANCE CURVES

2 PSIG Set Point

Type and model B42 N, R

Inlet size 3/4" NPT

Outlet size 1" NPT

Spring Yellow/black

All test results are reported at a base of 14.7 PSIA at 60° F and with 0.6 S.G. gas.

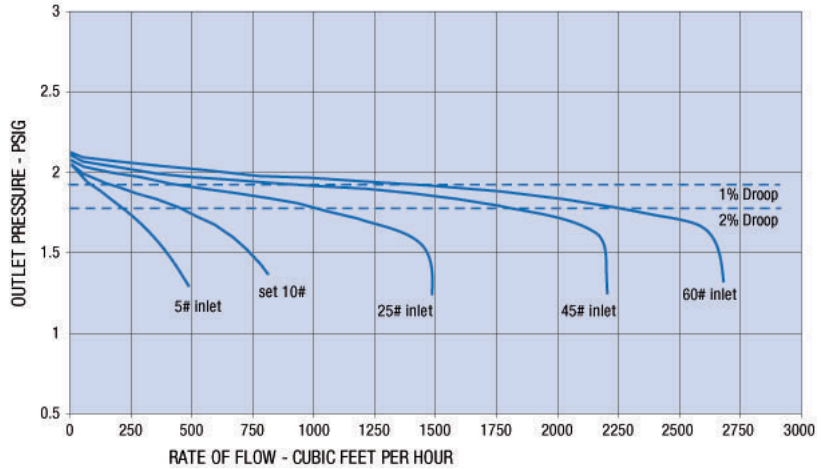

RELIEF CURVES

2 PSIG Set Point

Inlet size 3/4"

Outlet size 1" NPT

Vent size 3/4"

All test results are reported at a base of 14.7 PSIA at 60° F and with 0.6 S.G. gas.

Regulator set at 2 PSIG for relief testing with 10 PSIG @ 50 SCFH inlet pressure.

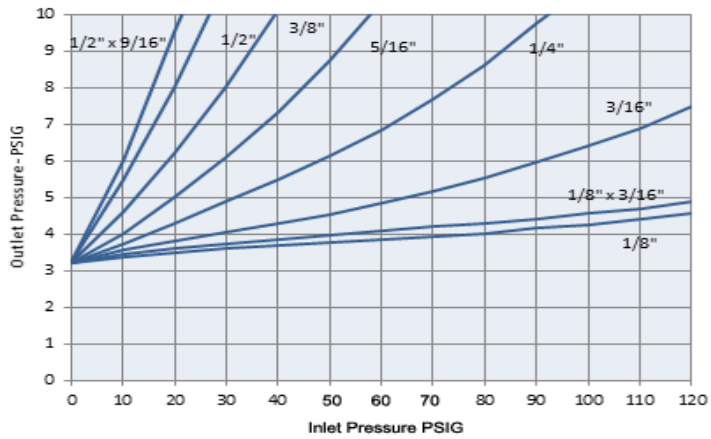

2 PSIG Set Point

Inlet size 3/4" NPT

Outlet size 1" NPT

Vent size 1" NPT

All test results are reported at a base of 14.7 PSIA at 60° F and with 0.6 S.G. gas.

Regulator set at 2 PSIG for relief testing with 10 PSIG @ 50 SCFH inlet pressure.

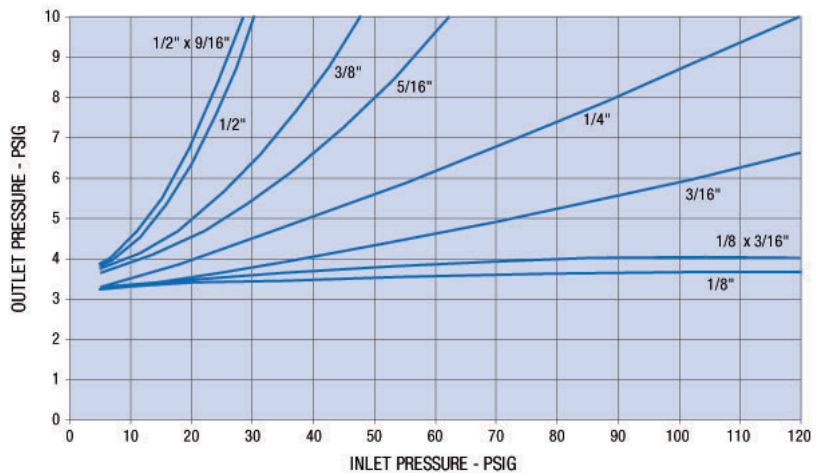

B42 SERIES RESIDENTIAL REGULATOR, MODELS N AND R

5 PSIG (0.34 mbar) Capacity Table (1% Absolute Droop*), 3/4" Outlet Valve Bodies

Capacities in SCFH (m3/hr) of 0.6 S.G. gas; base conditions of 14.7 PSIA and 60° F.

Typical Capacity Info.		Inlet Pressure		Orifice Size					
		PSIG	BAR	1/8"	3/16"	1/4"	5/16"	3/8"	1/2"
Manufacturer	Itron	10	0.69	125 (6.8)	145 (4.1)	220 (6.2)	235 (6.7)	285 (8.1)	315 (8.9)
Type and model	B42	15	1.03	155 (4.4)	160 (4.5)	250 (7.1)	275 (7.8)	320 (9.1)	
Inlet size	3/4" NPT	20	1.38	160 (4.5)	195 (5.5)	260 (7.4)	305 (8.6)	380 (10.1)	
Outlet size	3/4" NPT	30	2.07	190 (5.4)	255 (7.2)	315 (8.9)	400 (11.3)		
Spring color	White	40	2.76	220 (6.2)	270 (7.7)	390 (11.0)			
Position	5	50	3.45	255 (7.2)	300 (8.5)	450 (12.7)			
		60	4.14	275 (7.8)	390 (11.0)	550 (15.6)			
		80	5.52	345 (9.8)	480 (13.6)				
		100	6.89	420 (11.9)	580 (16.4)				
		125	8.62	510 (14.5)	700 (19.8)				

Inlet Effect A (PSIG)	0.05	0.08	0.10	0.12	0.14	0.20
Lock Up B (PSIG)	0.08	0.10	0.11	0.12	0.14	0.16

Notes:

A. Change in outlet pressure for 10 PSIG inlet pressure change.

B. Outlet pressure increase required for lock up.

*Individual regulator performance may vary from data shown.

Do not operate orifice in shaded inlet pressure area.

B42 SERIES RESIDENTIAL REGULATOR, MODELS NHP AND RHP

5 PSIG (0.34 mbar) Capacity Table (2% Absolute Droop*), 3/4 Outlet Valve Bodies

Capacities in SCFH (m3/hr) of 0.6 S.G. gas; base conditions of 14.7 PSIA and 60° F.

Typical Capacity Info.	
Manufacturer	Itron
Type and model	B42 R
Inlet size	3/4"
Outlet size	3/4" NPT
Spring color	White
Position	5

Inlet Pressure		Orifice Size					
PSIG	BAR	1/8"	3/16"	1/4"	5/16"	3/8"	1/2"
10	0.69	175 (5.0)	230 (6.5)	300 (8.5)	355 (10.1)	420 (11.9)	565 (16.0)
15	1.03	230 (6.5)	330 (10.3)	430 (12.2)	490 (13.9)	650 (18.4)	
20	1.38	255 (7.2)	385 (10.9)	525 (14.9)	615 (17.4)	770 (21.8)	
30	2.07	370 (10.5)	570 (16.1)	710 (20.1)	855 (218)		
40	2.76	405 (11.5)	700 (19.8)	940 (26.6)			
50	3.45	445 (12.6)	845 (23.9)	1160 (32.8)			
60	4.14	535 (15.1)	925 (26.2)	1355 (38.4)			
80	5.52	710 (20.1)	1000 (28.3)				
100	6.89	865 (24.5)	1215 (34.4)				
125	8.62	1050 (29.7)	1480 (41.9)				

Inlet Effect A (PSIG)	0.05	0.08	0.10	0.12	0.14	0.20
Lock Up B (PSIG)	0.08	0.10	0.11	0.02	0.14	0.16

Notes:

A. Change in outlet pressure for 10 PSIG inlet pressure change.

B. Outlet pressure increase required for lock up.

*Individual regulator performance may vary from data shown.

Do not operate orifice in shaded inlet pressure area.

B42 SERIES RESIDENTIAL REGULATOR, MODELS NHP AND RHP

5 PSIG (0.34 mbar) Capacity Table (1% Absolute Droop*), 1" Outlet Valve Bodies

Capacities in SCFH (m3/hr) of 0.6 S.G. gas; base conditions of 14.7 PSIA and 60° F.

Typical Capacity Info.	
Manufacturer	Itron
Type and model	B42
Inlet size	3/4" NPT
Outlet size	1" NPT
Spring color	White
Position	5

Inlet Pressure		Orifice Size					
PSIG	BAR	1/8"	3/16"	1/4"	5/16"	3/8"	1/2"
10	0.69	175 (5.0)	240 (6.8)	300 (8.5)	355 (10.1)	420 (11.9)	610 (17.3)
15	1.03	130 (3.7)	160 (4.5)	225 (6.4)	275 (7.8)	320 (9.1)	
20	1.38	160 (4.5)	195 (5.5)	260 (7.4)	305 (8.6)	380 (10.1)	
30	2.07	190 (5.4)	255 (7.2)	315 (8.9)	400 (11.3)		
40	2.76	220 (6.2)	270 (7.7)	390 (11.0)			
50	3.45	255 (7.2)	300 (8.5)	450 (12.7)			
60	4.14	175 (7.8)	390 (11.0)	550 (15.6)			
80	5.52	349 (9.9)	478 (13.5)				
100	6.89	422 (11.9)	579 (16.4)				
125	8.62	514 (14.5)	705 (19.9)				

Inlet Effect A (PSIG)	0.05	0.08	0.10	0.12	0.14	0.20
Lock Up B (PSIG)	0.08	0.10	0.11	0.12	0.14	0.16

Notes:

A. Change in outlet pressure for 10 PSIG inlet pressure change.

B. Outlet pressure increase required for lock up.

*Individual regulator performance may vary from data shown.

Do not operate orifice in shaded inlet pressure area.

B42 SERIES RESIDENTIAL REGULATOR, MODELS NHP AND RHP

5 PSIG (0.34 mbar) Capacity Table (2% Absolute Droop*), 1" Outlet Valve Bodies

Capacities in SCFH (m3/hr) of 0.6 S.G. gas; base conditions of 14.7 PSIA and 60° F.

Typical Capacity Info.	
Manufacturer	Itron
Type and model	B42 R
Inlet size	3/4"
Outlet size	1" NPT
Spring color	White
Position	5

Inlet Pressure		Orifice Size					
PSIG	BAR	1/8"	3/16"	1/4"	5/16"	3/8"	1/2"
10	0.69	175 (5.0)	240 (6.8)	300 (8.5)	355 (10.1)	420 (11.9)	610 (17.3)
15	1.03	230 (3.7)	365 (10.3)	430 (12.2)	555 (7.8)	650 (9.1)	
20	1.38	255 (4.5)	445 (12.6)	525 (14.9)	650 (8.6)	770 (10.8)	
30	2.07	370 (5.4)	570 (16.1)	710 (20.1)	950 (11.3)		
40	2.76	405 (6.2)	754 (21.1)	940 (26.6)			
50	3.45	445 (7.2)	855 (24.2)	1160 (32.9)			
60	4.14	535 (7.8)	925 (26.1)	1450 (41.1)			
80	5.52	714 (9.9)	1003 (28.3)				
100	6.89	865 (12.0)	1215 (34.3)				
125	8.62	1054 (29.8)	1480 (41.8)				

Inlet Effect A (PSIG)	0.05	0.08	0.10	0.12	0.14	0.20
Lock Up B (PSIG)	0.08	0.10	0.11	0.02	0.14	0.16

Notes:

A. Change in outlet pressure for 10 PSIG inlet pressure change.

B. Outlet pressure increase required for lock up.

*Individual regulator performance may vary from data shown.

Do not operate orifice in shaded inlet pressure area.

B42 SERIES RESIDENTIAL REGULATOR, MODELS NHP AND RHP

5 PSIG (0.34 mbar) Capacity Table (1% Absolute Droop*), 1-1/4" Outlet Valve Bodies

Capacities in SCFH (m3/hr) of 0.6 S.G. gas; base conditions of 14.7 PSIA and 60° F.

Typical Capacity Info.		Inlet Pressure		Orifice Size					
		PSIG	BAR	1/8"	3/16"	1/4"	5/16"	3/8"	1/2"
Manufacturer	Itron	10	0.69	175 (5.0)	245 (6.9)	310 (8.8)	370 (10.5)	450 (12.7)	650 (18.4)
Type and model	B42	15	1.03	155 (3.8)	200 (5.7)	270 (7.6)	300 (8.5)	360 (10.2)	
Inlet size	3/4" NPT	20	1.38	165 (4.7)	230 (6.5)	320 (9.1)	360 (10.2)	430 (12.2)	
Outlet size	1"-1/4 NPT	30	2.07	220 (6.2)	320 (9.1)	410 (11.6)	420 (11.9)		
Spring color	White	40	2.76	280 (7.9)	370 (10.5)	450 (12.7)			
Position	5	50	3.45	340 (9.6)	400 (11.3)	520 (14.7)			
		60	4.14	350 (9.9)	450 (12.7)	580 (16.4)			
		80	5.52	485 (13.7)	630 (17.8)				
		100	6.89	500 (14.2)	680 (19.3)				
		125	8.62	630 (17.8)	850 (24.1)				

Inlet Effect A (PSIG)	0.05	0.08	0.10	0.12	0.14	0.20
Lock Up B (PSIG)	0.08	0.10	0.11	0.12	0.14	0.16

Notes:

A. Change in outlet pressure for 10 PSIG inlet pressure change.

B. Outlet pressure increase required for lock up.

*Individual regulator performance may vary from data shown.

 Do not operate orifice in shaded inlet pressure area.

B42 SERIES RESIDENTIAL REGULATOR, MODELS N AND R

5 PSIG (0.34 mbar) Capacity Table (2% Absolute Droop*), 1-1/4" Outlet Valve Bodies

Capacities in SCFH (m3/hr) of 0.6 S.G. gas; base conditions of 14.7 PSIA and 60° F.

Typical Capacity Info.

Manufacturer	Itron
Type and model	B42 R
Inlet size	3/4"
Outlet size	1-1/4" NPT
Spring color	White
Position	5

Inlet Pressure		Orifice Size					
PSIG	BAR	1/8"	3/16"	1/4"	5/16"	3/8"	1/2"
10	0.69	175 (5.0)	250 (7.1)	350 (9.9)	370 (10.5)	430 (12.2)	580 (16.4)
15	1.03	230 (3.7)	375 (10.6)	500 (14.2)	575 (16.3)	680 (9.3)	
20	1.38	280 (7.9)	450 (12.7)	580 (16.4)	680 (19.3)	800 (22.7)	
30	2.07	370 (5.4)	580 (16.4)	770 (21.8)	975 (27.6)		
40	2.76	480 (13.6)	755 (21.9)	1000 (28.3)			
50	3.45	600 (17)	875 (24.8)	1180 (33.4)			
60	4.14	630 (17.8)	1000 (28.3)	1475 (41.8)			
80	5.52	900 (25.5)	1200 (34)				
100	6.89	1000 (28.3)	1400 (39.6)				
125	8.62	1200 (34)	1750 (49.6)				

Inlet Effect A (PSIG)	0.05	0.08	0.10	0.12	0.14	0.20
Lock Up B (PSIG)	0.08	0.10	0.11	0.12	0.14	0.16

Notes:

A. Change in outlet pressure for 10 PSIG inlet pressure change.

B. Outlet pressure increase required for lock up.

*Individual regulator performance may vary from data shown.

Do not operate orifice in shaded inlet pressure area.

B42 PERFORMANCE CURVES

5 PSIG Set Point

Type and model B42 NHP, RHP

Inlet size 3/4" NPT

Outlet size 1" NPT

Spring White

All test results are reported at a base of 14.7 PSIA at 60° F and with 0.6 S.G. gas.

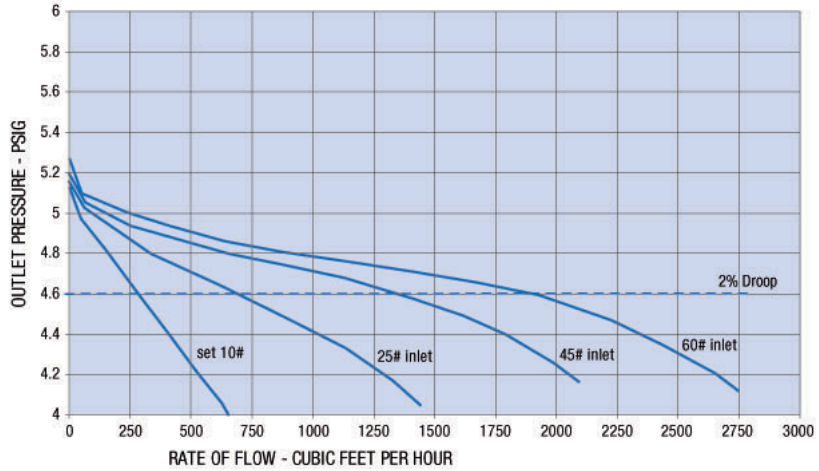

RELIEF CURVES

5 PSIG Set Point

Inlet size 3/4" NPT

Outlet size 1" NPT

Vent size 3/4"

All test results are reported at a base of 14.7 PSIA at 60° F and with 0.6 S.G. gas.

Regulator set at 5 PSIG for relief testing with 10 PSIG @ 50 SCFH inlet pressure.

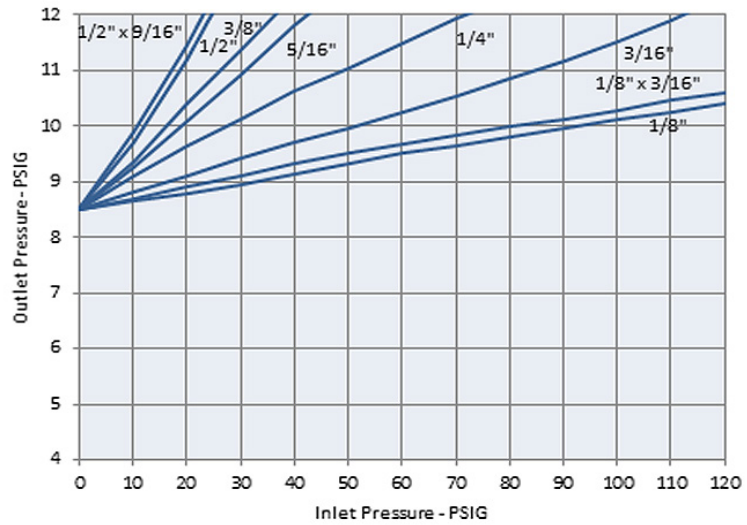

5 PSIG Set Point

Inlet size 3/4" NPT

Outlet size 1" NPT

Vent size 1" NPT

All test results are reported at a base of 14.7 PSIA at 60° F and with 0.6 S.G. gas.

Regulator set at 5 PSIG for relief testing with 10 PSIG @ 50 SCFH inlet pressure.

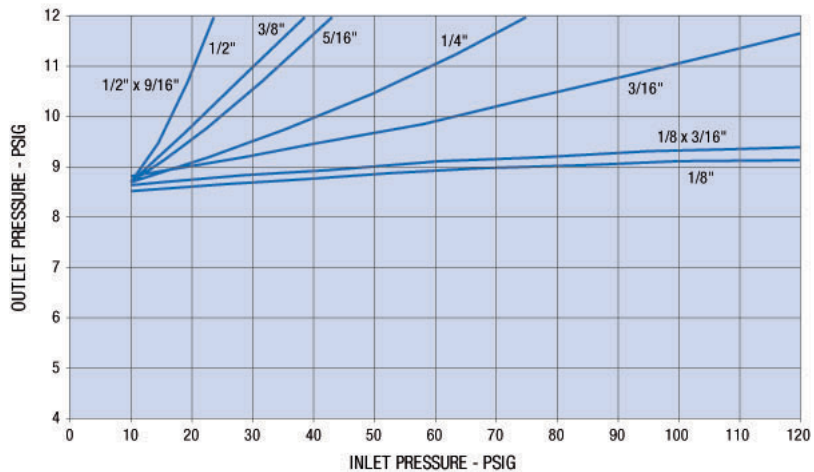

ASSEMBLY POSITIONS

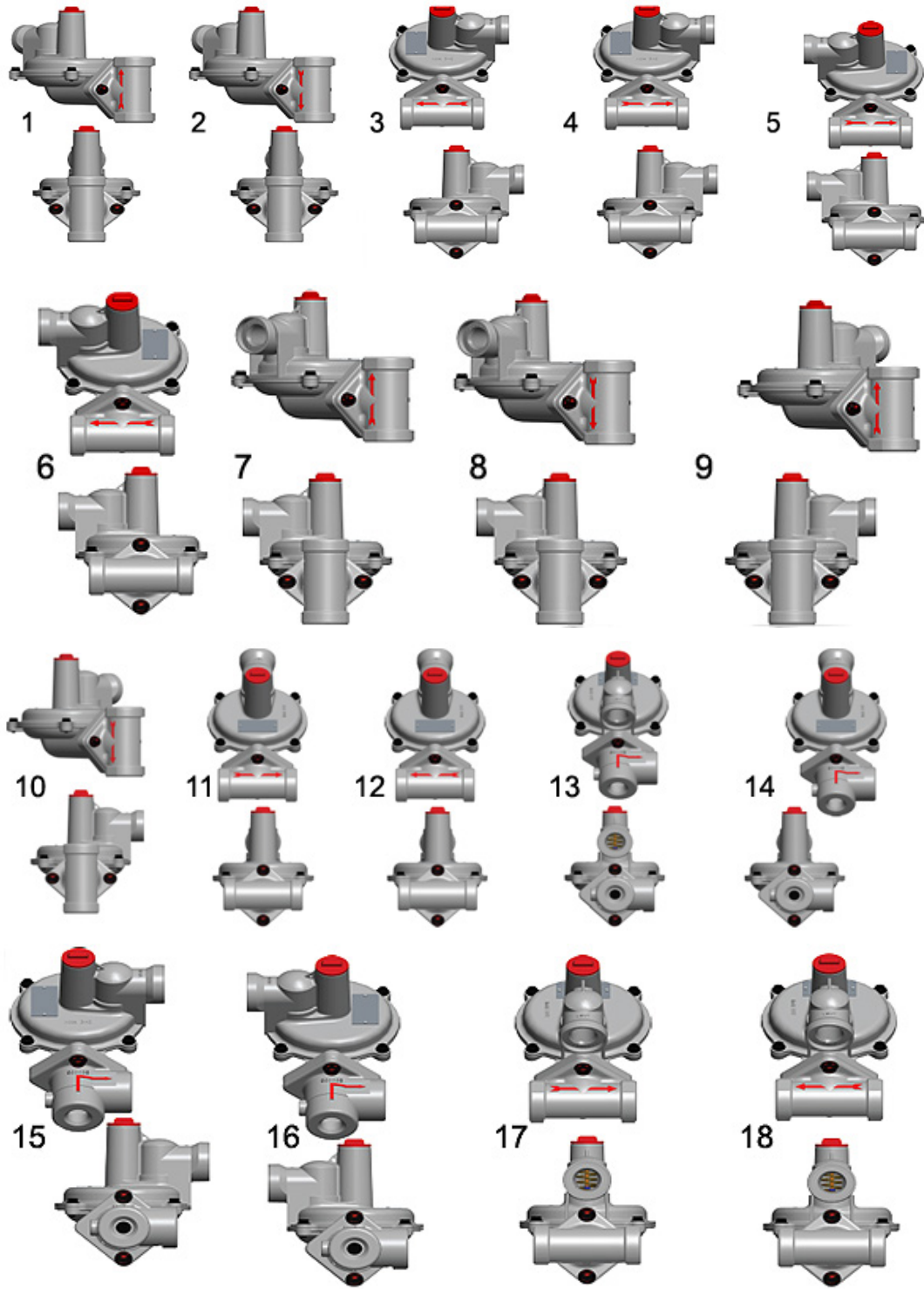

PARTS LIST

B42 Parts Diagram

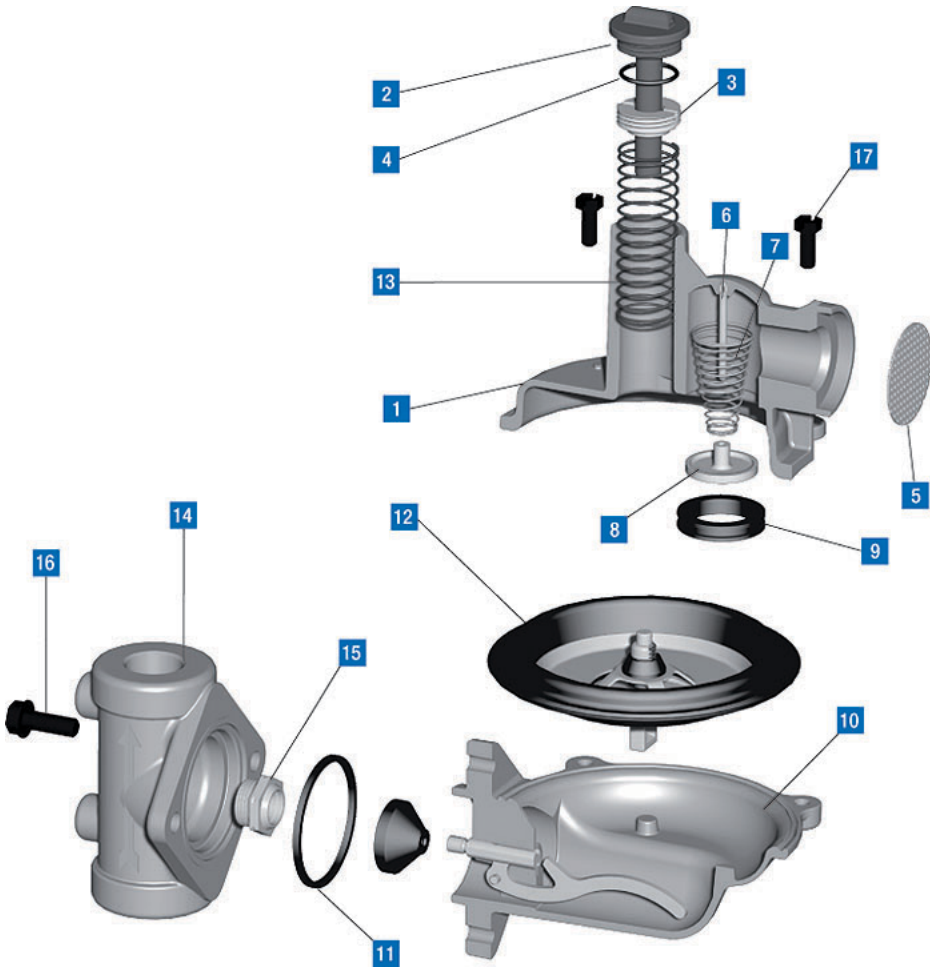

Parts List

Item Number	Part Number	Qty		Description
		N	R	
1		1	1	Upper diaphragm case
	753443SU			Standard, 1" vent
	710106	1,6,7,8,&9		Upper diaphragm case assembly, 1"
	753442SU			Standard, 3/4" vent
	710105	1,6,7,8,&9		Upper diaphragm case assembly, 3/4"
	753445SU			High pressure, 1" vent
	710108	1,6,7,8,&9		Upper diaphragm case assembly, 1" HP
	753444SU			High pressure, 3/4" vent
	710107	1,6,7,8,&9		Upper diaphragm case assembly, 3/4" HP
	753500-002SU			Cast iron standard, 3/4" vent
	710120	1,6,7,8,&9		Cast iron upper diaphragm case assembly, 3/4"
	753500-003SU			Cast iron standard, 1" vent
	710121	1,6,7,8,&9		Cast iron upper diaphragm case assembly, 3/4"
2		1	1	Seal cap
	76026001			Seal cap with gasket, gray

Item Number	Part Number	Qty		Description
		N	R	
2		1	1	Seal cap
	76026101			Seal cap with gasket, red
	76026201			Seal cap with gasket, green
	76026301			Seal cap with gasket, white
3	760215	1	1	Adjustment screw, standard
	760217	1	1	Adjustment screw, high pressure
4	765501	1	1	Seal cap gasket
5	762933	1	1	Vent screen
6	75483401	1	1	Vent valve disc pin
7	762651	1	1	Vent valve spring
8	765181	1	1	Vent valve disc
9	765685	1	1	Vent valve seat
10	715075	1	1	Lower diaphragm case assembly
	715077	1	1	Cast iron, lower diaphragm case assembly
11		1	1	Valve seat
	765051			Valve seat, standard
	765053			Valve seat, silicone
				Diaphragm assembly complete
12	720085		1	Diaphragm assembly, standard relief (R)
	720091	1		Diaphragm assembly, non-relief (N)
	761005	1	1	Upper diaphragm plate
	75606102		1	Lower diaphragm plate (R)
	75606103	1		Lower diaphragm plate (N)
	761401		1	Relief spring retaining clip
	755513-001	1		Nut (N)
	755801	1		Washer (N)
	762653		1	Relief spring, 7" w.c., standard
	762655			Relief spring, 5" w.c.
	754911	1	1	Stop stem guide bushing
13		1	1	Adjustment springs, please specify color
	762649			5-7" w.c. green
	762645			6-8" w.c. brown
	762646			8-14" w.c. blue
	762647			12-28 w.c. silver
	762003			4-9" w.c. dark green
	762002			5.5-9" w.c. orange
13		1	1	Adjustment springs, please specify color
	762650			1-2 PSIG yellow/black
	76213101			2-4 PSIG yellow* (high pressure)
	76213701			4-5 PSIG white* (high pressure)

Item Number	Part Number	Qty		Description
		N	R	
14		1	1	Valve body, specify type and size <i>straight</i>
	750586SU			1/2" x 1/2" NPT
	750587SU			1/2" x 1/2" NPT w/ 1/8" in. PP
	750588SU			1/2" x 1/2" NPT w/ 1/8" out. PP
	750527SU			3/4" x 3/4" NPT
	750528SU			3/4" x 3/4" NPT w/ 1/8" in. PP
	750529SU			3/4" x 3/4" NPT w/ 1/8" out. PP
	750530SU			3/4" x 3/4" NPT with in/out PP
	750531SU			3/4" x 1" NPT
	750532SU			3/4" x 1" NPT with 1/8" in. PP
	750533SU			3/4" x 1" NPT with 1/8" out. PP
	750534SU			3/4" x 1" NPT with in/out PP
	750567SU			3/4" x 1-1/4" NPT
	750568SU			3/4" x 1-1/4" NPT with 1/8" in. PP
	750569SU			3/4" x 1-1/4" NPT with 1/8" out. PP
	750535SU			1" x 1" NPT
	750536SU			1" x 1" NPT with 1/8" in. PP
	750537SU			1" x 1" NPT with 1/8" out. PP
	750538SU			1" x 1" NPT with in./out. PP
	750570SU			1" x 1-1/4" NPT
	750571SU			1" x 1-1/4" NPT with 1/8" in. PP
	750572SU			1" x 1-1/4" NPT with 1/8" out. PP
	750573SU			1-1/4" x 1-1/4" NPT
	750574SU			1-1/4" x 1-1/4" NPT with 1/8" in. PP
	750575SU			1-1/4" x 1-1/4" NPT with 1/8" out. PP
				90° Angle body
	750541SU			3/4" x 3/4" NPT
	750542SU			3/4" x 3/4" NPT with 1/8" in. PP
	750543SU			3/4" x 1" NPT
	750544SU			3/4" x 1" NPT with 1/8" in. PP
	750545SU			1" x 1" NPT
	750546SU			1" x 1" NPT with 1/8" in PP
15		1	1	Orifice, please specify size
	757611			1/8" aluminum
	757641			1/8" brass
	757651			1/8" x 3/16" aluminum
	757619			3/16" aluminum
	757643			3/16" brass
	757623			1/4" aluminum
	757645			1/4" brass
	757627			5/16" aluminum

Item Number	Part Number	Qty		Description
		N	R	
15		1	1	Orifice, please specify size
	757631			3/8" aluminum
	757453			1/2" aluminum
	75767101			1/2" x 9/16" aluminum
	769417	1	1	Legal warning label
16	80006703	2	2	Valve body screw 5/16 - 18 x 7/8 lg.
	80006702	2	2	SS cast iron valve body screw 5/16 - 18 x 7/8 lg.
17	010323-002	4	4	Case screw 1/4 - 20 x 3/4 lg.
	010323-001	4	4	SS cast iron case screw 1/4 - 20 x 3/4 lg.
	765605	1	1	Valve body gasket

Part Number	Description
799051	Adjustment tool
799017	Orifice wrench

Part Number	Torque Specifications
010323-002	Case screws: 35 - 45 in. lb.
010323-001	Case screws: 35-45 in.
80006703	Valve body screws: 85 - 115 in. lb
	See above orifice: 450 - 600 in. lb.

VENT LINES FOR REGULATORS

When constructing vent lines to be attached to regulators installed indoors, follow a few basic rules:

- a. Never use pipe sizes smaller than the vent size; smaller pipe sizes restrict the gas flow. If a long gas run must be used, Itron advises increasing the pipe one nominal size every ten feet to keep the flow restriction as low as possible.
- b. Keep the vent line length as short as possible to minimize the restriction and reduce the vent's tendency to cause regulator pulsation.
- c. Support the vent pipe to eliminate strain on the regulator diaphragm case.
- d. Always point outdoor vent pipes in the downward position to reduce the possibility of rain, snow, sleet, and other moisture entering the pipe. Install a bug screen in the end of the pipe.
- e. Do not locate the vent line terminus near windows, fans, or other ventilation equipment. See the installation instructions furnished with the regulator.
- f. Adhere to all applicable codes and regulations.
- g. If your vent pipe causes regulator pulsation, consult your sales representative or manufacturer.
- h. Itron strongly recommends running a separate vent line for each regulator. Headers with various installed devices can cause regulator malfunction.

Caution Ensure the end of the vent line is away from ANY potential ignition sources. It is the installer's responsibility to ensure the vent line is exhausting to a safe environment.

INSTALLATION

Warning Itron does not endorse or warrant the completeness or accuracy of any third party regulator installation procedures or practices, unless otherwise provided in writing by Itron. Follow your company's standard operating procedures regarding the use of personal protection equipment (PPE). Adhere to guidelines issued by your company in addition to those given in this document when installing regulators.

- a. Remove all shipping plugs from the regulator inlet, outlet, and vent before installation.
- b. Verify the piping interior and regulator inlet and outlet are clean and free of dirt, pipe dope, and other debris. Dirt and other foreign materials entering the regulator can cause a loss of pressure control.
- c. Apply pipe joint sealant to the male pipe threads. Do not use pipe joint material on the regulator's female threads. Joint sealant could become lodged in the regulator and cause a loss of pressure control.
- d. Gas must flow through the regulator's valve body in the direction cast on the regulator body. Gas flowing in the wrong direction can overpressure and cause damage to the regulator.
- e. The diaphragm case can be mounted in any position relative to the body through a full 360° angle at 90° increments.
- f. When the regulator is installed OUTDOORS, the vent must always be positioned so that rain, snow, moisture or foreign particles cannot enter the vent opening. Itron recommends positioning the pilot vent downward to avoid entry of water or other matter which could interfere with the proper operation of the regulator. The vent should be located away from building eaves, window openings, building air intakes and above the expected snow level at the site. The vent opening should be inspected periodically to insure it does not become blocked by foreign material as outlined in DOT PHMSA-RSPA-2004-19856.
- g. When the regulator is installed INDOORS, the vent must be piped to the outside atmosphere using the shortest length of pipe, the fewest possible pipe elbows, and a pipe diameter as large as the vent size or larger. USING VENT PIPE SMALLER THAN THE VENT CONNECTION LIMITS THE REGULATOR'S INTERNAL RELIEF VALVE CAPACITY. The outlet end of the pipe must be protected from moisture and the entrance of foreign particles. The regulator should be specified by the user with the size vent and pipe threads desired to make the vent pipe connection.

STARTUP PROCEDURE

- a. Mount a pressure gauge downstream of the regulator to monitor the downstream pressure.
- b. With the downstream pressure valve closed, slowly open the inlet valve. The outlet pressure should rise to slightly more than the set-point. Verify there are no leaks and all connections are tight.
- c. The regulator was preset at the factory to match order specifications. If necessary, adjust the outlet pressure by removing the seal cap on the top of the spring housing and adjusting the ferrule or screw inside the spring housing using a large flat-head screwdriver. With a small amount of gas flowing through the regulator, rotate the ferrule clockwise to raise the outlet pressure or counterclockwise to lower the outlet pressure.
- d. Replace the seal cap and check for leaks after the desired outlet pressure is achieved.

The regulator is ready for operation.

SAFETY WARNING

This product, as of the date of manufacture, is designed and tested to conform to all governmental and industry safety standards as they may apply to the manufacturer. The purchaser/user of this product must comply with all fire control, building codes, and other safety regulations governing the application, installation, operation, and general use of this regulator to avoid leaking gas hazards resulting from improper installation, startup, or use of this product.

Itron strongly recommends installation by a qualified professional and periodic inspection of pressure regulators (inspections may be required by local applicable codes or regulations).

Inspections should include checking for gas quality, cycle numbers, external environmental changes, and operating conditions that impact wear on the regulator's moving parts. To ensure safe and efficient operation of this product, replace worn or damaged parts found during inspection.

LIMITED WARRANTY

Itron, Inc. 2111 North Molter Road Liberty Lake, WA 99019, warrants this gas product against defects in materials and workmanship for the earlier of one (1) year from the date the product is shipped by Itron or a period of one year from the date the product is installed by Itron at the original purchaser's site. During such one-year period, provided that the original purchaser continues to own the product, Itron will, at its sole option, repair any defects, replace the product or repay the purchase price.

» This warranty will be void if the purchaser fails to observe the procedures for installation, operation or service of the product as set forth in the Operating Manual and Specifications for the product or if the defect is caused by tampering, physical abuse or misuse of the product.

- » ITRON SPECIFICALLY DISCLAIMS ALL IMPLIED WARRANTIES INCLUDING THOSE OF MERCHANTABILITY OR OF FITNESS FOR A PARTICULAR PURPOSE. UNDER NO CIRCUMSTANCES WILL ITRON BE LIABLE FOR INCIDENTAL OR CONSEQUENTIAL DAMAGES OF ANY KIND WHATSOEVER.
- » Itron's liability for any claim of any kind, including negligence and breach of warranty for the sale and use of any product covered by or furnished, shall in no case exceed the price allocable to the product or part thereof which gives rise to the claim.
- » In the event of a malfunction of the product, consult your Itron Service Representative or Itron Inc., 2111 North Molter Road Liberty Lake, WA 99019. See Itron Terms and Conditions of Sale for the full and complete terms of the Limited Warranty.

ORDERING INFORMATION

Specify:

1. Inlet and outlet connection size and type
2. Model number
3. Outlet pressure desired
4. Pilot needed
5. Inlet pressure range
6. Type of gas and maximum capacity required
7. Assembly position number (see chart above)
8. Special requirements such as tagging, 1/8" pipe plug tap, seal wire, etc.



Join us in creating a more **resourceful world**.
To learn more visit **itron.com**

While Itron strives to make the content of its marketing materials as timely and accurate as possible, Itron makes no claims, promises, or guarantees about the accuracy, completeness, or adequacy of, and expressly disclaims liability for errors and omissions in, such materials. No warranty of any kind, implied, expressed, or statutory, including but not limited to the warranties of non-infringement of third party rights, title, merchantability, and fitness for a particular purpose, is given with respect to the content of these marketing materials. © Copyright 2018 Itron. All rights reserved. 101059SP-12 09/18

CORPORATE HQ

2111 North Molter Road
Liberty Lake, WA 99019 USA

Phone: 1.800.635.5461

Fax: 1.509.891.3355