

BALDOR



DC Servo Motors & Drives

for the automation industry

Solutions from Baldor

Quality, service and flexibility... durability and reliability... these have become the keys to application solutions in today's world.

Automation is an Investment Baldor's application experience combined with technical knowledge, experience and product capability will aid you in maximizing the return on your investment.

Baldor's philosophy is to provide the best quality products and solutions. We make constant improvements in the quality of our PMDC servo motors and drives. Today better grease, Exxon PolyrexEM, is used in the bearings - proven to improve product life by four times. Product innovations like this are an example of Baldor's commitment to provide reliable performance, while exceeding customer expectations.

Motors and Drives in Stock Baldor strives to improve the level of service to you, our customer, by making your job easier, and by making product available faster. Baldor has motor and drives in stock for delivery today! In addition Baldor has the industry's shortest lead times on custom motors. Our unique Flex Flow manufacturing process lets us produce any order in any quantity, quickly and efficiently.

Baldor's worldwide offices offer immediate availability of Baldor products.

DC Servo Motors Baldor's motors are designed to meet demanding industrial applications. They operate the world's fastest machines, improving productivity. Making your investment in automation work.

Baldor's servo motors are designed for a high duty rating. They are a quality designed product and provide a proven long life as exhibited by thousands and thousands shipped into world wide applications.

Stock and custom products are available. A wide variety of electrical windings, feedback, terminations, shafts and mounting allow you to customize the product for your application needs.

DC Drives Baldor's DC drives provide the power to move the load for any application. Single and multi-axis drives are available; and the standard industry input and feedback make these DC drives easy to interface to Baldor's motion controllers.

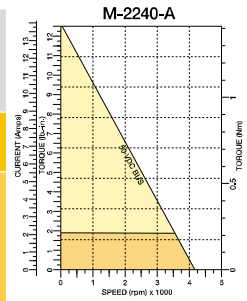

Baldor's DC Servo Motors
Performance Curves
Page 8



Baldor's DC Servo Controls
Technical Specs
Page 34

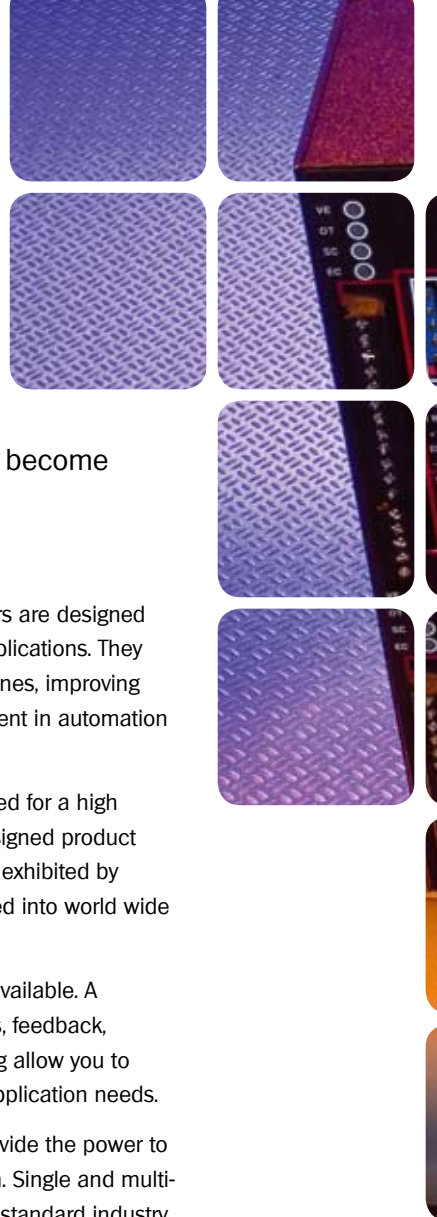



DC Servo Motors

Baldor's DC high performance servo motors were designed rugged to meet demanding requirements of industrial motion control. They can be supplied with many electrical and mechanical options so the design fits your application. Some of the many options available include: tachometer, encoders, brakes, mountings, shafts, windings, speeds and connectors.

The DC servo motors provide continuous stall torques from 1.8 Lb-In (0.2 N-m) to 56 Lb-In (6.3 N-m). They are designed to provide reliability and dependability and long life in today's tough applications.

The DC servo motors are presently used world wide in applications such as X-Y tables, factory automation, coil winders, labeling equipment, machine tool, insertion machines, robotics, pick and place, packaging, converting equipment, assembly equipment and laboratory equipment.

- › High continuous 155°C design for dependability
- › Premium 200°C moisture resistant, multi-coated wire for reliability
- › Non-hygroscopic polyester high temperature class H varnish
- › Quality servo grade bearings with Exxon PolyrexEM® grease for longer life
- › Optimum selected copper-graphite brushes for maximizing life
- › Variety of electrical winding for versatility in your application needs
- › Variety of termination options to suit your requirements
- › Variety of feedback devices
- › Stock and custom design available



M2200 Series

Dimensions, Connections and How to Order
Page 22
Performance Curves
Page 10



M3300 Series

Dimensions, Connections and How to Order
Page 24
Performance Curves
Page 11



M4000 Series

Dimensions, Connections and How to Order
 Page 26
 Performance Curves
 Page 13

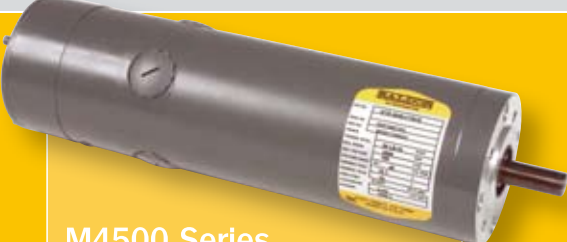

M4500 Series

Dimensions, Connections and How to Order
 Page 28
 Performance Curves
 Page 16

Baldor's DC Servo Motors

Baldor's DC servo motors are environmentally rugged, providing reliability and long life in today's tough applications.

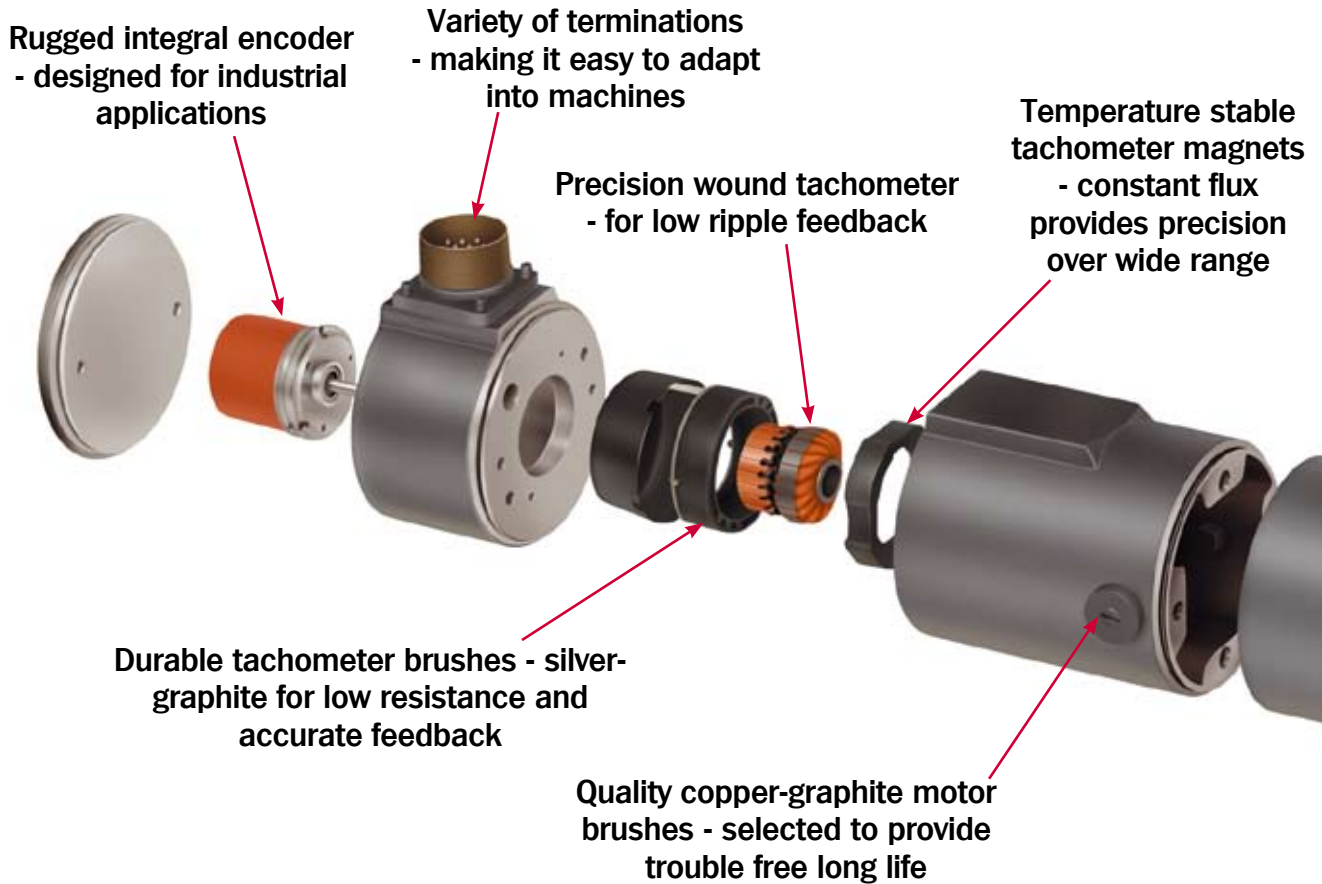

Specification	Description
Rating	Continuous duty 155°C rotor temperature - high temperature design for dependability
Wire	Premium 200°C moisture resistant, multi-coated copper wire for improved product reliability
Insulation	Non-hygroscopic polyester high temperature Class H varnish - designed for dependability
Windings	Variety of electrical windings - performance and versatility for your application needs
Feedback	Precision integral tachometer with low ripple - precise speed regulation; integral encoder - for rugged industrial applications.
Enclosure	Totally enclosed, non-ventilated housing, with optional environmental sealed to IP65 - provides protection in light industrial or demanding environments.
Terminations	Strain relieved cable exits; optional MS connectors, NPT hole, junction box - provides for variety of installation options making it easy to adapt to machines
Bearings	Quality motor grade ball bearings - designed to handle radial and axial load ratings
Brushes	Copper-graphite composition - selected for minimizing wear and maintenance intervals
Mounting	Standard mounting directly interchangeable with many machine tool manufacturers and PMDC motor and stepper manufacturers; optional NEMA and metric mounting - designed for worldwide acceptance

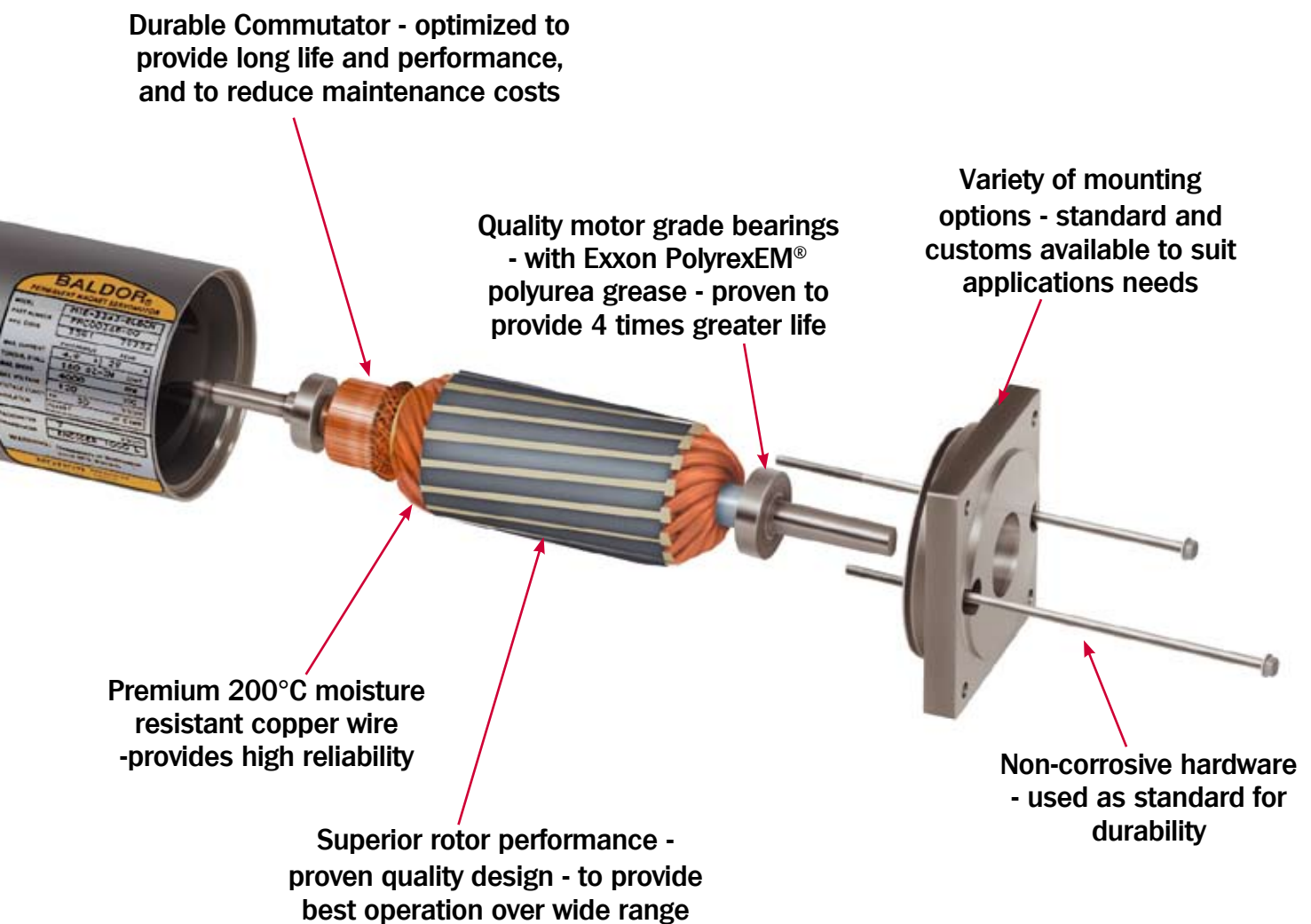



Baldor offers solutions for your motion control solutions...

From speed and positioning, to operating the world's fastest machines - Baldor products are hard at work - they increase productivity, improve quality, reduce cost. Baldor motors are used worldwide in high performance industrial motion control applications.

Baldor strives to provide the best value in industrial electrical motors. That dedication shows in customer preference for Baldor motors.

› DC Servo Motor Performance Selection Guide

Torque				Nominal Volts	Motor RPM	Motor Inertia		Current Cont. at Stall	Order Number
Cont. Stall		Peak				lb-in-sec ²	Kg-Cm ²	Amp	
lb-in	Nm	lb-in	Nm						
1.8	0.21	13	1.4	50	3500	0.0003	0.35	2.1	MT-2240-ACYAN
1.8	0.21	13	1.4	30	3000	0.0003	0.35	3.4	MT-2240-BCYAN
3.1	0.35	19	2.1	50	3500	0.0005	0.54	3.4	MT-2250-ACYAN
3.1	0.35	19	2.1	30	3000	0.0005	0.54	5.5	MT-2250-BCYAN
6.2	0.71	44	4.9	100	2800	0.0016	1.84	2.8	MT-3353-BLYAN
6.2	0.71	44	4.9	50	2000	0.0016	1.84	5.1	MT-3353-DLYAN
8.8	0.99	59	6.7	100	2800	0.0024	2.75	3.8	MT-3358-BLYAN
8.8	0.99	59	6.7	100	5000	0.0024	2.75	6	MT-3358-CLYAN
11.2	1.27	75	8.5	100	2800	0.0033	3.67	4.9	MT-3363-BLYAN
11.2	1.27	75	8.5	100	4000	0.0033	3.67	6.3	MT-3363-CLYAN
12.5	1.41	45	5.0	100	3000	0.007	7.91	5.5	MT-4050-ALYBE
12.5	1.41	45	5.0	100	4500	0.007	7.91	7.9	MT-4050-BLYBE
21.5	2.43	72	8.1	100	1500	0.011	12.43	5	MT-4060-ALYBE
21.5	2.43	72	8.1	100	2300	0.011	12.43	7	MT-4060-BLYBE
28	3.16	125	14.1	100	1500	0.014	15.82	6.2	MT-4070-ALYBE
28	3.16	125	14.1	100	2300	0.014	15.82	9.2	MT-4070-BLYBE
40	4.52	185	20.9	100	1500	0.024	27.12	9	MT-4090-ALYBE
40	4.52	185	20.9	100	2300	0.024	27.12	13	MT-4090-BLYBE
30	3.39	130	14.7	150	2200	0.014	15.82	6.1	MT-4525-BTYCN
30	3.39	130	14.7	150	3200	0.014	15.82	9.2	MT-4525-CTYCN
30	3.39	130	14.7	150	4400	0.014	15.82	12	MT-4525-DTYCN
40	4.52	190	21.5	150	1400	0.021	23.73	5.7	MT-4535-ATYCN
40	4.52	190	21.5	150	2200	0.021	23.73	8.3	MT-4535-BTYCN
40	4.52	190	21.5	150	2700	0.021	23.73	11.2	MT-4535-CTYCN
40	4.52	190	21.5	150	4500	0.021	23.73	16.4	MT-4535-DTYCN
50	5.65	250	28.2	150	1700	0.028	31.64	8	MT-4545-ATYCN
50	5.65	250	28.2	150	2300	0.028	31.64	10.6	MT-4545-BTYCN
50	5.65	250	28.2	150	3300	0.028	31.64	15.7	MT-4545-CTYCN
58	6.55	283	31.8	150	1500	0.035	39.55	8.5	MT-4555-ATYCN
58	6.55	283	31.8	150	2100	0.035	39.55	12.1	MT-4555-BTYCN
58	6.55	283	31.8	150	2900	0.035	39.55	15.3	MT-4555-CTYCN

Speed – Torque Curves

How to Read Motor Performance Curves

Baldor has provided the following curves in order to simplify the process of selecting both a motor and control for a specific application. The following paragraphs explain how the information in these curves should be interpreted.

In constant speed applications, motors are defined in terms of horsepower (which is torque at a base speed). Servo motors normally operate over a wide speed range. The curves show continuous torque (define as torque which will not overheat the motor), and peak torque (defined as intermittent acceleration torque).

It is also necessary to know the current and voltage required for the motor to operate. The curves have a scale that shows current required for any torque, and voltage required for any speed.

As an example, an application requires a continuous torque of 1.5 (0.17 Nm) lb-in at a speed of 1500 RPM. The peak torque required for acceleration is 6 lb-in (0.67 Nm).

This curve shows that the M-2240-A will work in this application. The bus voltage required is 50VDC. The continuous and peak currents required is 1.7 and 6.7 amps. From this information, we select a TSD control (5 amps continuous, 10 amps peak) with a 115VAC input (50VDC Bus).

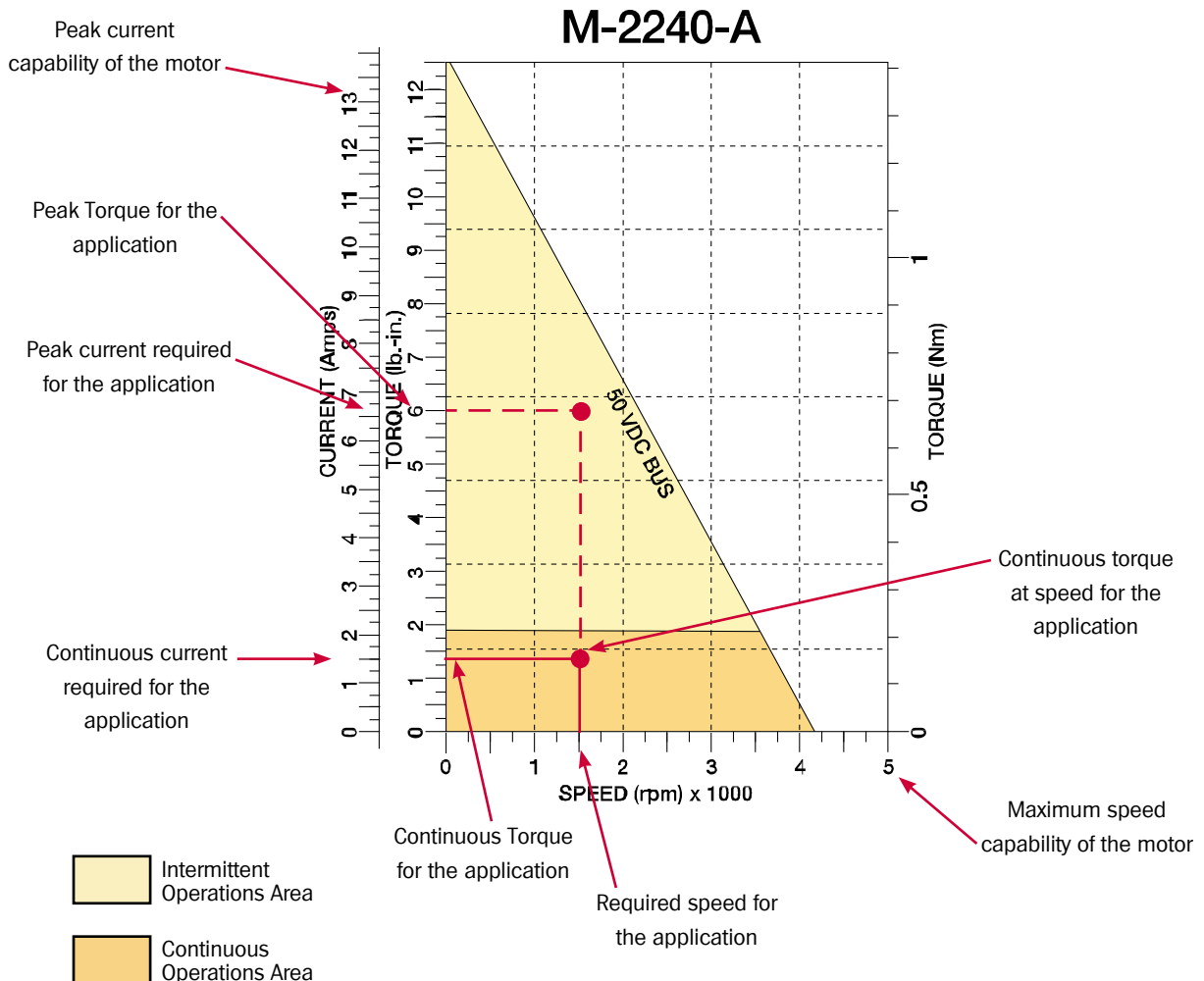

Data in the tables have the following values: The motor's voltage constant (back-emf) and torque constant are "cold" values (25°C); the continuous stall torque and current are "hot" values (155°C). The temperature coefficient factor between "cold" and "hot" is 0.85 for DC motors.

Contact Baldor for special windings, custom shafts/mountings, and custom specs.

M-Series Performance Curves

M-2240-A

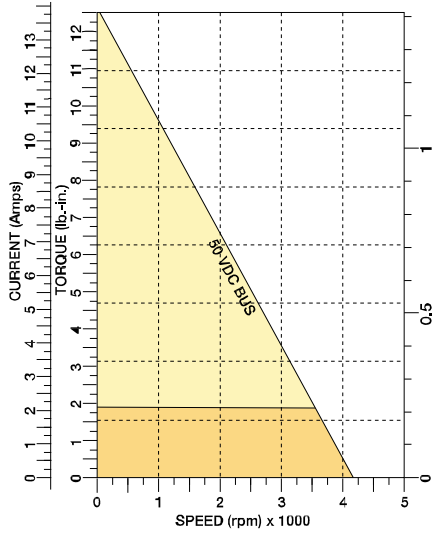

M-2240-B

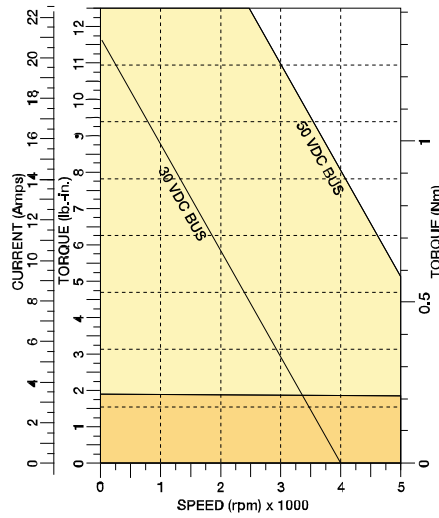

M-2250-A

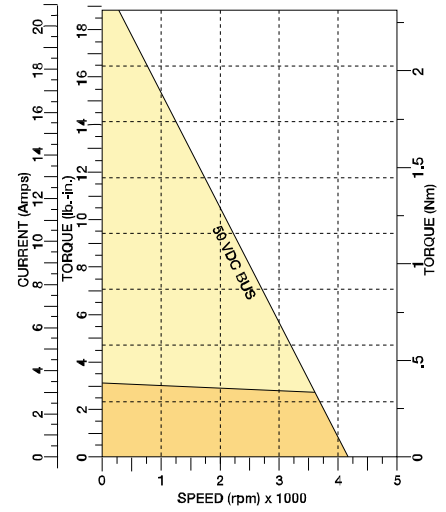

Model Number	MT-2240-A	MT-2240-B	MT-2250-A
--------------	-----------	-----------	-----------

General

Continuous Stall Torque	lb-in	1.88	1.88	3.13
	N-m	0.21	0.21	0.35
Continuous Current	amps	2.05	3.33	3.42
Peak Torque	lb-in	13	13	19
	N-m	1.4	1.4	2.1
Peak Current	amps	12.3	20	18.5
Viscous Damping	lb-in/krpm	0.01	0.01	0.01
	Nm/krpm	7.1 E-04	7.1 E-04	1.4 E-03
Thermal Resistance	°C/watt	5	5	4.2
Thermal Time Constant	Min	20	20	30
Mechanical Time Constant	msec	2.0	2.0	9.5
Electrical Time Constant	msec	7.8	9	2.52
Rated Speed	rpm	3500	3000	3500
Rated Voltage	volts	50	30	50

Electrical

Torque Constant	lb-in/amp	1.012	0.625	1.0125
	N-m/amp	0.115	0.071	0.115
Voltage Constant	Vpk/krpm	12	7.4	12
	v/r/s	0.115	0.071	0.115
Resistance	ohms	4.0	1.6	2.3
Inductance	mH	7.7	3.3	5.8

Mechanical

Inertia	lb-in-s ²	0.00031	0.00031	0.00048
	Kg-cm ²	0.35	0.35	0.54
Maximum Speed	rpm	5000	5000	5000
Weight	lbs/Kg	3.2/1.5	3.2/1.5	3.5/1.6

M-Series Performance Curves

M-2250-B

M-3353-B

M-3353-D

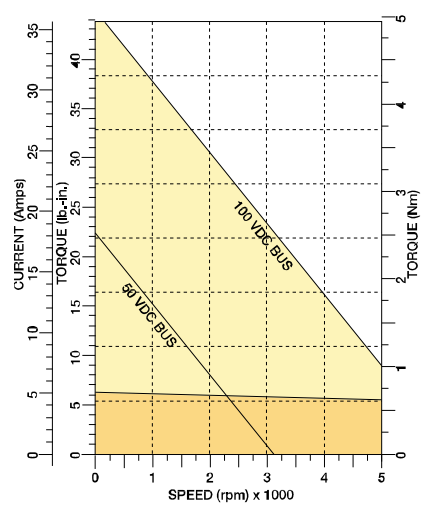
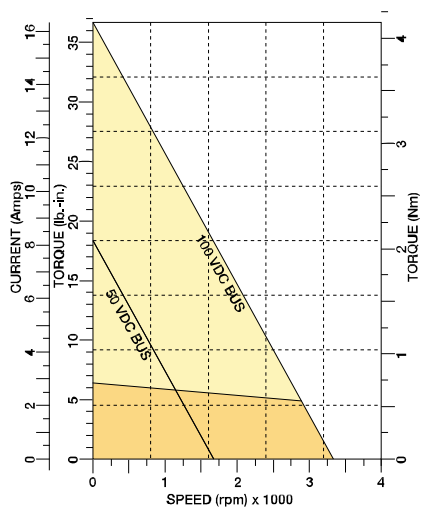
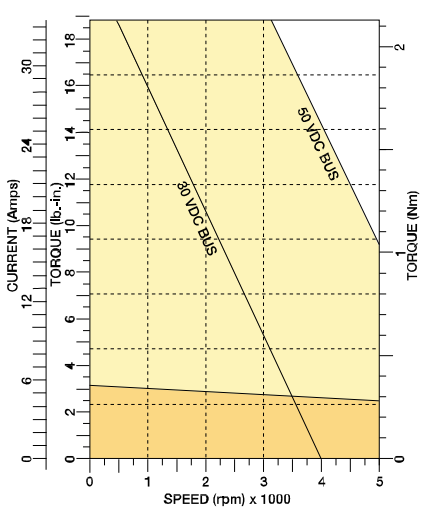

Model Number		MT-2250-B	MT-3353-B	MT-3353-D
General				
Continuous Stall Torque	lb-in	3.13	6.25	6.25
	N-m	0.35	0.71	0.71
Continuous Current	amps	5.5	2.68	4.9
Peak Torque	lb-in	19	44	44
	N-m	2.1	4.94	4.94
Peak Current	amps	30	16.9	34.4
Viscous Damping	lb-in/krpm	0.01	0.04	0.04
	Nm/krpm	1.4 E-03	4.2 E-03	4.2 E-03
Thermal Resistance	°C/watt	4.2	2.8	2.8
Thermal Time Constant	Min	30	30	30
Mechanical Time Constant	msec	9.8	11.96	12.99
Electrical Time Constant	msec	2.78	2.77	2.22
Rated Speed	rpm	3000	2800	2000
Rated Voltage	volts	30	100	50
Electrical				
Torque Constant	lb-in/amp	0.625	2.59	1.41
	N-m/amp	0.071	0.293	0.159
Voltage Constant	Vpk/krpm	7.4	30.7	16.7
	v/r/s	0.071	0.293	0.159
Resistance	ohms	0.9	5.6	1.8
Inductance	mH	2.5	15.5	4.0
Mechanical				
Inertia	lb-in-s ²	0.00048	0.00163	0.00163
	Kg-cm ²	0.54	1.84	1.84
Maximum Speed	rpm	5000	4000	5000
Weight	lbs/Kg	3.5/1.6	8/3.6	8/3.6

M-Series Performance Curves

M-3358-B

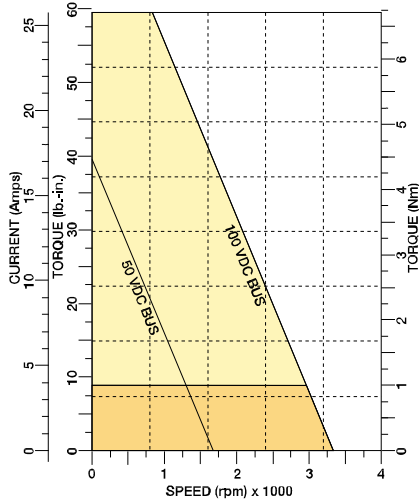

M-3358-C

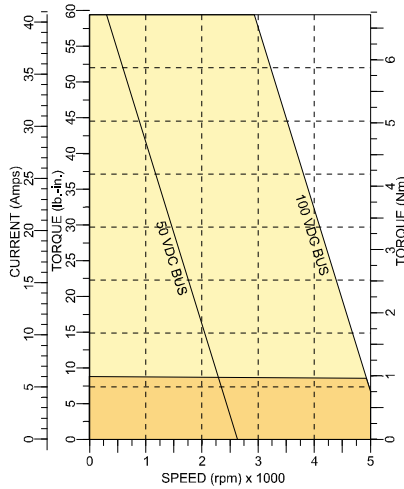

M-3363-B

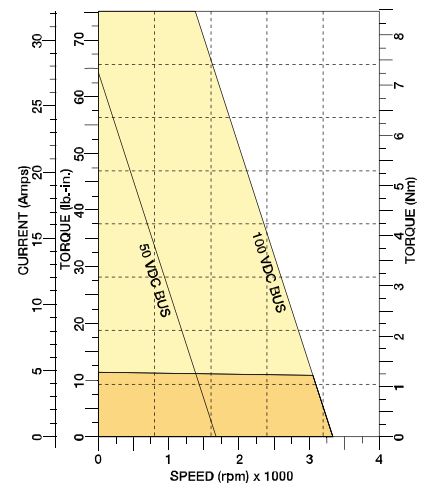

Model Number	MT-3358-B	MT-3358-C	MT-3363-B
--------------	-----------	-----------	-----------

General

Continuous Stall Torque	lb-in	8.75	8.75	11.25
	N-m	0.99	0.99	1.27
Continuous Current	amps	2.68	4.9	4.76
Peak Torque	lb-in	59	59	75
	N-m	6.7	6.7	8.5
Peak Current	amps	24.7	36.6	28.5
Viscous Damping	lb-in/krpm	0.05	0.05	0.07
	Nm/krpm	5.6 E-03	5.6 E-03	7.8 E-03
Thermal Resistance	°C/watt	2.4	2.4	2.1
Thermal Time Constant	MIn	35	35	35
Mechanical Time Constant	msec	8.77	11.47	9.99
Electrical Time Constant	msec	2.76	2.21	2.54
Rated Speed	rpm	2800	5000	2800
Rated Voltage	volts	100	100	100

Electrical

Torque Constant	lb-in/amp	2.67	1.62	2.63
	N-m/amp	0.302	0.183	0.297
Voltage Constant	Vpk/krpm	31.6	19.2	31.1
	v/r/s	0.302	0.183	0.297
Resistance	ohms	2.9	1.4	2.4
Inductance	mH	8.0	3.1	6.1

Mechanical

Inertia	lb-in-s ²	0.00244	0.00244	0.00325
	Kg-cm ²	2.75	2.75	3.67
Maximum Speed	rpm	4000	5000	4000
Weight	lbs/Kg	10/4.5	10/4.5	11/5

M-Series Performance Curves

M-3363-C

M-4050-A

M-4050-B

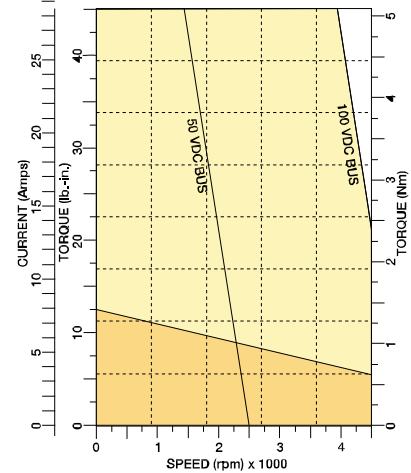
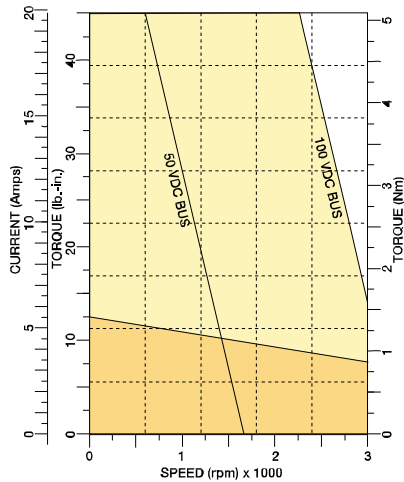
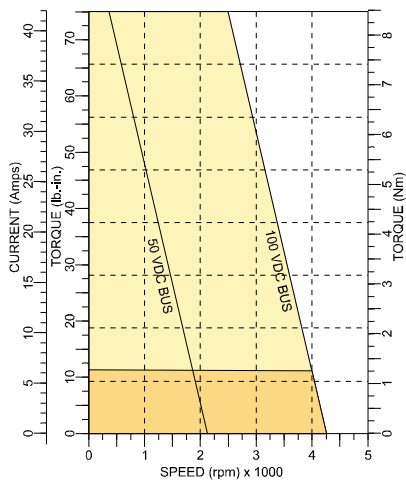

Model Number		MT-3363-C	MT-4050-A	MT-4050-B
General				
Continuous Stall Torque	lb-in	11.25	12.5	12.5
	N-m	1.27	1.41	1.41
Continuous Current	amps	5.99	5.48	8.22
Peak Torque	lb-in	75	45	45
	N-m	8.5	5.08	5.08
Peak Current	amps	35.9	17.75	26.62
Viscous Damping	lb-in/krpm	0.07	0.31	0.31
	Nm/krpm	7.8 E-03	0.035	0.035
Thermal Resistance	°C/watt	2.1	2.2	2.2
Thermal Time Constant	Min	35	50	50
Mechanical Time Constant	msec	11.88	17.35	17.35
Electrical Time Constant	msec	2.06	4.17	3.75
Rated Speed	rpm	4000	3000	4500
Rated Voltage	volts	100	100	100
Electrical				
Torque Constant	lb-in/amp	2.09	2.54	1.69
	N-m/amp	0.297	0.086	0.191
Voltage Constant	Vpk/krpm	24.7	30.0	20.0
	v/r/s	0.297	0.286	0.191
Resistance	ohms	1.8	1.8	0.80
Inductance	mH	3.7	7.5	3.0
Mechanical				
Inertia	lb-in-s ²	0.00325	0.0071	0.0071
	Kg-cm ²	3.67	7.91	7.91
Maximum Speed	rpm	5000	3000	4500
Weight	lbs/Kg	11/5	8/3.63	8/3.63

M-Series Performance Curves

M-4060-A

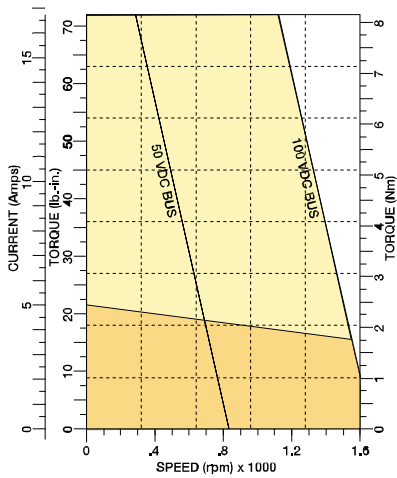

M-4060-B

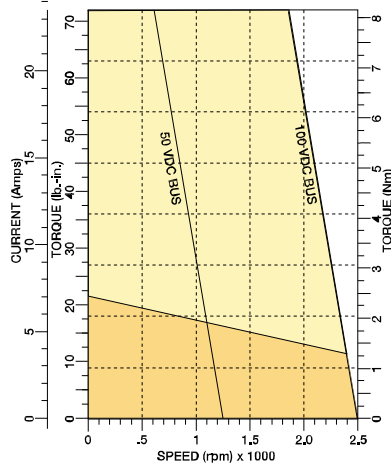

M-4070-A

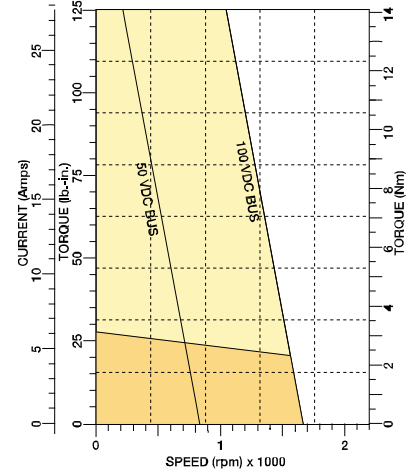

Model Number		MT-4060-A	MT-4060-B	MT-4070-A
General				
Continuous Stall Torque	lb-in	21.5	21.8	28.0
	N-m	2.43	2.43	3.16
Continuous Current	amps	4.71	7	6.13
Peak Torque	lb-in	72	72	125
	N-m	8.1	8.1	14.1
Peak Current	amps	15.8	25	24.65
Viscous Damping	lb-in/krpm	1	1	1.6
	Nm/krpm	0.113	0.113	0.181
Thermal Resistance	°C/watt	1.5	1.5	1.3
Thermal Time Constant	Min	60	60	65
Mechanical Time Constant	msec	8.71	10.22	7.23
Electrical Time Constant	msec	4.71	3.83	4.53
Rated Speed	rpm	1500	2300	1500
Rated Voltage	volts	100	100	100
Electrical				
Torque Constant	lb-in/amp	5.07	3.38	5.07
	N-m/amp	0.573	0.382	0.573
Voltage Constant	Vpk/krpm	60.0	40.0	60.0
	v/r/s	0.573	0.382	0.573
Resistance	ohms	2.3	1.2	1.5
Inductance	mH	9.6	4.6	6.8
Mechanical				
Inertia	lb-in-s ²	0.011	0.011	0.014
	Kg-cm ²	12.43	12.43	15.82
Maximum Speed	rpm	1600	2500	2200
Weight	lbs/Kg	11/4.99	11/4.99	13/5.9

M-Series Performance Curves

M-4070-B

M-4090-A

M-4090-B

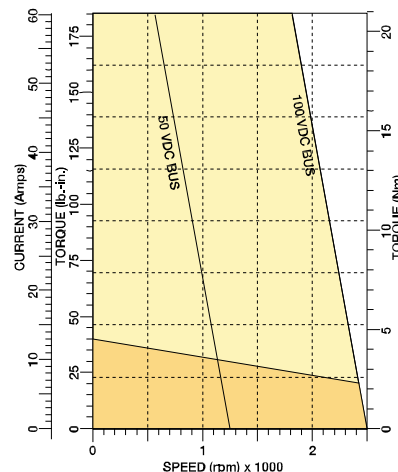
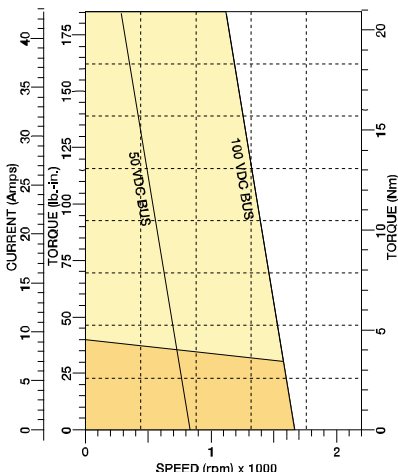
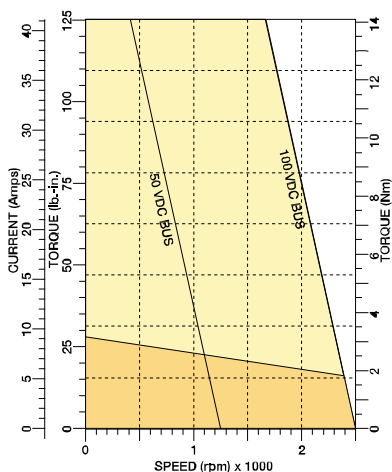

Model Number		MT-4070-B	MT-4090-A	MT-4090-B
General				
Continuous Stall Torque	lb-in	28.0	40.0	40.0
	N-m	3.16	4.52	4.52
Continuous Current	amps	9.2	8.7	13.15
Peak Torque	lb-in	125	185	185
	N-m	14.1	20.9	20.9
Peak Current	amps	36.97	36.5	60.8
Viscous Damping	lb-in/krpm	1.6	2.2	2.2
	Nm/krpm	0.181	0.249	0.249
Thermal Resistance	°C/watt	1.3	1.1	1.1
Thermal Time Constant	Min	65	75	75
Mechanical Time Constant	msec	9.76	7.43	9.29
Electrical Time Constant	msec	3.33	4.78	5.0
Rated Speed	rpm	2300	1500	2300
Rated Voltage	volts	100	100	100
Electrical				
Torque Constant	lb-in/amp	3.38	5.07	3.38
	N-m/amp	0.382	0.573	0.382
Voltage Constant	Vpk/krpm	40.0	60.0	40.0
	v/r/s	0.382	0.573	0.382
Resistance	ohms	0.90	0.9	0.5
Inductance	mH	3.0	4.3	2.5
Mechanical				
Inertia	lb-in-s ²	0.014	0.024	0.024
	Kg-cm ²	15.82	27.14	27.14
Maximum Speed	rpm	2500	2200	2500
Weight	lbs/Kg	13/5.9	18/8.16	18/8.16

M-Series Performance Curves

M-4525-B

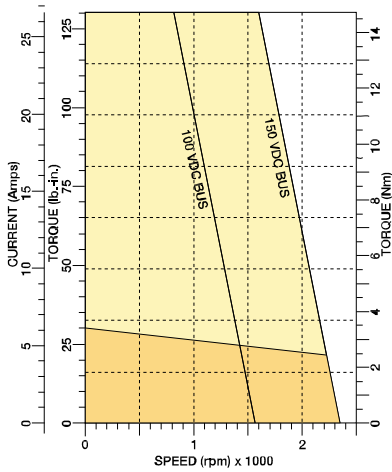

M-4525-C

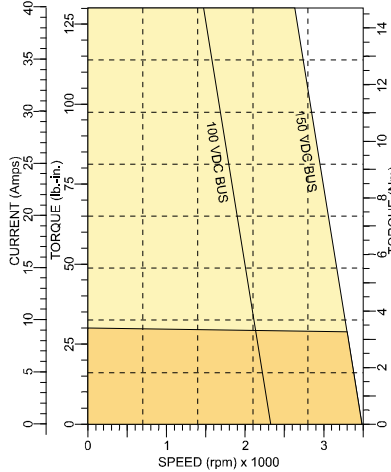

M-4525-D

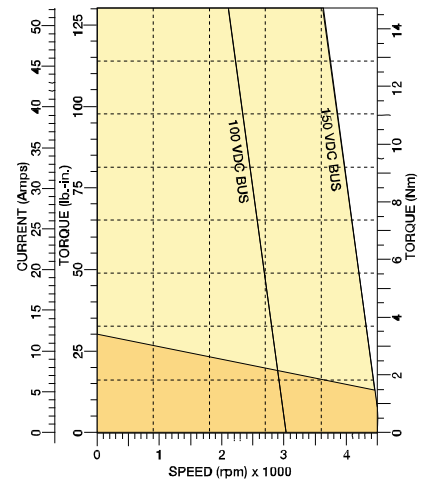

Model Number	MT-4525-B	MT-4525-C	MT-4525-D
--------------	-----------	-----------	-----------

General

Continuous Stall Torque	lb-in	30.0	30.0	30.0
	N-m	3.39	3.39	3.39
Continuous Current	amps	6.16	9.17	12.0
Peak Torque	lb-in	130	130	130
	N-m	14.7	14.7	14.7
Peak Current	amps	24	35.8	46.6
Viscous Damping	lb-in/krpm	1.76	1.76	1.76
	Nm/krpm	0.199	0.199	0.199
Thermal Resistance	°C/watt	1.3	1.3	1.3
Thermal Time Constant	Min	60	60	60
Mechanical Time Constant	msec	8.43	9.57	10.35
Electrical Time Constant	msec	4.52	4.12	3.54
Rated Speed	rpm	2200	3200	4400
Rated Voltage	volts	150	150	150

Electrical

Torque Constant	lb-in/amp	5.41	3.63	2.79
	N-m/amp	0.611	0.411	0.315
Voltage Constant	Vpk/krpm	64	43	33
	v/r/s	0.611	0.411	0.315
Resistance	ohms	1.99	1.02	.065
Inductance	mH	9.0	4.2	2.3

Mechanical

Inertia	lb-in-s ²	0.014	0.014	0.014
	Kg-cm ²	15.82	15.82	15.82
Maximum Speed	rpm	2500	3500	4500
Weight	lbs/Kg	16/7.3	16/7.3	16/7.3

M-Series Performance Curves

M-4535-A

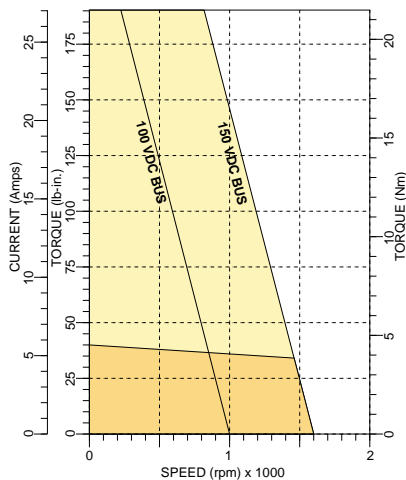

M-4535-B

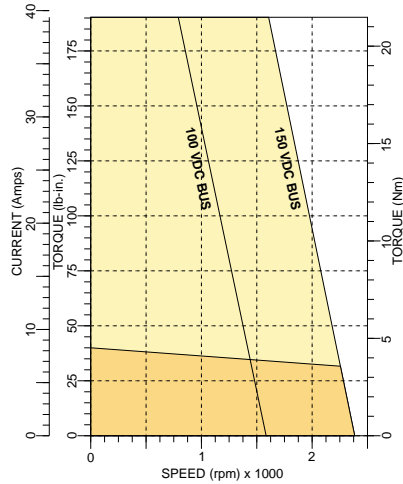

M-4535-C

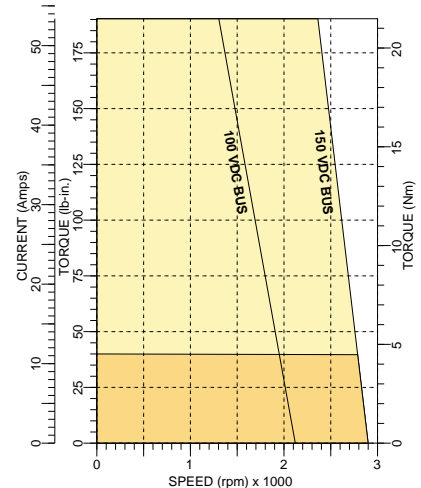

Model Number		MT-4535-A	MT-4535-B	MT-4535-C
General				
Continuous Stall Torque	lb-in	40.0	40.0	40.0
	N-m	4.52	4.52	4.5
Continuous Current	amps	5.7	8.35	11.2
Peak Torque	lb-in	190	190	190
	N-m	21.5	21.5	21.5
Peak Current	amps	24.4	35.7	46.8
Viscous Damping	lb-in/krpm	2.6	2.6	2.6
	Nm/krpm	0.294	0.294	0.294
Thermal Resistance	°C/watt	1.2	1.2	1.2
Thermal Time Constant	Min	70	70	70
Mechanical Time Constant	msec	7.51	8.07	8.63
Electrical Time Constant	msec	5.15	4.19	4.2
Rated Speed	rpm	1400	2200	2700
Rated Voltage	volts	150	150	150
Electrical				
Torque Constant	lb-in/amp	7.78	5.32	3.97
	N-m/amp	0.879	0.602	0.449
Voltage Constant	Vpk/krpm	92	63	47
	v/r/s	0.879	0.602	0.449
Resistance	ohms	2.7	1.36	0.81
Inductance	mH	13.9	5.7	3.4
Mechanical				
Inertia	lb-in-s ²	0.019	0.019	0.019
	Kg-cm ²	21.47	21.47	21.47
Maximum Speed	rpm	1900	2500	3000
Weight	lbs/Kg	20/9.1	20/9.1	20/9.1

M-Series Performance Curves

M-4535-D

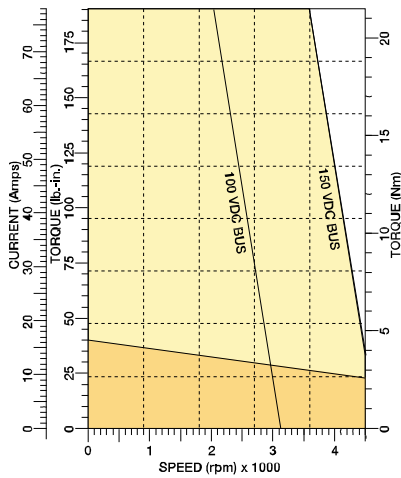

M-4545-A

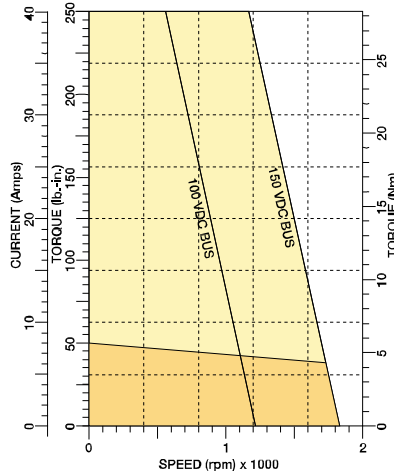

M-4545-B

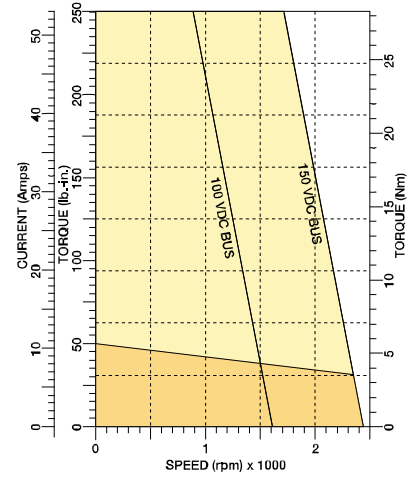

Model Number		MT-4535-D	MT-4545-A	MT-4545-B
General				
Continuous Stall Torque	lb-in	40.0	50	50
	N-m	4.5	5.65	5.65
Continuous Current	amps	16.4	8.02	10.6
Peak Torque	lb-in	190	250	250
	N-m	21.5	28.2	28.2
Peak Current	amps	70.2	36.1	47.7
Viscous Damping	lb-in/krpm	2.6	3.62	3.62
	Nm/krpm	0.294	0.409	0.409
Thermal Resistance	°C/watt	1.2	1.0	1.0
Thermal Time Constant	Min	70	80	80
Mechanical Time Constant	msec	11.49	6.63	7.27
Electrical Time Constant	msec	3.6	4.8	4.26
Rated Speed	rpm	4500	1700	2300
Rated Voltage	volts	150	150	150
Electrical				
Torque Constant	lb-in/amp	2.7	6.93	5.24
	N-m/amp	0.306	0.783	0.592
Voltage Constant	Vpk/krpm	32	82	62
	v/r/s	0.306	0.783	0.592
Resistance	ohms	0.50	1.5	0.94
Inductance	mH	1.8	7.2	4.0
Mechanical				
Inertia	lb-in-s ²	0.019	0.024	0.024
	Kg-cm ²	21.47	27.12	27.12
Maximum Speed	rpm	4500	2000	2500
Weight	lbs/Kg	20/9.1	23/10.4	23/10.4

M-Series Performance Curves

M-4545-C

M-4555-A

M-4555-B

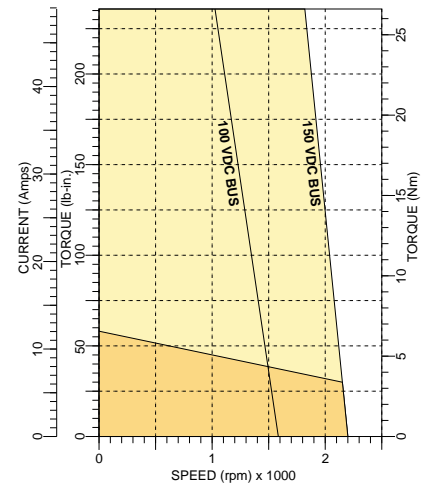
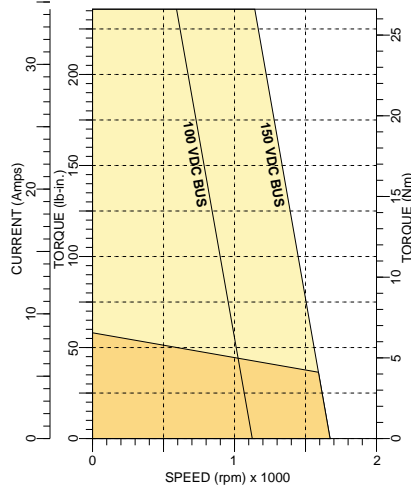
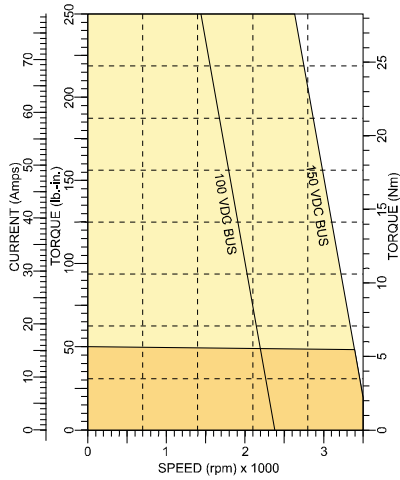

Model Number		MT-4545-C	MT-4555-A	MT-4555-B
General				
Continuous Stall Torque	lb-in	50	56.0	56.0
	N-m	5.65	6.33	6.33
Continuous Current	amps	15.7	8.47	10.9
Peak Torque	lb-in	250	282	282
	N-m	28.2	31.9	31.9
Peak Current	amps	70	38.1	48.8
Viscous Damping	lb-in/krpm	3.62	3.71	3.71
	Nm/krpm	0.409	0.413	0.419
Thermal Resistance	°C/watt	1.0	0.9	0.9
Thermal Time Constant	Min	80	90	90
Mechanical Time Constant	msec	9.44	7.9	7.9
Electrical Time Constant	msec	3.21	5.9	6.5
Rated Speed	rpm	3300	1500	2100
Rated Voltage	volts	150	150	150
Electrical				
Torque Constant	lb-in/amp	3.55	7.61	5.32
	N-m/amp	0.401	0.859	0.602
Voltage Constant	Vpk/krpm	42	90	63
	v/r/s	0.401	0.859	0.602
Resistance	ohms	0.56	1.52	0.6229
Inductance	mH	1.8	7.9	3.8
Mechanical				
Inertia	lb-in-s ²	0.024	0.035	0.035
	Kg-cm ²	27.12	35.03	35.03
Maximum Speed	rpm	3500	1900	2200
Weight	lbs/Kg	23/10.4	27/12.2	27/12.2

M-Series Performance Curves

M-4555-C

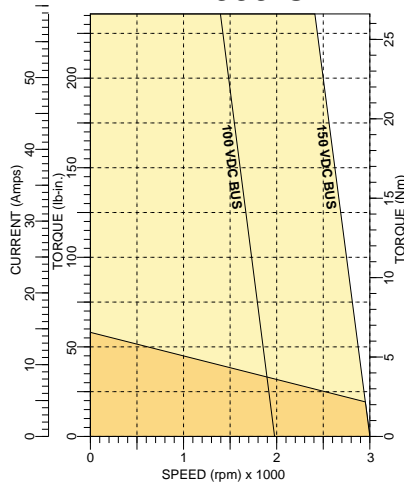

Tachometer Specs

Motor Family	Tach K_E	Inertia	
	V/K rpm	Oz-in-s ²	Kg-cm ²
M2200	7	0.01	0.71
M3300	7	0.01	0.71
M4000	7	0.01	0.71
M4500	9.5	0.01	0.71

Note: Ripple less than 1%
Measured average to peak

Encoder Data

Specification	Description
Resolution (ppr)	100 / 500 / 100/ 1024 / 2000 / 2500 / Custom
Output	Differential Line Driver Logic "1" Vcc = 2V (min) 4 ma Max Source Current Logic "0" Vcc = 0.4V (max) 8 ma Max Sink Current
Voltage	5 VDC ± 5% @ 80 ma
Inertia	0.0001 oz - in - s ²
Frequency Response	200 KHz
Index	Non-gated There is no specific alignment between index and channels
Vibration	50 to 2000 Hz. @ 10 G's
Shock	30 G's for 11 ms

Brake Data

Motor Family	Holding Torque		Brake Watts
	lb-in	N-m	
M2200	5	0.56	7
M3300	25	2.8	12
M4000	45	5.08	12
M4500	70	7.91	12

Motor Family	Brake Inertia	
	lb-in-s ²	Kg-cm ²
M2200	0.0000044	0.0049
M3300	0.000141	0.16
M4000	0.000142	0.16
M4500	0.00024	0.27

Note: All brake voltage = 24 VDC
Current = Watts/24

Model Number		MT-4555-C
General		
Continuous Stall Torque	lb-in	56.0
	N-m	6.33
Continuous Current	amps	13.7
Peak Torque	lb-in	282
	N-m	31.9
Peak Current	amps	61.6
Viscous Damping	lb-in/krpm	3.71
	Nm/krpm	0.419
Thermal Resistance	°C/watt	0.9
Thermal Time Constant	Min	90
Mechanical Time Constant	msec	7.9
Electrical Time Constant	msec	5.2
Rated Speed	rpm	2900
Rated Voltage	volts	150
Electrical		
Torque Constant	lb-in/amp	4.23
	N-m/amp	0.47
Voltage Constant	Vpk/krpm	50
	Vrms/krpm	0.477
Resistance	ohms	0.3938
Inductance	mH	2.6
Mechanical		
Inertia	lb-in-s ²	0.035
	Kg-cm ²	35.03
Maximum Speed	rpm	3500
Weight	lbs/Kg	27/12.2

DC Servo Motors

Thrust Load Capacity

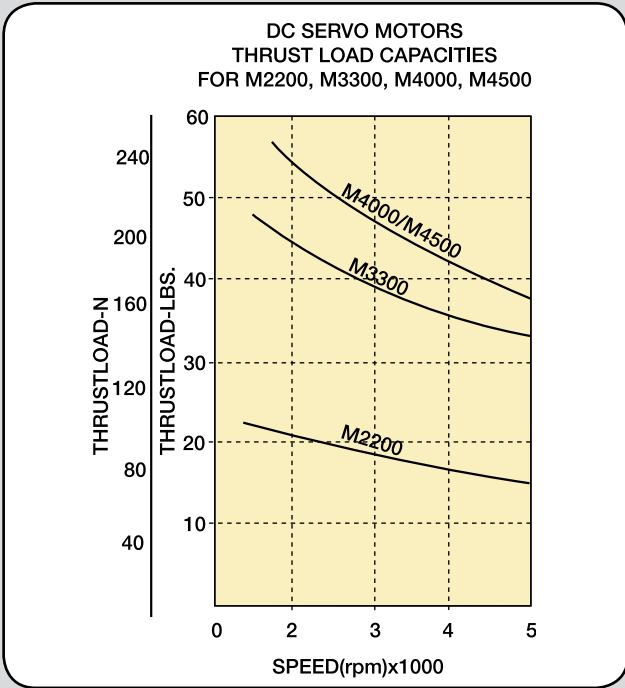

Radial Load Capacity

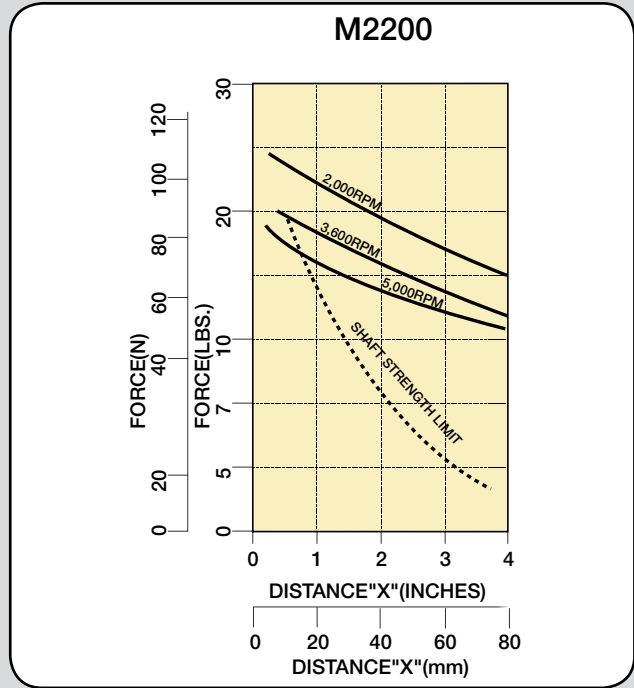

Radial Load Capacity

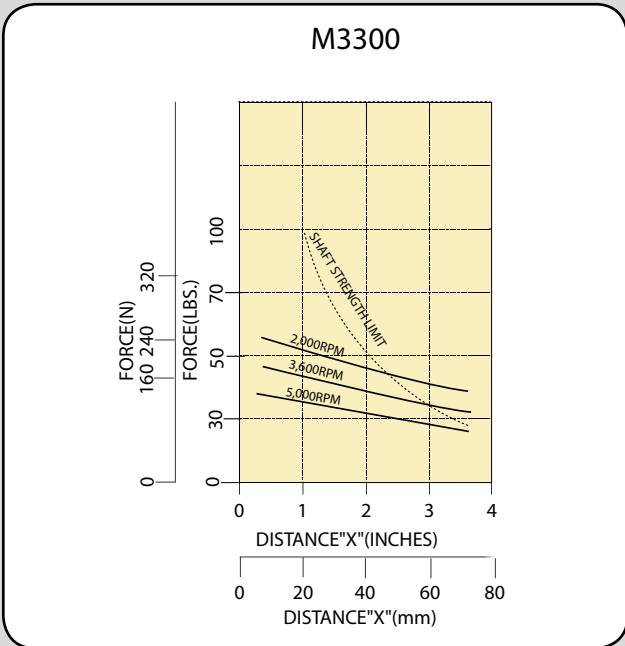

Radial Load Capacity

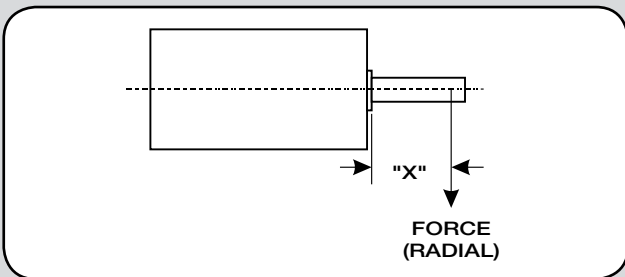
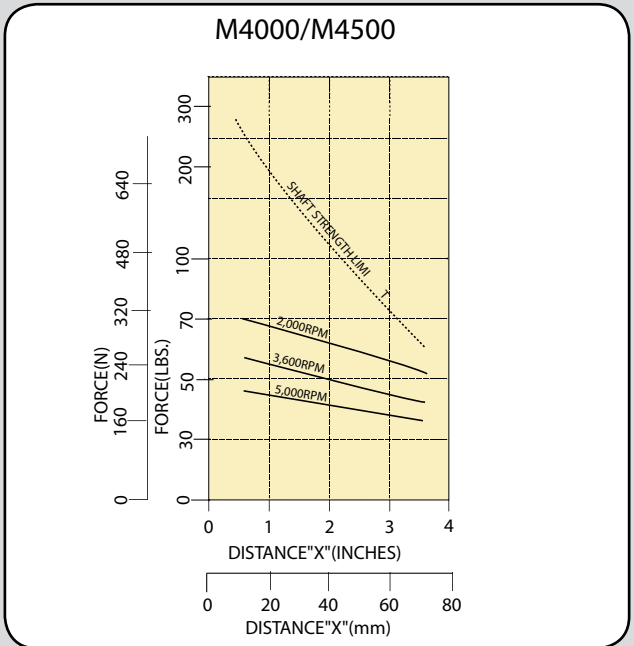

Notes:

- 1) Solid lines are based on $L_{10} = 100,000$ hours.
- 2) Dashed line is based on 10^4 load peaks @ 110% of rated torque.

DC Servo Motors

M2200 Series Dimensions

Motor — Tachometer
Standard “C” Face Mounting

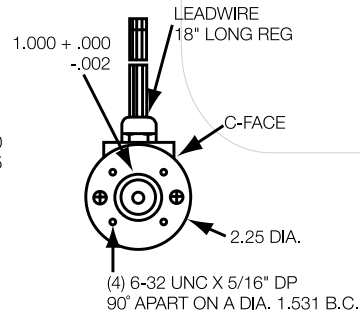
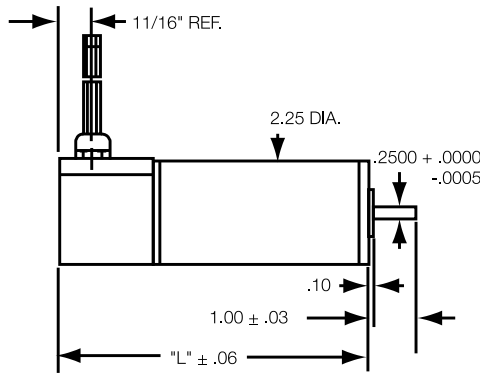

Optional Terminations

Option “A”

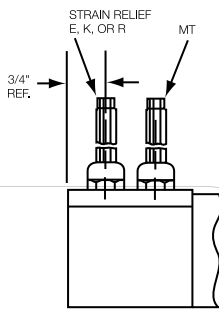

Option “C”

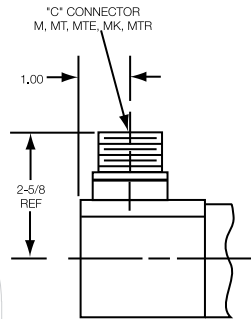

Optional “M” Mounting

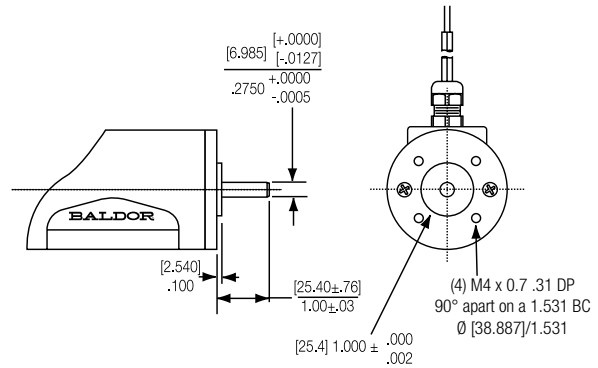

Optional “L” Mounting

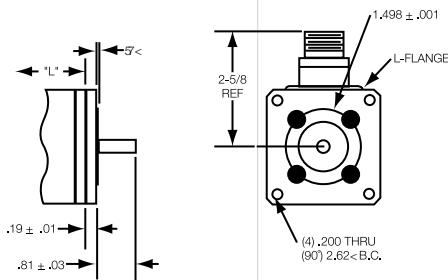

Optional “D” Mounting

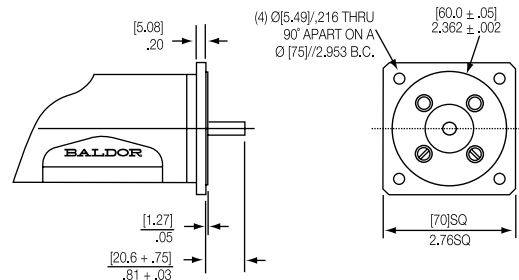

Configuration Length

Model	M	MT	MTE	MTR	ME	MR	MK	MTK
M2240	5.59/141.9	5.59/141.9	7.84/199.1	8.69/220.7	6.12/155.4	7.54/191.5	5.59/141.9	7.22/183.3
M2250	6.59/167.3	6.59/167.3	8.84/224.5	9.69/246.1	7.12/180.8	8.54/216.9	6.59/167.3	8.22/208.7

Note: Dimensions are in Inches/mm.

Connection Diagrams

6 Pin

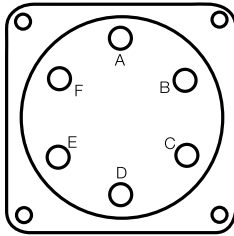

MOTOR CONNECTOR
MS3102E-14S-06P

14 Pin

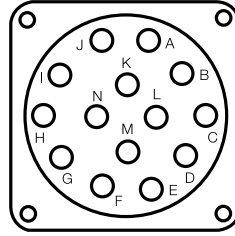

MOTOR
MS3102E-20-27P

M2200, M, MT, MB, MTB, Versions

PIN	Function (Optional)
A	Motor C.C.W. (+)
B	Motor C.C.W. (-)
C	Tach C.C.W. (-)
D	Tach C.C.W. (+)
E	Tach Shield (or brake)
F	(Brake)

M2200, ME, MTE, MTEB, Versions

PIN	Function (Optional)
A	Encoder Shield (or brake)
B	Tach C.C.W. (+)
C	Motor C.C.W. (-)
D	Channel Z
E	Channel B
F	Common
G	Channel A
H	Motor C.C.W. (+)
I	Tach Shield (or brake)
J	Channel B
K	Tach C.C.W. (-)
L	Channel Z
M	+5 VDC
N	Channel A

M2200, MR, MTR, Versions

PIN	Function (Optional)
A	(Motor Ground)
B	Tach Lead (+)
C	Motor Lead (-)
D	S1
E	S4
F	R1
G	R2
H	Motor Lead (+)
I	Tach Shield
J	Open
K	Tach Lead (-)
L	Open
M	S1 and S3
N	Open

Leads Out

Series	M2200
Rotation	C.C.W.
Motor	Red (+), Black (-)
Tach	Red (-), Black (+)

Note: All motor rotation is facing output shaft.

How to Order

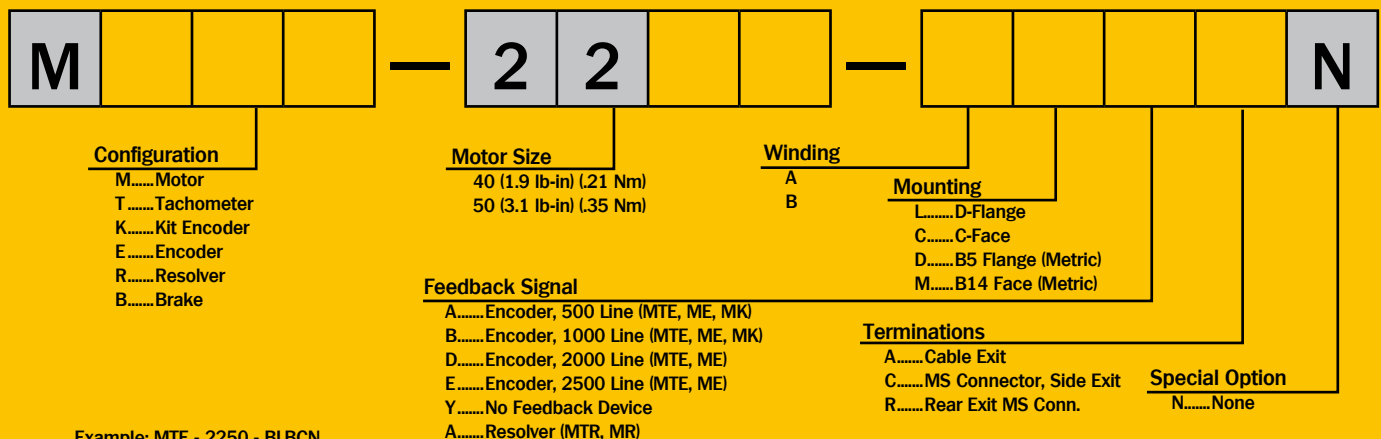

Example: MTE - 2250 - BLBCN
 Motor - Tach - Encoder with B-Winding,
 square flange, 1000 line encoder, MS
 side mounted connector.

DC Servo Motors

M3300 Series Dimensions

Motor — Tachometer Standard "L" Flange Mounting

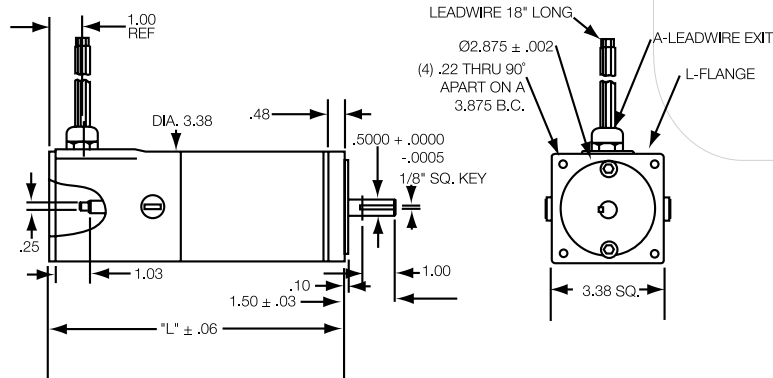

Optional Terminations

Option "A"

Option "C"

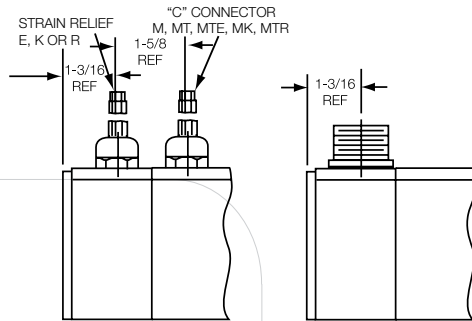

Encoder Terminations

Standard with Metric Mounting "D" & "M"

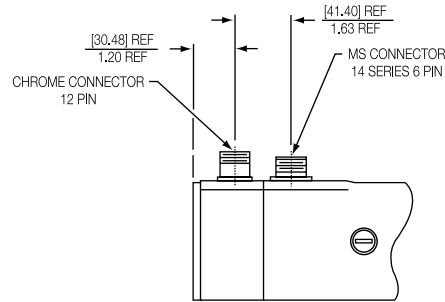

Optional "M" Mounting

Optional "C" Mounting

Optional "D" Mounting

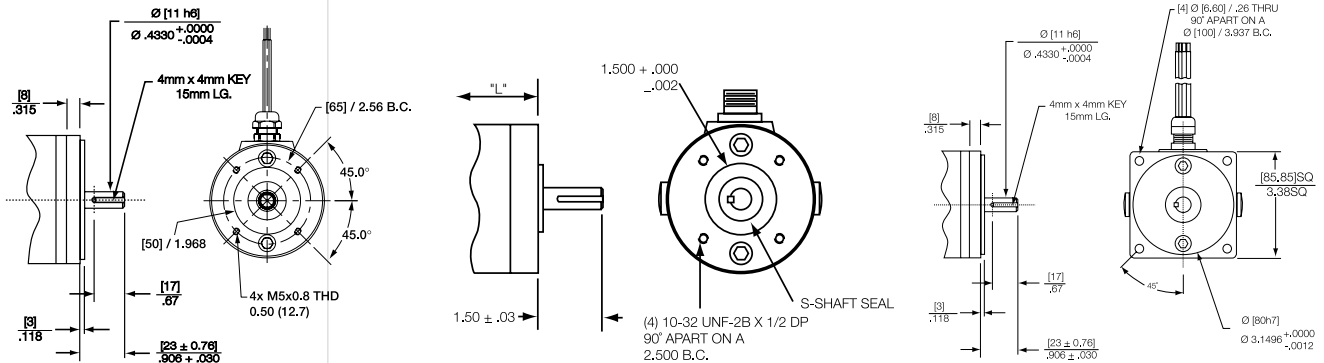

Configuration Length

Model	M	MT	MTE	ME	Brake Length Adder to "L"
M3353	5.63/143.0	7.86/199.6	9.50/241.3	8.2/213.9	1.8/45.7
M3358	6.63/168.4	8.86/225	10.50/266.7	9.42/239.3	1.8/45.7
M3363	7.63/193.8	9.89/250.4	11.50/292.1	10.42/264.7	1.8/45.7

Note: Dimensions are in Inches/mm.

Connection Diagrams

6 Pin

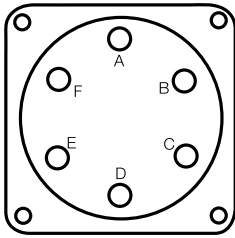

MOTOR CONNECTOR
MS3102E-14S-06P

14 Pin

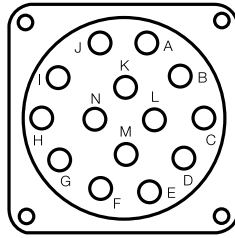

MOTOR
MS3102E-20-27P

12 Pin

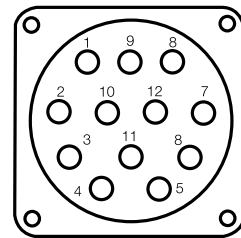

MOTOR CONNECTOR
CHROME 12 PIN

M3300, M, MT, MB, MTB, Versions

PIN	Function (Optional)
A	Motor C.C.W. (+)
B	Motor C.C.W. (-)
C	Tach C.C.W. (-)
D	Tach C.C.W. (+)
E	Tach Shield (or brake)
F	(Brake)

M3300, ME, MTE, MTEB, MR, MTR, Versions

PIN	ME, MTE, MTEB (Optional)	MR, MTR
A	Encoder Shield (or brake)	Open (MTR end)
B	Tach C.C.W. (+)	Tach (+)
C	Motor C.C.W. (-)	Motor (-)
D	Channel Z	S1
E	Channel B	S4
F	Common	R1
G	Channel A	R2
H	Motor C.C.W. (+)	Motor (+)
I	Tach Shield (or brake)	Tach Shield
J	Channel B	Open
K	Tach C.C.W. (-)	Tach (-)
L	Channel Z	Open
M	+5 VDC	S1 and S3
N	Channel A	Open

Encoder Connection

(on motors ordered with D & M mounting options)

PIN	Function
1	Channel B
3	Channel Z
4	Channel Z
5	Channel A
6	Channel A
8	Channel B
9	Shield
10	Common
12	+5 VDC

Leads Out

Series	M3300
Rotation	C.C.W.
Motor	Red (+), Black (-)
Tach	Red (-), Black (+)

Note: All motor rotation is facing output shaft.

How to Order

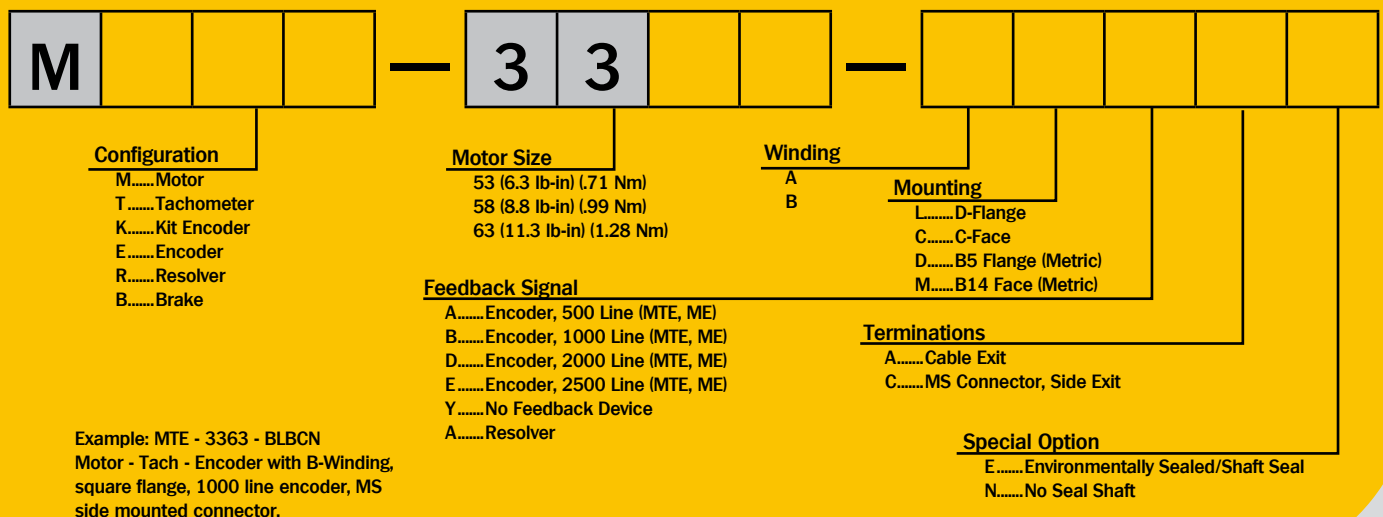

DC Servo Motors

M4000 Series Dimensions

Motor — Tachometer Standard “L” Flange Mounting

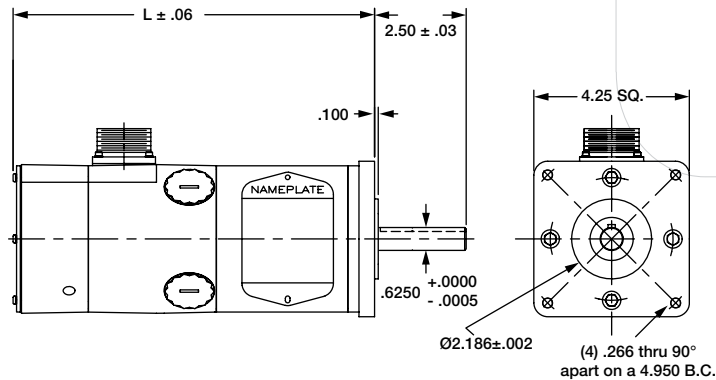

Option “A”

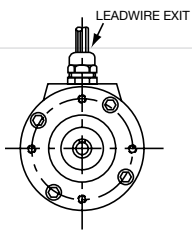

Optional Terminations

Option “B”

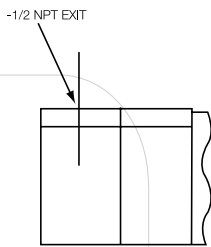

Option “C”

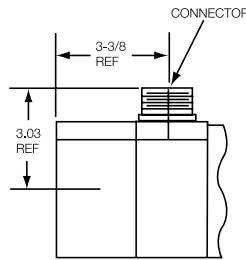

Encoder Terminations Standard with Metric Mounting “D” & “M”

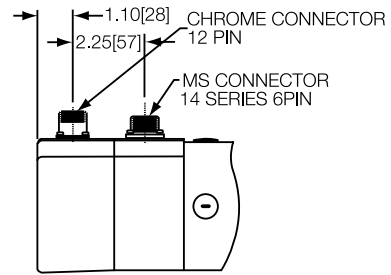

Optional “C” Mounting

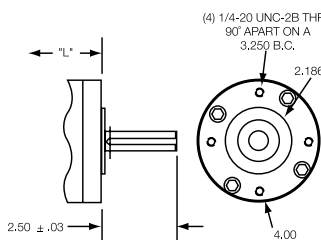

Optional “N” Mounting

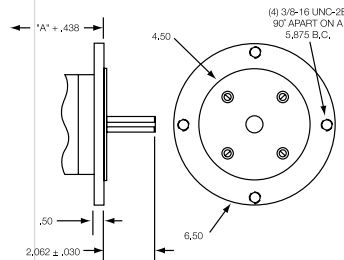

Optional “M” Mounting

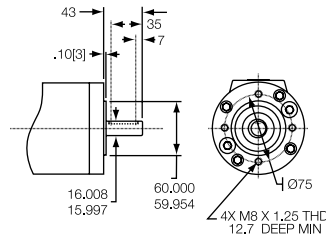

Optional “D” Mounting

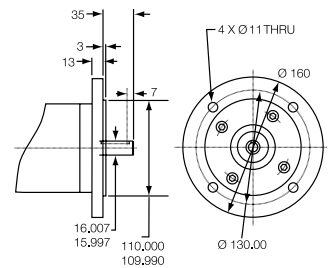

Configuration Length

Model	M	MT	MTE	ME	Brake Length Adder to “L”
M4050	7.27/184.7	7.04/178.8	9.2/233.6	9.2/233.6	2.46/62.4
M4060	8.27/210.1	8.04/204.2	10.2/259	10.2/259	2.46/62.4
M4070	9.27/235.5	9.04/229.6	11.2/284.4	11.2/284.4	2.46/62.4
M4090	11.27/286.3	11.04/280.4	13.2/335.2	13.2/335.2	2.46/62.4

Note: Dimensions are in Inches/mm.

6 Pin

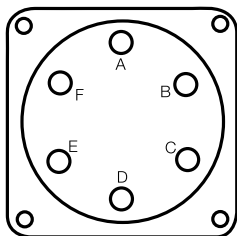

MOTOR CONNECTOR
MS3102E-14S-06P

9 Pin

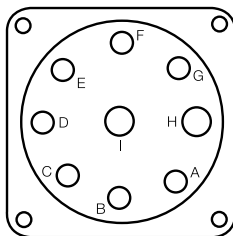

MOTOR CONNECTOR
MS3102E-20-16P

16 Pin

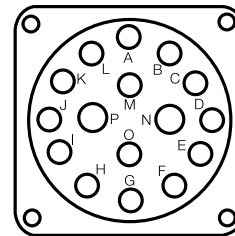

MOTOR CONNECTOR
MS3102E-24-07P

M4050/4060, M, MT, MB, MTB, Versions

PIN	Function (Optional)
A	Motor C.C.W. (+)
B	Motor C.C.W. (-)
C	Tach C.C.W. (-)
D	Tach C.C.W. (+)
E	Tach Shield (or brake)
F	(Brake)

M4070/4090, M, MT, MB, MTB, Versions

PIN	Function (Optional)
A	Tach C.C.W. (-)
B	Tach C.C.W. (+)
E	(Brake)
F	(Brake)
G	Tach Shield
H	Motor C.C.W. (-)
I	Motor C.C.W. (+)

M4000, ME, MEB, MTE, MTEB, Versions

PIN	Function (Optional)
A	Channel A
B	Channel A
C	Channel B
D	Channel B
E	Channel Z
F	Channel Z
G	(Brake)
H	+5 VDC
I	Common
J	(Brake)
K	Encoder Shield
L	Tach Shield
M	Tach C.C.W. (+)
N	Motor C.C.W. (-)
O	Tach C.C.W. (-)
P	Motor C.C.W. (+)

Leads Out

Series	M4000
Rotation	C.C.W.
Motor	Red (+), Black (-)
Tach	Red (-), Black (+)

Note: All motor rotation is facing output shaft.

How to Order

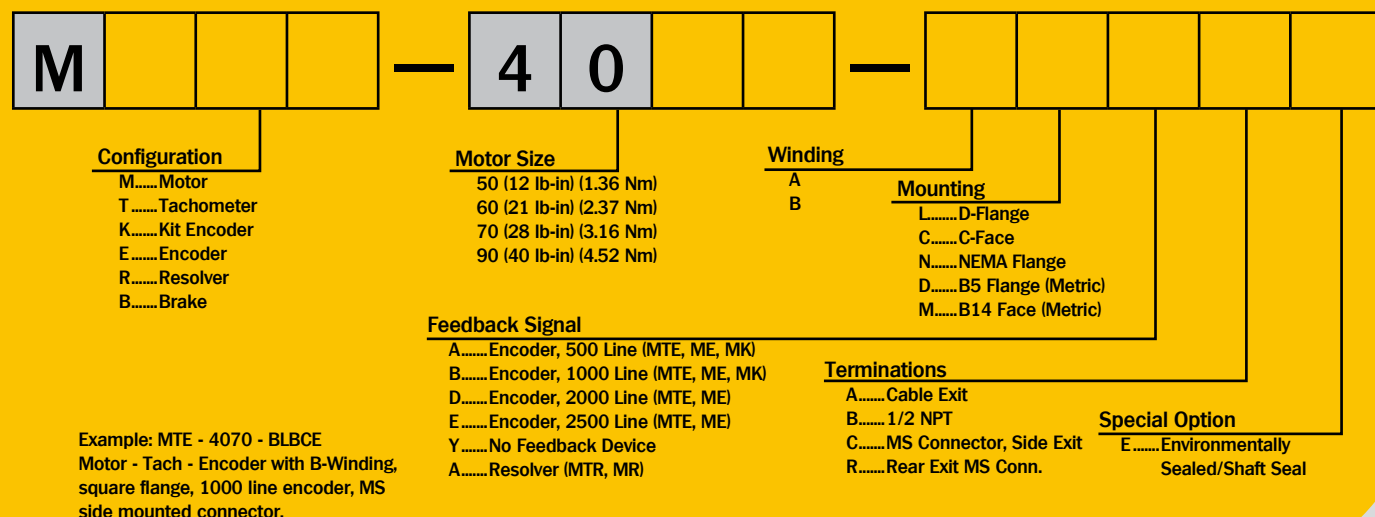

DC Servo Motors

M4500 Series Dimensions

Motor — Tachometer Standard “T” Metric Face Mounting

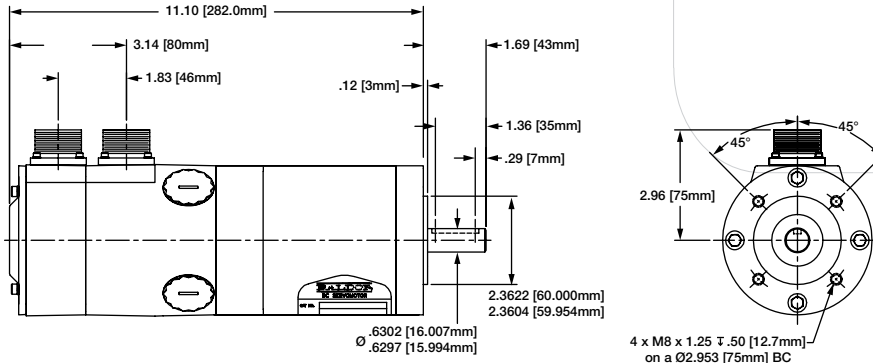

Encoder Terminations Standard with Metric Mounting “D” & “M”

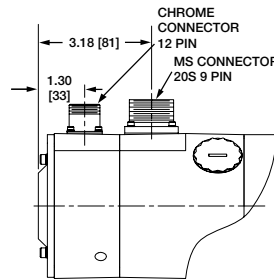

Optional “H” or “D” Mounting

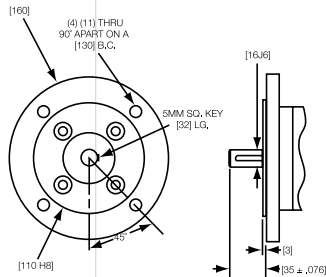

Optional “N” Mounting

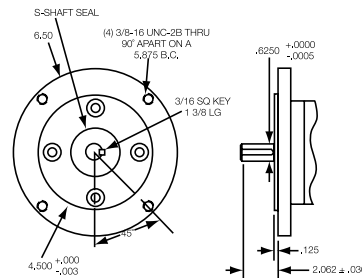

Configuration Length

Model	M / MT	MTE	Brake Length Adder to “L”
M4515	8.0/203.2	9.6/243.8	1.82/46.22
M4525	9.5/241.3	11.1/281.9	1.82/46.22
M4535	11.0/279.4	12.6/320.0	1.82/46.22
M4545	12.3/317.5	14.1/358.1	1.82/46.22
M4555	14.0/355.6	15.6/396.2	1.82/46.22

Note: Dimensions are in Inches/mm.

9 Pin

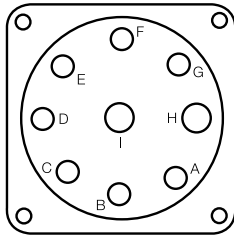

MOTOR CONNECTOR
MS3102E-20-16P

14 Pin

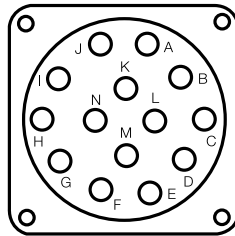

MOTOR
MS3102E-20-27P

12 Pin

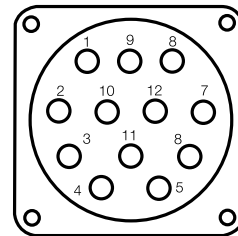

MOTOR CONNECTOR
CHROME 12 PIN

M4500 M, MT, MB, MTB, Versions

PIN	Function (Optional)
A	Tach C.W. (+)
B	Tach C.W. (-)
C	Thermal Switch
D	Thermal Switch
E	(Brake)
F	(Brake)
G	Tach Shield
H	Motor C.W. (+)
I	Motor C.W. (-)

Encoder/Resolver Connection
(on motors ordered with T, H, N mounting options)

PIN	Encoder	Resolver
A	Encoder Shield	—
D	Channel Z	S1
E	Channel B	S4
F	Common	R1
G	Channel A	R2
J	Channel B	—
L	Channel Z	—
M	+5 VDC	S2
N	Channel A	S3

Encoder Connection
(on motors ordered with D & M mounting options)

PIN	Function
1	Channel B
3	Channel Z
4	Channel Z
5	Channel A
6	Channel A
8	Channel B
9	Shield
10	Common
12	+5 VDC

Leads Out

Series	M4500
Rotation	C.W.
Motor	Red (+), Black (-)
Tach	Red (-), Black (+)

Note: All motor rotation is facing output shaft.

How to Order

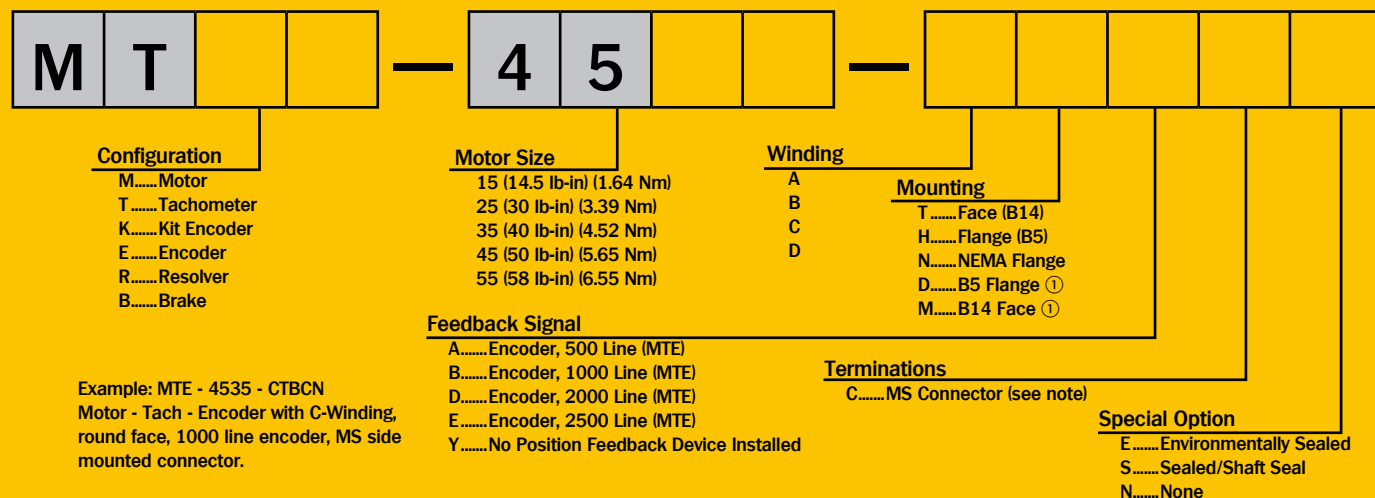

Note: ① Includes chrome 12 pin connector on encoder feedback when ordered with "D" or "M" mounting options. The MTE4500 series have two connectors. One connector for power and tachometer, and connector for encoder. The mating connectors must be ordered separately.

DC Servo Motor Cable Assemblies

› Catalog Number Definition

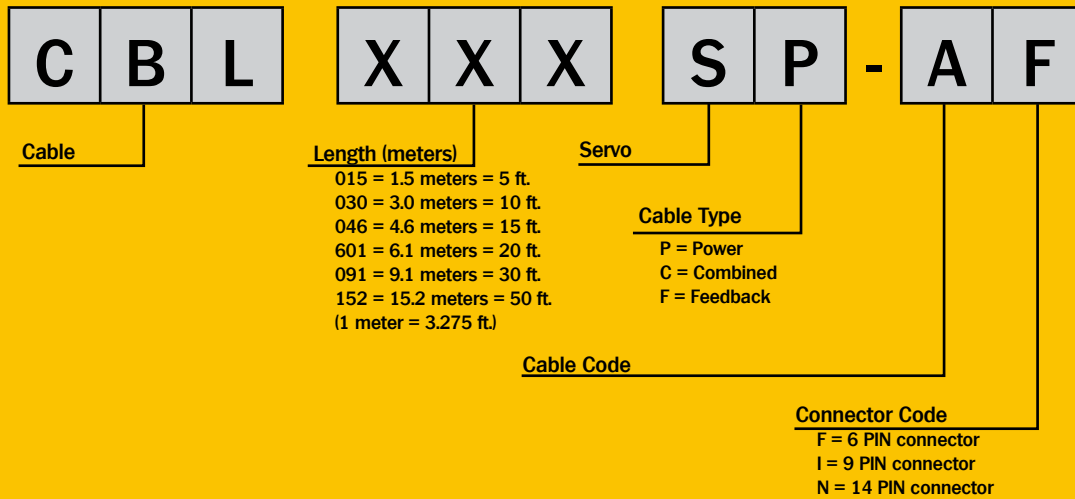

Cable Assembly used on M2200/3300 Motor Series

Motor Prefix	Number of Connector Pins	Mating Connector Order No.	Cable assembly Order No.	Length	
				Meters	Feet
M, MT - 2000 M, MT, MTB, MB - 3000	6	MSCF	CBL030SP-AF	3.0	10
	6		CBL061SP-AF	6.1	20
	6		CBL091SP-AF	9.1	30

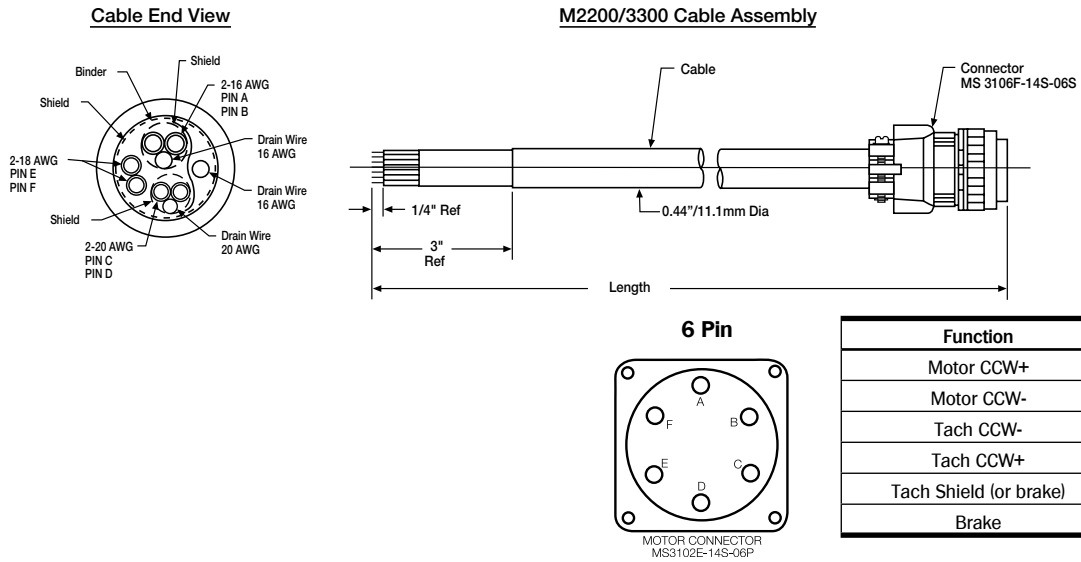

Motor Prefix	Number of Connector Pins	Mating Connector Order No.	Cable assembly Order No.	Length	
				Meters	Feet
MTE, ME - 2200 MTE, ME, MTEB, MEB - 3300	14	MSCN	CBL030SC-GN	3.0	10
	14		CBL061SC-GN	6.1	20
	14		CBL091SC-GN	9.1	30

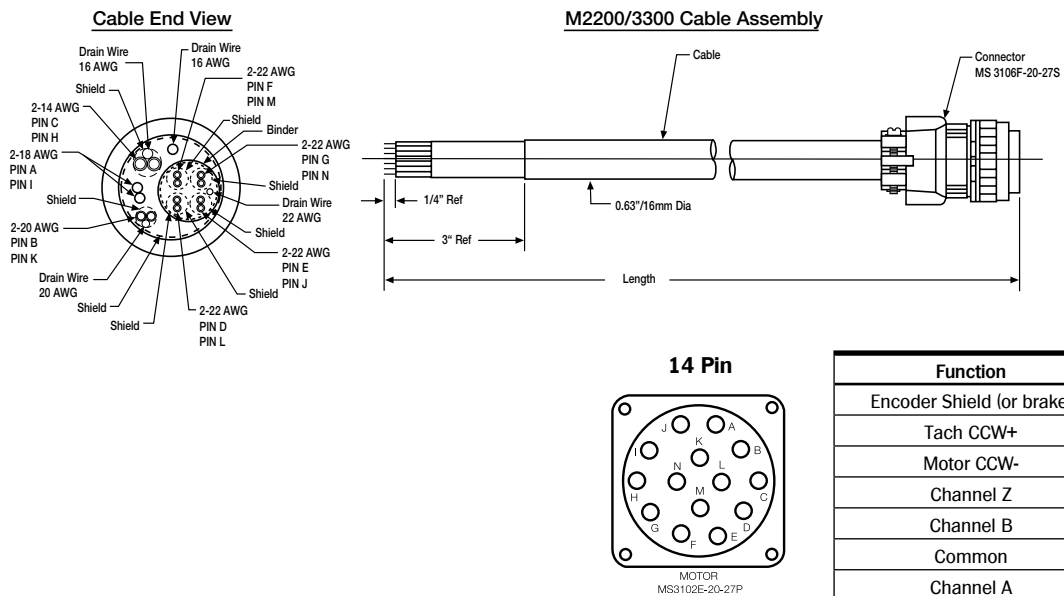

Cable Assembly used on M4000/4500 Motor Series

Motor Prefix	Number of Connector Pins	Mating Connector Order No.	Cable assembly Order No.	Length	
				Meters	Feet
M, MT, MB, MTB - 4050/4060	6	MSCF	CBL030SP-AF	3.0	10
	6		CBL061SP-AF	6.1	20
	6		CBL091SP-AF	9.1	30

Cable End View

M4050/4060 Cable Assembly

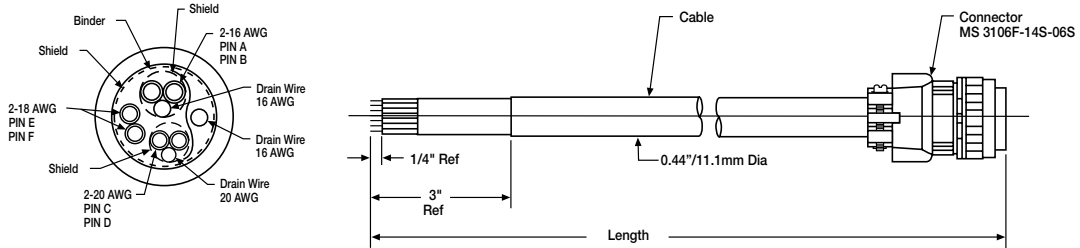

6 Pin

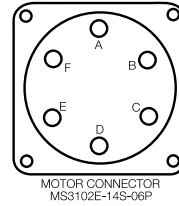

M4050/4060	
Function	Pin
Motor CCW+	A
Motor CCW-	B
Tach CCW-	C
Tach CCW+	D
Tach Shield (or brake)	E
Brake	F

Motor Prefix	Number of Connector Pins	Mating Connector Order No.	Cable assembly Order No.	Length	
				Meters	Feet
M, MT, MTB, MB - 4070/4090 M, MT, MTB, MB - 4500 ①	9	MSCI	CBL030SP-BI	3.0	10
	9		CBL061SP-BI	6.1	20
	9		CBL091SP-BI	9.1	30

Note: ① The MTE-4500 Series with encoder feedback requires two cables; one for power and one for feedback.

Cable End View

M4070/4090/4500 Cable Assembly

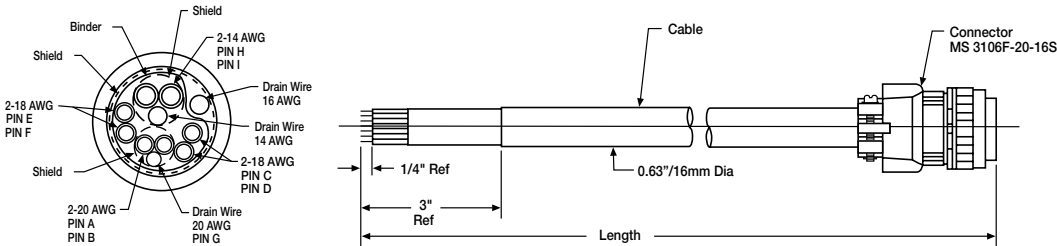

9 Pin

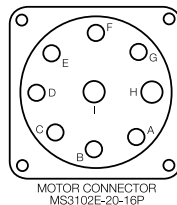

M4070/4090		M4500	
Function	Pin	Function	Pin
Tach CCW-	A	Tach CCW-	A
Tach CCW+	B	Tach CCW+	B
(Brake)	E	(Brake)	E
(Brake)	F	(Brake)	F
Tach Shield	G	Tach Shield	G
Motor CCW-	H	Motor CCW+	H
Motor CCW+	I	Motor CCW-	I

Cable Assembly used on M4000/4500 Motor Series

Motor Prefix	Number of Connector Pins	Mating Connector Order No.	Cable assembly Order No.	Length	
				Meters	Feet
MTE, ME, MTEB, MEB -4050, -4060, -4070, -4090	16	MSCP	CBL061SC-GP	6.1	20
	16		CBL091SC-GP	9.1	30

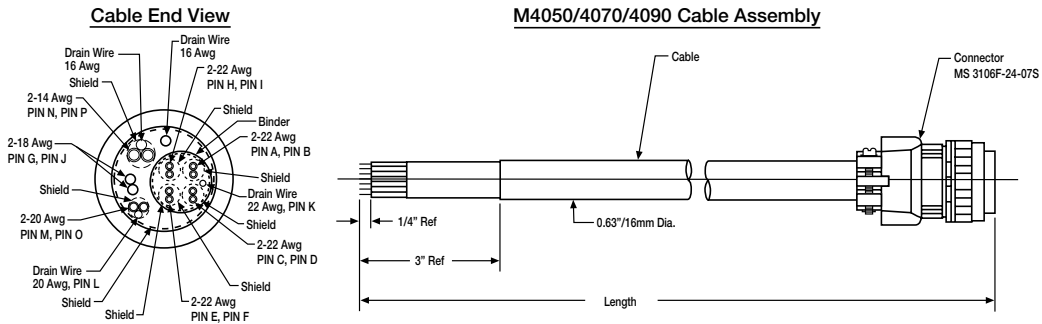

Function	Pin
Channel A	A
Channel A/	B
Channel B	C
Channel B/	D
Channel Z	E
Channel Z/	F
(Brake)	G
+5 VDC	H
Common	I
(Brake)	J
Encoder Shield	K
Tach Shield	L
Tach CCW+	M
Motor CCW-	N
Tach CCW-	O
Motor CCW+	P

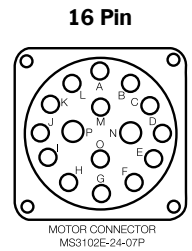

NOTE: 22 AWG are encoder signals, larger AWG are for motor/tach/brake.

Encoder Feedback for	Number of Connector Pins	Mating Connector Order No.	Cable assembly Order No.	Length	
				Meters	Feet
MTE, ME, MEB, MTEB - 4500①	14	MSCN	CBL030SF-BN	3.0	10
	14		CBL061SF-BN	6.1	20
	14		CBL091SF-BN	9.1	30

Note: ① The MTE-4500 Series with encoder feedback requires two cables; one for power and one for feedback.

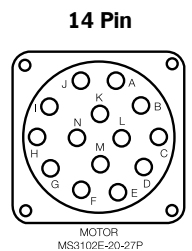
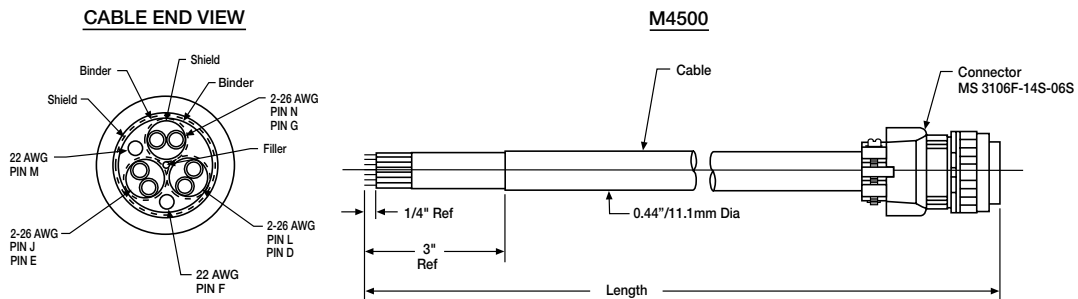

Function	Pin
Channel Z	D
Channel B	E
Common	F
Channel A	G
Channel B/	J
Channel Z/	L
+5 VDC	M
Channel A/	N

DC Servo Controls

In 1952, Baldor began supplying the industry with reliable adjustable speed controls. A benchmark was attained in 1983 when Baldor began shipping servo controls - and since then, thousands and thousands of Baldor servo controls have been shipped worldwide for many diverse applications.

Baldor products help increase productivity, improve quality, work hard - and provide solutions for your application needs.

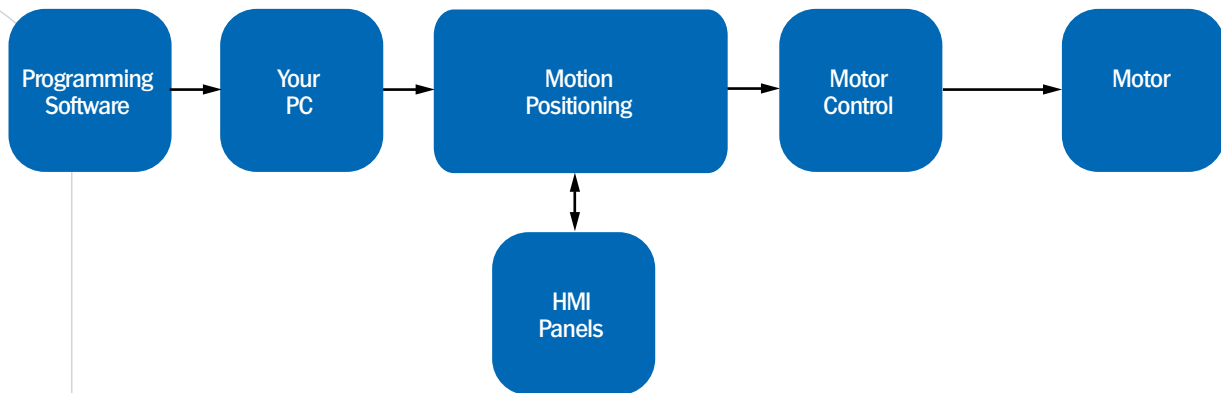

TSD Series

Baldor's TSD is a totally enclosed PWM drive for control of one or two DC servo motors. Panel mount enclosure, completely stand-alone unit plugs into 115 or 220 Vac. Accepts industry standard ± 10 VDC input command for operation in either velocity or current mode. Provides up to 5 amps continuous, 10 amps peak per axis. Fully protected unit. Easily interfaces to existing motion controllers.

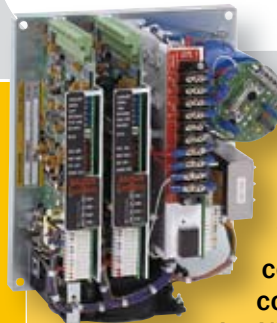

LD Series

The LD series servo control is an open chassis configuration similar to the UM, however operates direct from 115 VAC. The LD contains one or two servo control cards mounted onto a chassis, provide 15 amps continuous, 30 amps peak per axis. Protection for over/under voltage, over temperature, short circuit, etc.

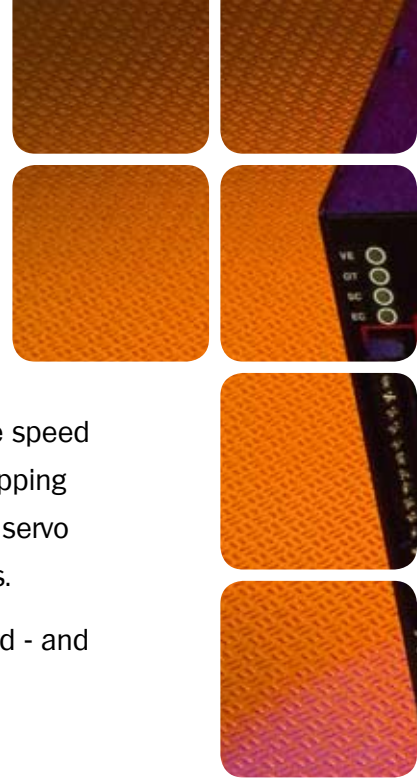



UM Series

The UM control is an open chassis configuration designed to operate a wide range of Baldor's DC servo motors. The UM series typically contains up to 4 servo control cards mounted onto a multi-axes chassis containing a power supply. Accepts industry standard ± 10 VDC input command for operation in either velocity or current mode. Models provide up to 6/15 amps continuous, with 15/30 amps peak. Easily interfaces to motion controllers. Protection for over/under voltage, over temperature, short circuit, etc.

DC Servo Control

TSD - Twin Servo Drive

- › One or two axes
- › 5 amps continuous
- › 50V and 100V bus
- › 500 Watts per axis
- › Direct 115/220 volt operation, 50/60 Hz
- › Standard ± 10 VDC command input signal
- › Velocity/torque mode operation
- › Fold back current or current latch function



The Baldor TSD (Twin Servo Drive) is a totally enclosed, stand-alone one or two axes brush-type PWM servo control.

This DC Servo Control is fully protected. It contains a front panel on/off switch and operates directly from 115 or 230 VAC. The TSD will power DC servo motors providing up to 5 amps continuous, 10 amps peak. It is a perfect match with Baldor M2200 and M3300 motors.

› Ordering Information

Control No. of Motors	Input Voltage		115 VAC 1Ø		220/240 VAC 1Ø	
	Bus Voltage		50 VDC	100 VDC	50 VDC	100 VDC
	Output Current Amps		Order Number	Order Number	Order Number	Order Number
	Continuous	Peak				
One	5	10	TSD-050-05-1-U	TSD-100-05-1-U	TSD-050-05-1-I	TSD-100-05-1-I
Two	5	10	TSD-050-05-2-U	TSD-100-05-2-U	TSD-050-05-2-I	TSD-100-05-2-I

See owners manual MN1201

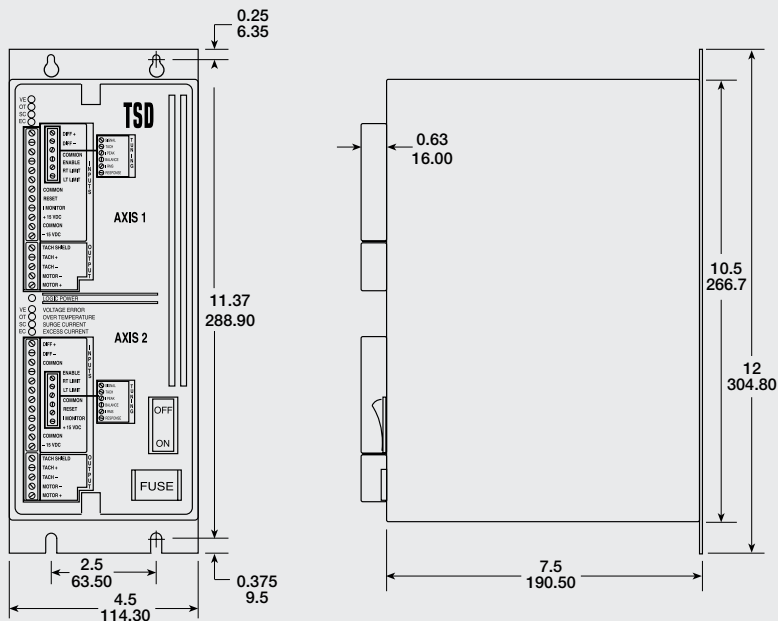

Technical Data

Description	Unit	TSD-050-05-1-U or I	TSD-050-05-2-U or I	TSD-100-05-1-U or I	TSD-100-05-2-U or I
Rated Bus Voltage (nominal)	VDC	50	50	100	100
Continuous Current	A	5	5	5	5
Peak Current	A	10	10	10	10
Maximum Time	sec	2	2	2	2
Peak Current Adjustment	A	0-10	0-10	0-10	0-10
Switching Frequency	kHz	20	20	20	20
Form Factor		1.01	1.01	1.01	1.01
Minimum inductance	mhy	1.0	1.0	1.5	1.5
Frequency Response	kHz	2.5	2.5	2.5	2.5
Positive Logic 15 VDC	mA	20	20	20	20
Negative Logic 15 VDC	mA	20	20	20	20
Minimum Motor Inductance	mhy	1.5	1.5	1.5	1.5
Differential Input	±VDC	5 to 15	5 to 15	5 to 15	5 to 15
Impedance	k Ω	20	20	20	20
Operating Temp	°C	0-50	0-50	0-50	0.50
Drift	μV/°C	10	10	10	10
Weight	lbs.	14	19	15	21

Power Specifications	Version U - 1 φ	Version I - 1 φ
AC Input Power (VAC)	115/60 Hz	240/50 Hz
Input Range (VAC)	105-125	216-264

DC Servo Control

LD - Line Drive Series

- › One or two axis
- › 15 amps continuous (30 amp peak)
- › 115 VAC direct operation
- › Chassis configuration
- › Standard ± 10 VDC command input signal
- › Velocity/torque mode operation
- › Fold back current or current latch function

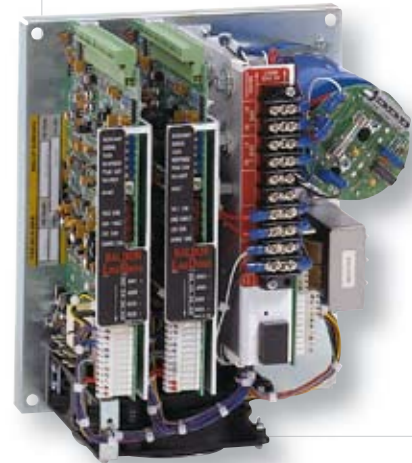

The Baldor LD high frequency PWM DC servo control plugs directly into 115 VAC and will operate a wide range of Baldor DC servo motors. The LD series typically contains one to two servo control cards mounted onto a multi-axes chassis, which includes the power supply.

› Ordering Information

Control No. of Motors	Input Voltage		115 VAC 1Ø
	Bus Voltage		160
	Output Current Amps		Order Number
	Continuous	Peak	
One	15	30	LD2-01S
Two	15	30	LD2-02S

See owners manual MN1269

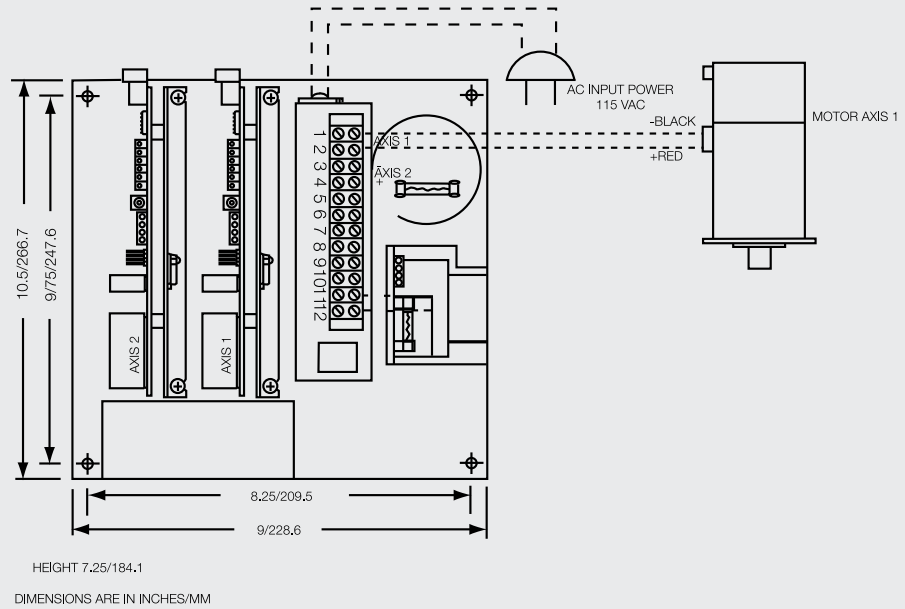

Technical Data

Description	Unit	Specifications
Rated Bus Voltage	VDC	160
Rated Continuous Current	A	27
Positive Logic 15 VDC	A	1.0
Negative Logic 15 VDC	A	1.0
Nominal Bus Input (50/60 Hz)	VAC	115
Bus Input Range (50/60 Hz)	VAC	105-125
Number of Phases		1
Nominal input for fan and logic supply (VAC 50/60 Hz)		Prewired
Continuous Rating	watts	250
Peak Rating	watts	4000
Clamp Rating	V	195
Shutdown Point Typical	V	220
Operating Temp.	°C	0-50
Weight	lbs.	14

Description	Unit	Specifications
Rated Bus Voltage	VDC	160
Rated Continuous Current	A	15
Peak Current Adjust (maximum time 1.5 seconds)	A	30
Switching Frequency	kHz	20
Form Factor		1.01
Minimum Inductance	mHz	2.0
Frequency Response	kHz	2.5
Signal Input	±VDC	10
Drift	µV/°C	10
Overall Gain	A/V	0-6000
Impedance	K Ω	20
Logic +15 VDC	mA	180
-15 VDC	mA	55
Bus Range	VDC	148-176
Operating Temp.	°C	0-50
Weight	lbs.	1.4

DC Servo Control

UM - Series

- › 6 and 15 amps continuous
- › 100 and 150 volt bus
- › 600 watts through 2.25 kW continuous
- › Multi-axes
- › Chassis mount
- › Standard ± 10 VDC command input signal
- › Velocity/torque mode operation
- › Fold back current or current latch function

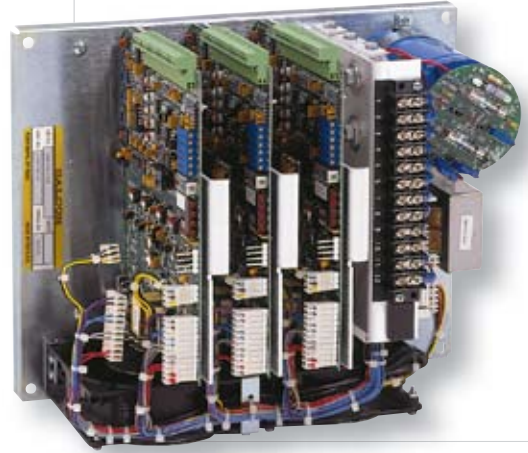

The Baldor UM series high frequency type DC servo control provides performance with attention to economy. The UM series servo control typically contains up to 4 servo control cards mounted on a multi-axes chassis. The servo card controls power to the motor. The chassis includes the power supply, over voltage protector and associated hardware.

› Ordering Information

Control No. of Motors	Input Voltage		70 VAC ①	105 VAC ①
	Bus Voltage		100 VDC	150 VDC
	Output Current Amps		Order Number	Order Number
	Continuous	Peak		
One	6	15	UM2-100-1-10S	-
	15	30	UM2-100-1-01S	UM2-150-1-01S
Two	6	15	UM2-100-1-20S	-
	15	30	UM2-100-1-02S	UM2-150-1-02S
Three	6	15	UM4-100-2-30S	-
	15	30	UM4-100-2-03S	UM4-150-1-03S
Four	6	15	UM4-100-2-40S	-
	15	30	UM4-100-2-04S	UM4-150-1-04S

NOTE: ① An isolation transformer is required to provide these voltages.

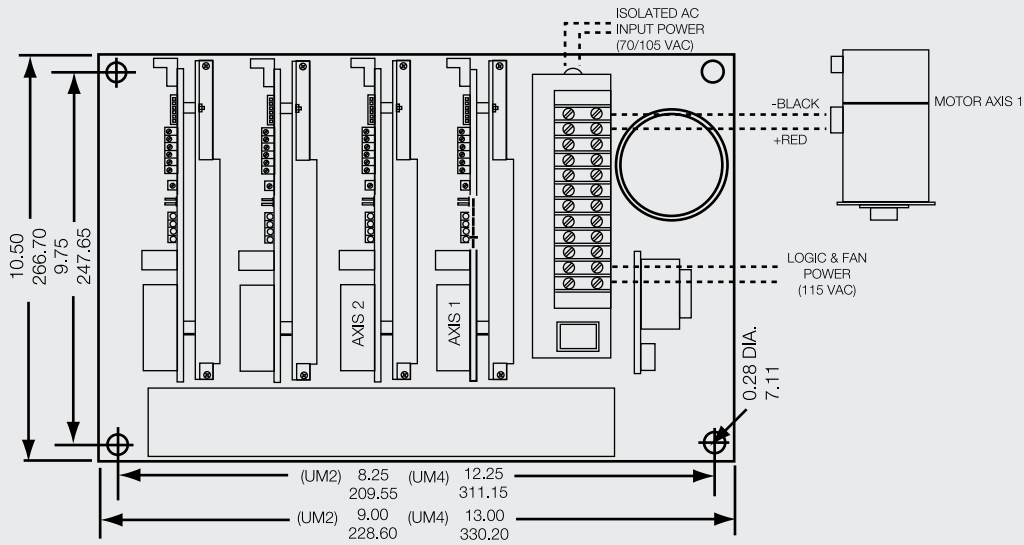

Technical Data Power Supply

Description	Unit	UM2		UM4	
		-100	-150	-100	-150
Rated Bus Input Nominal	VAC	70	150	70	105
Rated Bus Input Range	VAC	20-77	20-115	20-77	20-115
Number of Phases		1	1	1 or 3	1 or 3
Logic & Fan Power	VAC	105-125	105-125	105-125	105-125
Nominal Output Voltage	VDC	100	150	100	150
Voltage Output Range	VDC	28-109	28-162	28-109	28-162
Max. Cont. Current	A	27	27	27/50	27/50
Maximum Power	kW	1.89	2.86	1.89/4.3	2.86/6.45
Rated Bus Volt.	VDC	100	150	100	150
+15 VDC	A	1	1	1	1
-15 VDC	A	1	1	1	1
Continuous Rating	watts	250	250	500	500
Peak Rating (W)	watts	2200	4000	4400	8000
Clamp Rating	VDC	118	185	118	185
Shut Down Point typical	VDC	130	200	130	200
Operating Temp.	°C	0-50	0-50	0-50	0-50
Weight	lbs.	14	14	20.6	20.6

› Technical Data Servo Control Card

Description	Unit	6 amp card	15 amp card	15 amp card
Rated Bus Output	VDC	100	100	150
Continuous Current	A	6	15	15
Peak Current (max time 1.5 sec)	A	15	30	30
Max. time	sec.	1.5	1.5	1.5
Switching Freq. (kHz)	kHz	20	20	20
Form Factor		1.01	1.01	1.01
Min. Inductance	mHz	1.0	1.0	2.0
Freq. Response	kHz	2.5	2.5	2.5
Drift	$\mu\text{V}/^\circ\text{C}$	10	10	10
Overall Gain	A/V	0-6000	0-6000	0-6000
Input Impedance	k Ω	20	20	20
Bus nominal	VDC	100	100	150
Bus range (VDC)	VDC	28-109	28-109	28-162
-15 VDC	mA	50	50	50
+15 VDC	mA	250	250	250
Operating Temp.	$^\circ\text{C}$	0-50	0-50	0-50
Weight	lbs.	1.4	1.4	1.4

Matched Performance

TSD Series

Torque				Speed ①	Motor Inertia		Current Cont. at Stall	Motor Size	Servo Control
Cont. Stall		Peak Stall			RPM	lb-in-s ²			
lb-in	Nm	lb-in	Nm						Amp
1.9	0.21	10.1	1.14	3500	0.0003	0.35	2.1	MT-2240-ACYAN	TSD-050-05-2-U
1.9	0.21	6.3	0.71	5000	0.0003	0.35	3.4	MT-2240-BCYAN	TSD-050-05-2-U
3.1	0.35	10.1	1.14	3500	0.0005	0.54	3.4	MT-2250-ACYAN	TSD-050-05-2-U
2.8	0.35	6.3	0.71	5000	0.0005	0.54	5.0	MT-2250-BCYAN	TSD-050-05-2-U
6.3	0.71	25.3	2.86	2800	0.0016	1.84	2.8	MT-3353-BLYAN	TSD-100-05-2-U
6.3	0.71	13.5	1.53	5000	0.0016	1.84	5.1	MT-3353-DLYAN	TSD-100-05-2-U
8.8	0.99	25.3	2.86	2800	0.0024	2.75	3.8	MT-3358-BLYAN	TSD-100-05-2-U
7.3	0.99	16.1	1.82	5000	0.0024	2.75	5.0	MT-3358-CLYAN	TSD-100-05-2-U
11.3	1.27	25.3	2.86	2800	0.0033	3.67	4.9	MT-3363-BLYAN	TSD-100-05-2-U
9.0	1.12	19.8	2.24	4200	0.0033	3.67	5.0	MT-3363-CLYAN	TSD-100-05-2-U

NOTE: Cables: For MT-2200 and MT-3300 Series use CBL061SP-AF (6.1 meters, 20 feet, 6 pin MS connector).

① Approximate speed under nominal conditions.

UM Series

Torque				Speed ①	Motor Inertia		Current Cont. at Stall	Motor Size	Servo Control
Cont. Stall		Peak Stall			RPM	lb-in-s ²			
lb-in	Nm	lb-in	Nm						Amp
12.5	1.41	38	4.29	3000	0.007	7.91	5.5	MT-4050-ALYBE	UM2-100-1-20S
12.5	1.41	45	5.08	4500	0.007	7.91	7.9	MT-4050-BLYBE	UM2-100-1-02S
21.5	2.43	72	8.13	1500	0.011	12.43	5	MT-4060-ALYBE	UM2-100-1-20S
21.5	2.43	72	8.13	2300	0.011	12.43	7	MT-4060-BLYBE	UM2-100-1-02S
28	3.16	125	14.12	1500	0.014	15.82	6.2	MT-4070-ALYBE	UM2-100-1-02S
28	3.16	101.1	11.42	2300	0.014	15.82	9.2	MT-4070-BLYBE	UM2-100-1-02S
40	4.52	151.8	17.15	1500	0.024	27.12	9	MT-4090-ALYBE	UM2-100-1-02S
40	4.52	101.1	11.42	2300	0.024	27.12	13	MT-4090-BLYBE	UM2-100-1-02S
30	3.39	130	14.69	2200	0.014	15.82	6.1	MT-4525-BTYCN	UM2-150-1-02S
30	3.39	108.9	12.30	3200	0.014	15.82	9.2	MT-4525-CTYCN	UM2-150-1-02S
30	3.39	83.4	9.42	4200	0.014	15.82	12	MT-4525-DTYCN	UM2-150-1-02S
40	4.52	159.3	18.00	2200	0.021	23.73	8.3	MT-4535-BTYCN	UM2-150-1-02S
40	4.52	119.1	13.46	3000	0.021	23.73	11.2	MT-4535-CTYCN	UM2-150-1-02S
37	4.52	81	9.15	4200	0.021	23.73	15	MT-4535-DTYCN	UM2-150-1-02S
50	5.65	207.6	23.46	1700	0.028	31.64	8	MT-4545-ATYCN	UM2-150-1-02S
50	5.65	156.9	17.73	2200	0.028	31.64	10.6	MT-4545-BTYCN	UM2-150-1-02S
50	5.65	106.2	12.00	3200	0.028	31.64	15.7	MT-4545-CTYCN	UM2-150-1-02S
56	6.55	228	25.76	1500	0.035	39.55	8.5	MT-4555-ATYCN	UM2-150-1-02S
56	6.55	159	17.96	2400	0.035	39.55	12.1	MT-4555-BTYCN	UM2-150-1-02S

NOTE: Cables: For MT-4050 and MT-4060 Series use CBL061SP-AF (6.1 meters, 20 feet, 6 pin MS connector). For MT-4070, MT-4090 and MT-4500 Series use CBL061SP-BI (6.1 meters, 20 feet, 9 pin MS connector).

① Approximate speed under nominal conditions.

LD Series

Torque				Speed ①	Motor Inertia		Current Cont. at Stall	Motor Size	Servo Control
Cont. Stall		Peak Stall			RPM	lb-in-s ²			
lb-in	Nm	lb-in	Nm						Amp
30	3.39	130	14.69	2200	0.014	15.82	6.1	MT-4525-BTYCN	LD2-01S
30	3.39	108.9	12.30	3200	0.014	15.82	9.2	MT-4525-CTYCN	LD2-01S
30	3.39	83.4	9.42	4200	0.014	15.82	12	MT-4525-DTYCN	LD2-01S
40	4.52	159.3	18.00	2200	0.021	23.73	8.3	MT-4535-BTYCN	LD2-01S
40	4.52	119.1	13.46	3000	0.021	23.73	11.2	MT-4535-CTYCN	LD2-01S
37	4.52	81	9.15	4200	0.021	23.73	15	MT-4535-DTYCN	LD2-01S
50	5.65	207.6	23.46	1700	0.028	31.64	8	MT-4545-ATYCN	LD2-01S
50	5.65	156.9	17.73	2200	0.028	31.64	10.6	MT-4545-BTYCN	LD2-01S
50	5.65	106.2	12.00	3200	0.028	31.64	15.7	MT-4545-CTYCN	LD2-01S
56	6.55	228	25.76	1500	0.035	39.55	8.5	MT-4555-ATYCN	LD2-01S
56	6.55	159	17.96	2400	0.035	39.55	12.1	MT-4555-BTYCN	LD2-01S

NOTE: Cables: For MT-4500 series use CBL061SP-BI (6.1 meters, 20 feet, 9 pin MS connector).

① Approximate speed under nominal conditions.

Conversion Tables

Rotary Inertia (To convert from A to B, multiply by value in table)

A \ B	gm-cm ²	oz-in ²	gm-cm-s ²	kg-cm ²	lb-in ²	oz-in-s ²	lb-ft ²	kg-cm-s ²	lb-in-s ²	lb-ft-s ² or slug-ft ²
gm-cm ²	1	5.46 x 10 ³	1.01 x 10 ³	10 ³	3.417 x 10 ⁴	1.41 x 10 ⁵	2.37 x 10 ⁶	1.01 x 10 ⁶	8.85 x 10 ⁷	7.37 x 10 ⁸
oz-in ²	182.9	1	0.186	0.182	0.0625	2.59 x 10 ³	4.34 x 10 ⁴	1.86 x 10 ⁴	1.61 x 10 ⁴	1.34 x 10 ⁵
gm-cm-s ²	980.6	5.36	1	0.9806	0.335	1.38 x 10 ²	2.32 x 10 ³	10 ³	8.67 x 10 ⁴	7.23 x 10 ⁵
kg-cm ²	1000	5.46	1.019	1	0.3417	1.41 x 10 ²	2.37 x 10 ³	1.019 x 10 ³	8.85 x 10 ⁴	7.37 x 10 ⁵
lb-in ²	2.92 x 10 ³	16	2.984	2.926	1	4.14 x 10 ²	6.94 x 10 ³	2.98 x 10 ³	2.59 x 10 ³	2.15 x 10 ⁴
oz-in-s ²	7.06 x 10 ¹	386.08	72	700.615	24.13	1	0.1675	7.20 x 10 ²	6.25 x 10 ²	5.20 x 10 ³
lb-in-s ²	4.21 x 10 ²	2304	429.71	421.40	144	5.967	1	0.4297	0.3729	3.10 x 10 ²
kg-cm-s ²	9.8 x 10 ⁵	5.36 x 10 ³	1000	980.66	335.1	13.887	2.327	1	0.8679	7.23 x 10 ²
lb-ft-s ²	1.129 x 10 ⁶	6.177 x 10 ³	1.152 x 10 ³	1.129 x 10 ³	386.08	16	2.681	1.152	1	8.33 x 10 ²
lb-ft-s ² or slug-ft ²	1.355 x 10 ⁷	7.41 x 10 ⁴	1.38 x 10 ⁴	1.35 x 10 ⁴	4.63 x 10 ³	192	32.17	13.825	12	1

Torque (To convert from A to B, multiply by value in table)

A \ B	dyne-cm	gm-cm	oz-in	kg-cm	lb-in	Newton-m	lb-ft	kg-cm
dyne-cm	1	1.019 x 10 ³	1.416 x 10 ⁵	1.0197 x 10 ⁶	8.850 x 10 ⁷	10 ⁷	7.375 x 10 ⁸	1.019 x 10 ⁸
gm-cm	980.65	1	1.388 x 10 ²	103	8.679 x 10 ⁴	9.806 x 10 ⁵	7.233 x 10 ⁵	105
oz-in	7.061 x 10 ⁴	72.007	1	7.200 x 10 ²	6.25 x 10 ²	7.061 x 10 ³	5.208 x 10 ³	7.200 x 10 ⁴
kg-cm	9.806 x 10 ⁵	1000	13.877	1	0.8679	9.806 x 10 ²	7.233 x 10 ²	102
lb-in	1.129 x 10 ⁶	1.152 x 10 ³	16	1.152	1	0.112	8.333 x 10 ²	1.152 x 10 ²
Newton-m	10 ⁷	1.019 x 10 ⁴	141.612	10.197	8.850	1	0.737	0.101
lb-ft	1.355 x 10 ⁷	1.382 x 10 ⁴	192	13.825	12	1.355	1	0.138
kg-m	9.806 x 10 ⁷	10 ⁵	1.388 x 10 ³	100	86.796	9.806	7.233	1

Material Densities

	Oz/in ²	lb/in ³	gm/cm ³
Aluminum	1.57	0.098	2.72
Brass	4.96	0.31	8.6
Bronze	4.72	0.295	8.17
Copper	5.15	0.322	8.91
Plastic	0.64	0.04	1.11
Steel	4.48	0.28	7.75

Mechanism Efficiencies

Acme Screw (Bronze Nut)	0.4
Acme Screw (Plastic Nut)	0.5
Ball Screw	0.9
Helical Gear	0.7
Spur Gear	0.6
Timing Belt/Pulley	0.9

Friction Coefficients

(Sliding)	μ
Steel on Steel	0.58
Steel on Steel (Greased)	0.15
Aluminum on Steel	0.45
Copper on Steel	0.36
Brass on Steel	0.40
Plastic on Steel	0.20
Linear Bearings	0.001

Temperature

$$^{\circ}\text{F} = (1.8 \times ^{\circ}\text{C}) + 32$$

$$^{\circ}\text{C} = .555 (^{\circ}\text{F} - 32)$$

Gravity

(Acceleration Constant)

$$g = 386 \text{ in/s}^2 = 32.2 \text{ ft/s}^2 = 9.8 \text{ m/s}^2$$

Conversion Tables

Length (To convert from A to B, multiply by value in table)

A \ B	Inch	Feet	Micro Inch	Micron	Millimeter	Centimeter	Meter
Inch	1	8.33×10^2	1.0×10^6	2.51×10^4	25.4	2.54	2.54×10^2
Feet	12	1	1.2×10^7	3.05×10^5	305	30.5	0.305
Micro-Inch	1.0×10^5	1.2×10^4	1	2.54×10^2	2.54×10^5	2.54×10^6	2.54×10^8
Micron	3.937×10^5	3.28×10^6	39.37	1	0.001	1.0×10^4	1.0×10^6
Millimeter	3.937×10^2	3.28×10^3	3.937×10^4	1000	1	0.1	0.001
Centimeter	0.3937	3.28×10^2	3.937×10^5	1×10^4	10	1	0.01
Meter	39.37	3.28	3.937×10^7	1×10^6	1000	100	1

Power (To convert from A to B, multiply by value in table)

A \ B	Watts	Kilowatts	ft-lb/sec	in-lb/sec	Hp (Imperial)	Hp (SI)
Watts	1	1×10^3	0.74	8.85	1.34×10^3	1.33×10^3
Kilowatts	1000	1	738	8850	1.34	1.33
ft-lb/sec	1.35	1.36×10^3	1	12	1.82×10^3	1.81×10^3
in-lb/sec	0.113	1.13×10^4	8.3×10^2	1	1.52×10^4	1.53×10^4
Hp (Imperial)	746	0.746	550	6600	1	0.995
Hp (SI)	750	0.750	553	6636	1.005	1

Mass (To convert from A to B, multiply by value in table)

A \ B	oz-m	lb-m	slug	gm	kg
oz-m	1	6.25×10^3	1.94×10^3	28.35	2.835×10^2
lb-m	16	1	3.11×10^2	453.6	0.453
slug	514.72	32.2	1	14590	14.59
gm	3.53×10^2	2.205×10^3	6.85×10^5	1	0.001
kg	35.274	2.205	6.85×10^2	1000	1

Force (To convert from A to B, multiply by value in table)

A \ B	Watts	Kilowatts	ft-lb/sec	in-lb/sec	Hp (Imperial)	Hp (SI)
oz-f	1	6.25×10^2	0.278	2.78×10^4	28.35	2.835×10^2
lb-f	16	1	4.448	4.448×10^5	453.6	0.4535
Newtons	3.596	0.225	1	1×10^5	101.9	0.1019
dyne	3.59×10^5	2.248×10^6	1.0×10^5	1	1.02×10^3	1.02×10^6
gm-f	3.53×10^2	2.205×10^3	9.81×10^3	981	1	0.001
kg-f	35.3	2.205	9.81	9.81×10^5	1000	1

Linear Velocity (To convert from A to B, multiply by value in table)

A \ B	in/sec	feet/sec	mm/sec	cm/sec	meter/sec	inch/min	feet/min	meter/min	km/hour	miles/hour
in/sec	1	0.083	25.4	2.54	2.54×10^2	60	5	1.524	0.091	6.7×10^2
feet/sec	12	1	304.8	30.48	0.3048	720	60	18.29	1.09	0.682
mm/sec	3.937×10^2	3.3×10^3	1	0.1	0.001	2.36	0.197	0.059	3.6×10^3	2.24×10^3
cm/sec	0.3937	3.28×10^2	10	1	0.01	23.62	1.97	0.59	3.6×10^2	2.24×10^2
meter/sec	39.37	3.281	1000	100	1	2362.2	197	60	3.6	2.24
inch/min	0.0167	1.39×10^3	0.42	0.042	4.2×10^4	1	8.33×10^2	2.54×10^2	1.52×10^3	9.5×10^4
feet/min	0.2	0.0167	5.08	0.508	5.08×10^3	12	1	0.3048	1.8×10^2	1.14×10^2
meter/min	0.656	5.46×10^2	16.667	1.67	1.67×10^2	39.4	3.28	1	5.9×10^2	0.37
km/hour	10.936	0.911	277.8	27.78	0.2778	656	54.67	16.67	1	0.62
miles/hour	17.59	1.47	447	44.7	0.447	1056	88	26.8	1.609	1

Servo Drive Solutions

Whether you are looking for a simple servo drive or a fully programmable drive, Baldor has the answer. Baldor servo drives have been at the heart of automation for over 20 years and have been used in thousands of applications across the world. Our latest drives build on the reputation of quality and ease of use and are ideally matched to Baldor's range of NextMove motion controllers, rotary servo motors and linear servo motors. Commissioning and setup use the same acclaimed Mint® WorkBench Windows based tool as the NextMove controllers, reducing the learning curve and improving productivity.



VS1SD Servo Drive

Refer to catalog BR1202-D for full information.

Baldor's new series incorporates an easy to use keypad for setup, auto-tuning and operation. The keypad's graphical alphanumeric display provides full parameter names to simplify setup and operation, 14 keys provide tactile feel. Includes auto-tuning. Optional field installable expansion boards extend capability to suit application needs. Models include internal power supply and are available in three phase ratings from 180-264 VAC (3 to 130A) and three phase 340-528 VAC (3 to 124A). Vector, encoderless vector and inverter drives are also available.



FlexDrive-II, Flex+Drive®-II and MintDrive®-II

Refer to catalog BR1202-D for full information.

Baldor's Series-II servo drives offer high performance control of both rotary and linear brushless servo motors. This fully featured drive family offers different feedback options (resolver, incremental and absolute multi-turn encoders) and fieldbusses (CANopen, DeviceNet and Profibus-DP). Models are available with single phase 115/230VAC (2.5 to 7.5A) or universal three phase 180-460 VAC (2.5 to 27.5A) inputs.

The FlexDrive-II is a servo drive for connection to a motion controller or PLC accepting the industry standard $\pm 10V$ analog interface. The Flex+Drive-II is a versatile indexing drive. In addition to setting position or speeds within a simple Windows® based front end, Flex+Drive-II is programmable in a single tasking version of Baldor's motion language, Mint®. The MintDrive-II provides the ultimate solution for single axis applications. Support the acclaimed multitasking version of Mint, MintDrive-II is ideally suited for following type applications requiring CAM profiles, flying shears or positional offsets.



Motion Controllers - NextMove series

Refer to catalog BR1202-C for full information.

Baldor provides high performance controllers for coordinated motion. These controllers represent industry's most dependable, and fastest product available. The NextMove family of products will speed up your manufacturing time, minimize set-up and increase your manufacturing process.

Motor Solutions

For over 20 years, Baldor has been manufacturing and supplying high reliability servo motor solutions to worldwide applications. Baldor's servo motors are designed for industrial applications, superior durability and proven reliability. Our range of rotary motors are available as a high performance, low inertia family, or as a higher inertia family for applications needing higher inertial matching. Baldor's new stainless steel motors lead the way in solutions for harsh and washdown environments.

With the widest range of linear motors and stages on the market today, Baldor's linear motors lead the way and are ideally suited to applications requiring higher speeds or improved accuracy.



BSM Series Servo Motors

Refer to catalog BR1202-E for full information.

BSM motors are hard at work, increasing productivity, improving part quality, providing precision and reducing costs in many applications. These motors are available in two models, the BSM N-Series and the BSM C-Series. The N-Series motors provide low inertia for the highest performance. The C-Series motors have a higher inertia. All the motors are available with different feedback options including resolver, incremental, and absolute encoders. Motors are available from 0.4 Nm (4 lb.-in) through to 134 Nm (1185 lb.-in). Both motor families are available in a stainless steel configuration, offering the best protection for harsh environment. These motors are ideally suited for pharmaceutical and food applications.

Linear Motors and Stages

Refer to catalog BR1202-G for full information.

Used in thousands of applications worldwide, Baldor provides industry with the widest range of linear motors and linear stages. Linear motors provide unique speed and positioning performance advantages. The direct-coupled motion eliminates mechanical transmission devices and offer substantial improvements over applications using ball screws, timing belts, etc. The rugged mechanical design provides accurate motion and precision positioning for millions of cycles.



DSM - Integrated Stepper Motor and Drive

Refer to flyer FL1851 for full information.

Baldor's new DSM integrated stepper motor and microstepping drive provides a cost effective solution for stepper motor applications. The unique design integrates a high performance micro-stepping drive onto a stepper motor, providing a compact and reliable solution. Wiring is reduced to just pulse and direction plus power. The range is available in NEMA frames sizes 17, 23 and 34 with torque outputs from 22 to 748 N-cm (32 to 1061 oz-in)

Stainless Steel Brushless Servo Motors

Refer to catalog BR1202-E for full information.

The SSBSM all-stainless steel motors are available in standard and low inertia models to provide for ideal inertial matching in your machine. Available in 5 frame sizes, the SSBSM series provide continuous torques to 280 lb-in (32 N-m) with peaks of 3-4 times. They are rated IP67 and can withstand 1500 psi washdown conditions.



Baldor's Motion Solutions Catalogs

- BR1202-A** Motion Control Solutions
- BR1202-B** Mint® Software and Applications
- BR1202-C** NextMove Multi-Axis Motion Controllers
- BR1202-D** AC Servo Drives
- BR1202-E** AC Servo Motors
- BR1202-F** DC Servo Motors and Drives
- BR1202-G** Linear Motors and Stages
- BR1202-H** Motion Product Accessories
- BR1202-I** Real-Time Ethernet Motion Solutions

World Headquarters (U.S.A.)

Baldor Electric Company

Tel: +1 479 646-4711
Fax: +1 479 648-5792
E-mail: sales.us@baldor.com

Australia

Tel: +61 2 9674 5455
Fax: +61 2 9674 2495
E-mail: sales.au@baldor.com

China

Phone: +86-21-64473060
Fax: +86-21-64078620
E-mail: sales.cn@baldor.com

Germany

Tel: +49 89 905 08-0
Fax: +49 89 905 08-490
E-mail: sales.de@baldor.com

India

Tel: +91 20 25 45 27 17/18
Fax: +91 20 25 45 27 19
E-mail: sales.in@baldor.com

Italy

Tel: +41 91 640 9950
Fax: +41 91 630 2633
E-mail: sales.it@baldor.com

Japan

Tel: +81 45-412-4506
Fax: +81 45-412-4507
E-mail: sales.jp@baldor.com

Korea

Tel: +(82-32) 508 3252
Fax: +(82-32) 508 3253
E-mail: sales.kr@baldor.com

Mexico

Tel: +52 477 761 2030
Fax: +52 477 761 2010
E-mail: sales.mx@baldor.com

Singapore

Tel: +65 744 2572
Fax: +65 747 1708
E-mail: sales.sg@baldor.com

Switzerland

Tel: +41 52 647 4700
Fax: +41 52 659 2394
E-mail: sales.ch@baldor.com

United Kingdom

Tel: +44 1454 850000
Fax: +44 1454 859001
E-mail: sales.uk@baldor.com

For additional office locations visit

www.baldor.com

Local Distributor: