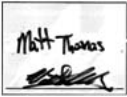
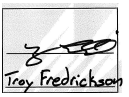
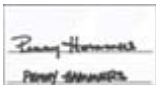

**Met One Instruments, Inc.**  
 1600 NW Washington Blvd, Grants Pass, OR  
 TEL (541) 471-7111 Fax (541) 471-7116  
 www.metone.com

TITLE  

**BAM 1022 Manual**

DWG NO <p style="text-align: center;"><b>BAM 1022-9800</b></p>	REV <p style="text-align: center;"><b>F</b></p>
---	--

Originator Approval 	Checker Approval 	Document Control Approval 
--	---	--

REVISIONS			
REV.	DESCRIPTION	DATE	BY
<b>A</b>	Initial production release.	2014-12-10	TAF
<b>B</b>	Production release. 1. Changed Accessory Kit part number from 52055 to 82055. 2. Added Inlet Tube Heater Insulation Sleeve part number 9123-2. 3. Added statement to section 1.4.2 instructing users to anchor the monitor.	2014-12-15	JJE
<b>C</b>	Production release. 1. Updated the pictures to represent the current product on pages 30, 31, 36, 37 and 43. 2. Section 3.5.9: Analog output 1 is the real-time concentration and output 2 is hourly concentration. 3. Section 6.8: The filter tape must be loaded and the foil inserted ABOVE the tape for this test. Screen shots updated.	2015-07-14	JJE
<b>D</b>	Production release. 1. Added K-Factor setup screen and information section 3.5.4.	2015-12-01	MST
<b>E</b>	Production release. ECO 3243 <ul style="list-style-type: none"> <li>• Replaced part number 460130 with 460180 in section 2.2.</li> <li>• Replaced part number 460130 with 460180 in section 9.1 under the Consumables heading.</li> <li>• Replaced part number 460130 with 460180 in section 9.1 under the 82055 Accessory Kit parts listing.</li> <li>• Added a more detailed explanation of Short Term Averaging in section 5.2</li> <li>• Updated section 3.5.11 to specify the interval is for values other than concentration</li> <li>• Updated section 3.5.2 to direct readers to section 5.2 for more info.</li> <li>• Changed footer to alternate page number position on odd/even pages.</li> </ul>	2017-01-28	TAF

	<ul style="list-style-type: none"> <li>• Corrected Data Resolution and Lower Detection Limit specs in section 1.5 Specifications Table</li> <li>• Fixed broken callout link in section 5.2</li> <li>• Added replacement 110 and 220 VAC pumps to the spare parts list</li> <li>• Added 110 and 220 VAC pump rebuild kits to the spare parts list</li> <li>• Added pump box PN's for 110 and 220V to replacement parts list</li> <li>• Added heater PN's for 110 and 220V to replacement parts list</li> <li>• Added heater insulating sleeve PN to replacement parts list</li> <li>• Added lithium coin cell battery to replacement parts list</li> <li>• Added 597 cable to the replacement parts list</li> <li>• Updated photo of 597 sensor in replacement parts list</li> <li>• Updated section 2.4 to include 220 VAC</li> <li>• Converted acronym list to Appendix A instead of Section 10 and added Appendix B for configuring the IP address</li> <li>• Corrected multiple typos and formatting errors.</li> <li>• Clarified sections 3.2 and 3.4.6 address <i>filter</i> RH</li> <li>• Updated section 3.5.2 to include statement about setting Data Average period to correctly log Real Time data.</li> <li>• Added statement to leave the PM<sub>2.5</sub> size selector installed during leak check so it is included in the leak test.</li> <li>• Updated advanced leak check procedures to include instructions to remove filter tape for test and install it again at the end.</li> <li>• Added statement to clarify the difference between performing an audit and a calibration in section 0</li> <li>• Clarified passing criteria for background test as less than <i>or equal to</i> 2.4ug</li> <li>• Changed "Minimum Suggested Interval" to just "Suggested Interval" for sections 6.6 and 6.7.</li> <li>• Updated section 6.10 to remove several references to E-BAM Plus errors that were not relevant to the BAM 1022.</li> <li>• Updated photos and text in section 2.3 for new fastening knob to secure upper housing to the pump box.</li> <li>• Updated current loads. Table entries are 20% higher than lab measurements.</li> <li>• Updated section 1.6 to remove text and cite designation number only. Also updated link to current web page.</li> </ul>		
<p><b>F</b></p>	<p>ECO 3403</p> <ul style="list-style-type: none"> <li>• Updated manual to reflect firmware changes R1.0.8</li> <li>• Updated Ethernet section</li> <li>• Added note in section 6.11 about multiple alarms being summed</li> <li>• Revised section 3.5.5 to better explain heater operation.</li> <li>• Revised sections 6.2 and 6.3 for new leak check procedure</li> <li>• Changed "inverse" to "negative" in step 10 of section 6.5 to indicate the correct mathematical operation.</li> <li>• Corrected AT Operating Range from -30 to +60 to -30 to +50 Deg C in specifications table.</li> <li>• Updated replacement heater part numbers to 80559 (120 VAC) and 80559-1 (220 VAC) in section 9.1</li> </ul>	<p>2019-03-02</p>	<p>TAF MST</p>



# **BAM 1022 PARTICULATE MONITOR OPERATION MANUAL**

**BAM 1022-9800 REV F**



**Met One Instruments, Inc.**

1600 NW Washington Blvd.

Grants Pass, OR 97526

Telephone: (541) 471-7111

Facsimile: (541) 471-7116

[www.metone.com](http://www.metone.com)

**BAM 1022 Particulate Monitor Operation Manual** - © Copyright 2012 Met One Instruments, Inc. All Rights Reserved worldwide. No part of this publication may be reproduced, transmitted, transcribed, stored in a retrieval system, or translated into any other language in any form without the written permission of Met One Instruments, Inc.

## Table of Contents

<b>1</b>	<b>INTRODUCTION .....</b>	<b>5</b>
1.1	About This Manual.....	5
1.2	Technical Service .....	6
1.3	BAM: Beta Attenuation Monitor .....	7
1.4	Safety Statements .....	8
1.4.1	Beta Radiation .....	8
1.4.2	Other Safety Items.....	8
1.5	BAM 1022 Specifications.....	9
1.6	U.S. EPA Federal Equivalency Method Notifications.....	10
<b>2</b>	<b>INSTALLATION &amp; COMMISSIONING .....</b>	<b>11</b>
2.1	Unpacking.....	11
2.2	Accessories .....	12
2.3	BAM 1022 Installation for FEM Monitoring Applications .....	12
2.4	BAM 1022 Power and Electrical Connections .....	17
<b>3</b>	<b>USER INTERFACE .....</b>	<b>18</b>
3.1	Main Operating Screen.....	18
3.2	Menu Hierarchy and Navigation .....	19
3.3	Operate Menu.....	21
3.3.1	Start Sample.....	21
3.3.2	Load Filter Tape.....	21
3.3.3	Transfer Data.....	21
3.3.4	About .....	21
3.3.5	Parameters .....	22
3.4	Test Menu.....	22
3.4.1	Leak Test.....	23
3.4.2	Ambient Temperature .....	23
3.4.3	Ambient Pressure .....	23
3.4.4	Flow Calibration .....	23
3.4.5	Run Self-Test.....	24
3.4.6	Filter Sensors .....	24
3.4.7	Span Mass Audit.....	24
3.4.8	Tape Test .....	24
3.4.9	Nozzle/Count Test .....	24
3.4.10	Analog Output Calibration.....	25
3.4.11	Analog Output Test.....	25
3.4.12	Inlet Heater .....	25
3.4.13	Relay Test .....	26
3.4.14	Input Test.....	26
3.4.15	Digital Link .....	26
3.5	Setup Menu .....	26
3.5.1	Set Clock .....	27
3.5.2	Sample .....	27

3.5.3	Calibration .....	27
3.5.4	Advanced.....	27
3.5.5	Inlet Heater .....	28
3.5.6	Clear Memory .....	28
3.5.7	Change Password .....	28
3.5.8	Reports.....	28
3.5.9	Alarms .....	29
3.5.10	Station ID.....	29
3.5.11	MET Average.....	29
3.5.12	Analog Outputs.....	30
3.5.13	Serial Port.....	30
3.5.14	Sound Volume .....	30
3.5.15	Touch Calibrate .....	30
3.6	Alarms Menu .....	31
<b>4</b>	<b>OPERATION .....</b>	<b>32</b>
4.1	Initial Procedures .....	32
4.2	Loading Filter Tape.....	32
4.3	Warm-up Period.....	34
4.4	Commissioning .....	34
<b>5</b>	<b>The BAM 1022 Measurement Cycle.....</b>	<b>35</b>
5.1	Hourly Measurement Cycle .....	35
5.2	Short Term Averaging.....	35
<b>6</b>	<b>MAINTENANCE, ALARMS &amp; TROUBLESHOOTING .....</b>	<b>36</b>
6.1	Periodic Maintenance .....	36
6.2	Basic Leak Check.....	37
6.3	Advanced Leak Checks .....	38
6.3.1	Total System Leak Test.....	38
6.3.2	Lower System Leak Test .....	39
6.3.3	Filter Tape Leak Test.....	40
6.4	Flow Audit and Calibration.....	41
6.5	Background Determination (Mass Offset).....	44
6.6	Nozzle, Vane & Pinch Roller Cleaning.....	46
6.7	Internal Nozzle Cleaning.....	47
6.8	Span Mass Audit.....	48
6.9	Filter Sensor Testing.....	50
6.9.1	Filter Temperature and Relative Humidity Sensors .....	50
6.9.2	Filter Pressure Sensors .....	51
6.10	Basic Problems & Solutions.....	52
6.11	Alarms .....	54
6.12	Hardware Failure Screen.....	55
6.13	Sensor Out of Range Event.....	55
6.14	Alarm Relay .....	56
<b>7</b>	<b>DATA COLLECTION AND COMMUNICATIONS .....</b>	<b>57</b>
7.1	Analog & Digital I/O .....	57
7.2	Clock Sync.....	58

7.3	Transfer Data to USB Flash Drive .....	58
7.4	Serial Communications .....	59
7.4.1	Terminal and Escape Commands Using the 7500 Protocol .....	59
7.5	Data Format & Example Reports .....	62
7.5.1	Settings Report .....	62
7.5.2	User Data Log Report .....	62
7.5.3	Alarm Log Report .....	64
<b>8</b>	<b>THEORY OF OPERATION .....</b>	<b>65</b>
<b>9</b>	<b>ACCESSORIES and PARTS .....</b>	<b>67</b>
9.1	Consumables, Replacement Parts, and Accessories .....	67
<b>10</b>	<b>Ethernet Port Setup and Configuration .....</b>	<b>70</b>
10.1	Setting the Static IP Address of Your Device .....	70
10.2	Setting up a Virtual COM Port .....	73
10.2.1	Installing Virtual COM Drivers .....	73
10.2.2	Virtual COM Drivers Setup .....	75
	<b>APPENDIX A: ACRONYMS AND ABBREVIATIONS .....</b>	<b>78</b>

# 1 INTRODUCTION

## 1.1 About This Manual

This document is organized with the most important information toward the front of the manual, such as site selection, installation, setups, and field calibrations, which all BAM 1022 owners and operators should read and understand. Toward the back are sections that provide in-depth information on subjects such as theory, diagnostics, accessories, and alternate settings. These sections provide valuable information that should be consulted as needed. Electronic versions of this manual are also available. Operators of the monitoring system are encouraged to study this manual to ensure correct performance, safe operation, and to prevent equipment damage.





## 1.2 *Technical Service*

This manual is structured by customer feedback to provide the required information for setup, operation, testing, maintaining, and troubleshooting your BAM 1022 mass monitor. Should you still require support after consulting your printed documentation, we encourage you to contact one of our expert Technical Service representatives during normal business hours of 7:00 a.m. to 4:00 p.m. Pacific Standard Time, Monday through Friday. In addition, technical information and service bulletins are often posted on our website. Please contact us and obtain a Return Authorization (RA) number before sending any equipment back to the factory. This allows us to track and schedule service work and to expedite customer service. Please have your instrument serial number available when contacting the manufacturer.

**Contact Information:** Tel: + 541 471 7111  
Fax: + 541 471 7116  
Web: <http://www.metone.com>  
Email: [service@metone.com](mailto:service@metone.com)

**Address:** Met One Instruments, Inc.  
1600 Washington Blvd  
Grants Pass, Oregon  
97526 U.S.A.

### 1.3 BAM: Beta Attenuation Monitor

The Met One Instruments Model BAM 1022 Continuous PM Monitoring System utilizes the principal of beta ray attenuation to accurately measure and report the concentration of airborne particulate matter (PM) in ambient air. The centerpiece of the measurement system consists of a beta source that emits a consistent supply of electrons, and a sensitive detector that counts the incident electrons.

A vacuum pump draws air through a size selective inlet, down the inlet tube, and deposits the airborne particulate on a filter tape that is located between the beta source and detector. The accumulation of mass onto the filter tape increasingly attenuates beta ray transmission through the media.

Beta attenuation through the filter tape is continuously monitored throughout the measurement cycle. The degree of beta ray attenuation is used to determine the mass of particulate matter deposited on the filter tape. During sampling, the flow rate is precisely controlled.

Having determined both mass and sample volume, the BAM 1022 calculates and reports the ambient PM concentration, expressed as  $\mu\text{g}/\text{m}^3$  or  $\text{mg}/\text{m}^3$ .

A detailed description of the measurement is provided in Section 8 of this Operating Manual.

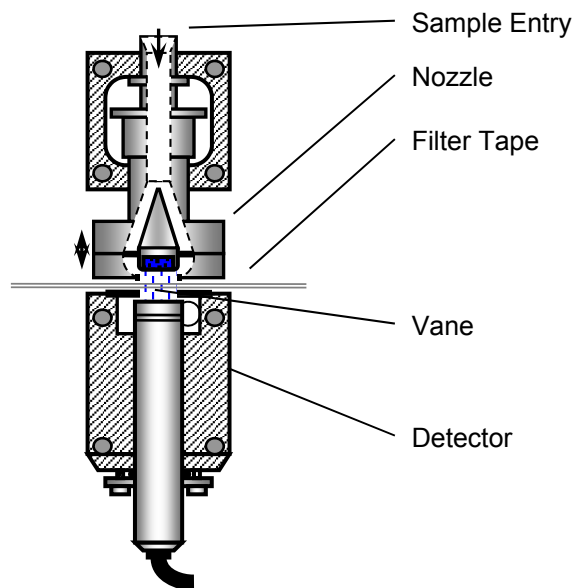

BAM 1022 Measurement System

**NOTE: For proper performance, the BAM 1022 must be operated outdoors and should not be installed inside of a building, trailer, or other shelter. It must be allowed to run at ambient conditions.** This is required for the BAM 1022 to operate as a U.S. EPA PM<sub>2.5</sub> Class III Equivalent Method monitor.

## 1.4 Safety Statements

### 1.4.1 Beta Radiation

The Met One Instruments BAM 1022 contains a small  $^{14}\text{C}$  (Carbon 14) beta radiation-emitting source. The nominal activity of the source is  $60 \mu\text{Ci} \pm 15\mu\text{Ci}$  (microcurries), which is below the "Exempt Concentration Limit" as defined in USC 10 CFR Section 30.71 – Schedule B. The owner of the BAM 1022 is not required to obtain any license in the United States to own or operate the mass monitor. The owner of a BAM 1022 may elect to return the entire mass monitor to Met One Instruments for recycling of the  $^{14}\text{C}$  source when the mass monitor has reached the end of its service life, although the owner is under no obligation to do so. Under no circumstances should anyone but factory technicians attempt to remove or access the beta source. The beta source has a half-life of about 5,730 years, and should never need to be replaced unless it becomes damaged or corroded. Neither the  $^{14}\text{C}$  source nor the beta ray detector are serviceable in the field. Should these components require repair or replacement, the BAM 1022 must be returned to the factory for service and recalibration. The BAM 1022 is manufactured in compliance with the U.S. NRC safety criteria in 10 CFR 32.27.

### 1.4.2 Other Safety Items

If the BAM 1022 is operated in a manner not specified by the manufacturer, the performance and protection provided by the equipment may be impaired.

- △ Any repairs or adjustments made to the BAM 1022 that are not outlined within this document must be carried out only by factory-trained personnel. Under no circumstances should repairs be attempted by personnel not qualified to service electronic instrumentation.
- △ Disconnect power to the BAM 1022 power before working on electrical components. Failure to do so may result in an electrical hazard and could damage the equipment.
- △ Grounding and antistatic procedures must be followed when handling any internal components. Internal circuitry of the BAM 1022 may be damaged by static electricity.
- △ Do not operate the BAM 1022 in potentially explosive environments.
- △ If safe operation of the BAM 1022 has been impaired, the instrument must be disconnected from power and secured against unintended operation.
- △ The BAM 1022 should be secured against accidental tipping. Anchoring holes are provided in the feet at the base of pump box assembly for this purpose.

For procedures not outlined within this document, consult your local Met One Instruments technical service representative or contact the manufacturer.

## 1.5 BAM 1022 Specifications

PARAMETER	SPECIFICATION
Measurement Principle	Beta Attenuation.
US EPA Designations	EPA Class III Federal Equivalency Method (EQPM-1013-209)
Measurement Range	-15 $\mu\text{g}/\text{m}^3$ – 10,000 $\mu\text{g}/\text{m}^3$
Accuracy	Meets US-EPA Requirements for Class III PM <sub>2.5</sub> FEM
Data Resolution	1.0 $\mu\text{g}/\text{m}^3$
Lower Detection Limit	< 4.8 $\mu\text{g}/\text{m}^3$ (Hourly, $2\sigma$ ) / < 1.0 $\mu\text{g}/\text{m}^3$ (24 Hour, $2\sigma$ )
Sampling Time	Continuous Air Sampling with Hourly Tape Advance
Measurement Cycles	Primary: Automatic Hourly PM Measurement (Required for PM <sub>2.5</sub> FEM Operation) Secondary: User Selectable Short Term Averages (15 to 60 minute)
Sample Flow Rate	16.7 liters/minute
Flow Accuracy	$\pm 2.0$ %
Filter Tape	Continuous glass fiber filter, 30mm x 21m roll. Up to 2 months operation per roll.
Maintenance Interval	8 Weeks (minimum)
Span Check	Manual Audits Performed with Zero and Span Foils (Included)
Beta Source	<sup>14</sup> C (carbon-14), 60 $\mu\text{Ci} \pm 15 \mu\text{Ci}$ (< 2.22 X 10 <sup>6</sup> Beq), Half-Life 5730 years.
Detector Type:	Scintillation Photomultiplier Tube.
Operating Temperature Range	-30° to +50° C
Operating Humidity Range	0 to 90% RH, non-condensing
Enclosure Requirements	Monitor housing meets all requirements for FEM sampling.
User Interface	4.3" graphical touch screen
Analog Output	Two channels; optically isolated; switch settable voltage or current 0-1, 0-2.5, 0-5 VDC, 4-20 mA
Alarm Contact Closure	1 channel; dry NO contact; 1 A at 125 VAC or 60 VDC maximum.
Serial Interfaces	1 channel; full duplex RS-232, USB, and Ethernet serial (Shared common serial output). Baud rates 1200, 2400, 4800, 9600, 19200, 38400, 57600, 115200
Compatible Software	Comet™ (included), Air Plus™, terminal programs such as HyperTerminal®
Data Logger Memory	11,827 records (1.4 years @ 1 record/hr. 8 days @ 1 record/min).
Unit Dimensions	55.9cm wide x 45.7cm deep x 139.7cm high (22"w x 18"d x 55"h)
Weight	38.6 kg (85 lbs) fully assembled
Power Supply	100 - 230 VAC; 50/60 Hz universal AC power
Power Consumption	Approximately 300 W (including BAM 1022, Inlet Heater, Pump, and Vent Fan)
Approvals	NRC, ISO-9001, ROHS, US-EPA

(Specifications may be subject to change without notice.)

## **1.6 U.S. EPA Federal Equivalency Method Notifications**

The BAM 1022 Beta Attenuation Mass Monitor is US-EPA designated for PM<sub>2.5</sub> under the following designation number:

- Designation Number: EQPM-1013-209 (PM<sub>2.5</sub> with BGI/Mesa Labs VSCC™ or Tisch Cyclone)

US-EPA designated methods using the BAM 1022 are modified from time to time in order to reflect hardware or software improvements. These modifications do not impact previously designated configurations of the BAM 1022 but may provide the end user with a product upgrade path that will allow the monitor to continue to be operated as a US-EPA designated method. For further details, please contact our service department. Details concerning USEPA designated configurations of the BAM 1022 may be found on the US-EPA website:

<https://www3.epa.gov/ttn/amtic/files/ambient/criteria/AMTIC%20List%20Dec%202016-2.pdf>

## 2 INSTALLATION & COMMISSIONING

### 2.1 Unpacking



Any damages incurred to the equipment during shipping are the responsibility of the carrier. If any damage to the shipment is noticed before unpacking, **a claim must be filed with the commercial carrier immediately**. You should follow any special unpacking instructions provided by the carrier as you then carefully remove all items from the containers and inspect each component. It is recommended to document and photograph all damaged packages and items before, during, and after unpacking them. Contact Met One Instruments (see section 1.2 of this manual) to arrange for any replacement items needed.

Unpack the mass monitor and accessories and compare them to the packing list to make sure all items are present.

The BAM 1022 is shipped with a white plastic shim pinched under the nozzle of the mass monitor which prevents the moving parts of the nozzle assembly from being damaged in transit. The shim must be replaced anytime the mass monitor is being transported in order to avoid damaging the nozzle control mechanism. Do not ship or transport the BAM 1022 with filter tape installed.

Please keep all of the special shipping items (box, foam packing material, etc.) used to ship your BAM 1022. They should be re-used if you must transport your monitor (changing site locations, returning to the factory, etc.). Met One is not responsible for damage to the mass monitor if shipped in non-original packaging, or without the shim in place. Contact Met One Instruments (see section 1.2 of this manual) for replacement packing materials if necessary.

## 2.2 Accessories

Every BAM 1022 requires the use of ancillary components. The items supplied with a standard BAM 1022 PM<sub>2.5</sub> FEM monitoring system are as follows:

Standard Components	Part No.
PM <sub>10</sub> Size Selective Inlet	BX-802
PM <sub>2.5</sub> Very Sharp Cut Cyclone	BX-808
Inlet Tube Heater	80559
Inlet Tube Heater Insulation Sleeve	9123-2
Inlet Tube (27 inches)	8112-2.25
Ambient Combination Sensor (AT, BP, RH)	597
Filter Tape	460180
Accessory Kit*	82055

\*See section 9.1 for a complete listing of all items contained in the Accessory Kit

Application and installation dependent accessories for the BAM 1022 are available from Met One Instruments.

Common Optional Component	Part No.
Volumetric Flow Calibration Kit	BX-307
Zero Filter Kit	BX-302

## 2.3 BAM 1022 Installation for FEM Monitoring Applications

The BAM 1022 is a weatherproof monitor and must be operated outside of any additional enclosures in order to maintain its US-EPA Class III designation. Its housing is designed to maintain a near constant temperature difference between ambient and measurement conditions. The required constant temperature difference will not be achieved if the BAM 1022 is installed inside of any structure where the temperature is not allowed to vary with ambient temperature.

There are no special precautions or handling concerns except for the normal level of care required for handling scientific equipment.

1. Remove the cover from the top of the pump box assembly and set it aside. Remove all packing material from inside the box and gather the loose ends of the cables and tubing.
2. Invert the cover so that the white nipple is protruding upward, feed the cables and tubing through it from the bottom, and then replace it atop the pump box assembly. It should look like the picture shown here.



- Open the front door of the main enclosure and remove the protective packing material from around the touch screen display. On the back of the enclosure, undo the four wing nuts holding the cable access cover in place and then remove the cover. Set it aside for now.
- Behind the cable access panel, locate the ingress hole on the right hand side of the bottom of the enclosure. Lift the monitor and carefully feed the cabling through this hole and continue to lower it until the white nipple extends in to the housing and the monitor is resting flat on top of the pump box assembly. Raise the side latches and secure them in place by tightening the large knob. See pictures below.



**CAUTION:** Do not lift the BAM 1022 monitor by the angled solar radiation shield mounted to the top of the enclosure. It is not designed to hold the weight of the full assembly and can easily be damaged if used to lift the monitor. Instead, firmly grasp the sides of the housing and lift. It would be easiest to have at least two people for this step.

- Route the pump cable, the pump box fan cable, and the pump tubing to the appropriate locations and plug them in to the monitor. Be sure to connect the ground lead tied to the yellow pump cable to the grounding connection on the BAM 1022 case. Note that the pump cable connection is a twist lock type. Once inserted, rotate it slightly in a clockwise direction to lock it in place. To insert the tubing, simply press it in to the fitting. See photos below.

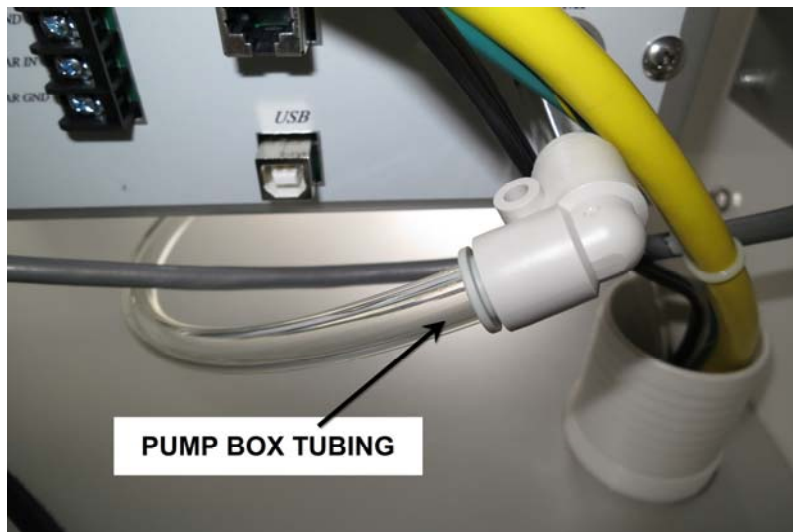
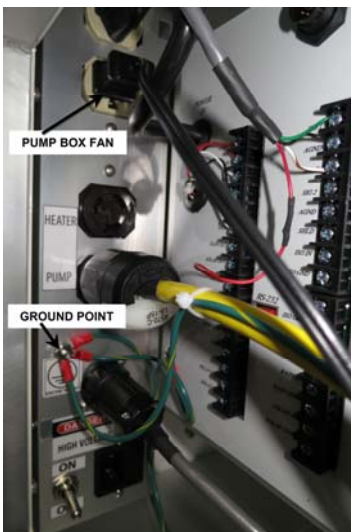



6. Wrap the lower threads of the pipe seal with Teflon tape and install it in the top of the enclosure. See picture to the right.
7. Insert the black sealing ring and loosely attach the white clamping ring (also shown in the picture at right) to the pipe seal.
8. Locate the red cap covering the inlet tube receiver inside the BAM 1022 enclosure. It is found just to the left of the touchscreen display. Remove the large red cap and a smaller red insert will be revealed beneath it. Remove this cap as well. See image below left.



9. Slide the inlet tube through the pipe seal on top of the enclosure just until you can see it inside the enclosure. Position the inlet heater beneath the inlet tube and slide the tube through the heating element until it just comes in contact with the o-rings. Raise the heater so it is near (but not touching) the top of the enclosure and fasten it in position with the supplied hex wrench. See image above center.
10. Rotate the tube so that the heater power cable is facing the back left corner of the enclosure and route the cable down the large empty hole located near that corner. Push the inlet tube down all the way and wrap the heater element in the supplied insulating material as shown in the above right image.
11. Route the inlet tube heater to the power connection labeled HEATER in the back of the BAM 1022 and plug it in. Note that this connection is a twist lock type. Once inserted, rotate it slightly in a clockwise direction to lock it in place.



12. Install the 597 probe on the inlet tube above the roof of the BAM 1022 enclosure using the U-bolt with the nuts and washers provided. Connect the silver connector of the cable to the silver connection on the bottom of the sensor. See pictures below.



13. Route the sensor cable to the back of the enclosure and attach it to the connection labeled as EXTERNAL AMBIENT SENSOR. See photo below left.

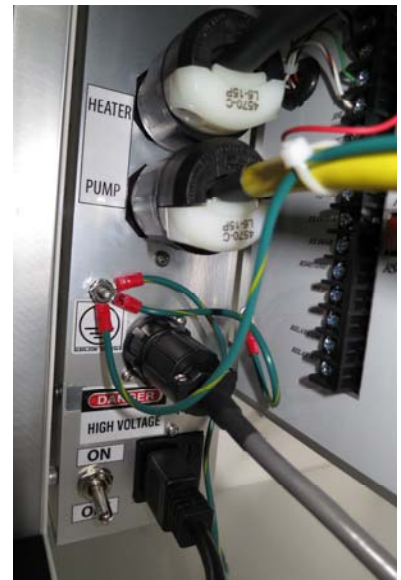

14. Install the AC power supply cable to the remaining connection on the bottom of the internal power strip. It is located next to the ON/OFF switch. See photo above right. Route the power cable and the sensor cable out of the bottom of the cable access opening.

15. Connect the 9528 grounding cable (included in the accessory kit) to the Ground connection shown in the above right photo. Route the ground cable out of the bottom of the cable access opening and connect it to the isolated site grounding rod.

16. Remove the inlet protector plugs from the BX-802 PM10 inlet head and BX-808 PM2.5 Very Sharp Cut Cyclone. Install the BX-808 on top of the inlet tube and then the BX-802 directly above it. See photos below.



17. Plug the AC power cable in to your AC source and turn the power switch to ON. Verify the fans start up in both the pump box and the main enclosure. The touchscreen display should also turn on as described in section 4.1.
18. Replace the cable access cover panel on the back of the enclosure and affix it in place with the four wing nut fasteners. Be sure the flange is on the bottom so that the power cable and the sensor cable will be pinned between the foam strips and held in place.

## 2.4 **BAM 1022 Power and Electrical Connections**

The BAM 1022 should be powered by either a 110 VAC 50/60Hz or 220 VAC 50/60 Hz source. Before proceeding with electrical connections, review the following notifications:

- △ Ensure that the monitoring site mains power (voltage and frequency) is compatible with the version of BAM 1022 monitor and accessories that has been purchased. Consult the electrical labels on the devices.
- △ All electrical connections must be in accordance with national codes. Always use grounded receptacles and power cords.

A dedicated 15 Amp electrical circuit is adequate to run a single BAM 1022 system. A summary of instrument power consumption is provided below:

<b>Description</b>	<b>Amps</b>	<b>Watts</b>
BAM 1022 on, pump and inlet heater off (115 VAC).	0.4 A	46 W
BAM 1022, pump and inlet heater on (115 VAC).	2.6 A	299 W
BAM 1022 on, pump and inlet heater off (230 VAC).	0.3 A	69 W
BAM 1022, pump and inlet heater on (230 VAC).	3.7 A	851 W

### 3 USER INTERFACE

The BAM 1022 user interface is a touchscreen display used to control almost all of the features and functionality of the BAM 1022. It is mounted on a hinged bracket located inside the enclosure near the inlet tube in the upper right hand corner of the monitor. The center screw of the mounting bracket hinge adjusts the amount of force necessary to reposition the bracket.



BAM 1022 User Interface

#### 3.1 Main Operating Screen

In addition to the last hourly concentration reading, this screen shows the current real time values being measured and the operational state of the BAM 1022. This image below on the left hand side is the screen that will normally be displayed.

BAM 1022		2014-10-29 13:54:19
Conc HR	3	ug/m3
Status	SAMPLING	
Conc RT	4 ug/m3	
Flow	16.7 LPM	
AT	24.4 C	
	▼	

BAM 1022		2014-10-29 14:50:32
Conc HR	3	ug/m3
RH	22 %	
BP	736 mmHg	
FT	24.6 C	
FRH	15 %	
	▲	

Note that the display has a limited amount of space and cannot show all of the real time data on one screen. Tap the up or down arrow keys in the lower left corner of the display to navigate between the two screens shown above.

## 3.2 Menu Hierarchy and Navigation

The BAM 1022 menu structure is outlined in the following table.

Main Menu	Sub Menu Options	Overview
Operate See section 3.3	Start Sample Load Filter Tape Transfer Data About	Begin or resume monitoring (will indicate Stop Sample, if appropriate) Load and properly tension the filter tape Download stored data to a USB memory stick Details the current BAM 1022 firmware type and version number
Test See section 3.4	Leak Test Ambient Temperature Ambient Pressure Flow Calibration Run Self-Test Parameters Filter Sensors Span Mass Audit Tape Test Nozzle/Count Test Analog Output Cal Analog Output Test Inlet Heater Relay Test Input Test Digital Link	Perform the leak test Calibrate ambient temperature or restore default settings Calibrate ambient pressure or restore default settings Calibrate flow rate or restore default settings Run the BAM 1022 Self-Test Review current settings Calibrate filter temp, filter RH, and pressure or restore default settings Run the zero and span foil tests Verify tape travels expected distance Test nozzle operation and verify beta counting Calibrate the analog output Test the analog output Manually turn the inlet heater on and off Manually open and close the alarm relay Test the digital clock sync input Test digital communications with the 597 sensor
Setup See section 3.5	Set Clock Sample Calibration Advanced Inlet Heater Clear memory Change Password Reports Alarms Station ID MET Average Analog Outputs Serial Port Sound Volume Touch Calibrate	Set the date and time Set the averaging interval for real time data; set concentration units Change the concentration offset and span membrane values. Set the K-factor Set the FT threshold for the inlet heater to activate Clear all stored data Change the master password Set the type of time stamp to use for the hourly report Set the differential pressure threshold for advancing the filter tape Set the ID (or location) number used to identify the BAM 1022 Set the averaging interval for collecting other than hourly data Set the parameters for both analog outputs Set the baud rate and connection type for serial communications Adjust the volume of the touchscreen sounds Calibrate the touch screen
Alarms See section 3.6	No sub menu	View alarms

Menu selections and instructions are detailed in the following sections of this operating manual as detailed in the Main Menu column of the table above.

To access the various main menus, press the three horizontal lines in the top left corner. A drop down menu will appear (see right) to allow selection of any of the four main menus. This option is available on all main menu screens (such as the Setup Menu shown below) and on the main operating screen.

BAM 1022		2014-10-29 14:58:37	
> Operate	99999	ug/m3	
> Test	STOPPED		
> Setup	99999 ug/m3		
> Alarms	0.0 LPM		
	24.7 C		
	▼		

Setup Menu		🏠
> Clock	> Inlet Heater	
> Sample		
> Calibration	> Clear Memory	
▼	▲	

To return to the main operating screen (see section 3.1), press the Home icon located in the upper right corner of all main menu screens. This icon can clearly be seen in the Setup Menu image shown here on the left.

To cancel an action and return to the previous menu screen, press the X icon located in the upper right corner of all sub menu screens. This icon can clearly be seen in the Set Clock Menu image to the right.

Clock						✕
Year	Month	Day	Hour	Minute	Second	
2018	3	27	16	26	46	
SET						

Location				
1 to 999	1	2	3	
1	4	5	6	✕
9999	7	8	9	
OK	Cancel	0		

Some parameters, such as the Date and Time settings (shown above) or a Location value, require numeric entry. When you press the button to edit such a field, a visual keypad (shown left) will open up and allow you to input the value. Press the OK key to accept the changes or the Cancel key to return to the previous screen. The X key on the far right performs a backspace operation.

### 3.3 Operate Menu

The Operate Menu is the doorway to the most commonly used areas for normal operation of the BAM 1022.

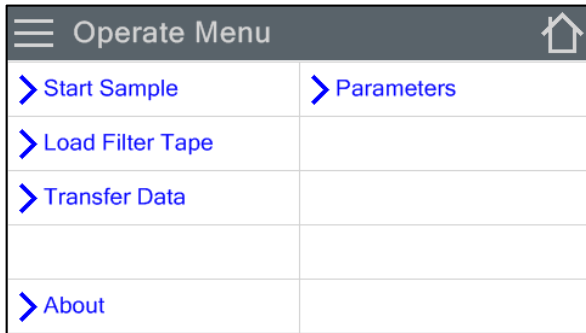

#### 3.3.1 Start Sample

This screen allows users to both start and stop the BAM 1022 sampling process. Upon entering this screen, a warning will be displayed asking users if they would like to start or stop a sample, depending on the current state of the monitor. If there is no sample currently being taken, the grey button in the lower left corner will be labeled START. If there is a sample in progress, it will read STOP.

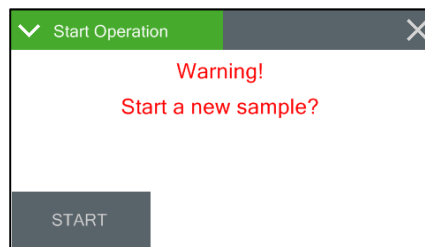

#### 3.3.2 Load Filter Tape

This screen provides the options needed to load and tension the filter tape. See section 4.2 for detailed instructions on loading filter tape.

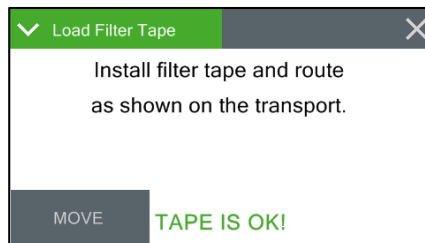

#### 3.3.3 Transfer Data

Copying data to a USB memory stick is performed from this screen. See section 7.3 for detailed instructions.

#### 3.3.4 About

This screen shows the monitor's model number, serial number, and installed firmware types and version numbers.

The screenshot shows a dialog box titled 'About' with a green header bar containing a checkmark icon and a close 'X' icon. The main content area is white and contains a table with system information.

Website	www.metone.com
Serial Number	T16479
Firmware Version	81650, R1.0.8
Display Version	82451, R1.0
CPLD Version	81699, R0.1.0



### 3.3.5 Parameters

These screens are not password protected. They provide the ability to view the real time value of a wide variety of parameters. Results are updated once per second. No changes can be made in this screen. It is for viewing purposes only.

Parameters	
Flow	0.0 LPM
AT	0.0 C
RH	0 %
BP	0 mmHg
▼	

Parameters	
Upper	721.1 mmHg
Lower	534.3 mmHg
FT	22.4 C
FRH	31 %
▼	

Parameters	
Box	26.3 C
Enclosure	21.3 C
Beta	2203 Hz
Heat	4.5 %
▼	

Note that the display has a limited amount of space and cannot show all of the real time data on one screen. Tap the down arrow key in the lower left corner of the display to scroll through the three screens shown above. Tapping the arrow on the last screen will return you to the first one.

### 3.4 Test Menu

The Test Menu provides a means of testing and calibrating individual sensor inputs and calculations. Because these settings directly impact flow and concentration values, most of these tests are password protected.

Test Menu	
> Leak Test	> Self Test
> Ambient Temperature	> Filter Sensors
> Ambient Pressure	> Span Mass Audit
> Flow Calibration	> Tape Test
▼	▲

Test Menu 2	
> Inlet Heater	> ISO Input
> Nozzle/Count Test	> Relay Output
> Digital Link	> Analog Calibration
	> Analog Output
▼	▲

Note that the display has a limited amount of space and cannot show all options on one screen. Tap the “>More...” and “>Back...” keys in the lower right corner of the display to navigate between the two screens shown above.

### 3.4.1 Leak Test

This screen provides the options and indications needed to perform a leak test of the sampling system. The grey pump control button in the lower left corner will read PUMP ON which indicates that pressing it will turn on the pump. Similarly, when the pump is running, this button will display PUMP OFF.

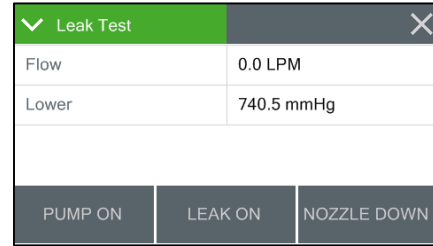

Use the LEAK ON button to force the flow sensor at its current value. This forces the pump regulate at the same value regardless of blocking the flow or not.

The grey nozzle control button in the lower right corner will always be labeled as NOZZLE when you first enter this test screen. Pressing it will cause the nozzle to change state from up to down or down to up. The button will now display what will happen if you press it again, just like the pump control button. This means that it will read NOZZLE UP if the nozzle is in the down position or NOZZLE DOWN if it is in the up position.

The flow and lower pressure sensor indications are provided for reference when performing the leak test. See section 6.2 for detailed instructions on performing a leak test.

### 3.4.2 Ambient Temperature

This screen provides the options and indications needed to default, verify, and calibrate the ambient temperature sensor as part of the flow audit and calibration. See section 0 for detailed instructions.

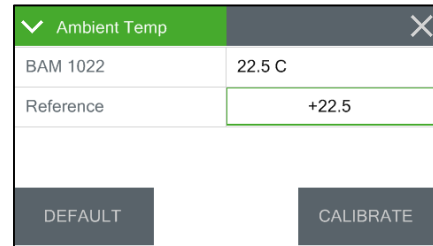

### 3.4.3 Ambient Pressure

This screen provides the options and indications needed to default, verify, and calibrate the ambient pressure sensor as part of the flow audit and calibration. See section 0 for detailed instructions.

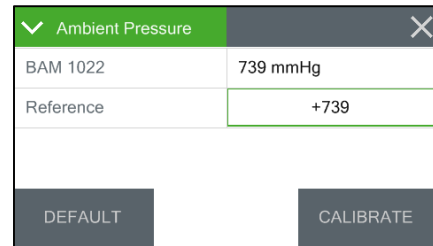

### 3.4.4 Flow Calibration

This screen provides the options and indications needed to default, verify, and calibrate the flow sensor as part of the flow audit and calibration. See section 0 for detailed instructions.

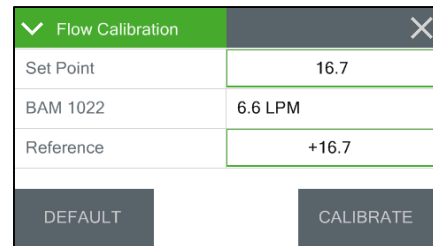

### 3.4.5 Run Self-Test

This screen runs the self-test sequence. Press X to exit once it is complete.

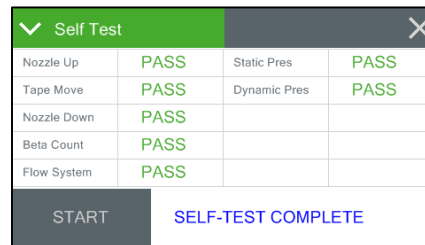

### 3.4.6 Filter Sensors

These screens provide the options and indications needed to default, verify, and calibrate the filter temperature, filter humidity, and upper and lower pressure sensors. See section 6.9 for detailed instructions.

### 3.4.7 Span Mass Audit

This screen runs the Span Mass Audit. The sequence begins as soon as you enter it. See section 6.8 for detailed instructions.

### 3.4.8 Tape Test

This screen will allow you to verify proper installation and operation of the filter tape and motors. Press the grey TEST TAPE button to advance the tape. The pass criteria is  $\geq 14$  mm. The status of the tape, such as OK or if there is a Tape Break error, will also be displayed to the right of the TEST TAPE button.

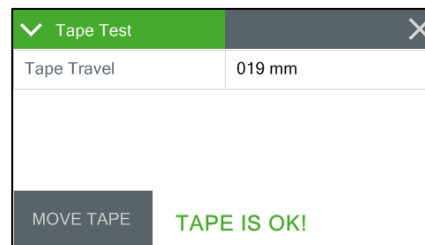

### 3.4.9 Nozzle/Count Test

The Nozzle/Count Test screen provides the ability to manually raise and lower the nozzle. Pressing the grey NOZZLE button will cause the nozzle to change state. When the nozzle is in the down position, you can also verify the monitor is beta counting correctly. The frequency for beta counts should be greater than 1000 Hz.

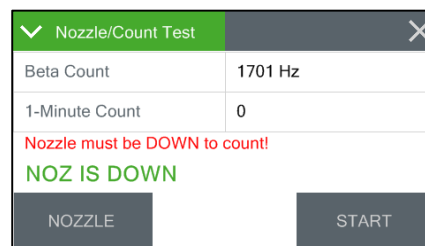

Counting should only occur when the nozzle is in the down position.

### 3.4.10 Analog Output Calibration

This screen allows for calibration of the two analog output channels.

The channel field defines whether you are adjusting output number one or two. Tap the green bordered Channel selection box and pick the channel you need to test. The full scale range will be displayed in the Range value box. If you wish to change the full-scale value, see section 0.

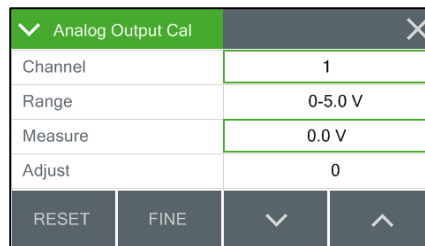

Analog Output Cal	
Channel	1
Range	0-5.0 V
Measure	0.0 V
Adjust	0
RESET	FINE
↓	↑

After selecting the output channel, the measure field may be adjusted to maximum or minimum value and the output of the channel confirmed. Just tap the green bordered Measure box and select the desired test output. Verify the actual output using a voltmeter at the appropriate channel terminals on the rear panel of the BAM 1022.

If the output is not correct, use the up and down arrow keys to modify the Adjust field. When the FINE/COARSE selection is set to FINE, units will be incremented by one. If it is set to COARSE, the units will be incremented in tens. Tap the button to swap between the options.

Pressing the X key to exit the screen will save any adjustments that have been made. To clear any custom settings and restore the factory defaults, press the grey RESET button.

### 3.4.11 Analog Output Test

To test the analog output channels, select channel number one or two on the top row marked Channel by pressing the green bordered Channel selection box. Now, using the Conc Output field, the output selection may now be modified to any test value in the -15 to +985 range.

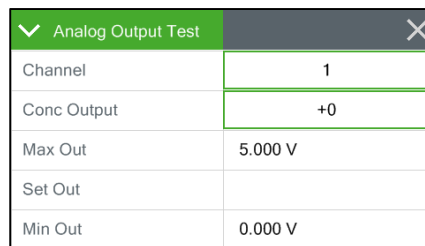

Analog Output Test	
Channel	1
Conc Output	+0
Max Out	5.000 V
Set Out	
Min Out	0.000 V

You'll notice the Min Out and Max Out fields match the zero and full scale values for the selected output. Between them is the Set Out field, which will update with the expected output based on the concentration selected. Verify the output on the back of the BAM 1022 matches the Set Out value shown.

### 3.4.12 Inlet Heater

This screen allows manual operation of the inlet heater assembly. Press ON to turn the heater on and verify the element heats up as expected. Press OFF to turn the heater off; verify it shuts off and then cools down. Exiting this test screen will also turn off the heater if you forget to turn it off when you are done testing.

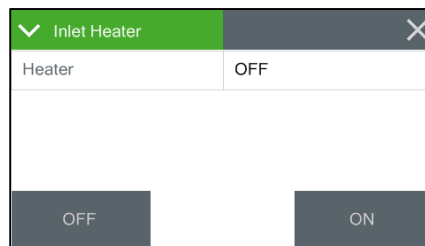

Inlet Heater	
Heater	OFF
OFF	ON

### 3.4.13 Relay Test

This screen allows manual operation of the external alarm relay. Press CLOSE to close the relay contacts. The NO (normally opened) relay on the back of the BAM 1022 should close its contacts. Press OPEN to reverse its state back to normal conditions.

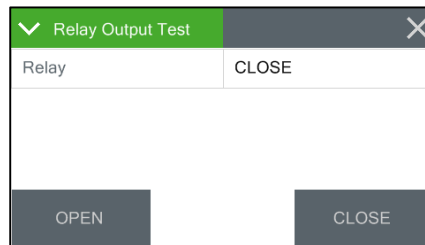

### 3.4.14 Input Test

Test the digital clock input on the back of the BAM 1022 by shorting the normally open ISO IN and ISO GND terminals together. When the terminals are shorted, this simulates a clock synchronizing signal being applied and the display shown here will change from OPEN to reading CLOSED.

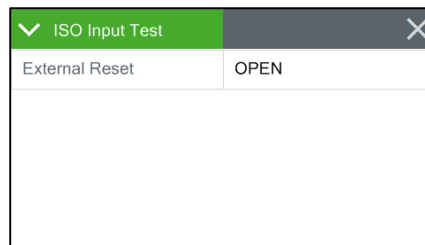

### 3.4.15 Digital Link

Test digital communications with the 597 by entering this screen. The 597 firmware version should be displayed when the proper link is established.

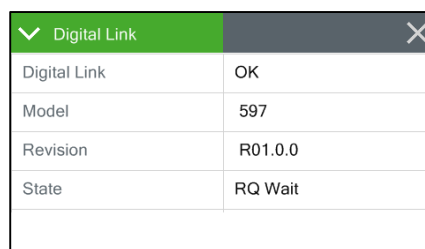

## 3.5 Setup Menu

The Setup Menu grants access to the configuration of the majority of the operating parameters for the BAM 1022. It allows you to change offsets, clear the memory, and set the date and time, and much more. Because of the changes able to be made, the Setup Menu is password protected.

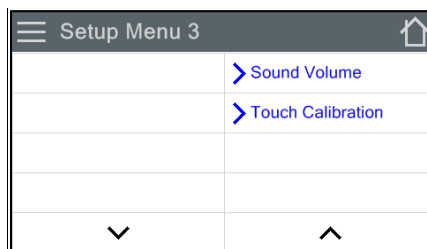
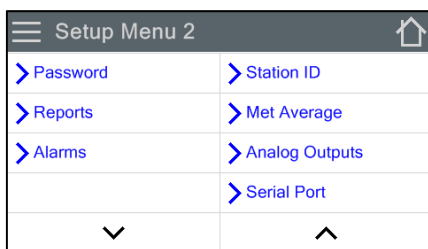
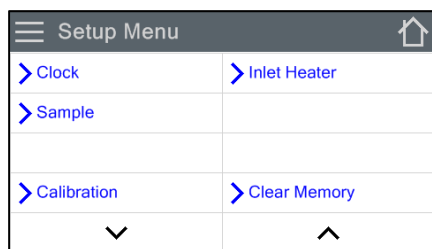

Note that the display has a limited amount of space and cannot show all options on one screen. Tap the up and down arrow keys to navigate between the three screens shown above.

### 3.5.1 Set Clock

This is where you set the date and time. Press the green box of the field you wish to modify. The numerical entry keypad will be displayed and allow you to enter the value for that parameter. Once all fields have been entered, press the grey Set button in the lower left corner to set them.

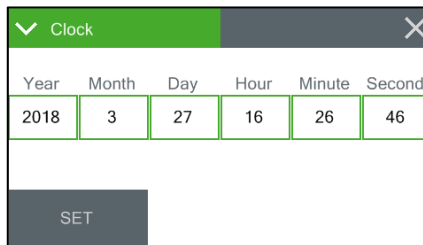

### 3.5.2 Sample

This screen allows you to setup the BAM 1022's sample options. Conc units allows you to set the BAM 1022's concentration units. The two current options are ug/m<sup>3</sup> or mg/m<sup>3</sup>. Real time period allows you to set the real time averaging period for the BAM 1022. The available average periods are from 15 to 60 minutes in one minute increments. See section 5.2 for more details about the Real Time calculation.

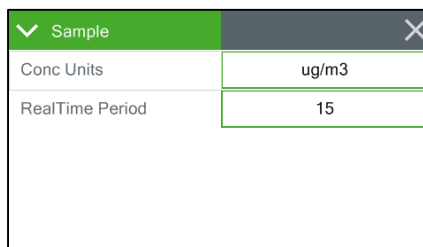

The Data Average (see section 3.5.11) must be set to an interval less than or equal to the Real Time Period in order to properly log the Real Time values.

### 3.5.3 Calibration

This screen allows you to setup certain calibration values for your BAM 1022. Background is the background zero correction factor determined from performing a zero test with the BX-302 Zero Filter (see Section 6.5). Regardless of the concentration unit setting, background is always entered in mg/m<sup>3</sup>.

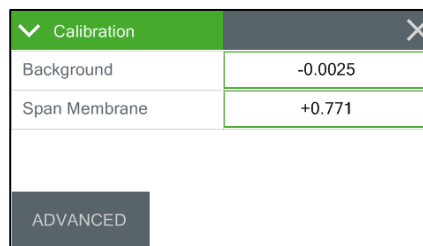

The Span Membrane is the factory-set expected mass of the reference membrane foil. Each unit's span membrane value is different, but is typically near 0.800 mg/cm<sup>2</sup>. Refer to the BAM 1022 calibration certificate that comes with the BAM 1022. The span membrane value will be listed under the Span Audit Value. ***The span membrane value is never changed by the operator unless the span membrane foil is replaced due to damage.***

### 3.5.4 Advanced

To get to the K-Factor setup screen, press the 'Advanced' button found in the calibration setup screen shown in section 3.5.3. Users will be prompted with the warning screen as shown in the image to the right. ***Changing the K-Factor should only be changed under advice from the factory, as changing your K-Factor will invalidate the factory calibration that came with the unit.***

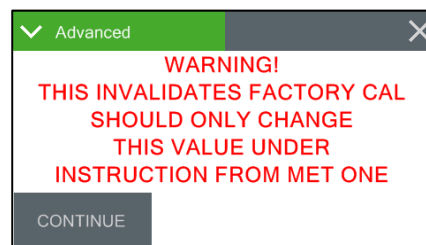

Pressing the 'Continue' button will allow the user into the Advanced screen, where users may adjust the K-Factor Calibration Constant. Only change this setting with advice from the factory.

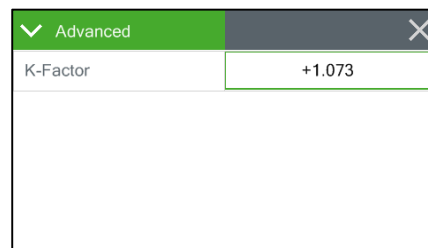

### 3.5.5 Inlet Heater

The BAM 1022 controls humidity at the filter by maintaining a specific filter temperature. Users set the desired FT (default is 45 Deg C) and once that temperature is reached, the BAM 1022 will modulate the heater to hold that FT.

This screen is used to set the target FT value. It can be set from 0 to 50 Deg C in one-degree increments. Press the green bordered value box and the numerical entry keypad will be displayed. Enter the new threshold value.

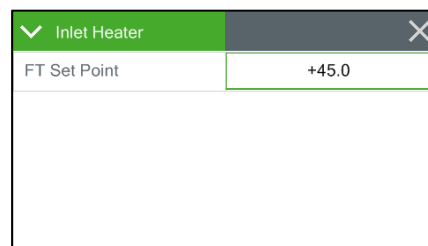

### 3.5.6 Clear Memory

The alarm and data logs may be cleared from this screen. Press CLEAR DATA button to clear the data log or press the CLEAR ALARM button to clear the alarm log. A confirmation screen will appear to confirm clearing the memory.

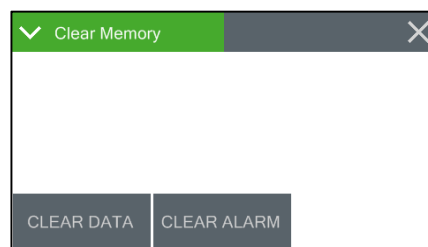

### 3.5.7 Change Password

Certain menus and options of the BAM 1022 are password protected. You may use any four digit password you would like and this is the screen you need to access to change it. Press the green bordered value box and the numerical entry keypad will be displayed. Enter the new password.

Setting the password to 0000 means no password is used.

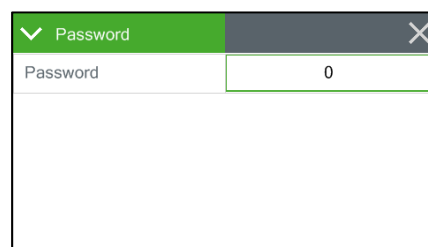

### 3.5.8 Reports

The hourly report time stamp can be set to mark the data with the time from either the beginning or ending of the hour. For example, if set to beginning, data collected during the hour from 8:00 to 9:00 would be marked as 8:00. Similarly, if that data were collected with ending as the choice, the data time stamp would be 9:00 instead. The beginning hourly timestamp only works when the data average period is 1 hour.

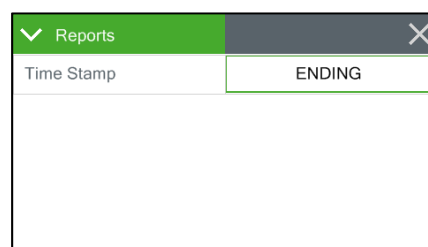

The factory default setting for this option is Ending. Press the green bordered value box and a list of the settings available will be displayed. Tap the one you wish to use and it will be applied.

### 3.5.9 Alarms

The BAM 1022 will advance the filter tape to a clean spot if the pressure drop across the tape gets too large. The threshold for this action can be set from 50 to 350 mmHg in one mmHg increments. Press the green bordered value box and the numerical entry keypad will be displayed. Enter the new pressure threshold value.

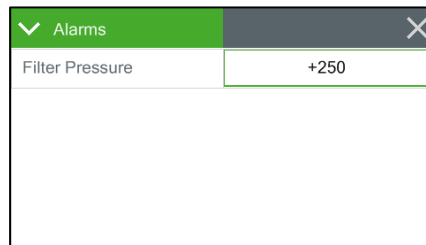

Press the OK key to set your new threshold.

### 3.5.10 Station ID

You may enter a four-digit station ID for the BAM 1022. Press the green bordered value box and the numerical entry keypad will be displayed. Enter the new location ID value.

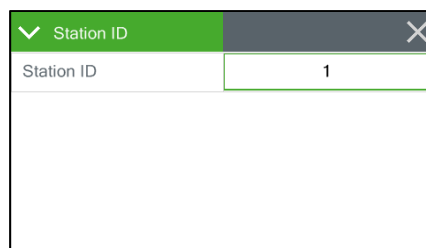

### 3.5.11 MET Average

If you would like to set an alternate averaging period for parameters other than concentration, you may do so from this screen. Press the green bordered value box and the selection screen shown below right will be displayed. Not all choices are able to be presented at the same time. Use the up and down arrow keys under the displayed options to show additional selections Tap the one you wish to use and then press the OK button to set it. The available average periods are 1, 5, 10, 15, and 30 minutes or 1 HR (for a one hour average).

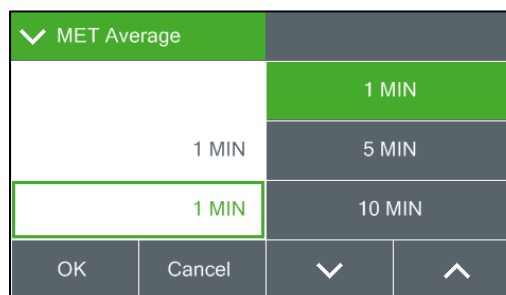
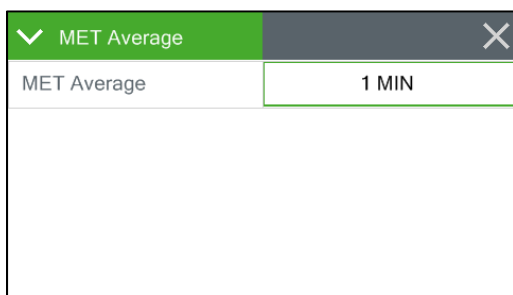



### 3.5.12 Analog Outputs

There are two analog output channels on the BAM 1022. Analog output 1 is the Real Time concentration and output 2 is hourly concentration. These are independently set to one of the following output ranges: 0-1.0 vdc, 0-2.5 vdc, 0-5.0 vdc, or 4-20 mA.

Analog Outputs	
Conc Range	1000 ug/m3
Conc Offset	0 ug/m3
Analog Range 1	0-5.0 V
Analog Range 2	0-5.0 V

However, there is only one span scale setting and it is applied to both channels. It can be set for 0-100, 0-200, 0-500, 0-1,000, 0-2,000, 0-5,000, or 0-10,000  $\mu\text{g}/\text{m}^3$  while the offset can be adjusted to -15, -10, -5, 0, 5  $\mu\text{g}/\text{m}^3$ .

Regardless of the concentration units setting, the scaling and offset is always entered in  $\mu\text{g}/\text{m}^3$ . To adjust the analog output settings, press the green bordered value box and a list of the settings available will be displayed. Tap the one you wish to use and it will be applied.

### 3.5.13 Serial Port

This is where your serial communication settings are configured. You can set the baud rate and the type of flow control you wish to use. Press the green bordered value box and a list of the settings available will be displayed. Tap the one you wish to use and it will be applied.

Serial Port	
RS-232 Baud	9600
Ethernet FlowControl	NONE

The baud rate options are 1200, 2400, 4800, 9600, 19200, 38400, 57600, and 115,200 while the flow control type can be either NONE or CTS/RTS. The CTS/RTS selection should ONLY be used when employing Ethernet port communications. All other modes should use the NONE flow control setting. Press the OK key to lock in your choices. See section 7.4 for more details about serial communications.

### 3.5.14 Sound Volume

The touchscreen will beep every time a selection is made and that volume may be adjusted in this screen. Press the green bordered value box and the numerical entry keypad will be displayed. You may enter a value from 0 – 100 with 100 being very loud and 0 being no beep at all. Any changes made here will not be active until exiting this screen.

Sound Volume	
Sound Volume	10

### 3.5.15 Touch Calibrate

Press the grey Calibrate button to enter the calibration screen. Simply follow the instructions on the screen to calibrate it. If each step is not completed within five seconds, the test will cancel itself and return to page two of the Setup menu. There is a countdown clock for this feature displayed on each step of the calibration process.

Touch Calibration	
CALIBRATE	

### 3.6 Alarms Menu

This screen is used to view time-stamped alarm events with the most recent alarm will be displayed first. Use the up and down arrow keys located at the bottom of the screen to scroll through the alarm log.

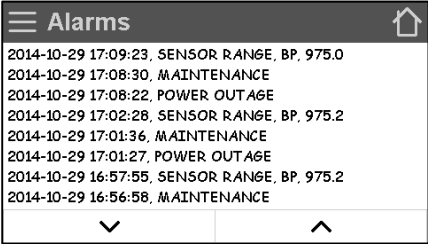

## 4 OPERATION

### 4.1 Initial Procedures

Prior to turning on the BAM 1022, confirm that all equipment set up procedures, outlined in Section 2 of this manual, have been completed.

The BAM 1022 power switch is located behind the rear panel near the bottom of the enclosure on the left hand side. Upon initial power up, the touchscreen will display a 60 second countdown. The display will beep once every six seconds while counting down. After 60 seconds have elapsed, the monitor will advance the tape one spot and begin sampling.

If tape is missing, or hardware errors (such as a missing sensor) are detected, the monitor will remain idle.

### 4.2 Loading Filter Tape

Filter tape must be installed before sampling will commence.

Use the following steps to load the roll of filter tape:

1. Press the "Operate Menu" button and select the "LOAD FILTER TAPE" option. Entering this screen will cause the nozzle to raise and instructions to load the tape per the door mounted diagram are displayed.
2. Remove the Plexiglas cover by pulling out at the bottom to release the Velcro holding strip, and then lifting the cover off of the two alignment pins at the top (see below).



3. Unscrew and remove the two clear plastic reel covers and both tape spool cores.
4. Make sure the BAM nozzle and vane are completely clean of debris. Cleaning procedures are detailed in Section 6.6 of this manual.
5. Slide an empty tape spool core on to the take-up reel (on the left). You may use the empty spool core that was just removed from the supply reel (on the right) or the grey core tube (part number 8150) supplied with the instrument
6. Unwrap a new roll of filter tape. Place the full roll on the supply reel and route the tape through the nozzle and vane as indicated on the inside of the door of the instrument.

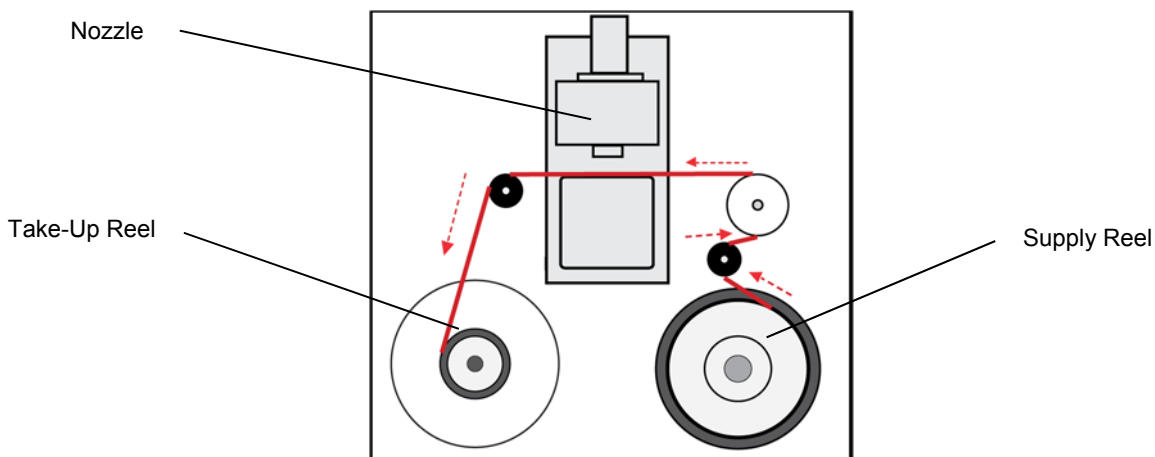

**BAM 1022 Front Panel (Door Open)**

7. Fasten the loose end of the new filter tape to the take-up spool core with a piece of tape.
8. Rotate the spools by hand to remove tape slack.
9. Replace the two clear plastic reel covers and fasten the screws tightly by hand.
10. Press the grey MOVE button to move the tape and verify it has been properly loaded.
  - i. If the tape is correctly installed, the display will report “TAPE IS OK!” in green letters beside the grey button.
  - ii. If there is a problem, it will report “TAPE FAIL” in red letters.
    1. Verify the tape is properly routed
    2. Remove any slack by rolling up loose tape on the tape spools.
    3. Press the MOVE button again to take out any additional slack and verify the tape is loaded correctly.

**Notes:**

- One roll of filter tape will last approximately 8 weeks when the BAM 1022 is set up to operate as a U.S. EPA PM<sub>2.5</sub> FEM.
- Filter tape should never be re-used. This will lead to measurement errors.
- For continuous monitoring requirements, it is recommended that spare filter tape rolls be kept in stock by the owner / operator. See section 9 for ordering information.

### **4.3 Warm-up Period**

If the BAM 1022 has been switched off for more than a few moments, the mass monitor must warm up for at least one hour before accurate PM measurements can be obtained. This is because the beta detector must stabilize. Users are encouraged to disregard the first two hourly PM data sets after power is restored.

During the warm up period, maintenance, programming (setup) changes, tests, and data downloads can be performed.

### **4.4 Commissioning**

The following steps should be performed when deploying a BAM 1022 for the first time:

1. Confirm that the BAM 1022 settings are correctly programmed. Refer to Section 3.5.
2. Perform a system Self-Test. See section 3.4.5 for details.
3. If an external data logger is being used, ensure that communication is properly established.
4. If the BAM 1022 analog outputs are being utilized, make certain that the BAM output correlates to the data logger input. To adjust the analog output, refer to section 0.
5. If the BAM 1022 data is being collected remotely, verify the telemetry system is functioning properly.

## 5 The BAM 1022 Measurement Cycle

### 5.1 Hourly Measurement Cycle

The BAM 1022 measurement cycle is essentially one hour.

When the cycle commences, the BAM 1022 will automatically advance the tape to the next sampling spot. The nozzle will be lowered on to the tape and sampling will begin. Flow rates are actively controlled and beta ray transmission is monitored throughout the cycle. At the end of the sampling event, the BAM 1022 will shut off the sample pump and repeat the cycle. The gap between measurements is one minute.

The BAM 1022 calculates, reports and records hourly PM concentrations at the top of each hour.

This measurement cycle will continue indefinitely, unless it is interrupted by either a loss of power, missing filter tape, an instrument error, or user intervention.

### 5.2 Short Term Averaging

The BAM 1022 always reports the hourly PM concentration at the top of the hour. Given that the measurement occurs in real time, hourly results may be supplemented with shorter term data. The Real Time concentration period, which is user defined, can be set to various short term periods as described in section 3.5.2 of this operating manual.

The Real Time calculation is a rolling average of the previous few minutes' concentration updated every minute. The number of minutes is defined using the Real Time concentration period setting. For example, if the 15-minute interval is selected, no Real Time value will be displayed until minute 15. It will then display the approximate average of the minute 1-15 time period. At minute sixteen, the average will update and will now only include minute 2-16. This process will repeat every minute until the sample is stopped.

**Note:** *The short term averaging is intended for use as a trend analysis tool. The numerical values recorded are an approximation and cannot be used to calculate the expected hourly concentration value.*

Both hourly and user defined average results are stored in the BAM 1022 data file.

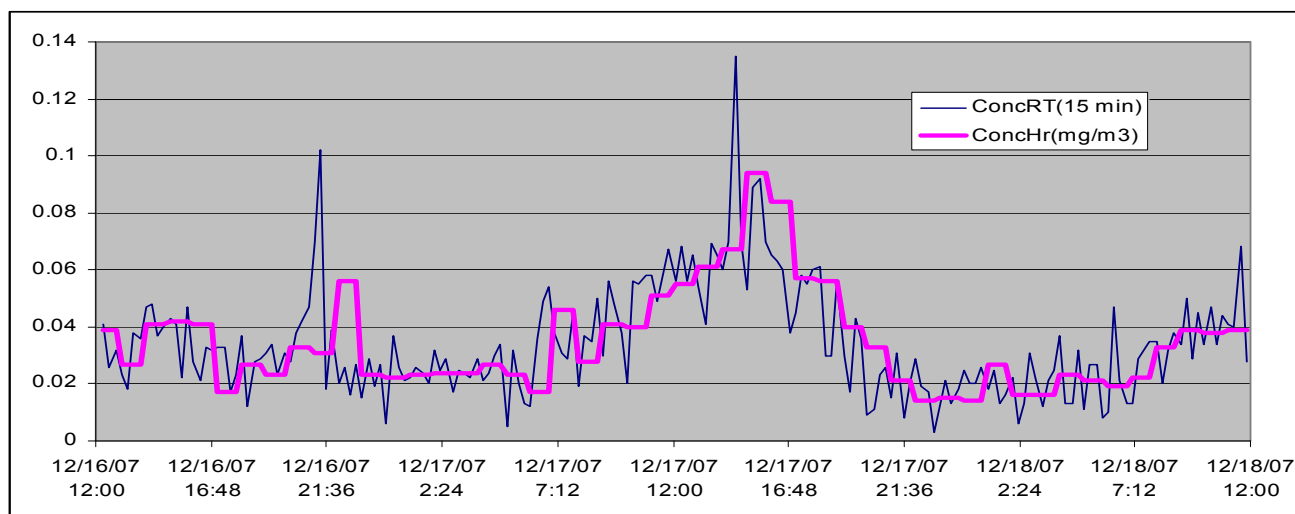

## 6 MAINTENANCE, ALARMS & TROUBLESHOOTING

This section provides information regarding routine maintenance, possible alarms, and field troubleshooting procedures.

### 6.1 Periodic Maintenance

The following table outlines the recommended period for normal maintenance procedures. Several items may need to be attended to more frequently due to site-specific characteristics. It is highly recommended that the operator of the instrument establish Site Operating Procedures (SOPs) based on their application.

Maintenance Item	Interval	Reference
Replace the filter tape - U.S. EPA PM <sub>2.5</sub> FEM Applications	8 Weeks	Sec. 4.2
Replace the filter tape (for high concentration areas)	As needed	Sec. 4.2
Basic leak check	8 Weeks	Sec. 6.2
Nozzle, vane and pinch roller cleaning	8 Weeks	Sec. 6.6
Flow audit (verify and/or calibrate flow system)	8 Weeks	Sec. 0
Clean PM <sub>10</sub> inlet particle trap	As needed	BX-802 Manual
Clean PM <sub>2.5</sub> cyclone particle trap	As needed	BX-808 Manual
Verify or set the clock	8 Weeks	Sec. 3.5.1
Mass Audit	6 Months	Sec. 6.8
Background determination	Annually	Sec. 6.5
Internal Nozzle Cleaning	6 Months	Sec. 6.7
Replace the pump muffler	6 Months	n/a
Test analog output voltage (if used)	6 Months	Sec. 0
Rebuild AC pump	As needed	BX-126 Manual
Empty PM <sub>10</sub> inlet water jar	As needed	n/a

## 6.2 Basic Leak Check

The BAM 1022 requires periodic leak checks to ensure that the sample flow is not being diluted. The majority of leaks will occur at the nozzle - tape interface. A leak may also be caused by degraded O-rings, or an improper inlet tube to receiver connection.

**Required Tools:** Leak Check Valve (Part No. BX-305 or included as part of the BX-302)

**Minimum Suggested Interval:** Upon commissioning and after replacing filter tape (8 weeks).

Use the following steps to conduct the basic leak check:

1. Go to the TEST>TAPE TEST menu. This will stop the current sample, if one is in progress, and then raise the nozzle.
2. Advance the tape one time by pressing the MOVE TAPE button. If the last sample spot is not clearly visible, advance the tape a second time.
3. Inspect the last sample spot on the tape roll. Examine it closely for any abnormal deformation or holes. The presence of abnormalities indicates debris build up at the nozzle / vane interface. This will need to be cleaned to restore proper operation.
4. Remove the PM<sub>10</sub> size selective inlet from the sample tube and install the BX-305 leak check valve (or BX-302 zero filter). If a PM<sub>2.5</sub> cyclone is being used, it should be left in place and included in the leak check. Verify that the leak valve is in the open position.
5. Navigate to the TEST>LEAK TEST menu. See section 3.4.1 for details on how the buttons on this screen function. Verify the nozzle is in the down position. If it is not, press the nozzle control button to lower it. The BAM 1022 is ready to begin the leak test.
6. Press the PUMP ON button and the BAM 1022 will start the pump. Monitor the flow rate on the BAM 1022 display and allow it to stabilize at 16.7 LPM
7. Press the LEAK ON button.
8. Close the BX-305 valve as shown in the image below. The flow rate should begin dropping as the sampling system is evacuated.





9. The pump flow rate should drop below 1.5 LPM.
  - a. If the flow rate is 1.5 LPM or less, the leak check is satisfactory. Proceed to step 10.
  - b. If the flow rate is greater than 1.5 LPM, then cleaning is required. Thoroughly clean the nozzle / vane interface and then perform this test again. If it passes, proceed to step 10. If it fails a second time, go to section 6.3.
10. Exit to the main menu.
11. Slowly open the BX-305 valve to release the vacuum inside the BAM 1022.
12. Remove the BX-305 and replace the PM<sub>10</sub> size selective inlet.
13. Resume normal sampling operations.

### 6.3 Advanced Leak Checks

If the basic leak check detailed in section 6.2 fails, the following procedures will isolate the problem.

**Required Tools:** Leak Check Valve (Met One Instruments Part No. BX-305 or BX-302)  
Nozzle Seal Tool (Part No. 7440)

#### 6.3.1 Total System Leak Test

This procedure will create a positive seal at the nozzle / vane interface. With this seal in place, the rest of the flow system can be tested for leaks.

The following procedure assumes steps 1 through 9 in section 6.2 have just been completed and a flow rate of greater than 1.5 LPM was found.

1. If running, press the PUMP OFF button to turn off the pump. Then, press the NOZZLE UP button to raise the nozzle.
2. Remove the filter tape from beneath the nozzle and insert the Nozzle Seal Tool with the hole positioned beneath the nozzle and then press the NOZZLE DOWN button. See the image below.



3. Verify the BX-305 valve is still mounted on the inlet and is in the closed position.
4. Press the LEAK ON button. The BAM 1022 will start the pump and begin the leak test.
5. The pump flow rate should drop below 0.3 LPM.
  - a. If the flow rate is 0.3 LPM or less, the leak check is satisfactory. The high flow rate observed during the basic leak test is located at the nozzle / tape interface. Proceed to section 0.
  - b. If the flow rate is greater than 0.3 LPM, then there is a leak somewhere in the system. Go to section 6.3.2 to locate the leak.

### 6.3.2 Lower System Leak Test

This procedure will split the flow system at the nozzle / vane interface. With this seal in place, only the portion of the flow system downstream of this location will be placed under vacuum and tested for leaks.

The following procedure assumes the steps listed in section 6.3.1 were performed and a leak of greater than 0.3 LPM was found.

1. If running, press the PUMP OFF button to turn off the pump. Then, press the NOZZLE UP button to raise the nozzle.
2. Rotate the Nozzle Seal Tool so that the solid portion of the tool is positioned beneath the nozzle and then press the NOZZLE DOWN button. See the image below.



3. Press the LEAK ON button. The BAM 1022 will start the pump and begin the leak test.

4. The pump flow rate should drop below 0.3 LPM.
  - a. If the flow rate is 0.3 LPM or less, the leak check is satisfactory. This confirms that the leak is above the nozzle. Investigate all mating connections and O-rings in the flow path before the nozzle / vane interface to locate and correct the leak.
  - b. If the flow rate is greater than 0.3 LPM, then there is a leak downstream of the nozzle. Investigate all mating connections and O-rings in the flow path after the nozzle / vane interface to locate and correct the leak.
  - c. Once resolved, repeat the steps listed in section 6.2 to verify the flow system integrity.

### 6.3.3 Filter Tape Leak Test

Use this procedure to assess a high flow rate at the nozzle / tape interface. It is assumed that the Basic Leak Check and the Total System Leak Test have both already been performed and a high flow rate at the nozzle / tape interface was found. It is also assumed that the filter tape is still not installed.

**Required Tools:** Certified Calibration Transfer Standard (CTS) such as the BX-307  
Nozzle Seal Tool (Part No. 7440)  
Filter Tape (Part No. 460180)

1. Remove the BX-305 from the sample tube and install the calibration transfer standard (CTS).
2. Navigate to the TEST>LEAK TEST menu.
3. The Nozzle Seal tool may already be installed with the hole positioned beneath the nozzle (see section 6.3.1). If this is not the case, press the NOZZLE UP button to raise the nozzle (if needed), position the sealing tool in this configuration, and then lower the nozzle.
4. Press the PUMP ON button to start the pump. The LEAK status should remain LEAK OFF.
5. Allow at least 2-3 minutes for the flow to fully stabilize. When the flow rate stabilizes, write down the CTS flow rate value. This is the “Without Tape” value.  
**NOTE:** *If after 5 minutes, the flow still has minor fluctuations, estimate the average flow rate and use that for the “Without Tape” value.*
6. Stop the pump and raise the nozzle.
7. Remove the Nozzle Seal Tool.
8. Place a three-inch-long piece of filter tape directly below the nozzle and then lower the nozzle onto the tape.
9. Press the PUMP ON button to start the pump. The LEAK status should remain LEAK OFF.
10. When the flow rate stabilizes, write down the CTS flow rate value. This is the “With Tape” value.
11. Stop the pump and raise the nozzle.
12. Remove the strip of filter tape.

13. Subtract the “With Tape” value from the “Without Tape” value using the following equation:

$$\text{WithoutTape} - \text{WithTape} = \text{LeakRate}$$

The result should be a positive value of 0.3 LPM or less. A typical example might look like this: 16.71 LPM – 16.58 LPM = 0.13 LPM

- a. If the difference is 0.3 LPM, or less, the leak test passes. Record the results (as needed), remove all test equipment, and resume normal sampling operations.
- b. If the difference is greater than 0.3 LPM, an out of tolerance leak exists at the nozzle / tape interface. Thoroughly clean the nozzle and vane area and then perform this test again. Repeat this test. If after a couple of attempts this test still fails, contact the Met One Instruments, Inc. service department (see section 1.2) for assistance.

#### 6.4 Flow Audit and Calibration

The accuracy of the BAM 1022 flow control system should be periodically verified. If the flow, temperature or pressure sensors are not operating within desired specification, they should be calibrated.

**Required Tools:** Certified Calibration Transfer Standard (CTS)  
(e.g. Flow Calibration Kit, Met One Instruments Part No. BX-307)

**Minimum Suggested Interval:** Complete calibration upon commissioning.  
Verification required after replacing filter tape (8 weeks).

All calibration transfer standards should be certified to the following criteria, and have a valid certificate of traceability to NIST standards:

Transfer Standard	Acceptance Criteria
Flow Rate	± 2% of NIST Traceable Standard
Ambient Temperature	± 0.1° C Resolution ± 0.5° C Accuracy
Barometric Pressure	± 1 mmHg Resolution ± 5 mmHg Accuracy

If a flow audit is desired (and not a full calibration) the same procedure detailed in this section is followed, but no changes are made; the results are observed and recorded only. A flow audit confirms operation of the flow system without making any alterations. This may be necessary to validate collected data.

During verification of the BAM 1022 flow control system, the following acceptance criteria should be maintained.

Parameter	Acceptance Criteria
Flow Rate	± 4% of transfer standard
Ambient Temperature	± 2° C of transfer standard
Barometric Pressure	± 10 mmHg of transfer standard

Use the following steps to verify and calibrate sensors associated with the BAM 1022 sample flow control system.

1. Make certain that the BAM 1022 has warmed up for at least 60 minutes prior to performing calibrations. Also, allow the calibration transfer standard (CTS) to equilibrate to ambient conditions for no less than 30 minutes.
2. Go to the Operate menu and select Stop Sample to stop the current sample.
3. Remove the size selective inlet(s) from the sample tube and install the calibration transfer standard (CTS).
4. Enter the Test > Ambient Temperature screen.
5. Compare the BAM 1022 temperature measurement and CTS temperature reading.
6. If the BAM 1022 temperature sensor exceeds the criteria listed in the table above, press the grey DEFAULT button to remove any previous offsets. If the temperature now passes, skip the next step.
7. If the temperature still needs to be adjusted, press the green bordered value box and the numerical entry keypad will be displayed. Enter the CTS value in the Standard field, and press OK to return to the Ambient Temperature screen. Press the grey CALIBRATE button to enter the new calibration offset.
8. Return to the TEST menu and go to the Ambient Pressure screen.
9. Compare the BAM 1022 pressure measurement and CTS pressure reading.
10. If the BAM 1022 pressure sensor exceeds the criteria listed in the table above, press the grey DEFAULT button to remove any previous offsets. If the pressure now passes, skip the next step.
11. If the pressure still needs to be adjusted, press the green bordered value box and the numerical entry keypad will be displayed. Enter the CTS value in the Standard field, and press OK to return to the Ambient Pressure screen. Press the grey CALIBRATE button to enter the new calibration offset.
12. Return to the TEST menu and go to the Flow Calibration screen. The pump will start automatically and adjust flow to the 16.7 lpm test point.
13. Press the green bordered value box the flow rate test set point selection will appear.
14. Select the 14.0 lpm set point and then press the OK button. The display will return to the Flow Calibrate screen and adjust the flow to the new test point.
15. Allow the BAM and CTS reading to stabilize (at least one minute) and then compare the BAM 1022 flow measurement and CTS flow reading.

16. If the BAM 1022 flow rate exceeds the criteria listed in the table above, press the grey DEFAULT button to remove any previous offsets for all three flow settings. If the flow rate now passes, skip the next step.
17. If the flow rate still needs to be adjusted, press the green bordered value box and the numerical entry keypad will be displayed. Enter the CTS value in the Standard field, and press OK to return to the Flow Calibrate screen. Press the grey CALIBRATE button to enter the new calibration offset.
18. Press SET to apply the change. When setting the 16.7 lpm flow rate, the SET option will change to read CALIBRATE.
19. Repeat steps 13 through 16 above for the 17.5 lpm flow rate.
20. Repeat steps 13 through 16 above for the 16.7 lpm flow rate.
21. Return to the Main Operating Screen and remove the CTS from the inlet tube and replace the size selective inlet(s).
22. Resume normal sampling operations.

## 6.5 Background Determination (Mass Offset)

It is recommended that the BAM 1022 undergo a background test upon initial deployment, annually, and after any major repairs have been performed.

**Required Tools:** Zero Filter (Met One Instruments Part No. BX-302)

Use the following steps to conduct a zero filter background test and set the mass offset.

1. Ensure that the BAM 1022 has been calibrated and that leaks are not present.
2. Go to the Operate menu and select Stop Sample to stop the current sample.
3. Remove the size selective inlet(s) from the sample tube and install the zero filter.



BX-302 Zero Filter Assembly

4. Verify that the zero filter leak valve is in the open position.
5. Go to the Setup menu and select Calibration.
6. Set the Background value to zero (see section 3.5.3 for details).
7. Exit the Background menu, go to the Operate menu, select Start Sample, and begin sampling.
8. After no less than 76 hours, retrieve the BAM 1022 hourly concentration data. Confirm that the monitor ran without disruption. If errors, power outages or maintenance occurred, the test will have to be restarted.
9. Calculate the average of the most recent 72 hourly PM concentrations. Record this value.
10. Calculate the new Mass Offset value determining the negative of the 72 hour average calculated in Step 9. For example, if the 72 hour mean =  $1.07 \mu\text{g}/\text{m}^3$ , the new Mass Offset would be  $-1.07 \mu\text{g}/\text{m}^3$ . Since all Background values are entered in units of  $\text{mg}/\text{m}^3$ , you would round to the fourth decimal place and use  $-0.0011 \text{mg}/\text{m}^3$ .
11. Return to the Setup menu and select Calibration.
12. Enter the new background value.
13. Go to the Operate menu and select Stop Sample to stop the current sample, if the monitor is still sampling.

14. Remove the zero filter from the inlet tube and install the size selective inlet(s)
15. Resume normal sampling.

**NOTES:**

For best results, the zero filter background test should be performed during a period of fairly stable weather.

The zero filter cartridge should be replaced if there are any obvious signs of discoloration due to aging or the aspiration of water. See section 9 for ordering details.

To determine the hourly zero noise and hourly lower detection limit, calculate the standard deviation of the most recent 72 hourly PM concentrations (the values used in step 9 above). The standard deviation ( $\sigma$ ) should be less than or equal to 2.4  $\mu\text{g}$ . The hourly detection limit is defined as two times the standard deviation ( $2\sigma$ ).

If the standard deviation is greater than 2.4  $\mu\text{g}$ , the cause should be investigated. Contact your local Met One Instruments representative for assistance.



## 6.6 Nozzle, Vane & Pinch Roller Cleaning

Over time, a gradual build-up of filter tape debris and particulate may form on the nozzle and vane sealing surfaces. Follow the steps below to clean particulate filter tape debris from these surfaces.

**Required Tools:** Cotton Tipped Swabs (Met one Instruments Part No. 995217)  
Isopropyl Alcohol  
Canned Air (a.k.a. Compressed Air Duster) with Tube

**Suggested Interval:** Upon filter tape replacement (8 weeks).

Use the following steps to clean the nozzle and vane assembly:

1. Navigate to the Test>Leak Test menu and raise the nozzle, if needed.
2. Remove the BAM 1022 filter tape.
3. Thoroughly clean the nozzle seal and vane with a clean swab dipped in alcohol. Do not use any sharp tools. Allow the alcohol to dissolve hardened deposits. Since the beta detector is located beneath the vane, prevent debris from falling through the holes.
4. If debris falls through or is found beneath the vane, carefully clean the cavity with a blast of compressed air.
5. Re-install the BAM 1022 filter tape per section 4.2 and perform a leak check as instructed in section 6.2.

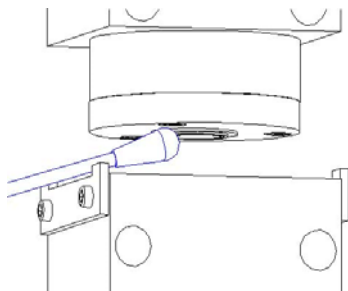

**Nozzle Seal Cleaning**

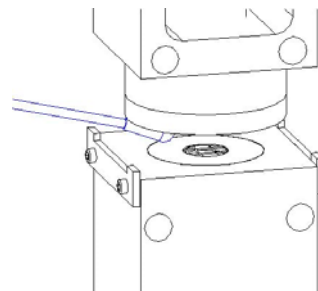

**Vane Cleaning**

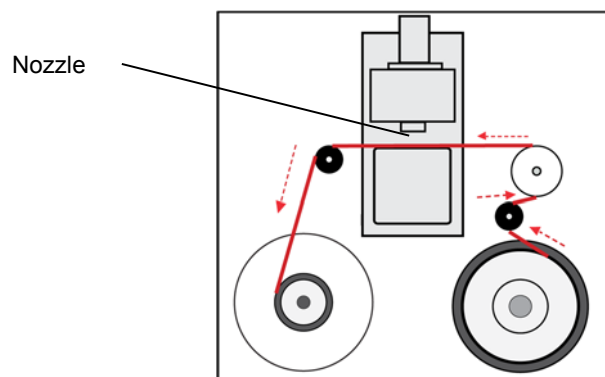

**BAM 1022 Front Panel (Door Open)**

## 6.7 Internal Nozzle Cleaning

The inside of the sample nozzle should be periodically cleaned to remove particulate which may have settled on internal surfaces. This cleaning prevents a buildup of debris, which could fall out of the nozzle and on to the tape (causing undesired positive concentration spikes).

**Required Tools:** Canned Air (a.k.a. Compressed Air Duster) with Tube

**Suggested Interval:** Every 6 months.

Use the following steps to clean the nozzle's internal surfaces:

1. Go to the Operate menu and select Stop Sample to stop the current sample.
2. Remove the size selective inlets and smart heater from the sample tube pull the sample tube out of the BAM 1022 inlet receiver.
3. Go to the Test > Tape Test menu and press the grey TEST TAPE button to advance the filter tape to a clean spot.
4. Gently slide the canned air tube down the inlet receiver on top of the BAM 1022. Supply multiple short blasts of air, while moving the canned air tube from side to side to blow on all surfaces inside the inlet. See picture below.



5. Go to the Operate menu and select Start Sample to start a new sample. Allow the pump to run for approximately 1 minute and then stop the sample.
6. Go to the Test > Tape Test menu and advance the filter tape to allow inspection of the sample spot.
7. If debris is still present, repeat steps 3 -6.
8. Reinstall the inlet tube, smart heater, and size selective inlets before sampling is resumed.

## 6.8 Span Mass Audit

### Mass Audit Screen

This screen, located in the Test menu, is used to verify the performance of the BAM 1022 beta attenuation system. A zero and span foil (included in the BAM 1022 accessory kit) will be required to complete this procedure. When this screen is accessed, the nozzle will be raised and you will be instructed to enter the zero calibration foil.

The filter tape **must be loaded** for this test. Insert the zero foil **above the filter tape** between the nozzle and vane, with the label facing up. Take care to minimize tape movement. When the zero foil is detected, the nozzle will automatically lower on to the foil and the four minute measurement will commence. After four minutes, the nozzle will be raised and the screen will instruct you to remove the zero foil. Remove the zero foil. Take care to minimize tape movement.

Once removed, the display will change to list the current span foil setting. Compare this value to the value on the calibration certificate. It should be correctly entered at the factory. If the values do not match, tap the green bordered span value field and enter the value listed on the calibration certificate now. Press the grey CONTINUE button to continue to the next step.

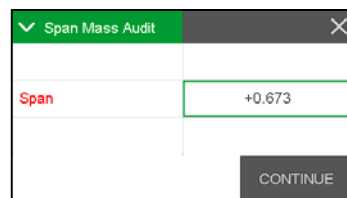
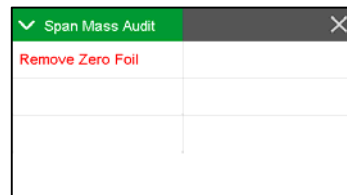
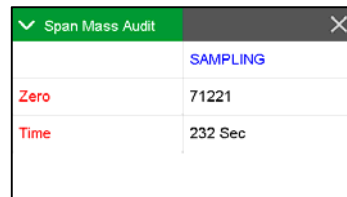
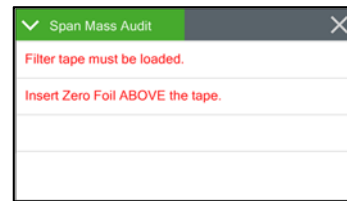

The display will instruct you to insert the span foil. Insert the span foil **ABOVE the filter tape**, with the label facing up. Take care to minimize tape movement. When the span foil is detected, the nozzle will automatically lower on to the foil and the four minute measurement will commence.

After four minutes the display will change to list the results of the audit. The measured mass will be listed on the top, the programmed span value will be in the middle, and the error between the two will be listed on the bottom.

If the error is greater than +/- 5%, the audit has failed. The error is usually caused by tape movement during the insertion and removal of the zero and span foils. Redo the test while paying attention to minimizing tape movement.

If the test continues to fail, see sections 6.6 and 6.7 for cleaning instructions. If the audit continues to fail, contact the Met One Service team for assistance.

Press the X button in the upper right corner to exit the audit. The nozzle will be raised you will be instructed to remove the span foil. Remove the foil and the display will automatically return to the Test menu.

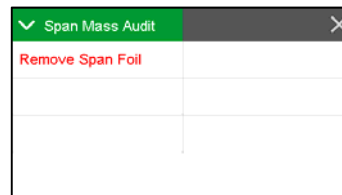
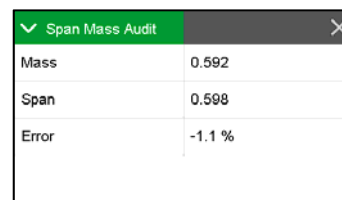
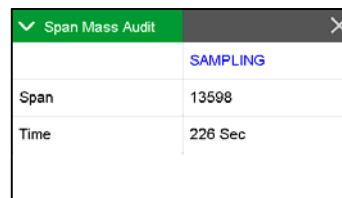

## 6.9 Filter Sensor Testing

The four filter sensors are all verified at a single test point. The temperature and relative humidity sensors are both tested with the pump running so that air flows across the sensors and provides an accurate indication. Both the upper and lower pressure sensors are tested with the pump off so that they will display the ambient pressure value.

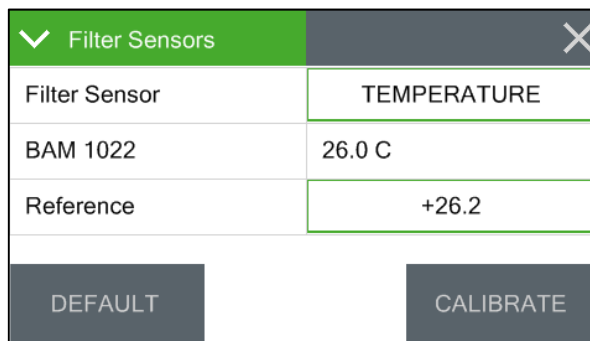

Filter Sensors	
Filter Sensor	TEMPERATURE
BAM 1022	26.0 C
Reference	+26.2
DEFAULT CALIBRATE	

If factory default values are ever needed, press the grey DEFAULT key. This will remove all field applied calibrations for the selected sensor and restore the factory default values.

Note: Never calibrate the temperature or relative humidity sensors if the inlet heater has been operating recently. The pump should be run for at least two hours after turning off the inlet heater before attempting to calibrate these sensors.

### 6.9.1 Filter Temperature and Relative Humidity Sensors

1. Navigate to the Test> Filter Sensor menu.
  - a. The pump will start and the menu will display the filter temperature sensor test interface first. Allow the pump to run for at least ten minutes to allow the sensor to equilibrate with the reference standard (see step 2 below).
  - b. Verify that the nozzle automatically raises if it is in the down position. It must be in the up position for these tests.
2. Place the AT standard as close as possible to the nozzle opening. Allow at least ten minutes for the standard to equilibrate with the filter sensor while the pump is running.
3. Verify the BAM 1022 reading matches the standard within +/- 1 deg C.
  - a. If the sensors do not match within specification, press the green bordered Standard value field and enter the value reported by the standard.
  - b. Press the grey CALIBRATE button to set the new calibration.
4. Tap the green bordered Filter Sensor field.
5. Locate the HUMIDITY option in the sensor list. You may need to use the up and down arrow keys to view the entire list.
6. Tap the HUMIDITY option to select it. The option should turn green. Press the OK button to exit out of the sensor selection list and return to the sensor test screen.
7. Place the RH standard as close as possible to the nozzle opening. Allow at least ten minutes for the standard to equilibrate with the filter sensor while the pump is running.
8. Verify the BAM 1022 reading matches the standard within +/- 4%.
  - a. If the sensors do not match within specification, press the green bordered Standard value field and enter the value reported by the standard.
  - b. Press the grey CALIBRATE button to set the new calibration.
9. If filter sensor testing is complete, press the X key to return to the Test menu. If pressure sensor testing also needs to be performed, go to section 6.9.2.

## 6.9.2 Filter Pressure Sensors

1. Navigate to the Test> Filter Sensor menu.
  - a. The pump will start and the menu will display the filter temperature sensor test interface first.
  - b. Verify that the nozzle automatically raises if it is in the down position. It must be in the up position for these tests.
2. Tap the green bordered Filter Sensor field.
3. To calibrate the upper pressure sensor, locate the UPPER PRES option in the sensor list. You may need to use the up and down arrow keys to view the entire list.
4. Tap the UPPER PRES option to select it. The option should turn green. Press the OK button to exit out of the sensor selection list and return to the sensor test screen.
5. Verify the pump turns off.
6. Place the pressure standard as close as possible to the nozzle opening. Allow at least ten minutes for the standard to equilibrate with the filter sensor.
7. Verify the BAM 1022 reading matches the standard within +/- 5 mmHg.
  - a. If the sensors do not match within specification, press the green bordered Standard value field and enter the value reported by the standard.
  - b. Press the grey CALIBRATE button to set the new calibration.
8. Tap the green bordered Filter Sensor field.
9. To calibrate the lower pressure sensor, locate the LOWER PRES option in the sensor list. You may need to use the up and down arrow keys to view the entire list.
10. Tap the LOWER PRES option to select it. The option should turn green. Press the OK button to exit out of the sensor selection list and return to the sensor test screen.
11. Verify the pump remains off.
12. Place the pressure standard as close as possible to the nozzle opening. Allow at least ten minutes for the standard to equilibrate with the filter sensor.
13. Verify the BAM 1022 reading matches the standard within +/- 5 mmHg.
  - a. If the sensors do not match within specification, press the green bordered Standard value field and enter the value reported by the standard.
  - b. Press the grey CALIBRATE button to set the new calibration.
14. If filter sensor testing is complete, press the ESC key to return to the test menu. If temperature and RH sensor testing also needs to be performed, go to section 6.9.1.

## 6.10 Basic Problems & Solutions

The following table contains information on some of the more common problems that may be encountered, and some steps to identify and remedy the problems. Met One Instruments welcomes customer suggestions for new items to include in this section of future manual revisions. If the solution cannot be found in the following table, then contact one of our expert service technicians for help in resolving your problem.

<b>Problem:</b>	<b>The mass monitor won't start a measurement cycle.</b>
<b>Cause/Solution:</b>	<ul style="list-style-type: none"> <li>• The mass monitor will not start a measurement cycle if it detects a hardware failure, such as low beta count signal, nozzle failure, pressure sensor failure, or pump failure.</li> <li>• The mass monitor will not start a cycle if the ambient temperature sensor is not connected.</li> <li>• The mass monitor will not start a cycle if the filter tape is not installed correctly.</li> <li>• The mass monitor will usually display an error message on the display if it cannot start a cycle.</li> <li>• If the mass monitor is left in a SETUP or FIELD CALIBRATION screen, it should still try to start a cycle after several minutes of inactivity, unless a failure is detected.</li> </ul>
<b>Problem:</b>	<b>The analog output voltage concentration readings are full-scale.</b>
<b>Cause/Solution:</b>	<ul style="list-style-type: none"> <li>• The mass monitor will force the analog output to the full scale voltage to indicate an error. Review the History / Alarm log to view any possible errors.</li> <li>• The full-scale analog output is usually scaled to represent 1.000 mg/m<sup>3</sup>. If this concentration is recorded by an external data logger which is measuring the analog output, then either there is an error in the mass monitor, or the particulate concentrations have exceeded the range of the analog output.</li> </ul>
<b>Problem:</b>	<b>The mass monitor records frequent "Tape Advance" errors.</b>
<b>Cause/Solution:</b>	<ul style="list-style-type: none"> <li>• This usually indicates that the filter tape is automatically advancing in response to being clogged due to heavy particulate loading.</li> <li>• If frequent tape advance errors are encountered, try setting the TAPE ADVANCE setting to a higher value. When hourly PM readings repeatedly exceed 100 µg/m<sup>3</sup> more frequent tape advance intervals may be required. See section 3.5.9.</li> </ul>
<b>Problem:</b>	<b>The concentration indicates negative values.</b>
<b>Cause/Solution:</b>	<ul style="list-style-type: none"> <li>• It is possible for the mass monitor to occasionally record negative hourly values if the actual particulate concentration is very low, such as below µg/m<sup>3</sup>. This is because the mass monitor has an hourly random noise band of several micrograms.</li> <li>• If the mass monitor is reading large, negative numbers hour after hour, it is probably punching holes in the filter tape. These holes can be very small and hard to see. This is almost always caused by debris on the nozzle or vane. Clean the parts.</li> <li>• The real-time averages of the mass monitor are considerably noisier than the hourly measurements. These noise spikes may indicate negative concentrations unless the true concentrations are high.</li> <li>• The noise performance of the mass monitor may be audited. Met One Instruments supplies the BX-302 zero filter kit for auditing the zero readings of the mass monitor.</li> </ul>

<b>Problem:</b>	<b>The airflow won't regulate at the correct rate of 16.7 lpm.</b>
<b>Cause/Solution:</b>	<ul style="list-style-type: none"> <li>• This usually indicates that the air pump is losing vacuum capacity due to wear.</li> <li>• Check for leaks at the nozzle. This will often cause the inlet flow to be low even though the flow sensor is measuring the correct flow rate. This is because the flow sensor is downstream of the filter tape and nozzle. Clean the nozzle and vane.</li> <li>• Perform a flow calibration. If the flow regulates at the lower calibration point, but not the higher point, the pump is probably worn out or there is a leak.</li> <li>• The gray plastic pump mufflers used on the vacuum pump clogs up after several months. Replace it every six months.</li> <li>• Check the inlet and PM heads for obstructions.</li> </ul>

<b>Problem:</b>	<b>The mass monitor has flow leaks, even after cleaning the nozzle and vane.</b>
<b>Cause/Solution:</b>	<ul style="list-style-type: none"> <li>• The nozzle may be sticking. Verify that the nozzle up/down motion is smooth and complete. If the nozzle is sticky or gritty, it will not seal properly.</li> <li>• Check the O-rings on the sharp-cut cyclone (if used). These frequently leak.</li> <li>• Check for bad O-rings on the inlet receiver.</li> <li>• Check all of the push-in air fittings inside the mass monitor.</li> </ul>

<b>Problem:</b>	<b>The mass monitor will not pass the span membrane test.</b>
<b>Cause/Solution:</b>	<ul style="list-style-type: none"> <li>• This often just indicates the membrane foil surface is dirty or damaged. It can be cleaned with distilled water. Damaged membranes must be replaced.</li> <li>• If the membrane is in good condition, but the mass monitor fails span tests, then the most common problem is debris on the beta detector window. Carefully blow through the vane with canned dusting air to blow debris off of the detector window and try again.</li> <li>• If the detector is clean and the membrane is in good condition, then failed span tests can indicate that the detector is wearing out. Contact the Service Department.</li> </ul>

<b>Problem:</b>	<b>The clock settings are lost when the mass monitor is powered down.</b>
<b>Cause/Solution:</b>	<ul style="list-style-type: none"> <li>• There is a small coin cell battery inside the mass monitor that maintains the clock and other settings when the mass monitor is powered off. After several years the battery may need to be replaced if the clock resets when the mass monitor is powered off.</li> <li>• It is normal for the clock to drift as much as 2 minutes per month.</li> </ul>



## 6.11 Alarms

In the event a measured parameter or sequence is not within design specification, the BAM 1022 will generate an alarm. These alarms can be monitored via the alarm log, output files or the alarm relay. A list of alarms is detailed below.

An alarm is indicated and logged at the time it occurs. The resolution time is not recorded. See section 3.5 for an explanation of viewing alarms through the BAM 1022 panel display.

**Note:** If multiple errors occur in the same data period, the stored alarm code will be the sum of the two individual codes.

To determine which codes are being summed, note the largest code number that is less than the value stored. This will be the first code being summed. Subtract that from the stored value to determine the second code. Repeat this process until all codes are known. For example, if 264 is stored, the largest code beneath that value is 256. The difference between 264 and 256 is 8. This means the two codes are 256 and 8.

Code	Description	Cause
1	Tape Break	No tape movement was detected during the tape move process.
2	Beta Detector	The event occurs when the Beta detector count rate is less than 500 Hz during the sampling cycle.
4	Sensor Range	The event occurs when an analog sensor reading (AT, RH, BP, UPPER, LOWER, FT, FRH) is outside the designated limits.
8	Tape Advance	The event occurs when the pressure drop across the tape exceeded the Tape Advance Pressure setting.
16	Flow Failure	The event occurs when the sample flow is less than 1.0 SLPM for greater than 1 minute. The event occurs when the sample flow is +/-10% out of regulation for 1 minute. The event occurs when the sample flow is +/-5% out of regulation for 5 minutes.
32	Nozzle Failure	The event occurs when the nozzle failed to move and stop at the up or down position. The event will also will occur when the foil device is still inserted at start of operation.
64	Digital Link Failure	The event occurs when communication with the 597 sensor has ceased for greater than 10-seconds.
128	Power Failure	The event occurs for a power cycle or a micro-processor reset.
256	Short Sample	The event occurs when the first sample cycle is less than 1-hour.
512	Maintenance	The event occurs when the user stops normal operation.

## 6.12 Hardware Failure Screen

This screen is presented to the user when a hardware failure occurs with the type of alarm (Tape Break, Sensor Range, Flow Failure, Nozzle Failure, Digital Link Failure) indicated in red text. Pressing the grey ALARMS button will present the View Alarms screen. See section 3.5 for more information about viewing alarms.

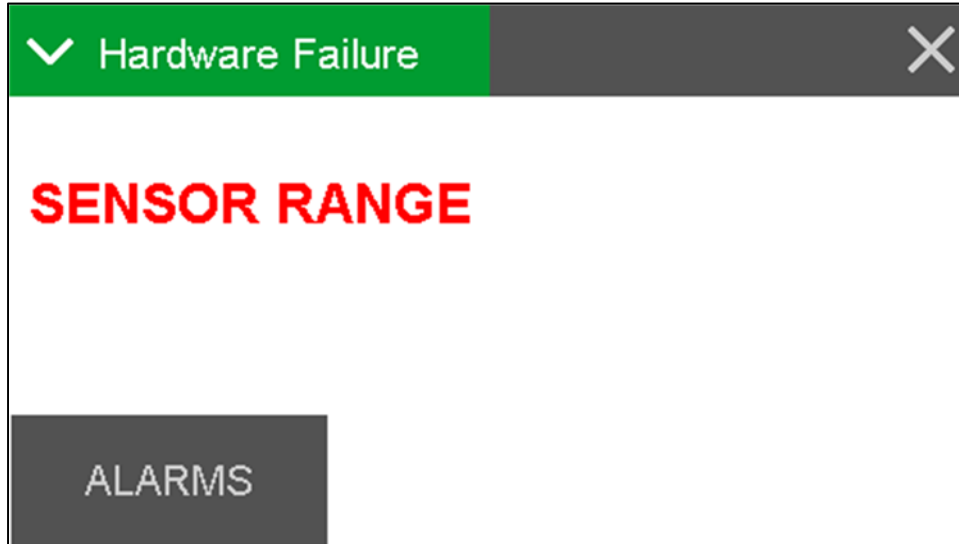

## 6.13 Sensor Out of Range Event

The sensor outside range alarm event occurs when one of the sensors listed in the table below is reading outside of its designated limit.

Each sensor, along with its limits, is shown in the following table. The Stop column indicates whether or not the error will cause the BAM 1022 to stop sampling.

Sensor	Minimum	Maximum	Stop
AT	-50	70	Yes
RH	0	100	No
BP	375	825	Yes
UPPER	228	818	Yes
LOWER	228	818	Yes
FT	-40	60	Yes
FRH	0	98.9	No
BOX	-40	60	No
BETA	500	20000	Yes

## **6.14 Alarm Relay**

There is one alarm relay on the BAM 1022 to indicate to an external device that an alarm has occurred. It is a normally open (NO) contact that closes whenever there is a pending alarm.

The short sample and tape advance alarms do not affect the alarm relay. See section 3.4.13 for testing details.

## 7 DATA COLLECTION AND COMMUNICATIONS

The BAM 1022 is capable of relaying information to and from external devices using analog outputs, digital inputs and outputs, RS-232 serial communications, USB serial, Ethernet and USB flash drive.

### 7.1 Analog & Digital I/O

Terminal connections on the rear panel of the BAM 1022 are available for communicating with data acquisitions system by means of analog and digital inputs and outputs.

The following is a detailed map of the terminal connections:



The 597 Digital Sensor connects to the External Ambient Sensor port.

The Digital Sensor 2 is not supported at this time.

The Alarm Relay output is rated for 1 A at 125 VAC or 60 VDC maximum.

Analog Inputs 1 and 2 are not supported at this time.

The Clock Sync input is rated for a dry contact closure at 17 mA or 0 – 5 VDC maximum capable of syncing 17 mA.

Analog Outputs 1 and 2 can be configured as either 0-1, 0-2.5, 0-5 VDC or 4-20 mA using the dip switches on the rear panel. Analog output 1 is the real-time concentration and output 2 is hourly concentration.

## 7.2 Clock Sync

The ISO IN allows an external device to synchronize the clock of the mass monitor to an external device. The Sync window is the one minute window from 59:30 (mm:ss) to 00:30. When the ISO IN is active during the Sync window the clock is reset to 00:00 (mm:ss).

The ISO IN must be active for greater than 1-second.

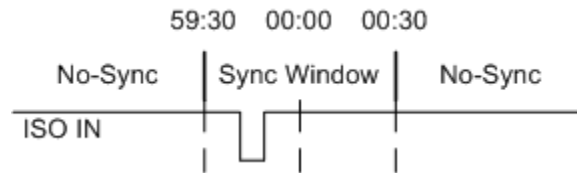

## 7.3 Transfer Data to USB Flash Drive

The BAM 1022 can copy data files directly to a user-supplied USB flash drive. This drive must be installed in the USB port located behind the front door, in the upper left corner of the tape transport. This USB port is not used for any other purpose.

Copy to USB Drive	
Days	99
Files	ALL
COPY	

Copy to USB Drive	
Status	COPY COMPLETE
Progress	100 %
Error	

1. Enter the OPERATE > TRANSFER DATA menu.
  - a. The Days field determines how many records you download. If you wish to change the number of days being copied, press the green bordered value box and the numerical entry keypad will be displayed. Enter the number of days between 001 and 999.
  - b. The FILES field determines whether you download all of the stored record types or only the user selected records. The USER files are ones which are used for all routine data collection purposes. The ALL option includes additional factory diagnostics files which are only used if data is being sent to Met One Instruments for factory support. The default setting is USER. If you need to change this field, press the green bordered value box and a list of the options available will be displayed. Tap the one you wish to use and it will be applied.
2. Locate the USB slot above the tape take up spool and insert a USB memory stick into it.
3. Press the grey COPY button to copy the selected data to the USB memory stick.
4. When the COPY COMPLETE message is displayed, remove the USB memory stick and close the front door of the BAM 1022.

## 7.4 Serial Communications

The BAM 1022 is able to communicate via serial commands using RS-232, USB Serial, or Ethernet. The monitor only allows one of these connections at a time. These connections allow users to both download data and operate the instrument

The default RS-232 settings are as follows:

Baud Rate: 9600  
Data Bits: 8  
Parity: None  
Stop Bits: 1  
Flow Control: None (should be set to CTS/RTS only when using Ethernet communications)

See 10 for details on configuring the IP address for Ethernet communications.

### 7.4.1 Terminal and Escape Commands Using the 7500 Protocol

The BAM 1022 supports a system of ASCII based terminal commands and Escape commands that can be used to manually collect data records or to remotely change some of the settings in the instrument through the serial port. These commands can be sent to the instrument through the “Direct Connect” terminal window tab in Comet (or through HyperTerminal or similar terminal programs). They can also be programmed into a digital data logger or similar automated system. Most of these functions are intended primarily for use with advanced or remote data collection systems, and are not usually used for routine data collection purposes. The Met One Instruments 7500 Protocol commands can be used in either Terminal Mode or Escape Command Mode.

#### 7.4.1.1 Terminal Mode

The BAM 1022 must be placed in Terminal Mode to use the Terminal Mode command set. From any command prompt (such as the terminal window in the Comet software), send three <cr> carriage returns (“Enter” key on a standard keyboard) through the serial port. The instrument will respond with an asterisk ( \* ) indicating that it is in Terminal Mode. Any terminal command may now be sent to the instrument.

Note: The instrument will time out of Terminal Mode after two minutes of serial port inactivity, and Terminal Mode will have to be reinitiated before more commands can be sent. Terminal Mode commands are echoed back to the terminal program.

#### 7.4.1.2 Escape Command Mode

Escape commands do not require the BAM 1022 to be in Terminal Mode. The command strings are slightly more complicated, but there are no timeout issues and data integrity is higher. This is better for machine-to-machine programming than Terminal Mode. In this case, the command string consists of an ASCII <Esc> (Escape) character (hex 1B), followed by the desired alphanumeric command, and then completed by a carriage return <cr> (Enter). Escape commands are not echoed back as they are entered. This means that characters that are typed will not be displayed in the software terminal window.

An example of entering an Escape command string to request only the last data record would be entered like this:

**<Esc>4<cr>**

The following table shows all of the available Terminal Mode and Escape commands. Commands with a "\$" symbol in the descriptions below require that the instrument password be sent before the command can be sent.

<b>COMMAND</b>	<b>DESCRIPTION</b>
1	Request settings report
2	Request All data report
3	Request New data report
4	Request Last data report
7	Request alarm event report
A	Network address command
C	Clear data log file – \$
D	Get/Set date part of the real time clock – \$
H	Help menu
T	Get/Set time part of the real time clock – \$
Z	Enable remote control – \$
AR	Get/Set Analog output range – \$
CO	Get/Set analog concentration offset – \$
CR	Get/Set analog concentration range – \$
CA	Clear alarm log file – \$
CU	Get/Set concentration units – \$
DS	Report data log channel descriptors
DT	Get/Set the date and time of the real time clock – \$
HS	Get/Set Ethernet flow control – \$
ID	Get/Set location ID or address – \$
OP	Get/Set operation state – \$
PR	Print report – 0-Settings, 1-Data, 2-Alarm
PW	Unlock protected and User commands (User setting) – \$
QH	Report Data Record Header
RQ	Report current readings without header
RV	Report Model/Part/Revision
SB	Get/Set baud rate – \$
SS	Get Met One serial number
ST	Get/Set sample time (data log period) – \$
TS	Get/Set timestamp mode – \$
ROP	Get/Set Operation state report – \$
SPW	Get/Set user password – \$
BKGD	Get/Set background offset – \$

FTSP      Get/Set filter temperature set point – \$  
 SPAN      Get/Set span audit – \$  
 RTPER     Get/Set real-time average period – \$  
 TPRES     Get/Set tape advance pressure – \$

The following table shows the commands associated with editable settings, along with the default value for the setting and the settable range.

DESCRIPTION	RANGE	DEFAULT	COMMAND
Location	1 – 999	1	ID
Data average period (Minutes)	0-1 MIN,1-5 MIN, 2-10 MIN,3-15 MIN, 4-30 MIN,5-1 HR	5-1 HR	ST
Real-time concentration period (Minutes)	15 – 60	30	RTPER
Serial port baud rate (BPS)	2-1200,3-2400, 4-4800,5-9600, 6-19200,7-38400, 8-57600,9-115200	5-9600	SB
Ethernet Flow Control	0-NONE,1-RTS/CTS	0-NONE	HS
Set User password (0 is no password)	0 – 9999	0	SPW
Analog output concentration range (ug/m <sup>3</sup> )	0-100 ug/m <sup>3</sup> , 1-200 ug/m <sup>3</sup> , 2-500 ug/m <sup>3</sup> , 3-1000 ug/m <sup>3</sup> , 4-2000 ug/m <sup>3</sup> , 5-5000 ug/m <sup>3</sup> , 6-10000 ug/m <sup>3</sup>	3-1000ug/m <sup>3</sup>	CR
Analog output concentration offset (ug/m <sup>3</sup> )	0--15 ug/m <sup>3</sup> , 1--10 ug/m <sup>3</sup> , 2--5 ug/m <sup>3</sup> , 3-0 ug/m <sup>3</sup> , 4-5 ug/m <sup>3</sup>	3-0 ug/m <sup>3</sup>	CO
Concentration units	0-ug/m <sup>3</sup> ,1- mg/m <sup>3</sup>	0-ug/m <sup>3</sup>	CU
DAC analog output range	0-0-1.0 V, 1-0-2.5 V, 2-0-5.0 V, 3-4-20 mA	2-0-5.0 V	AR
Hourly concentration data timestamp is either ENDING or BEGINNING hour only when Data Average Period is 1-HR.	0-ENDING, 1-BEGINNING	0-ENDING	TS
Concentration calibration offset (ug/m <sup>3</sup> )	-0.05 – 0.05	0.0	BKGD
Span audit verification	0.4 – 1.0	0.780	SPAN
Inlet heater FT set point (C)	0 – 50	45	FTSP
Tape advance pressure (mmHg)	50 – 350	250.0	TPRES
Unlock User commands			PW
Get mass monitor serial number			SS



## 7.5 Data Format & Example Reports

Samples of the more common reports and file downloads are shown in the following sections.

### 7.5.1 Settings Report

Issue the 1-command to output the Settings report.

```
BAM 1022 Settings Report
2014-06-02 17:12:04
```

```
    Firmware, 81650, R1.0.0
      CPLD, 81699, R0.1.0
Serial Number, A99999
  Location, 1
    Baud, 9600
  Flow Control, RTS/CTS
  Data Average, 1 MIN
RealTime Period, 30
  Tape Period, 1 HR
  Tape Pressure, 250
    K, 1.000
    Bkgd, 0.0000
    Usd, 0.285
  Audit Span, 0.780
  Conc Units, ug/m3
  USB Days, 1
  USB Files, USER
Analog Range 1, 0-1.0 V
Analog Range 2, 0-1.0 V
  Conc Range, 100 ug/m3
  Conc Offset, -15 ug/m3
Hourly Timestamp, ENDING
  FT Set Pt, 45.0
  FT P-Gain, 1.000
  FT I-Gain, 1.000
RealTime Alpha, 0.2316
RealTime Gamma, 0.1500

Name, Offset, Slope
FLOW, 0.000, 1.000
AT, 0.000
BP, 0.000
FT, 0.000
UPPER, 0.000
LOWER, 0.000
FRH, 0.000
```

```
DAC Cal 1, 0.0,0,1.0,0
DAC Cal 2, 0.0,0,1.0,0
```

### 7.5.2 User Data Log Report

Issue the 2, 3, or 4-command to output the User Data Log report.

Data Report  
 2014-05-14 17:00:02  
 Location, 123, I10220

Time, ConcRT (ug/m3) , ConcHR (ug/m3) , Flow (lpm) , AT (C) , RH (%) , BP (mmHg) , FT (C) , FRH (%) , Status  
 2014-05-13 19:17:00, +000024, +000026, +16.7, +026.9, 030, 734, +035.9, 014, 00000  
 2014-05-13 19:18:00, +000024, +000026, +16.7, +026.9, 030, 734, +035.9, 014, 00000

The user data is stored at the DATA AVERAGE PERIOD.

The CONCHR value is not averaged over the DATA AVERAGE PERIODS.

The number of fields is 10, the records size is 40 bytes.

The file size is 462 Kbytes. The number of data records is 11,827.

When the data file is full the oldest data event record is over written.

The table below shows the file duration for the DATA AVERAGE PERIODS.

<b>PERIOD (MIN)</b>	<b>FILE SIZE (DAYS)</b>	<b>FILE SIZE (MONTHS)</b>	<b>FILE SIZE (YEARS)</b>
1	8.2	0.3	0.0
5	41.1	1.4	0.1
10	82.1	2.7	0.2
15	123.2	4.1	0.3
30	246.4	8.2	0.7
60	492.8	16.4	1.4

### 7.5.3 Alarm Log Report

Issue the 7-command to output the Alarm Log report.

Alarm Report

2014-05-14 17:02:30

Location, 123, I10220

Time,Alarm

2014-05-14 17:02:30,TAPE BREAK,14

2014-05-14 17:02:30,BETA DETECTOR,500

2014-05-14 17:02:30,SENSOR RANGE,FLOW,-6.0

2014-05-14 17:02:30,SENSOR RANGE,AT,-50.0

2014-05-14 17:02:30,SENSOR RANGE,RH,0.0

2014-05-14 17:02:30,SENSOR RANGE,BP,375.0

2014-05-14 17:02:30,SENSOR RANGE,UPPER,228.0

2014-05-14 17:02:30,SENSOR RANGE,LOWER,228.0

2014-05-14 17:02:30,SENSOR RANGE,FT,0.0

2014-05-14 17:02:30,SENSOR RANGE,FRH,0.0

2014-05-14 17:02:30,SENSOR RANGE,BOX,0.0

2014-05-14 17:02:30,SENSOR RANGE,BETA,500.0

2014-05-14 17:02:30,SENSOR RANGE,FLOW,21.0

2014-05-14 17:02:30,SENSOR RANGE,AT,70.0

2014-05-14 17:02:30,SENSOR RANGE,RH,98.0

2014-05-14 17:02:30,SENSOR RANGE,BP,825.0

2014-05-14 17:02:30,SENSOR RANGE,UPPER,818.0

2014-05-14 17:02:30,SENSOR RANGE,LOWER,818.0

2014-05-14 17:02:30,SENSOR RANGE,FT,60.0

2014-05-14 17:02:30,SENSOR RANGE,FRH,98.0

2014-05-14 17:02:30,SENSOR RANGE,BOX,98.0

2014-05-14 17:02:30,SENSOR RANGE,BETA,20000.0

2014-05-14 17:02:30,TAPE ADVANCE,250.0

2014-05-14 17:02:30,FLOW FAILURE,0.0

2014-05-14 17:02:30,NOZZLE FAILURE,UP

2014-05-14 17:02:30,NOZZLE FAILURE,DOWN

2014-05-14 17:02:30,NOZZLE FAILURE,FOIL INSERT

2014-05-14 17:02:30,DIGITAL LINK DOWN

2014-05-14 17:02:30,POWER OUTAGE

2014-05-14 17:02:30,MAINTENANCE

The Alarm file can store 200 events.

When the Alarm file is full the oldest alarm event record is over written.

## 8 THEORY OF OPERATION

When beta rays emitted from the radioactive decay of  $^{14}\text{C}$  (carbon-14) interact with nearby matter they lose their energy and, in some cases, are absorbed by the matter. The process is known as beta-ray attenuation and is the principle of operation of the BAM 1022. When matter is placed between the radioactive  $^{14}\text{C}$  source and a device designed to detect beta rays, such as a photomultiplier tube with a scintillator, beta rays are absorbed and/or their energy diminished. This results in a reduction in the flux of beta rays detected. The magnitude of the reduction in detected beta rays is a function of the mass of the absorbing matter between the  $^{14}\text{C}$  beta source and the detector.

The beta ray flux passing through absorbing matter, such as dust deposited on a filter tape, decreases nearly exponentially with the mass through which they must pass. Equation 1 shows this relationship.

### Equation 1

$$M = \frac{S}{\mu} \ln \left( \frac{I_0}{I} \right)$$

In Equation 1,  $I$  is the measured beta ray intensity (counts per unit time), of the attenuated beta ray (dust laden filter tape),  $I_0$  is the measured beta ray intensity of the non-attenuated beta ray (clean filter tape),  $\mu$  is the absorption cross section of the material absorbing the beta rays ( $\text{cm}^2/\text{g}$ ), and  $S$  is spot size ( $\text{cm}^2$ ).

It is a *differential* measurement: what is being measured is the change in mass that occurs during the measurement cycle. For the BAM 1022 this change in mass is mainly caused by particulate deposition onto the filter tape during the sampling process and changes in air density above and below the filter tape during the measurement process caused by fluctuations in temperature and pressure. The BAM 1022 continuously monitors the air temperature and pressure above and below the filter tape, determines the changes in these measured parameters during the measurement cycle and then compensates for them in order to accurately determine mass deposition that occurs on the filter tape during the measurement event. The filter tape mass remains constant during the measurement process and therefore is not part of the differential mass.

What makes the beta attenuation method so successful and so versatile is that the absorption cross section “ $\mu$ ” is, to an excellent approximation, dependent only on mass (and not on chemical composition) for species likely to be sampled during ambient monitoring.

In order to convert sampled mass  $M(\text{mg})$  into aerosol concentration (instrument output), the following scaling factor is used:

### Equation 2

$$C \left( \frac{\text{mg}}{\text{m}^3} \right) = k \frac{M(\text{mg})}{Q(\text{m}^3)} + \text{BKGD} \left( \frac{\text{mg}}{\text{m}^3} \right)$$

The “ $k$ ” factor is determined experimentally *during the factory calibration process* by comparing the mass output of the BAM 1022 under test with the mass output of a transfer standard beta gauge that has been calibrated against gravimetrically traceable standard s. “ $Q$ ” is the sampled volume during the measurement. “BKGD” is the recorded mass value of the BAM 1022 under test in the absence of any mass accumulation and is determined in the field.



For the BAM 1022, the rate at which mass accumulates onto the filter tape during the measurement cycle determines the minimum usable time resolution of the device.

## 9 ACCESSORIES and PARTS





### 9.1 Consumables, Replacement Parts, and Accessories

The following parts are available from Met One for maintenance, replacement, service, and upgrades. If unsure about a part is required, please contact the Service department. Some of these parts require technical skills or special considerations before use or installation.

#### Consumables

Description	Part Number	Graphic
Filter Tape Roll, Glass Fiber, 30mm x 25m	460180	
Filter Tape Core Tube, Gray Plastic	8150	
Cotton-Tipped Applicators, nozzle cleaning, 100 pack Solon #362	995217	
Backup Battery, Lithium, Coin Cell (CR 1216)	390068	



#### Tools

Rubber Nozzle Seal Tool	7440	
Flow Inlet Adapter Kit (Leak Test Valve)	BX-305	
Zero Filter Calibration Kit, with valve Same as BX-305 but with 0.2 micron filter	BX-302	
Volumetric Flow Calibration Kit (BGI deltaCal™) Flow, Temp, and Pressure Reference Standards Met One recommended flow audit meter	BX-307	

### Flow System Components

Description	Part Number	Graphic
Flow Sensor, Mass, 0-20 LPM, Internal Assembly	<b>82056</b>	
Flow Controller Assembly	<b>80215</b>	
Filter RH Sensor, Replacement Only	<b>80212</b>	
Filter Temperature Sensor, Replacement Only	<b>80213</b>	
Flow Sensor Debris Filter Element	<b>580292</b>	
O-Ring, Nozzle, 1 required	<b>720066</b>	
O-Ring, Inlet Tube Receiver, 2 required	<b>720069</b>	
Pump Box Enclosure Assembly, 110 VAC	<b>82041</b>	
Replacement 110 VAC Medo Pump	<b>82044</b>	
Rebuild Kit for 110 VAC Medo Pump	<b>680839</b>	
Pump Box Enclosure Assembly, 220 VAC	<b>82041-1</b>	
Replacement 220 VAC Gast Pump	<b>82046</b>	
Pump Service Kit for 220 VAC Gast Pump	<b>680828</b>	

### Inlet Components

PM10 Inlet Head, EPA Specified	<b>BX-802</b>	
PM <sub>2.5</sub> Very Sharp Cut Cyclone	<b>BX-808</b>	
O-Ring Kit, for BX-808 Cyclone, set of 8	<b>720105</b>	
O-Ring Kit, for BX-802 PM10 Head, set of 3	<b>8965</b>	
Inlet Heater, 110 VAC	<b>80559</b>	
Inlet Heater, 220 VAC	<b>80559-1</b>	
Insulation Sleeve for Inlet Heater	<b>9123-2</b>	

### Meteorological Sensors

Combination Ambient Temperature and Barometric Pressure Sensor Standard Accessory	<b>597</b>	
Digital Signal Cable, 597 Sensor to BAM 1022	<b>81977</b>	

**Miscellaneous Accessories**

Tape Spool Cover, Replacement, Sold Individually	<b>9185</b>	
--	-------------	---

**Standard Shipping Accessory Kit (PN: 82055)**

Description	Part Number	Initial Qty.
AC Power Cable	<b>400100</b>	1
Serial Cable, DB9, M-F	<b>550065</b>	1
Filter Tape	<b>460180</b>	1
Fuse, 3.15	<b>590811</b>	2
Comet Software CD	<b>80248</b>	1
Grounding Cable	<b>9528</b>	1
Allen Wrench 5/64	<b>99300</b>	1
6" Applicator, Wooden, Cotton Tip, Pack of 10	<b>995217</b>	1
Mass Foil Set (includes zero and span tools)	<b>80307</b>	1
Rubber Nozzle Seal Tool	<b>7440</b>	1
Pipe Seal Assembly	<b>8119</b>	1



## 10 Ethernet Port Setup and Configuration

The Ethernet port must be configured with some drivers by the user. This section will cover assigning a static ip address to your device to allow users to connect to their device over their network.

### 10.1 Setting the Static IP Address of Your Device

This section covers how to assign your static ip to your device. These steps assume that someone (an IT person) has setup a static ip address, a network mask, and gateway that you can use to assign to the device. Follow the steps below to assign this information to your device.

1. Connect CAT5 Ethernet cable between local network and Ethernet connector on the wiring panel of the device.
2. Insert the supplied USB/Ethernet Driver CD (part 80328) into your PC. The following menu window should appear:

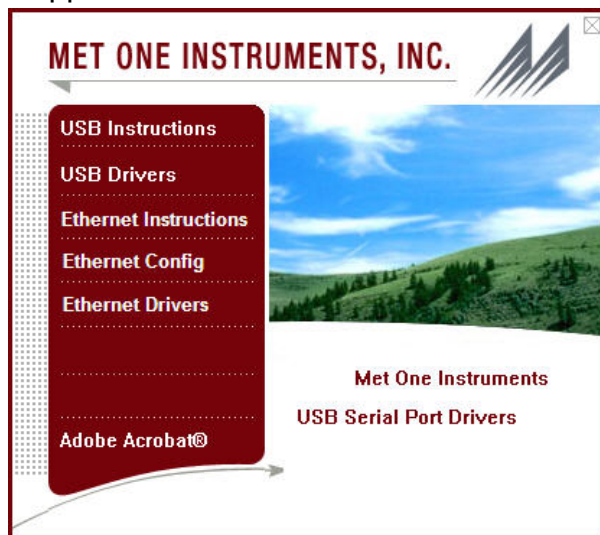

3. Click on the Ethernet Config button. The following screen will appear:

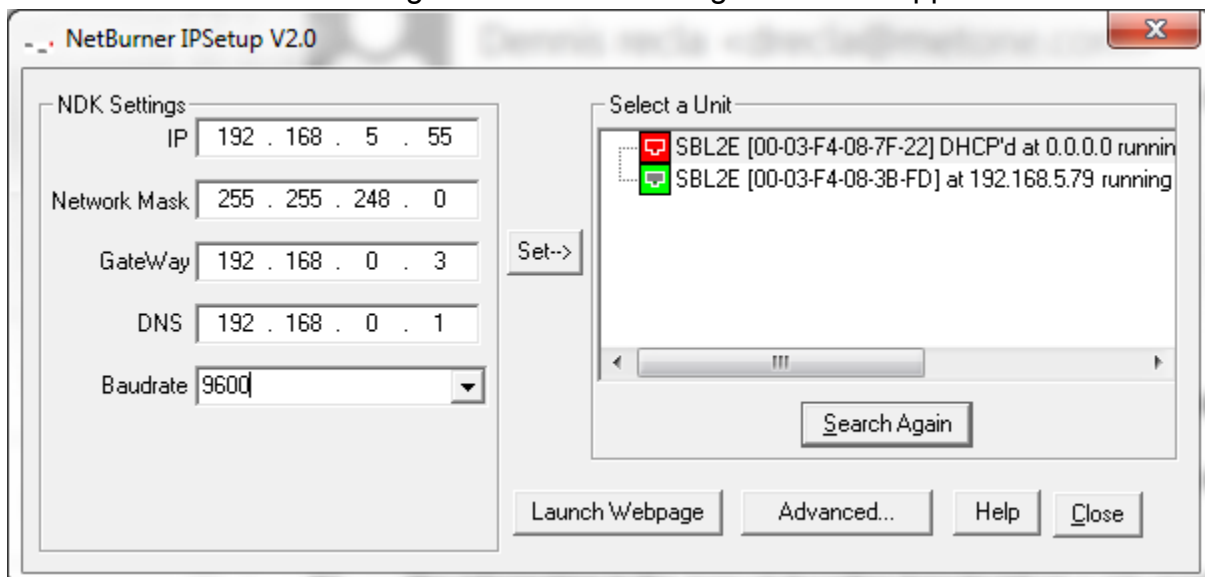

4. The “Select a Unit” box displays a list of available static IP addresses on the network. Units with a “DHCP” mean they need to be configured and units without the “DHCP’d” means they have already been configured and you shouldn’t change them unless you know where you are doing.
  - a. Generally, when setting the device up for the first time, it will have an ip address of 0.0.0.0 and will be displayed in red as shown in the screen shot above.
  - b. If your device isn’t showing up in the list, confirm that you have enabled Ethernet in the device’s setup screen (not all devices need this step).
5. Select from the unit list your device. It should be the ip address with a “DHCP’d” in it and an address of 0.0.0.0, because that unit is ready to be configured.
6. Type in your assigned static IP address in the IP window. Be sure to write this number down as you will need it later.
7. Type in a Network Mask in the Network Mask window, this may vary depending how your IT department has set up your network. Typical network mask is 255.255.255.0.
8. Set the gateway and DNS based on your company’s network settings.
9. Set the baud rate to the unit’s port baud rate. This can be adjusted in the device’s settings.
10. Select your device from the unit list and press the Set→ button to change the IP address of your device.
11. If the device disappeared from your list, press the search again button until it appears again with your newly assigned ip address.
12. Select the unit from the list and press the launch webpage button. This will launch the Netburner’s Ethernet configuration page.
13. At the top of the page, go to the Serial tab.

**Serial**

Data port settings (DEBUG defaults to port 0 if both are set to DEBUG):

	PORT 0	PORT 1
Data port settings (DEBUG defaults to port 0 if both are set to DEBUG):	RS-232	DEBUG
Data baud rate:	38400	38400
Custom baud rate:	0	0
Data bits:	8	8
Stop bits:	1	1
Data parity:	None	None
Flow control:	RTS/CTS	None
Allow AT commands:	<input checked="" type="checkbox"/>	<input checked="" type="checkbox"/>
AT attention command char:	43 (+)	43 (+)

14. For Port 0, set the data port to RS-232, set the baud rate to match your device’s baud rate, and the flow control to RTS/CTS.
15. For Port 1 set the dataport to DEBUG and match port 0 settings for the rest.
16. Press the ‘submit new settings’ button to save your changes. You should now be able to communicate with your device via Ethernet using your assigned static ip address and the set port number (default is 23).

17. To check the assigned port number, launch the Netburner Page and go to the Network tab. The Listening network port for Port 0 under incoming TCP Settings is where you can set the port number. For example, in the screen shot below the port is set to 10023.



[Network](#) | [Serial](#) | [GPIO](#) | [Password](#)

Network		
Device name for DHCP:	<input type="text" value="SBL2E-3AAF"/>	
Addressing mode:	<input type="text" value="Static"/>	
<hr/>		
<b>IP Settings</b>	<b>Static Settings</b>	<b>Current Values</b>
Device IP address:	<input type="text" value="192.168.5.29"/>	192.168.5.29
Device subnet mask:	<input type="text" value="255.255.248.0"/>	255.255.248.0
Device gateway:	<input type="text" value="192.168.0.3"/>	192.168.0.3
DNS server:	<input type="text" value="192.168.0.1"/>	192.168.0.1
Ethernet link:	<input type="text" value="Normal"/>	Physical power cycle required after change
<hr/>		
<b>Incoming TCP Settings</b>	<b>PORT 0</b>	<b>PORT 1</b>
Listen for incoming network connections:	<input checked="" type="checkbox"/>	<input checked="" type="checkbox"/>
Listening network port:	<input type="text" value="10023"/>	<input type="text" value="24"/>
Timeout and disconnect after this many seconds of inactivity:	<input type="text" value="60"/>	<input type="text" value="60"/>
Allow new connection if the existing connection has been idle for this many seconds:	<input type="text" value="30"/>	<input type="text" value="30"/>

## 10.2 Setting up a Virtual COM Port

A virtual COM Port allows users to designate a COM port for their existing Ethernet setup for a Met One device. This is not necessary to be able to talk to your device, this just creates an alternative method for connecting to your device if TCP/IP is not an option for some software applications. This section covers the drivers needed and the steps necessary to set up a virtual COM port for your device.

### 10.2.1 Installing Virtual COM Drivers



1. From the Drivers CD (shown above), click the Ethernet Drivers button. This will launch the Ethernet driver installation. If you downloaded the drivers from our website, run the VirtualCommPort-2.1.exe found in your zip file.
2. Press next to continue with the wizard.

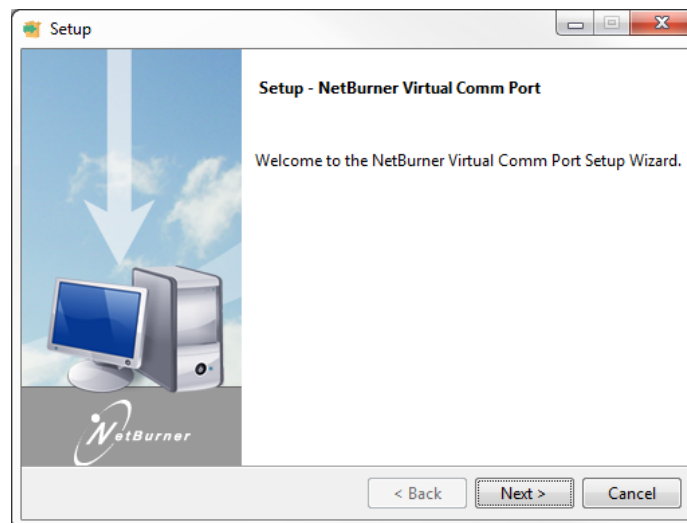

3. Select your own installation path or use the default path: C:\nburn\VirtualCommPort

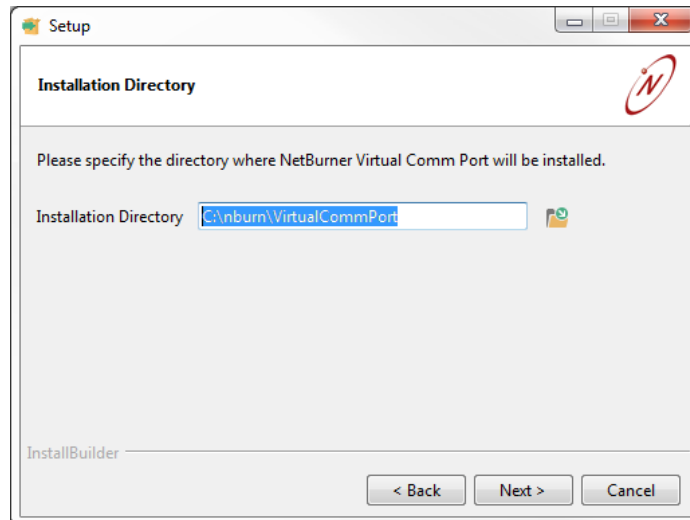

4. Select which operating system you are using.

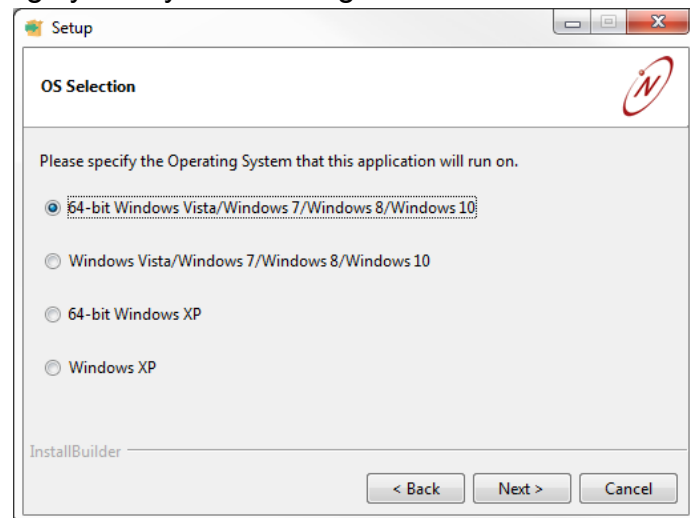

5. Press Next to finish installing the Ethernet drivers.

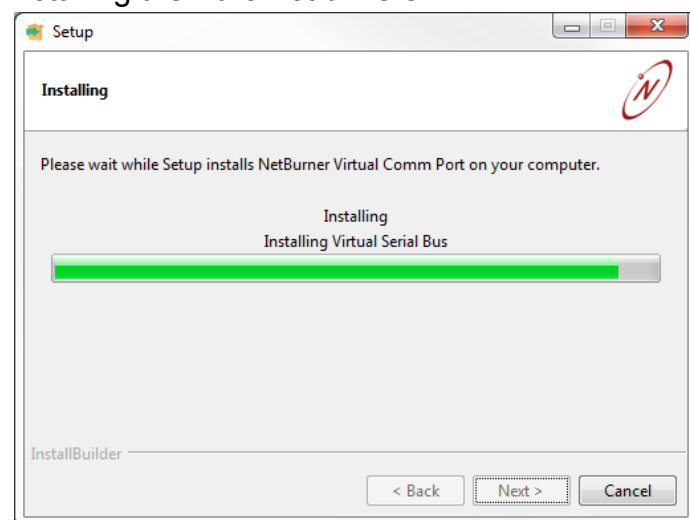

6. Wait for installation to finish and press finish to complete the installation. NOTE: A PC reboot may be required for the Ethernet drivers to function correctly. We recommend restarting your PC after this step.

## 10.2.2 Virtual COM Drivers Setup

1. After restarting your PC, head to your installation folder and open NBVirtualCommPort.exe

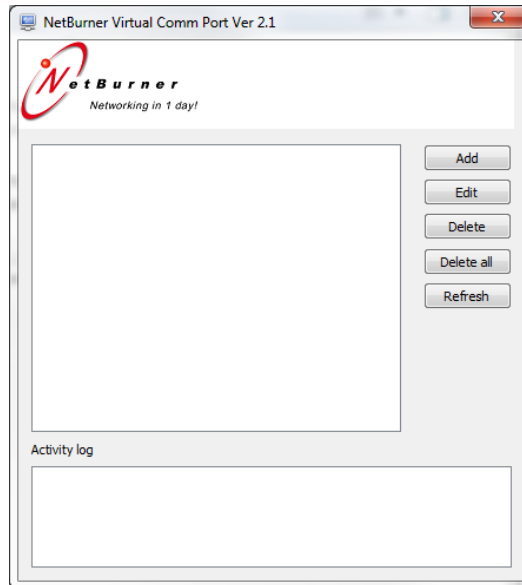

2. Press the Add button
3. Select Client connection for the connection type.

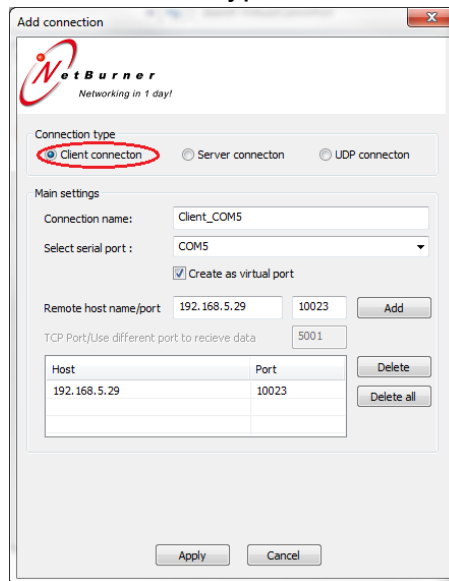

4. Under Select serial port, choose the COM port you would like to assign to your device.

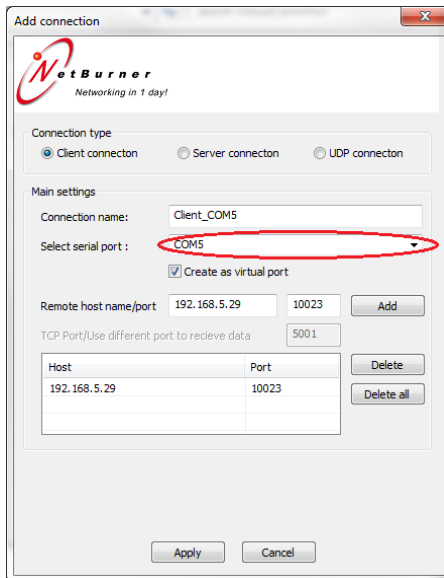

5. Under Connection name, enter a descriptive name for this virtual com port.

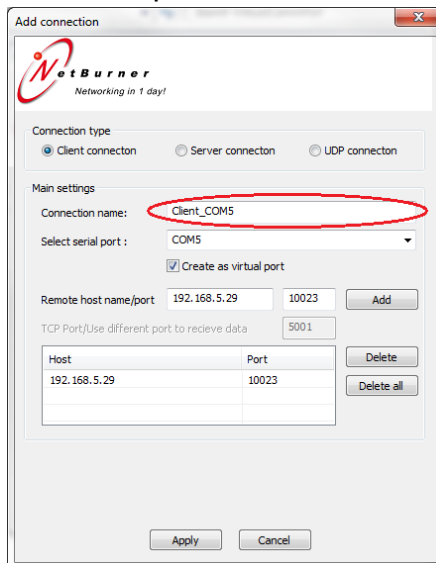

6. Make sure "Create as virtual port" is checked.

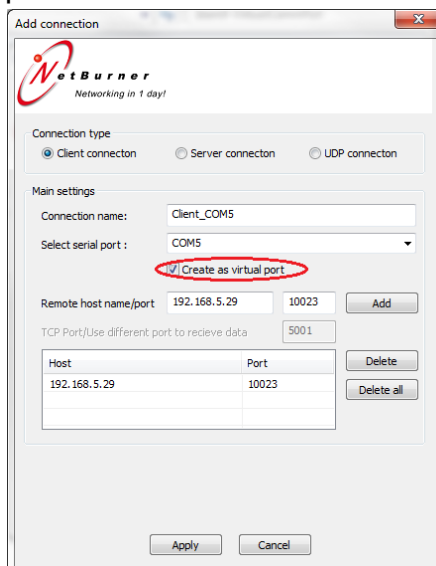

7. Enter your static ip address and port number into the Remote host name/port section.

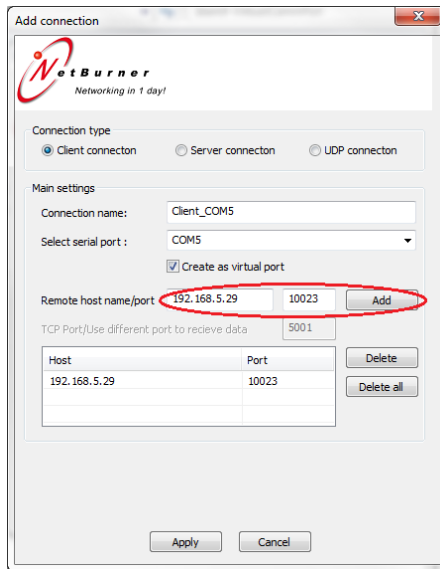

8. Press Add to add this TCP/IP address.
9. Press Apply to add this virtual COM port
10. Now your setting should be displayed on the main page of the program. You can use the refresh button on the right hand side to refresh the status of the virtual port. As you can see in the image below, it found my settings to be 38400 baud, no parity, 8 databits, and 1 stopping bit. After talking to my device, I was able to refresh and see the amount of data sent/received.

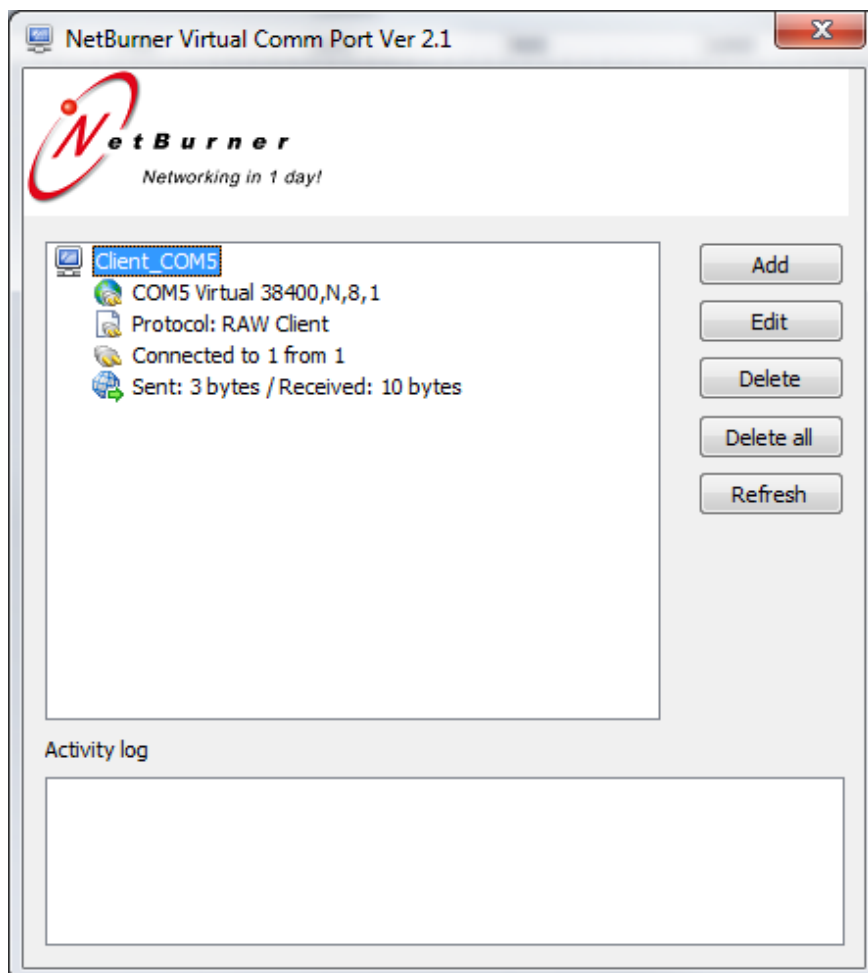



## APPENDIX A: ACRONYMS AND ABBREVIATIONS

### Acronyms and Abbreviations

The following is a list of acronyms and abbreviations that may be used within this operating manual:

ASTM	American Society for Testing and Materials
CFR	Code of Federal Regulations
CV	Coefficient of Variation
CTS	Calibration Transfer Standard
EPA	Environmental Protection Agency
FEM	Federal Equivalent Method
FRM	Federal Reference Method
HEPA	High-Efficiency Particulate Air
I/O	Inputs/Outputs
NAAQS	National Ambient Air Quality Standards
NIST	National Institute of Standards and Technology
PM	Particulate Matter
PM <sub>10</sub>	Particulate Matter $\leq 10 \mu\text{m}$
PM <sub>2.5</sub>	Particulate Matter $\leq 2.5 \mu\text{m}$
QA/QC	Quality Assurance/Quality Control
QA	Quality Assurance
QC	Quality Control
Qa	Actual Flow Rate
RH	Relative Humidity
SCC	Sharp Cut Cyclone
SOP	Standard Operating Procedure
SRM	Standard Reference Material
TEMP	Temperature
TSP	Total Suspended Particulate
VSCC	Very Sharp Cut Cyclone