



## Storage + Installation Guidelines

Teragren® Bamboo Butcher Block, Countertops and Table tops

 **Teragren.**

FINE BAMBOO FLOORING, PANELS & VENEER

# Bambooworking™ with Teragren® Countertops

Use these installation basics to supplement the complete Storage + Installation Guidelines that can be found at [www.teragren.com/ad/installation\\_countertops](http://www.teragren.com/ad/installation_countertops)

Familiarize yourself with the requirements for your installation before ordering countertops. Here you'll observe a few of the most common countertop installation situations and the requirements for each. For these examples a standard front overhang of 1 1/2" will be used.



*Vertical Grain Caramelized face with Chestnut strand core*



*Chestnut strand face with Vertical Grain Caramelized core*

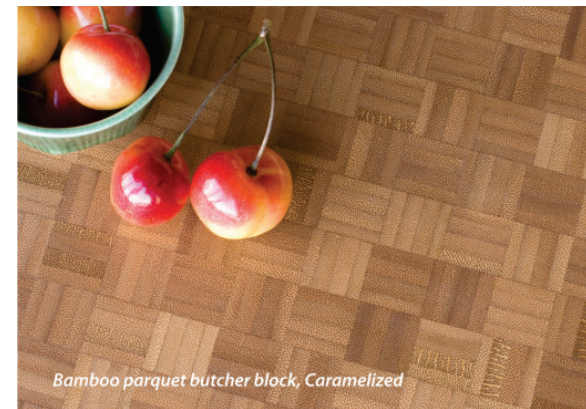

*Bamboo parquet butcher block, Caramelized*



# Common Installations - 1

In Example One there is a back splash along the entire length, a side splash to the left of the range, and an open area to the right of the sink where the countertop has a 1 1/2" overhang, just as the front does.

By joining the countertops as pictured, only two pieces of 96" countertop will be needed; each piece will be cut to a length of about 7 feet.

Teragren bamboo countertops, as with hardwood countertops, are traditionally joined together using a butt-joint, which saves a great deal of material that would be lost by using a miter-joint. In this example a large piece leftover from each countertop slab can be used to make a cutting board.

In Example Two, a kitchen island, there are cabinets beneath the countertop. The cabinet fronts are on the left and the countertop has a 1 1/2" overhang, as on the sides. On the back of these cabinets the countertop has a 12" overhang, which provides a counter for a seating area. This countertop is a single piece with no joints, which measures just under 36" x 48".

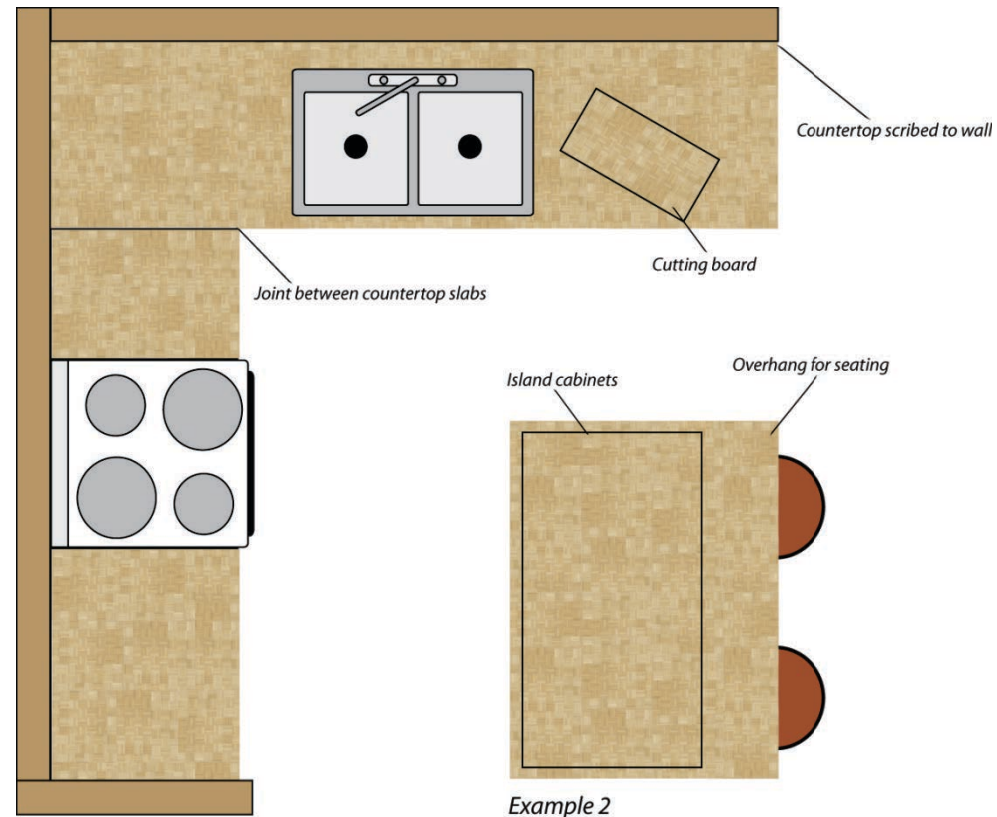

Example 1

Example 2



Butt-joint: Joint where two boards are glued edge to edge.

## Common Installations - 2

Example Three is essentially the same kitchen with a peninsula on the right. This third slab of butcher block, which is approximately 7 feet long, is 36" wide instead of the 30" that the other two are. An 11" wide piece of countertop is mounted higher to provide a raised seating area. Two butt-joints ensure enough material is left over for a cutting board.

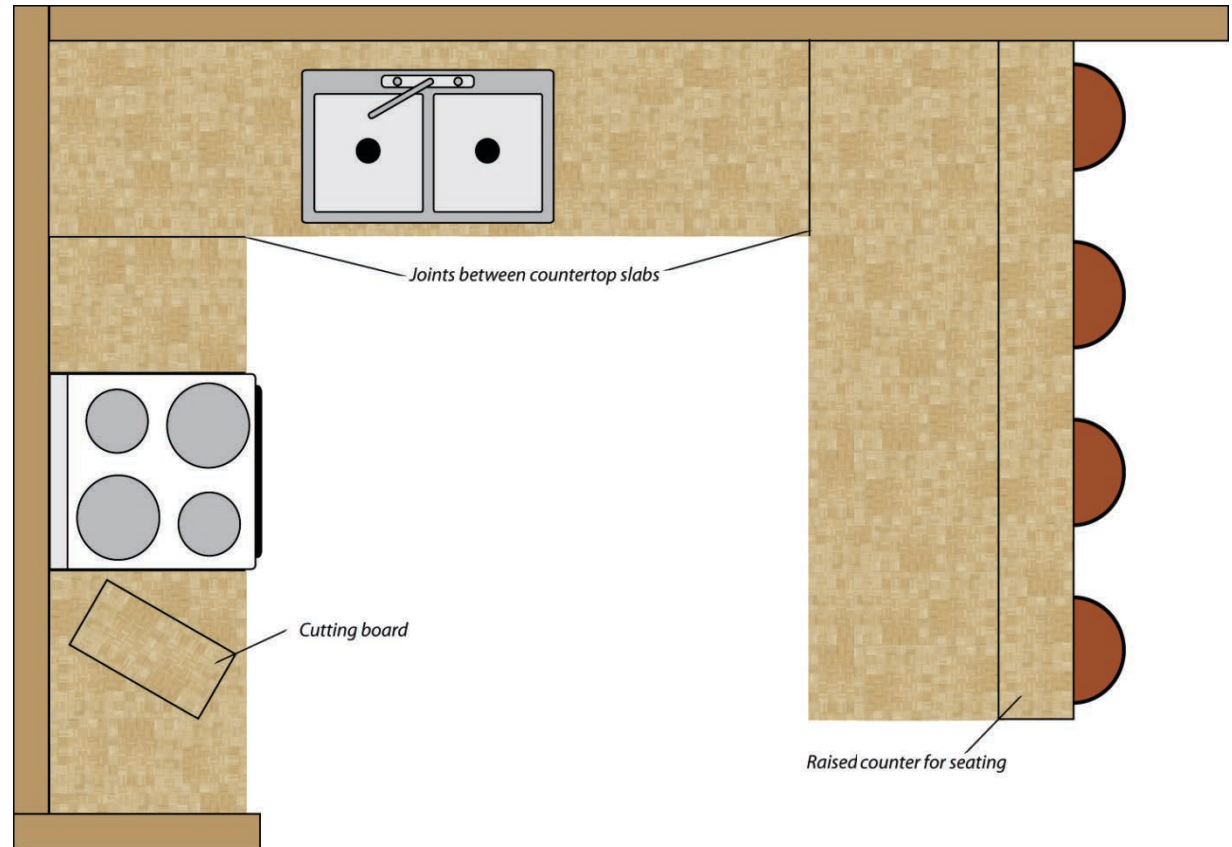

Example 3

# Box Construction

The three most common types of cabinet box construction are No Top with corner blocks, No Top with front and back stretchers, and Solid Top. Each will require different preparations for installation of countertops.

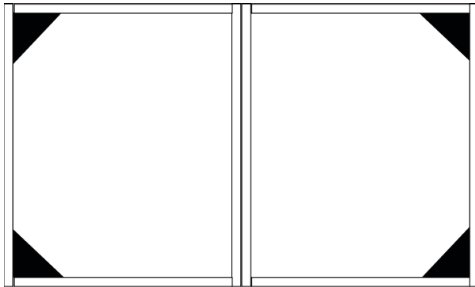

No Top—Corner Blocks

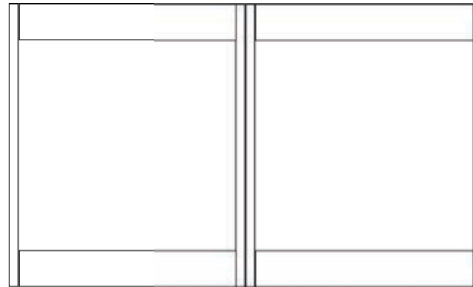
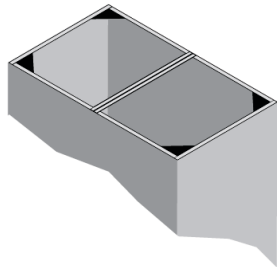

No Top—Stretchers

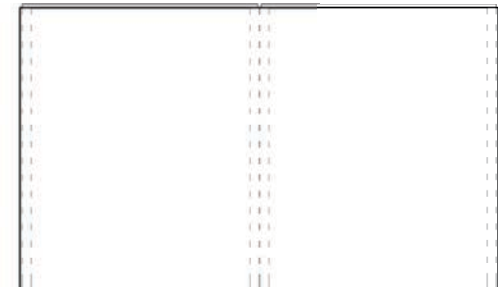
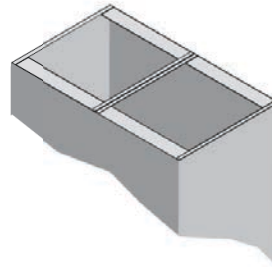

Solid Top

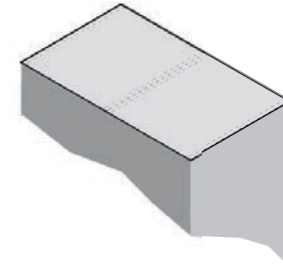

# Templates

Most countertop installations require the use of a template. Templates are used to determine what size countertop to order and to ensure proper fit before cutting the countertop.

Templates can be made of cardboard, plywood, hardboard, or a combination of these materials. Shop-grade plywood or hardboards are inexpensive and the use of them greatly aids in a successful countertop installation without costly mistakes.

Some manufacturers, such as those of sinks and stoves, supply cut-out templates along with instructions for installing. Use these paper templates along with one of plywood or hardboard. They can then be placed over the run of cabinets to verify that the cut-out has been precisely fabricated.

In the diagram the countertop in the desk area reveals where the countertop meets the walls before the back splash is installed. As straight as the walls appear to be, they actually bow in and out. You must ensure that there is enough room in these areas to allow for the expansion and contraction of the countertop when you scribe it to the wall.

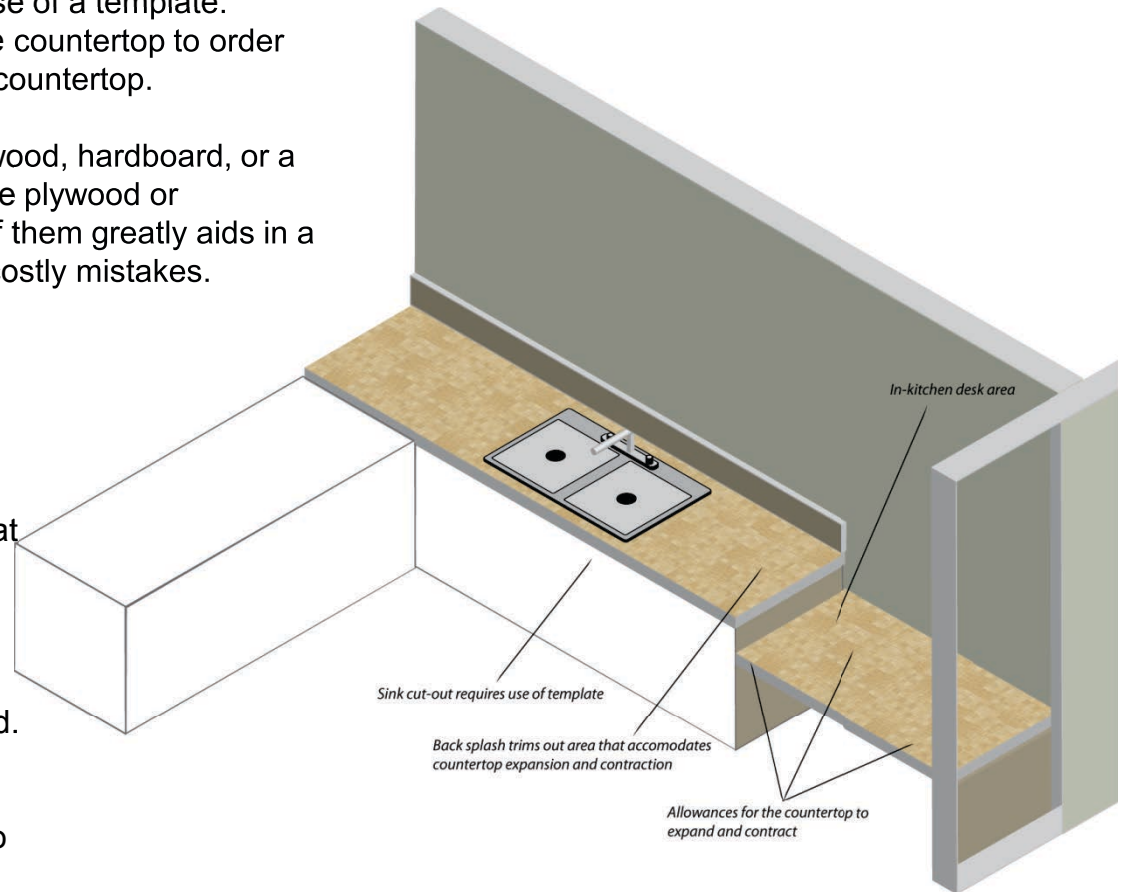

Scribe: Transferring the contour of one surface to another.



# Joining Countertops

Several fasteners on the market can be used to hold two pieces of countertop together at the butt-joint, but not all are recommended for 1 1/2" thick material. In all cases, apply glue to each of the edges being joined together and employ adequate pressure to the pieces until the glue cures. Most mechanical fasteners for countertops will act as clamps while the glue cures.

In this example we are using a plate joiner with a 4" blade to cut crescent shaped slots in the edges of our countertop. They will be joined together using wood biscuits. Slots will be cut registering the plate joiner both from the top and the bottom of the countertop. Either a PVA (polyvinyl acetate) or aliphatic resin (yellow) glue can be used to adhere the pieces together. Glue is applied to both edges and in the biscuit slots.

In some installations, such as those where the two pieces of countertop need to fit between walls, it may be necessary to join the countertop pieces together at the time of installation.

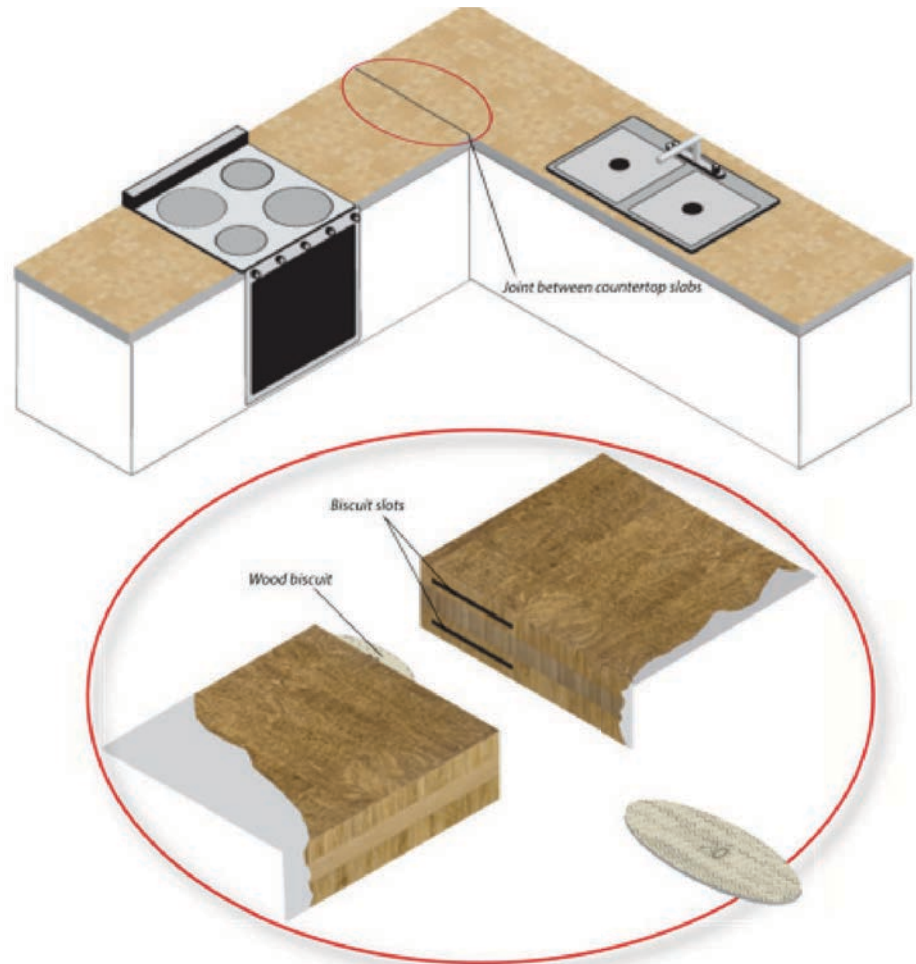

**Biscuit:** A small oval-shaped, wood disc that is inserted into the slot created by a plate joiner. Glue is applied to the slot and surface of the biscuit to secure the sections that will be joined together.

## Scribe Detail

A plan view detail reveals that the countertop touches the wall in some areas and is held out from the wall in others. Countertops will expand and contract, like any hardwood, as much as one-half inch. Scribing the countertop to the shape of the wall ensures that the countertop is allowed to move and that the back splash or architectural molding used at the wall can properly trim the area.

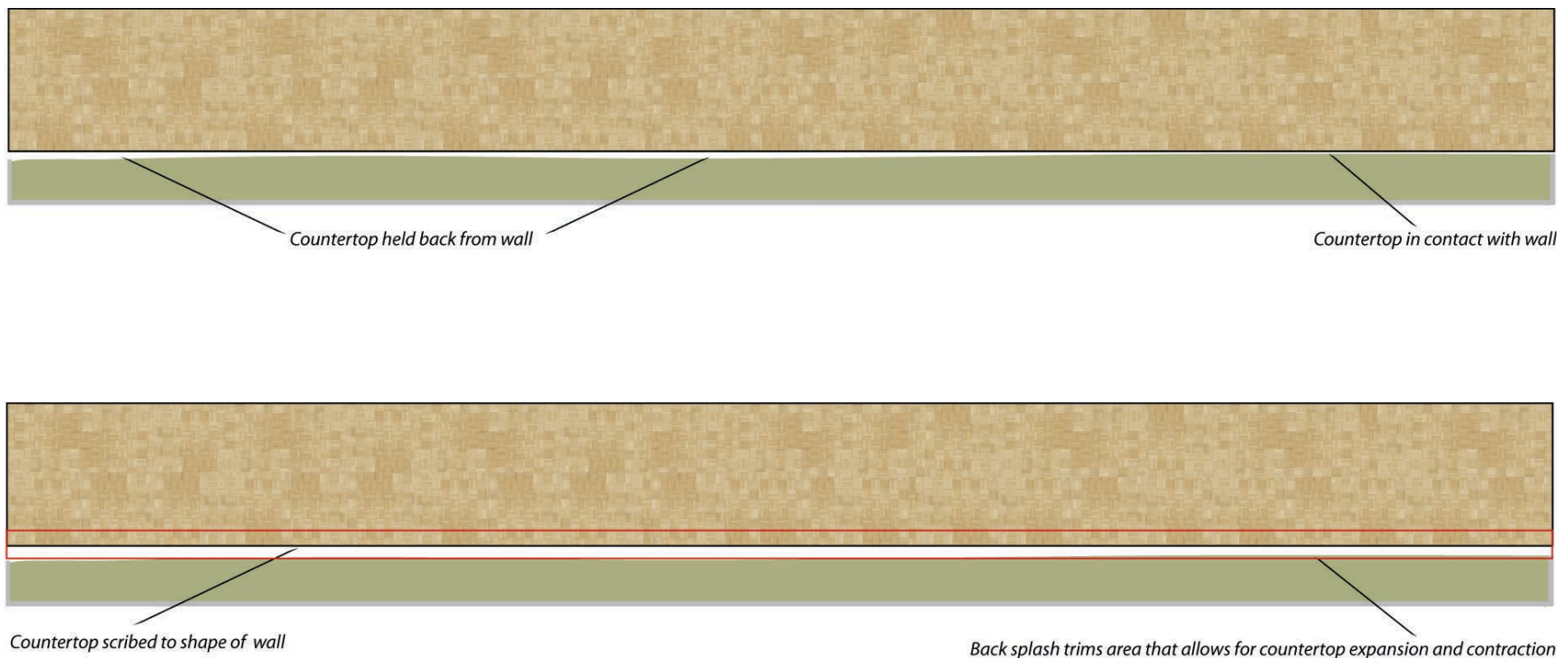

Plan view: A drawing that represents the top view or horizontal section such as a structure or layout of a floor.



# Attaching the countertop - 1

Once the countertop has been sized, scribed, and test-fitted, it is ready to be installed. A crucial element of the installation is allowing for the expansion and contraction of the countertop. Larger slabs may expand or contract as much as one-half inch. The larger the slab, the more it will expand and contract.

It is imperative that oversized holes are used where the countertop will be fastened to the cabinets — minimum 3/8" diameter. The countertop should be securely fastened through these holes using the appropriate length screw or lag bolt. Fender washers over the pilot holes on the underside of the countertop are required for a good installation.

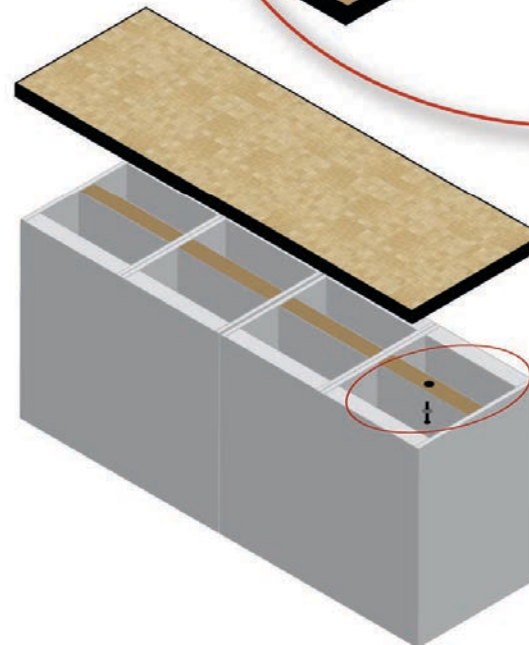
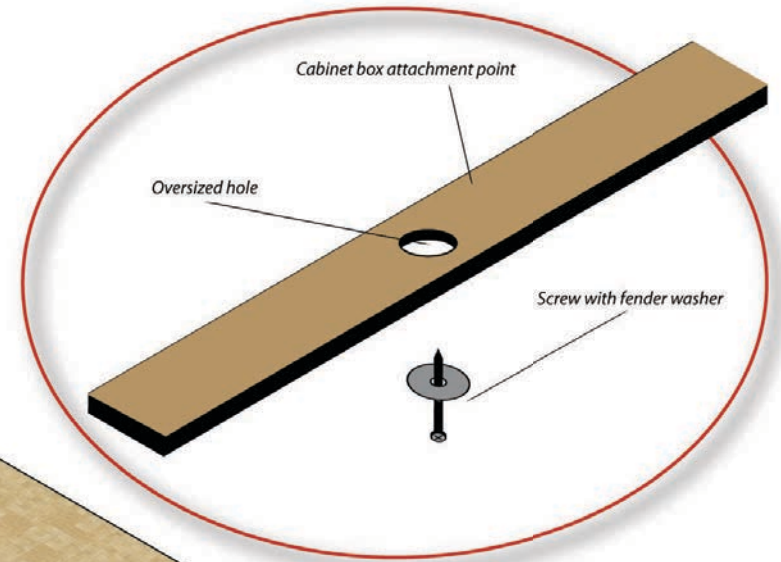

Do not over tighten the fasteners as this will limit the natural movement of the countertop. Do not use an adhesive caulk to set the countertop.



**Fender washer:** A washer with a greater outside diameter that helps spread the load of the fastener.

**Pilot hole:** A small hole that is drilled for the purpose of guiding a screw into your workpiece and to avoid splitting the material.

## Attaching the countertop - 2

Each type of cabinet box construction has a different method of attachment:

- 1) When the corner blocks are made of wood and securely attached to the box, drill an oversized hole in each block for attaching the countertop. If additional attachment or support is desired, wood strips may be added (see Example Three).
- 2) When there are no corner blocks or when the corner blocks are made of plastic and unsuitable as attachment points, attach several angle irons with oversized holes. Ensure that there is always an angle iron as close as possible to each corner.
- 3) Some boxes will have stretchers in both the front and back of the box instead of corner blocks or a solid top. Drill the oversized holes in each corner, as pictured. If additional attachment or support is desired, use wood strips with oversized holes.
- 4) If the box has a solid top it will be necessary to attach 1/8" thick spacers to the top of the box in the areas where the holes are to be drilled. These spacers should also be placed at approximately every 12" in-between to prevent the countertop from sagging between the attachment points.

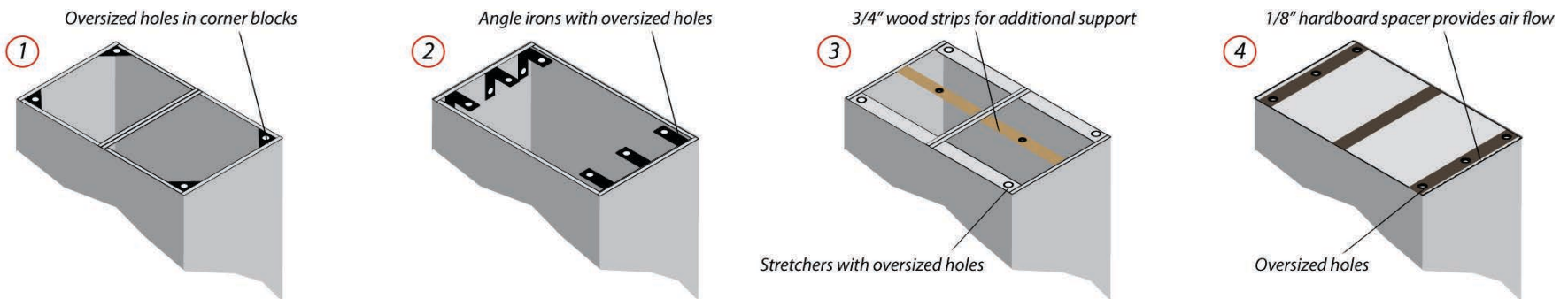

When drilling the oversized holes, do so from the backside using a backer board to avoid tearing out the top side. When attaching the countertop, apply downward pressure on the countertop in the area where the fastener is being driven to ease the process of pulling the countertop tight to the cabinet top.

# Countertop overhangs

The examples of common countertop installations all had countertop overhangs. The cantilevered cabinet or island countertop installations must have brace support. A maximum of 6" overhang is recommended without support. Many styles and sizes are available, each with specific weight loads. If you use brace supports, you may have to enlarge the mounting holes where they are attached to the underside of the countertop. This ensures that the natural movement of the countertop is not restricted.

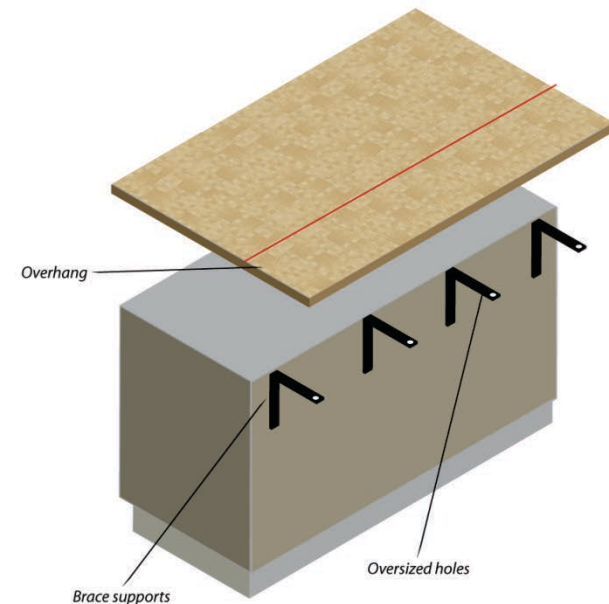
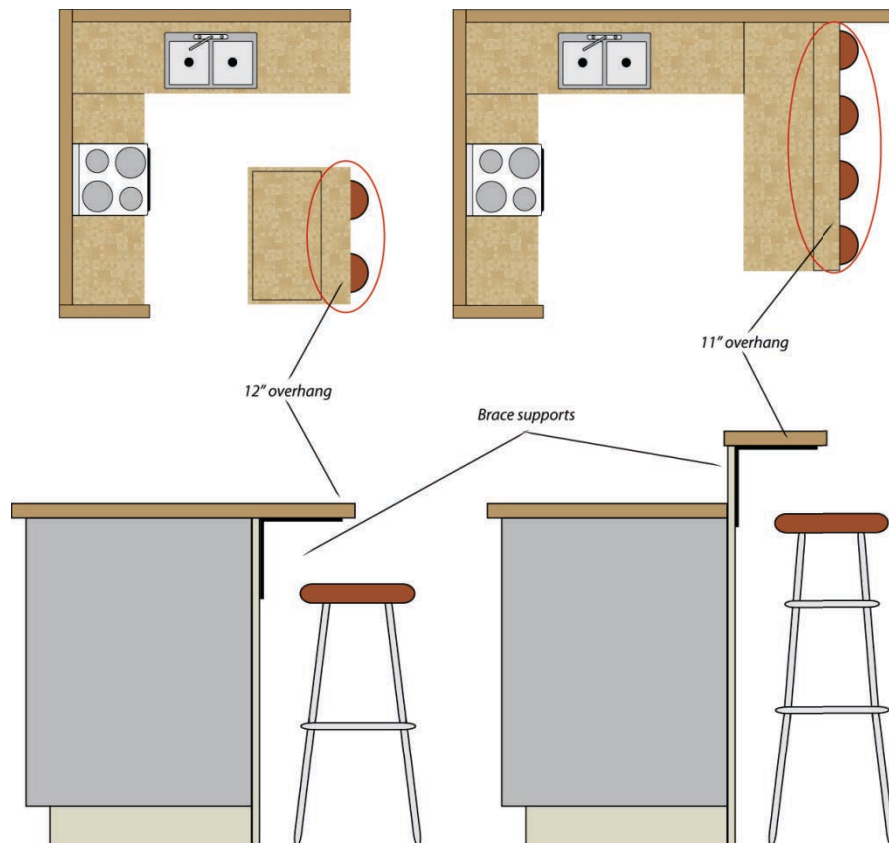



# Finishing

All Teragren countertops are available prefinished with a food-safe mineral oil/beeswax finish. Bamboo takes sealers and finishes very well; the same rules for finishing solid wood apply. Countertops are also available unfinished.

Different finishes offer varying degrees of protection, durability, ease of application, and protection. Follow manufacturer's instructions, and be sure to test adhesion quality and aesthetics of finishes on a piece of countertop cut-off before beginning your full-scale project.



Mineral Oil is a petroleum-based, non-drying oil that has long been used as a penetrating finish for wood utensils and food preparation surfaces. Mineral oil remains safe throughout its life. As a kitchen sealer, traditional mineral oil is both food and environmentally safe. To prevent drying, re-oiling is required maintenance but its frequency depends upon environment and use.

Butcher Block Oils – There are many commercial blends available, most are designed to be food-safe and help condition the bamboo surface. The mixtures may include blends of mineral oil, Tung oil, linseed oil and wax.

Vegetable Oils (e.g., olive, corn, peanut, safflower) are edible and sometimes used to finish wood utensils. However, these oils run the risk of going rancid and can be a health issue.

Baby oil should not be used because it contains ingredients that should not come into contact with food.



All surfaces need to be finished, including edges, ends, cut-outs and bottom.

# Closing

Thank you for your interest in Teragren countertops. To view the complete Storage + Installation Guidelines go to [www.teragren.com/ad/installation\\_countertops](http://www.teragren.com/ad/installation_countertops). For more product information go to [www.teragren.com/products\\_countertops](http://www.teragren.com/products_countertops) or telephone 800.929.6333.

