

EasyStand[®] Bantam

Y5500 Medium
Assembly Manual



Please ensure the Assembly Manual stays with the unit at all times.

SYMBOL/LABEL LEGEND



CAUTION/WARNING/ATTENTION



TEMPERATURE



TYPE BF APPLIED PART



DATE OF MANUFACTURE



PINCHPOINT



SEE INSTRUCTIONS FOR USE

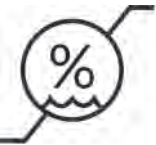

HUMIDITY

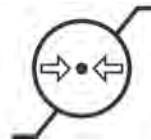

ATMOSPHERIC PRESSURE

SN

SERIAL NUMBER



MANUFACTURER

CE

CONFORMITÉ EUROPÉENNE

Rx only

PRESCRIPTION ONLY

MD

MEDICAL DEVICE



POTENTIALLY HOT SURFACE

Accessible surfaces which may exceed 105°F/41°C and could be a hazard to persons with skin damage or not having sensation.



Waste of electrical and electronic equipment must not be disposed as unsorted municipal waste. It must be collected separately, and must be disposed as per local regulations. Contact your authorized representative for information concerning the decommissioning of your equipment.

CERTIFICATION LABEL/UNIQUE DEVICE IDENTIFICATION LABEL

Manufacturer: Altimate Medical, Inc 262 West First Street Morton, MN 56270 507-697-6393	CE	MD	2021	
SN 0000000000				
00000000000000000000				
Model: Height Range: Max. Weight Limit:	Approx. Max. Mass of Unit & Weight Limit: 0000			

Serial Number

SN 0000000000

Item Number
Item Description

Model:
Height Range:
Max. Weight Limit:

Approx. Max. Mass of Unit
& Weight Limit: 0000

Unique Identifier

00000000000000000000

Table of Contents

Assembly	1
Options & Parts Detail	15

Date Purchased _____ Serial # _____

Contact Altimate Medical for any information required prior to purchase. This owner's manual along with other information is freely available by request or by downloading from easystand.com.

Assembly

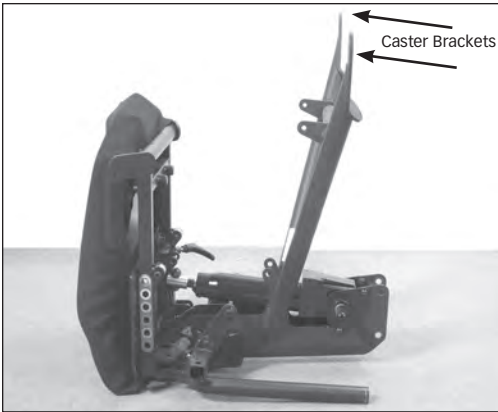

1. Remove all parts from each box and remove all packaging.

Position the base of the unit as shown to install the casters on to the caster brackets.

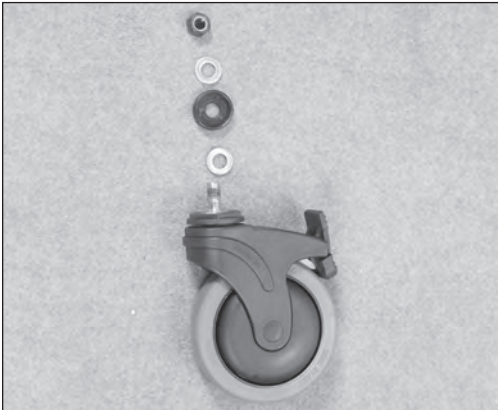

2. Remove the hardware on both casters and set out as shown. This is how the hardware will be assembled. The casters are supplied with a locking compound pre-applied to the threaded stem. Do not remove this material, it is important to prevent the casters from loosening over time. Make sure the caster is in the lock position as shown.



3. Place metal washer onto the stud of the caster.

4. Place the caster onto the caster bracket hole as shown.

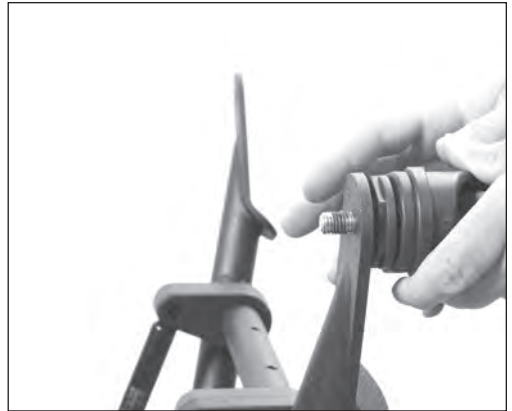

5A. Place the black cupped washer onto the caster stud with the flat part on the caster bracket.



5B. Place the second metal washer into the black washer on the caster stud.



6. Making sure the caster is in the locked position, place the lock nut onto the caster stud and tighten securely using provided wrench.





7. Place black cap onto the unit to cover hardware.

Repeat these steps for installation of the second rear caster.

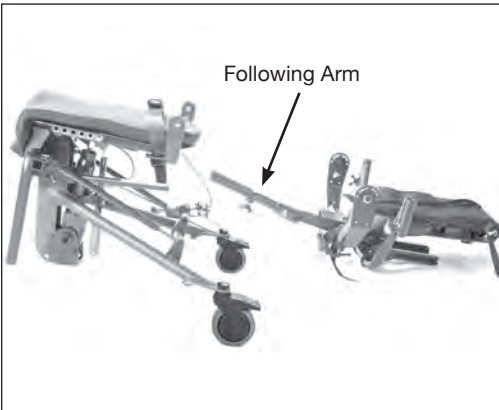

8. With assistance, place the base unit as shown, if the back option was **NOT** ordered, skip to step #21. Place the back as shown and place the following arm as shown.

Place the controller and hand pendant on the right hand side of the unit keeping the cables clear of the following arm as shown below.



9A. Remove the screw from the following arm and set the screw aside. You will need this later.

9B. On the following arm, turn the knob all the way loose, flip the gray tab of the knob fully open until it clicks open.

10. With assistance, insert the following arm onto the tube with the color strips on the unit until the red color setting is reached on the following arm indicator area knotch.

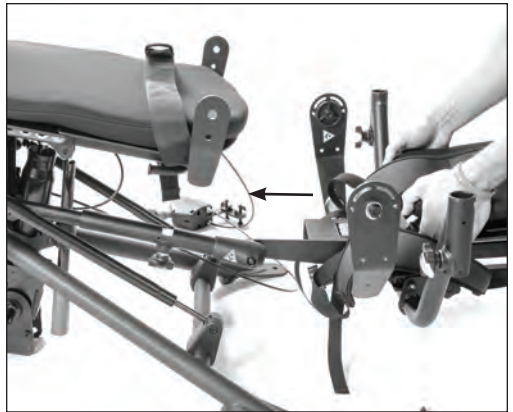
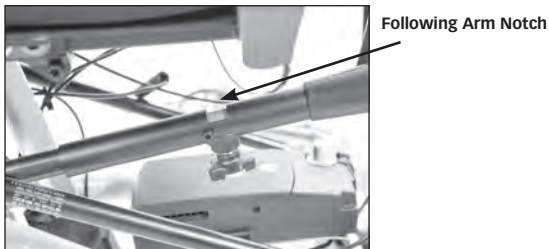

11. Install the screw that was removed onto the following arm and tighten securely. Flip the gray tab closed and tighten knob securely.



12. Remove a bolt, wagon wheel plastic washer, metal washer and nut from the parts bag. These will be used on the hip pivot.

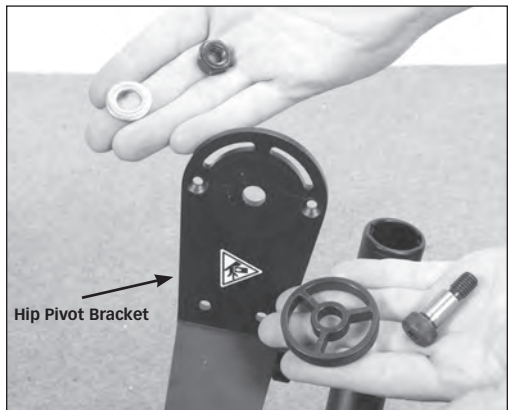



13. With assistance, position the back in the slot on the seat as shown.



14. Line up the holes and place the wagon wheel plastic washer between the hip pivot bracket and the slot on the seat, insert bolt from the inside of the unit.

Repeat these steps for the other side of the unit.



15. Place the metal washer and lock nut onto the bolt.

16. Using an allen wrench and the wrench from the toolkit, tighten the bolt and lock nut **snug**. **Do not overtighten.**

Repeat steps for the other side of the unit.



17. If the Pow'r Up Lift option was ordered, remove the protective packaging from the hand pendent.

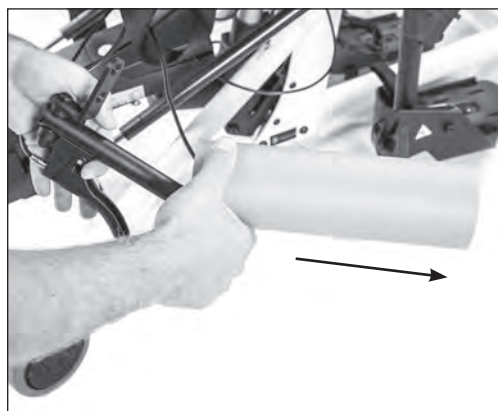

18. Remove the 2 nuts and 2 bolts from the hip pivot bracket.



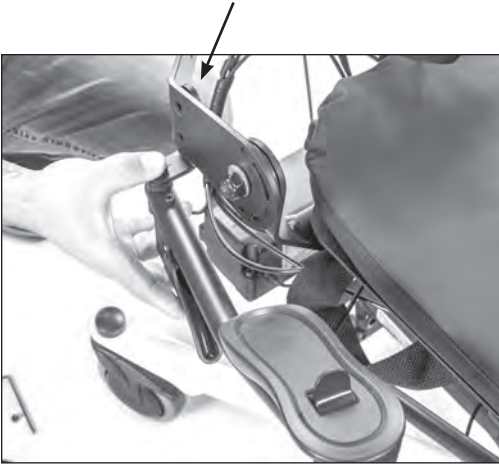

19. Place controller bracket onto the inside of the hip pivot bracket as shown

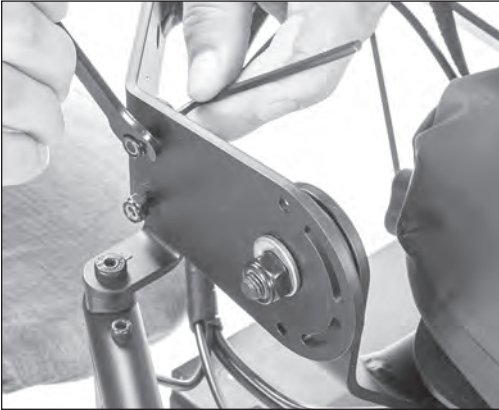

20. Insert 2 bolts and 2 nuts and tighten securely.



21A. Remove one of the covers for the hip pivot from the parts bag. Remove the 3 flat head screws from the inside of the cover. Place cover on the hip pivot. Make sure the EasyStand label is **not** upside down.

21B. Replace the 3 flat head screws tighten securely.

Repeat steps for the other cover.

22. Making sure casters are locked, with assistance, position unit as shown. Remove styrofoam from inside of the unit.



23. Remove all 4 bolts and lock washers from the front wheel assembly.



24. With the openings on the bottom of the frame facing down, place the wheel assembly into the seat assembly.





25. While supporting the front wheel assembly, using the 4 bolts and lock washers that were removed from the front wheel assembly, insert and start the 2 top bolts into the base and wheel assembly, then insert and start the 2 lower bolts, making sure to start all 4 bolts before tightening securely.

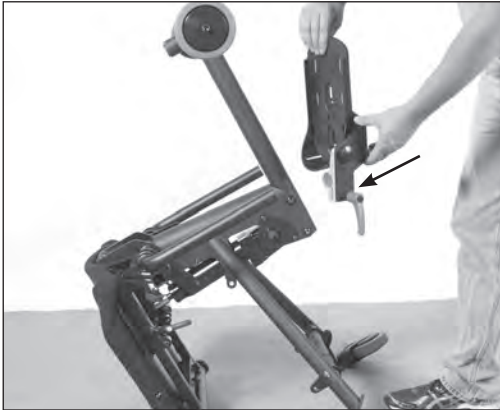

26. Loosen ratchet handle and place both foot plates on the unit, with the ratchet handle to the outside of the unit.



27A. If the Supine option was ordered, place the unit back onto its wheels. Locate the bolts with the covered washers and nuts on the back left handed side of the unit.

27B. Support the covered washer and remove only the nuts. Place the controller bracket onto the bolts.

If the Supine option was not ordered skip to step #30.

28. Place nuts onto bolts, remove nut caps. Tighten nuts securely and replace caps.



29A. Run the cables inside the adjustment wheel. Insert tie strap into hole

Note: Tie Strap will be in a bag on the controller.

29B. Do the same for the other side. Line cable clip up with hole on unit. Insert tie strap and tighten. Trim excessive strap and turn cut end inward.

Do not twist cables when installing controller.

Adjustment Wheel

For controller usage see pg. 23 in the Instructions For Use manual.



30. If the optional Shadow Tray was ordered, place the tray upside down as shown. Flip the chrome arms as shown, remove 4 bolts from bottom of the tray. Place arm brackets onto tray and line up holes in arm bracket with holes on the tray. Insert 4 bolts and tighten securely.

If the optional Swing-Away Tray was ordered skip to step 32.

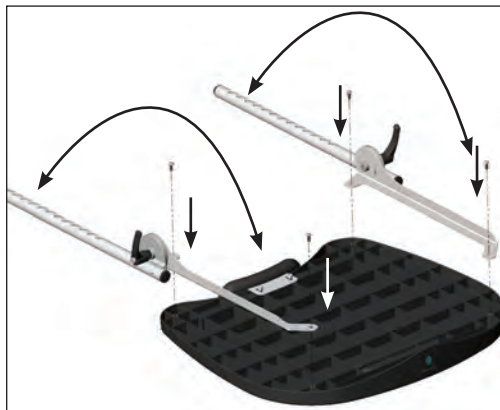

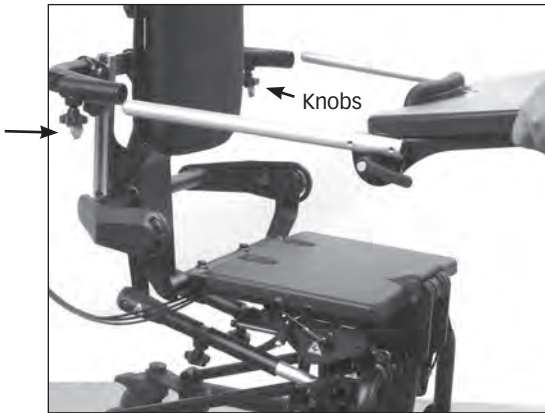

31. Lock the casters, loosen the knobs on the tray receiver all the way, then flip open gray tabs until it clicks. Insert the two tray arms into the tray bracket on the bottom of the tray as shown.

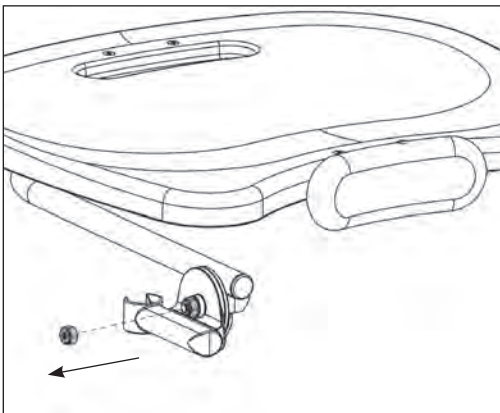

32. If the swing away shadow tray was ordered, using a wrench, remove the nut from the bolt on the tray arm and discard the nut. Make sure all other hardware stays on the bolt.

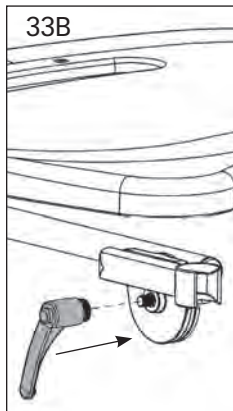
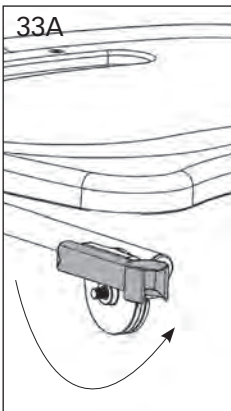

33A. Flip the tray arm as shown.

33B. Place the ratchet handle onto the bolt and tighten securely.

Repeat steps for the other side.

34. There are 2 knobs in the parts bag. Screw each knob slightly into the tray bracket on the unit. Place tray onto unit. Tighten securely.

 **Caution:** After placing the tray into position, ensure the ratchet handles on the side of the tray are tightened securely.



35A. If the High Mount Chest Vest Bracket was ordered, loosen knob on the bracket and insert head support.

35B. If the Head Support was ordered, loosen the knob on the back and insert the Head Support, tighten knob securely.



36A. Insert each knee bracket assembly into the tube along the seat post. Depress the spring button to allow the bracket to slide into place, advance until the spring button locks into place. Tighten knob securely. For Swing-Away knees, place into the tube, and tighten knob securely.

36B. Insert knee pad bracket into knee assembly, Depress the spring button to allow the bracket to slide into place, advance until the spring button locks into place. Tighten knob securely.

Repeat steps for the other knee pad assembly.

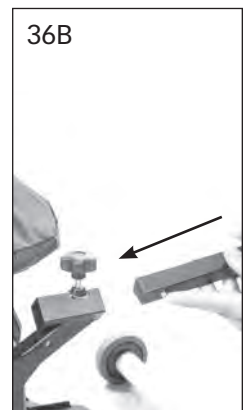



37. Remove knobs (bolts on standard knees) from the knee pads, place the knee pads on the bracket with the larger end of the pad to the outside and the seams side down. Place into desired position and tighten securely.

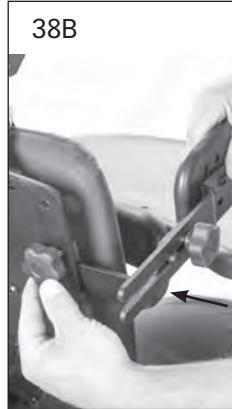
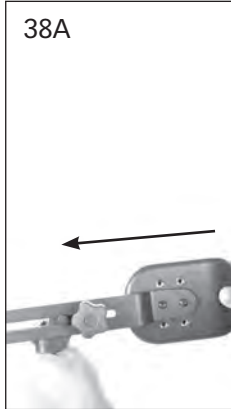

38A. If the Lateral Supports were ordered, loosen knob on lateral bracket and place lateral pad bracket onto bracket as shown. Tighten knob securely.

38B. Loosen knob on the back and Insert lateral assembly. Tighten knob securely.

Repeat steps for other side.



39. If the Hip Supports were ordered, loosen knob on tube on the back rear of the seat. Insert bracket into the tube and tighten securely.

Repeat steps for other side.

40A. For the Standard Actuator Handle, remove bolts and nuts from the pump handle socket. Place pump handle socket onto pump and align holes. Place bolts through top of the pump handle socket and place nuts on bottom. Tighten securely.

40B. For the Adjustable/Removable Actuator Handle, remove pull pin from the pump socket

40A



40B



41. Insert pump handle and secure pull pin into place.



42. Remove bolts from pump handle top. Place pump handle top on pump handle and align holes. Tighten securely.



43. If the optional Elbow Pad Cutout was ordered, remove the Chest Pad from tray. Disregard bolts, replace bolts with bolts in the bag with the Elbow Pad Cutout.

Place Elbow Pad Cutout onto the tray. Line up Chest Pad bracket with holes, insert bolts into Tray and Elbow Pad Cutout. Tighten securely.

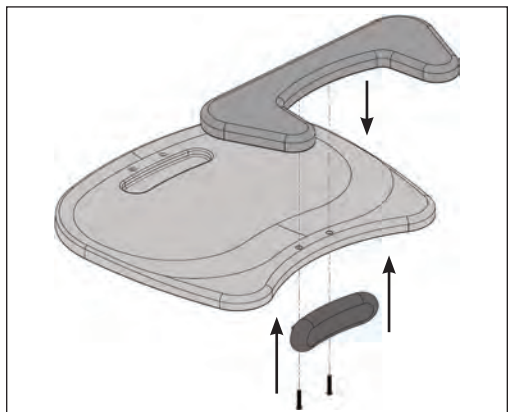

Options & Parts Detail-Y5500 Medium Bantam

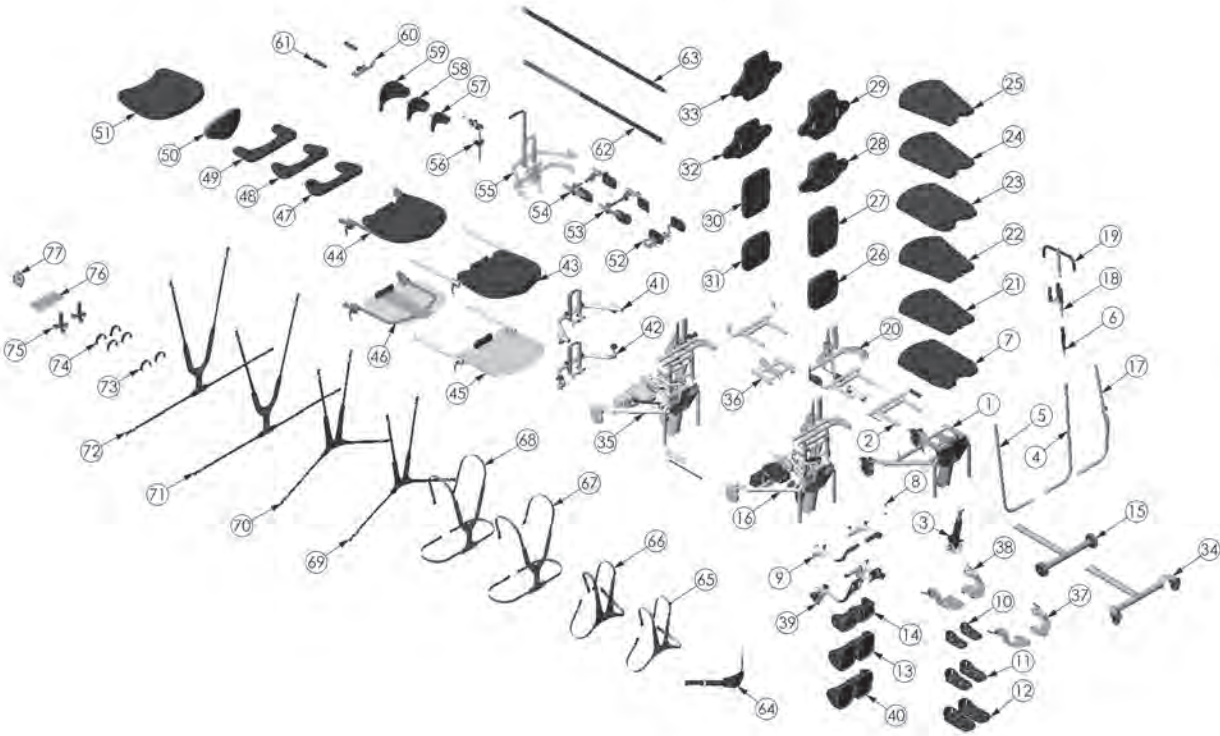

Options & Parts Detail-Y5500 Medium Bantam

ITEM NO.	PART NO.	REV.	QTY.	NAME	ITEM NO.	PART NO.	REV.	QTY.	NAME
1	Y5502	F	1	ASSEMBLY FRAME BANTAM MED	37	Y5584	B	1	ASMBLY FOOT PLATE STANDARD
2	Y5504	C	1	ASMBLY NO BACK BANTAM MED	38	Y5586	C	1	ASMBLY FOOT MULTI-ADJ LARGE
3	Y5516	A	1	ASMBLY HYDRAULIC LIFT BANTAM MED	39	Y5596	D	1	ASSEMBLY KNEES SWING AWAY
4	Y5518	A	1	PUMP HANDLE BANTAM MED STD RH	40	Y5600	000	1	ASSEMBLY KNEE PADS ROHO
5	Y5520	A	1	PUMP HANDLE BANTAM MED STD LH	41	Y5602	E	1	ASMBLY TABLE MULTI-ADJUSTABLE
6	NG50260	000	1	HANDLE STANDARD TOP	42	Y5653	A	1	ASMBLY TABLE MOUNT SWINGAWAY MED
7	Y5522	A	1	UPHOLSTERY PLANAR SEAT BANTAM MED	43	Y5604	C	1	ASSEMBLY TRAY STANDARD
8	Y5524	000	1	ASMBLY NON-SUPINE BANTAM MED	44	Y5654	D	1	ASMBLY TRAY SWINGAWAY MED - BLACK
9	Y5594	C	1	ASSEMBLY KNEES BANTAM MED STD	45	Y5606	C	1	ASSEMBLY TRAY CLEAR 21" L X 24" W
10	Y5588	000	1	ASMBLY FOOT PLATES 8"	46	Y5655	C	1	ASMBLY TRAY SWINGAWAY MED - CLEAR
11	Y5590	000	1	ASMBLY FOOT PLATES 9.75"	47	T50156	C	1	ASSEMBLY ELBOW PAD 9.25" CUTOUT
12	Y5592	000	1	ASMBLY FOOT PLATES 11.75"	48	T50160	C	1	ASSEMBLY ELBOW PAD 11" CUTOUT
13	Y5598	000	1	ASSEMBLY KNEE PADS STANDARD	49	Y5582	B	1	ASSEMBLY ELBOW PAD 13"
14	Y5624	000	1	ASSEMBLY KNEE PADS SMALL	50	NG30000	A	1	PAD FRONT EXTRA SUPPORT
15	Y5566	C	1	ASMBLY FRONT NO-TABLE BANTAM MED	51	NG30295	000	1	PADDED TRAY COVER
16	Y5564	E	1	ASMBLY ELECTRIC LIFT BANTAM MED	52	Y5560	A	1	ASMBLY HIP GUIDES BANTAM MED
17	Y5632	B	1	HANDLE PUMP REMOVEABLE/ADJ MED	53	Y5562	C	1	ASMBLY LATERAL GUIDES BANTAM MED
18	NG50044	A	1	QUAD GRIP OPTION	54	Y5686	000	1	ASMBLY LAT GUIDES BANTAM MED FLAT
19	NG50070	A	1	ACTUATOR HANDLE EXTENSION EVOLV LG	55	Y5662	000	1	ASSIST HANDLE MED BANTAM
20	Y5528	K	1	ASMBLY BACK BANTAM MED	56	Y5548	E	1	ASMBLY HEAD REST
21	Y5570	A	1	ASMBLY SEAT CONTOUR NARROW	57	T30062	000	1	HEAD SUPPORT BANTAM XS
22	Y5572	A	1	ASMBLY SEAT CONTOUR WIDE	58	T30065	000	1	HEAD SUPPORT BANTAM SMALL
23	Y3042	000	1	COVER SEAT PLANAR MEDIUM DARTEX	59	NG30299	000	1	HEAD SUPPORT EVOLV LARGE
24	Y3043	000	1	COVER CONTOURED SEAT NARROW DARTEX	60	Y5634	B	1	ASMBLY CHEST VEST BRKT HIGH MOUNT
25	Y3044	000	1	COVER CONTOURED SEAT WIDE DARTEX	61	NG50040	000	1	HANDLE PUSH ASSEMBLY
26	Y5530	A	1	BACK REST PLANAR 16"	62	Y3008	000	1	POSITIONING BELT ADJUSTABLE 25 - 60"
27	Y5532	A	1	BACK REST PLANAR 20"	63	Y3014	000	1	POSITIONING BELT W/BUCKLE MED
28	Y5574	B	1	ASMBLY BACK CONTOURED 16"	64	Y5620	A	1	ASMBLY CHEST STRAP WITH PAD
29	Y5576	B	1	ASMBLY BACK CONTOURED 20"	65	NG30170	A	1	X-STYLE CHEST VEST 9.5"W X 9"W
30	Y3040	000	1	COVER BACK PLANAR 20" DARTEX	66	NG30056	A	1	X-STYLE CHEST VEST 11"L X 9.5"W
31	Y3041	000	1	COVER BACK PLANAR 16" DARTEX	67	NG30171	000	1	Y-STYLE CHEST VEST 17.5"L X 11.5"W
32	Y3045	000	1	COVER BACK REST CONTOURED 16" DARTEX	68	NG30021	000	1	Y-STYLE CHEST VEST 20.5"L X 12.5"W
33	Y3046	000	1	COVER BACK REST CONTOURED 20" DARTEX	69	NG30318	000	1	NON STRETCH X-STYLE CHEST VEST 11"L X 9.5"W
34	Y5568	A	1	SWIVEL FRONT BANTAM MED	70	NG30322	000	1	NON STRETCH X-STYLE CHEST VEST 14.5"L X 10.5"W
35	Y5554	E	1	ASMBLY SUPINE OPTION BANTAM MED	71	NG30320	000	1	NON-STRETCH Y-STYLE CHEST VEST 17.5"L X 11.5"W
36	Y5645	000	1	ASMBLY BEARING SEAT DEPTH	72	NG30324	000	1	NON-STRETCH Y-STYLE CHEST VEST 20.5"L X 12.5"W
					73	Y5636	A	1	ASMBLY FOOT STRAP 15"L
					74	Y5638	A	1	ASMBLY FOOT STRAP SECURE 15"L
					75	NG50042	000	1	SUPPORT GRIP OPTION
					76	80809	A	1	TOOL POUCH
					77	Y5643	000	1	ANGLE LOCATOR MED BANTAM

AltimateMedical

Assembly Manual

262 West 1st St.

Morton, MN 56270 USA

Toll Free: 800.342.8968 or 507.697.6393

Fax Free: 877.342.8968 or 507.697.6900

email: info@easystand.com

easystand.com



Standing technology should only be used under the guidance of a physician with recommendations for standing program protocol and any medical precautions. Standing programs should be monitored by the attending therapist. AMI maintains a policy of continual product improvement and reserves the right to change features, specifications, and prices without prior notification. Check with AMI for latest info.
FORM NEWMBANMAN 060421 REV A Copyright © 2021 Altimate Medical, Inc. All rights reserved. Printed in the U.S.A.