

Basic electronic components

An introduction to electronic components that you will need to build a motor speed controller.



Resistors

- A resistor impedes the flow of electricity through a circuit.
 - Resistors have a set value.
 - Since **voltage**, **current** and **resistance** are related through **Ohm's law**, resistors are a good way to control voltage and current in your circuit.



Resistor

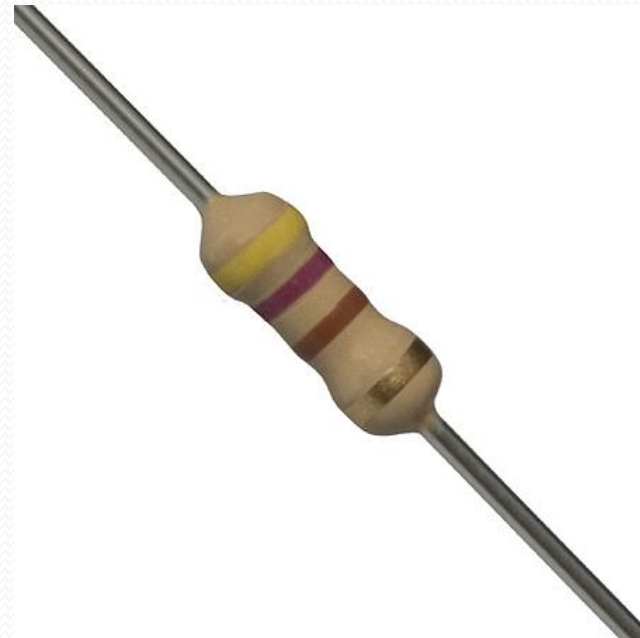

More on resistors

- Resistor color codes

1st band = 1st number

2nd band = 2nd number

3rd band = # of zeros / multiplier

4th band = tolerance

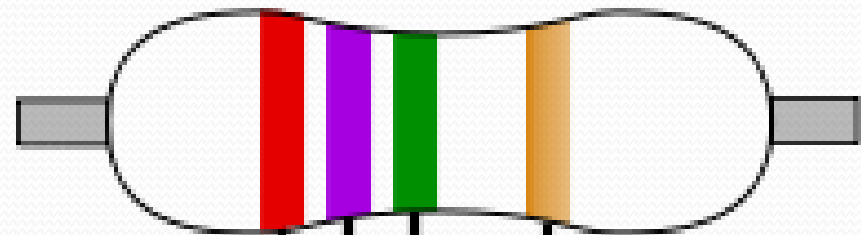
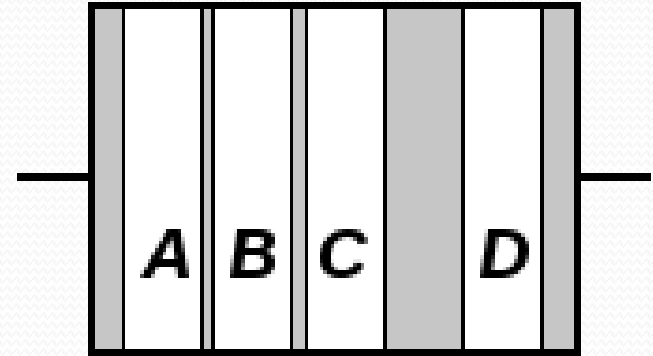

1st Band

2nd Band

Tolerance

Multiplier

Color code

- Tolerance: Gold = within 5%

Black: 0

Brown: 1

Red: 2

Orange: 3

Yellow: 4

Green: 5

Blue: 6

Violet: 7

Gray: 8

White: 9

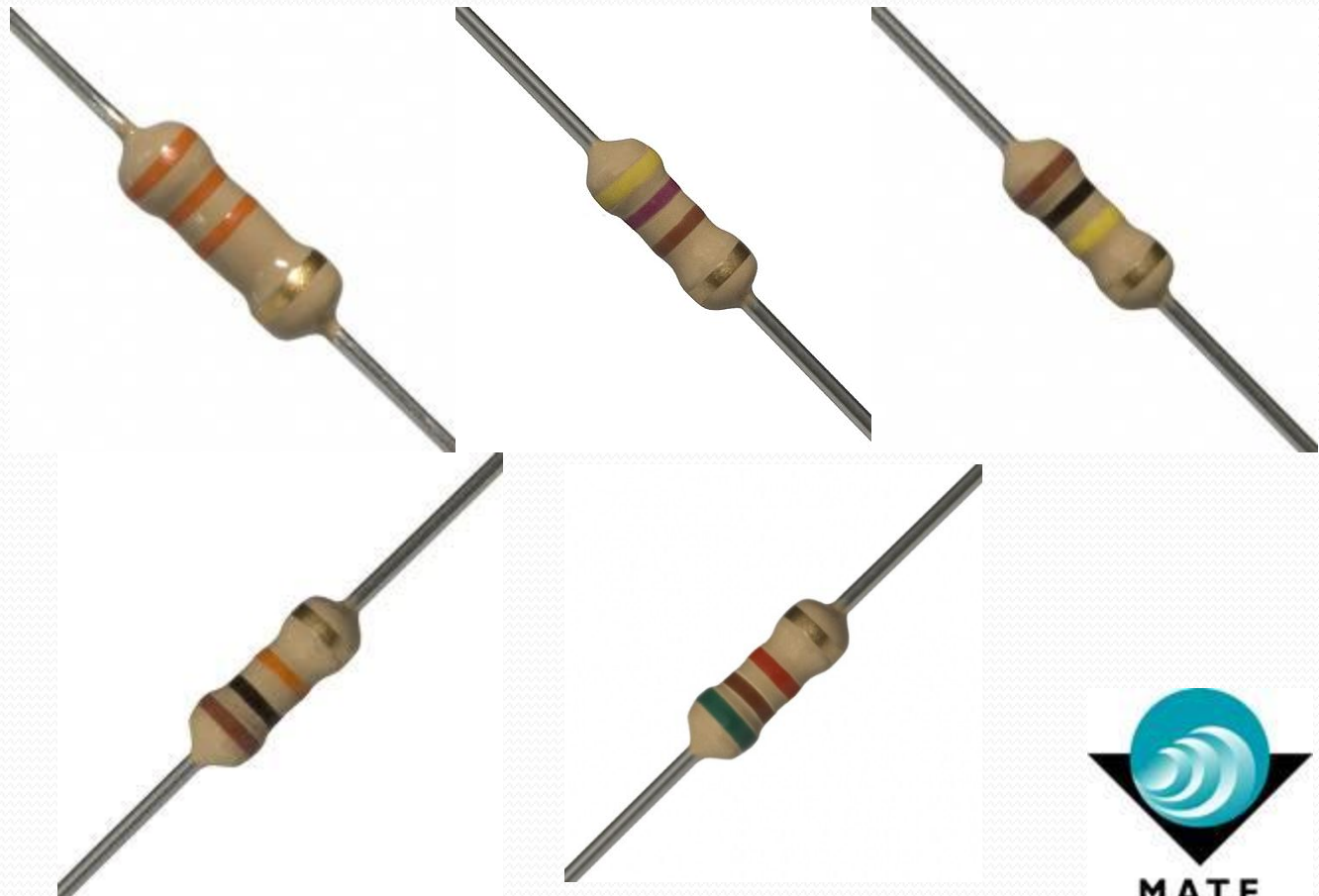

Units

- Knowing your units is important!
 - Kilo and Mega are common in resistors
 - Milli, micro, nano and pico can be used in other components

K (kilo) = 1,000

M (mega) = 1,000,000

m (milli) = 1/1,000

μ (micro) = 1/1,000,000

n (nano) = 1/1,000,000,000 (one trillionth)

p (pico) = 1 / 1,000,000,000,000 (one quadrillionth)



Capacitors

- A capacitor stores electrical energy.
 - This pool of electrons is available for electronic components to use.

Capacitance is measured in Farads. The small capacitors usually used in electronics are often measured in microfarads and nanofarads.



Some capacitors are polarized. Note the different length terminals on one of the capacitors.

Polarity of capacitors

- The shorter terminal goes on the negative side.
- The stripe is on the negative terminal side of the capacitor.
- The board is marked for positive or negative.

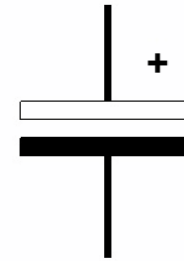
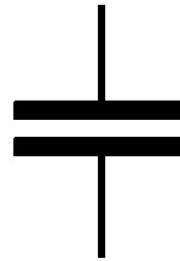
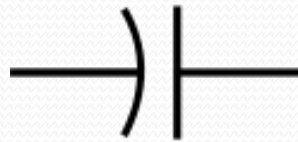
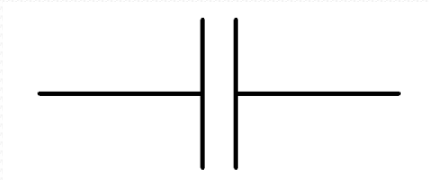

Applications of capacitors

- Capacitors supply a **pool of electrons** for immediate use.
 - If a component needs an immediate supply of electrons, the capacitor can supply those electrons.

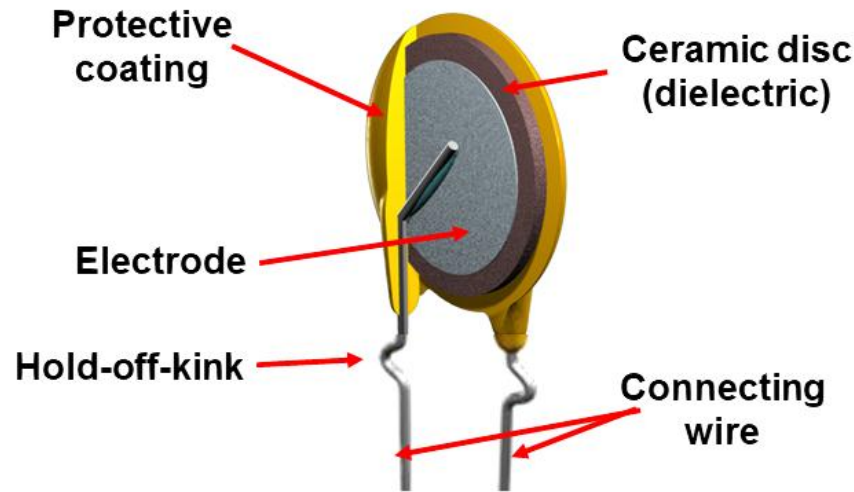

- Capacitors can **smooth out a signal** – eliminate the ripples or spikes in DC voltage.
 - The capacitor can absorb the peaks and fill in the valleys of a rippled signal.

Diode

- A diode is a **one way valve** (or gate) for electricity. It is a component with an asymmetrical transfer characteristic. A diode has low (ideally **zero**) **resistance** in one direction, and high (ideally **infinite**) **resistance** in the other direction.

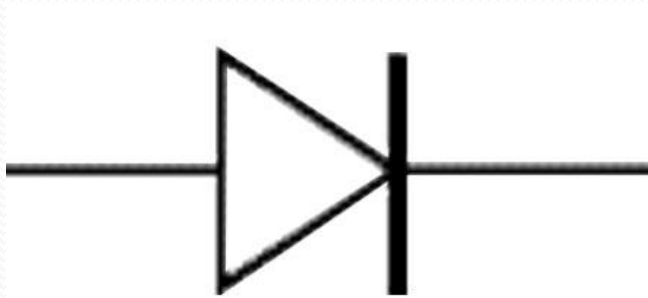

Diode

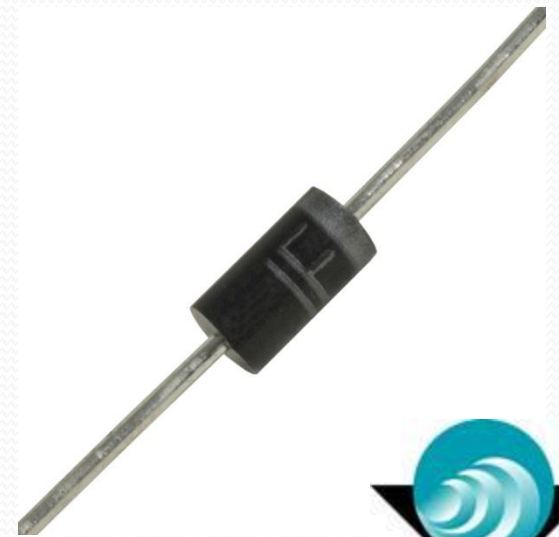

- Diodes will protect your electronics.



Diode circuit protection

- In a DPDT switch, if polarity is wrong, the motor will run backwards.
- In an electronic circuit, if the polarity is wrong, you can fry your components.

A diode in your system will help to prevent problems.

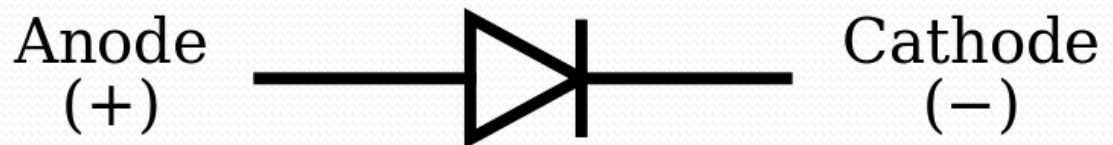

Diodes have a bar on the cathode (negative) side.

Light emitting diode (LED)

- A light emitting diode (LED) is a semiconductor light source. When electricity is passing through the diode, it emits light.

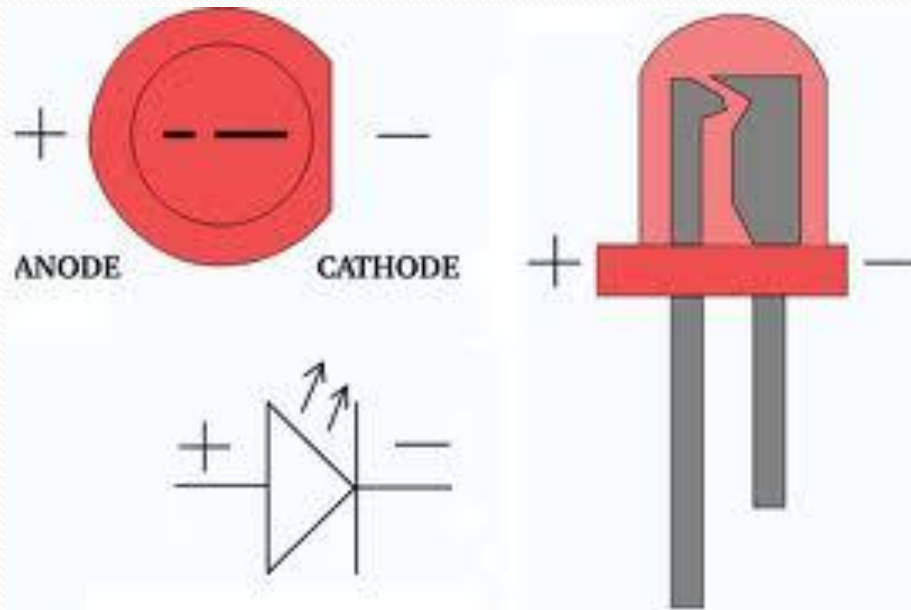

- Jeremy is going to talk a lot more about LEDs.

Variable resistor / Potentiometer

- A potentiometer is a variable resistor. As you manually turn a dial, the resistance changes.



Fixed value resistor

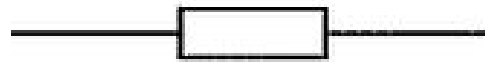

Variable resistor - Potentiometer

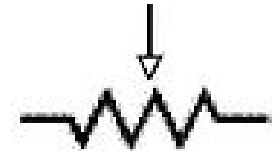
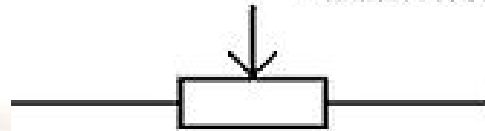

How a variable resistor works

- As the dial/wiper turns, electricity must go through more or less of the resistive strip.

In series, the change in resistance means a change in voltage.

- So as you turn the dial/wiper, you get a change in **voltage**.

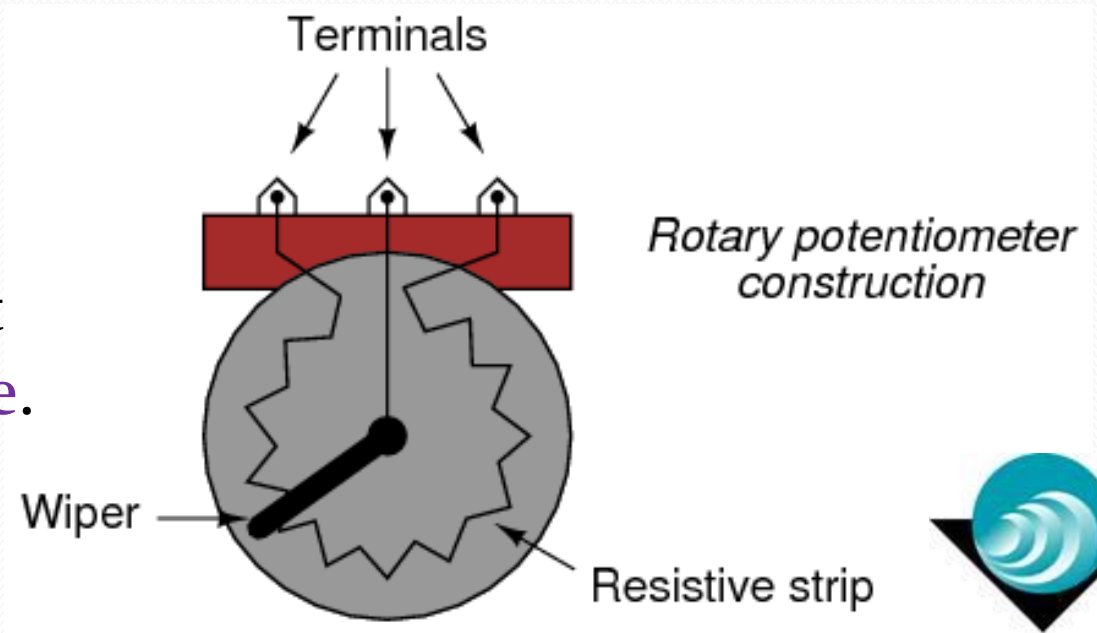

Transistors

- A transistor is a semiconductor device used to amplify and **switch** electronic signals and electrical power.

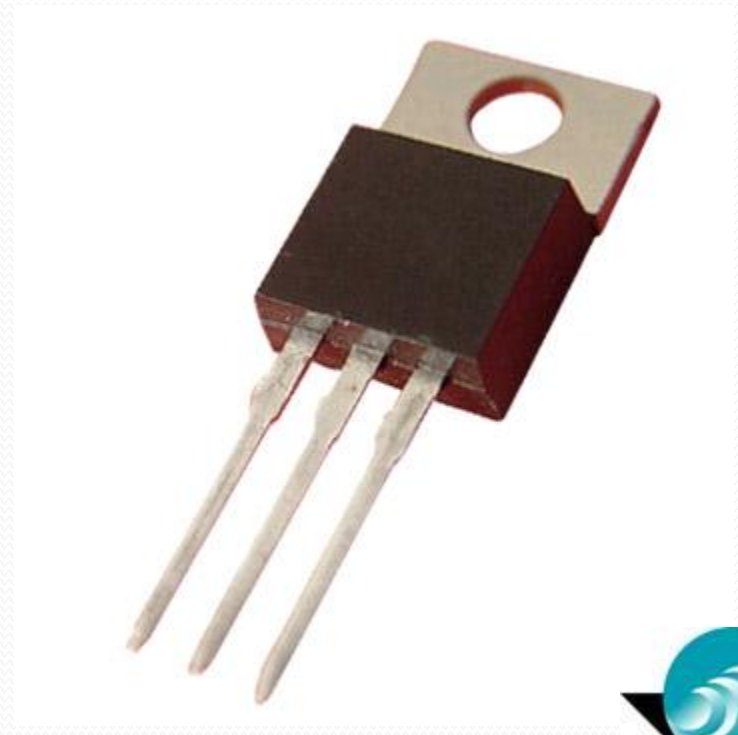

- This is our electronic switch!

How a transistor works

- A voltage or current applied to one pair of the transistor's terminals changes the current through another pair of terminals.
- A transistor is composed of semiconductor material with at least three terminals for connection to an external circuit.

Transistors have 3 pins.

For these transistors:

Collector

Emitter

Base

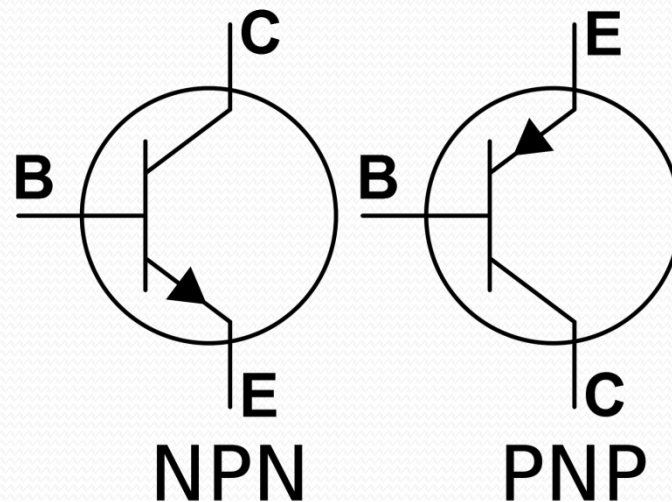

Terminology

- BJT versus FET
 - **Bipolar junction transistor.** Useful as amplifiers.
Collector, Emitter, Base
 - **Field-effect transistor.** Useful as motor drivers.
Source, Drain, Gate
MOSFET: Metal-oxide-semiconductor FET
- **NPN** (N-channel FET) versus **PNP** (P-channel FET)
 - NPN versus PNP is how the semiconductors are layered.
NPN: **Not pointing in**
PNP: **Pointing in permanently**



Schematic symbols

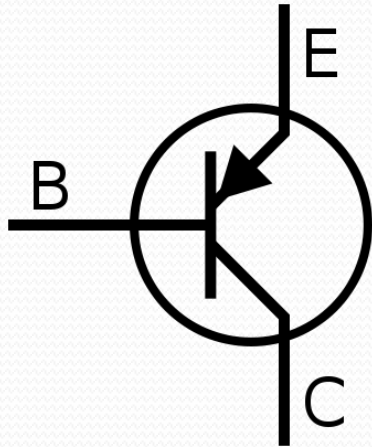

BJT PNP

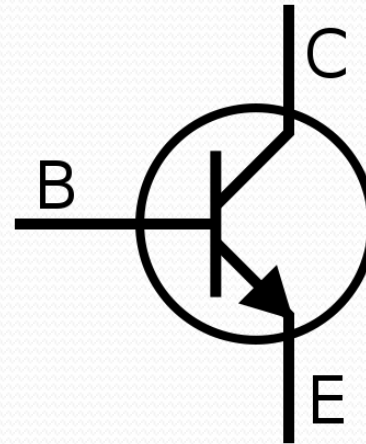

BJT NPN

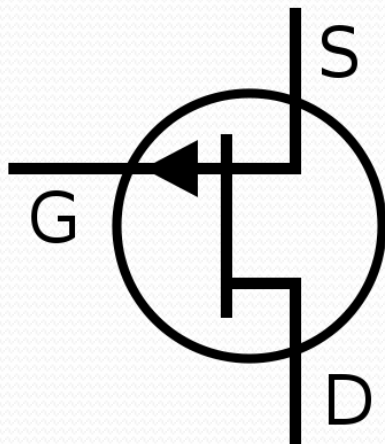

P-channel FET

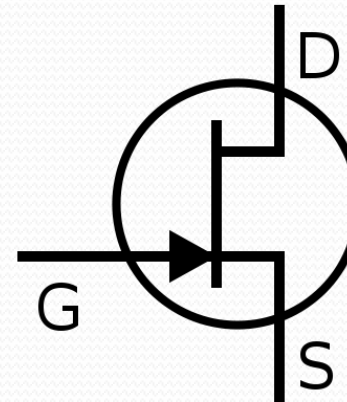

N-channel FET



Integrated circuit

- An **integrated circuit** (IC) is a set of transistors that is the controller or **'brain'** of an electronic circuit.
 - An input is received, an output is sent out.

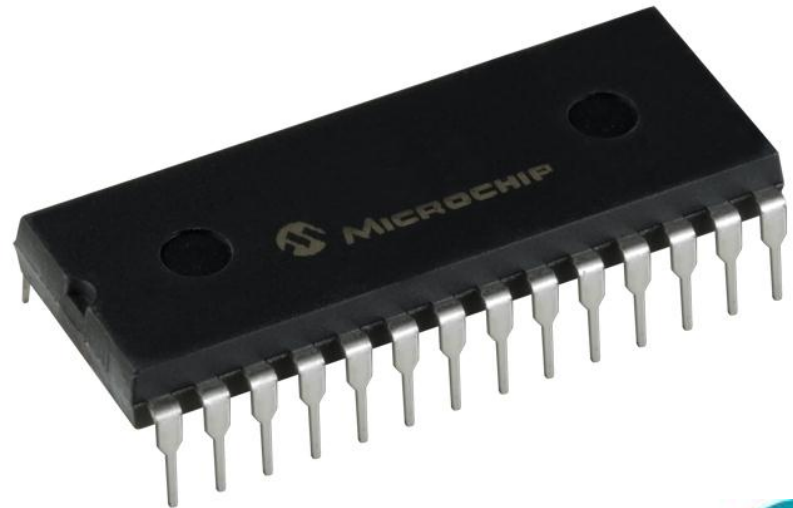

Modern microprocessor ICs can have billions of transistors per square inch!



What an IC can do for us?

- Billions of electronically controlled on/off switches (**transistors**) is how the microprocessor in a digital computer 'thinks' and functions.
 - A computer has a wide range of tasks to perform.
- But other ICs can complete simpler, discrete jobs. For example, an IC can take a **voltage input** and output **commands to a motor**.



IC Terminology: Op-amp

- An **operational amplifier** (op-amp) is a set of transistors inside the integrated circuit. They often are the components doing the mathematical operations.

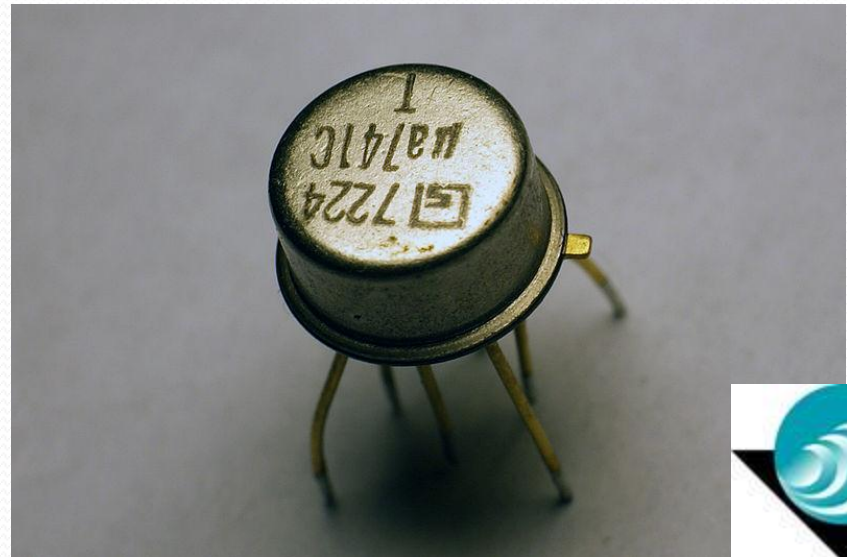
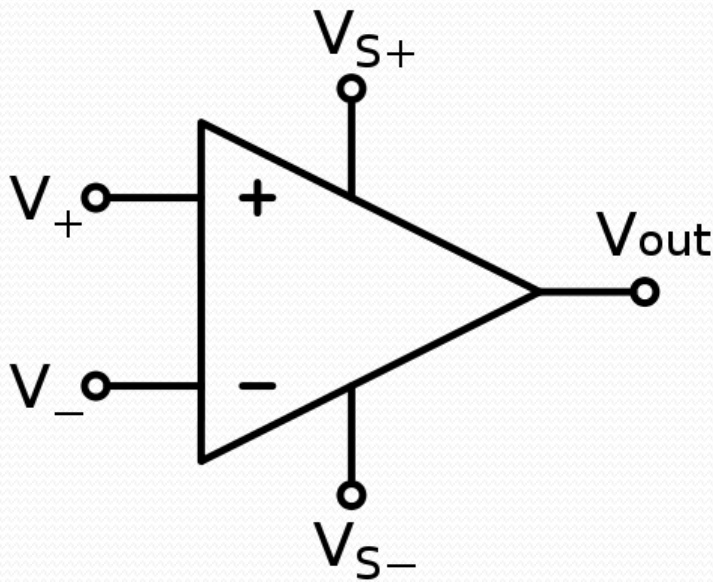

H-bridge

- An **electronic circuit** that enables voltage to be applied across a load in either direction.

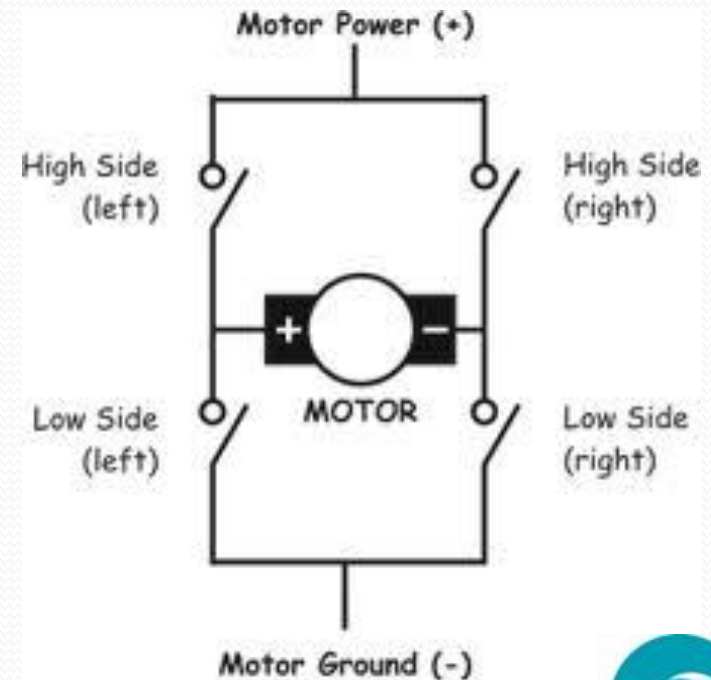
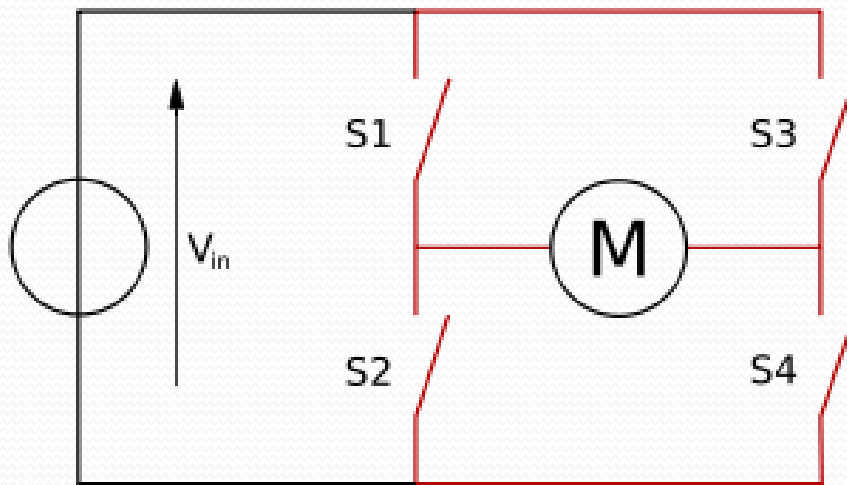

- A DPDT switch also does this, but not electronically.

H-bridge

- Need four electronic switches.
- Either have 1 and 4 closed. Or 2 and 3 closed.

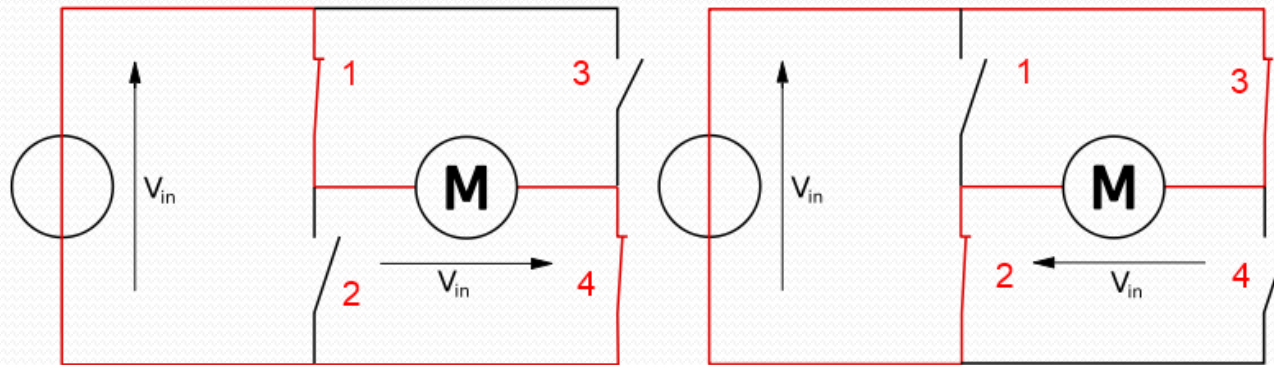

- What happens if both 1 and 2 are closed?
- The H-bridge allows electricity to flow both ways across the motor, which gives us forward and reverse.
- We can use pulse width modulation to control how often the switches are on versus off, which gives us speed control.

Varying voltage

- A potentiometer/variable resistor allows you to change the voltage input that goes into the integrated circuit.

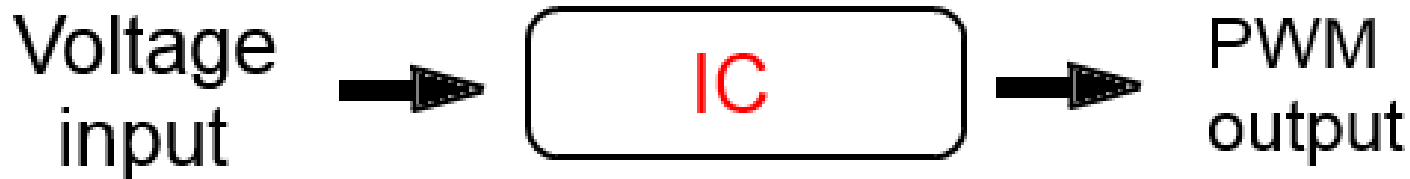

- Integrated circuit can now output variety of **pulse widths** to the transistors on the H-bridge.
- This combination of potentiometer, integrated circuit and PWM to the H-bridge **is the key to speed control.**



Why not skip the IC?

- There are a couple reasons we don't use just a potentiometer to control the speed of our motors.
 - Potentiometers are rarely used to control significant power (more than a watt).
- You would still need a way to switch the direction of the motor. Just using a potentiometer can control speed, but not direction.
 - DPDT switch and potentiometer combinations can lead to problems if you quickly switch from full forward to full reverse. Problems can occur if the polarity of a spinning DC motor gets suddenly switched from forward to reverse.
 - Current surge
 - Mechanical stress



Printed Circuit Board

- Components are attached to a printed circuit board.
- The 'front' side of the board will have printed component information, such as resistor # and resistance, diode type and polarity, etc.
- Holes go all the way through the board from one side to the other. Through-hole soldering is needed to connect components to the board.

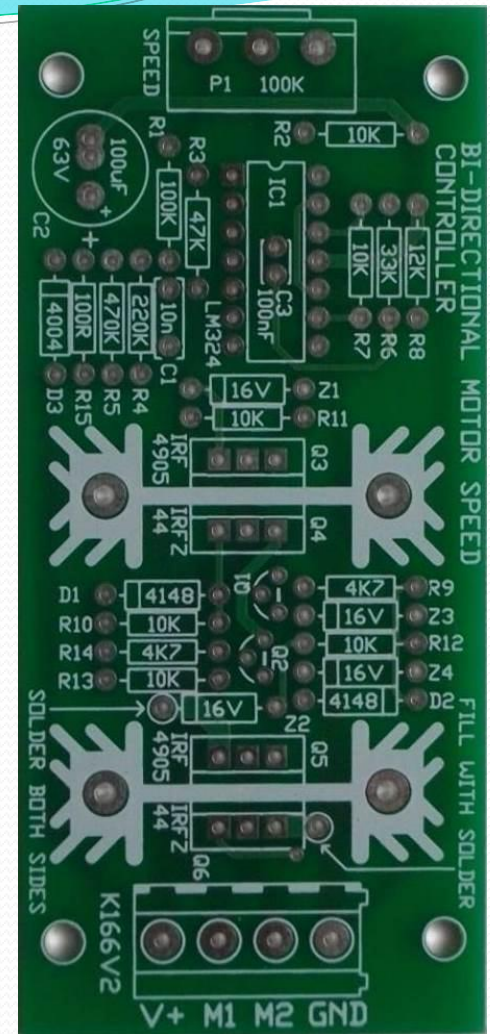

Back of Circuit Board

- The 'back' side of the board will have lines indicating connections between components. The lines on the back are similar to wires.
- Thicker lines denote more current (electrons) moving through.
- Components connect the lines.

