

# **Basic Principles and Techniques of Internal Fixation of Fractures**

***Leo A. Calafi, MD***

***March 2014***

# Overview

- **Types of Bone healing and fixation constructs**
- **Types and functions of internal fixation**
- **Summary**

# Biology of Bone Healing

## Primary Bone Healing

- Requires direct reduction and absolute stability
- Requires increased fracture stability and a low strain ( $\leq 2\%$ ) environment
- Haversian remodeling
- No callus

## Secondary Bone Healing

- Requires indirect reduction and relative stability
- Requires a high strain ( $\geq 2\%$ ) fracture environment
- Endochondral/intramembranous ossification
- Callus/cartilage become mineralized and replaced by bone

# Fixation Construct

- **Fracture personality and patient factors determine fixation construct**
- **Fracture personality encompasses factors such as anatomic location, fracture pattern, bone quality, and soft tissue status**
- **Simple fracture patterns and articular injuries are treated with direct reduction and absolute stability**
- **Complex and comminuted fracture patterns are treated with indirect reduction and relative stability**

# Fracture Stability

- **Absolute stability**
  - Involves direct visualization, anatomic reduction, and stable fixation
  - Lag screws, compression plating
- **Relative stability**
  - Involves indirect reduction and fixation
  - The goal is restoration of axial, angular, and rotational alignment, while preserving the biological environment of the fracture
  - IM rods, bridge plating, Ex-fix, casting

# Spectrum of Stability

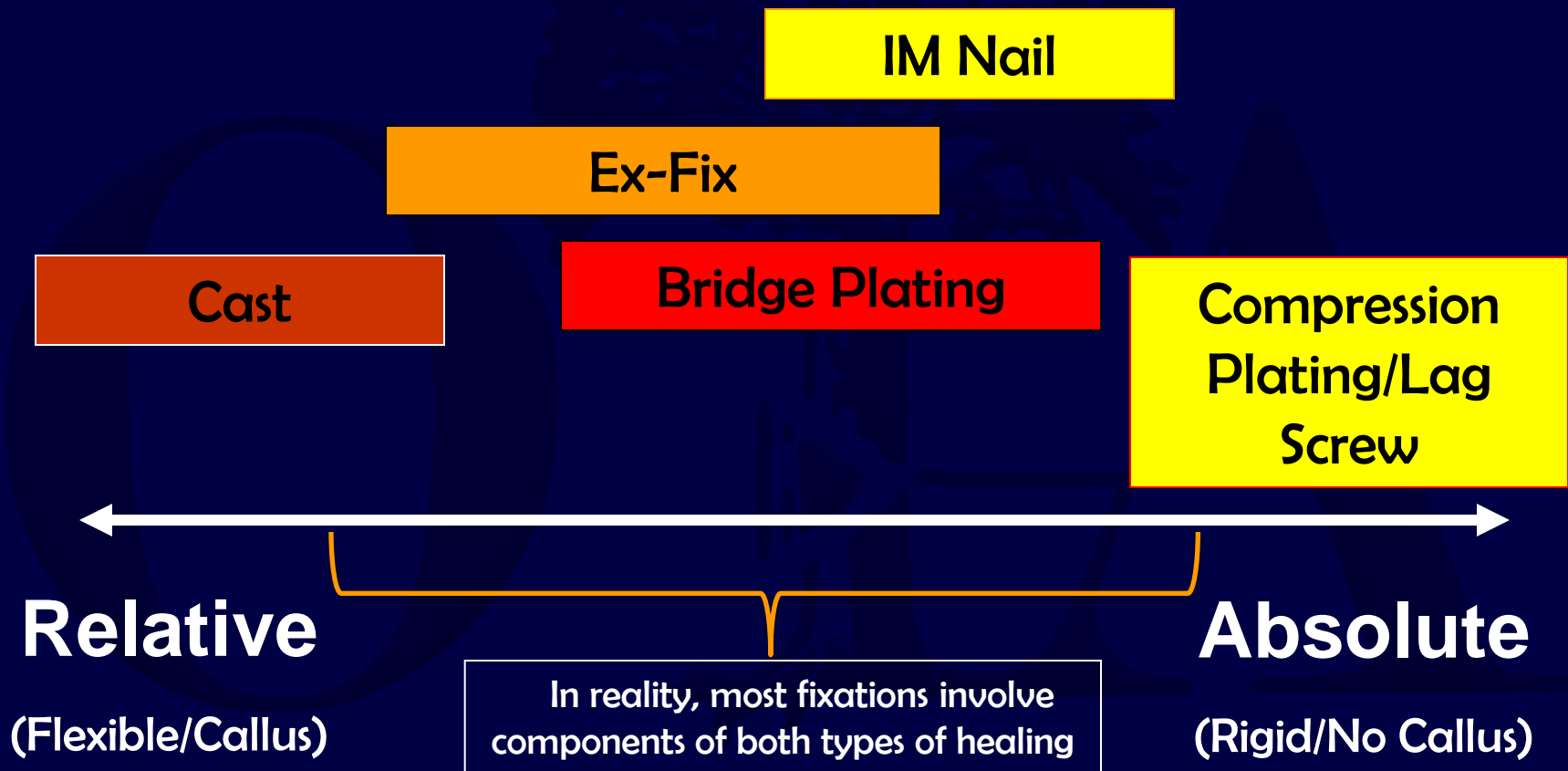

# Absolute Stability

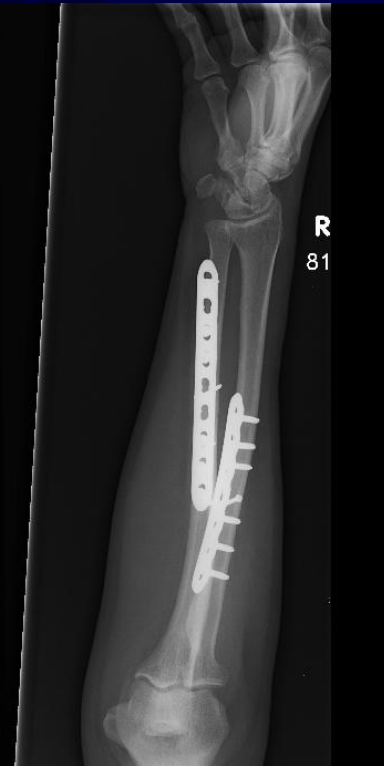

# Relative Stability





# Hybrid Fixation

- This type of fixation involves a combination of absolute and relative stability principles
- An example would be a peri-articular fracture with extensive meta-diaphyseal comminution

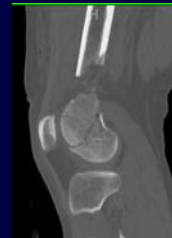
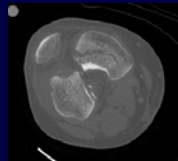

Direct reduction and absolute stability for the articular block;  
Bridge plating and relative stability for the meta-diaphysis



# Goals and Indications for Internal Fixation

- **Goals:**
  - Restoration of bony anatomy while respecting soft tissues
  - Stable fixation
  - Accelerated recovery
  - More predictable and potentially faster healing
- **Indications:**
  - Displaced intra-articular fractures
  - Open fracture
  - Polytrauma
  - Associated neurovascular injury
  - Failure of closed treatment

# Fixation Functions

- **Lag Screw**
  - Inter-fragmentary compression
- **Plates**
  - Neutralization
  - Buttress/anti-glide
  - Tension Band
  - Compression
  - Bridge
  - Locking
- **Intramedullary Nails**
  - Internal splint
- **Bridge plate fixation**
  - Internal splint
- **External fixation**
  - External splint
- **Cast**
  - External splint

# Screw Types

- **Cancellous**
- **Cortical**
- **Solid vs. cannulated**
- **Locking vs. non-locking**
- **Locking – screw head “locks” into the plate creating a fixed angle device; can be cortical, cancellous, solid, or cannulated**

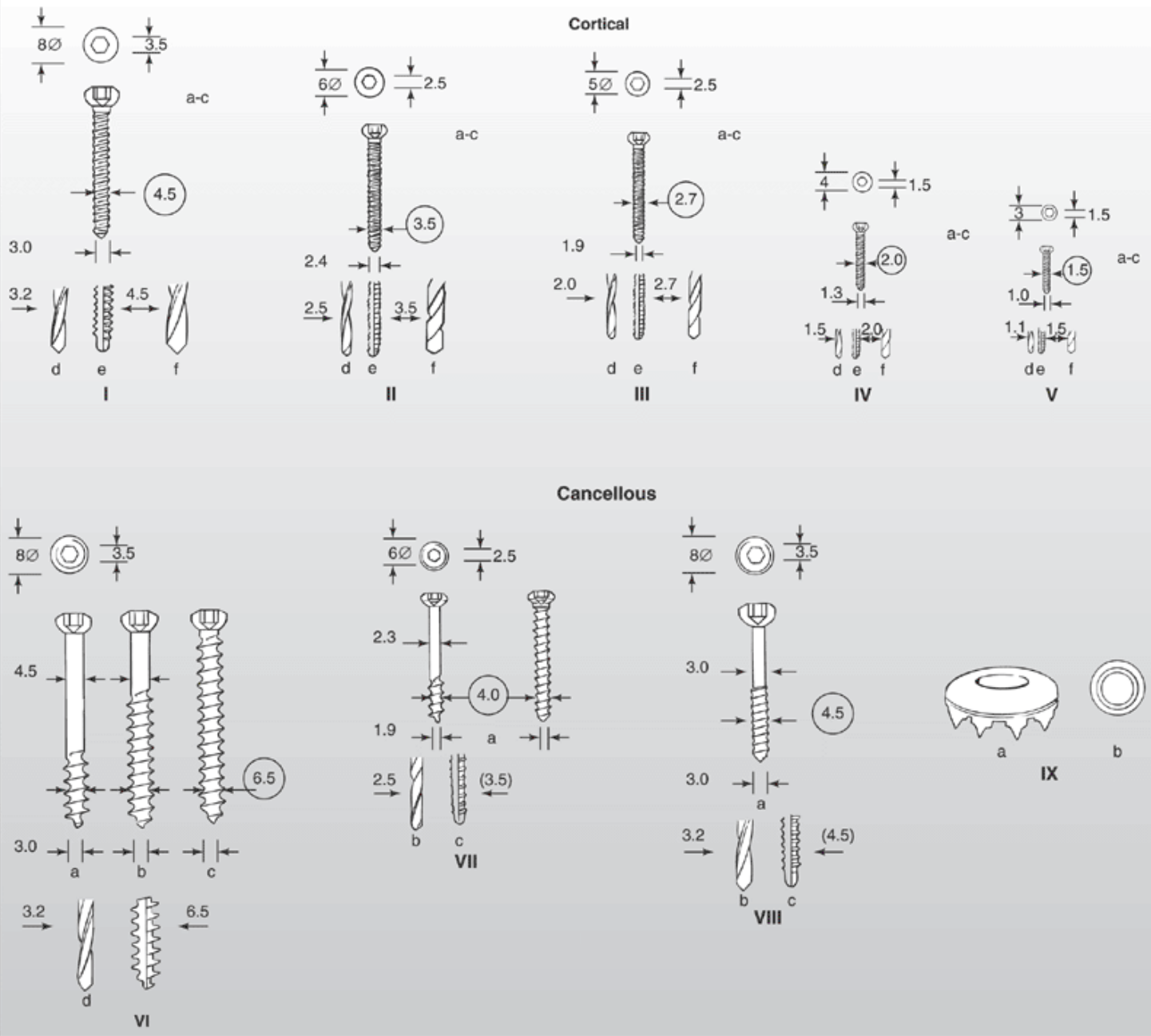
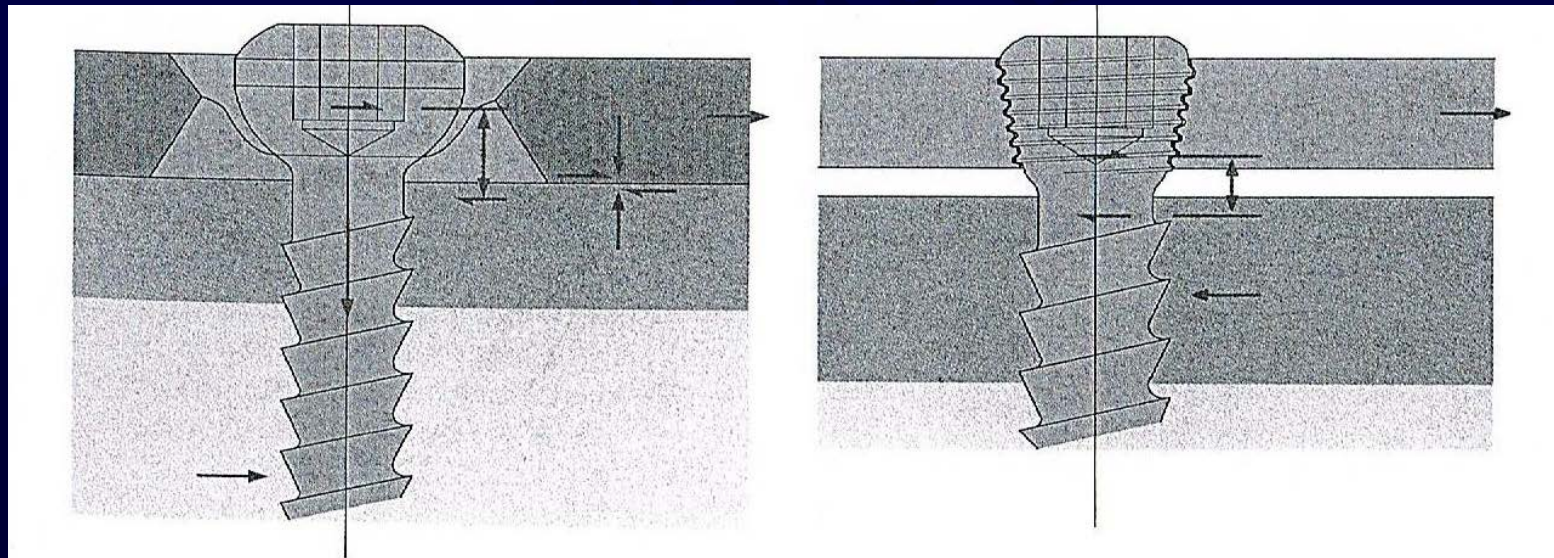

Figure from Rockwood & Green's Fractures in Adults, 6<sup>th</sup> Edition

# Conventional vs. Locking Screw



Tightening of the screw compresses the plate to the bone and the resulting friction forces keep the construct stable

The screw head threads and locks into the plate creating an angular-stable construct

# Screw Functions

- **Positional screw** – screw has a neutral effect on fracture fragment position, pilot hole diameter is slightly greater than screw core diameter
- **Plate screw** – can be locking or non-locking head; non-locking produces friction between plate and bone due to compression; locking provides angular stability
- **Poller/blocking screw** – used to redirect an IMN
- **Lag screw** – Inter-fragmentary compression; both fully threaded and partially threaded screws can have a lag effect

# Lag Screw

## Lag by technique

Fully threaded screws act as a lag screw when the proximal hole (gliding hole) is drilled with the diameter of the screw thread

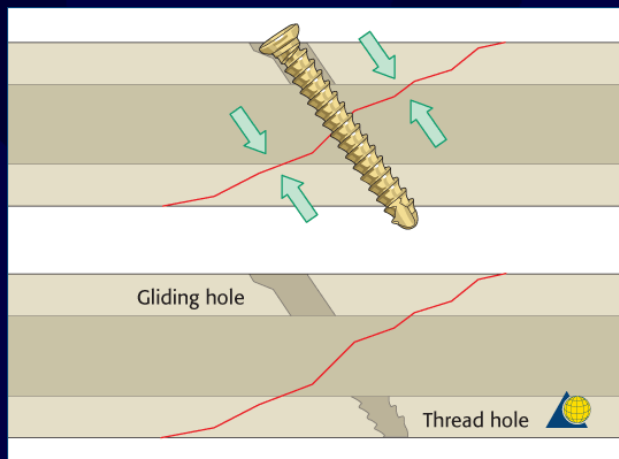

## Lag by design

Partially threaded screws can act as a lag screw as long as the threaded part does not cross the fracture line

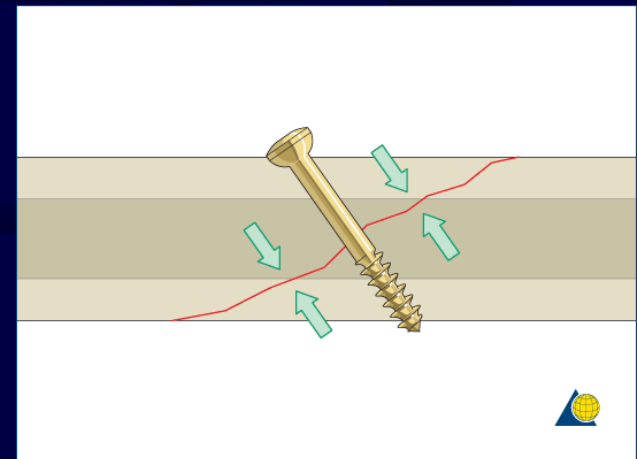

Copyright by AO  
Foundation,  
Switzerland



# Lag Screw Technique

**Fully threaded (example: 3.5mm cortex screw)**

- 1.Reduce the fracture and drill perpendicular to the obliquity of the fracture line**
- 2.Gliding hole – Drilling with the outer diameter of the screw (3.5mm) should only be done to the fracture line**
- 3.Center the drill for the core diameter of the screw (2.5mm) within the gliding hole using a drill sleeve and drill the far cortex**
- 4.Countersinking of the proximal cortex improves screw-bone load transfer (measure screw length after countersinking)**

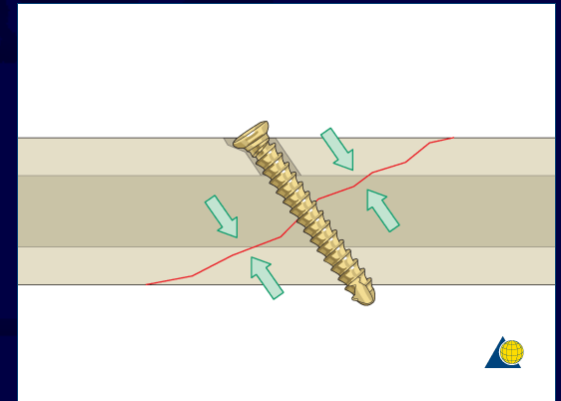
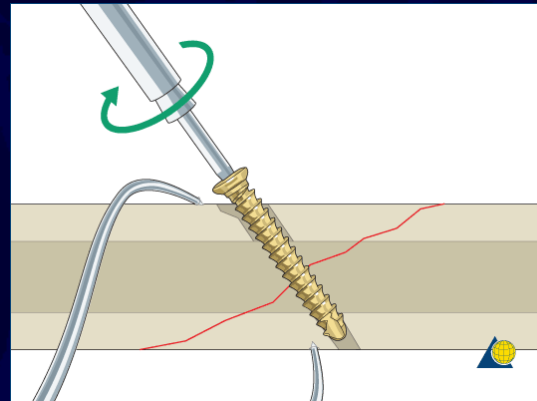
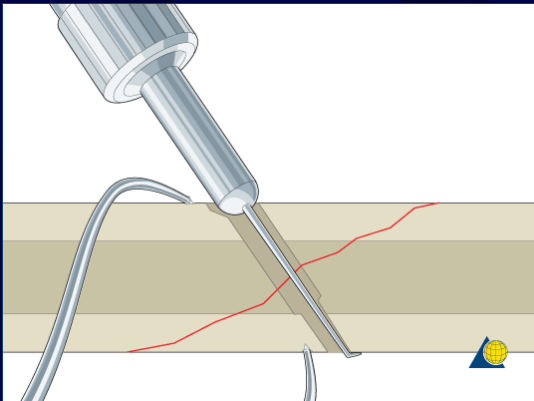
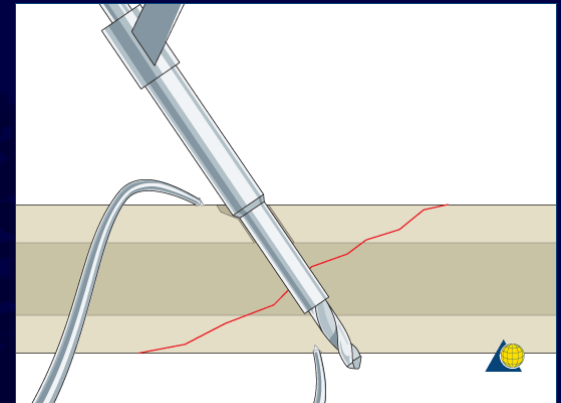
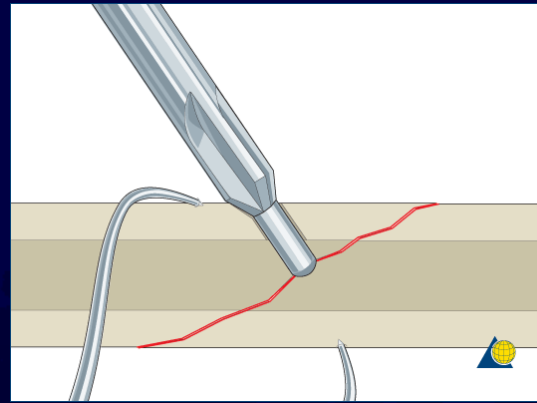
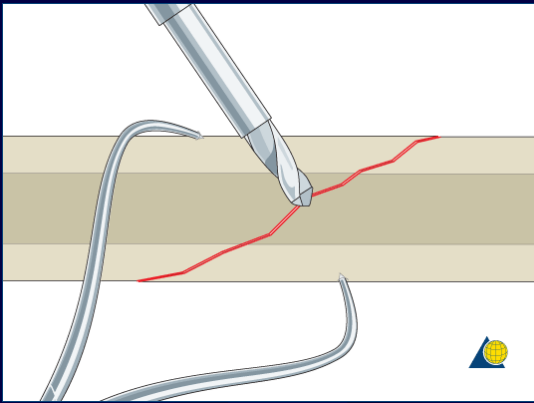

Malposition of the screw, not counter-sinking, or fracture comminution can lead to loss of reduction

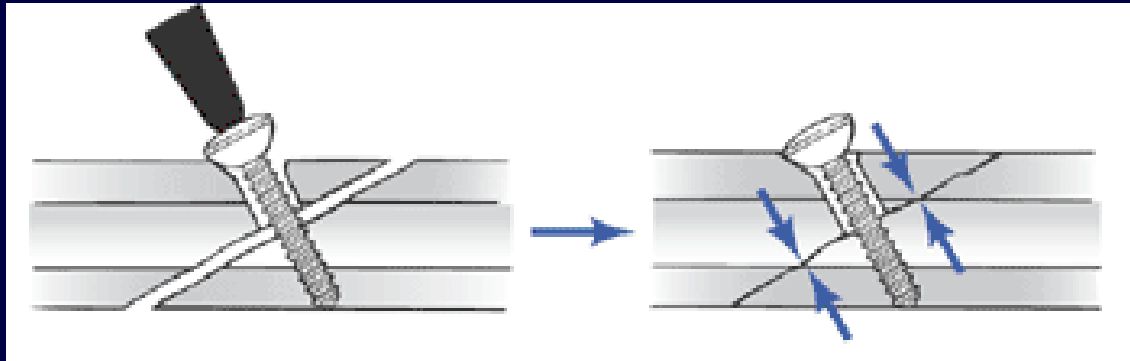

A lag screw placed perpendicular to the fracture line results in maximum inter-fragmentary compression

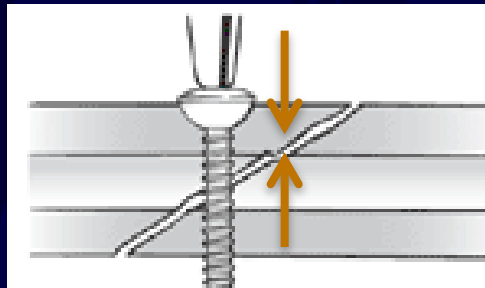

A lag screw inserted perpendicular to the long axis of bone results in maximal resistance to shear forces produced during axial loading

Copyright by  
AO Foundation,  
Switzerland

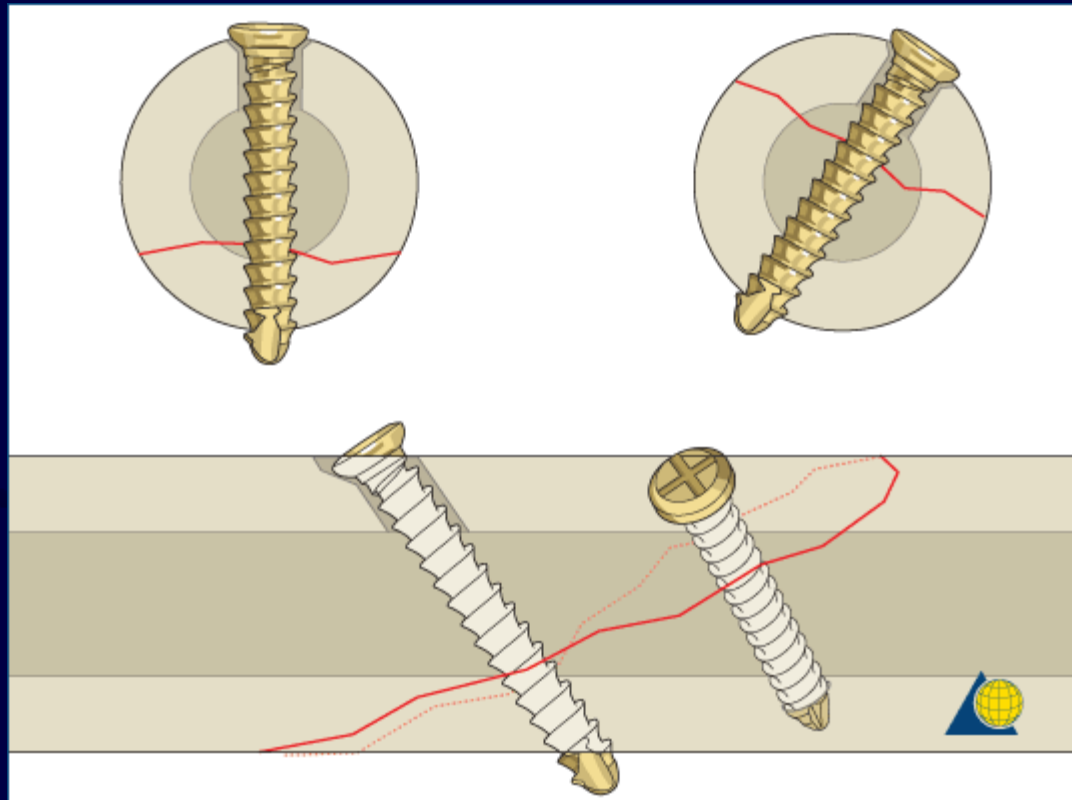

In most cases, a single lag screw is not sufficient to stabilize the forces within the fracture, especially shear and rotational forces, therefore additional lag screw(s) and/or a neutralization plate may be required

# Plate Function: Neutralization

- Neutralizes/protects lag screws from shear, bending, or torsional forces across the fracture
- Can be a locking or a non-locking plate

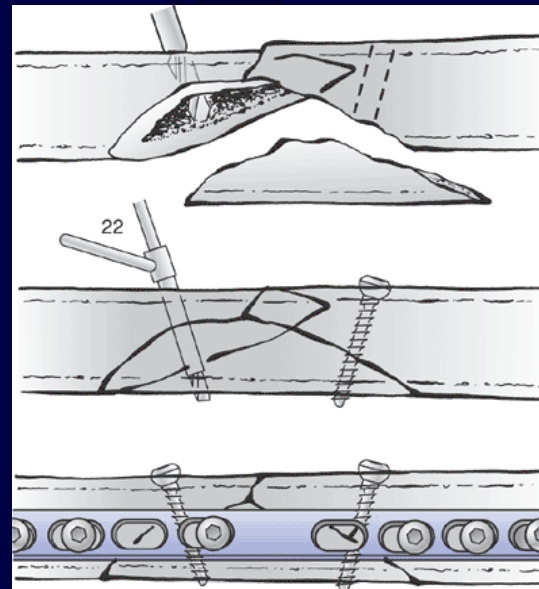
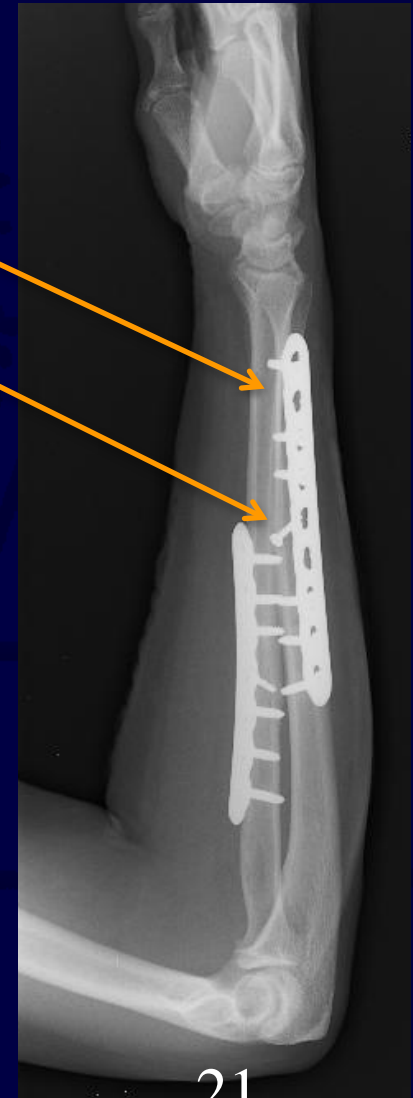

Figure from Rockwood & Green's  
Fractures in Adults, 6<sup>th</sup> Edition

Neutralization  
plate

Lag screw



# Plate Function: Buttress/Anti-glide

## Buttress Plate

- When applied to metaphyseal fractures to support intra-articular fragments
- If a stiff plate is used, exact contouring to the local anatomy is necessary; alternatively, pre-contoured anatomical plates can be used

## Anti-glide Plate

- When applied to diaphyseal fractures
- The anti-glide effect leads to compression within the fracture with axial loading

- Both neutralize vertical shear forces during axial loading
- Practically speaking, they prevent sliding/shortening of the fracture fragments

# Buttress Plate

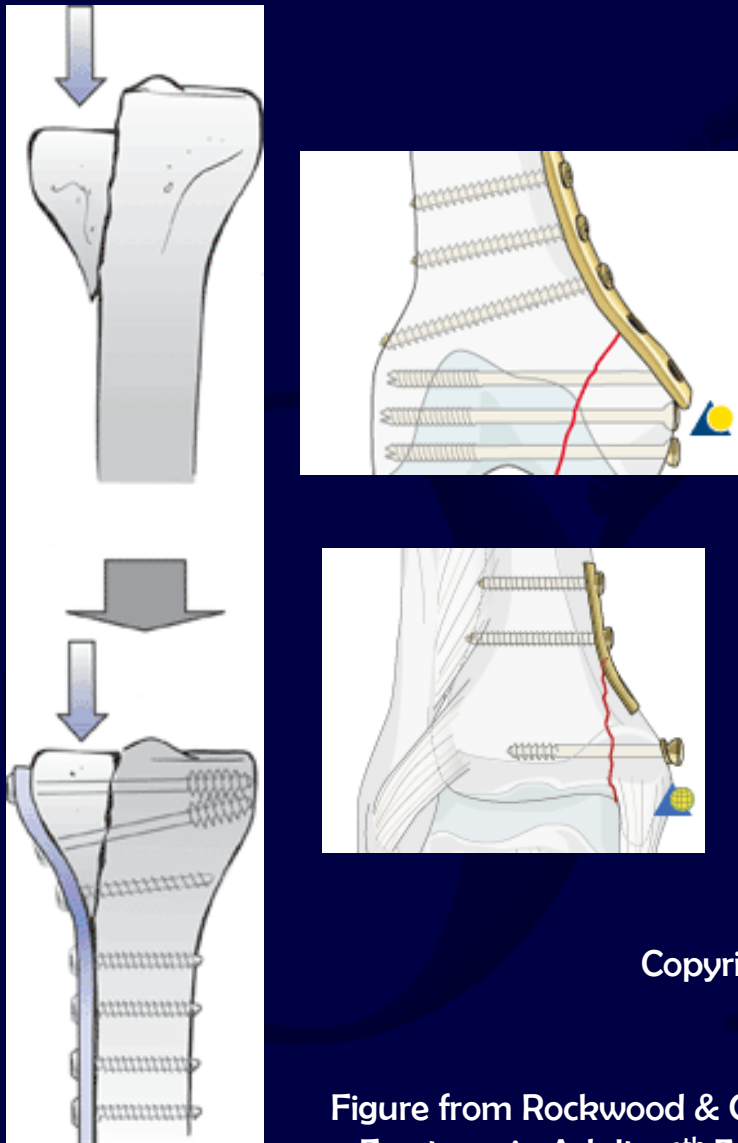

# Anti-glide Plate

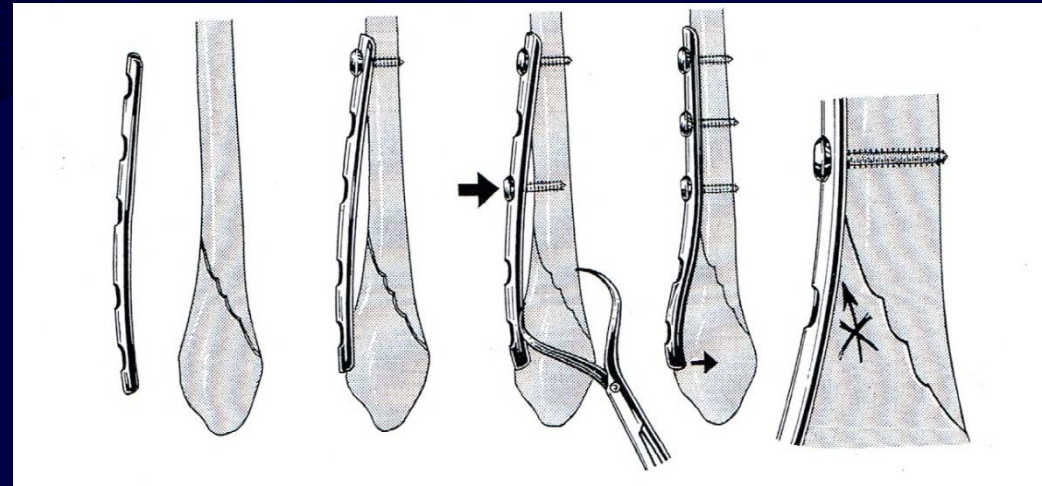

Copyright by AO Foundation, Switzerland

Figure from Rockwood & Green's  
Fractures in Adults, 6<sup>th</sup> Edition

- A buttress effect can also be obtained with a strategically placed screw and washer at the apex of the fracture

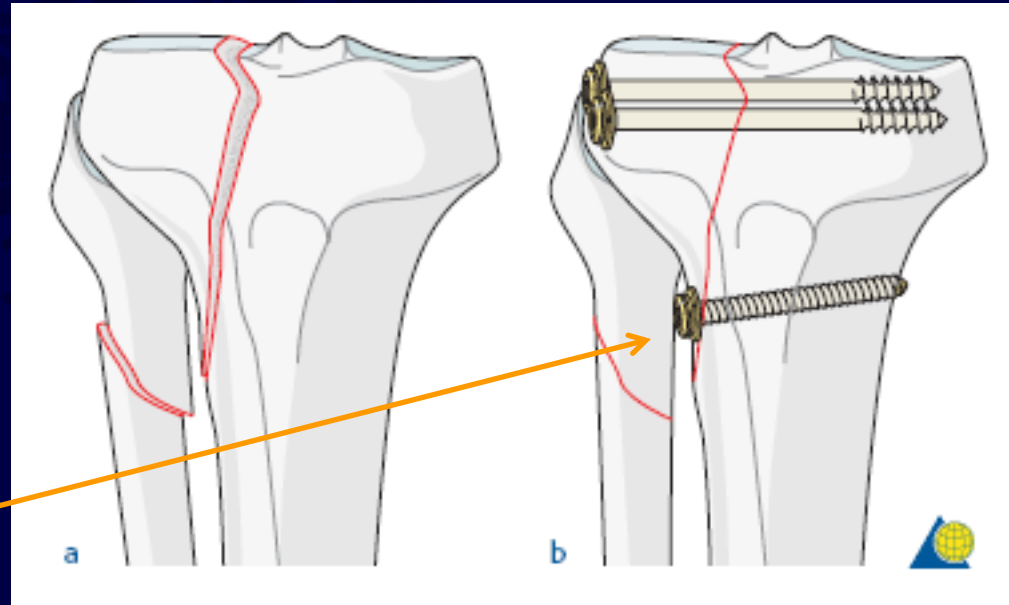

Copyright by AO Foundation, Switzerland



- Plates can be used with or without lag screws to provide buttress
- If plates with DC holes are used, the screw should be inserted in buttress position to prevent plate sliding

Plate prevents sliding of the proximal fragment with axial loading

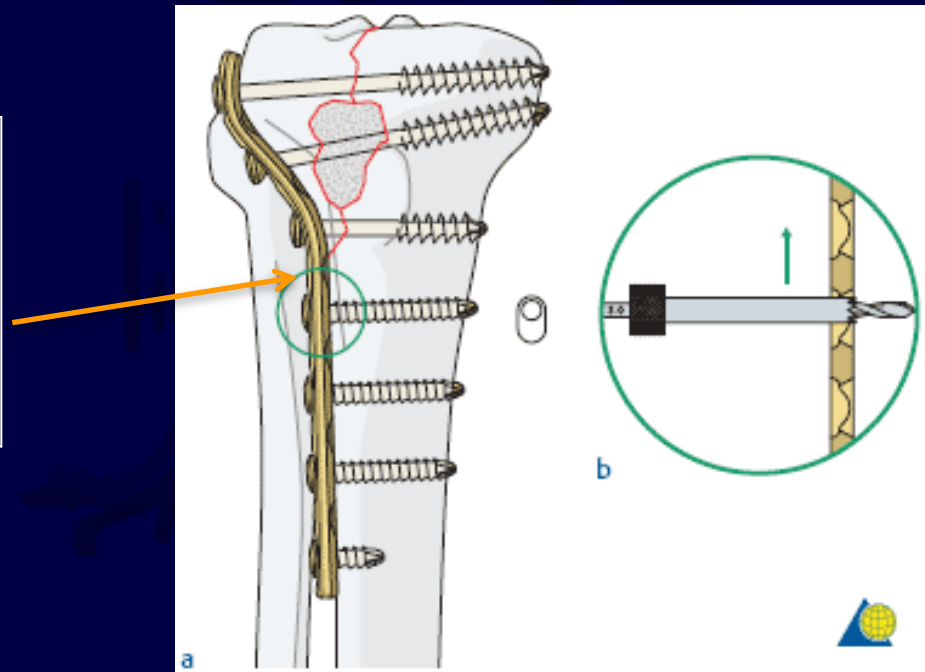

# Plate Function: Tension Band

- Principle: tensile forces are converted into compression forces
- The plate must be applied to the tension (convex) side of the bone
- With loading, the plate will be under tension, thereby compressing the fracture

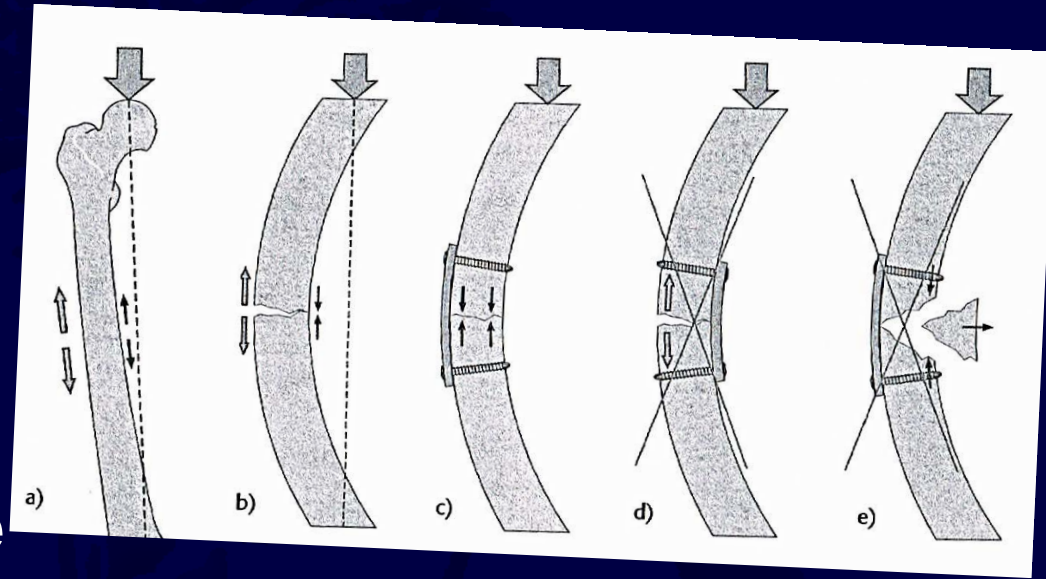

Copyright by AO Foundation, Switzerland

- **In certain articular fractures (e.g. patella, olecranon) where muscle forces during motion tend to distract fracture fragments, the application of a tension band will convert distracting forces into compressive forces with flexion**
- **For ideal tension band effect, the fracture has to be simple and oriented relatively perpendicular to the line of motion**
- **This principle also applies to avulsion fractures that occur at the insertion of tendons or ligaments (i.e. greater tuberosity of humerus, medial malleolus, etc.)**

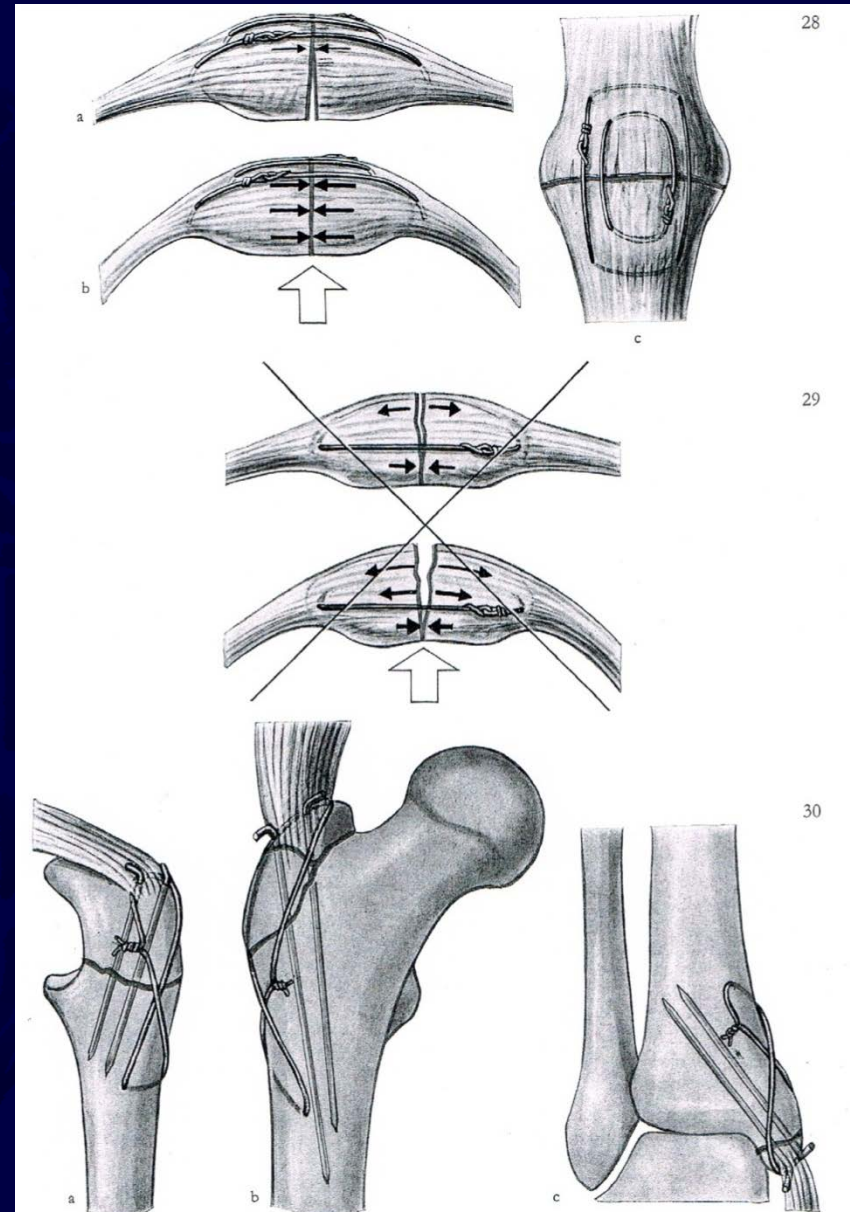

# Plate Function: Compression

- **Compression provides rigid fixation and absolute stability**
- **Especially helpful in transverse fractures, where a lag screw placement is not possible**
- **Compression plating can be accomplished by:**
  - **Plate design (dynamic compression principle)**
  - **Over-bending of the plate**
  - **External tension device**
  - **Combination of the above**
- **Can be used alone or in combination with lag screws:**
  - **Alone – In transverse or short oblique fractures where lag screw placement is difficult**
  - **In combination: compress with the plate prior to lag screw placement**

# Compression: Plate Design

- The screw holes of the plate have an inclination; as the screw is tightened, the head slides down this inclination, thereby compressing the fracture
- This concept is predicated on eccentric (“away from” fracture) screw placement within the oval plate hole, as well as, anchoring the plate first with another screw on the opposite side of the fracture
- DCP, LC-DCP, 1/3 tubular, and reconstruction plates can all compress, but the effect is best with DCP and LC-DCP

# Compression: Plate Design

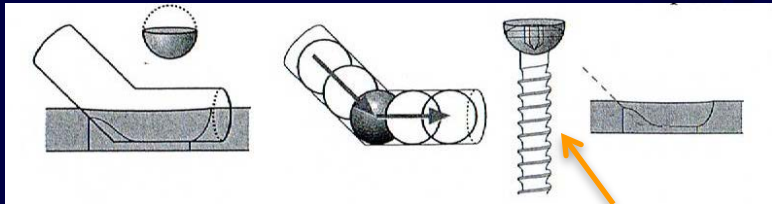

Inclination

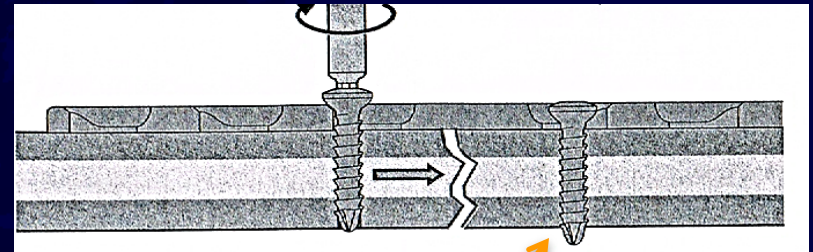

First, affix the plate, ideally with a screw in neutral position, on the opposite side

Eccentric drilling "away from" fracture

Figures from Rockwood & Green's  
Fractures in Adults, 6<sup>th</sup> Edition

# Compression: Plate Bending

- Without pre-bending the plate, there will be compression under the plate and distraction on the opposite cortex
- Pre-bending results in evenly distributed forces across the fracture site

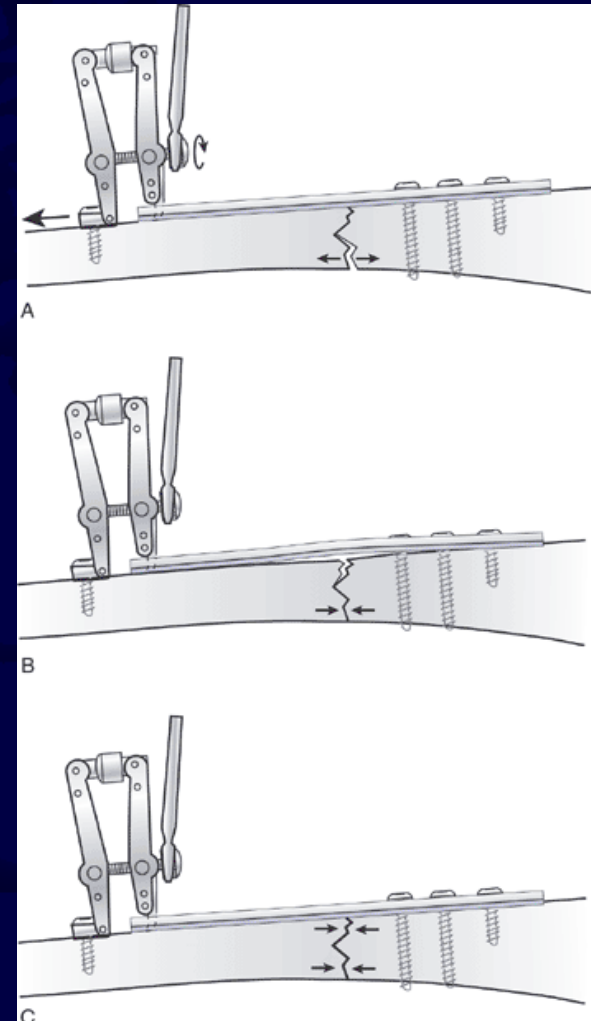
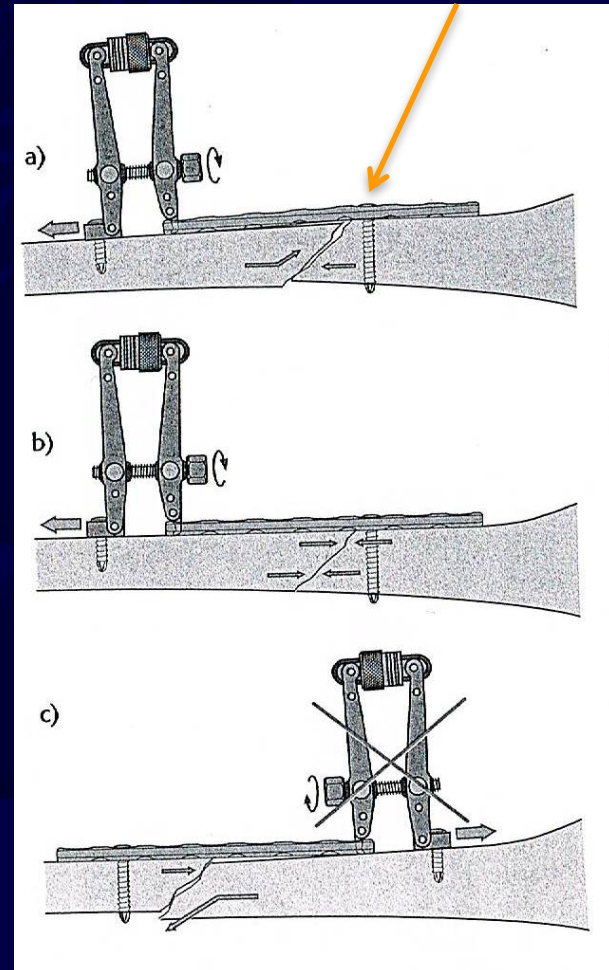

Figure from Rockwood & Green's  
Fractures in Adults, 6<sup>th</sup> Edition

# Compression: Tension Device

Plate axilla is here in this fracture obliquity

- Compression of an oblique fracture must be performed in such a way that the loose fracture fragment locks in the axilla of the plate-bone construct, otherwise, it will lead to mal-reduction





- When a lag screw is placed through a compression plate, compress with the plate first prior to lag screw placement

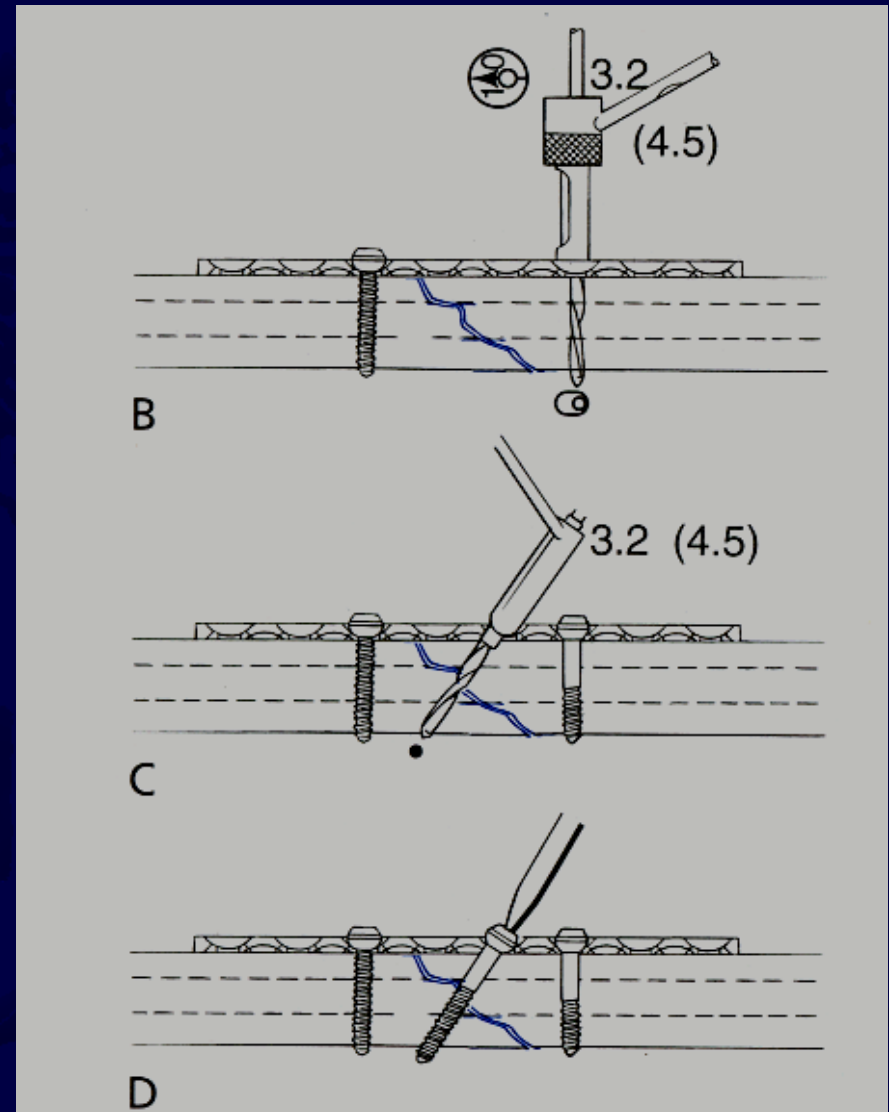
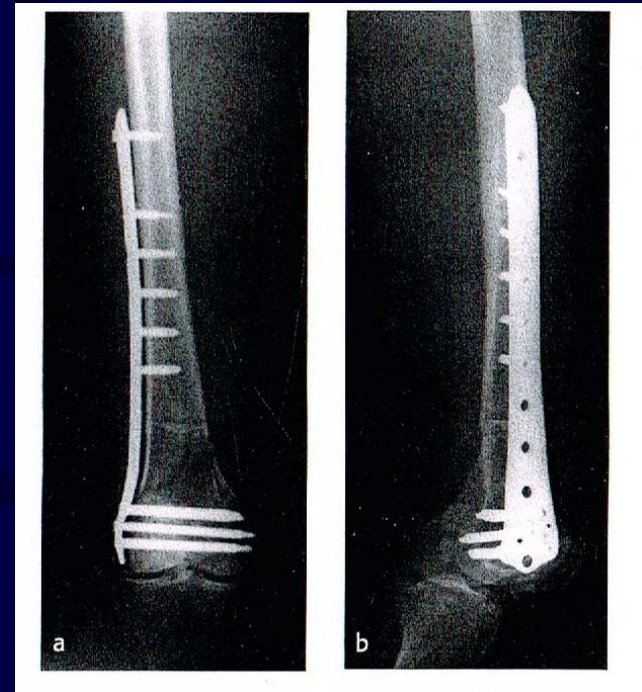
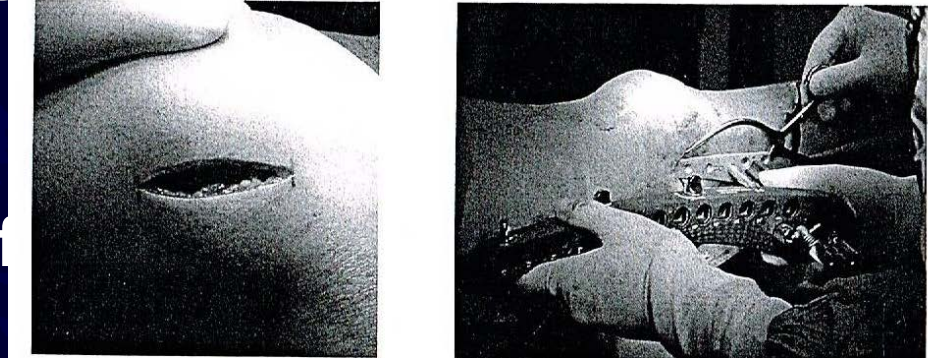

Figure from Rockwood & Green's  
Fractures in Adults, 5<sup>th</sup> Edition

# Plate Function: Bridge

- This technique is suited for highly comminuted metaphyseal or diaphyseal fractures or situations where the overlying soft tissues preclude a direct approach to the fracture
- The goal is:
  - To preserve the fracture biology by “bypassing” the fracture zone
  - Not anatomic reduction and absolute stability, but indirect reduction and relative stability (internal splint)

- If possible minimally invasive plate osteosynthesis principles (MIPO) should be utilized in order to maintain correct length, axial alignment, and rotation of the limb
- Depending on the bone quality, both locking and non-locking plates can be used, although locking plates have the biological advantage of not compressing the periosteum





Proximal and distal fixation with a locking plate

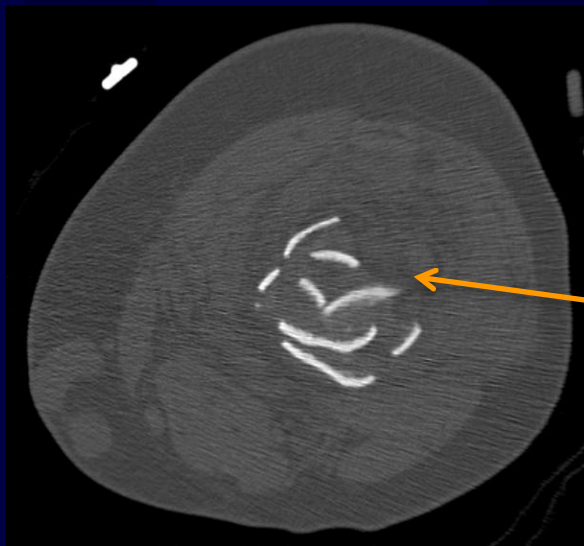

Fracture zone undisturbed



Example of bridge plating in a highly comminuted osteoporotic distal radius fracture



- A plate span ratio of 3 for comminuted fractures and 8-10 for simple fractures should serve as a guide for plate selection

$$\text{Plate span ratio} = \text{Plate length} / \text{Fracture length}$$

- In other words, when bridging a simple fracture, the use of a relatively longer plate and increased screw spread of the innermost screws will result in a lower implant strain

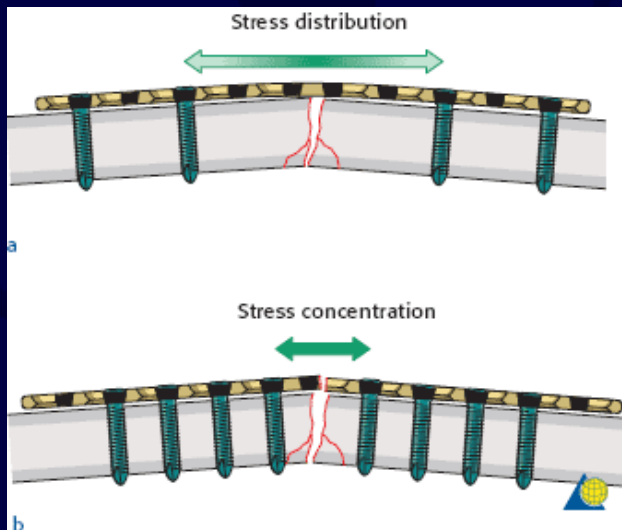
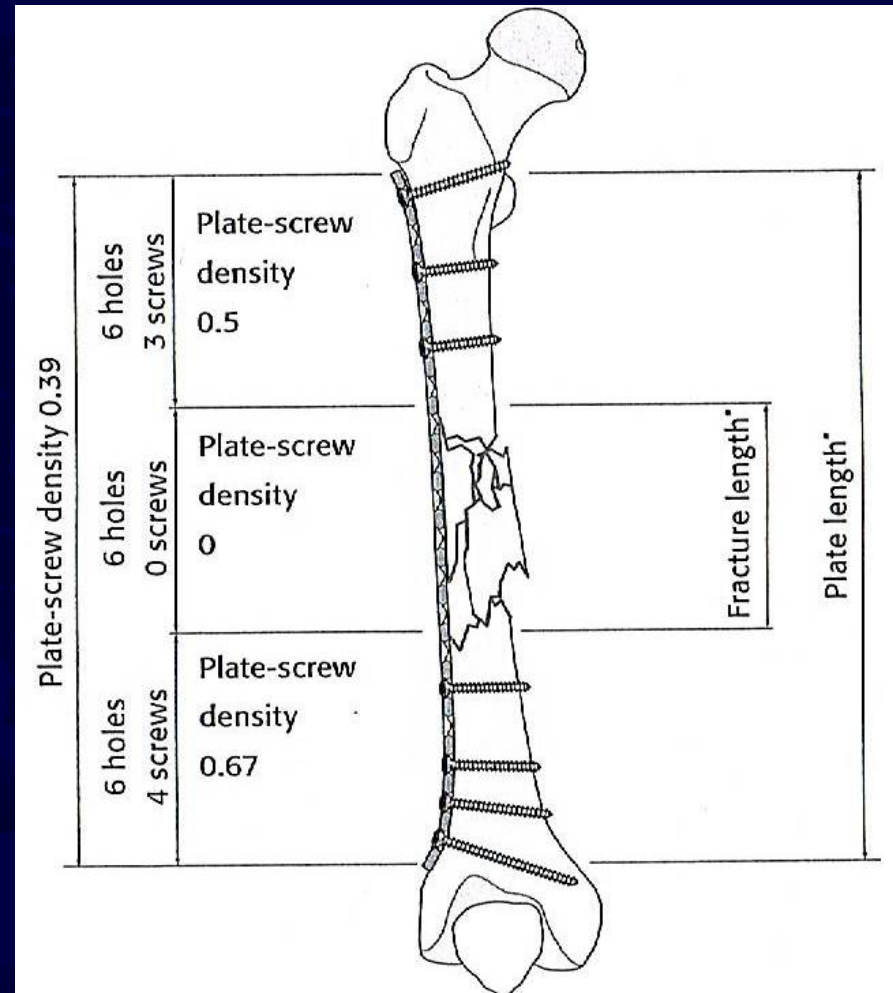

Copyright by AO Foundation,  
Switzerland



Example of bridge plating in a simple femoral shaft fracture which precluded IMN due to pre-existing deformity

# Plate Function: Locking

- In a locking plate, the screw head locks into the plate providing axial and angular stability
- In a locking construct the load is transferred through the entire construct (bone – screw – plate – screw – bone)
- Their failure is typically due to fatigue fracture of the plate

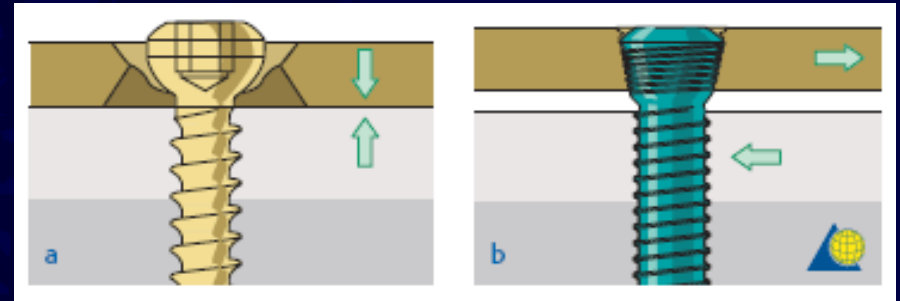

Compression achieves stability

Plate does not crush the periosteum, thus maintaining vascularity

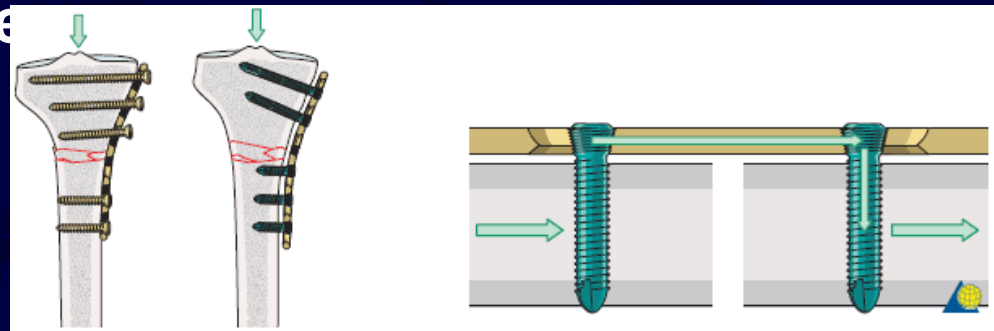



- **Unlike with conventional plates where construct stability is predicated on bi-cortical screw fixation, in a locking construct, bi-cortical fixation is not necessary**
- **However, bi-cortical screws improve fixation in osteoporotic and metaphyseal bone and enhance the torsional stability of the construct**

- **Fracture reduction and compression should be performed prior to locking, i.e. conventional screws should be placed prior to locking screws**
- **The use of a locking plate is advantageous in osteoporotic bone and comminuted meta-diaphyseal fractures treated with bridging**

# Newer Plate Technologies

- Newer plate technologies, with combination holes, enable insertion of both conventional and locking screws through the same plate
- This allows for “hybrid fixation”, where depending on the fracture pattern, absolute and relative stability can be achieved with the use of one implant

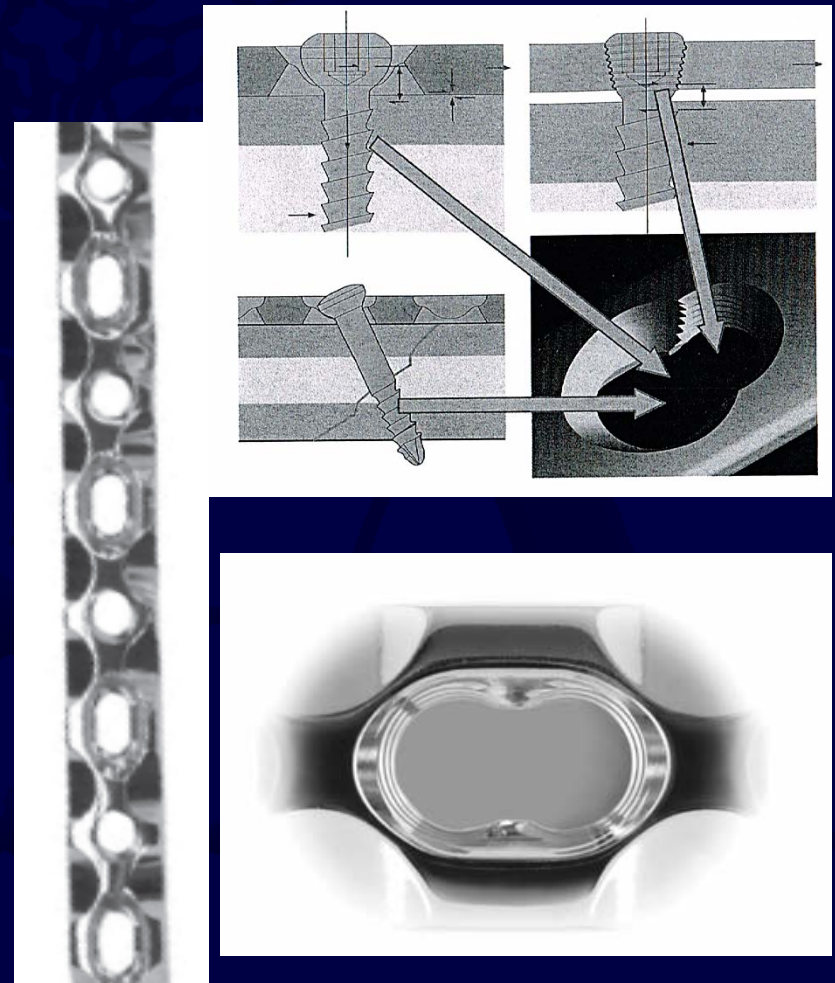

# Anatomical Plates

- Many implant companies provide peri-articular locking, non-locking, and combination- plates, some of which, also enable percutaneous insertion using specifically designed jigs
- Do not rely on plate design for fracture reduction – need to reduce fracture first



# Variable Angle Locking Screws

- Different technologies available
- More flexibility with locking screw insertion
- Potentially less need for additional implants to stabilize a given fracture as screws have a wider “reach” to capture fracture fragments

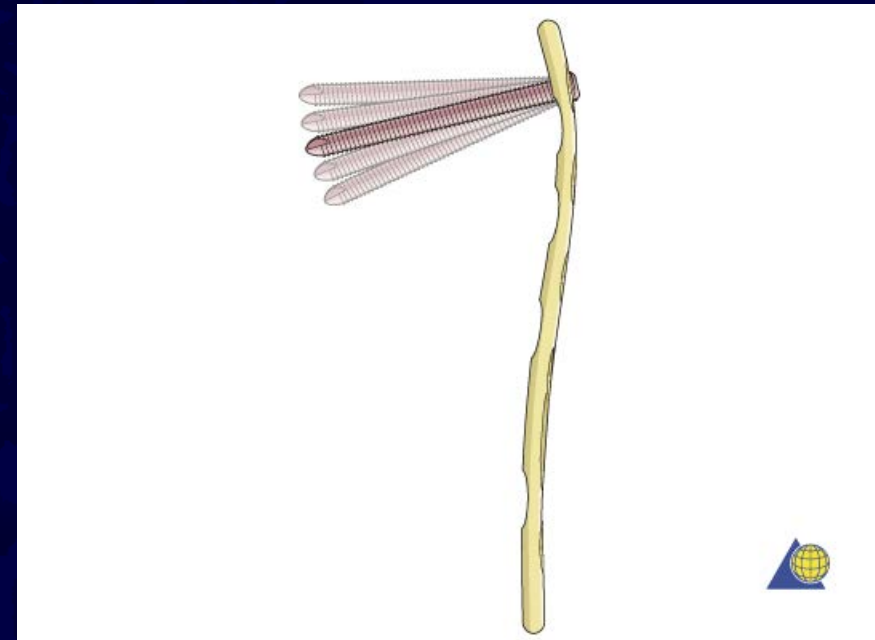

Copyright by AO Foundation,  
Switzerland

# Intramedullary Nailing

- Internal splint
- Indirect reduction and relative stability (callus)
- Goal is to re-establish length, alignment, and rotation of the limb, not anatomic reduction
- Typically done in a minimally invasive fashion
- Load sharing, not load bearing device
- Ideal for femoral and tibial diaphyseal and certain metaphyseal fractures



- **Correct starting point is crucial in IMN: incorrect entry can result in iatrogenic fracture and fracture mal-alignment, especially in proximal and distal fractures**

- **In antegrade nailing of distal femur and tibia fractures the distal position of the ball-tip guide wire should be centered in order to prevent fracture mal-alignment**

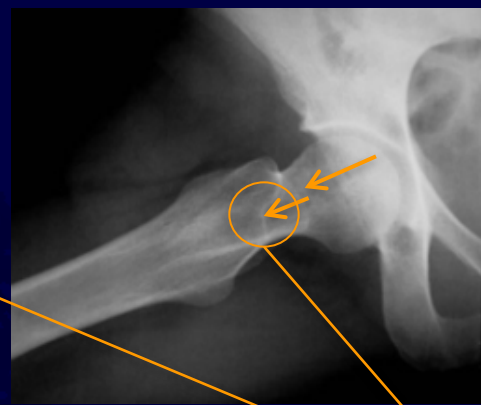
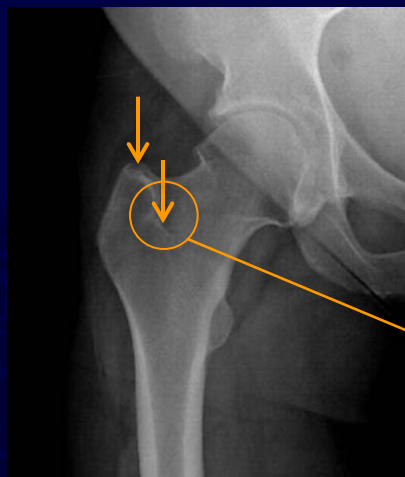

Piriformis Starting point

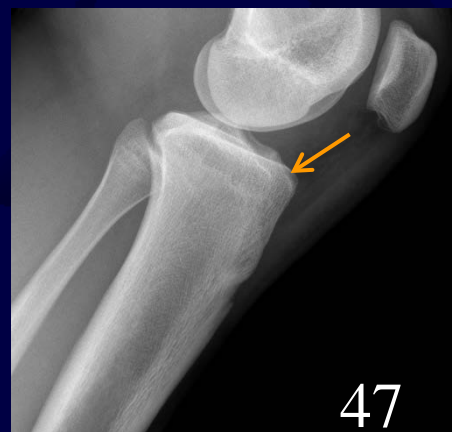
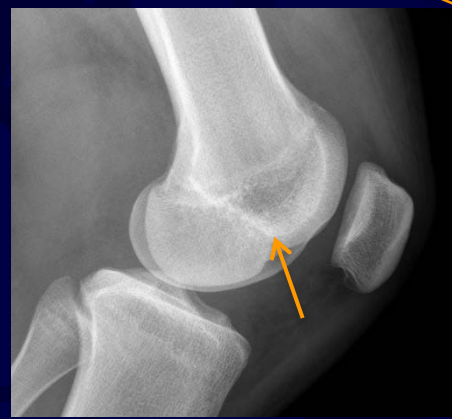

Starting points for antegrade and retrograde femoral IMN, and tibial IMN, respectively.



- **Maintaining length/  
reduction can be  
accomplished by:**
  - **Manual traction**
  - **Skeletal traction**
  - **Fracture table**
  - **Ex-Fix/Femoral  
distractor**
  - **Open reduction/  
provisional plating**
  - **Blocking screws**

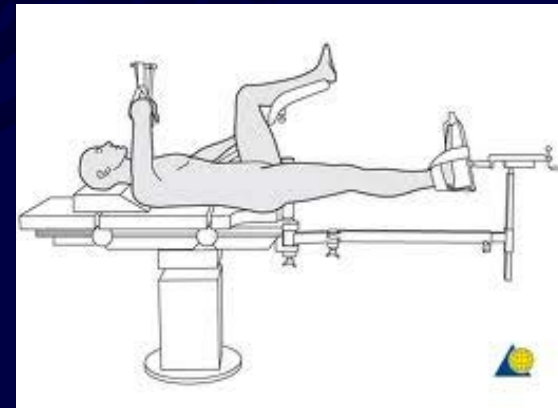
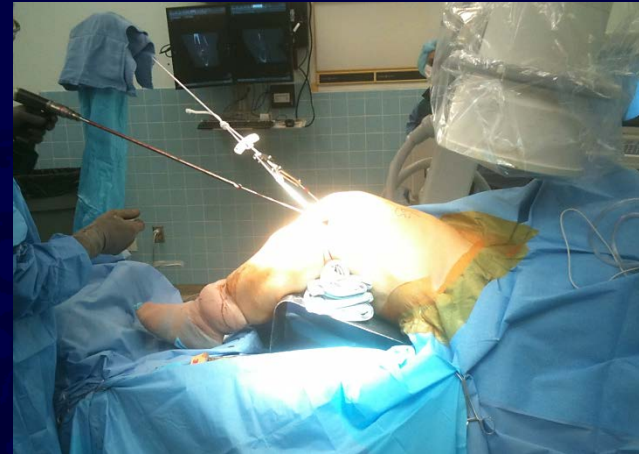

Copyright by  
AO Foundation,  
Switzerland



Skeletal traction during antegrade femoral IMN using a Kirschner bow. Note the K-wire is placed anteriorly so it doesn't block the reamer path



- **If possible, reduction should be done through minimally invasive techniques (i.e. bumps, external pressure, traction, percutaneous techniques)**
- **Occasionally ORIF and supplementary plating can be helpful in achieving and maintaining reduction**
- **Length and rotation can be judged clinically and/or radiographically**



Examples of  
some reduction  
maneuvers

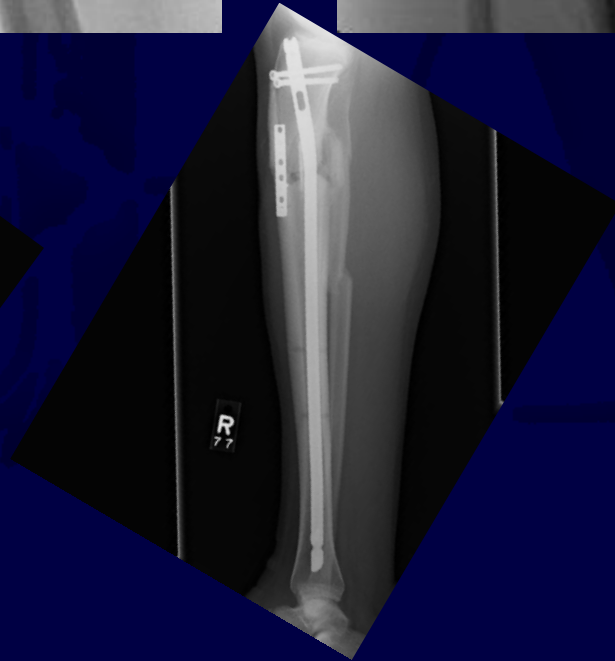
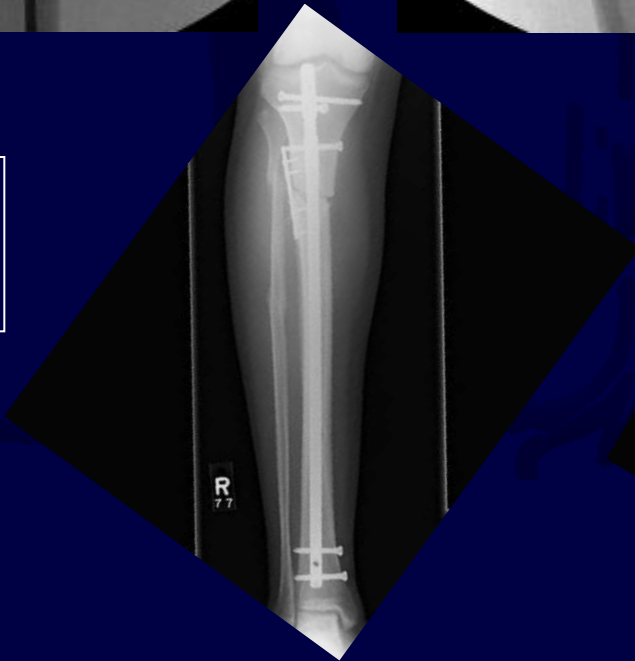

# Intra-operative Assessment of Rotation

- **Cortical thickness**
  - Uneven radiographic cortical thickness indicates malrotation

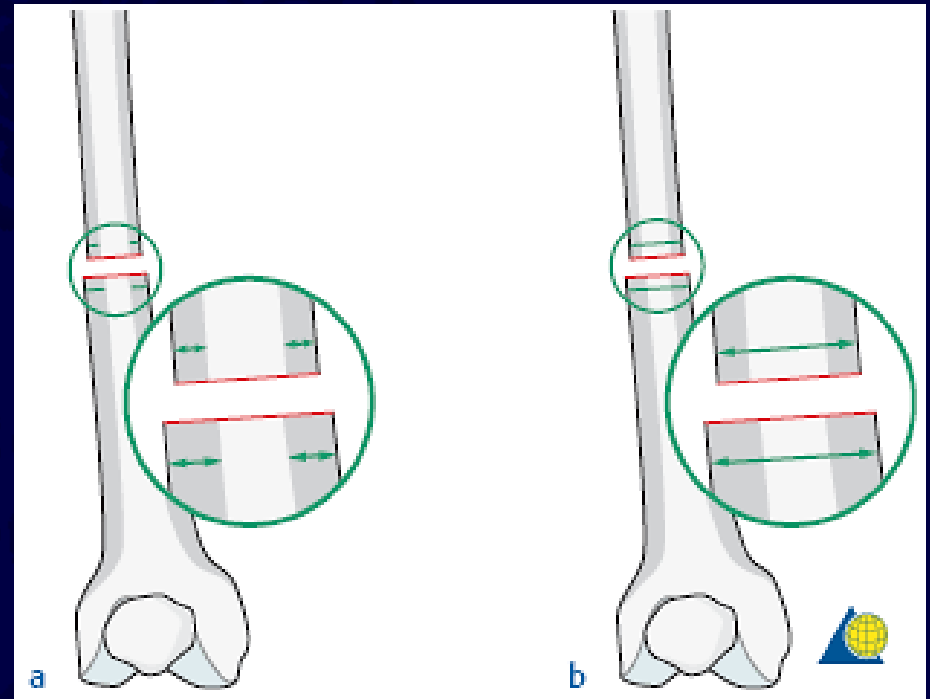

Copyright by AO Foundation,  
Switzerland

# Intra-operative Assessment of Rotation

- **Lesser Trochanter (LT) method**
  1. **An AP of the uninjured knee is obtained; at this position the LT profile is visualized and saved**
    - Alternatively, a true lateral of the knee is obtained, the c-arm is then rotated by 90° to obtain LT profile
  2. **After fracture reduction/fixation, with the knee in the same position, the LT profile of the injured site is compared with the saved reference**
  3. **A smaller profile means the proximal segment is internally rotated (distal segment externally rotated), and vice versa**

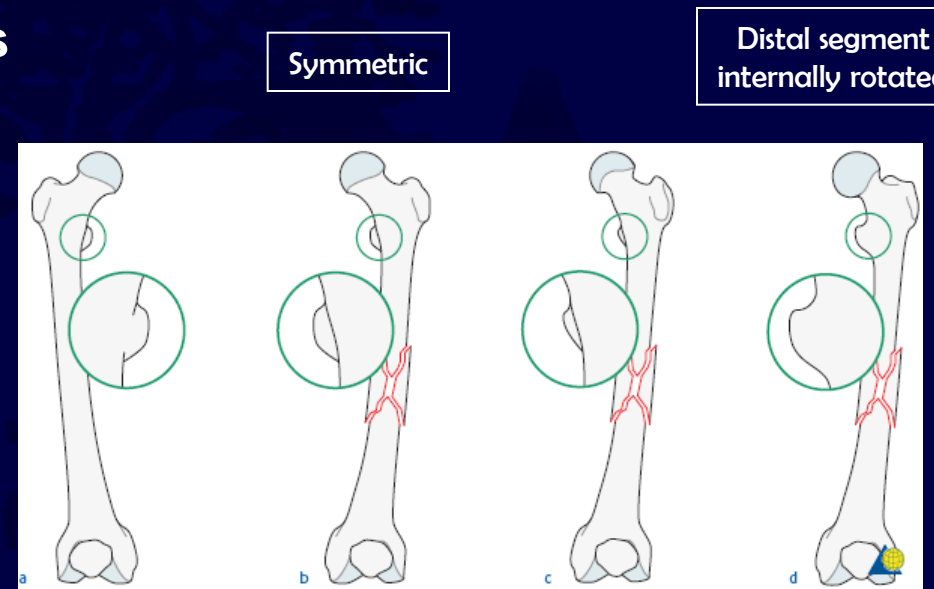

Distal segment  
externally rotated

# Radiographic Assessment of Axial Alignment

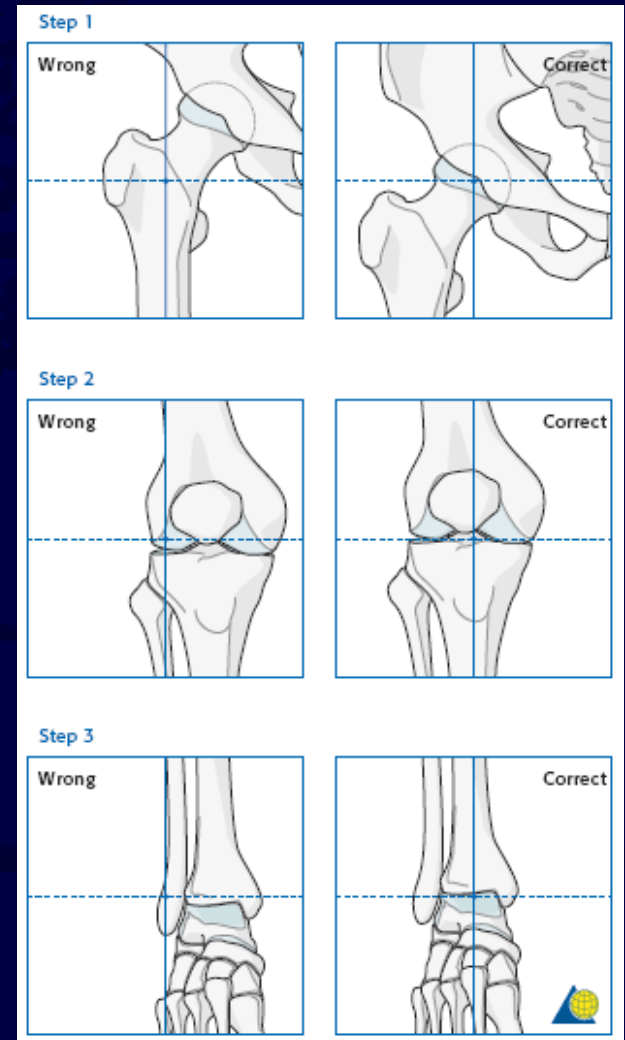
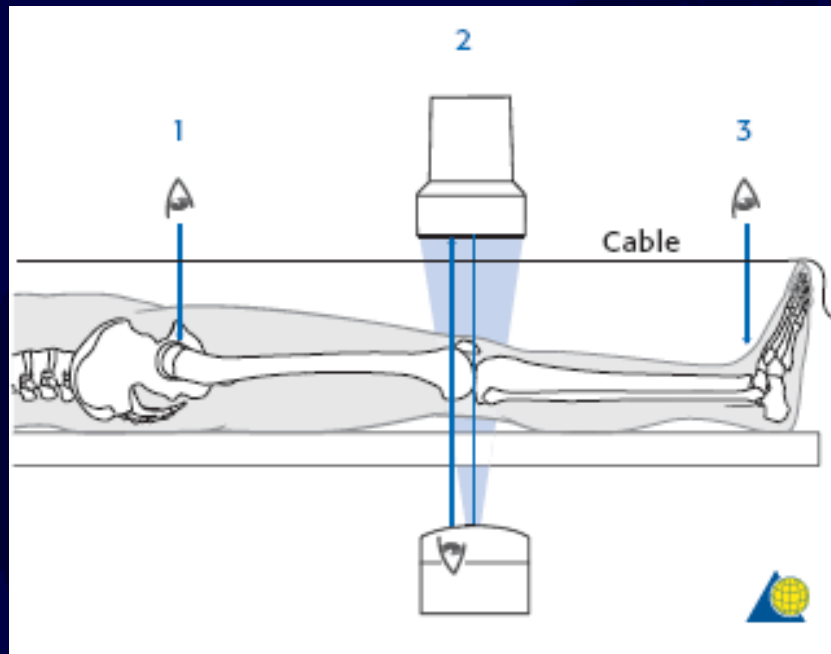

Copyright by AO Foundation,  
Switzerland

# Poller/Blocking Screw

Copyright by AO Foundation

- Especially helpful for more distal or proximal fractures where there is a larger discrepancy between nail and canal diameter. They:
  - Decrease the width of the intramedullary canal, forcing the nail to the center of the bone
  - Are ideally placed in the “concavity” of the deformity, in the short (metaphyseal) fragment
  - Can be used for alignment, manipulation, and construct stabilization by providing intramedullary 3-point fixation

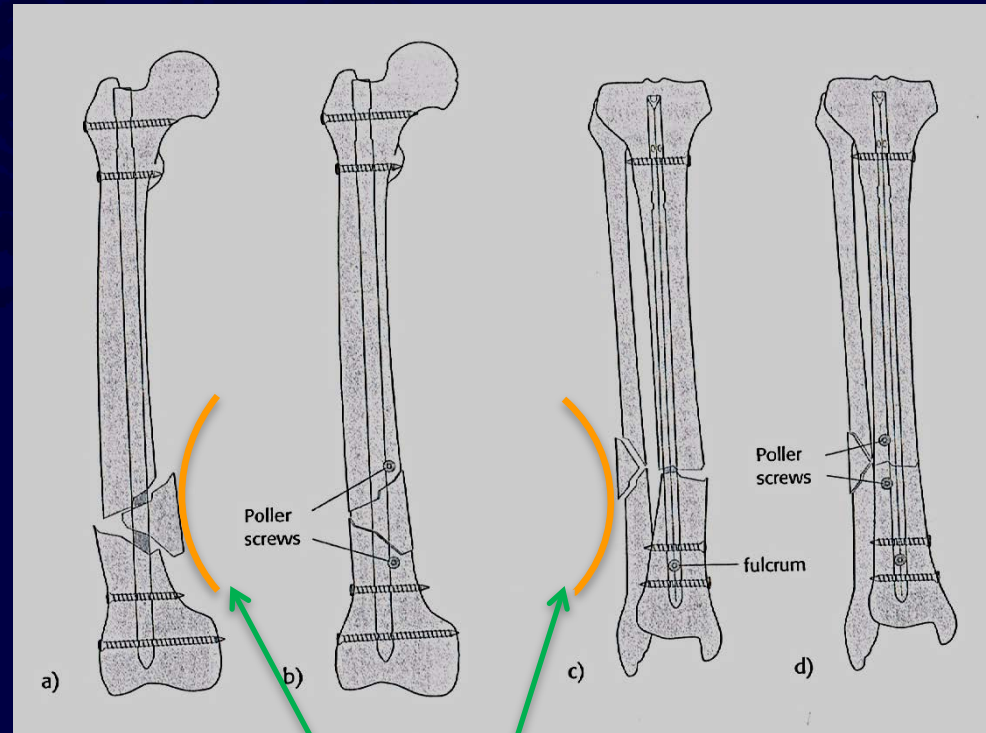

Screws are placed on the “concave” side of the fracture deformity

- **Length and rotation may be difficult to judge in comminuted, segmental, and bilateral fractures**
- **In bilateral fractures, where a contralateral reference is not available, if possible, start with the easier side**
- **Interlocking increases axial and torsional stability of the construct**

# Summary

- **Fracture personality and patient factors determine the fixation construct**
- **Generally speaking, simple fracture patterns and articular injuries are treated with direct/anatomic reduction and absolute stability**
- **Complex and comminuted fracture patterns are treated with indirect reduction and relative stability**
- **The goal in relative stability (bridge plating, IMN) is restoration of length, alignment, and rotation**
- **Regardless of approach, reduction, and fixation, always respect the soft tissues**



# Thank you

If you would like to volunteer as an author for the Resident Slide Project or recommend updates to any of the following slides, please send an e-mail to [ota@ota.org](mailto:ota@ota.org)

E-mail OTA  
about  
Questions/Comments

Return to  
General/Principles  
Index

