

CHAPTER 7

BASIC SEAMANSHIP

To ensure safety at sea, the best that science can devise and that naval organization can provide must be regarded only as an aid, and never as a substitute for good seamanship, self-reliance, and sense of ultimate responsibility which are the first requisites in a seaman...

—C.W. Nimitz
Letter to U.S. Pacific Fleet
13 February 1945

At this stage in your Navy career, you're learning thousands of things entirely new to you. You're probably finding it hard to assign relative importance to them. The importance of these skills and knowledge will become more obvious the longer you're in the Navy. This is true because the most important things will be emphasized in your day-to-day living. If you're not assigned to the deck force, you may think that seamanship is not important. Well, you're wrong!

Seamanship ties every member of the Navy together. The uniform worn by Navy members, from seaman to admiral, implies that the wearer has a certain degree of proficiency in the art of seamanship. The fact that you may later become an Electronics Technician doesn't change the fact that you're first a seaman and then a technician. Be as proud of your ability as a seaman as you are of your ability to perform your other duties.

Even though you don't work on deck everyday, there will be times, particularly on small ships, when you will be required to assist the deck force. You may have to carry stores, assist in replenishment-at-sea operations, assist in mooring to or untying a ship from the pier, and so forth. When working as part of the deck force, you'll be expected to have a general idea of what's going on, how and why a task is being accomplished, and be able to carry out orders intelligently. Therefore, take every opportunity to observe and learn as much as you can about seamanship. This chapter provides only basic seamanship information.

In this chapter, seamanship is divided into the following basic sections—deck, boat, and marlinespike seamanship.

- Deck seamanship concerns the general work that goes on about the ship's deck and the equipment used. Anchoring, mooring, rigging and handling

heavy weights and cargo, underway replenishment, towing, and a host of other skills are considered deck seamanship.

- Boat seamanship, as the name implies, concerns the handling of boats.
- Marlinespike seamanship concerns the use and care of line and consists of forming knots, making splices, and fashioning useful and decorative articles from small stuff and twine.

DECK SEAMANSHIP

Learning Objective: When you finish this chapter, you will be able to—

- Identify deck equipment and recognize their purpose.

Deck equipment consists of all equipment used in the application of deck seamanship, which is work normally performed by the deck force. You need to know shipboard equipment and terminology because you may be called on to assist the deck force in various seamanship evolutions. To help you, some of the more familiar items of deck equipment are discussed in this section.

GROUND TACKLE

Ground tackle is the equipment used in anchoring and mooring with anchors. It includes anchors, anchor cables and chains, and associated equipment, such as chain stoppers, bending shackles, outboard swivel shots, and detachable links. Figure 7-1 shows a typical ground tackle arrangement on a forecastle.

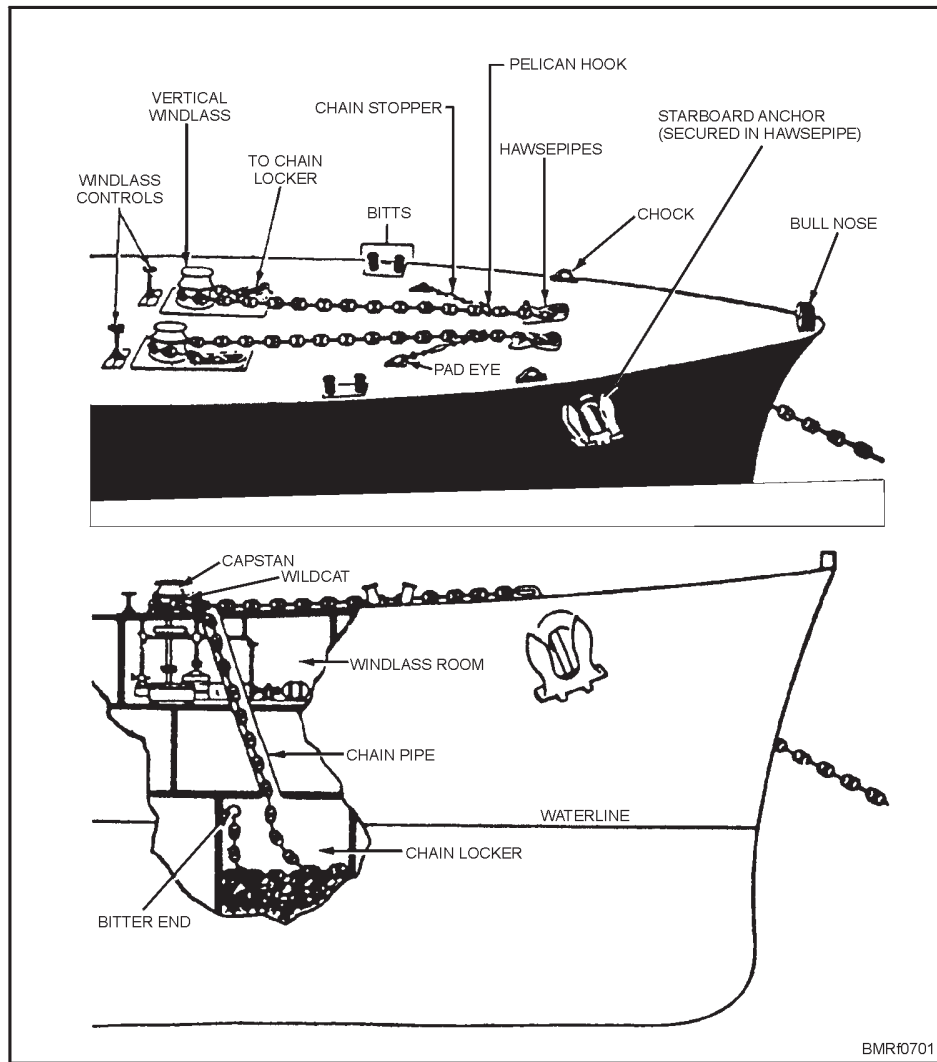

Figure 7-1.—Typical ground tackle and chain stowage.

ANCHORS

Anchors can be defined by their stowage locations aboard ship or by their type of construction. Bower anchors are carried on the bow and are secured (housed) in the hawsepipes. Stern anchors are carried on the stern. On landing ships and craft, stern anchors are secured to the stern and are used to help pull away from beaches.

The most common types of anchors used aboard ship are the stockless and the lightweight (or stock-in-crown) anchors. The two anchors shown in figure 7-2 are of Navy design. The stockless types are used chiefly as bow anchors (bowers) on most Navy

ships. Originally, the lightweight types were used only on small boats and as stern anchors of landing ships and craft. However, recently they are carried as bowers for several types of vessels.

ANCHOR CHAIN

Modern Navy anchor chain consists of studded links of high strength steel. (Studs are crosspieces of metal forged or welded in the center of the links to prevent the chain from kinking.) Chains are made up of 15-fathom (90-foot) sections called *standard shots*. The number of shots per chain depends on the size of the ship. Shots are secured together by detachable links that

Student Notes:

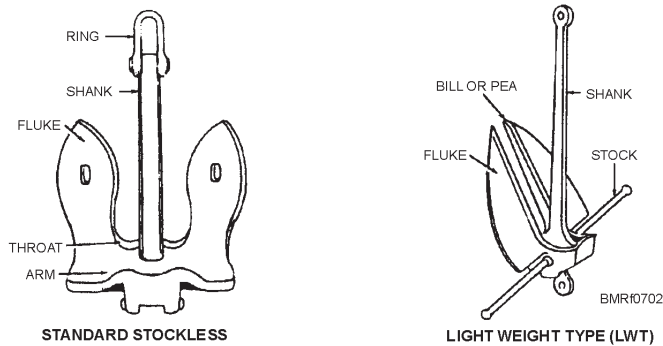

Figure 7-2.—Anchors.

can be readily disassembled whenever it is desirable to break the chain.

STOWING CHAIN

As the chain comes aboard, it passes along the deck on metal flash plates, over the wildcat, and down into the chain locker. Each chain goes into a bin called a chain locker, as shown in figure 7-1. Its *bitter end* is secured to a ring bolt on the bulkhead of the chain locker.

ANCHOR WINDLASSES

The Navy uses two types of anchor windlasses for lifting the ship's anchor—the vertical shaft type and the horizontal shaft type (fig. 7-3). The vertical shaft type is used on most combatant ships. The horizontal shaft type is used on amphibious and auxiliary ships. Both types are equipped with wildcats, which engage the links of the anchor chain. The wildcat may be disengaged when

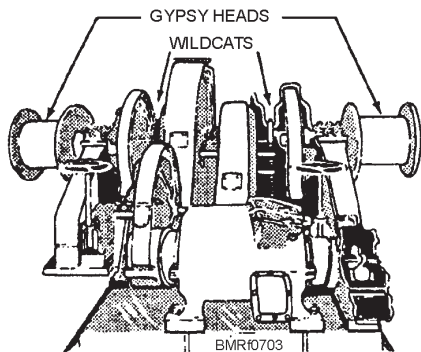

Figure 7-3.—Horizontal shaft anchor windlass.

it is desired to use the capstan (vertical type) or the gypsy heads (horizontal type) for handling lines or wire.

ACCOMMODATION LADDER

Frequently, the accommodation ladder is mistakenly called the gangway. However, gangway actually means *the opening in a bulwark or life rail that gives access to a brow or an accommodation ladder*. An accommodation ladder (fig. 7-4) consists essentially of an upper and a lower platform connected by a ladder. The lower end is supported, raised, and lowered by a block and tackle (called *falls*) and is usually suspended from a davit.

Brow is the Navy term for gangplank. Brows are ramps used between ships and between a ship and pier. They may be simply two or three wooden planks fastened together, or they may be elaborate affairs with handrails and wheels at one or both ends to prevent a ship's motion from unduly affecting the positioning of the brow.

MOORING LINES

A ship is moored when it's made fast to a buoy, when it's between two buoys, when it's between two anchors, or when it's secured by lines alongside a pier or another ship.

The lines used in mooring a ship alongside a pier are shown in figure 7-5. Well in advance of mooring, the lines should be faked down, fore and aft, each near the chock through which it passes in preparation for passing the line. You will learn about the procedure for faking a

Student Notes:

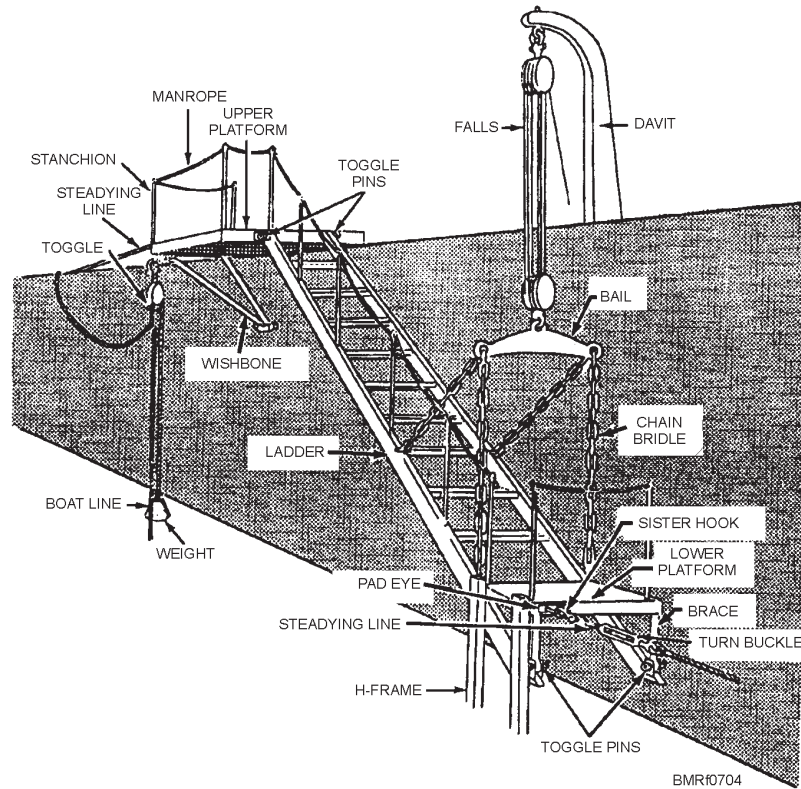

Figure 7-4.—A rigged accommodation ladder.

line and a description of deck fittings later in this chapter.

Rat guards are hinged conical metal shields secured around mooring lines. They are used to prevent rats from coming aboard ship.

The bowline and forward spring lines prevent the ship from drifting astern. The stern line and after spring lines prevent the ship from drifting forward. Look at figure 7-5. Here, lines 1, 3, and 5 are called *forward lines*; lines 2, 4, and 6 are called *after lines*. When secured, these lines tend to breast the ship in. The forward and after spring lines are used to prevent the ship from drifting forward or aft.

NOTE

The various types of line and wire rope are discussed in the “Marlinespike Seamanship” section of this chapter.

Teamwork is essential in carrying out the mooring operation. Lines must not be kinked or fouled. Keep control of the lines and avoid dipping them into the water. **Remember, observe all safety precautions!**

If the ship is to remain moored for a long period, lines are doubled up and bound together with marline hitches, and rat guards are placed on each line. Look at figure 7-6. To provide protection to the side of the ship while it is alongside a pier, *camels* (large wooden logs or rectangular structures) (views B and C) are often placed between the pier and the ship. *Fenders* (large cylindrical objects of rubber or fibrous material) (views A and D) are swung over the side of the ship to give bumper support against damage whenever a ship lies alongside another ship or a pier.

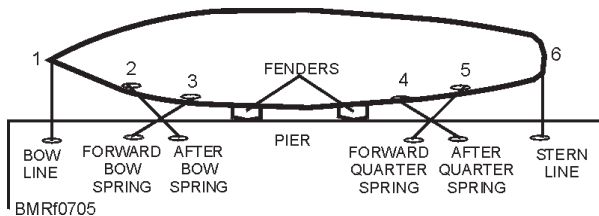

Figure 7-5.—Ship’s mooring lines.

Student Notes:

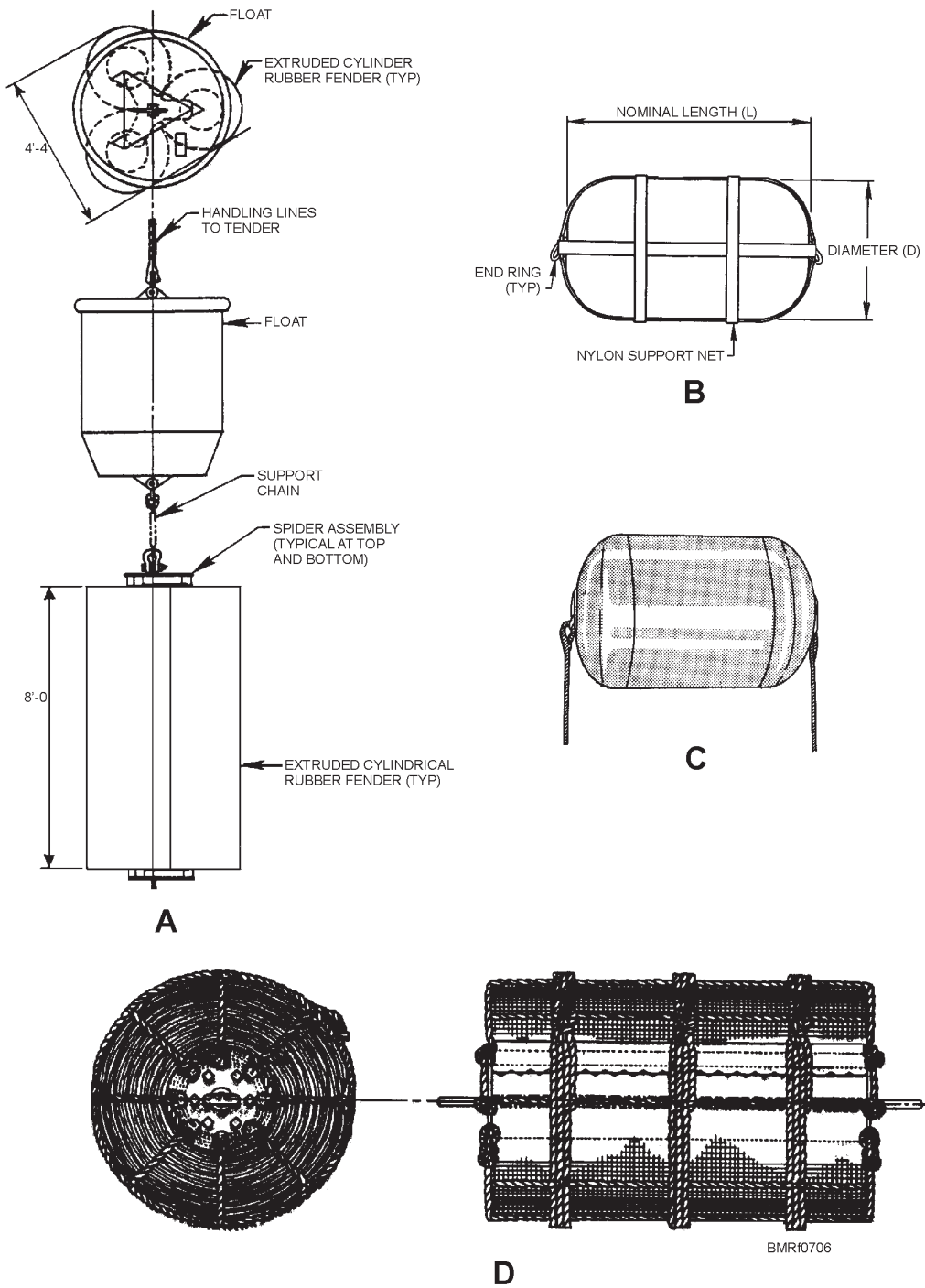

Figure 7-6.—Protection for the side of a ship.

DECK FITTINGS

Deck fittings are used aboard ships and boats mainly for the securing of mooring lines. All fittings shown in figure 7-7 are found aboard ship except the bollard, which is a pier fitting. The pad eye shown in the figure is not used for mooring but for towing other vessels. Different variations of the pad eye are used for securing heavy objects and equipment.

DAVITS

Boats carried aboard ships usually are handled by powerful cranes and booms. These cranes and booms hook onto slings attached to hoisting points built into the strong parts of the boat's structure. Boats stowed at davits are lowered and hoisted by the davit machinery. Basically, a set of davits is nothing more than a special crane that is designed specifically for handling boats in a safe and timely manner.

BOAT BOOMS

Ships that are at anchor or moored to a buoy rig out their boat booms for the purpose of mooring their boats well clear of the side. This method of securing is known as *hauling out to the boom*. Forward booms are called *lower booms*; after booms are called *quarter booms*.

The boat boom shown in figure 7-8 is a spar that is secured to a gooseneck by a pin on the side of the ship. This arrangement allows free motion fore and aft. The outboard end of the boom hangs from a wire vang and tackle combination called the *topping lift*. Fore-and-aft

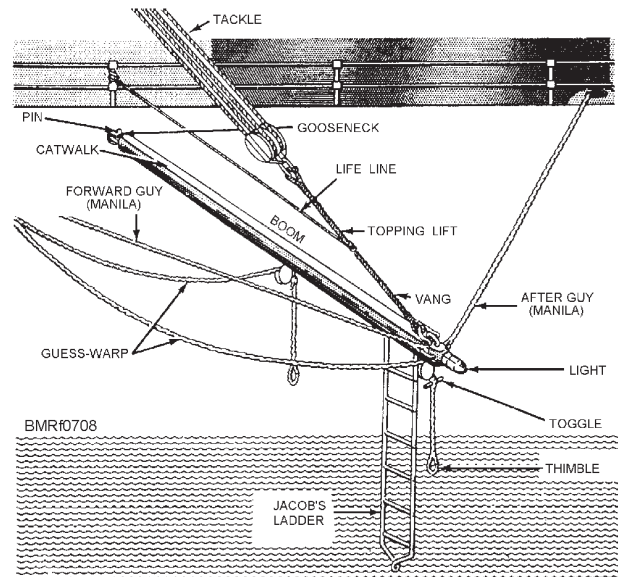

Figure 7-8.—Parts of a boat boom.

motion is controlled by lines called *forward* and *after guys*.

A strong line called a *guess-warp* runs from well forward on the ship out through a block or blocks on the boom and ends in a metal thimble through which boats can reeve (pass) their bowlines. A small piece of wood called a *toggle* is seized between strands of the guess-warp above the thimble to keep it from running up out of reach when a boat lets go. One or more *Jacob's ladders* (a rope ladder) from the boom permit boat crews to come aboard.

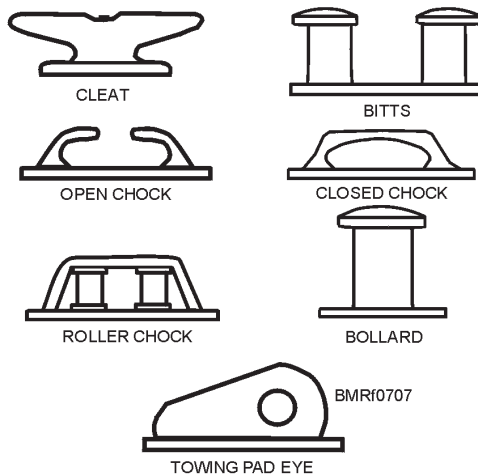

Figure 7-7.—Deck fittings.

REVIEW 1 QUESTIONS

- Q1. List six types of ground tackle used aboard ships.
- -
 -
 -

Student Notes:

- e.
- f.

Q2. Where are bower anchors located?

Q3. List the standard parts of the mooring line used to secure a normal sized ship at a pier.

- a.
- b.
- c.
- d.
- e.
- f.

Q4. Aboard ship, deck fittings are used for—

Q5. While anchored, what deck equipment is used to moor the ship's boat?

BOAT SEAMANSHIP

Learning Objectives: When you finish this chapter, you will be able to—

- Identify various types of boats, service craft, and combatant craft to include boat terms and nomenclature.
- Identify safety practices for boat passengers.

Boat seamanship is much more than a knowledge of the kinds of boats in operation in the Navy. Boat crews are responsible for the safe operation and upkeep of

Student Notes:

their craft and must receive training in a number of areas. Some of the techniques to be mastered require much practice and experience before a boat crew can become accomplished in their assigned duties. If you are assigned to duties as a member of a boat crew, you should study the *Seaman and Boatswain's Mate 3 & 2* training manuals and complete the required personnel qualification standards (PQS).

Boats used by the Navy are of three general groups—support craft, combatant craft, and boats in general. Each group may be determined by its assigned mission and by its type, design, and construction. Chapter 8 has detailed information about these craft.

BOATS

The term *boat* refers to a noncommissioned waterborne vessel that is not designated as a service craft. A boat is capable of limited independent operation. Officer/personnel boats, motor whaleboats, and utility boats fit into this group. Boats carried aboard ship that can be hoisted from and lowered into the water are known as *ship's boats*.

SERVICE CRAFT

The term *service craft* (figs. 7-9 and 7-10) is applied to waterborne craft that are designed for special use. Harbor tugs, ferryboats, various nonself-propelled barges, and floating dry docks are designated service craft.

COMBATANT CRAFT

Combatant craft are craft or boats specifically designed for combat roles. Figures 7-11 and 7-12 show a variety of patrol, riverine, amphibious warfare, and special combatant craft.

BOAT SAFETY

Because the majority of Navy personnel are concerned with small boats only in the role of passengers, this section is written from the standpoint of passengers, rather than crew members. Every Sailor should be familiar with the following boat safety precautions:

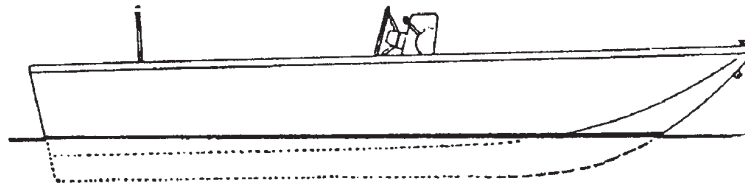

18-FOOT UTILITY BOAT

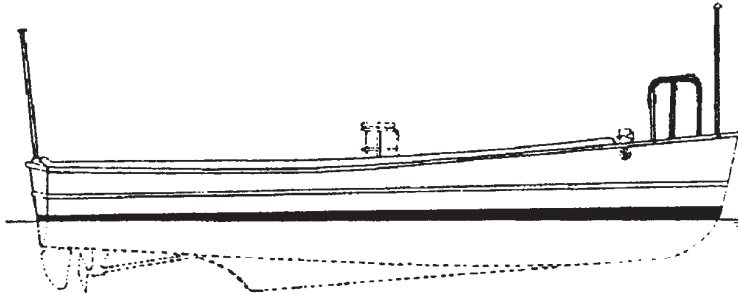

33-FOOT UTILITY BOAT

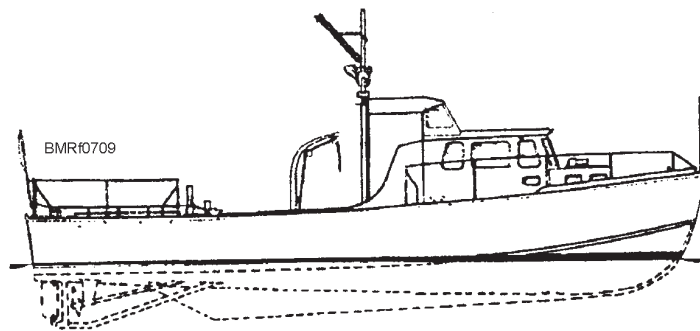

45-FOOT UTILITY BOAT

Figure 7-9.—Boats and service craft of the U.S. Navy.

- Embark in a quiet, orderly manner and move as far forward as possible. Once embarked, stay in place. Keep all parts of your body in the boat; do not perch on the gunwales.
- Don't engage in horseplay.
- Never needlessly distract the attention of crew members from their duties.
- Don't sit on life jackets—to do so mats the filler and reduces buoyancy.
- When told to do so, don your life jacket immediately.
- Don't smoke in a boat.
- During heavy weather, boat loads must be reduced.
- If told not to embark or requested to disembark, do so without argument

Student Notes:

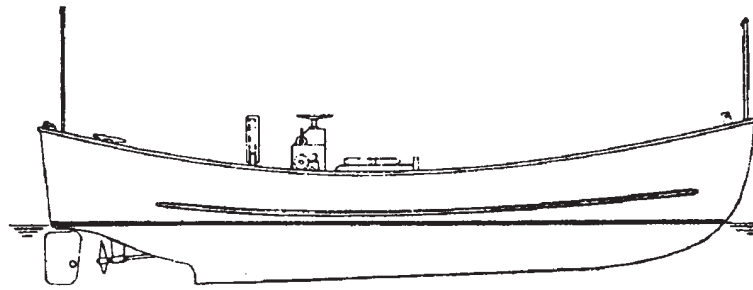

26-FOOT MOTOR WHALE BOAT

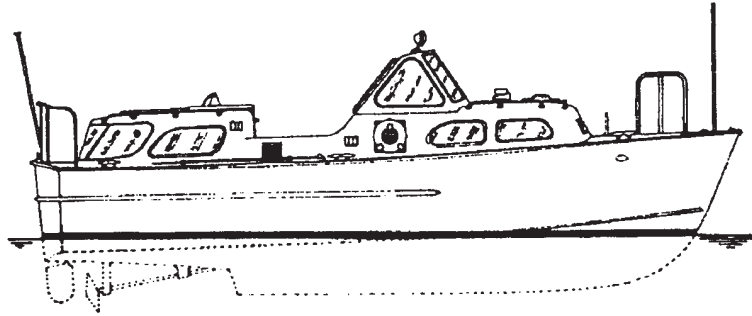

33-FOOT PERSONNEL BOAT

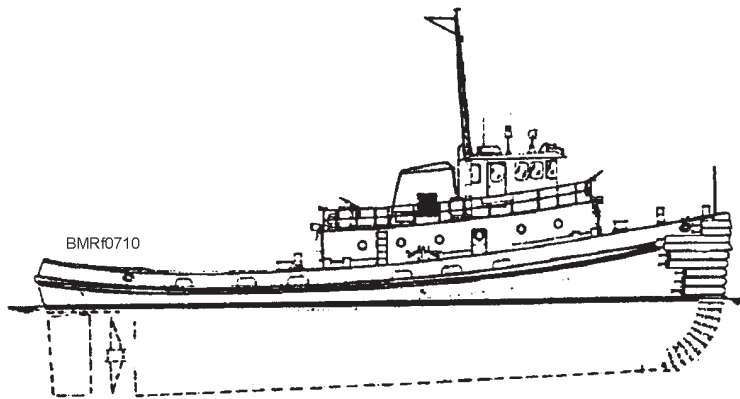

109-FOOT HARBOR TUG (YT)

Figure 7-10.—Boats and service craft of the U.S. Navy (Continued).

- If a boat swamps or capsizes, don't panic. Fear is transmitted easily from person to person, and a terrified individual drowns easily. Never strike out alone.
- Never strike out alone. Stay with the boat or huddle with other passengers because a large group can be found much more easily than individual swimmers.

BOAT TERMS AND NOMENCLATURE

Boat crew members often develop the habit of calling objects and the activities around them by their proper names. In times of emergency, your understanding and correct response to such terms could save valuable time.

Abaft. Any part of the boat aft of amidships.

After end (aft). The after end (aft) of a boat is the stern.

Student Notes:

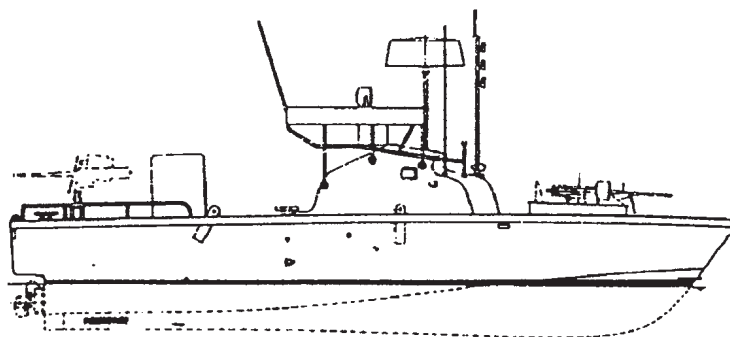

31-FOOT PATROL BOAT,
RIVER (PBR)

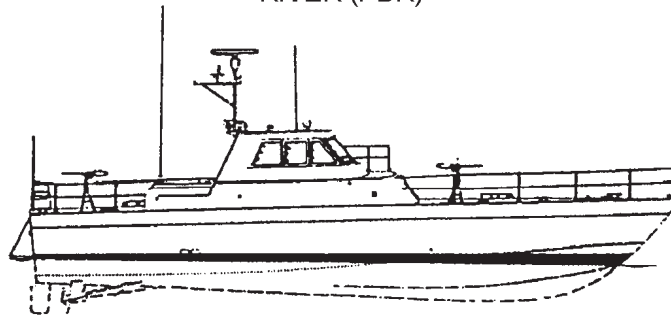

65-FOOT PATROL BOAT (PB)

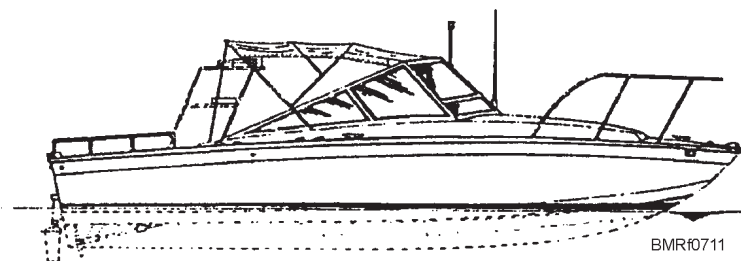

32-FOOT HARBOR SECURITY
PATROL BOAT (HSPB)

Figure 7-11.—Combatant craft of the U.S. Navy.

Amidships. Amidships is a point about halfway between the bow and stern and the sides of the boat.

Athwartships. When something is said to be *athwartships*, it's across the boat from side to side.

Forward end (fore). The forward end (fore) of the boat is the *bow*.

Inboard. Inboard usually describes the area inside the boat or an object nearer the centerline of the boat.

Outboard. Outboard describes the area furthest from the boat's centerline or beyond the side of a boat.

Starboard. When facing forward of the boat, your right-hand side is the starboard.

Port. When you are facing forward of the boat, your left-hand side is the port.

Figure 7-13 shows a 26-foot personnel boat with features that are similar to most Navy boats.

Student Notes:

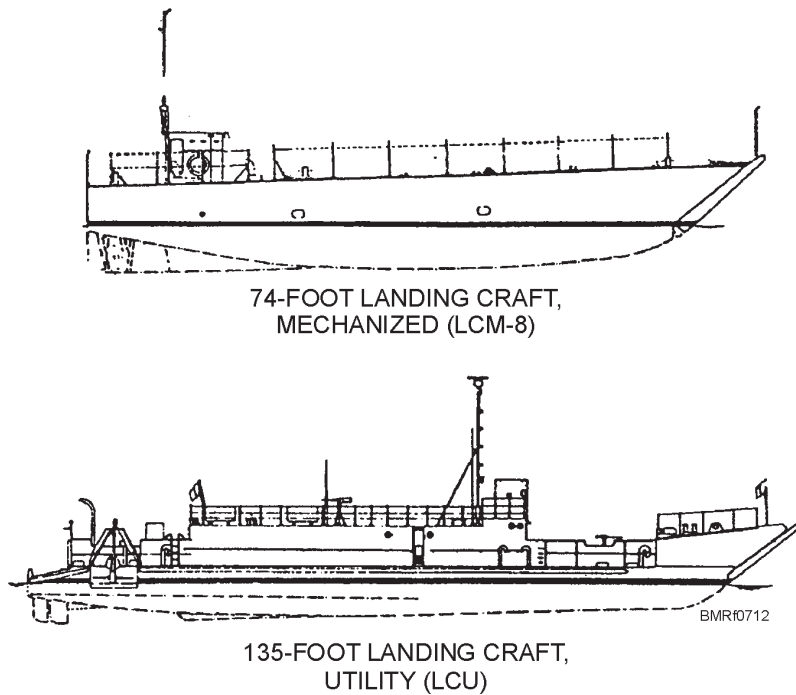

Figure 7-12.—Combatant craft of the U.S. Navy (Continued).

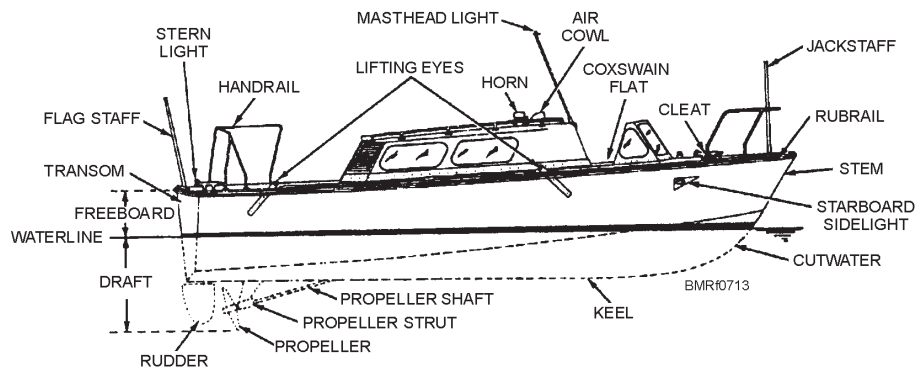

Figure 7-13.—Boat nomenclature.

By studying the nomenclature shown in figure 7-13, you will become familiar with much of the deck and hull equipment used on Navy boats. The glossary in appendix I of this training material will help you identify some of the terms.

REVIEW 2 QUESTIONS

- Q1. List two types of combatant craft .
- a.
 - b.

Student Notes:

- Q2. As a boat passenger, you should obey the orders of what person(s)?
- Q3. If a boat capsizes while you're a passenger, you shouldn't panic for what reason?
- Q4. What does the term *athwartships* mean?

MARLINESPIKE SEAMANSHIP

Learning Objectives: When you finish this chapter, you will be able to—

- Identify the purpose of various types of line and rope.
- Recognize the procedures used to tie knots, bends and hitches, and to make splices.
- Identify the procedures for securing at sea.

Marlinespike seamanship is the art of handling and working all kinds of fiber and wire rope. *Rope* is a general term and can include both fiber and wire rope. In the Navy, Sailors generally refer to fiber rope as *line*, and wire rope is referred to as *rope*, *wire rope*, or *wire*. A better definition of a line is as follows: *A line is a length of rope, either fiber or wire, that is in use or has been cut for a specific purpose, such as a lifeline, heaving line, or lead line.* A few such lines have the word *rope* in their names, such as wheel rope, foot rope, and bell rope.

In sailing ships, the fiber ropes that gave athwartship support for the masts were so numerous that they actually shrouded the tops of the masts from the view of an observer on deck, hence, the name *shroud*. Stays, the fore and aft supports, were not so numerous, but there were several on each ship. Running rigging, tackles used to hoist and trim (adjust) the sails and handle cargo and other heavy weights, spanned the areas between sails, yards and decks, and yards and bulwarks. Lines secured the guns to the ship's sides and prevented them from rolling or recoiling across the gun

decks. Gun tackles were used to haul the guns back into battery (firing position) after the guns were fired. Even the anchor cable was made of line. Obviously, line played a vital role in those ships.

In today's Navy, line isn't used as much as on sailing ships; however, it's still an important and expensive item. Therefore, every Sailor needs to learn the proper use and care of all kinds of line and wire rope. Today's Navy uses line made of fiber (natural and artificial); wire rope made of steel, phosphor bronze, and other metal; and a combination of wire and fiber (spring-lay).

Lines made from a variety of natural fibers have seen service in the Navy, but most have been replaced by lines made of synthetic fibers. The two most commonly used lines made of natural fibers are marline (tarred hemp fibers) and manila (abaca plant fibers). Manila line was formerly authorized for use only where great strength was required, such as mooring lines, towing lines, personnel transfers at sea and boatfalls. Fiber ropes made of tarred hemp are used in seizing, worming, serving ropes, and lashing. For most applications, nylon line (synthetic fiber) has replaced manila. Nylon line is about 2 1/2 times as strong as manila of the same size, has a greater strength and elasticity, and has a higher resistance to weather.

Wire rope usually is substituted for line where the line is subjected to a great deal of wear, weathering, or heat, and where greater strength is required. Spring lay is used for mooring lines, particularly at the bow and stern.

FIBER LINE

Any rope that is not wire is fiber rope. Except in a few instances where it has special uses, **fiber rope is never called anything but line aboard ship.**

Lines are classified by both their construction and their material. Nearly all line used in the Navy is three-strand line.

Line is made by twisting fibers into threads (or yarns), threads into strands, and strands into rope. Taking the process further, ropes twisted together form a cable—an item seldom seen nowadays. Most of our lines are three-strand and right-laid; that is, as you look

Student Notes:

along a line, the twist is to the right. During construction of natural fiber line, a lubricant is added that also serves as a preservative.

Large line is measured by circumference. Line 1 3/4 inches and under in circumference, called *small stuff*, is identified by the number of threads in the line. A line with twenty-four thread is 1 1/2 inches in circumference. Inasmuch as the numbers of threads per strand are equal, thread numbers in a three-strand line are divisible by 3—24, 21, 18, and so on, down to the smallest—6 thread (3/4 inch). Line from 1 3/4 inches to about 4 inches is manufactured in 1/4-inch graduations. The length of all line and wire rope is usually measured in feet.

The chart shown below lists tips on the care of natural fiber line. You should be thoroughly familiar with them and observe them at all times.

NYLON LINE

Most of the tips for the care of natural fiber line should be observed with nylon line. Nylon, however, is not subject to mildew. It should be scrubbed if it becomes slippery because of oil or grease.

A stretch of one third of its length is normal for nylon line under safe working loads. Nylon stretches about 50 percent before it will break. Because of its elasticity, nylon line breaks with a decided snapback; therefore, stand well clear when it is under a heavy strain.

NEVER	ALWAYS
Stow wet or damp line in an unventilated compartment or cover it so that it cannot dry. Mildew will form and weaken the fibers.	Dry line before stowing it.
Subject line to intense heat nor unnecessarily allow it to lie in the hot sun. The lubricant (natural oils) will dry out, thus shortening the useful life of the line.	Protect line from weather when possible.
Subject a line to loads exceeding its safe working load. To do so may not break the line, but individual fibers will break, reducing the strength.	Use chafing gear (canvas, short lengths of old firehose, and so on) where line (or wire) runs over sharp edges or rough surfaces.
Allow line to bear on sharp edges or run over rough surfaces. The line will be cut or worn, reducing the strength and useful life.	Slack off taut lines when it rains. Wet line shrinks, and if the line is taut, the resulting strain may be enough to break some of the fibers.
Scrub line. The lubricant will be washed away, and caustics in strong soap may harm the fibers.	Coil right-laid line to the right (clockwise).
Put a strain on a line with a kink in it.	Inspect a line before using it. Overworked or overstrained line will have a bristly surface. Mildew can be seen, and it has peculiar, unpleasant odor. Untwist the line so that the inner parts of the strands can be seen. If they have a dull, grayish look, the line is unsafe.
Try to lubricate line. The lubricant you add may do more harm than good.	Give line the care it deserves—someday your safety may depend on it.

Student Notes:

CAUTION

Snapback is extremely dangerous and has caused severe injuries and death. The utmost caution must be observed when working with or around all synthetic lines.

WIRE ROPE

The basic unit of wire rope construction is the individual wire, which is made of steel or other metal and comes in various sizes. These wires are laid together to form strands. The number of wires in a strand varies according to the purpose of the rope. A number of strands are laid together to form the wire rope itself.

Wire rope is designated by the number of strands per rope and the number of wires per strand. For example, a 6 by 19 rope will have 6 strands with 19 wires per strand. It may have the same outside diameter as a 6 by 37 wire rope, which will have 6 strands with 37 wires of much smaller size per strand. The more wires per strand, the more flexible the rope. Rope with fewer and larger wires per strand is more resistant to external abrasion.

The strands of the wire rope are laid up around a central core, which may be only a single wire, a single strand of wire, or hemp. A hemp core contributes flexibility, cushions the strands as the wire rope contracts under strain, and holds a portion of lubricant for continuous lubrication. A wire core is stronger than

hemp and can be used where conditions, such as high temperatures, would damage a hemp core.

WHIPPINGS

Whippings are bindings on the ends of rope that keep the rope from unlaying. On line, whippings are made with cord, such as sail twine or with marline. The ends of all line must be whipped because of the frequent need for passing the ends through rings and pad eyes and for reeving them through blocks. Unlaid and frayed ends of line are unsightly and unseamanlike and waste many feet of line. Knots or backsplices in the end of a line are not allowed, nor are friction tape or wire whippings. Knots and backsplices will jam in a block; friction tape will not hold for long; and wire may tear a line-handler's hands.

The most secure whipping is made with the aid of a sail needle and palm. However, an excellent whipping can be made without a needle if the procedure shown in figure 7-14 is followed. First, lay one end of the whipping along the line, bind it down with a couple of turns, and snug up the edges. Then lay the other end on in an opposite direction with the body portion of the whipping, continuing with several more turns from the bight of the whipping. The whipping length should be about equal to the diameter of the line being whipped. Snug up the edges and cut off the twine close to the line. This type of whipping is a temporary one. If the line is to

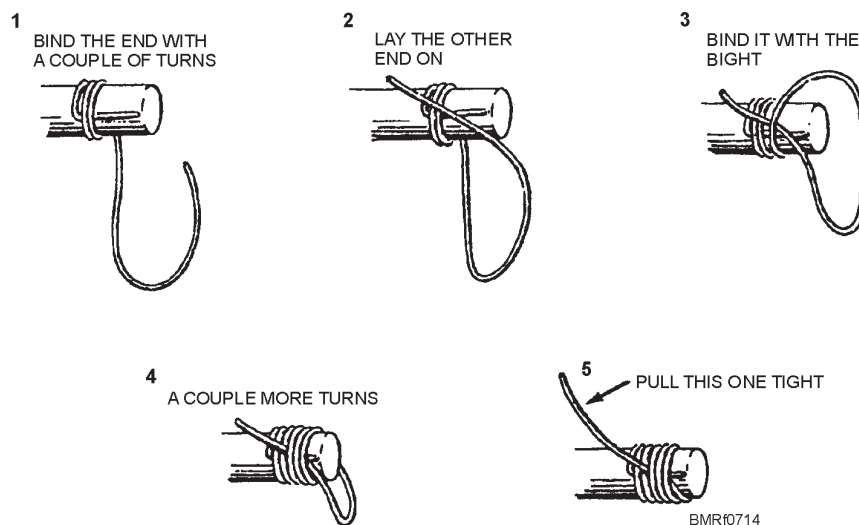

Figure 7-14.—Plain whipping a line.

Student Notes:

be used frequently, a permanent whipping should be used.

KNOTS, BENDS, AND HITCHES

Except among seamen, the word *knot* is ordinarily used as an all-inclusive term, covering the more specific use of knots plus bends and hitches. Even seamen find it hard to clearly define the terms *knot*, *bend*, and *hitch* because their functions overlap like the bowline knot and many other instances. In general, however, the terms may be defined as follows:

Knots. Knots are used to form eyes or to secure a cord or line around an object, such as a package. In other words, the line is bent to itself.

Hitches. Hitches are used to bend a line to or around an object, such as a ring, spar, or stanchion.

Bends. Bends are used to secure two lines together.

All Navy personnel should know the square knot, bowline, single- and double-becket bends, round turn and two half hitches, and clove hitch. Navy personnel should know when these knots, bends, and hitches are used. Before reading further, look at figure 7-15, which shows a few terms that make it easier for you to understand the following procedures.

Square Knot

The square knot, also known as the *reef knot* from its use in reefing sails, is quickly and easily made and has a great many uses. It will not slip, but it can jam under heavy strain. It can be loosened, however, by pulling on first one and then the other end. Figure 7-16 shows steps in making a square knot.

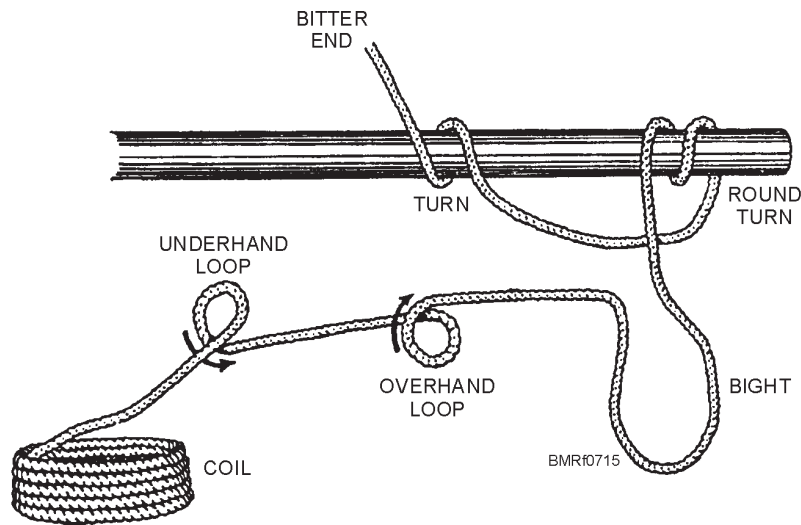

Figure 7-15.—Elements of knots, bends, and hitches.

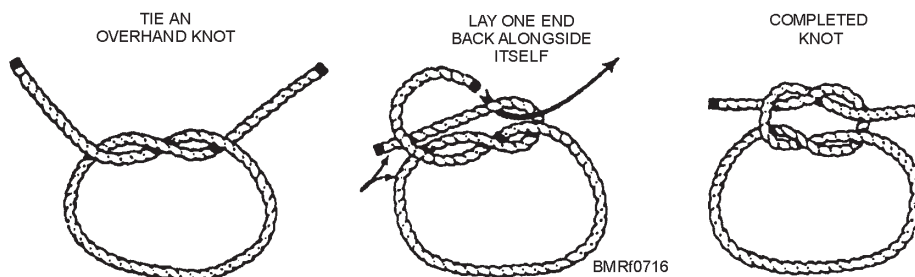

Figure 7-16.—Square knot.

Student Notes:

Bowline

The bowline, with its many variations, has a lot of uses. Its chief use is to form an eye; but it can also be used to secure a line to a pad eye, to secure another ring around a stanchion or other object, or to bend two lines together.

To tie a bowline, you should—

1. Grasp the bitter end of the line in the right hand and the standing part in the left hand (opposite, if left-handed). Assuming you are using small stuff, the length of line between your hands should be about 2 feet.
2. Throw an overhand loop counterclockwise near your left hand (clockwise near your right hand, if you are left-handed).
3. Grasp the loop formed and hold it. Pass the bitter end up through the bottom of the loop, as shown in figure 7-17, view A.
4. Pull the bitter end up through the loop, and pass it around behind the standing part of the line (fig. 7-17, view B).
5. Pass the bitter end down through the loop beside the line that was pulled up through the loop (fig. 7-17, view C).
6. To tighten the knot, grasp the standing part in one hand and the two lines passed through the loop with the other hand, and pull.

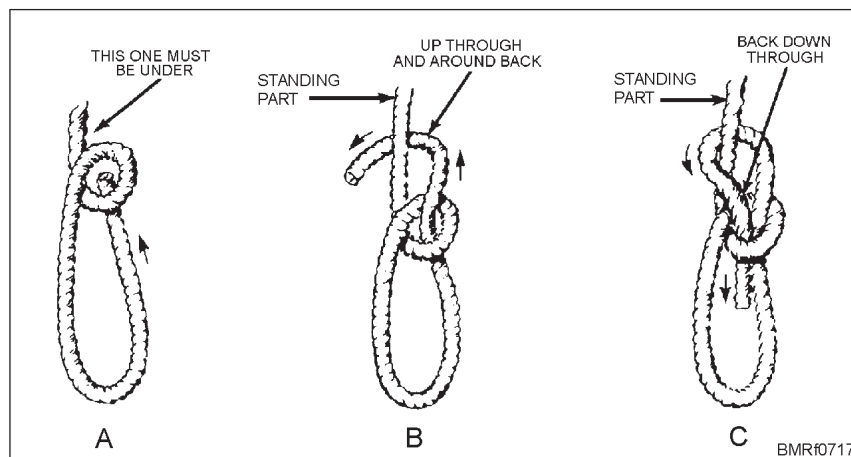

Figure 7-17.—Tying a bowline.

Student Notes:

Becket Bend

The chief value of the becket bend is its use in binding together two lines of different sizes. If there is a great difference in sizes or the strain on the line is to be great, always use a double becket bend.

To fashion a single becket bend, you should—

1. Make a bight in one line and run the bitter end of the other line up through it, as shown in figure 7-18, view A.
2. Pass the end around behind both parts of the bight and back under itself (fig. 7-18, view B).

Figure 7-18, view C, shows how you make a double becket bend by simply taking another turn around the bight. (These bends are also known as *sheet bends*.)

Clove Hitch

The clove hitch can be quickly and easily tied in several ways, and it will hold as long as there is a strain on it. Once the strain is taken off, however, the hitch must be checked and tightened to prevent the bitter end from pulling out when the strain is reapplied. To make this checking and tightening unnecessary, you lash a clove hitch with a half hitch around the standing part.

To tie this hitch (fig. 7-19), you should—

1. Take a turn with the bitter end.
2. Pass the end across the standing part.

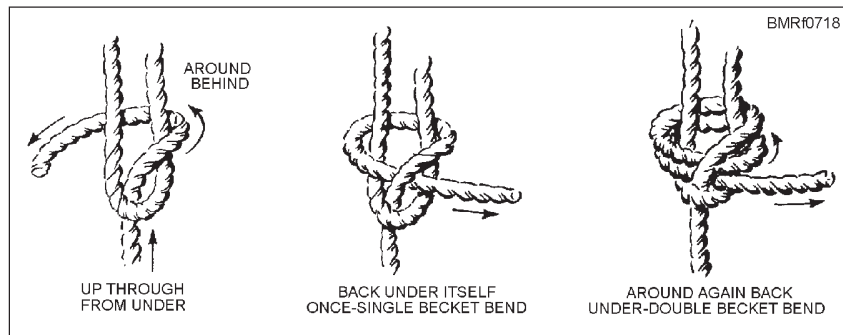

Figure 7-18.—Single- and double-becket bends.



Figure 7-19.—Tying a clove hitch.

3. Take another turn. (Notice that both turns go around in the same direction.)
4. Pass the end under itself, and the hitch is complete.

Another way to make this hitch is to form two underhand loops. Lay the second loop on top of the first. This method is the usual way to form the hitch when it can be slipped over the end of the object to which the line is to be secured.

Round Turn and Two Half Hitches

The chief advantage of the round turn and two half hitches over other hitches is that it won't slip along the object to which it is secured. It's made by taking a round turn and making two half hitches (fig. 7-20). (The two half hitches actually consist of a clove hitch taken around the line itself.)

Making Up a Line

Once line is removed from the manufacturer's coil, or spool, it may be made up (for ready use) by coiling down, faking down, or flemishing. Figure 7-21 shows

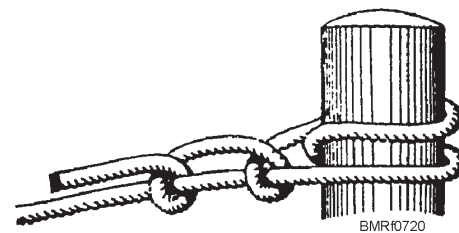

Figure 7-20.—Round turn and two half hitches.

the methods of coiling, faking, and flemishing lines. Descriptions of making up lines are shown below:

“Coiling down a line” means laying it up in circles, roughly one on top of the other. Faking down a line is laying it up in the same manner as for coiling down, except that it is laid out in long, flat bights, one alongside the other, instead of in round coils. The main advantage of working with line that is faked down is that it runs off more easily. To flemish down a line, start with the bitter end, and lay on deck successive circles of line in the manner of a clock spring with the bitter end in the center. Right-laid line is laid down clockwise; left-laid line is laid down counterclockwise.

Student Notes:

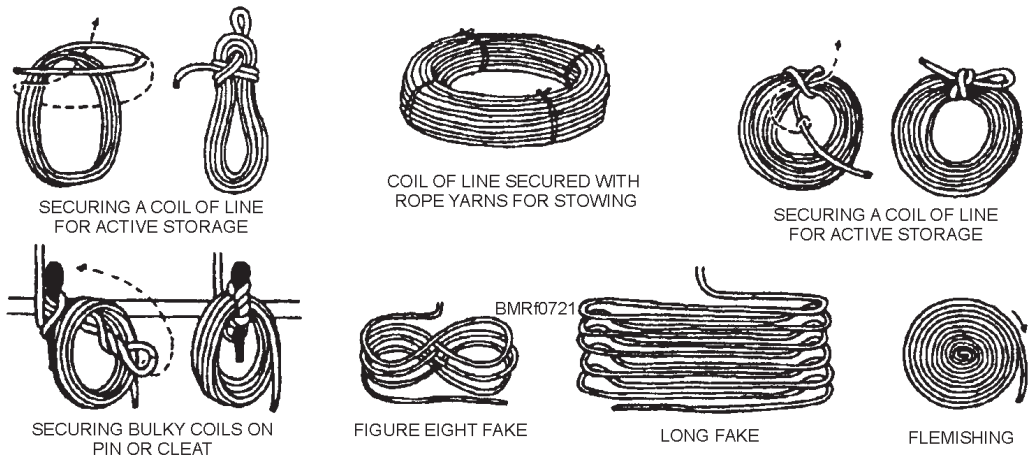

Figure 7-21.—Coils, fakes, and flemishes.

SPLICES

Splices are used to permanently join two lines or to form an eye or loop in the end of a line. When time permits, splices should be used instead of knots because splices are much stronger.

Eye Splice

To make an eye splice, unlay (untwist) the strands in the end of your line about 8 to 10 turns of lay. Whip the end of each strand to prevent the strands from unlaying while you splice.

NOTE

When splicing synthetic line, such as nylon, it is sometimes easier to use tape on the strand ends. Large line, such as mooring lines, should be seized or bound together at the point where unlaying stops.

To form the eye, bend the line back until the eye is the desired size. This is the point where your splicing begins.

Follow the steps shown in figure 7-22 by tucking each whipped strand under one strand of the line. Pull

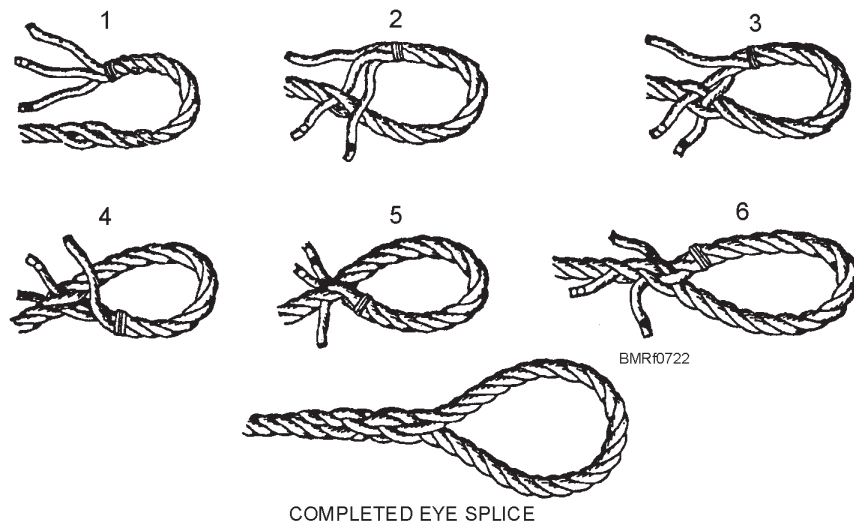

Figure 7-22.—Steps for making an eye splice.

Student Notes:

the slack out of each tuck and check the size of the eye. (If a thimble is to be used, insert it at this point.) Follow the “over one strand, under the next” procedure until you complete at least three tucks for natural fiber line or four tucks for synthetic line. (NOTE: The splice can be smoothed by rolling it on deck under your foot.)

Upon completion of the splice, the excess length of each strand must be cut off. When natural fiber line is used for the splice, the strands can simply be cut off near the line. With synthetic line, a short length of each strand should be left intact. The ends of the threads of each strand are then melted together over an open flame to prevent the strands from frazzling.

When you melt the ends of the strands, don't allow any of the melted synthetic line to drip on you, your clothing, another person, or anything that might present a fire hazard. Also, observe all safety precautions pertaining to the use of open flames aboard your ship or station.

Short Splice

A short splice is used where two lines are to be permanently joined, provided a slight enlargement of the diameter is not important. When properly made, the short splice is much stronger than any knot.

After unlaying and whipping the strands as described for the eye splice, seize each line where the unlaying stops. Now butt the two lines together so that they are interlaced, and follow the steps shown in figure 7-23.

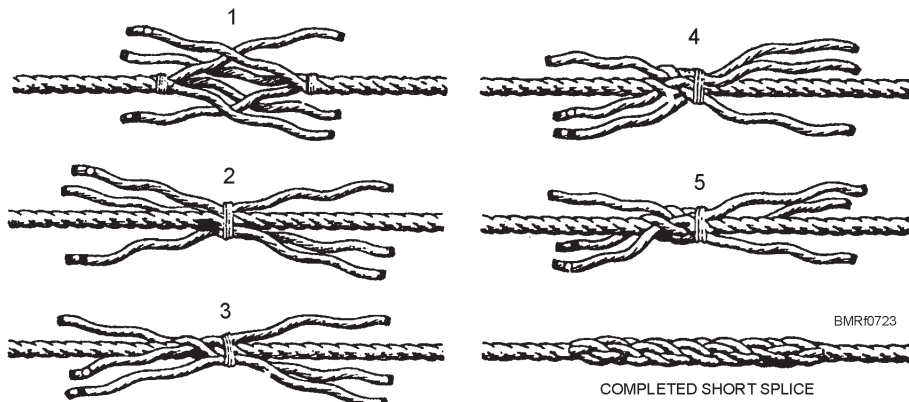

Figure 7-23.—Steps for making a short splice.

With large lines, you must put on a temporary seizing where they join to keep them from suddenly coming apart. It's better to do that with small lines, too, until you get the hang of holding them together while you tuck.

Once your seizing is on, tuck over and under the same way you finish off an eye splice. Three tucks (natural fiber) or four tucks (synthetic fiber) on each side of the seizing are ample. Remove the seizing, cut off the ends of the strands, and melt them (if appropriate) as previously described.

SECURING FOR SEA

You are required to learn these knots, bends, and hitches so that you can use them when and where necessary. Rest assured that a person who goes to sea will find frequent use for them in securing equipment to prevent damage from rough waters. How the equipment is secured depends on the gear and the places of stowage. By observing the few tips that follow and by using a little common sense, you should be able to do a good job of securing your equipment for sea.

- Use line strong enough to hold the gear.
- Make certain the line is in good condition. Make fast the belay objects from at least two points that, preferably, are near the object.
- Lash tightly all objects against something solid (such as the bulkhead).

Student Notes:

- Make the lashings taut so that the object will not “work” with the pitch and roll of the ship. Frequently check all lashings, and tighten as necessary.
- Use chafing gears on sharp corners and rough surfaces.
- Never make fast your lashings to electric cables or small slightly secured pipes, lagged pipes, door and hatch dogs or hinges, electric motors, lifeline stanchions, or anything not solidly secured.
- Never block access to vents, fireplugs, switches, valves, doors, or hatches.

Never underestimate the force of the sea! Secure everything properly the first time and be safe.

REVIEW 3 QUESTIONS

- Q1. List the three advantages of using nylon line over natural fiber line.
- a.
 - b.
 - c.
- Q2. When a natural fiber line will bear on sharp edges or run over rough surfaces, what action should you take to protect the line from damage?
- Q3. Under what condition should you use a wire rope?
- Q4. You are right-handed. When tying a bowline, the overhand loop should be in what direction?

- Q5. You are going to join two separate lines together using a becket bend. What is the first step you should take?

SUMMARY

Becoming an accomplished seaman takes time, hard work, and patience. At some time in your career, you could be a member of a detail where handling lines will be required, or you may work with deck equipment and lines on a daily basis. Knowing how to use deck equipment and handle lines safely is essential.

Lines are used in the Navy for many reasons—from mooring aircraft carriers to securing bookshelves at sea. Without the wide variety of lines available to us, our way of doing our jobs would be extremely difficult.

Each piece of deck equipment or fitting has been designed for a specific purpose. A set of bits on a destroyer is used primarily for mooring, where a set of bits on a tug is used almost exclusively for towing. Becoming familiar with deck equipment and its use, and knowing how to make up and use lines is not only a sign of good seamanship but could, in case of emergencies, make the difference between saving or losing the ship or your shipmates.

Each person in the Navy is first and foremost a seaman and then a technician in his or her specific rate. Become proficient in seamanship. It may help you in your daily duties and most certainly assist you in times of difficulty.

REVIEW 1 ANSWERS

- A1. Ground tackle used on board ship includes—
- a. **Anchors**
 - b. **Anchor cable and chains**
 - c. **Chain stoppers**
 - d. **Bending shackles**
 - e. **Outboard swivel shots**
 - f. **Detachable links**

Student Notes:

- A2. Bower anchors are **carried on the bow of a ship and secured in the hawspipe.**
- A3. The standard mooring lines used to secure a normal size ship at a pier include the—
- Bowline**
 - Forward bow spring**
 - After bow spring**
 - Forward quarter spring**
 - After quarter spring**
 - Stern line**
- A4. Aboard ship, deck fittings are used **in securing mooring lines, in towing operations, and in securing heavy objects and equipment.**
- A5. **Boat booms** are used to moor the ship's boat while anchored.

REVIEW 2 ANSWERS

- A1. Combatant craft include—
- Mechanized landing craft (LCM)**
 - Utility landing craft (LCU)**
- A2. As a passenger, you should **obey all orders from the boat officer and the coxswain.**
- A3. If a boat you're a passenger in capsizes, you shouldn't panic because **fear is easily transmitted from one person to another.**

- A4. The term *athwartships* refers to **the position of something that is across the boat from side to side at a right angle.**

REVIEW 3 ANSWERS

- A1. Three advantages of using nylon line over natural fiber line include—
- Nylon line is 2 1/2 times stronger than natural fiber.**
 - Nylon has greater strength and elasticity.**
 - Nylon has greater resistance to weather.**
- A2. To protect a natural fiber line from sharp edges and rough surfaces, you should **use a chafing gear between the contact point of the line and the damaging surface.**
- A3. You should use a wire rope **when a great deal of wear and tear and weathering and heat is met, and greater strength is needed.**
- A4. The overhand loop should be turned in a **counterclockwise direction.**
- A5. The first step you should take when joining two separate lines together using a beck bend is to **make a bight on one line and run the bitter end of the other line up through the bight.**

CHAPTER COMPREHENSIVE TEST

- | |
|----------------------------|
| A. DECK SEAMANSHIP |
| B. BOAT SEAMANSHIP |
| C. MARLINESPIKE SEAMANSHIP |

Figure A

IN ANSWERING QUESTIONS 1 THROUGH 4, REFER TO FIGURE A AND SELECT THE TERM USED TO DEFINE THE QUESTION.

- General boat handling.
 - A
 - B
 - C
- The general work on the ship's deck and the equipment used.
 - A
 - B
 - C
- Anchoring, mooring, cargo handling, and towing are examples of this type of seamanship.
 - A
 - B
 - C
- Care and use of line.
 - A
 - B
 - C
- It is important for you to know shipboard equipment terminology for which of the following reasons?
 - Equipment changes all the time
 - You will have to inventory the equipment once each month
 - You will probably assist the deck force in various seamanship evolutions
 - There are different names for the same equipment
- What is ground tackle?
 - Equipment bolted to the deck
 - Equipment used to anchor and moor with anchors
 - Equipment electrically connected to ground
 - Equipment used to refuel the ship
- Which of the following is/are the most commonly used anchors aboard Navy ships?
 - Lightweight
 - Stockless
 - Both 1 and 2 above
 - Locking pin
- How long is a standard shot of anchor chain?
 - 15 fathoms
 - 20 fathoms
 - 25 fathoms
 - 30 fathoms
- What device is used to secure shots of anchor chain together?
 - Link pins
 - Bending shackles
 - Detachable links
 - Securing shackles
- What types of anchor windlasses are used for lifting the ship's anchor?
 - Vertical shaft type only
 - Horizontal shaft type only
 - Vertical shaft and horizontal shaft types
 - Lateral shaft type
- What device engages the chain links when hauling anchors on board ship?
 - Wildcat
 - Capstan
 - Gypsy heads
 - Bending shackles
- Which of the following platforms is/are used in the construction of an accommodation ladder?
 - Middle platform
 - Upper platform
 - Lower platform
 - Both 2 and 3 above

13. What is the Navy term for gangplank?
 1. Brow
 2. Ramp
 3. Platform
 4. Accommodation ladder
14. What lines are used to prevent the ship from drifting forward or aft?
 1. The bowline and the forward spring lines
 2. The stern line and after spring lines
 3. The forward and after spring lines
 4. The bow and stern lines
15. What means are used to protect the sides of a ship when it is alongside a pier?
 1. Doubled lines
 2. Camels only
 3. Fenders only
 4. Camels and fenders
16. What is the main purpose for deck fittings aboard ship?
 1. To secure mooring lines
 2. To connect electrical power
 3. To replace stanchions
 4. To secure the anchor
17. Which of the following is NOT a deck fitting found aboard ships?
 1. Bitts
 2. Cleats
 3. Bollards
 4. Pad eyes
18. Which of the following is the purpose of boat booms when ships are at anchor or moored to a buoy?
 1. To raise and lower supplies
 2. To moor their boats well clear of the side
 3. Both 1 and 2 above
 4. To raise and lower personnel
19. Which of the following is/are types of boats used by the Navy?
 1. Service craft
 2. Combatant craft
 3. Boats in general
 4. All of the above

20. A boat is defined as a non-commissioned waterborne vessel that isn't designated as a service craft. According to this definition, which of the following are types of boats?
 1. Personnel boats
 2. Motor whaleboats
 3. Utility boats
 4. All of the above
21. Which of the following is a type of service craft?
 1. Riverine craft
 2. Patrol craft
 3. Ship's boats
 4. Harbor tugs
22. Which of the following is a type of combatant craft?
 1. Patrol craft
 2. Ship's boats
 3. Ferryboats

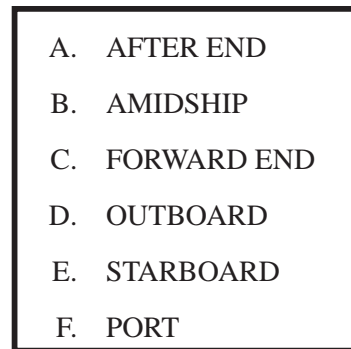

Figure B

IN ANSWERING QUESTIONS 23 THROUGH 27, REFER TO FIGURE B AND SELECT THE TERM DESCRIBED BY THE QUESTION.

23. When facing forward of the boat, your right-hand side is in this direction.
 1. C
 2. D
 3. E
 4. F
24. The stern of the boat.
 1. A
 2. B
 3. C
 4. D

25. The area furthest from the boat's centerline.
1. B
 2. C
 3. D
 4. E
26. When facing forward of the boat, your left-hand side is facing this direction.
1. A
 2. B
 3. E
 4. F
27. The bow of the boat.
1. B
 2. C
 3. D
 4. F
28. Nylon line is about how many times stronger than manila line of the same size?
1. 1 1/2
 2. 2 1/2
 3. 3 1/2
 4. 4 1/2
29. How is line termed *small stuff* identified?
1. By the length of the line
 2. By the number of threads in the line
 3. By the number of strands in the line
 4. By the number of cables twisted together
30. Under safe working conditions, nylon line will stretch what maximum fraction of its length?
1. 1/4
 2. 1/3
 3. 1/2
 4. 2/3
31. Nylon line will stretch what maximum percentage of its length before it will break?
1. 20%
 2. 33%
 3. 50%
 4. 66%

32. A wire rope designated as 5 by 12 has (a) what number of strands and (b) what number of wires per strand?
1. (a) 5 (b) 12
 2. (a) 12 (b) 12
 3. (a) 12 (b) 5
 4. (a) 5 (b) 5
33. The most secure line whipping is made with which of the following pieces of equipment?
1. Small needle and palm
 2. Wire cutters
 3. Hammer
 4. Pliers

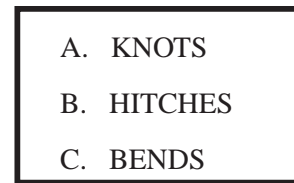

Figure C

IN ANSWERING QUESTIONS 34 AND 35, REFER TO FIGURE C AND SELECT THE TERM DESCRIBED BY THE QUESTION.

34. Used to bend a line to or around an object.
1. A
 2. B
 3. C
35. Used to form eyes or to secure a cord or line around an object.
1. A
 2. B
 3. C
36. The square knot is also known as a
1. granny knot
 2. seaman's knot
 3. reef knot
 4. top knot
37. The bowline can be used for which of the following purposes?
1. To form an eye
 2. To bend two lines together
 3. To secure a line to a pad eye
 4. Each of the above

38. The main value of the becket bend is that it can be used to bend together two lines of different sizes.
1. True
 2. False
39. If there is a great strain on a line, what type of bend should be used?
1. Becket bend
 2. Double becket bend
 3. Bowline
 4. Double bowline
40. What type of hitch will hold as long as there's a strain on it?
1. Two half hitches
 2. Two underhanded loops
 3. Round and turn and two half hitches
 4. Clove hitch
41. Which of the following actions would you perform to "coil down" a line?
1. Lay line in successive circles with the bitter end in the center
 2. Lay line in circles, one on top of the other
 3. Lay line in long, flat bights
 4. Lay line out in full
42. Which of the following actions would you take to "flemish down" a line?
1. Lay line in successive circles with the bitter end in the center
 2. Lay line in circles, one on top of the other
 3. Lay line in long, flat bights
 4. Lay line out in full
43. When making an eye splice, you should unlay what number of line strands?
1. 2 to 4
 2. 4 to 6
 3. 6 to 8
 4. 8 to 10
44. Which of the following procedures is used to prevent the strands of synthetic line from frazzling after a splice has been made?
1. They are whipped
 2. They are melted together
 3. They are cut off even with the standing part
 4. Each of the above
45. Which of the following is the purpose of using a short splice?
1. To temporarily join two lines together
 2. To permanently join two lines together
 3. To form an eye
 4. Each of the above