

Basics of Electricity

A quickSTEP Online Course

Trademarks

Siemens is a trademark of Siemens AG. Product names mentioned may be trademarks or registered trademarks of their respective companies.

Other trademarks are the property of their respective owners.

Course Topics

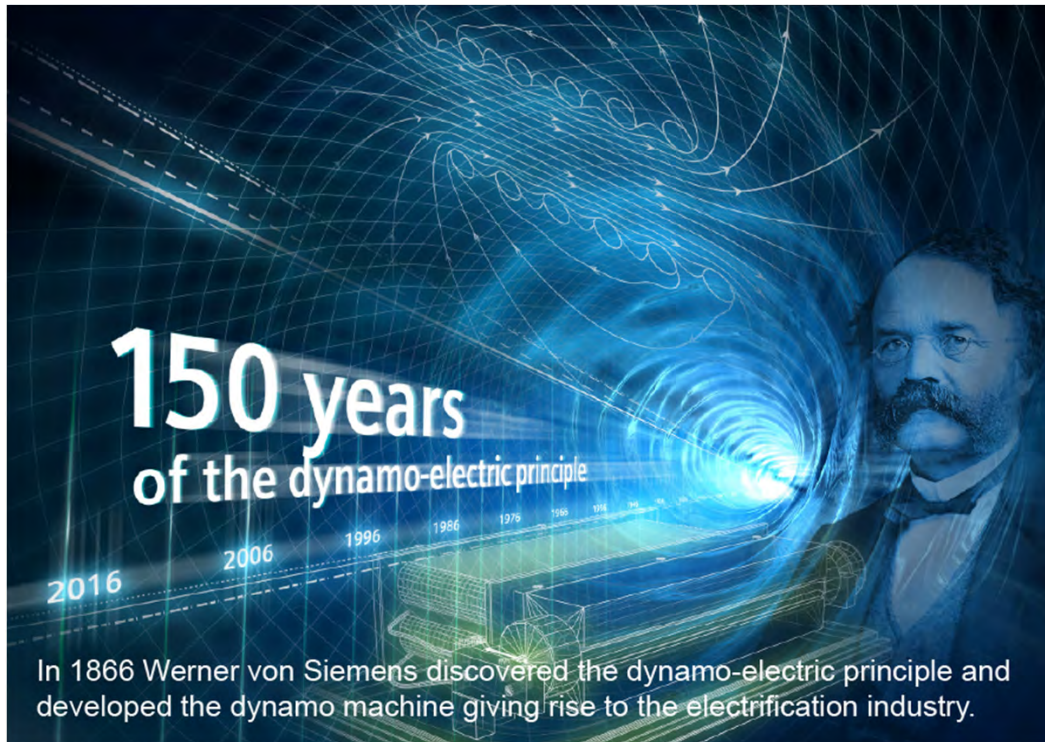

Welcome to Basics of Electricity. This course covers the following topics:

Introduction

Chapter 1 – Direct Current

- Direct Current Basics
- DC Circuits
- Magnetism

Chapter 2 – Alternating Current

- Alternating Current Basics
- Inductance and Capacitance
- AC Circuits
- Transformers

Final Exam

If you do not have a basic understanding of electricity, complete this course before starting other quickSTEP online courses.

Course Objectives

Upon completion of this course you will be able to...

- Explain the difference between conductors and insulators
- Use Ohm's Law to calculate current, voltage, and resistance
- Calculate equivalent resistance for series, parallel, or series-parallel circuits
- Calculate voltage drop across a resistor
- Calculate power given other basic values
- Identify factors that determine the strength and polarity of a current-carrying coil's magnetic field
- Determine peak, instantaneous, and effective values of an AC sine wave
- Define inductive reactance, capacitive reactance, and impedance
- Calculate total impedance of a simple AC circuit
- Explain the difference between real power and apparent power in an AC circuit
- Determine how a transformer turns ratio affects secondary voltage and current

SITRAIN® Training for Industry



Online Self-paced Learning – Programs with maximum flexibility so students can easily fit courses into their busy schedules



Virtual Instructor-led Learning - Classroom lectures delivered in the convenience of your home or office



Classroom Learning - Expert and professional instructors, proven courseware, and quality workstations combine for the most effective classroom experience possible at your facility or ours



How-to Video Library - Quick, affordable, task-based learning options for a broad range of automation topics for training or purchase



Simulators - World-class simulation systems available for training or purchase

This course also describes learning options available from the Siemens SITRAIN USA organization and our global SITRAIN partners. For additional information: www.usa.siemens.com/sitrain

Chapter 1 – Direct Current

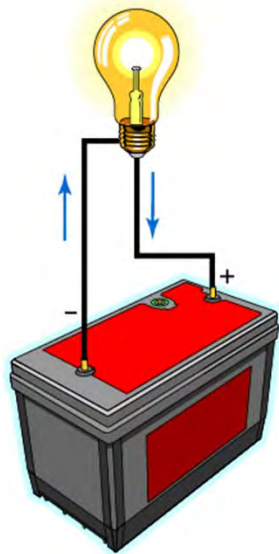
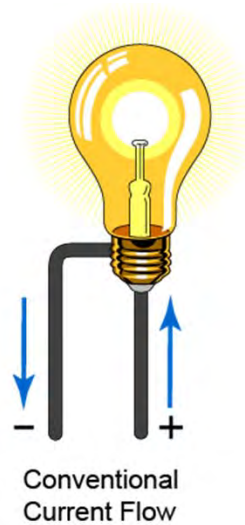
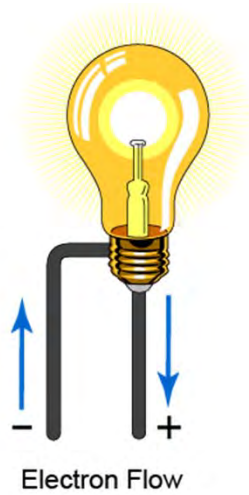

DC Voltage Source Symbols
The + and - signs are optional

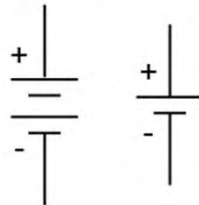

This chapter covers the following topics:

- **Direct Current Basics**
- DC Circuits
- Magnetism

Atoms

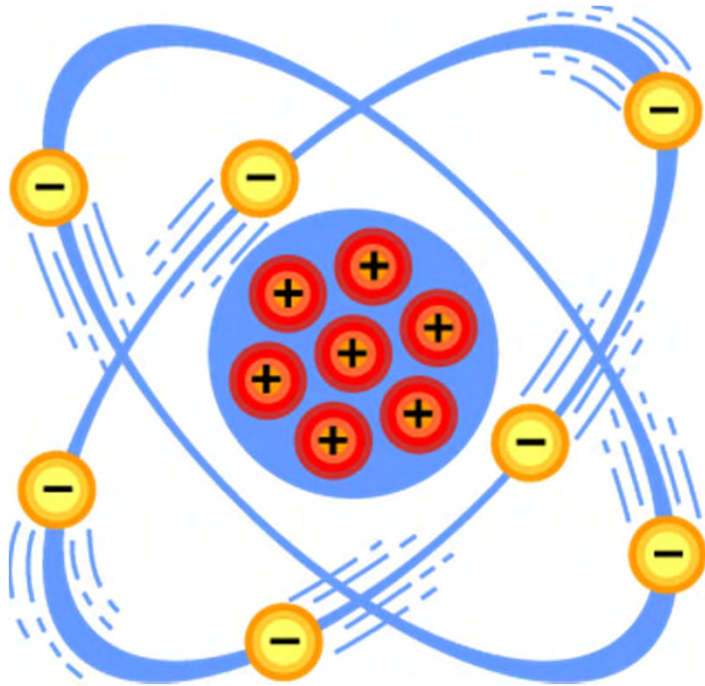

All matter is composed atoms. Atoms have a nucleus with electrons moving around it. The nucleus is composed of protons and neutrons (not shown).

In their neutral state, atoms have an equal number of electrons and protons. Electrons have a negative charge. Protons have a positive charge . Neutrons are neutral. The negative charge of the electrons is balanced by the positive charge of the protons. Electrons are bound in their orbit by their attraction to protons.

Free Electrons

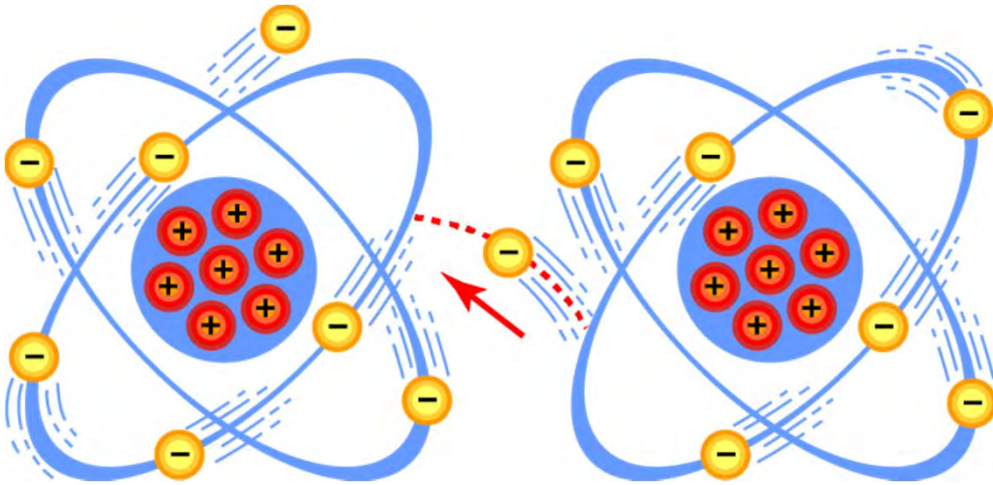

Electrons in the outer band can become free of their orbit by the application of some external force such as movement through a magnetic field, friction, or chemical action. These are referred to as free electrons.

A free electron leaves a void which can be filled by an electron forced out of orbit from another atom. As free electrons move from one atom to the next an electron flow is produced. This is the basis of electricity.

Conductors

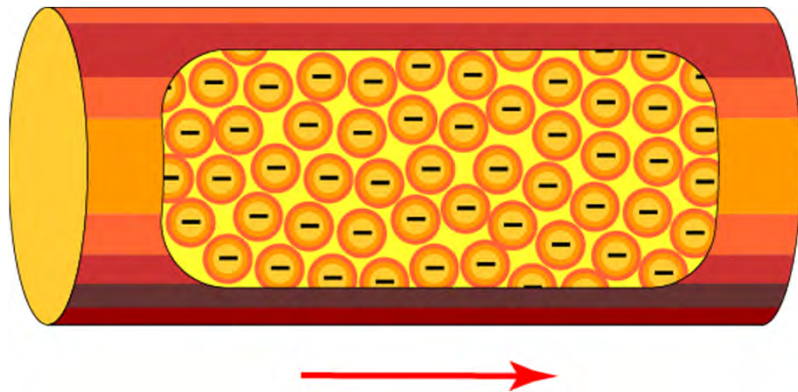

An electric current is produced when free electrons move from one atom to the next. Materials that permit many electrons to move freely are called conductors.

Copper, gold, silver, and aluminum are examples of materials that are good conductors. Copper is widely used as a conductor because it is one of the best conductors and is relatively inexpensive.

Insulators

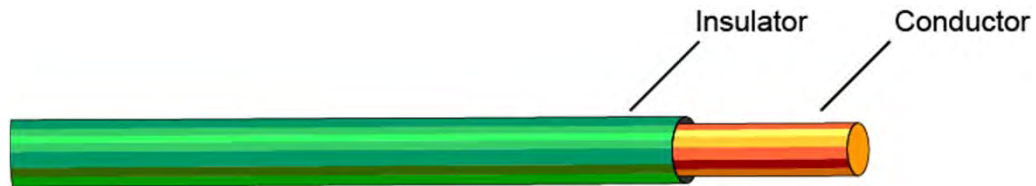

Materials that allow few free electrons are called insulators. Materials such as plastic, rubber, glass, mica, and ceramic are examples of materials that are good insulators.

An electrical cable is one example of how conductors and insulators are used together. Electrons flow along a copper conductor in a circuit and the insulator around the outside of the copper conductor keeps electrons in the conductor.

Semiconductors

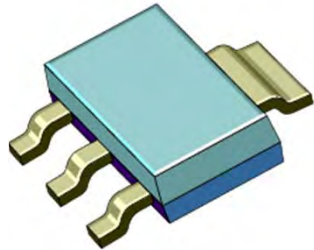

Transistor



Diode

Semiconductor materials, such as silicon, can be used to manufacture devices that have characteristics of both conductors and insulators.

Many semiconductor devices act like a conductor when an external force is applied in one direction and like an insulator when an external force is applied in the opposite direction.

This principle is basic to the operation of transistors, diodes, and other solid-state electronic devices.

Electric Charges



Neutral Charge



Negative Charge



Positive Charge

Elements are defined by the number of electrons in orbit around the nucleus of an atom and by the number of protons in the nucleus. A hydrogen atom, for example, has only one electron and one proton. An aluminum atom has 13 electrons and 13 protons. An atom with an equal number of electrons and protons is said to be electrically neutral.

Electrons in the outer band of an atom are easily displaced by the application of some external force. Electrons which are forced out of their orbits can result in a lack of electrons where they leave and an excess of electrons where they come to rest.

A material with more protons than electrons has a net positive charge, and a material with more electrons than protons has a net negative charge. A positive or negative charge is caused by an absence or excess of electrons, because the number of protons in an atom remains constant.

Attraction and Repulsion of Electric Charges

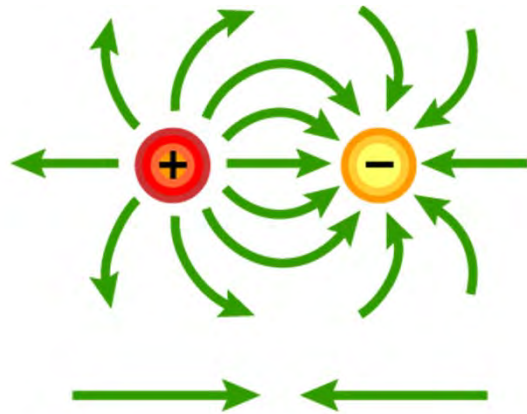

Unlike Charges Attract Each Other

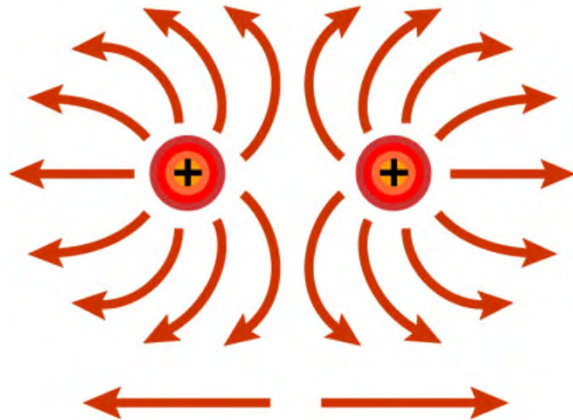

Like Charges Repel Each Other

The old saying, “opposites attract,” is true when dealing with electric charges. Charged bodies have an invisible electric field around them. When two unlike-charged bodies are brought together, their electric fields attract one body to the other. When two like-charged bodies are brought together, their electric fields repel one body from the other.

During the 18th century a French scientist, Charles A. Coulomb, studied fields of force that surround charged bodies. Coulomb discovered that charged bodies attract or repel each other with a force that is directly proportional to the product of the charges and inversely proportional to the square of the distance between them.

Today we call this Coulomb’s Law of Charges. Simply put, the force of attraction or repulsion depends on the strength of the charges and the distance between them.

Current

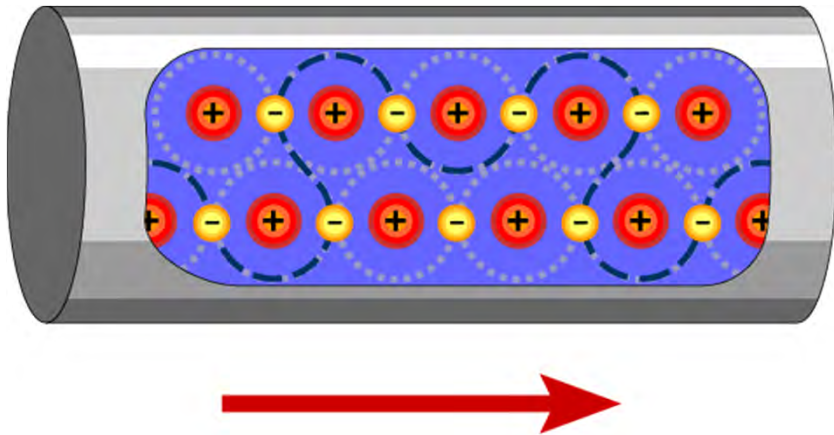

Electricity is the flow of electrons in a conductor from one atom to the next atom in the same general direction. This flow of electrons is referred to as current and is designated by the symbol “I”.

Current is measured in amperes, which is often shortened to “amps”. The letter “A” is the symbol for amps. Because the amount of voltage present can vary significantly, metric unit prefixes are sometimes used. For example, a current of 0.001 amps is equal to 1 milliamp or 1 mA for short.

Current that constantly flows in the same direction is called direct current (DC). Current that periodically changes direction is called alternating current (AC).

Commonly Used Units		
Unit	Short Form	Decimal Value
1 kiloampere	1 kA	1000 A
1 ampere	1 A	1 A
1 milliampere	1 mA	0.001 A
1 microampere	1 μ A	0.000001 A

Direction of Current Flow

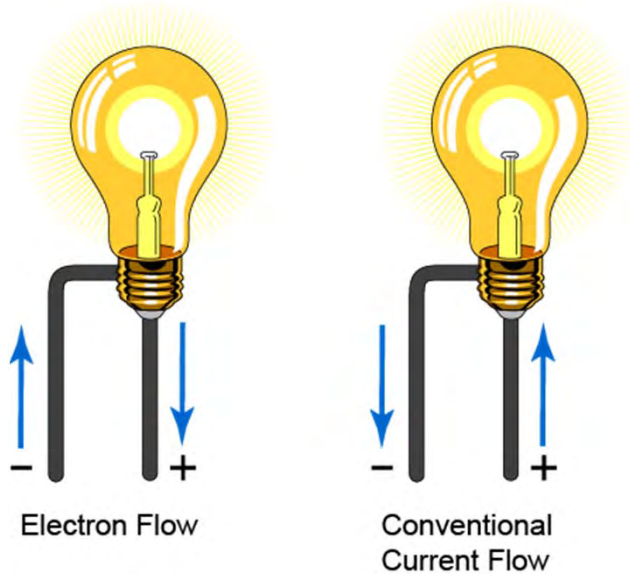

Some authorities distinguish between electron flow and current flow.

Conventional current flow theory ignores the flow of electrons and states that current flows from positive to negative.

Electric circuits can be correctly analyzed using either conventional current flow or electron flow; however, to avoid confusion, this course uses the electron flow concept which states that electrons flow from negative to positive.

Voltage

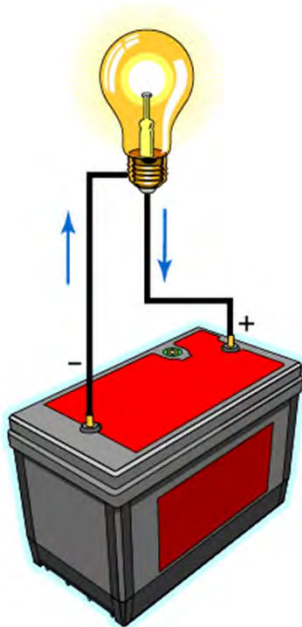

DC Voltage Source Symbols
The + and - signs are optional

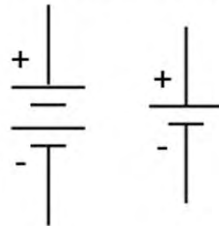

Commonly Used Units		
Unit	Short Form	Decimal Value
1 kilovolt	1 kV	1000 V
1 volt	1 V	1 V
1 millivolt	1 mV	0.001 V
1 microvolt	1 μ V	0.000001 V

The force that causes current to flow through a conductor is called a difference in potential, electromotive force (emf), or voltage. Voltage is designated by the letter “E” or the letter “V.” The unit of measurement for voltage is volts which is also designated by the letter “V.” Because the amount of voltage present can vary significantly, metric unit prefixes are sometimes used. For example, a voltage of 1000 volts is equal to 1 kilovolt or 1kV for short.

A voltage can be generated in various ways. A battery uses an electrochemical process. A car’s alternator and a power plant generator utilize a magnetic induction process.

All voltage sources share the characteristic of an excess of electrons at one terminal and a shortage at the other terminal. This results in a difference of potential between the two terminals.

For a DC voltage source, the polarity of the terminals does not change, so the resulting current constantly flows in the same direction.

The terminals of an AC voltage source periodically change polarity, causing the current flow direction to change with each switch in polarity.

Resistance

Resistor



Resistor Symbol



Commonly Used Units		
Unit	Short Form	Decimal Value
1 Megaohm	1 M Ω	1,000,000 Ω
1 kilohm	1 k Ω	1000 Ω
1 ohm	1 Ω	1 Ω

Unit	Short Form	Decimal Value
1 Megaohm	1 M Ω	1,000,000 Ω
1 kilohm	1 k Ω	1000 Ω
1 ohm	1 Ω	1 Ω

A third factor that plays a role in an electrical circuit is resistance. Resistance is the property of a circuit, component, or material that opposes current flow. All material resists the flow of electrical current to some extent.

The amount of resistance depends upon the composition, length, cross-section, and temperature of the resistive material. For any specific material at a constant temperature, the resistance of a conductor increases with an increase of length or a decrease in cross-section.

Resistance is designated by the symbol "R." The unit of measurement for resistance is the ohm, symbolized by the Greek letter omega (Ω). Because 1 ohm is a small unit and circuit resistances are often large values, metric unit prefixes are often used. For example, 1 million ohms is equal to 1 Megaohm or 1 M Ω for short.

While all circuit components have resistance, a resistor is a component manufactured to provide a designated resistance that is often shown in color coded bands around the resistor.

Ohm's Law

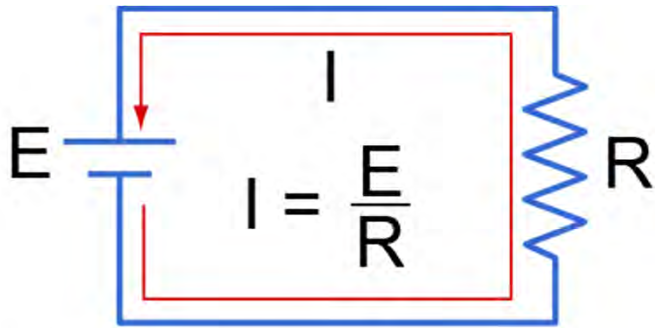

Current (I) is measured in amperes (amps)

Voltage (E) is measured in volts

Resistance (R) is measured in ohms

A simple electric circuit consists of a voltage source, some type of load, and conductors to allow electrons to flow between the voltage source and the load.

Ohm's law defines the relationship between current, voltage, and resistance and shows that current varies directly with voltage and inversely with resistance.

Ohm's Law Triangle

Point your finger on a letter to show the Ohm's law formula for that value

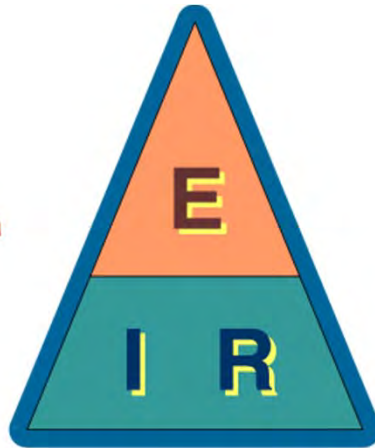

Ohm's law can be expressed in three ways. There is an easy way to remember which form of Ohm's law to use.

First, draw a triangle with the letters for current, voltage and resistance positioned as shown in the accompanying illustration.

Then, when you need to use the ohms law formula, point your finger on the value you want to calculate. The remaining letters make up the formula.

$$I = \frac{E}{R}$$

$$R = \frac{E}{I}$$

$$E = I \times R$$



Ohm's Law Example

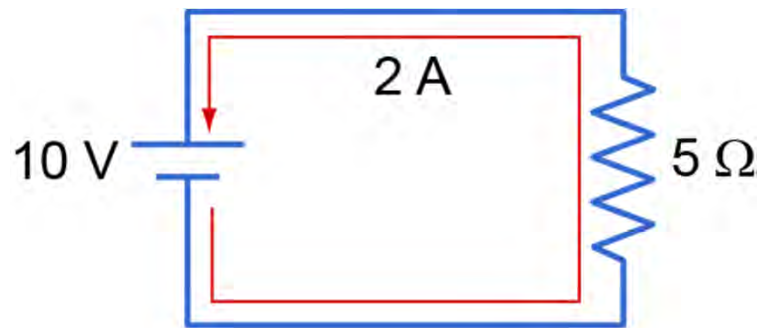

$$I = \frac{E}{R} = \frac{10 \text{ V}}{5 \Omega} = 2 \text{ A}$$

$$R = \frac{E}{I} = \frac{10 \text{ V}}{2 \text{ A}} = 5 \Omega$$

$$E = I \times R = 2 \text{ A} \times 5 \Omega = 10 \text{ V}$$

The accompanying illustration shows that if you know any two Ohm's law values, you can easily find the third value using the appropriate Ohm's law formula.

Online Self-paced Learning

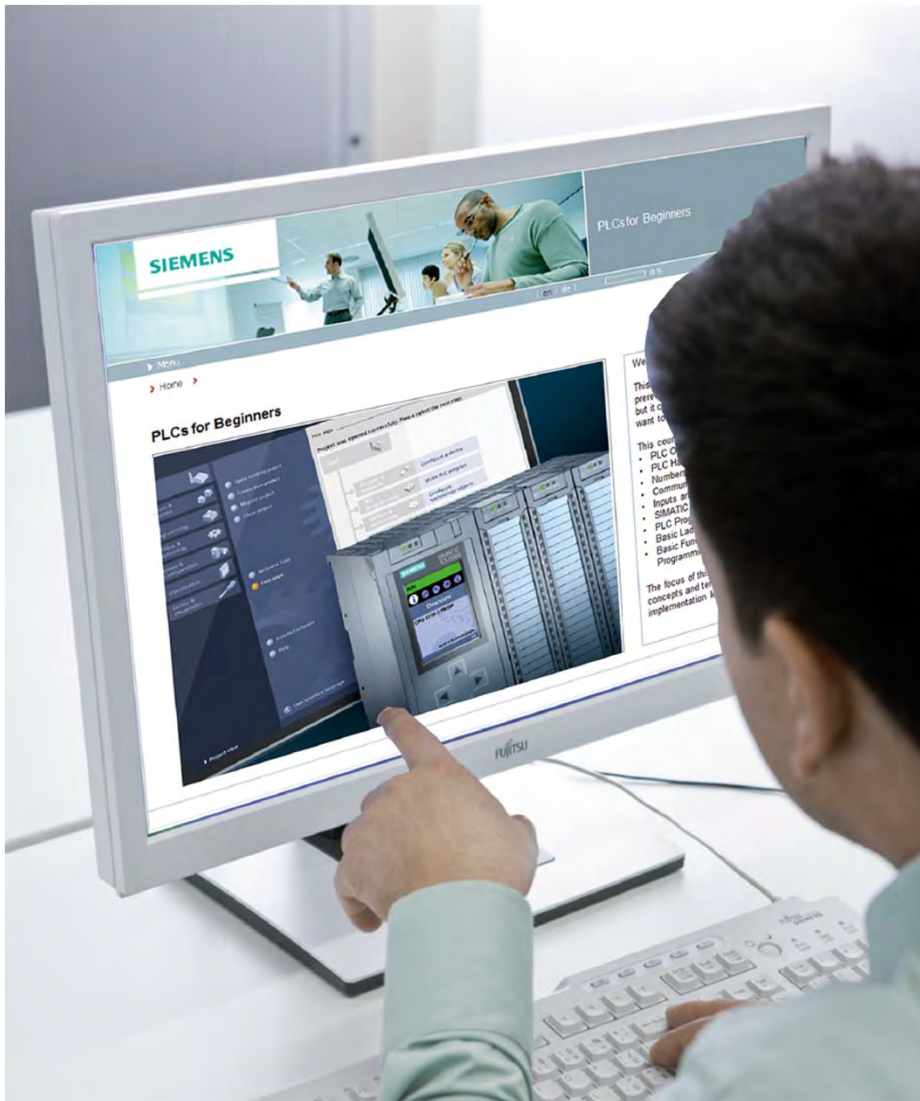

With Siemens online self-paced learning, you select the topics and set your own pace for completing chosen courses. All course material can be accessed online. Instruction starts upon completing the purchase of a subscription.

You can choose from over 500 courses consisting of high-quality graphics, on-screen text, supporting voiceover narration, and interactive exercises. Features include printable course content for reference and underlined key vocabulary terms with definitions displayed with a simple mouse-over action.

Depending on the subscription purchased, you can choose any 10 or 25 courses or select the entire online self-paced course catalog.

These courses are offered 24/7/365, so you can begin your subscription at any time. From the date of registration, you have one year to complete your course selections.

For additional information: www.usa.siemens.com/sitrain

Chapter 1 – Direct Current

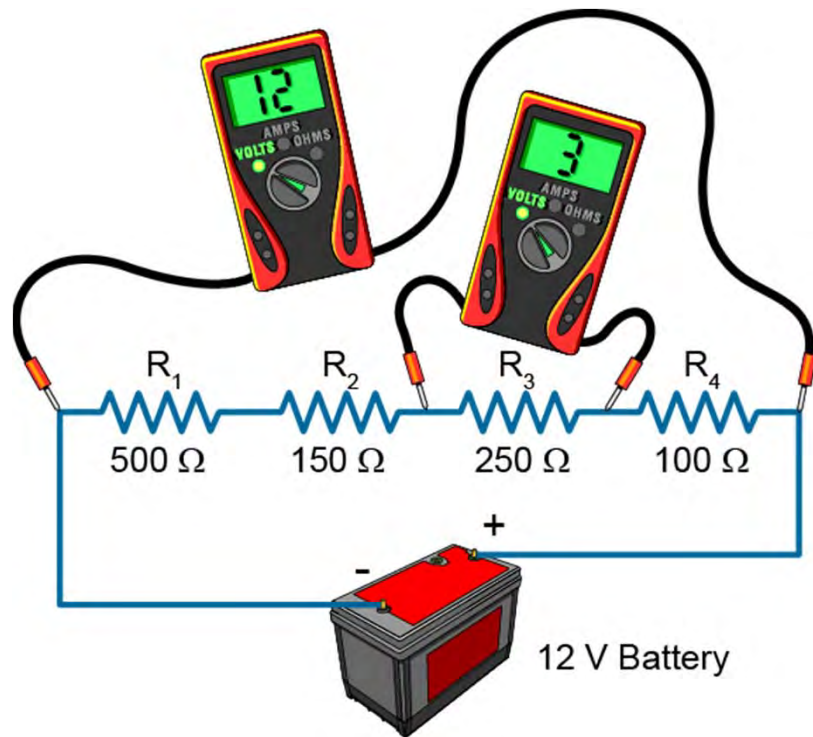

This chapter covers the following **topics**:

- Direct Current Basics
- **DC Circuits**
- Magnetism

Series Circuit Resistance

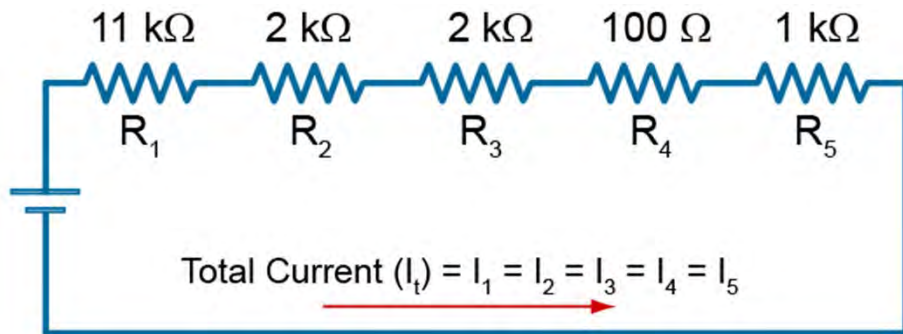

$$\text{Total Resistance} = R_t = R_1 + R_2 + R_3 + R_4 + R_5$$

$$R_t = 11,000 \Omega + 2000 \Omega + 2000 \Omega + 100 \Omega + 1000 \Omega$$

$$R_t = 16,100 \Omega = 16.1 \text{ k}\Omega$$

Commonly Used Units		
Unit	Short Form	Decimal Value
1 Megaohm	1 MΩ	1,000,000 Ω
1 kilohm	1 kΩ	1000 Ω
1 ohm	1 Ω	1 Ω

A series circuit is formed when any number of resistors are connected end-to-end so that there is only one path for current to flow. The resistors can be actual resistors or other devices that have resistance.

The accompanying illustration shows five resistors connected end-to-end. There is one path of current flow from the negative terminal of the voltage source through all five resistors and returning to the positive terminal.

The total resistance in a series circuit is determined by adding all the resistor values. Although the unit for resistance is the ohm, different metric unit prefixes, such as kilo (k) or mega (M) are often used. Therefore, it is important to convert all resistance values to the same units before adding.

Series Circuit Voltage and Current

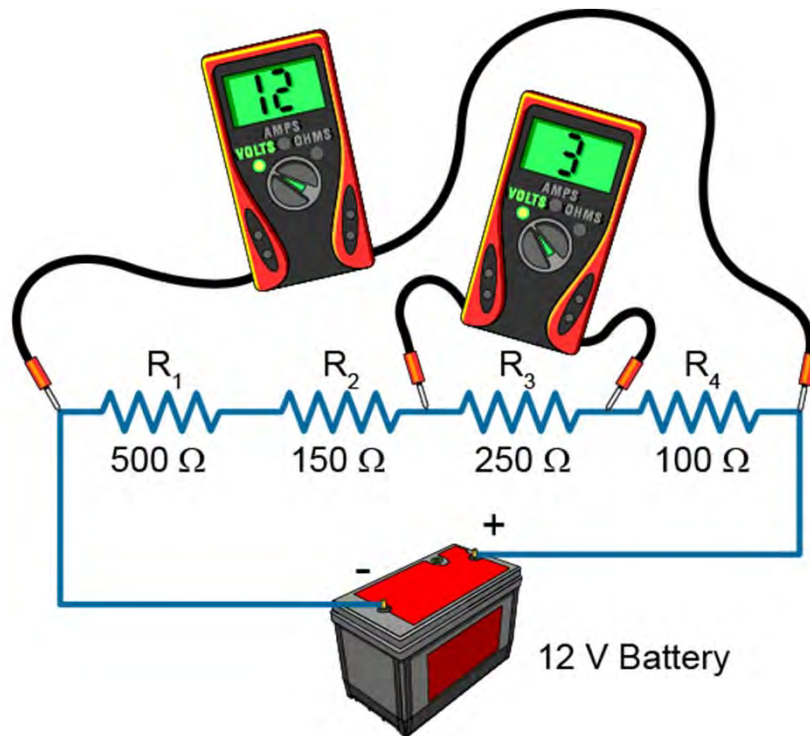

The current in a series circuit can be determined using Ohm's law. First, total the resistance, and then divide the source voltage by the total resistance.

This current flows through each resistor in the circuit. The voltage measured across each resistor can be calculated using Ohm's law. The voltage across a resistor is often referred to as a voltage drop. The sum of the voltage drops across each resistor is equal to the source voltage.

The accompanying illustration shows two voltmeters, one measuring total voltage, and one measuring the voltage across R_3 .

$$R_t = 500\ \Omega + 150\ \Omega + 250\ \Omega + 100\ \Omega = 1000\ \Omega = 1\ \text{k}\Omega$$

$$I = \frac{12\ \text{V}}{1000\ \Omega} = 0.012\ \text{A} = 12\ \text{mA}$$

$$E_3 \text{ (The voltage across } R_3) = I \times R_3 = 0.012\ \text{A} \times 250\ \Omega = 3\ \text{V}$$

$$E_t = E_1 + E_2 + E_3 + E_4 = 6\ \text{V} + 1.8\ \text{V} + 3\ \text{V} + 1.2\ \text{V} = 12\ \text{V}$$

Parallel Circuits

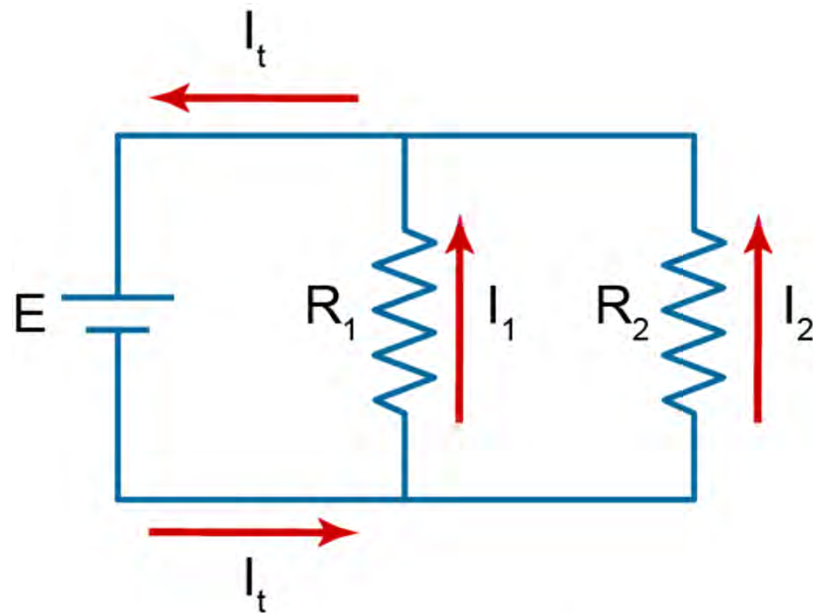

$$I_1 = \frac{E}{R_1} \quad I_2 = \frac{E}{R_2}$$

$$I_t = I_1 + I_2$$

A parallel circuit is formed when two or more resistances are placed in a circuit side-by-side so that current can flow through more than one path.

The accompanying illustration shows the simplest parallel circuit, two parallel resistors. There are two paths of current flow. One path is from the negative terminal of the battery through R1 returning to the positive terminal. The second path is from the negative terminal of the battery through R2 returning to the positive terminal of the battery.

The current through any resistor can be determined by dividing the circuit voltage by the resistance of that resistor. The total current is the sum of the branch currents.

Parallel Circuit Resistance

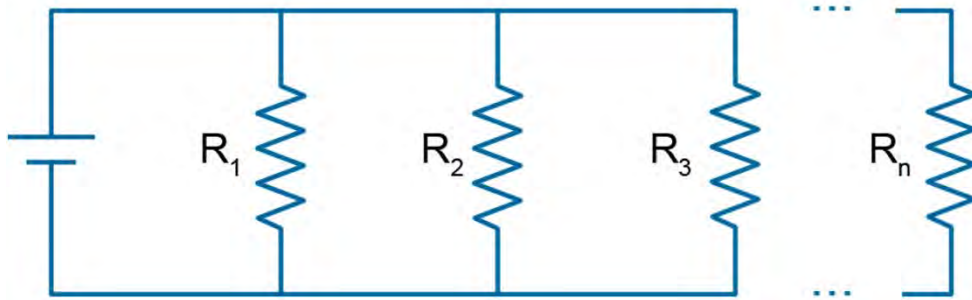

The total resistance for a parallel circuit with any number of resistors can be calculated using the formula shown in the accompanying illustration.

In the unique example where all resistors have the same resistance, the total resistance is equal to the resistance of one resistor divided by the number of resistors.

$$\frac{1}{R_t} = \frac{1}{R_1} + \frac{1}{R_2} + \frac{1}{R_3} \dots + \frac{1}{R_n}$$
$$R_t = \frac{1}{\frac{1}{R_1} + \frac{1}{R_2} + \frac{1}{R_3} \dots + \frac{1}{R_n}}$$

Parallel Circuit Resistance Example

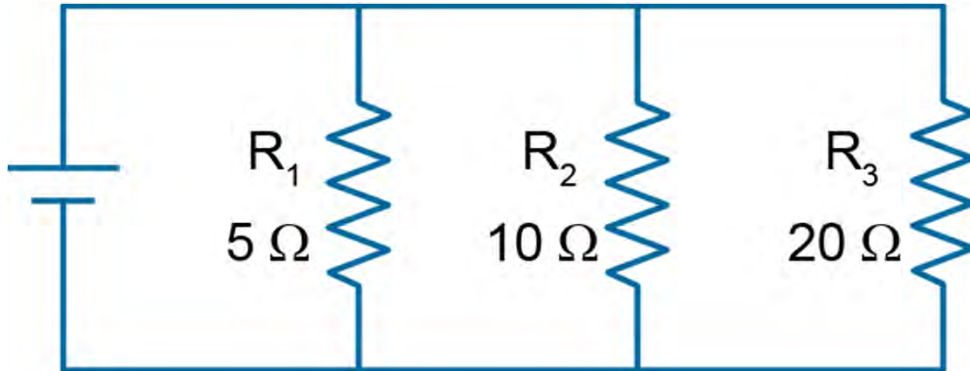

The accompanying illustration shows a circuit with three parallel resistors. See if you can complete the total resistance calculation. Then go to the next page of this course to see the solution.

$$\frac{1}{R_t} = \frac{1}{R_1} + \frac{1}{R_2} + \frac{1}{R_3} =$$

$$R_t = \frac{1}{\frac{1}{R_1} + \frac{1}{R_2} + \frac{1}{R_3}} =$$

Parallel Circuit Resistance Solution

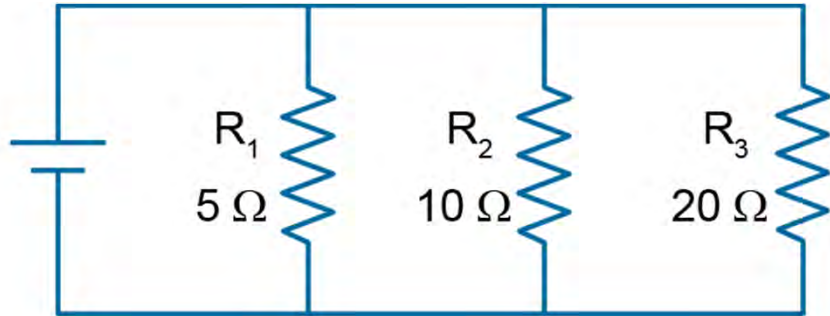

Note the total resistance calculation for this circuit.

$$\frac{1}{R_t} = \frac{1}{R_1} + \frac{1}{R_2} + \frac{1}{R_3} = \frac{1}{5\ \Omega} + \frac{1}{10\ \Omega} + \frac{1}{20\ \Omega} = \frac{4}{20\ \Omega} + \frac{2}{20\ \Omega} + \frac{1}{20\ \Omega} = \frac{7}{20\ \Omega}$$

$$R_t = \frac{1}{\frac{1}{R_1} + \frac{1}{R_2} + \frac{1}{R_3}} = \frac{1}{\frac{7}{20\ \Omega}} = \frac{20\ \Omega}{7} = 2.86\ \Omega$$

Parallel Circuit Current Example

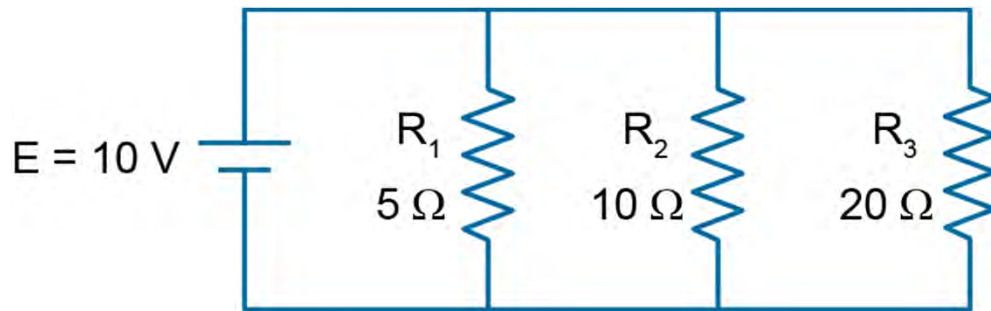

$$I_t = I_1 + I_2 + I_3 = \frac{E}{R_1} + \frac{E}{R_2} + \frac{E}{R_3} =$$

$$I_t = \frac{E}{R_t} =$$

Current in each of the branches of a parallel circuit can be calculated by dividing the circuit voltage, which is the same for all branches, by the resistance of the branch.

The total circuit current can be calculated by adding the current for all branches or by dividing the circuit voltage by the total resistance.

See if you can complete the calculations for each branch current and for the total current. Then go to the next page of this course to see the solution.

Parallel Circuit Current Example

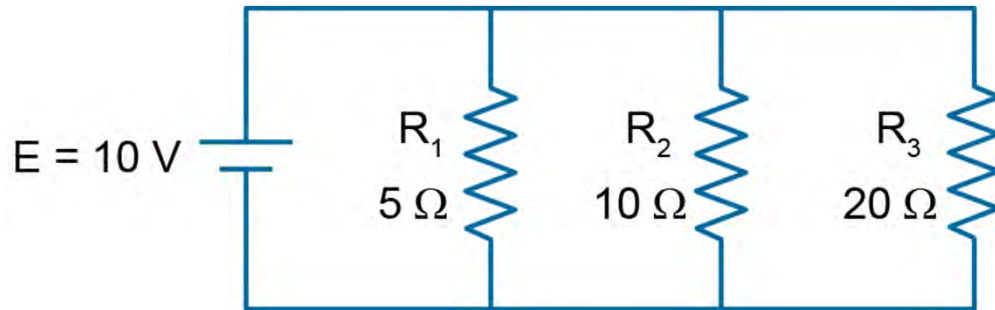

Note the current calculations for this circuit.

$$I_t = I_1 + I_2 + I_3 = \frac{E}{R_1} + \frac{E}{R_2} + \frac{E}{R_3} = \frac{10\text{ V}}{5\ \Omega} + \frac{10\text{ V}}{10\ \Omega} + \frac{10\text{ V}}{20\ \Omega} = 2\text{ A} + 1\text{ A} + 0.5\text{ A} = 3.5\text{ A}$$

$$I_t = \frac{E}{R_t} = \frac{10\text{ V}}{2.86\ \Omega} = 3.5\text{ A}$$

Series-Parallel Circuits

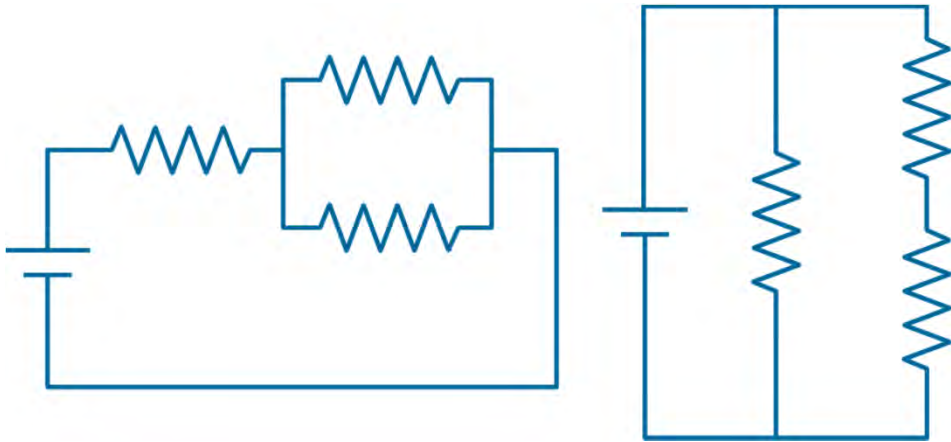

Series-parallel circuits are also known as compound circuits. At least three resistors are required to form a series-parallel circuit. The accompanying illustration shows the two simplest series-parallel circuits.

The circuit on the left has two parallel resistors in series with another resistor. The circuit on the right has two series resistors in parallel with another resistor.

Series-parallel circuits are usually more complex than the circuits shown here, but by using the circuit formulas discussed earlier in this course, you can easily determine circuit characteristics.

Series-Parallel Circuit Resistance Calculations

Example 1

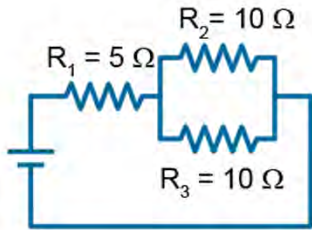

1. Combine the parallel resistors

$$R = \frac{1}{\frac{1}{10 \Omega} + \frac{1}{10 \Omega}} = \frac{10 \Omega}{2} = 5 \Omega$$

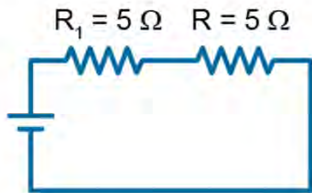

2. Add the series resistors

$$R_t = 5 \Omega + 5 \Omega = 10 \Omega$$

Example 2

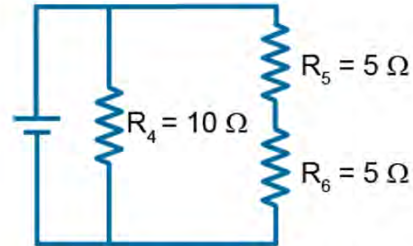

1. Add the series resistors

$$R = R_5 + R_6 = 5 \Omega + 5 \Omega = 10 \Omega$$

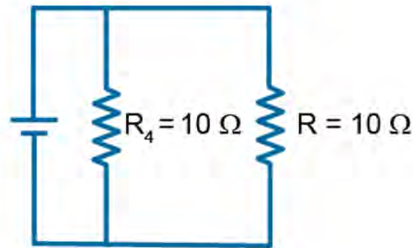

2. Combine the parallel resistors

$$R_t = \frac{1}{\frac{1}{10 \Omega} + \frac{1}{10 \Omega}} = \frac{10 \Omega}{2} = 5 \Omega$$

The accompanying illustration shows how total resistance can be determined for two series-parallel circuits in two easy steps for each circuit.

More complex circuits require more steps, but each step is relatively simple. In addition, by using Ohm's law, you can also solve for current and voltage throughout each circuit, if the source voltage is known.

Series-Parallel Circuit Current Calculations

Example 1

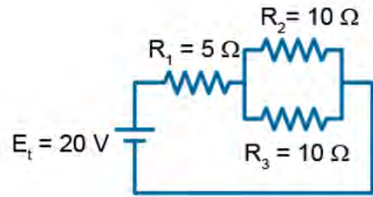

Equivalent Circuit

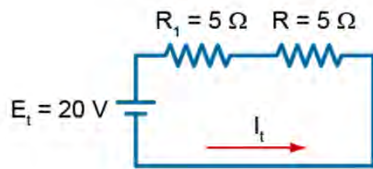

$$R_t = 10 \Omega \quad I_t = \frac{20 \text{ V}}{10 \Omega} = 2 \text{ A}$$

$$E_1 = I_t \times R_1 = 2 \text{ A} \times 5 \Omega = 10 \text{ V}$$

$$E_R = E_2 = E_3 = E_t - E_1 = 20 \text{ V} - 10 \text{ V} = 10 \text{ V}$$

$$I_t = I_2 + I_3 = \frac{E_R}{R_2} + \frac{E_R}{R_3} = \frac{10 \text{ V}}{10 \Omega} + \frac{10 \text{ V}}{10 \Omega} = 2 \text{ A}$$

Example 2

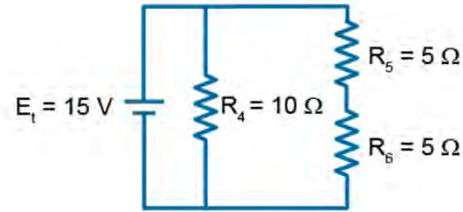

Equivalent Circuit

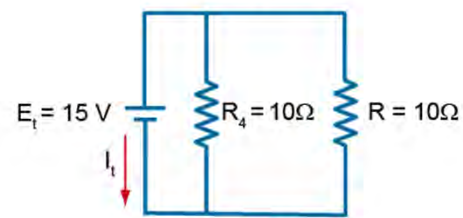

$$R_t = 5 \Omega \quad I_t = \frac{15 \text{ V}}{5 \Omega} = 3 \text{ A}$$

$$E_t = E_4 = E_R = 15 \text{ V}$$

$$I_t = I_4 + I_R = \frac{E_t}{R_4} + \frac{E_t}{R} = \frac{15 \text{ V}}{10 \Omega} + \frac{15 \text{ V}}{10 \Omega} = 3 \text{ A}$$

Using the same two series-parallel circuits as in the previous example, but with source voltages included, the accompanying illustration shows how Ohm's law can be used to calculate current values.

Power in a DC Circuit

Direct Current Power Formulas

$$P = I \times E = IE$$

$$P = IE = I(IR) = I^2R$$

$$P = IE = \left(\frac{E}{R}\right)E = \frac{E^2}{R}$$

Ohm's Law

$$E = I \times R = IR$$

$$I = \frac{E}{R}$$

Whenever a force of any kind causes motion, work is accomplished. If a force is exerted without causing motion, then no work is done.

In an electrical circuit, voltage applied to a conductor causes electrons to flow. Voltage is the force and electron flow is the motion. The rate at which work is done is called power and is represented by the symbol "P."

Power is measured in watts, represented by the symbol "W." In a direct current circuit, one watt is the rate at which work is done when 1 volt causes a current of 1 amp.

As shown on the left, from the formula power (P) = current (I) times voltage (E), the other formulas for power can be derived using Ohm's law.

DC Circuit Power Example

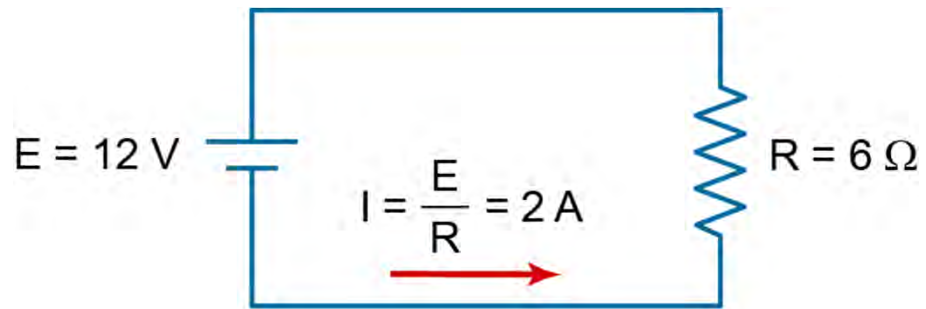

$$P = IE = (2\text{ A})(12\text{ V}) = 24\text{ W}$$

$$P = I^2R = (2\text{ A})^2(6\ \Omega) = 24\text{ W}$$

$$P = \frac{E^2}{R} = \frac{(12\text{ V})^2}{6\ \Omega} = 24\text{ W}$$

The accompanying illustration shows how power can be calculated using any of the power formulas.

Virtual Instructor-led Learning



Siemens virtual instructor-led courses offer you a live, classroom experience with the convenience and cost savings of online learning. These courses provide hands-on instruction and live interaction, delivered anywhere an internet connection is available.

Scheduled courses are typically 10-hour agendas presented Monday through Friday in two-hour sessions. These sessions provide you with lecture, demonstration, lab exercises, and Q&A sessions – all presented by Siemens subject matter experts.

For the full course duration, you can complete assignments and reinforce classroom instruction using a virtual cloud-based application providing 24/7 access to fully functional Siemens software such as SIMATIC STEP 7 and PLCSIM.

For additional information: www.usa.siemens.com/sitrain

Chapter 1 – Direct Current

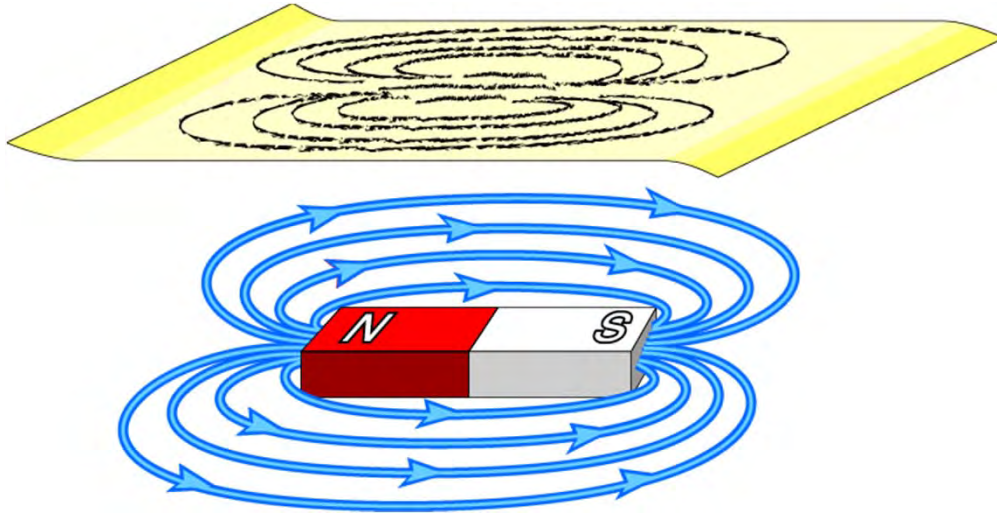

This chapter covers the following **topics**:

- Direct Current Basics
- DC Circuits
- **Magnetism**

Permanent Magnets

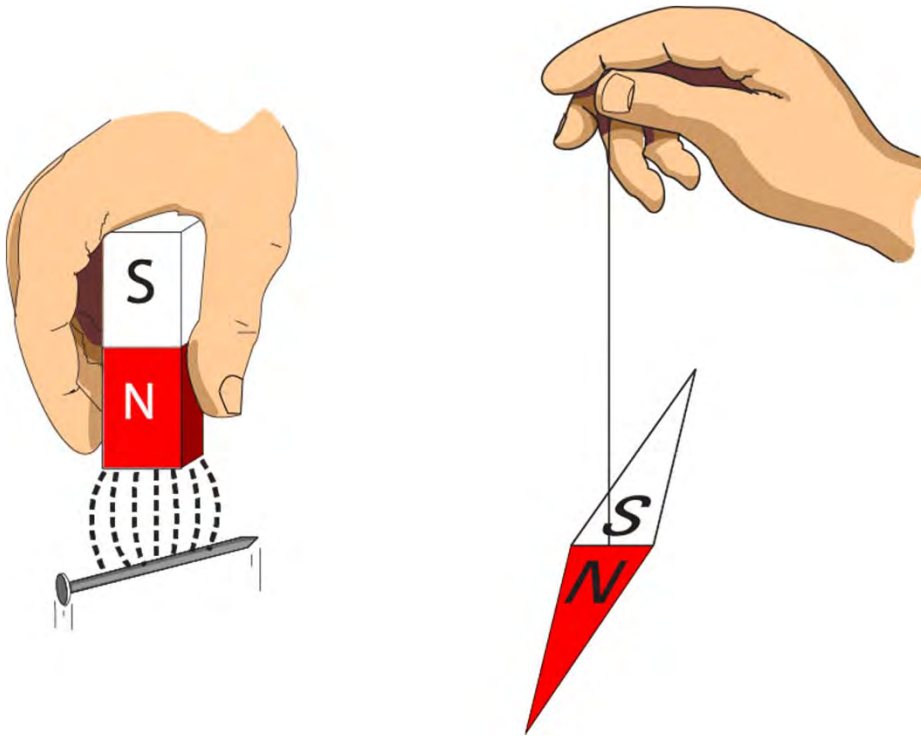

Magnetism and electricity are related concepts. Magnetism can be used to produce electric current and electric current produces a magnetic field.

When we think of a permanent magnet, we often envision a horseshoe or bar magnet or a compass needle, but permanent magnets come in many shapes.

However, all magnets have two characteristics. They attract iron and, if free to move (like the compass needle), a magnet will assume a north-south orientation.

Magnetic Lines of Flux

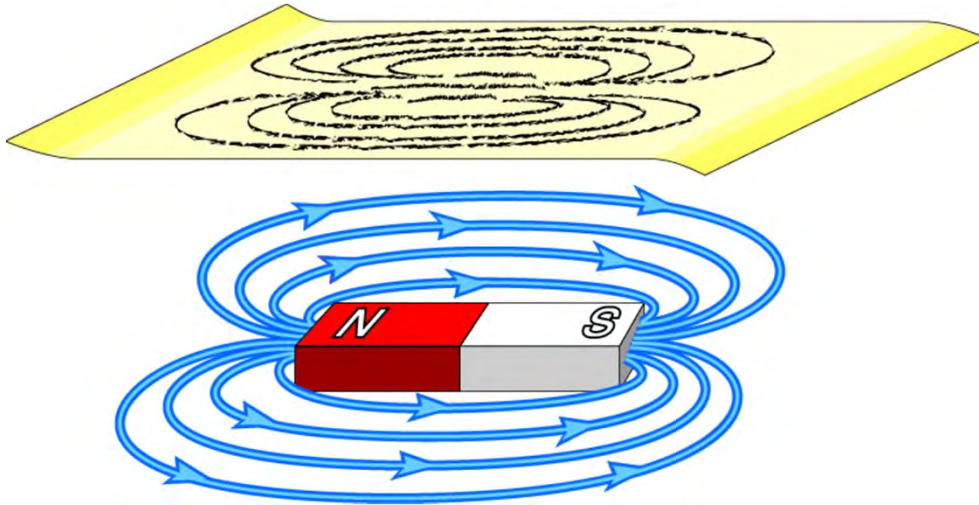

Every magnet has two poles, a north pole and a south pole. Invisible magnetic lines of flux leave the north pole and enter the south pole.

Although the lines of flux are invisible, the effects of magnetic fields can be made visible. When a sheet of paper is placed on a magnet and iron filings loosely scattered over it, the filings arrange themselves along the invisible lines of flux.

The density of these lines of flux is greatest inside the magnet and where the lines of flux enter and leave the magnet. The greater the density of the lines of flux, the stronger the magnetic field.

Interaction Between Magnets

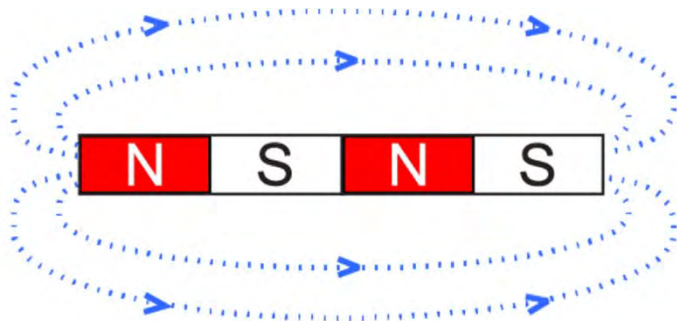

Unlike Poles Attract

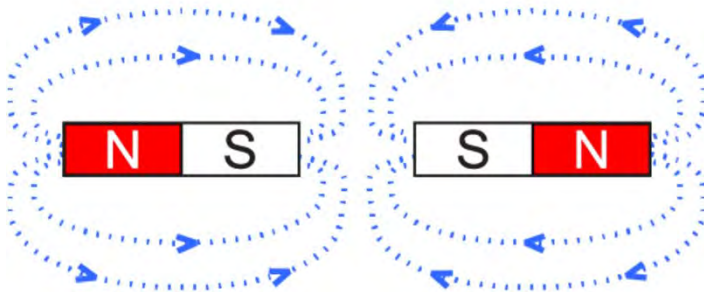

Like Poles Repel

When two magnets are brought together, the magnetic field around the magnets causes some form of interaction.

When two unlike poles are brought together, the magnets attract each other.

When two like poles are brought together, the magnets repel each other.

Electromagnetism

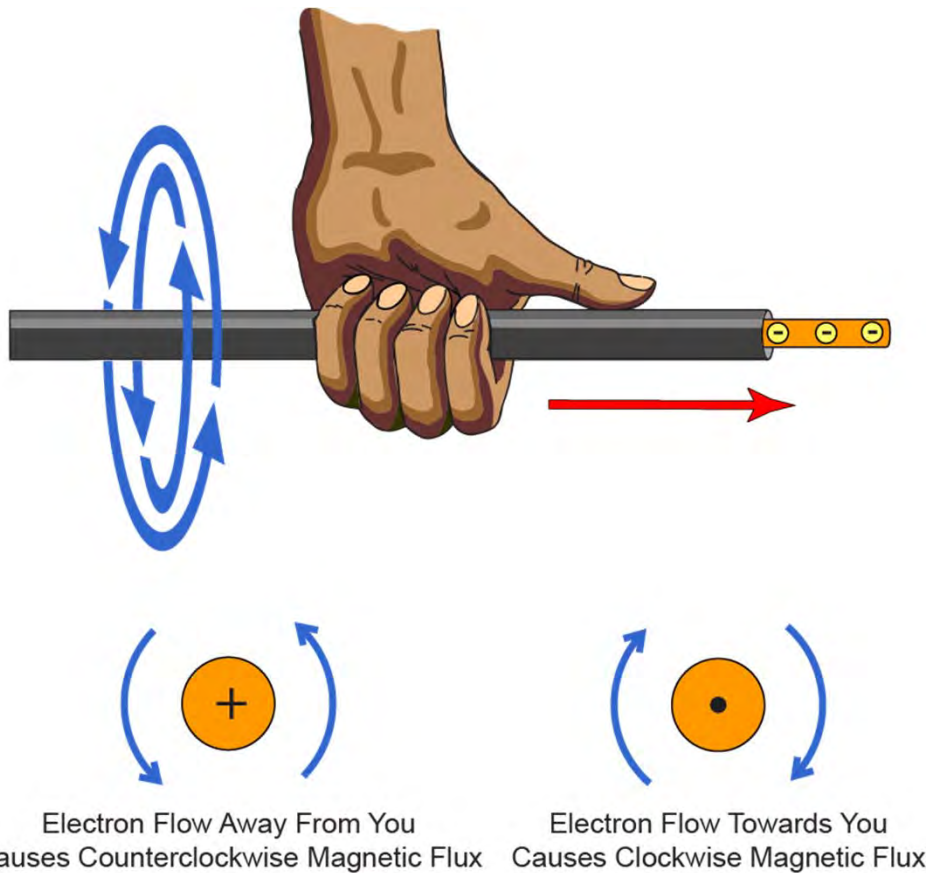

An electromagnetic field is a magnetic field generated by current flow in a conductor. Every electric current generates a magnetic field and a relationship exists between the direction of current flow and the direction of the magnetic field.

The left-hand rule for conductors demonstrates this relationship. If a current-carrying conductor is grasped with the left hand with the thumb pointing in the direction of electron flow, the fingers point in the direction of the magnetic lines of flux.

Electromagnets

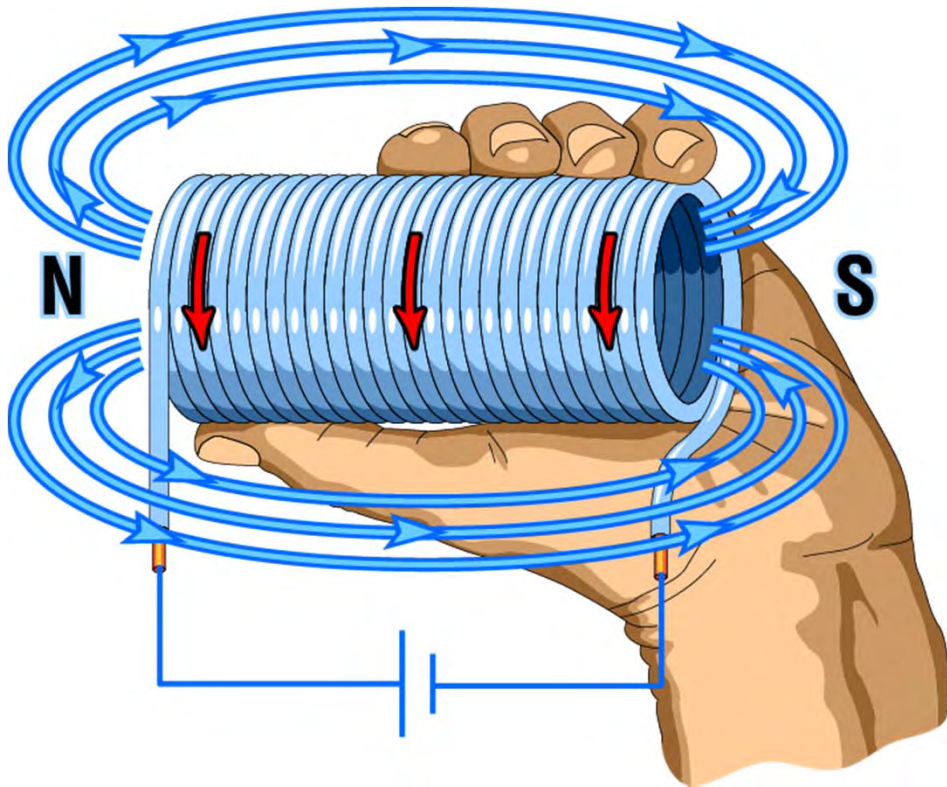

A coil of wire carrying a current, acts like a magnet. Individual loops of wire act as small magnets. The individual fields add together to form one magnet. The strength of the field can be increased by adding more turns to the coil, increasing the amount of current, or winding the coil around a material such as iron that conducts magnetic flux more easily than air.

The left-hand rule for coils states that if the fingers of the left hand are wrapped around the coil in the direction of electron flow. The thumb points to the north pole of the electromagnet.

An electromagnet is usually wound around a core of soft iron or some other material that easily conducts magnetic lines of force.

A large variety of electrical devices such as motors, circuit breakers, contactors, relays, and motor starters use electromagnetic principles.

Chapter 2 – Alternating Current

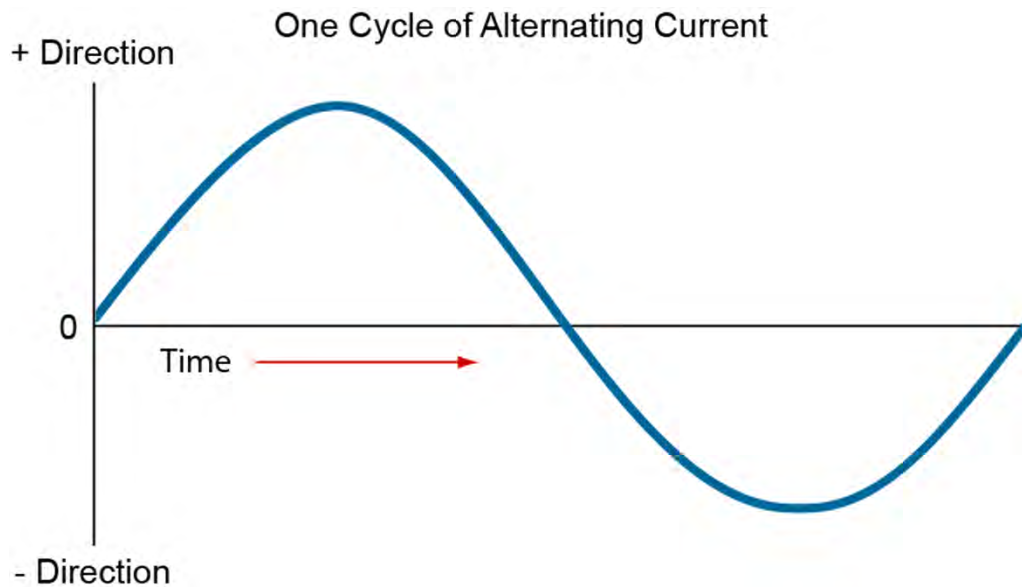

This chapter covers the following topics:

- **Alternating Current Basics**
- Inductance and Capacitance
- AC Circuits
- Transformers

Alternating Current

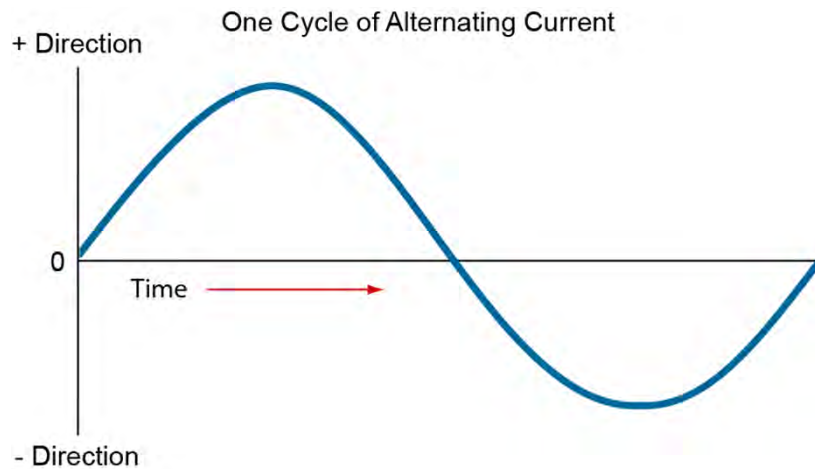

Current may come from a direct current (DC) source or an alternating current (AC) source. In a direct current circuit, electrons flow continuously in one direction from the source of power through a conductor to a load and back to the source of power. Voltage polarity for a DC source remains constant. DC sources include batteries and DC generators.

By contrast, an AC generator makes electrons flow first in one direction and then in another. In fact, an AC generator reverses its terminal polarities many times a second, causing current to change direction with each reversal.

Alternating voltage and current vary continuously in a pattern referred to as a sine wave. A sine wave can represent current or voltage. The accompanying illustration shows one cycle of a sine wave on a graph with two axes. The vertical axis represents the direction and magnitude of current or voltage. The horizontal axis represents time.

When the waveform is above the time axis, current is flowing in one direction. This is referred to as the positive direction. When the waveform is below the time axis, current is flowing in the opposite direction. This is referred to as the negative direction. A complete cycle of a sine wave has 360 degrees. Alternating current and voltage go through many of these cycles each second.

Basic AC Generator

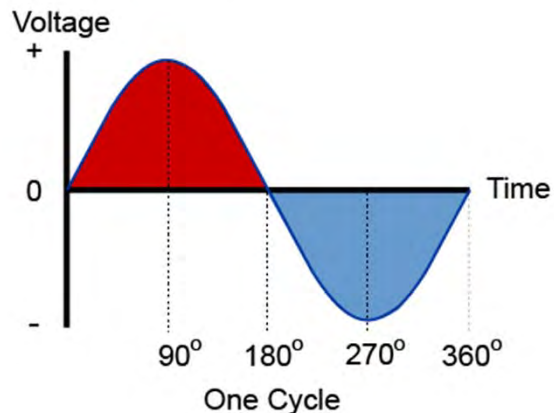
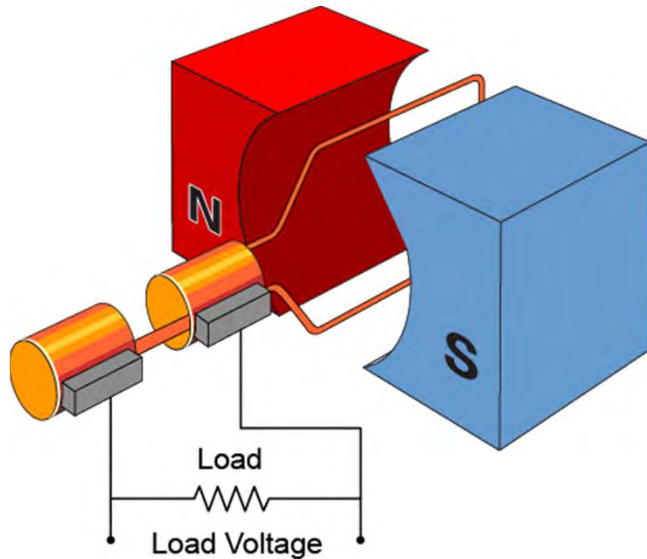

A basic generator consists of a magnetic field, an armature, slip rings, and brushes which connect to the load. In a commercial generator, the magnetic field is usually created by an electromagnet, but, this simple generator has permanent magnets. An armature is any number of conductive wires wound in loops which rotates through the magnetic field. For simplicity, this simple generator has only one loop.

As the armature rotates through the magnetic field, a voltage is generated in the armature, causing current to flow. Slip rings are attached to the armature and rotate with it. Carbon brushes ride against the slip rings to conduct current from the armature to the load, which in this case is a resistor.

If the movement of the AC generator is tracked through a complete rotation of 360 degrees, during the first quarter of a revolution, voltage increases until it reaches a maximum positive value at 90 degrees. Voltage decreases during the next quarter cycle to zero at 180 degrees. During the third quarter cycle, voltage increases in a negative direction and reaches a peak at 270 degrees. During the last quarter cycle, voltage returns to zero. This is one complete revolution. This process continues as long as the generator is in operation.

Frequency

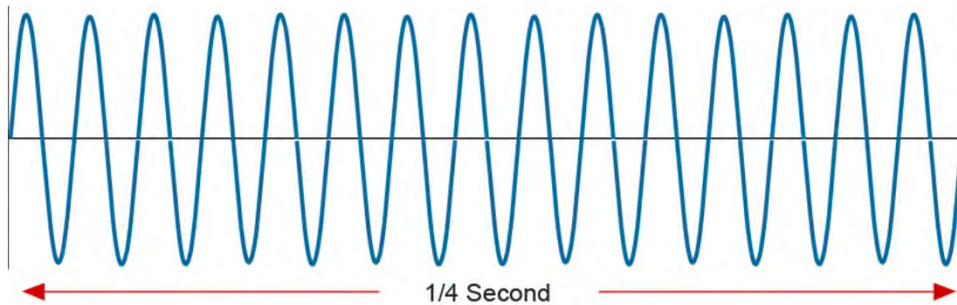

60 Hertz Alternating Current Waveform

The number of cycles per second of voltage and current induced in the armature is the frequency of the generator. If the armature rotates at a speed of 60 revolutions per second, the generated voltage will be 60 cycles per second. The recognized unit for frequency is hertz, abbreviated "Hz." 1 Hz is equal to 1 cycle per second.

Power companies generate and distribute electricity at very low frequencies. The standard power line frequency in the United States and many other countries is 60 Hz. 50 Hz is also a common power line frequency used throughout the world. The accompanying illustration shows 15 cycles in 1/4 second which is equivalent to 60 Hz.

Four-Pole AC Generator

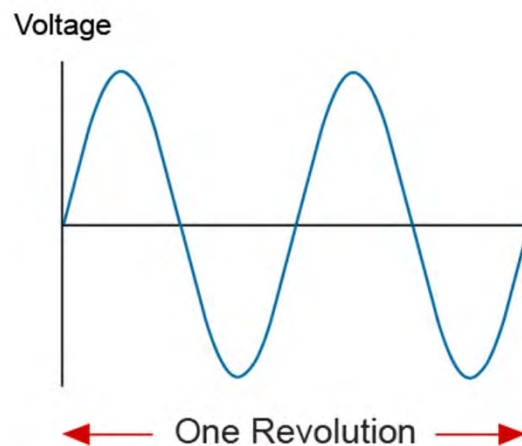
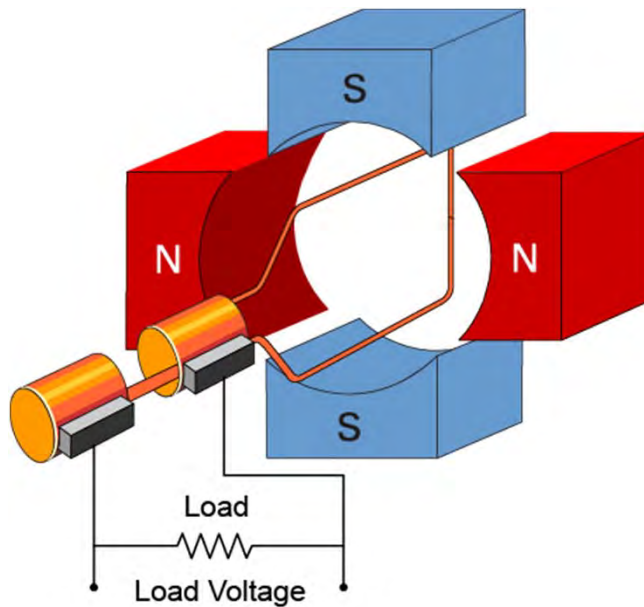

The frequency is the same as the number of rotations per second if the magnetic field is produced by only two magnetic poles. An increase in the number of poles causes an increase in the number of cycles completed in a revolution.

A two-pole generator completes one cycle per revolution and a four-pole generator, like the one shown on the left, completes two cycles per revolution. In other words, an AC generator produces one cycle per revolution for each pair of poles.

Amplitude

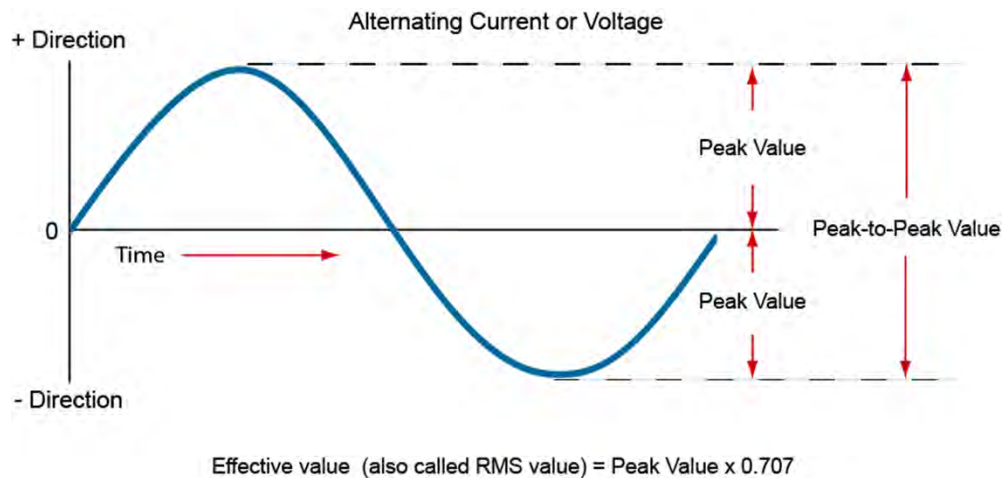

In addition to frequency, which is the rate of variation, an AC sine wave also has amplitude, which is the range of variation. Amplitude can be specified in three ways: peak value, peak-to-peak value, and effective value.

The peak value of a sine wave is the maximum value for each half of the sine wave.

The peak-to-peak value is the range from the positive peak to the negative peak. This is twice the peak value.

The effective value of AC is defined in terms of an equivalent heating effect when compared to DC. Instruments designed to measure AC voltage and current usually display the effective value. The effective value of an AC voltage or current is approximately equal to 0.707 times the peak value.

The effective value is also referred to as the RMS value. This name is derived from the root-mean-square mathematical process used to determine the effective value of a waveform.

Instantaneous Value

Instantaneous Value of Alternating Current or Voltage

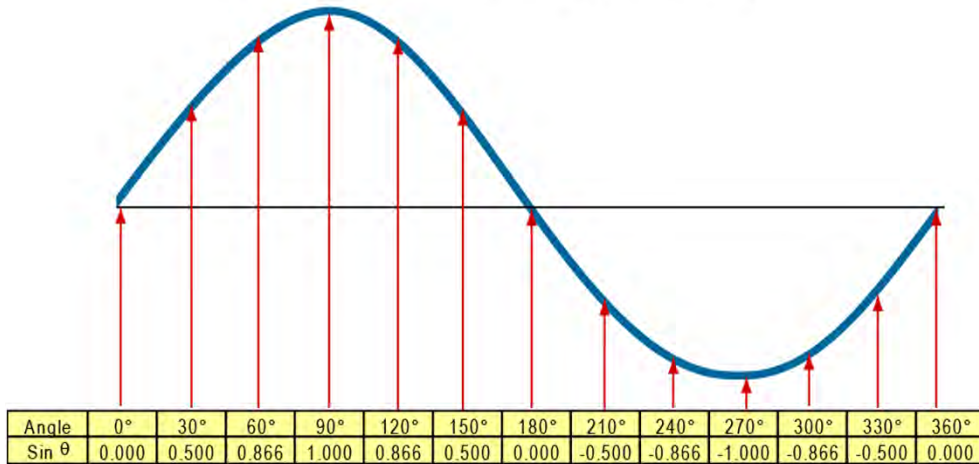

$$\text{Instantaneous current (i)} = I_{\text{peak}} \times \sin \theta$$

$$\text{Instantaneous voltage (e)} = E_{\text{peak}} \times \sin \theta$$

Example: if $E_{\text{peak}} = 170 \text{ V}$, at 150 degrees $e = (170 \text{ V})(0.5) = 85 \text{ V}$

The instantaneous value is the value at any one point on the sine wave. The voltage waveform produced as the armature of a basic two-pole AC generator rotates through 360 degrees is called a sine wave because the instantaneous voltage or current is related to the sine trigonometric function.

As shown in the accompanying illustration, the instantaneous voltage (e) and current (i) at any point on the sine wave is equal to the peak value times the sine of the angle. The sine values shown in the illustration are obtained from trigonometric tables.

Keep in mind that each point has an instantaneous value, but this illustration only shows the sine of the angle at 30 degree intervals. Also note that the angle is often symbolized by a Greek letter such as Theta (θ).

Classroom Learning



Studies indicate that when students practice what they have learned in a classroom setting they retain 75% of the lesson, as compared with lecture-only settings where they retain just 20% of the lesson.

Our learning content is reviewed and approved by Siemens technical and operational experts to ensure compliance with the highest industry, health, safety, and environmental standards. Siemens simulator workstations provide a safe and risk-free platform for job training, project testing, design engineering, and troubleshooting.

We combine technology and industry experience to deliver highly effective, customized learning programs.

- Job targeted courses
- Hands-on learning and skill building
- System-level training approach
- Extensive schedule of classes
- Various media and course length options
- On-site and custom courses
- Multiple training center locations
- Packaged services and products

For additional information: www.usa.siemens.com/sitrain

Chapter 2 – Alternating Current

Inductors (also called coils)



Schematic Symbols



Inductor Iron Core Inductor

Capacitors

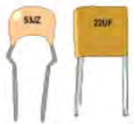

Schematic Symbols



This chapter covers the following topics:

- Alternating Current Basics
- **Inductance and Capacitance**
- AC Circuits
- Transformers

Inductance and Inductors

All electrical products have inductance, but the products shown below are examples of products that are primarily inductive.

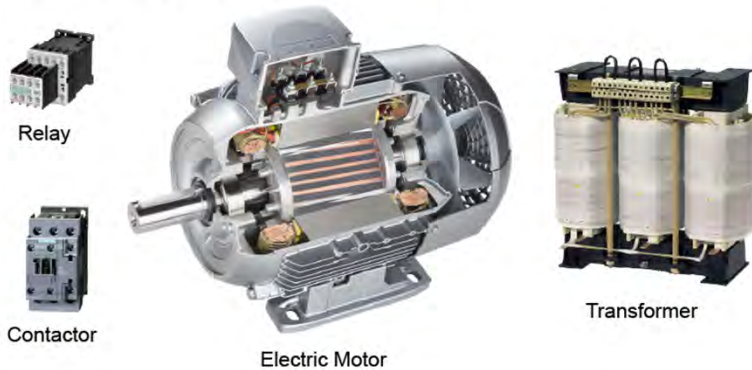

The circuits shown to this point have been resistive. Resistance and voltage are not the only circuit properties that effect current flow, however. Resistance opposes current flow. Inductance opposes changes in current flow. Inductance is designated by the letter “L”. The unit of measurement for inductance is the henry (h).

Current flow produces a magnetic field in a conductor. The amount of current determines the strength of the magnetic field. As current flow increases, field strength increases, and as current flow decreases, field strength decreases.

Inductors are components manufactured to have a specific inductance.

Inductors (also called coils)

Schematic Symbols



Inductor



Iron Core Inductor

$$\text{Inductance (L)} = (\text{Permeability of Core}) \times \frac{(\text{Number of Turns})^2 \times (\text{Cross Sectional Area})}{\text{Length}}$$

Any change in current causes a corresponding change in the magnetic field surrounding the conductor. Current is constant for a regulated DC source, except when the circuit is turned on and off, or when there is a load change. However, alternating current is constantly changing, and inductance is continually opposing the change. A change in the magnetic field surrounding the conductor induces a voltage in the conductor. This self-induced voltage is referred to as counter emf because it opposes the change in current.

Commonly Used Units		
Unit	Short Form	Decimal Value
1 henry	1 h	1 h
1 millihenry	1 mh	0.001 h
1 microhenry	1 μh	0.000001 h

All circuits have inductance, but an inductor is a coil of wire wound for a specific inductance. For some applications, inductors are wound around a metal core to further concentrate the inductance. The inductance of a coil is determined by the number of turns in the coil, the coil diameter and length, and the core material.

Inductors in Series

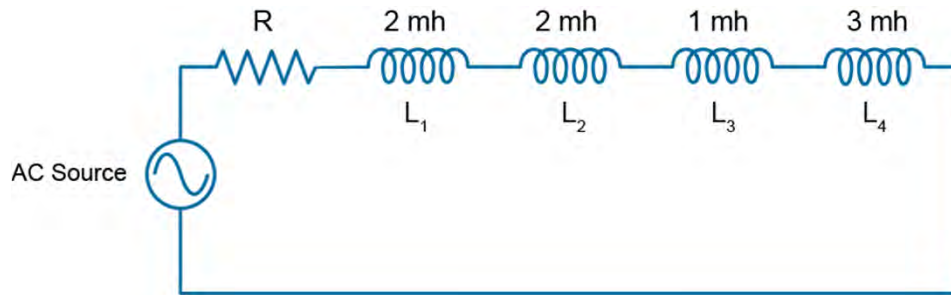

$$L_t = L_1 + L_2 + L_3 + L_4 = 2 \text{ mh} + 2 \text{ mh} + 1 \text{ mh} + 3 \text{ mh} = 8 \text{ mh}$$

Commonly Used Units		
Unit	Short Form	Decimal Value
1 henry	1 h	1 h
1 millihenry	1 mh	0.001 h
1 microhenry	1 μ h	0.000001 h

The accompanying circuit diagram shows an AC source that supplies electrical power through a resistor to four inductors connected in series. The total inductance of series inductors is equal to the sum of the inductances.

Because the henry is a large unit of inductance, inductance is often expressed using metric unit prefixes. For example, 0.001 h is equal to 1 millihenry or 1 mh for short.

Inductors in Parallel

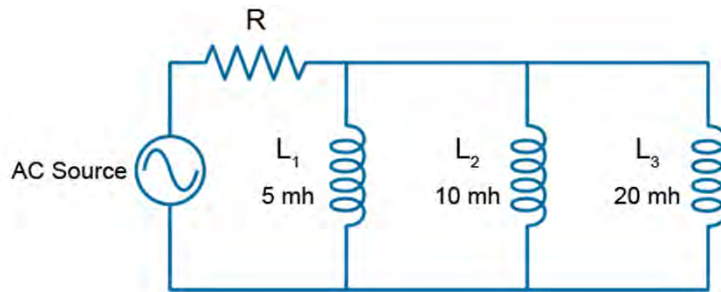

The accompanying circuit diagram shows an AC source that supplies electrical power through a resistor to three parallel inductors. Connecting inductors in series decreases the total inductance.

The total inductance of parallel inductors is calculated using a formula similar to the formula for the resistance of parallel resistors.

$$\frac{1}{L_t} = \frac{1}{L_1} + \frac{1}{L_2} + \frac{1}{L_3} = \frac{1}{5 \text{ mh}} + \frac{1}{10 \text{ mh}} + \frac{1}{20 \text{ mh}} = \frac{4}{20 \text{ mh}} + \frac{2}{20 \text{ mh}} + \frac{1}{20 \text{ mh}} = \frac{7}{20 \text{ mh}}$$

$$L_t = \frac{1}{\frac{1}{L_1} + \frac{1}{L_2} + \frac{1}{L_3}} = \frac{1}{\frac{7}{20 \text{ mh}}} = \frac{20 \text{ mh}}{7} = 2.86 \text{ mh}$$

Capacitance and Capacitors

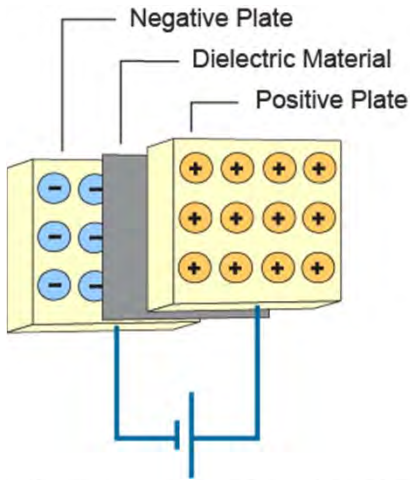

Direct current cannot flow through a capacitor unless it is defective

Capacitors are components manufactured to have a specific capacitance.

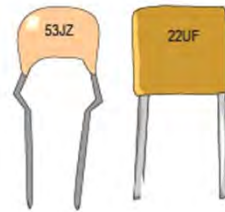

Schematic Symbols



Capacitance is a measure of a circuit's ability to store an electrical charge. All circuits have some amount of capacitance, but a capacitor is a device manufactured to have a specific amount of capacitance.

A capacitor is made up of a pair of conductive plates separated by a thin layer of insulating material called a dielectric.

When a voltage is applied to the plates, electrons are forced onto one plate. That plate has an excess of electrons while the other plate has a deficiency of electrons. The plate with an excess of electrons is negatively charged. The plate with a deficiency of electrons is positively charged.

Direct current cannot flow through the dielectric because it is an insulator; however, the electric field created when the capacitor is charged is felt through the dielectric.

The capacitance of a capacitor depends on the area of the plates, the distance between the plates, and type of dielectric material used. The unit of measurement for capacitance is the farad (F). However, because the farad is a large unit, capacitors are often rated in microfarads or picofarads.

Commonly Used Units		
Unit	Short Form	Decimal Value
1 farad	1 F	1 F
1 microfarad	1 μ F	0.000001 F
1 picofarad	1 pF	0.000000000001 F

Capacitors in Series

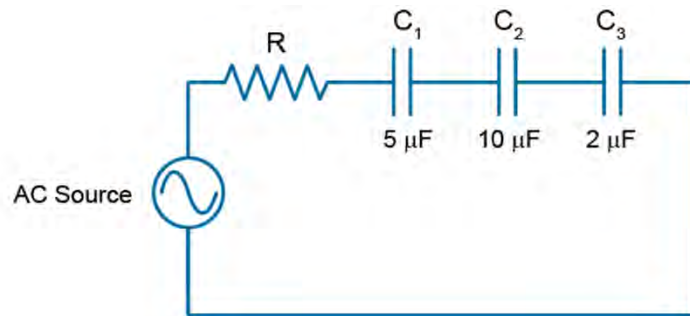

The accompanying circuit diagram shows an AC source that supplies electrical power through a resistor to three series capacitors. Connecting capacitors in series decreases the total capacitance.

The total capacitance of series capacitors is calculated using a formula similar to the formula for the resistance of parallel resistors.

$$\frac{1}{C_t} = \frac{1}{C_1} + \frac{1}{C_3} + \frac{1}{C_2} = \frac{1}{5 \mu\text{F}} + \frac{1}{10 \mu\text{F}} + \frac{1}{2 \mu\text{F}} = \frac{2}{10 \mu\text{F}} + \frac{1}{10 \mu\text{F}} + \frac{5}{10 \mu\text{F}} = \frac{8}{10 \mu\text{F}}$$

$$C_t = \frac{1}{\frac{1}{C_1} + \frac{1}{C_2} + \frac{1}{C_3}} = \frac{1}{\frac{8}{10 \mu\text{F}}} = \frac{10 \mu\text{F}}{8} = 1.25 \mu\text{F}$$

Capacitors in Parallel

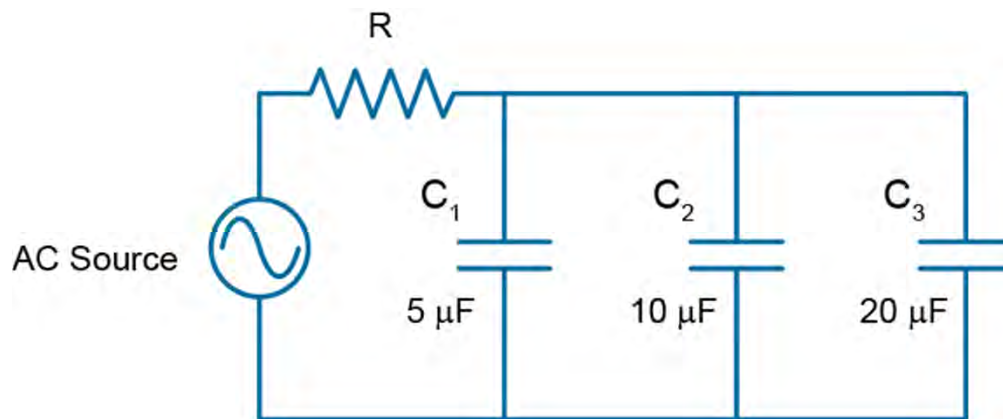

The accompanying circuit diagram shows an AC source that supplies electrical power through a resistor to three parallel capacitors. Connecting capacitors in parallel increases the total capacitance.

The total capacitance of parallel capacitors is equal to the sum of the capacitances.

$$C_t = C_1 + C_2 + C_3 = 5 \mu\text{F} + 10 \mu\text{F} + 20 \mu\text{F} = 35 \mu\text{F}$$

How-to Video Library



This extensive library of short videos was created by our instructional experts to meet the real-world needs of industry, with all levels of experience in mind. By providing on-demand, how-to instruction in easy-to-understand bites, the How-to Video Library helps maintain the critical industrial and manufacturing knowledge and skills developed during instructor-led training courses. Videos are typically three-minutes long and conveniently available via any computer or mobile device with Internet access.

Learning begins once you've completed registration.

- Start your subscription at any time. Videos are available 24/7/365.
- Purchase one, three, six, or 12-month subscriptions by technology or in one complete bundle.
- Take advantage of our most-flexible option – ultimate access with a full, one-year subscription.

For additional information: www.usa.siemens.com/sitrain

Chapter 2 – Alternating Current

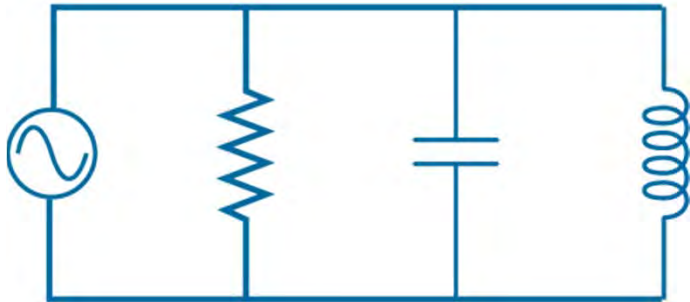
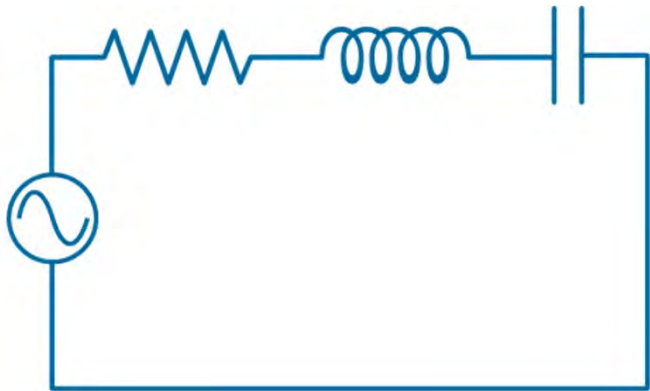

This chapter covers the following topics:

- Alternating Current Basics
- Inductance and Capacitance
- **AC Circuits**
- Transformers

Inductive Reactance

$$\text{Inductive Reactance } (X_L) = 2\pi fL$$

f = Frequency, L = Inductance
 2π is approximately equal to 6.28

If f = 60 Hz and L = 100 mh

$$X_L = 6.28 \times 60 \times 0.1 = 37.7 \Omega$$

The same inductor has a inductive reactance of 628 Ω at 1 kHz.

$$X_L = 6.28 \times 1000 \times 0.1 = 628 \Omega$$

(Note: 100 mh = 0.1 h)

In a purely resistive AC circuit, resistance is the only opposition to current flow. In an AC circuit with only inductance, capacitance, or both inductance and capacitance, but no resistance, opposition to current flow is called reactance, designated by the symbol "X."

Total opposition to current flow in an AC circuit that contains both reactance and resistance is called impedance, designated by the symbol "Z." Just like resistance, reactance and impedance are expressed in ohms.

Inductance only affects current flow when the current is changing. Inductance produces a self-induced voltage (counter emf) that opposes changes in current.

In an AC circuit, current is changing constantly. Inductance in an AC circuit, therefore, causes a continual opposition. This opposition to current flow is called inductive reactance. As the accompanying formula for Inductive reactance (X_L) shows, it is proportional to both inductance (L) and frequency (f).

Current and Voltage Phases

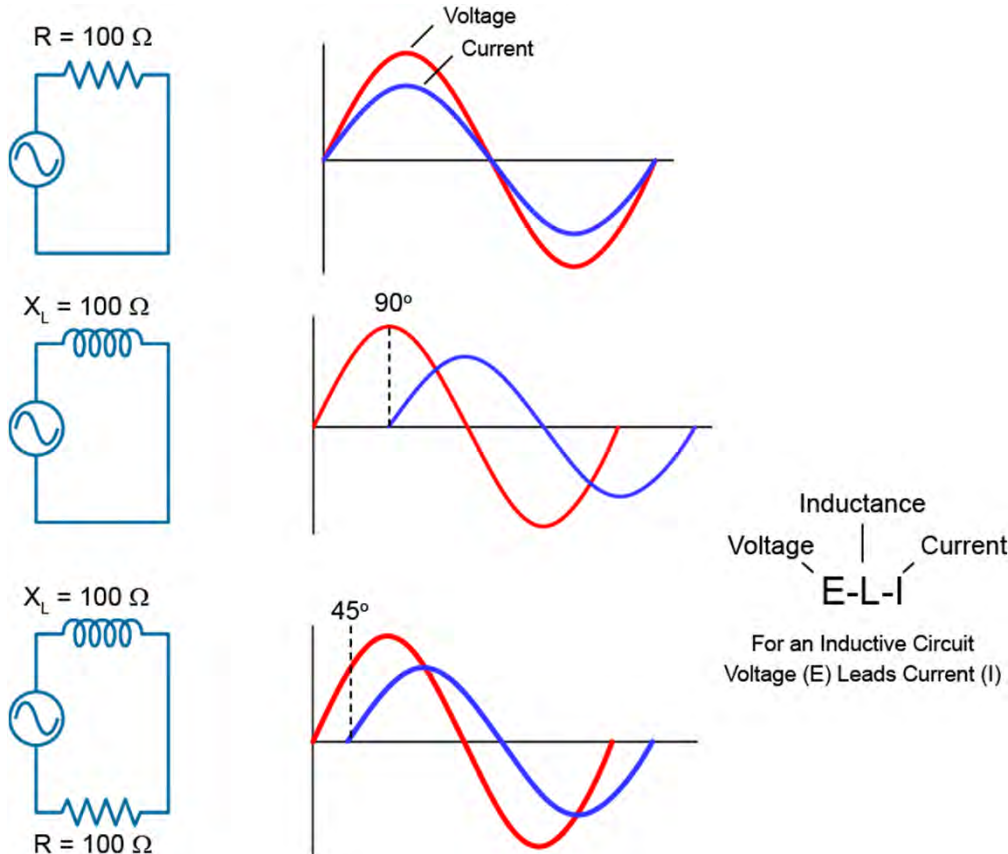

In a purely resistive circuit, current and voltage rise and fall at the same time. They are said to be “in phase.” For the circuit in the top illustration, there is no inductance. Therefore, resistance and impedance are the same.

In a purely inductive circuit, voltage leads current by 90 degrees. Current and voltage are said to be “out of phase.” For the circuit in the middle illustration, impedance and inductive reactance are the same.

All circuits have some resistance, however, and in an AC circuit with both resistance and inductive reactance, voltage leads the current by more than 0 degrees and less than 90 degrees. For the circuit in the bottom illustration, resistance and inductive reactance are equal and voltage leads current by 45 degrees.

Another way to say this is that current lags the voltage in a circuit with resistance and inductance. The exact amount of lag depends on the relative amounts of resistance and inductive reactance. The more resistive a circuit is, the closer it is to being in phase. The more reactive a circuit is, the more out of phase it is.

Capacitive Reactance

$$\text{Capacitive Reactance } (X_c) = \frac{1}{2\pi fC}$$

f = Frequency, C = Capacitance
 2π is approximately equal to 6.28

If f = 60 Hz and C = 100 μ F

$$X_c = \frac{1}{6.28 \times 60 \times 0.0001} = \frac{1}{0.0377} = 26.5 \Omega$$

The same capacitor has a capacitive reactance of 1.59 Ω at 1 kHz

$$X_c = \frac{1}{6.28 \times 1000 \times 0.0001} = \frac{1}{0.628} = 1.59 \Omega$$

(Note: 100 μ F = 0.0001 F)

Capacitors also oppose current flow in an AC circuit. This opposition is called capacitive reactance.

Capacitive reactance is inversely proportional to frequency and capacitance. Therefore, the larger the capacitor or the higher the frequency, the smaller the capacitive reactance.

Current and Voltage Phases

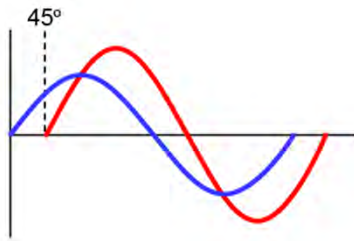
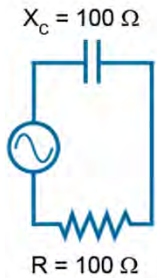
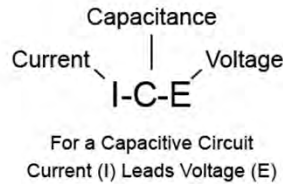
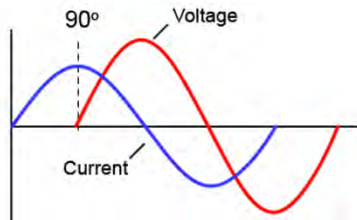
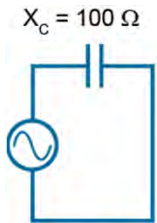

For capacitive circuits, the phase relationship between current and voltage is opposite to the phase relationship for an inductive circuit. In a purely capacitive circuit, current leads voltage by 90 degrees.

In an AC circuit with both resistance and capacitive reactance, current leads voltage by more than 0 degrees and less than 90 degrees. The exact amount of lead depends on the relative amounts of resistance and capacitive reactance. The more resistive a circuit is, the closer it is to being in phase. The more reactive a circuit is, the more out of phase it is.

In the bottom illustration, resistance and capacitive reactance are equal and current leads voltage by 45 degrees.

Calculating Impedance

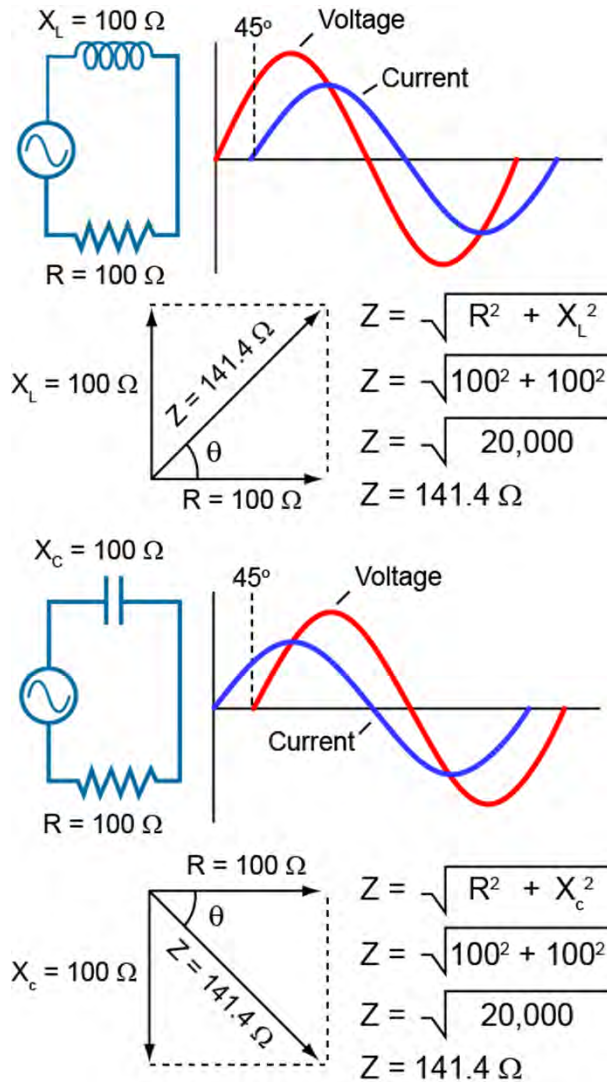

Impedance (Z) is the total opposition to current flow in an AC circuit. Impedance is often represented as a vector. A vector is a quantity that has magnitude and direction.

An impedance vector diagram shows reactance and resistance vectors at right angles to each other with the impedance vector plotted at some angle in between the reactance and resistance vectors. Resistance is plotted at 0 degrees, inductive reactance at 90 degrees, and capacitive reactance at -90 degrees.

The accompanying illustration shows two circuits with equal values of resistance and reactance. The upper circuit has inductive reactance and resistance, and the lower circuit has capacitive reactance and resistance. The magnitude of the impedance vectors is determined by taking the square root of the sum of the squares of reactance and resistance.

Although the magnitude of the impedance vector (141.4 ohms) is the same for both circuits, the angles of the impedance vectors are different. For the upper circuit, the impedance vector has an angle of +45 degrees, but for the lower circuit, the angle is -45 degrees. Note the relationship between the impedance vector angle and the phase relationship between voltage and current for each circuit.

Series R-L-C Circuit

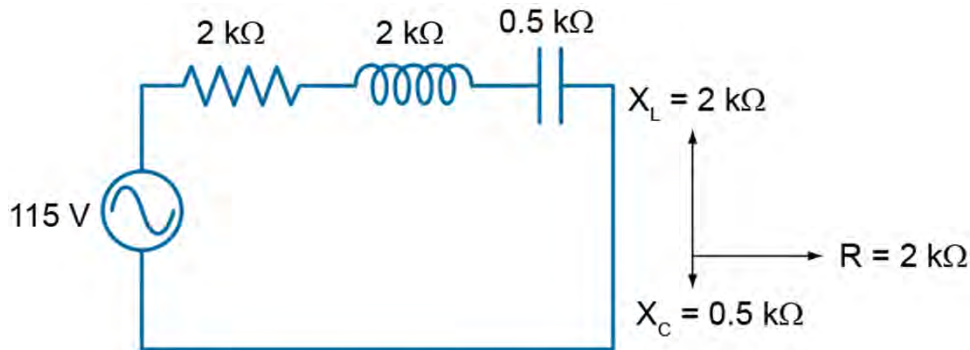

$$Z_t = \sqrt{R^2 + (X_L - X_C)^2}$$

$$Z_t = \sqrt{2000^2 + 1500^2}$$

$$Z_t = \sqrt{6,250,000}$$

$$Z_t = 2500 \Omega = 2.5 \text{ k}\Omega$$

Z_t = Total Impedance

$$X_L = 1.5 \text{ k}\Omega$$

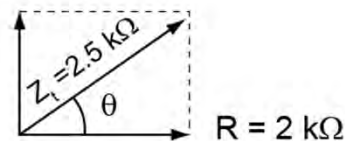

$$I = \frac{E}{Z_t} = \frac{115 \text{ V}}{2500 \Omega} = 0.046 \text{ A} = 46 \text{ mA}$$

Many circuits contain values of resistance, inductance, and capacitance in series. In an inductive AC circuit, current lags voltage by 90 degrees. In a capacitive AC circuit, current leads voltage by 90 degrees. When represented in vector form, inductive reactance and capacitive reactance are plotted 180 degrees apart. As a result, the net reactance is determined by taking the difference between the two reactances.

The total impedance of the circuit can be calculated using the formula shown in the accompanying illustration. Once the total impedance is known, the current can be determined using Ohm's law.

Keep in mind that because both inductive reactance and capacitive reactance are dependent upon frequency, if the frequency of the source voltage changes, the net reactance changes. For example, if frequency increases, inductive reactance increases and capacitive reactance decreases.

For the special case where the inductive reactance and capacitive reactance are equal, the circuit impedance is the total resistance. This type of circuit is called a series resonant circuit.

Parallel R-L-C Circuit

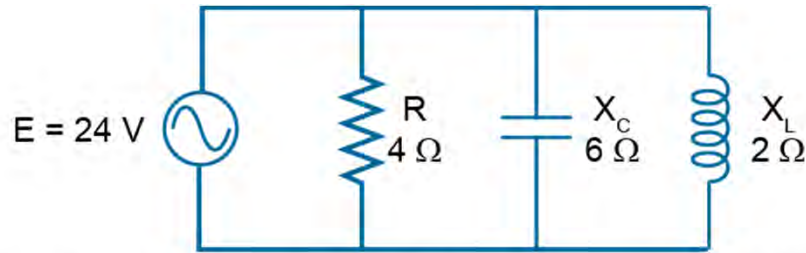

$$I_R = \frac{E}{R} = \frac{24 \text{ V}}{4 \Omega} = 6 \text{ A} \quad I_C = \frac{E}{X_C} = \frac{24 \text{ V}}{6 \Omega} = 4 \text{ A} \quad I_L = \frac{E}{X_L} = \frac{24 \text{ V}}{2 \Omega} = 12 \text{ A}$$

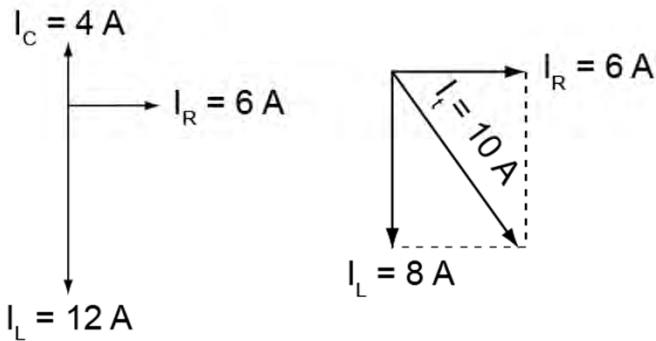

$$I_t = \text{Total Current}$$

$$I_t = \sqrt{I_R^2 + (I_C - I_L)^2}$$

$$I_t = \sqrt{6^2 + 8^2}$$

$$I_t = \sqrt{100}$$

$$I_t = 10 \text{ A}$$

$Z_t = \text{Total Impedance}$

$$Z_t = \frac{E}{I_t} = \frac{24 \text{ V}}{10 \text{ A}}$$

$$Z_t = 2.4 \Omega$$

Many circuits contain values of resistance, inductance, and capacitance in parallel. One method for determining the total impedance for a parallel circuit is to begin by calculating the total current.

In a capacitive AC circuit, current leads voltage by 90 degrees. In an inductive AC circuit, current lags voltage by 90 degrees. When represented in vector form, capacitive current and inductive current are plotted 180 degrees apart. The net reactive current is determined by taking the difference between the reactive currents.

The total current for the circuit can be calculated using the formula shown in the accompanying illustration. Once the total current is known, the total impedance can be calculated using Ohm's law.

Keep in mind that because both inductive reactance and capacitive reactance are dependent upon frequency, if the frequency of the source voltage changes, the reactances and corresponding currents change. For example, if the frequency increases, the inductive reactance increases, and the current through the inductor decreases, but the capacitive reactance decreases and the current through the capacitor increases.

Power in an AC Circuit

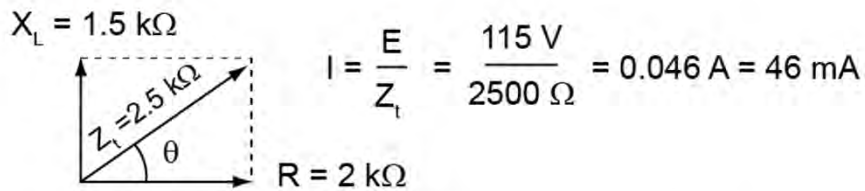
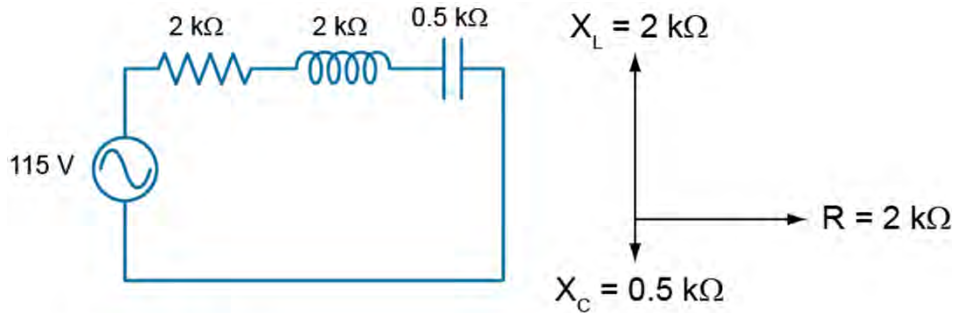

True Power = $I^2R = (0.046 \text{ A})^2 \times 2 \text{ k}\Omega = 4.232 \text{ W}$

Apparent Power = $IE = 0.046 \text{ A} \times 115 \text{ V} = 5.29 \text{ VA}$

In resistive circuits, power is dissipated in heat. This is called true power or effective power because it is the rate at which energy is used. True power is equal to the current squared times the resistance. The unit for true power is the watt.

Although reactive components do not consume energy, they do increase the amount of energy that must be generated to do the same amount of work. The rate at which this non-working energy must be generated is called reactive power. The unit for reactive power the var (or VAr), which stands for volt-amperes reactive.

The vector sum of true power and reactive power is called apparent power. Apparent power is also equal to the total current multiplied by the applied voltage ($P = IE$). The unit for apparent power is the volt-ampere (VA).

Power Factor

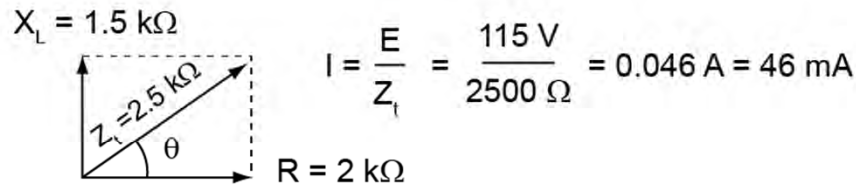
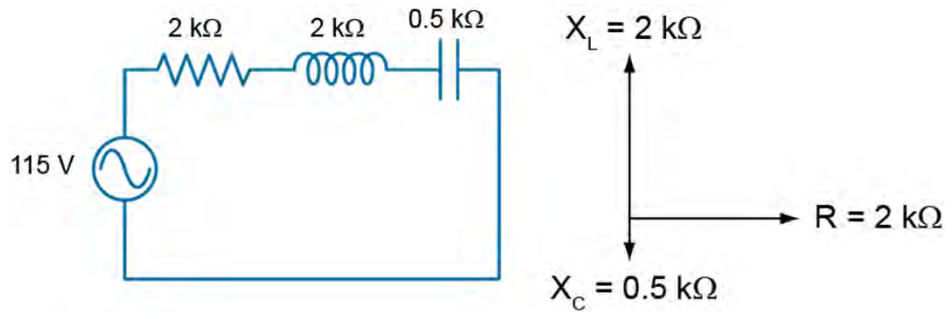

True Power = $I^2R = (0.046 \text{ A})^2 \times 2 \text{ k}\Omega = 4.232 \text{ W}$

Apparent Power = $IE = 0.046 \text{ A} \times 115 \text{ V} = 5.29 \text{ VA}$

Power Factor (PF) = $\frac{\text{True Power}}{\text{Apparent Power}} = \cos \theta$ (cosine of angle θ)

$PF = \frac{4.232 \text{ W}}{5.29 \text{ VA}} = 0.8 = \cos \theta$

True Power = Apparent Power $\times \cos \theta = IE \cos \theta$

True Power = $IE \cos \theta = 0.046 \text{ A} \times 115 \text{ V} \times 0.8 = 4.232 \text{ W}$

Power factor is the ratio of true power to apparent power in an AC circuit. This ratio is also the cosine of the phase angle.

In a purely resistive circuit, current and voltage are in phase. This means that there is no angle of displacement between current and voltage. The cosine of a zero degree angle is one. Therefore, the power factor is one. This means that all energy delivered by the source is consumed by the circuit and dissipated in the form of heat.

In a purely reactive circuit, voltage and current are 90 degrees apart. The cosine of a 90 degree angle is zero. Therefore, the power factor is zero. This means that all the energy the circuit receives from the source is returned to the source.

For the circuit in the accompanying illustration, the power factor is 0.8. This means that the circuit uses 80 percent of the energy supplied by the source and returns 20 percent to the source.

True power is equal to the apparent power times the power factor. This is I times E times the cosine of the phase angle.

Simulators



Engineered to provide a real-world experience, Siemens simulators are fully functional, ready-to-use systems available in a variety of configurations.

System-level design makes the simulators an invaluable tool for program testing and debugging, reinforcing learning, shop floor troubleshooting, and more. With portable construction and hard-shell cases, they can be easily transported. Custom-built systems are also available.

For additional information: www.usa.siemens.com/sitrain

Chapter 2 – Alternating Current



This chapter covers the following topics:

- Alternating Current Basics
- Inductance and Capacitance
- AC Circuits
- **Transformers**

Transformers

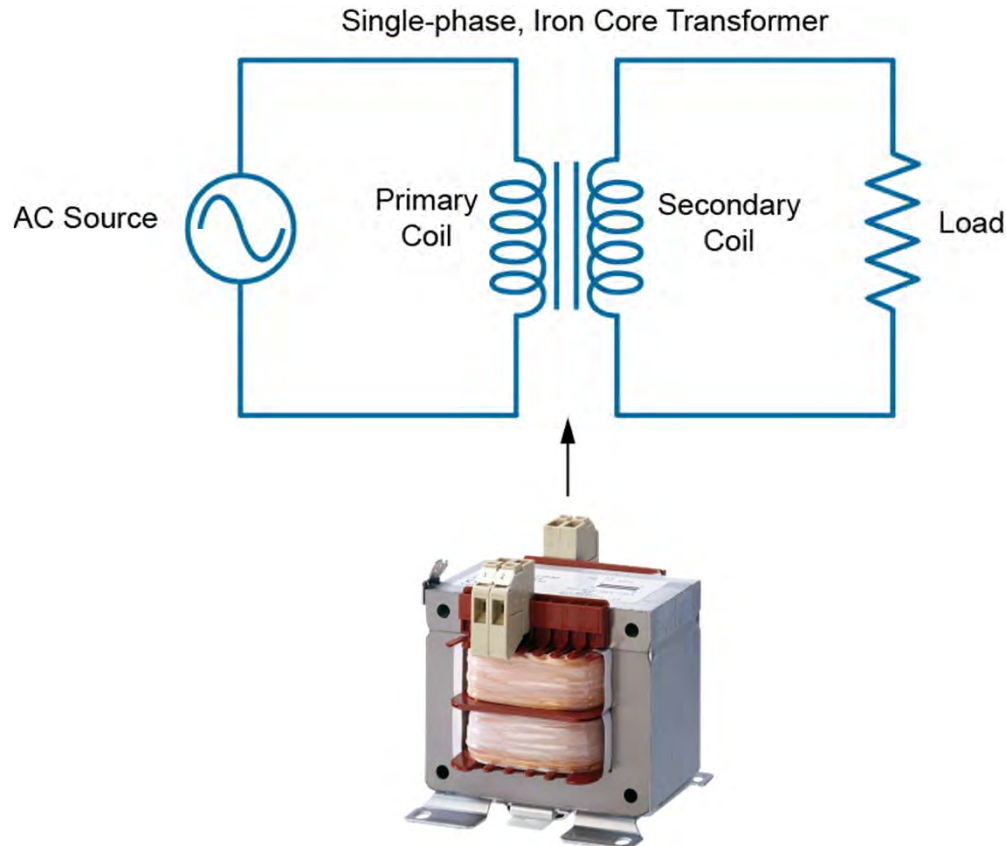

Transformers are electromagnetic devices that transfer electrical energy from one circuit to another by mutual induction. They are frequently used to step up or step down a voltage. Because direct current cannot flow from one transformer winding to another, transformers can also be used to provide DC isolation from one circuit to another.

A single-phase transformer has two coils, a primary coil and a secondary coil. Energy is transferred from the primary to the secondary via mutual induction.

The accompanying illustration shows an AC source connected to the primary coil. The magnetic field produced by the primary induces a voltage in the secondary coil, which supplies power to a load.

Mutual inductance between two coils depends on their flux linkage. Maximum coupling occurs when all the lines of flux from the primary coil cut through the secondary coil. To maximize the amount of coupling, both coils are often wound on the same iron core, which provides a good path for the lines of flux. The following discussions of step-up and step-down transformers apply to transformers with an iron core.

Transformer Turns Ratio

Step-up Transformer Example

- Primary Voltage (E_p) = 120 V
- Primary Current (I_p) = 10 A
- Number of Primary Turns (N_p) = 900
- Secondary Voltage (E_s) = 240 V
- Secondary Current (I_s) = 5 A
- Number of Secondary Turns (N_s) = 1800

Step-down Transformer Example

- Primary Voltage (E_p) = 240 V
- Primary Current (I_p) = 5 A
- Number of Primary Turns (N_p) = 1800
- Secondary Voltage (E_s) = 120 V
- Secondary Current (I_s) = 10 A
- Number of Secondary Turns (N_s) = 900

There is a relationship between primary and secondary voltage, current, and impedance and the ratio of transformer primary turns to secondary turns.

When the primary has fewer turns than the secondary, voltage is stepped up from primary to secondary. For the circuit on the left, the transformer secondary has twice as many turns as the primary, and voltage is stepped up from 120 VAC to 240 VAC. Because the impedance of the load is also higher than the impedance of the primary, current is stepped down from 10 amps to 5 amps.

When the primary has more turns than the secondary, voltage is stepped down from primary to secondary. For the circuit on the right, the primary coil has twice as many turns as the secondary coil, and voltage is stepped down from 240 VAC to 120 VAC. Because the impedance of the load is lower than the impedance of the primary, the secondary current is stepped up from 5 amps to 10 amps.

Transformers are rated for the amount of apparent power they can provide. Because values of apparent power are often large, the transformer rating is frequently given in kVA (kilovolt-amps).

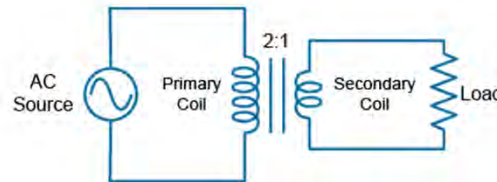
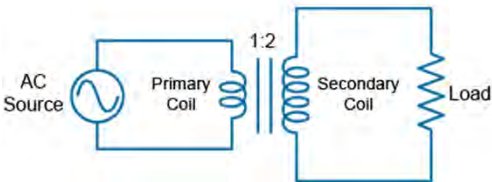

$$\frac{N_P}{N_S} = \frac{E_P}{E_S} = \frac{I_S}{I_P} \quad E_S = \frac{N_S E_P}{N_P} \quad I_S = \frac{N_P I_P}{N_S} \quad Z_P = \left(\frac{N_P}{N_S}\right)^2 Z_L$$

Z_P = Impedance of the Primary
 Z_L = Impedance of the Load

Residential Transformers

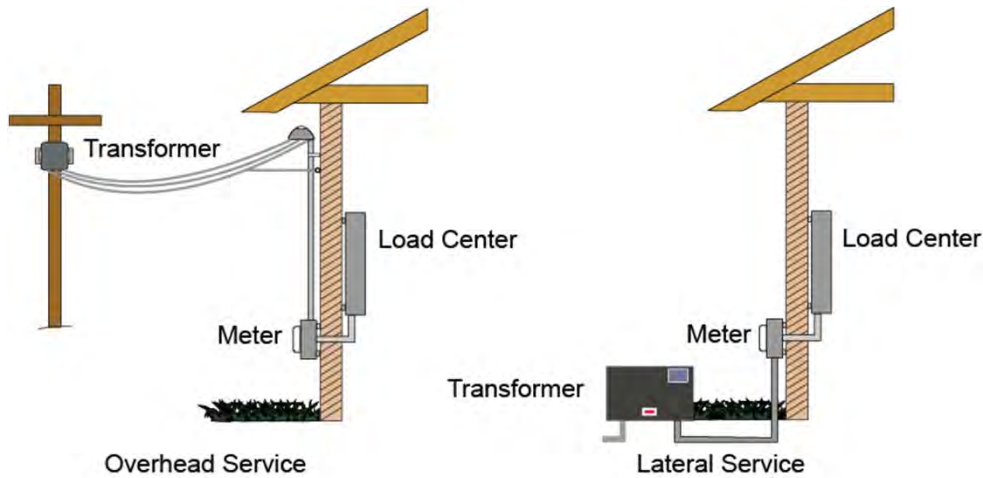

The most common power supply system used in residential applications in the United States today is a single-phase, three-wire supply system.

In this system, the voltage between either hot wire and neutral is 120 volts and the voltage between the two hot wires is 240 volts.

The 120-volt supply is used for general-purpose receptacles and lighting. The 240 volt supply is used for heating, cooling, cooking, and other high-demand loads

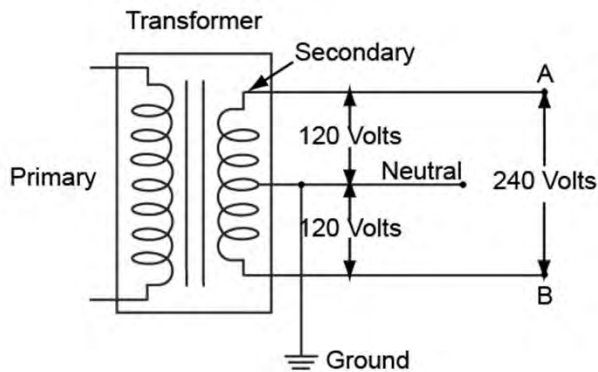

Three-Phase Power

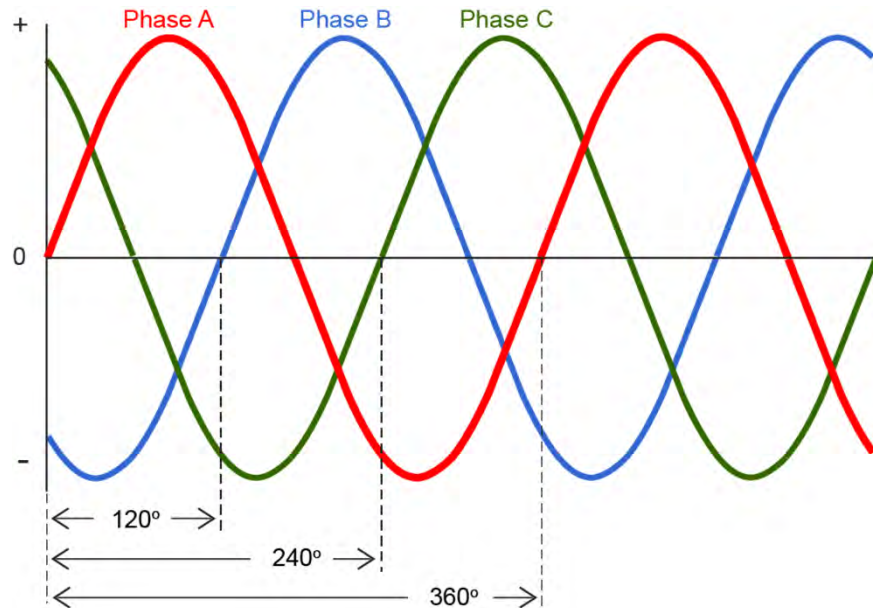

Up till now, we have been talking only about single-phase AC power. Single-phase power is used where power demands are relatively small, such as for a typical home.

However, power companies generate and distribute three-phase power. Three-phase power is used in commercial and industrial applications.

Three-phase power, as shown in the accompanying illustration, is a continuous series of three overlapping AC cycles. Each wave represents a phase and is offset by 120 electrical degrees from each of the two other phases.

Three-Phase Transformers

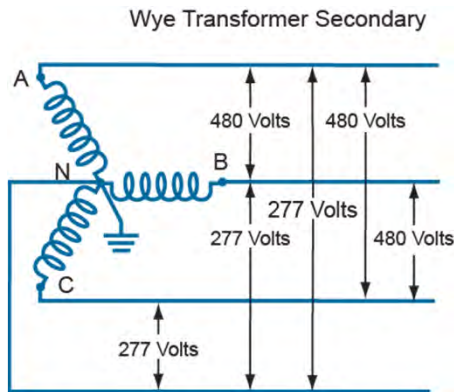

- A - B 480 Volts
- B - C 480 Volts
- C - A 480 Volts
- A - N 277 Volts
- B - N 277 Volts
- C - N 277 Volts

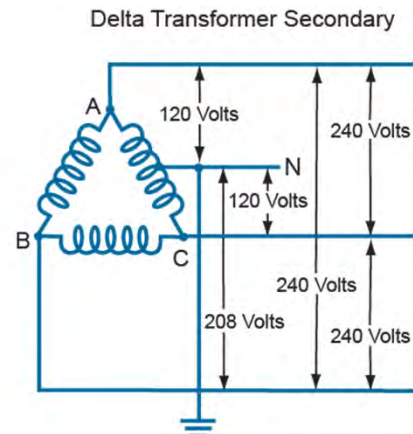

- A - B 240 Volts
- B - C 240 Volts
- C - A 240 Volts
- A - N 120 Volts
- B - N 208 Volts
- C - N 120 Volts

Transformers used with three-phase power require three interconnected coils in both the primary and the secondary. These transformers can be connected in either a wye or a delta configuration. The type of transformer and the actual voltage depend on the requirements of the power company and the needs of the customer.

The accompanying illustration shows the secondary of a wye-connected transformer and the secondary of a delta-connected transformer. These are only examples of possible distribution configurations, the specific voltages and configurations vary widely depending upon the application requirements.



SITRAIN® Training for Industry



Online Self-paced Learning – Programs with maximum flexibility so students can easily fit courses into their busy schedules



Virtual Instructor-led Learning - Classroom lectures delivered in the convenience of your home or office



Classroom Learning - Expert and professional instructors, proven courseware, and quality workstations combine for the most effective classroom experience possible at your facility or ours



How-to Video Library - Quick, affordable, task-based learning options for a broad range of automation topics for training or purchase



Simulators - World-class simulation systems available for training or purchase

For additional information: www.usa.siemens.com/sitrain

SITRAIN World



From the basics to advanced specialist skills, Siemens SITRAIN courses deliver extensive expertise directly from the manufacturer and encompass the entire spectrum of Siemens Industry products and systems.

Worldwide, SITRAIN courses are available in over 200 locations in over 60 countries.

For additional information including a SITRAIN world map and SITRAIN contacts worldwide:

<http://sitrain.automation.siemens.com/sitrainworld/Default.aspx>

Course Completion

This course covered the following topics:

Introduction

Chapter 1 – Direct Current

- Direct Current Basics
- DC Circuits
- Magnetism

Chapter 2 – Alternating Current

- Alternating Current Basics
- Inductance and Capacitance
- AC Circuits
- Transformers

This course has covered the topics shown on the left. Thank you for your efforts. You can complete this course by taking the final exam and scoring at least 70%.