

BEAVER PATRIOT® THUNDER

2008

BEAVER PATRIOT® THUNDER | 2008



## BEAVER PATRIOT® THUNDER | 2008

### Patriot Thunder. The power to move you.

The 2008 Patriot Thunder is made to stir your emotions. Your heart begins to pound with excitement as you slide behind the wheel to experience the powerful CAT® 525 HP C-13 engine. Exhilaration overcomes you as you take in all the beauty and luxury. And finally, all longing leaves your body and is replaced with feelings of gratitude and harmony. Because with the 2008 Patriot Thunder, you've found everything you were looking for — and so much more.



#### BEAVER WOODS. WORKS OF ART.

Only the devotion of a true artist can turn the ordinary into the extraordinary. Our hardwood cabinets are handcrafted by skilled artisans. Hours of painstaking work are put into creating the one-of-a-kind high-gloss finish. It's what elevates our cabinets from utility items to genuine works of art.







## 2008 HIGHLIGHTS

- The exclusive PanaSuite™ full-wall slide, only available on the Winchester III, creates more room and an open feeling with a single slide that stretches almost the entire length of the RV.
- All new exterior graphics with five colors and integrated fades.
- Interior highlights include a standard 17-cubic-foot four-door refrigerator, high-gloss Corian® countertops and Ralph Lauren decors.
- Newly designed lifestyle floorplans are filled with unique features such as 30-inch-deep bed slide-out boxes for more room and comfort.





**A balanced approach.**

You'll be ready to go in the perfectly balanced cockpit. The power of the CAT® engine stays under control with the two-tone leather Smartwheel®. The smooth Roadmaster chassis seamlessly merges with the comfort of the 6-way power Ultraleather® seats. Entertainment works in conjunction with safety. The same dash that houses an in-dash AM/FM stereo with multi-disc CD changer and optional XM or Sirius satellite stereo, also has room for a rear vision system and optional GPS navigation system.







#### WHEN THE ACTION SLOWS.

At the end of the day, kick back and take in a movie on the bedroom's 23" LCD television and DVD player. But first you can wash your cares away in the spacious shower with Corian® caddy or optional bathtub.



#### In the still of the night.

There'll be no sleepless nights here. Not with the comfort of a pillowtop-hinged mattress or the optional king-size air mattress with digital remote. Staying organized won't keep you awake either, thanks to ample closet and drawer space for all your personal belongings.





BEAVER PATRIOT® THUNDER | 2008

### What's your pleasure?

Make your life on the road whatever you want it to be — packed with adventure or filled with quiet moments. Like the ones you'll enjoy sharing during meals at this elegant dinette table that efficiently slides into place between two freestanding chairs. Or you can choose the optional booth dinette ensemble. After a quiet dinner, the easy-to-clean solid surface top makes a great place to map out the next day's escapades.







**LIKE MAGIC.**



One option worth considering is the central vacuum system with toe kick vacuum in the pantry base. No more lugging a vacuum along to clean carpets. And, with the handy toe kicks, a quick touch whisks away dirt you've swept up off the tile. Just like magic.



BEAVER PATRIOT® THUNDER | 2008



**Keep your focus on fun.**

The Patriot Thunder is designed for carefree living. For example, our beautiful ceramic tile floors and high-gloss Corian® countertops are easy to clean. And, you have the option of a stack washer and dryer or a combination washer and dryer. Both are conveniently located and easily hidden out of sight. So you can spend time seeing sights other than the Laundromat.



### Along for the ride.

Patriot Thunder features a 10,000 lb. hitch receiver and 7/4-way trailer plug. Yes, you read that correctly — ten thousand pounds. Even with extra weight, the Patriot Thunder delivers a smooth, easy ride. Thanks to the combination of a Roadmaster chassis, a full-cushion air glide suspension, and, for safety and security, front and rear air disc brake systems with ABS. So go ahead and hitch up your sports car, sedan or even the SUV.



#### ROOM TO SPARE.

No need to pack lightly. The Patriot Thunder has large, lined storage compartments with insulated baggage doors and power locks. To make loading and unloading a snap, add the optional pass-through storage bay with manual or electric slide-out tray.







## Improving on Mother Nature.

Ahhh, the great outdoors. Make it even better with Patriot Thunder's Girard® awning package. It includes colorful, durable awning for the rear patio, front door, slide-out topper and windows. The automatic feature makes setup and teardown a breeze. And, you can bring the entertainment outdoors as well, with an optional 32" Sharp LCD television. Now that's sure to get your neighbor's attention.

## WE'RE HERE. ANYTIME, EVERY TIME.

- Reach us anytime – literally – via our live customer support line.
- Drive in to one of our 350 Service Centers.
- Enjoy the first year free when you enroll in our Owner Advantage Roadside Assistance Program.
- See where it all begins with a tour of one of our facilities in Indiana or Oregon. Call **1-800-650-7337** or **1-800-634-0855** to find out more.



**ASSISTANCE**  
SALES • TECH • ROADSIDE

**1-877-4MONACO**





## ROADMASTER CHASSIS AND CONSTRUCTION

### It's all riding on a Roadmaster.

Ask any Beaver owner, and they'll tell you — it's the Roadmaster chassis that makes the difference. That's because the Roadmaster is custom-built to the exact specifications of each Beaver model and floorplan. You see, Roadmaster has a 100% commitment to only producing luxury motorhome chassis — and that's something no other manufacturer can say. We invite you to take a closer look at the highlights of the Patriot Thunder's incomparable S-Series semi-monocoque chassis. You'll find that it leads the way in safety, performance, convenience and reliability.

### POWERED BY CATERPILLAR®

Beaver is proud to offer Caterpillar® 525 HP C-13 engines with ACERT® technology. Road tested for millions of miles, CAT® engines offer unbeatable reliability and durability. Plus, a CAT® with ACERT® technology gives you high performance with the lowest operating costs in the industry. In fact, its maintenance intervals are 30,000 miles, compared with 25,000 for other engines. The C-13 outperforms the competition in horsepower and torque and features the tremendous responsiveness of series turbo charging. The CAT® is also backed by an industry-leading 5-year/200,000-mile warranty with no deductible. And finally, ACERT® technology gives you the cleanest running engine available — and is fully compliant with EPA-mandated standards.

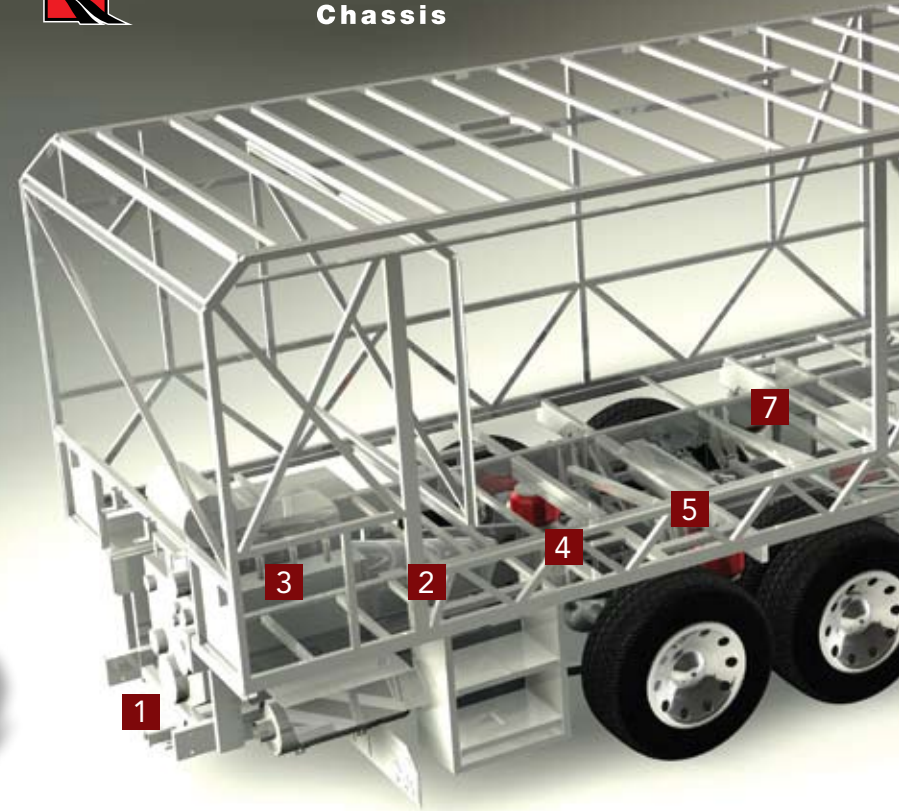

ROADMASTER S-SERIES SEMI-MONOCOQUE CHASSIS

- 1 10,000 lb. hitch receiver offers powerful towing capacity with 7/4-way trailer plug. The coach is also prewired for a supplemental braking system.
- 2 The three-point engine mounting system lowers the coach's center of gravity and reduces the amount of vibration that reaches the coach. The mounting also makes the engine easier to service by allowing the engine to be easily lowered through the bottom of the coach.
- 3 Caterpillar® 525 HP ACERT® C-13 Engine.
- 4 Allison® 4000 MH 6-Speed World Transmission for smooth shifting; our exclusive use of synthetic transmission fluid allows for up to three-year maintenance intervals.
- 5 Full Cushion Air Glide suspension system positions ten Bilstein® shocks and ten air bags, eight of which are outboard mounted with auto-leveling for greater stability, a smoother ride and the best handling in its class.
  - Unique three-degree rear axle tilt perfectly aligns the engine, transmission and differential, minimizing stress on the drivetrain and reducing noise and vibration in the coach.
  - Automatic Traction Control (ATC) eliminates wheel slippage in slick conditions and heightens control.
  - Tag axle lifts for added maneuverability in tight spots.

### ACTIVE CONTROL DAMPENING (ACD)

This optional state-of-the-art system monitors suspension and chassis movement thousands of times per second and adapts the suspension to the input. The result: superior control and unbeatable ride quality.



With the optional GPS navigation system, you're free to explore the middle of nowhere and always know exactly where you are.



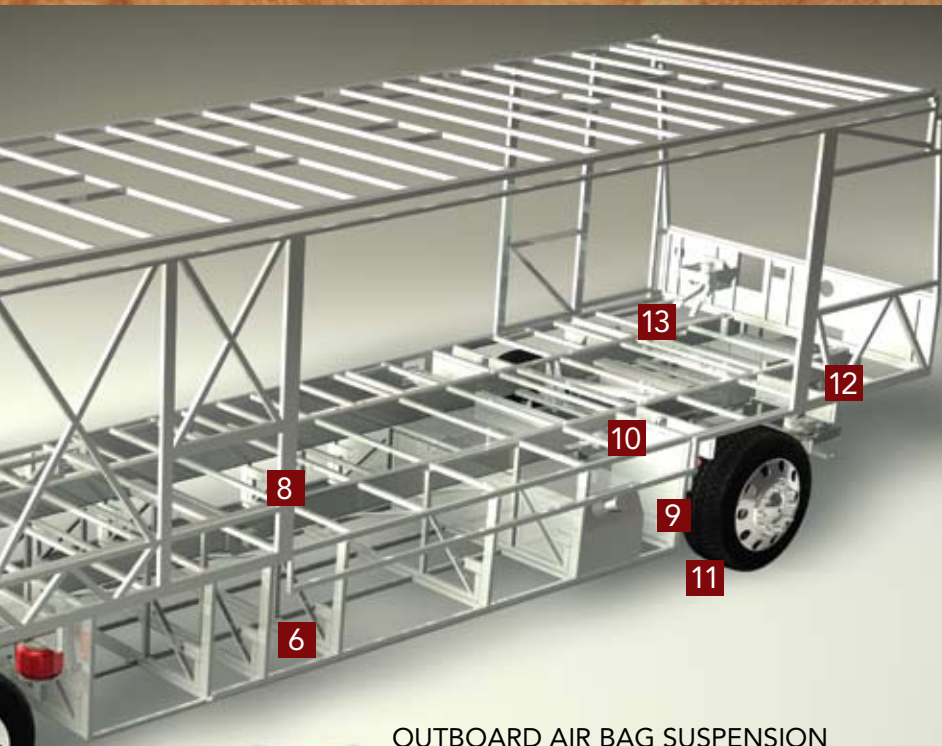

### OUTBOARD AIR BAG SUSPENSION



The outboard-mounted air bags are protected by two steel plates and are placed farther apart than the competition, providing a wider, more stable platform for the coach. The active suspension automatically adjusts the pressure of the air bags as you drive and virtually eliminates nosediving and the side-to-side body sway associated with high wind conditions, curvy roads and emergency maneuvers.

- 6 Basement structure rust inhibitor: To prevent corrosion, the basement storage area is constructed with pre-primed steel with rust-inhibiting paint.
- 7 Full-length frame rails fabricated from 3" by 8" by 1/4" 60,000 PSI structural steel; rails are spaced 44" on center for a wider stance and unmatched strength.
- 8 The semi-monocoque design, with trussed superstructure, distributes stress evenly throughout the entire chassis and adds strength to sidewalls and bays.
- 9 Compression Two-Stage Engine Brake assures you of safely traveling steep grades while 6-wheel anti-lock brakes with disc brakes in both the front and rear help you maintain control in severe road conditions.

- 10 Dual ping air tanks with 3/4" air lines for quicker response and improved ride and handling.
- 11 P295/80R Goodyear steel-belted all-season tires ensure a safe and quiet ride (G670 RV tire).
- 12 The truss power steering box allows for a 50-degree front wheel turn angle in both directions for better maneuverability and returns the steering wheel to its center position to eliminate driver fatigue.
- 13 All chassis are equipped with steel cage construction, steel firewall and steel stepwell for added safety.

### 8-LAYER ROOF CONSTRUCTION (top to bottom)

- One-piece 1/4" thick fiberglass roof, crowned for water runoff and seamlessly joined with front and rear end caps
- Vapor barrier
- 3-1/2" tapered bead foam supports the crowned roof; the center tunnel houses wiring and air conditioner ducts
- 1/4" marine grade plywood sheeting
- Tubular steel framework
- R 7.5 closed cel foam seals every nook and crevice
- Luaun and vinyl paneling are Vac-U-Bonded
- Sound-absorbing, easy-to-clean padded vinyl interior headliner

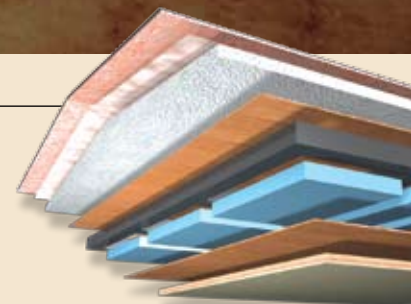

### 6-LAYER WALL CONSTRUCTION (left to right)

- Gel coat fiberglass outer wall
- Luaun paneling
- Heavy-gauge tubular steel and 4" steel plate backers
- R 7.5 closed cel foam seals every nook and crevice
- Luaun paneling; walls are Vac-U-Bonded together
- Decorative wall coverings



### 5-LAYER FLOOR CONSTRUCTION (top to bottom)

- Tile, or 1/2" carpet pad and carpeting
- Dyna-Span flooring
- Decibel layer
- Dyna-Span flooring
- Waterproof fiberglass underbelly

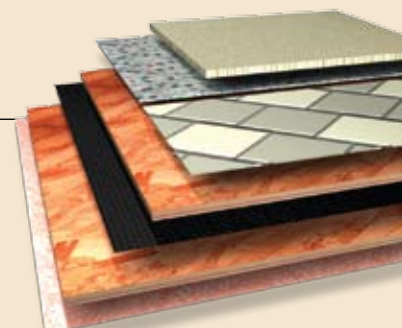

This optional collision avoidance system utilizes a combination of sensors, software and radar to warn you of potential hazards on the road ahead and alongside your coach, which may be outside your view.

### WARRANTIES

12 Month/24,000 Mile basic limited warranty; 5 Year/50,000 Mile limited warranty on aluminum or steel frame structure of sidewall, roof, front and rear cap; 3 Year/50,000 Mile limited warranty on Roadmaster chassis. *Applies to certain models. See owner's manual for complete details.*



**Ralph Lauren.**

The distinctive look of the Patriot Thunder is hard to match. But there is one name that conveys the same elegance and sophistication — Ralph Lauren. Beaver Patriot Thunder is proud to offer interiors designed by Ralph Lauren. Five selections in all, each one sophisticated and elegant, yet distinctive from one another. Whichever package you choose, it's guaranteed to coordinate beautifully and enhance the rich wood tone and overall elegance of the Patriot Thunder.

FABRICS | EXTERIOR | COLORS

- 1. DINETTE
- 2. BEDSPREAD
- 3. SOFA
- 4. CARPET



AFRICAN TWILIGHT II



RALPH LAUREN BLACK PEARL



NASSAU GOLD II



RALPH LAUREN WINDERMERE





RALPH LAUREN LANDSDOWN II

**RALPH LAUREN PACKAGE:**

Here's a feast for your senses. Our exclusive Ralph Lauren package offers upgraded features throughout the coach. Because we want your life on the road to be beautiful.

- › Upgraded Ralph Lauren Fabrics, Both Living Room and Bedroom
- › Upgraded Villa Furniture Featuring 2-Tone Ralph Lauren Fabric/Leather and Villa Dinette Chairs
- › Upgraded Galley and Lavatory Faucets
- › Upgraded Tumbled Stone Galley/Bath Backsplashes
- › Polished Porcelain 14" x 14" Floor Tile
- › Upgraded Carpet
- › Additional Decorative Pillows in Ralph Lauren Fabrics
- › Decorative Lighting
- › Detailed Decorative Carved Headboard
- › Upgraded Carved Slide-Out Fascia
- › Upgraded Wallpaper and Ceiling Treatments
- › Raised Panel Cabinetry and Panels Throughout
- › Black Microwave

**Choose with confidence.**

Selected from the finest woods, then handcrafted by skilled artisans, Patriot Thunder's stunning wood cabinets are created by a long and arduous process. But the results are well worth it. For 2008, we offer both natural cherry and maple, with a colorful combination of inlays available. So choose with confidence, knowing that all of the selections are made with the same dedication and pride.

NATURAL CHERRY



CHERRY WITH MAPLE BURL INLAY

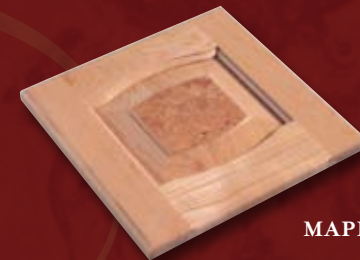

CHERRY WITH MAPPA BURL INLAY

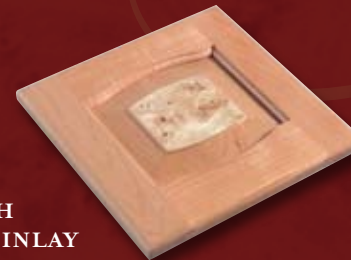

CHERRY WITH MAKORI INLAY

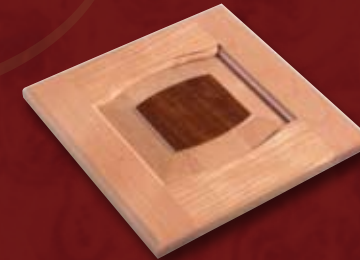

NATURAL MAPLE



MAPLE WITH MAPLE BURL INLAY

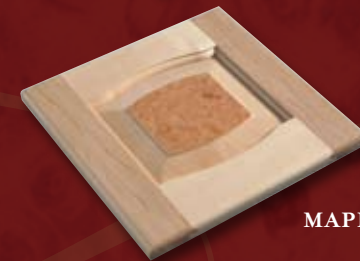

MAPLE WITH MAPPA BURL INLAY



MAPLE WITH BIRD'S EYE MAPLE





### CONCORD IV

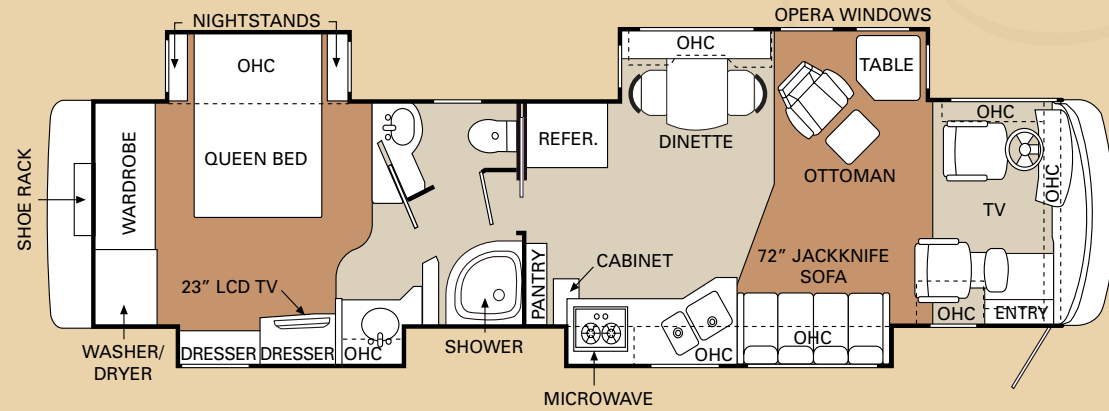

### BRANDYWINE IV

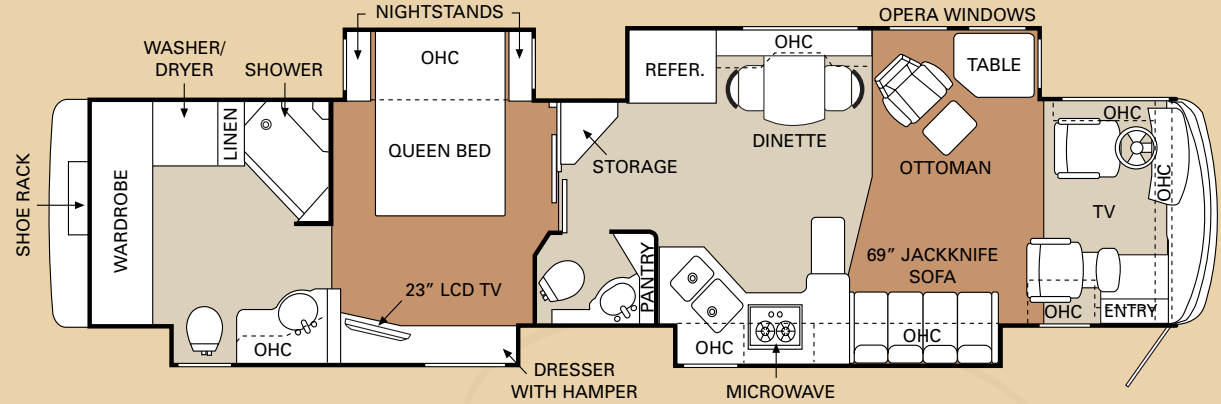

### PRINCETON IV

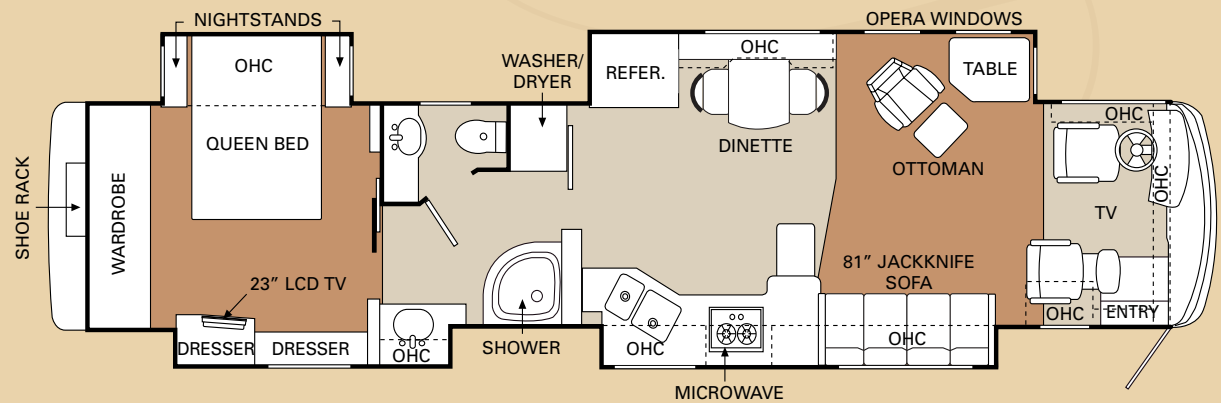

### The power of choice.

The 2008 Patriot® Thunder has a total of five new floorplans, and every one of them is filled with comfort and convenience. We're especially excited about the Brandywine IV, featuring a half bath off the kitchen. Take a moment to look over all of the floorplans as you imagine yourself enjoying every inch of luxurious space. Then choose the one that best fits your vision of how life on the road should be.



## FLOORPLAN OPTIONS

### HANOVER IV

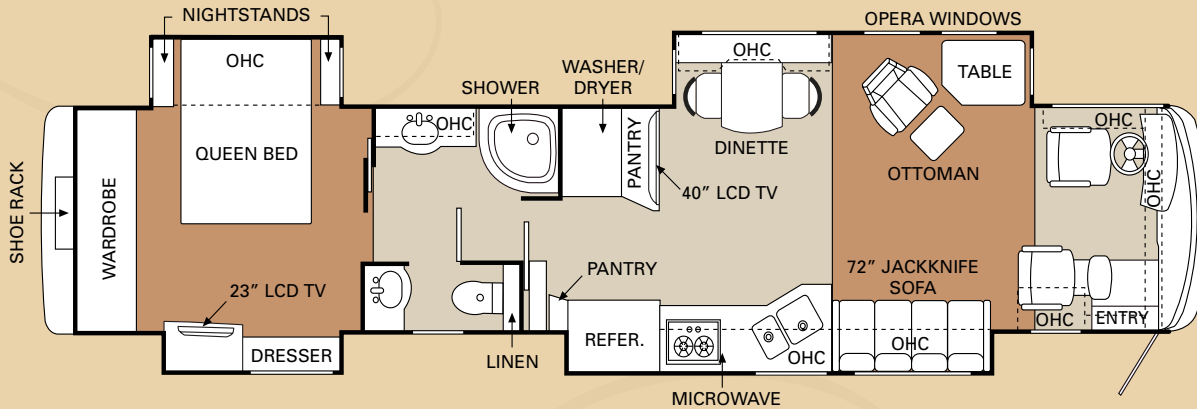

### WINCHESTER III

FULL-WALL SLIDE  
PANASONIC

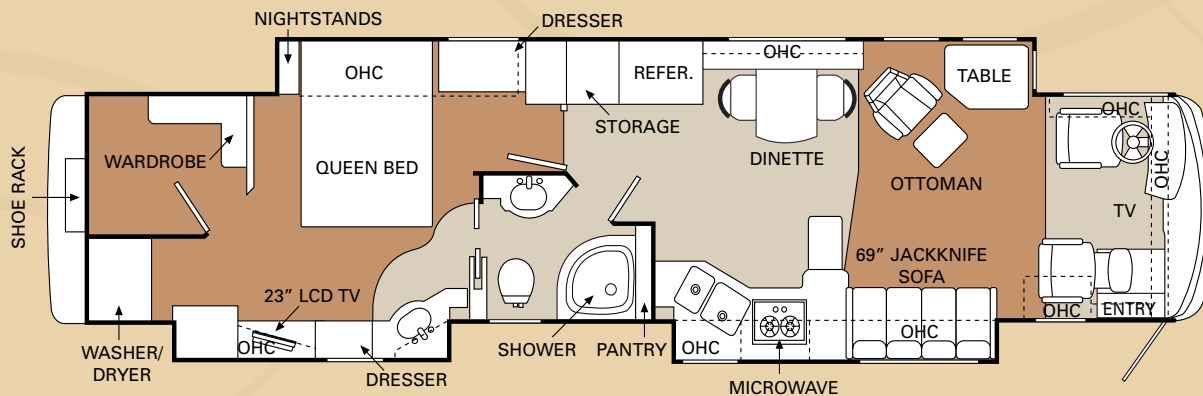

CARPET  TILE

- King Bed with Pillowtop-Hinged Mattress (72" x 80")
- King Air Mattress with Digital Remote (72" x 80")
- Roadside: Leather Recliner
- Roadside: Leather Sofa with Drawer
- Curbside: Leather Sofa with Drawer
- Curbside: Leather Hide-A-Bed with Air Mattress (N/A: Winchester III)
- Curbside: Fabric Hide-A-Bed with Air Mattress (N/A: Winchester III)
- Computer Table (with Standard Leather Euro-Recliner and Ottoman)
- Bedroom Workstation and Window ILO Walk-In Closet (Winchester III Only)
- Fabric/Leather Sectional Booth Dinette Ensemble
- Two Folding Chairs with Sectional Booth Dinette Ensemble
- Bathtub

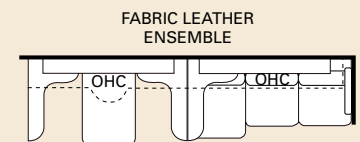
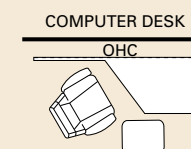



Due to continuous product improvement, please see the website for the latest in standards and options, specifications, and technical data. Go to [www.beavermotorcoaches.com](http://www.beavermotorcoaches.com).

WEIGHTS	Concord IV	Brandywine IV	Winchester III	Princeton IV	Hanover IV
Gross Vehicle Weight Rating (Lbs.)	50,160	50,160	50,160	50,160	50,160
Gross Combined Weight Rating <sup>1</sup> (Lbs.)	60,160	60,160	60,160	60,160	60,160
Front Gross Axle Weight Rating (Lbs.)	15,160	15,160	15,160	15,160	15,160
Rear Gross Axle Weight Rating (Lbs.)	23,000	23,000	23,000	23,000	23,000
Tag Gross Axle Weight Rating (Lbs.)	12,000	12,000	12,000	12,000	12,000
MEASUREMENTS	Concord IV	Brandywine IV	Winchester III	Princeton IV	Hanover IV
Wheelbase	242.75	284	284	284	284
Overall Length	41' 7"	43' 1"	44' 11"	44' 11"	44' 11"
Exterior Width	100.5	100.5	100.5	100.5	100.5
Exterior Height	12' 6"	12' 6"	12' 6"	12' 6"	12' 6"
Interior Height	84	84	84	84	84
TANK CAPACITIES <sup>2</sup>	Concord IV	Brandywine IV	Winchester III	Princeton IV	Hanover IV
Gray Tank (Gal.)	70	70	70	70	70
Black Tank (Gal.)	40	40	40	40	40
Fresh Tank (Gal.)	100	100	100	100	100
LP Tank <sup>3</sup> (Gal.)	25	25	25	25	25
Fuel Tank (Gal.)	150	150	150	150	150

<sup>1</sup> Towing capacity is limited by GCWR; your vehicle's towing capacity is the difference between the GCWR and the actual vehicle weight, including all water, fuel, passengers and cargo. Your towed vehicle should be equipped with auxiliary brakes if the weight of the towed vehicle exceeds 1,000 lbs. Consult your owner's manual for further towing information.

<sup>2</sup> All tank capacities are estimated based upon calculations provided by the tank manufacturers and represent approximate capacities. The actual "usable capacity" may be greater or less than the estimated capacities based upon fabrication and installation of the tanks.

<sup>3</sup> Actual filled LP capacity is 80% of listing due to safety shut-off required on tank.

The actual overall length of the recreational vehicle may differ from that indicated in the brochure due to variances in the manufacturing process and/or installed components. The actual length may be greater or less than that indicated. Due to the large variety of options and floorplan arrangements available to our customers, actual weights for each

unit can differ significantly. Beaver Motor Coaches provides a weight sticker on each unit we produce which includes that unit's tank capacities and approximate weight. Consult your local Beaver Motor Coaches dealer for unit availability and further information.

The information printed in this brochure reflects product design, fabrication, and component parts at the date of printing. The manufacturer reserves the right, at any time, to make changes in product design or material or component specifications as its sole option, without notice. This includes the substitution of components of a different brand or trade name which will result in comparable performance.

All information printed in this brochure is subject to change after the date of printing. Some features shown or mentioned in this brochure are optional and may only be available in selected floorplans. Photographs may show props or decorations that are not standard equipment on Beaver Motor Coach models. Beaver Motor Coaches, the Beaver logo and its design, are registered trademarks. All other products and company names are trademarks and/or registered

trademarks of their respective holders. While the color of the motorhome's exterior and the interior fabrics depicted in this sales brochure are fair and reasonable depictions, the colors depicted may not be an exact match of the actual colors because of the variances in photo-processing and variances caused by inserting the photographs within the sales brochure.

**Due to product improvements, changes during the model year and/or transcription errors that may occur, information represented within this brochure may not be accurate at the time of your purchase. If certain information is significant to your purchasing decision, please confirm the information with your dealer prior to submitting your order. Component part and appliance manufacturers issue limited warranties covering those portions of the recreational vehicle not covered by the Limited Warranties issued by Monaco Coach Corporation. To learn which specific component parts and appliances are excluded from the Limited Warranties issued by Monaco Coach Corporation, please contact your selling dealership or Monaco Coach Corporation directly, or review the warranty packet inside the recreational vehicle.**



## BODY CONSTRUCTION

### FEATURES

- › Heavy-Duty Steel Superstructure with Steel Cage Cockpit Construction
- › Seamless One-Piece Molded Crowned Fiberglass Roof
- › All-Season Foam Insulated Roof
- › Laminated Gel Coat Fiberglass Sidewalls
- › Five-Layer Flooring with Two Layers of OSB Flooring

- › Deluxe Full-Body Paint with Thunder Logos on Front and Rear Caps
- › Panaview™ 1-Piece Front Windshield
- › Triple Head Power Controlled Heated Chrome Exterior Mirrors
- › Daytime Running Lights
- › Halogen Driving Lights
- › Recessed Side Docking Lights (with Bedroom Switch)

- › Dual Trumpet Air Horns
- › Insulated Aluminum Baggage Doors with Power Locks
- › Lined Storage Compartments
- › Interlocking Aluminum Framed Slide-Out Houses
- › Rear Ladder
- › Full-Length "Beaver" Mud Flap
- › Chrome Rocker Trim

### OPTIONS

- › 3M Film Front Mask
- › One Manual Storage Bay Slide-Out Storage Tray (One Side)
- › One Manual Storage Bay Slide-Out Tray (Full Pass-Through)
- › Electric Slide-Out Storage Tray (Full Pass-Through)

## CHASSIS/ENGINE/SUSPENSION

### FEATURES

- › Roadmaster S-Series: Semi-Monocoque Chassis
- › CAT® 525 HP C-13 and Allison® 4000 MH 6-Speed World Transmission with Electronic Shifter
- › Torque: (@ 1,200 RPM) 1,750 lbs./ft. Max. Net
- › Engine Displacement: 763 Cu. In. /12.5L
- › Dual Fuel Fill
- › 200 Amp Alternator
- › Rear Axle Ratio: 4.33:1

- › Tires: 295/80R/22.5
- › Polished Aluminum Wheels
- › Full-Cushion Air Glide Suspension with Ten Air Bags, Eight of which are Outboard Mounted, and Ten Bilstein® Shock Absorbers
- › Air Suspension with Ping Tank
- › Automatic Traction Control
- › Air Disc Brake System with ABS (Front and Rear)
- › Tag Axle with Anti-Lock Braking System (Drum)

- › CAT® Compression Two-Stage Engine Brake (with Hi/Lo Switch)
- › Engine Block Heater with Switch on Dash (120V/1000 W)
- › Prewire for Supplemental Braking System
- › Hydraulic Leveling System (3 Point; Power Gear)
- › 10,000 Lb. Hitch Receiver & 7/4-Way Trailer Plug
- › Remote Inflation Connector

### OPTIONS

- › Dual Leveling System (Air/Hydraulic)
- › Air Leveling (Replaces Hydraulic Leveling)
- › ACD – Electronic Adjustable Suspension System

## COCKPIT

### FEATURES

- › In-Dash AM/FM Stereo with Multi-Disc CD Changer
- › Auxiliary Audio Input in Cockpit Area
- › Rear Vision System with Color Monitor
- › SEE-Vision Security Cameras
- › Compass and Temperature Gauge
- › CB Radio Prep (Cable and Antenna)
- › Manual Privacy Drapes

- › Power Sunvisors with Driver and Passenger Switch
- › Pilot and Co-Pilot Side Window Manual Sunscreens
- › Adjustable Accelerator and Brake Pedals
- › Two-Tone Leather VIP Lighted Smartwheel® with Controls for Windshield Wipers, ICC and Cruise Control

- › 6-Way Power Ultraleather™ Pilot and Co-Pilot Seats with Adjustable Head- and Armrests, Electric Lumbar and Heat, Colored Pleats and Thunder Logo, and Memory Capabilities on Pilot Seat

### OPTIONS

- › Electronic Privacy Drape
- › Interior Cockpit Sunscreens
- › Electric Cockpit Solar Screens with Blackout Shades
- › CB Radio (40 Channel Handheld Cobra)
- › GPS Navigation System with Touchscreen
- › XM Satellite Stereo (Requires Subscription)
- › Sirius Satellite Stereo (Requires Subscription)

## APPLIANCES AND ACCESSORIES

### FEATURES

- › 17 Cu. Ft. Four-Door Refrigerator with Raised Panel Doors
- › Recessed High-Output 2-Burner Cooktop with Flush-Mounted Covers
- › Spacesaver Convection Microwave with Touch Control (Stainless with Standard Decor Choices ILO Black; Black with Ralph Lauren)
- › Electric TV Antenna
- › Prep for Satellite Receiver
- › 32" LCD TV with Remote in Living Area (N/A: Hanover IV)
- › 40" LCD TV Mounted in Entertainment Center behind Dinette Area (Hanover IV Only)
- › 23" LCD TV with Remote Control in Bedroom
- › Home Theater System in Living Area
- › Bedroom DVD Player
- › Universal Remote System for Living Area TV
- › Combination Washer and Dryer Prep

### OPTIONS

- › Combination Washer and Dryer
- › Stack Washer and Dryer
- › Central Vacuum System with Toe Kick Vacuum in Pantry Base
- › Residential Refrigerator with Raised Panel Doors and 2 Additional Batteries
- › Stainless Steel Refrigerator Panels
- › 40" LCD TV in Living Area Ceiling (40 LCD Standard in Hanover IV Dinette Area)
- › 26" LCD TV in Living Area Overhead (Hanover IV Only)
- › 26" LCD TV with Remote Control in Bedroom
- › 32" LCD TV with Remote Control in Bedroom
- › KVH R5 In-Motion Digital Satellite System
- › KVH R6 In-Motion Digital Satellite System
- › Exterior 32" Sharp LCD TV

## INTERIOR

### FEATURES

- › Gloss Finish Cabinetry
- › Dinette Wall Cabinet with Solid Surface Top
- › Low-Friction Roller Drawer Guides
- › Vinyl Ceiling with Wood Design
- › High-Gloss Corian® Solid Surface Countertops Throughout
- › Integrated Sinks in Vanity and Galley
- › Solid Surface and Ceramic Tile Galley Backsplash with Metal Tile Accents
- › Tile and Corian® Vanity Backsplash
- › Sculpted Glass Splash Guard at Edge of Galley
- › Day/Night Shades with Blackouts Throughout
- › Textured Carpet in Living Area and Throughout
- › Ceramic Tile in Kitchen and Bath Area (with Metal Tile Accents)
- › Ceramic Tile Flooring in Cockpit Area
- › Bedspread with Pillows
- › Nightstands with Corian® Countertops
- › Decorative Hardware Throughout
- › Large Pot and Pan Drawer in Kitchen Area

### OPTIONS

- › Interior Decors: African Twilight II and Nassau Gold II
- › Ralph Lauren Decors: Landsdown II, Black Pearl and Windermere
- › Gloss Finish Cabinetry Choices: Cherry and Maple
- › Maple Burl Accent Cabinet Door Inserts with Cherry and Maple Cabinetry
- › Mappa Burl Accent Cabinet Door Inserts with Cherry and Maple Cabinetry
- › Makori Accent Cabinet Door Inserts with Cherry Cabinetry
- › Bird's Eye Maple Accent Cabinet Door Inserts with Maple Cabinetry
- › Manual Roman Shades (N/A with Slide-Out Endwall Windows)
- › Solar Screens with Blackout Shades Throughout (Power in Living Area)
- › Ceiling Fan in Bedroom
- › Sculptured Carpet in Living Area
- › Full-Tile Living Room Floor

## FURNITURE

### FEATURES

- › Queen Bed with Pillowtop-Hinged Mattress
- › Curbside: Sleeper Sofa with Drawer and Footrest
- › Roadside: Leather Euro-Recliner with Ottoman
- › Solid Surface Fixed Living Area Table
- › Side-Slide, Solid Surface Fixed Dinette Table with Two Freestanding Dinette Chairs and Two Folding Chairs

### OPTIONS

- › King Bed with Pillowtop-Hinged Mattress (72" x 80")
- › King Air Mattress with Digital Remote (72" x 80")
- › Roadside: Leather Recliner
- › Roadside: Leather Sofa with Drawer
- › Curbside: Leather Sofa with Drawer
- › Curbside: Leather Hide-A-Bed with Air Mattress (N/A: Winchester III)
- › Curbside: Fabric Hide-A-Bed with Air Mattress (N/A: Winchester III)
- › Computer Table with Standard Leather Euro-Recliner and Ottoman
- › Bedroom Workstation and Window ILO Walk-In Closet (Winchester III Only)
- › Fabric/Leather Sectional Booth Dinette Ensemble
- › Two Folding Chairs with Sectional Booth Dinette Ensemble

## ELECTRICAL SYSTEMS AND LIGHTS

### FEATURES

- › 50 Amp 120/240V Distribution Panel and Power Cord
- › Power Cord Reel
- › Onan® 10.0kW QD Generator on Power Slide-Out Tray with Auxiliary Start Switch and Automatic Temperature Start
- › 2800 Watt Pure Sine Wave Inverter with Auto Gen Start and Auto Temp Start
- › Pilot/Co-Pilot Reading Lights
- › Adjustable Bedroom Overhead Lights with Switches above Bed (His and Her Switches by Nightstands)
- › Fluorescent Light in Bath Area
- › 120V Outlet in Private Bath
- › 120V Outlet in Bed Base

- › 120V Receptacle in Outside Storage Compartment
- › Lighted Exterior Storage Compartments
- › Four 6V Coach Batteries
- › Two 12V Chassis Batteries
- › Multiplex 12V Wiring Throughout Interior of Coach

### OPTIONS

- › Glass Matt Batteries (Replaces House and Chassis Batteries)
- › Solar Panel with Regulator (100 Watt)



## PLUMBING AND LP SYSTEMS

FEATURES

- › Central Water Filtration System in Service Bay
- › Manifold Water Control System
- › Insulated Systems Compartment with Easy Access to Hook-Ups
- › Water Pump Switches in Galley, Bath and Water Bay
- › China Toilet (Sealand Opus®)
- › Super Service Center
- › Solid Surface Shower with Corian® Shower Caddy
- › Black and Gray Tank Flush
- › Outside Faucet with Hot and Cold Water
- › Power Water Hose Reel
- › One Touch Pullout Faucet
- › Soap Dispenser in Kitchen

OPTIONS

- › RV Sani-Con Tank Drainage System
- › Electronic Automatic Winterization
- › Bathtub

## HEATING, VENTS AND AIR CONDITIONING

FEATURES

- › Aqua-Hot® Heating System (with Engine Preheat)
- › Two Low-Profile Ducted 15M BTU Roof Air Conditioners with Heat Pumps (Concord IV)
- › Three Low-Profile Ducted 15M BTU Roof Air Conditioners with Heat Pumps (N/A: Concord IV)
- › Electronic AC/Heat Climate Control System
- › Dash Heating and Air Conditioner System with Defroster
- › 12V Attic Fan with Sensor and Wall Switch in Kitchen, Bath and Vanity Area

OPTIONS

- › Galley Low-Profile Baseboard Heater

## WINDOWS, DOORS AND AWNINGS

FEATURES

- › Flush-Mounted Radius Dual Pane Safety Glass Dark Tinted Windows
- › Opera Windows with Standard Roadside Furniture
- › Horizontal Windows with Optional Sofa on Roadside
- › Front Entry Door with Air Seal and Removable Top Screen
- › Keyless Remote Entry System with Pocket Remote
- › Topper Slide-Out Awnings
- › Carefree® Manual Window Awnings
- › Roof-Mounted Girard® Automatic Front Patio Awning

OPTIONS

- › Girard® Awning Package (Includes: Rear Patio Awning, Automatic Front Door Awning, Slide-Out Topper Awnings and Window Awnings) (Except Private Bath Window)
- › Girard® Automatic Front Door Awning

## SAFETY

FEATURES

- › Backup Alarm
- › Fire Extinguisher
- › Deadbolt Lock on Entrance Door
- › Lighted Interior and Exterior Grab Handles
- › 120V GFI Protected Circuit (Kitchen, Bath and Exterior)
- › LP Gas Detector
- › Smoke Detector
- › Carbon Monoxide Detector
- › Integrated Pilot and Co-Pilot Three-Point Seatbelts (Lap and Shoulder)
- › Third Brake Safety Light
- › Egress Window(s)

OPTIONS

- › Security Safe
- › Deluxe Security Alarm System
- › Collision Avoidance System

## The inside track.

Beaver dealer links, service center finders, owner news and the latest information on the 2008 Patriot® Thunder can be found on our website. It's a direct link to everything Beaver that can be accessed anytime, day or night, from home or on the road.

[www.beavermotorcoaches.com](http://www.beavermotorcoaches.com)



# BEAVER PATRIOT® THUNDER | 2008



## Different by design.

It's no accident that Beaver motorhomes stand apart from the others. We were never going for mass appeal. At Beaver, our goal has always been to cater to those individuals who want something more. Something special. So we create luxury motorhomes that are exclusive and unique.

Some differences are obvious, like our famous handcrafted wood cabinetry. Others aren't as apparent, such as our exclusive Roadmaster chassis and seamlessly integrated engineering. But when you drive a Beaver, it all comes together to create a one-of-a-kind experience you won't soon forget. The 2008 Patriot® Thunder from Beaver. Different by design.



MONACO COACH CORPORATION

Monaco is traded on the New York Stock Exchange under the listing MNC.

© 2007, Monaco Coach Corporation Litho in USA

0807 NPN:BRBPAT

## BEING DIFFERENT MAKES ALL THE DIFFERENCE.

*"No other manufacturer can match Monaco's offerings. No one even comes close."*

*Kay*  
KAY TOOLSON, CEO



At Monaco, we always strive to be the best. And that means thinking outside the box. Giving you more of what you want in an RV. Like our exclusive Roadmaster chassis. Three factory-owned service centers. And programs like Monaco Financial Services and 24/7 roadside assistance. No other manufacturer can match Monaco's offerings. No one even comes close. Why not discover the difference for yourself? Go Monaco.

877-252-4666 | [www.monacodifferent.com](http://www.monacodifferent.com)

THE BEAVER LINE OF MOTOR COACHES:

MARQUIS® • PATRIOT® THUNDER • CONTESSA



Different by Design.

### BEAVER MOTOR COACH

91320 Coburg Industrial Way, Coburg, OR 97408

[www.beavermotorcoaches.com](http://www.beavermotorcoaches.com)

Daily factory tours.

(800) 634-0855