

Panasonic[®]

Operating Instructions

Digital Corded/Cordless Phone with Link-to-Mobile

Model No. **KX-TGF380AZ**
KX-TGF382AZ



Model shown is KX-TGF380.

Before initial use, see “Getting Started” on page 9.

Thank you for purchasing a Panasonic product.

Please read these operating instructions before using the unit and save them for future reference.

To use this unit in your country, first change the unit’s region setting to match your country (page 47).

Table of Contents

Introduction	
Model composition	3
Accessory information	3
Important Information	
For your safety	6
General notices	7
Important safety instructions	7
For best performance	7
Other information	8
Specifications	8
Getting Started	
Setting up	9
Controls	12
Display icons/Indicators	13
Date and time	14
Recording your greeting message	15
Link to Mobile	
Link to mobile feature	16
Pairing a mobile phone	16
Link to mobile settings	17
Making/Answering Calls Using the Handset	
Making mobile calls	20
Making landline calls	20
Answering calls	21
Useful features during a call	21
Making/Answering Calls Using the Base Unit	
Making mobile calls	24
Making landline calls	24
Answering calls	25
Useful features during a call	25
Intercom	
Intercom	27
Call Block	
Using the [CALL BLOCK] button	28
Storing unwanted callers	28
Phonebook	
Phonebook	31
Speed dial	34
One-touch dial buttons	35
Programming	
Menu list	37
Alarm	44
Do not disturb mode	44
Baby monitor	45
Other programming	47
Registering a unit	47
Caller ID Service	
Using Caller ID service	49
Caller list	50
Using Bluetooth® Devices	
Copying phonebook from a mobile phone (phonebook transfer)	53
Link to Mobile app	54
Text message (SMS) alert	55
Alert settings for your DECT phone	55
Using a Bluetooth wireless headset (optional) for landline calls	55
Answering System for Landline	
Answering system for landline	58
Turning the answering system on/off	58
Greeting message	58
Listening to messages	59
Advanced new message alerting features	60
Remote operation	62
Answering system settings	63
Useful Information	
Voicemail service for landline	65
Wall mounting	66
Error messages	68
Troubleshooting	69
Warranty (for New Zealand)	76
Index	
Index.....	77

Model composition

Series	Model No.	Base unit	Handset	Quantity
		Part No.	Part No.	
KX-TGF380 series	KX-TGF380	KX-TGF380	KX-TGFA30	1
	KX-TGF382	KX-TGF380	KX-TGFA30	2

Accessory information

Supplied accessories

No.	Accessory item/Part number	Quantity	
		KX-TGF380	KX-TGF382
①	AC adaptor/PNLV226AL	1	1
②	Telephone line cord (for Australia)*1	1	1
③	Telephone line cord (for New Zealand)	1	1
④	Desk stand/Wall mounting adaptor*2	1	1
⑤	Corded handset	1	1
⑥	Corded handset cord	1	1
⑦	Rechargeable batteries*3	2	4
⑧	Handset cover*4	1	2
⑨	Belt clip	1	2
⑩	Charger	1	2

*1 The telephone line cord comes connected with the telephone plug.

*2 The desk stand/wall mounting adaptor comes attached to the base unit.

*3 See page 4 for replacement battery information.

*4 The handset cover comes attached to the handset.

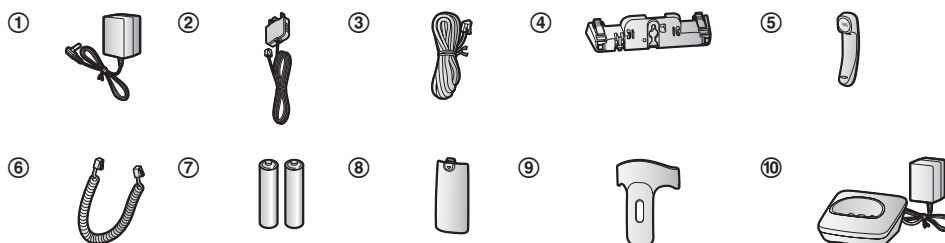

Introduction

Additional/replacement accessories

Please contact your nearest Panasonic dealer for sales information.

Accessory item	Model number/Specifications
Rechargeable batteries*1	Battery type: <ul style="list-style-type: none">– Nickel metal hydride (Ni-MH)– 2 x AAA (R03) size for each handset– 1.2 V– Minimum amperage of 550 mAh
DECT repeater	KX-TGA405, KX-TGA406
Key finder	KX-TGA20AZ*2

*1 Replacement batteries may have a different capacity from that of the supplied batteries. We recommend using Panasonic rechargeable batteries.

*2 By registering the key finder (4 max.) to a Panasonic Digital Cordless Phone and attaching it to an easy-to-lose item in advance, you can locate and find the mislaid item to which the key finder is attached. Please visit our Web site: www.panasonic.net/pcc/products/telephone/p/tga20/
Please contact Panasonic or authorised sales department for availability of key finder in your area.

Headset (optional)

Connecting a headset to the handset allows for hands-free conversations.

Note:

- Only telecommunications compliance labelled headset should be plugged into the headset socket on the handset.

Other information

- Design and specifications are subject to change without notice.
- The illustrations in these instructions may vary slightly from the actual product.

Expanding your phone system

Handset (optional): KX-TGFA30AZ	
You can expand your phone system by registering optional handsets (6 max.) to a single base unit. <ul style="list-style-type: none">• Optional handsets may be a different colour from that of the supplied handsets.	

Bluetooth® devices

You can expand your phone system by pairing the following units to a single base unit.

Your Bluetooth mobile phone*1: 2 max. (for mobile calls: page 16)	
---	---

Introduction

Your Bluetooth headset*1: 1 max.
(for a wireless hands-free conversation: page 55)



*1 Your mobile phone and headset must be Bluetooth wireless technology compatible.

Trademarks

- The Bluetooth® word mark and logos are registered trademarks owned by Bluetooth SIG, Inc., and any use of such marks by Panasonic Corporation is under licence.
- iPhone is a trademark of Apple Inc., registered in the U.S. and other countries.
- Android is a trademark of Google Inc.
- Gmail, Google Calendar are trademarks of Google Inc.
- Facebook is trademark of Facebook, Inc.
- Twitter is trademark of Twitter Inc.
- Instagram is trademark of Instagram, Inc.
- BlackBerry is owned by Research In Motion Limited and is registered in the United States and may be pending or registered in other countries. Panasonic is not endorsed, sponsored, affiliated with or otherwise authorised by Research In Motion Limited.
- All other trademarks identified herein are the property of their respective owners.

Important Information

For your safety

To prevent severe injury and loss of life/property, read this section carefully before using the product to ensure proper and safe operation of your product.

WARNING

Power connection

- Use only the power source marked on the product.
- Do not overload power outlets and extension cords. This can result in the risk of fire or electric shock.
- Completely insert the AC adaptor/power plug into the power outlet. Failure to do so may cause electric shock and/or excessive heat resulting in a fire.
- Regularly remove any dust, etc. from the AC adaptor/power plug by pulling it from the power outlet, then wiping with a dry cloth. Accumulated dust may cause an insulation defect from moisture, etc. resulting in a fire.
- Unplug the product from power outlets if it emits smoke, an abnormal smell, or makes an unusual noise. These conditions can cause fire or electric shock. Confirm that smoke has stopped emitting and contact an authorised service centre.
- Unplug from power outlets and never touch the inside of the product if its casing has been broken open.
- Never touch the plug with wet hands. Danger of electric shock exists.

Installation

- To prevent the risk of fire or electrical shock, do not expose the product to rain or any type of moisture.
- Do not place or use this product near automatically controlled devices such as automatic doors and fire alarms. Radio waves emitted from this product may cause such devices to malfunction resulting in an accident.
- Do not allow the AC adaptor or telephone line cord to be excessively pulled, bent or placed under heavy objects.
- It is advised not to use the equipment at a refuelling point. Users are reminded to observe restrictions on the use of radio equipment in fuel depots, chemical plants or where blasting operations are in progress.

Operating safeguards

- Unplug the product from power outlets before cleaning. Do not use liquid or aerosol cleaners.
- Do not disassemble the product.
- Do not spill liquids (detergents, cleansers, etc.) onto the telephone line cord plug, or allow it to become wet at all. This may cause a fire. If the telephone line cord plug becomes wet, immediately pull it from the telephone wall socket, and do not use.
- Do not excessively pull the corded handset cord from the base unit. This may cause the base unit to fall, resulting in injury.

Medical

- Consult the manufacturer of any personal medical devices, such as pacemakers or hearing aids, to determine if they are adequately shielded from external RF (radio frequency) energy. (The product operates in the frequency range of 1.88 GHz to 1.90 GHz, and the RF transmission power is 250 mW (max..))
- Do not use the product in health care facilities if any regulations posted in the area instruct you not to do so. Hospitals or health care facilities may be using equipment that could be sensitive to external RF energy.

CAUTION

Installation and location

- Never install telephone wiring during an electrical storm.
- Never install telephone line sockets in wet locations unless the socket is specifically designed for wet locations.
- Never touch uninsulated telephone wires or terminals unless the telephone line has been disconnected at the network interface.
- Use caution when installing or modifying telephone lines.
- The AC adaptor is used as the main disconnect device. Ensure that the AC outlet is installed near the product and is easily accessible.
- This cordless handset is unable to make calls when:
 - the handset batteries need recharging or have failed.
 - there is a power failure.

Ni-MH rechargeable batteries

- We recommend using the batteries noted on page 4. **USE ONLY rechargeable Ni-MH batteries AAA (R03) size.**
- Do not mix old and new batteries.
- Do not open or mutilate the batteries. Released electrolyte from the batteries is corrosive and may cause burns or injury to the eyes or skin. The electrolyte is toxic and may be harmful if swallowed.
- Exercise care when handling the batteries. Do not allow conductive materials such as rings, bracelets, or keys to touch the batteries, otherwise a short circuit may cause the batteries and/or the conductive material to overheat and cause burns.
- Charge the batteries provided with or identified for use with this product only, in accordance with the instructions and limitations specified in this manual.
- Only use a compatible base unit (or charger) to charge the batteries. Do not tamper with the base unit (or charger). Failure to follow these instructions may cause the batteries to swell or explode.

Note when using alkaline batteries for power backup

- The batteries should be used correctly, otherwise the unit may be damaged due to battery leakage.
- Do not charge, short-circuit, disassemble, or heat the batteries.
- Do not dispose of batteries in a fire.
- Remove all the batteries when replacing.
- Do not mix old, new or different types of batteries.

Important Information

- It is recommended that batteries are replaced annually.
- It is recommended that batteries are replaced after a power outage.

General notices

- This equipment will be inoperable when mains power fails.
- When a failure occurs which results in the internal parts becoming accessible, disconnect the power supply cord immediately and return this unit to an authorised service centre.
- To minimise the possibility of lightning damage, when you know that a thunderstorm is coming, we recommend that you:
 - Unplug the telephone line cord from the phone socket.
 - Unplug the AC adaptor from the AC power outlet.
- No "000" (for Australia), "111" (for New Zealand), and/or other calls can be made from this device during a mains power failure.
- The earpiece on the handset is magnetised and may retain small metallic objects.

Important notice:

- Under power failure conditions, this telephone may not operate. Please ensure that a separate telephone, not dependent on local power, is available for emergency use.

For New Zealand

- Disconnect the telecom connection before disconnecting the power connection prior to relocating the equipment, and reconnect the power first.
- This equipment shall not be set to make automatic calls to the Telecom "111" Emergency Service.
- The unit's answering system only responds to Distinctive Alert cadence(s) DA1 and DA3.
- Not all telephones will respond to incoming ringing when connected to the extension socket.
- This equipment may not provide for the effective hand-over of a call to another device connected to the same line.
- The grant of a Telepermit for any item of terminal equipment indicates only that Telecom has accepted that the item complies with minimum conditions for connection to its network. It indicates no endorsement of the product by Telecom, nor does it provide any sort of warranty. Above all, it provides no assurance that any item will work correctly in all respects with another item of Telepermitted equipment of a different make or model, nor does it imply that any product is compatible with all of Telecom's network services.

Important safety instructions

When using your product, basic safety precautions should always be followed to reduce the risk of fire, electric shock, and injury to persons, including the following:

1. Do not use this product near water for example, near a bathtub, washbowl, kitchen sink, or laundry tub, in a wet basement or near a swimming pool.

2. Avoid using a telephone (including a cordless type) during an electrical storm. There may be a remote risk of electric shock from lightning.
3. Do not use the telephone to report a gas leak in the vicinity of the leak.
4. Use only the power cord and batteries indicated in this manual. Do not dispose of batteries in a fire. They may explode. Check with local codes for possible special disposal instructions.

SAVE THESE INSTRUCTIONS

For best performance

Base unit location/avoiding noise

The base unit and other compatible Panasonic units use radio waves to communicate with each other.

- For maximum coverage and noise-free communications, place your base unit:
 - at a convenient, high, and central location with no obstructions between the cordless handset and base unit in an indoor environment.
 - away from electronic appliances such as TVs, radios, personal computers, wireless devices, or other phones.
 - facing away from radio frequency transmitters, such as external antennas of mobile phone cell stations. (Avoid putting the base unit on a bay window or near a window.)
- Coverage and voice quality depends on the local environmental conditions.
- If the reception for a base unit location is not satisfactory, move the base unit to another location for better reception.

Environment

- Keep the product away from electrical noise generating devices, such as fluorescent lamps and motors.
- The product should be kept free from excessive smoke, dust, high temperature, and vibration.
- The product should not be exposed to direct sunlight.
- Do not place heavy objects on top of the product.
- When you leave the product unused for a long period of time, unplug the product from the power outlet.
- The product should be kept away from heat sources such as heaters, kitchen stoves, etc. It should not be placed in rooms where the temperature is less than 0 °C or greater than 40 °C. Damp basements should also be avoided.
- The maximum calling distance may be shortened when the product is used in the following places: Near obstacles such as hills, tunnels, underground, near metal objects such as wire fences, etc.
- Operating the product near electrical appliances may cause interference. Move away from the electrical appliances.

Routine care

- **Wipe the outer surface of the product with a soft moist cloth.**
- Do not use benzene, thinner, or any abrasive powder.

Important Information

Other information

CAUTION: Risk of explosion if battery is replaced by an incorrect type. Dispose of used batteries according to the instructions.

Notice for product disposal, transfer, or return

- This product can store your private/confidential information. To protect your privacy/confidentiality, we recommend that you erase information such as phonebook or caller list entries from the memory before you dispose of, transfer, or return the product.

Information on Disposal in other Countries outside the European Union



These symbols are only valid in the European Union. If you wish to discard these items, please contact your local authorities or dealer and ask for the correct method of disposal.

Note for the battery removal procedure

Refer to "Handset battery installation" on page 9 and "Base unit battery installation (for power backup)" on page 10.

Specifications

- **Standard:**
DECT 6.0 (Digital Enhanced Cordless Telecommunications 6.0)
Bluetooth wireless technology 2.1
- **Frequency range:**
1.88 GHz to 1.90 GHz (DECT)
2.402 GHz to 2.48 GHz (Bluetooth)
- **RF transmission power:**
Approx. 10 mW (average power per channel)
- **Power source:**
220–240 V AC, 50/60 Hz
- **Power consumption:**
Base unit:
Standby: Approx. 0.8 W
Maximum: Approx. 3.0 W
Charger:
Standby: Approx. 0.1 W
Maximum: Approx. 1.8 W
- **Operating conditions:**
0 °C – 40 °C, 20 % – 80 % relative air humidity (dry)

Setting up

Connections

- If you do not connect the telephone line cord and use only mobile lines, set the mobile line only mode to use this unit more conveniently (page 18).

■ Base unit

- ① Connect the AC adaptor to the unit by pressing the plug firmly.
- ② Connect the telephone line cord to the unit until you hear a click.
- ③ Fasten the AC adaptor cord and the telephone line cord by hooking it.
- ④ Connect the AC adaptor to the power outlet.
- ⑤ Connect the telephone line cord to the unit, then to the telephone line socket until you hear a click.
- ⑥ A DSL/ADSL filter (not supplied)*1 is required if you have a DSL/ADSL service.
- ⑦ Connect the corded handset cord to the corded handset and the base unit until you hear a click.

*1 For Australia: Connect a DSL/ADSL filter between the telephone plug and telephone line cord.

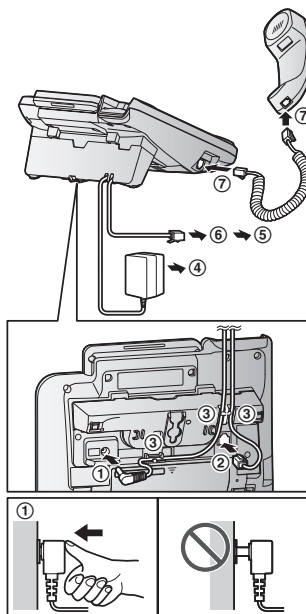

Note:

- Use only the supplied Panasonic AC adaptor PNLV226AL.
- Use only the supplied telephone line cord.

- Follow the directions on the display to set up the unit.

■ Charger

- ① Connect the AC adaptor to the power outlet.

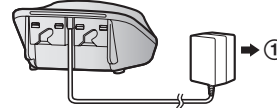

Handset battery installation

- USE ONLY rechargeable Ni-MH batteries AAA (R03) size (A).
- Do NOT use alkaline/manganese/Ni-Cd batteries.
- Confirm correct polarities (+, -).

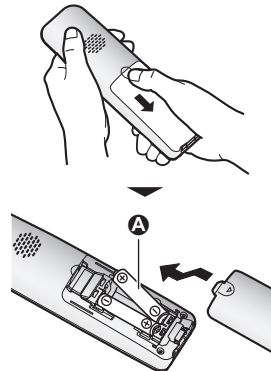

- Follow the directions on the display to set up the unit.

Handset battery charging

Charge for about 7 hours.

- Confirm "Charging" is displayed (A).

Getting Started

- When the batteries are fully charged, “Fully charged” is displayed.



Handset battery level

Icon	Battery level
	High
	Medium
	Low
	Needs charging.
	Empty

Panasonic Ni-MH battery performance (supplied batteries)

Operation	Operating time
In continuous use	17 hours max.*1
Not in use (standby)	330 hours max.*1

*1 If eco mode is on.

Note:

- Actual battery performance depends on usage and ambient environment.

Base unit battery installation (for power backup)

You can insert 2 AAA (R03) batteries (not supplied) into the base unit that will power the unit temporarily in the event of a power failure.

Important:

- The following batteries can be used with the base unit:
 - Rechargeable Ni-MH batteries*1, *2 (including the batteries used in your handset(s))
 - Standard (non-rechargeable) alkaline batteries*3
- Do NOT use manganese batteries.
- Confirm correct polarities (+, -).

*1 The base unit can fully charge Ni-MH batteries in about 15 hours.

*2 We recommend using Panasonic rechargeable batteries (page 4).

*3 Only insert alkaline batteries once a power failure occurs. Remove the alkaline batteries when power is restored.

- 1 Disconnect the telephone line cord (1).
- 2 Open the battery cover (2).
- 3 Install the batteries in the battery compartment (3).
- 4 Close the cover, then reconnect the telephone line cord (4).

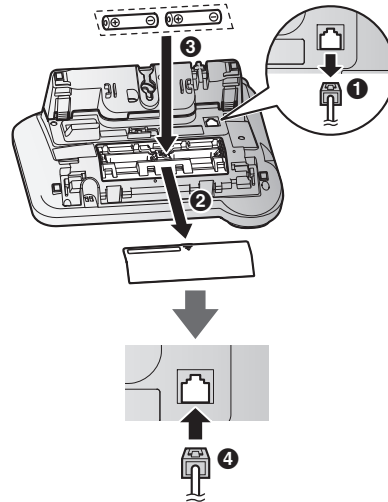

Note:

- If your phone service provider requires additional devices in order to make and receive calls, such as a modem, you may still not be able to make and receive calls even if the base unit's backup power feature is functioning.

Base unit battery status when a power failure occurs

Icon	Battery status
	Power backup mode is on.
	Battery power is low.*1

*1 If begins flashing on the base unit, replace the batteries with new ones as soon as possible. If you replace Ni-MH batteries with alkaline batteries, insert the Ni-MH batteries

into the base unit again after the power is restored so that they will be recharged.

Battery saving mode setting

This feature allows the base unit to reduce its power consumption by limiting the available functions and therefore extend battery life during a power failure.

The following settings are available:

- "On": The unit will work as a standard telephone. Only the corded handset can be used to make and receive calls. (You cannot use the base unit display, phonebook, one-touch dial, answering system, speakerphone, Bluetooth functions, etc.) The base unit display is blank.
- "OFF" (default): You can use the full functions of the base unit, but battery life is not extended. The brightness level for the base unit display is lowered.

Base unit

- 1 [MENU]#150
- 2 [↕]: Select the desired setting.
- 3 [SAVE] → [EXIT]

Note:

- Once the battery saving mode is set to "On", the unit rings with the volume level 1 even if the ringer volume for the base unit is set to "OFF" to let you know an incoming call is being received.

Panasonic Ni-MH battery performance (optional batteries) when operating on backup battery power

Operation	Saving mode	
	Off	On
In continuous use	2 hours max.	7 hours max.
Not in use (standby)	3 hours max.	8 hours max.

Note:

- Battery performance depends on the type of batteries.
- Actual battery performance depends on usage and ambient environment.

Note when setting up

Note for connections

- The AC adaptor must remain connected at all times. (It is normal for the adaptor to feel warm during use.)
- The AC adaptor should be connected to a vertically oriented or floor-mounted AC outlet. Do not connect the AC adaptor to a ceiling-mounted AC outlet, as the weight of the adaptor may cause it to become disconnected.
- The unit is not designed to be used with rotary/pulse dialling services.
- The unit's answering system will not answer incoming calls on your FaxAbility number. (for New Zealand)

Note for Ni-MH battery installation

- **Handset:** Use the supplied rechargeable batteries.
- **Handset/Base unit:** For replacement, we recommend using the Panasonic rechargeable batteries noted on page 4, 6.

Note for battery charging

- It is normal for the handset to feel warm during charging.
- Clean the charge contacts of the handset and charger with a soft and dry cloth once a month. Before cleaning the unit, disconnect from power outlets and any telephone line cords. Clean more often if the unit is exposed to grease, dust, or high humidity.

Intelligent eco mode

This feature automatically reduces handset power consumption by suppressing handset transmission power when the handset is close to the base unit.

- When this feature is activated, **ECO** is displayed. However, during a mobile call, **ECO** is not displayed even though this feature is activated.

Getting Started

Controls

Handset

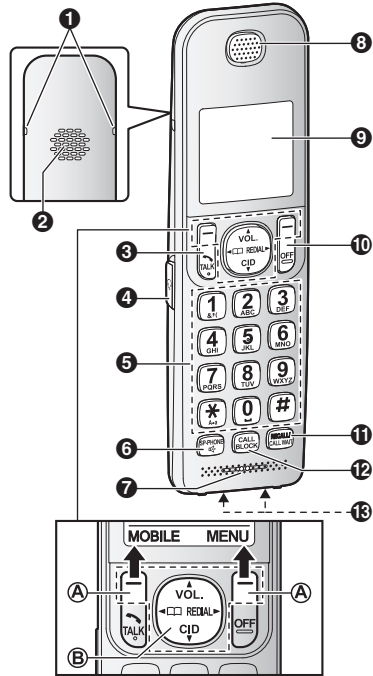

- 1 Belt clip holes
- 2 Speaker
- 3 [TALK]
- 4 Headset socket
- 5 Dial keypad
- 6 [SP-PHONE: Speakerphone]
- 7 Microphone
- 8 Receiver
- 9 Display
- 10 [OFF]
- 11 [RECALL] [CALL WAIT]
- 12 [CALL BLOCK]
- 13 Charge contacts

Control type

A Soft keys

By pressing a soft key, you can select the feature shown directly above it on the display. After a mobile phone is paired, [MOBILE] is displayed.

B Navigator key

- [▲], [▼], [◀], or [▶]: Scroll through various lists and items.
- VOL. (Volume: [▲] or [▼]): Adjust the receiver or speaker volume while talking.
- [◀] [PHONE]: View the phonebook entry.
- [▶] REDIAL: View the redial list.
- [▼] CID (Caller ID): View the caller list.

Base unit

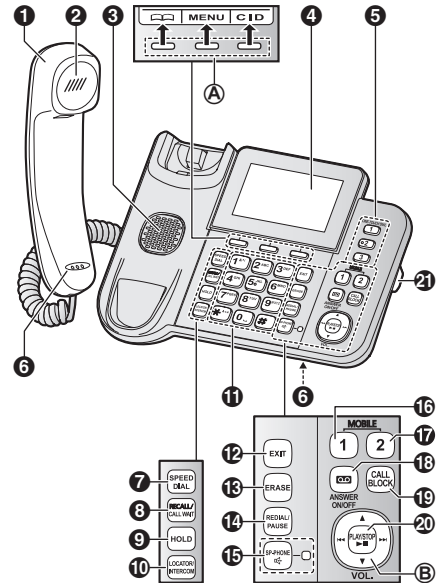

- 1 Corded handset
- 2 Receiver
- 3 Speaker
- 4 Display
 - The display can be moved back and forth to select the desired angle.
- 5 ONE-TOUCH DIAL buttons
- 6 Microphone
- 7 [SPEED DIAL]
- 8 [RECALL] [CALL WAIT]
- 9 [HOLD]
- 10 [LOCATOR] [INTERCOM]
 - You can locate a misplaced handset by pressing [LOCATOR].
- 11 Dial keypad
- 12 [EXIT]
- 13 [ERASE]
- 14 [REDIAL] [PAUSE]
- 15 [SP-PHONE: Speakerphone] SP-PHONE indicator
- 16 [MOBILE 1]

- 17 **MOBILE 1 indicator**
[MOBILE 2]
- 18 **MOBILE 2 indicator**
[ANSWER ON/OFF]
ANSWER ON/OFF indicator
- 19 **[CALL BLOCK]**
- 20 **[PLAY/STOP]**
Message indicator
- 21 **Desk stand/Wall mounting adaptor**
 - The adaptor is a removable attachment for desk stand or wall mounting use (page 66).

■ **Control type**

Ⓐ **Soft keys**

By pressing a soft key, you can select the feature shown directly above it on the display.

Ⓑ **Navigator key**

- [▲], [▼], [◀], or [▶]: Scroll through various lists and items.
- VOL. (Volume: [▲] or [▼]): Adjust the receiver or speaker volume while talking.
- [◀]/[▶]: Repeat/skip messages during playback.

Display icons/Indicators

Handset display items

Item	Meaning
	Within base unit range
	Out of base unit range
	The landline is in use. <ul style="list-style-type: none"> • When flashing: The call is put on hold. • When flashing rapidly: An incoming call is now being received.
	A mobile line is in use.*1 <ul style="list-style-type: none"> • When flashing: The mobile call is put on hold. • When flashing rapidly: A mobile call is being received.
ECO	Eco mode is on.*2 (page 11)
	A mobile phone is connected.*1 Ready to make/receive mobile calls. <ul style="list-style-type: none"> • When turned off: A mobile phone is not connected to the base unit. (page 18)

Item	Meaning
	- A mobile call is in progress on that line. - The mobile line is selected for the setting.
NR	Noise reduction is set. (page 21)
EQ	Equalizer is set. (page 22)
	Speakerphone is on. (page 20)
	Ringer volume is off.*3 (page 39, 41)
	Do not disturb mode is on. (page 45)
PRIV	Privacy mode is on. (page 42)
	Alarm is on. (page 44)
1	Handset number
	Battery level
	Blocked call (page 28)
	Baby monitor is activated. The name/number displayed next to the icon indicates the monitoring unit. (page 45)
In use	Answering system is being used by another handset or the base unit.
Mob1 in use	Someone is using the corresponding line.
Mob2 in use	
M1&M2 in use	
Line in use	











*1 Corresponding lines (1, 2: mobile line) are indicated next to the item.

*2 During a mobile call, the item is not displayed even though the feature is activated.

*3 Corresponding lines (1, 2: mobile line, L: landline) are indicated next to the item. If all lines are turned off, no line is indicated.

Getting Started

Base unit display items

Item	Meaning
	The landline is in use. <ul style="list-style-type: none"> When flashing: The call is put on hold. When flashing rapidly: An incoming call is now being received.
	A mobile line is in use.*1 <ul style="list-style-type: none"> When flashing: The mobile call is put on hold. When flashing rapidly: A mobile call is being received.
	Ringer volume is off.*2 (page 39, 41)
	Do not disturb mode is on. (page 45)
	Privacy mode is on. (page 42)
	"Greeting only" is selected. Caller messages are not recorded. (page 64)
	<ul style="list-style-type: none"> A mobile call is in progress on that line. The mobile line is selected for the setting.
	Power backup mode is on. (page 10)
	Blocked call (page 28)
	A Bluetooth headset is connected to the base unit. It is ready for use.
	A Bluetooth headset is in use.
In use	Answering system is being used by the handset.
Mobile1 in use	Someone is using the corresponding line.
Mobile2 in use	
M1&M2 in use	
Line in use	

*1 Corresponding lines (1, 2: mobile line) are indicated next to the item.

*2 Corresponding lines (1, 2: mobile line, L: landline) are indicated next to the item. If all lines are turned off, no line is indicated.

MOBILE indicators on the base unit

The MOBILE indicators show each mobile line status.

Status	Meaning
On	A mobile phone is connected. Ready to make/receive mobile calls.
Flashing	<ul style="list-style-type: none"> The mobile line is in use. Phonebook entries are being copied from a mobile phone. (page 53) The base unit is searching for the paired mobile phone. The base unit is pairing a mobile phone. A mobile call is put on hold.
Flashing rapidly	A mobile call is being received.
Light off	<ul style="list-style-type: none"> A mobile phone is not paired to the base unit. A mobile phone is not connected to the base unit. (page 18)

Date and time

You can configure this setting using either the base unit or one of the handsets.

Handset / Base unit

- [MENU]** **#** **1** **0** **1**
- Enter the current date, month, and year by selecting 2 digits for each.
Example: 12 July, 2015
1 **2** **0** **7** **1** **5**
- [OK]**
- Enter the current hour and minute (12-hour clock format) by selecting 2 digits for each.
Example: 9:30
0 **9** **3** **0**
- Proceed with the operation for your unit.
Handset: **[X]**: Select "AM" or "PM".
Base unit: **[AM/PM]**: Select "AM" or "PM".
- [SAVE]**
- Proceed with the operation for your unit.
Handset: **[OFF]**

Base unit: [EXIT]

Recording your greeting message

You can record your own greeting message instead of using a pre-recorded greeting message. See page 58 for details.

You can configure this setting using either the base unit or one of the handsets.

Handset / Base unit

- 1 **[MENU][#][3][0][2]**
- 2 **[↕]: “Yes” → [SELECT]**
- 3 Record a greeting message. → **[STOP]**
- 4 Proceed with the operation for your unit.
Handset: [OFF]
Base unit: [EXIT]

Link to Mobile

Link to mobile feature

You can connect your base unit and mobile phone using Bluetooth wireless technology, so that you can make or answer mobile calls using your phone system. This allows you to:

- use the unit to talk on mobile calls even if some areas of your home have poor mobile reception, simply by placing your mobile phone in an area with good reception.
- talk on mobile calls even if your mobile phone is in your pocket or bag.
- enjoy cordless mobile calls even if your mobile phone plugged in and charging.

Important:

- Your mobile phone must support the Hands Free Profile (HFP) specification.
- You may pair 2 mobile phones and 1 headset.
- The unit can be used to talk on 2 lines at the same time (for example, 2 mobile lines, or the landline and 1 mobile line).
- Only 2 Bluetooth devices can be used with the unit at the same time (for example, 2 mobile lines, or the headset and 1 mobile line).
- Locate your mobile phone near the base unit. If the mobile phone is too close to the base unit during a mobile call, you may hear noise. For best performance, we recommend placing the mobile phone between 0.6 m to 3 m away from the base unit.

Pairing a mobile phone

Important:

- Before pairing a Bluetooth enabled mobile phone to the base unit, make sure that no other Bluetooth device such as a Bluetooth headset is connected to your mobile phone.

1 Base unit:

Press and hold **[MOBILE 1]** or **[MOBILE 2]** for a few seconds.

- After the corresponding MOBILE indicator on the base unit starts flashing, the rest of the procedure must be completed within 5 minutes.

2 Your mobile phone:

While the corresponding MOBILE indicator is flashing, follow the instructions of your mobile phone to enter the pairing mode.

- Depending on your mobile phone, it may ask you to enter the Bluetooth PIN (default: "0000"). If your mobile phone shows PassKey confirmation on its display, follow the directions to proceed.

3 Base unit:

Wait until a long beep sounds.

- It may take more than 10 seconds to complete pairing.
- When the corresponding MOBILE indicator lights up, the mobile phone is connected to the base unit. You are ready to make mobile calls.

4 [EXIT]

Note:

- Make sure that your mobile phone is set to connect to this product automatically. Refer to your mobile phone's operating instructions.
- Make sure you cancel your mobile phone's current pairing if you want to pair it to the other line (page 16).
- The default setting for the alert feature is "on", so when you pair your mobile phone to the base unit, this feature may be activated (page 55). (This depends on the version and type of mobile phone you are using.)

Unpairing a mobile phone

You can cancel the pairing of a mobile phone that is stored in the base unit.

You can configure this setting using either the base unit or one of the handsets.

Handset / Base unit

1 For MOBILE 1: **[MENU]#6111**

For MOBILE 2: **[MENU]#6112**

2 **[↕]: "Yes" → [SELECT]**

- When the mobile phone is unpaired, the MOBILE indicator is turned off.

3 Proceed with the operation for your unit.

Handset: [OFF]

Base unit: [EXIT]

Link to mobile settings

Selecting which unit receives mobile calls

You can select which unit rings and receives calls for a mobile line. When “**All**” is selected, all handsets and the base unit ring. You can configure this setting using either the base unit or one of the handsets.

Handset / Base unit

- 1 For MOBILE 1: **[MENU]#6271**
For MOBILE 2: **[MENU]#6272**
- 2 **[↕]**: Select the desired handset or “**All**”. → **[SAVE]**
- 3 Proceed with the operation for your unit.
Handset: [OFF]
Base unit: [EXIT]

Note:

- When you select a specific handset to receive calls for a mobile line:
 - other handsets cannot answer the calls.
 - the base unit can answer the calls even though it does not ring. However, you can make the base unit ring by adjusting the base unit ringer volume (page 39).
- When you change to “**All**” from another setting, the base unit ringer volume also returns to the lowest level even if the ringer volume was changed.
- The units selected with this setting have the alert feature (page 55) applied to them.

Ring as mobile mode

Once this feature is turned on, the handset and base unit ring using the same ringer tone as your mobile phone.

The following settings are available:

- “**off**”: Turn this feature off to use the ringer tones of the handset and base unit. Caller information is announced depending on the Talking Caller ID setting (page 41).
- “**On (with Talking CID)**” (default): The handset and base unit use your mobile phone’s ringer tone. Caller information is announced even if the Talking Caller ID is turned off.
- “**On (without Talking CID)**”: The handset and base unit use your mobile phone’s

ringer tone. Caller information is not announced even if the Talking Caller ID is turned on.

You can configure this setting using either the base unit or one of the handsets.

Important:

- To use this feature, your mobile phone must support Bluetooth in-band ringtone. Refer to your mobile phone’s operating instructions.

Handset / Base unit

- 1 For MOBILE 1: **[MENU]#6141**
For MOBILE 2: **[MENU]#6142**
- 2 **[↕]**: Select the desired setting. → **[SAVE]**
- 3 Proceed with the operation for your unit.
Handset: [OFF]
Base unit: [EXIT]

Note:

- The units use the preset ringer tones instead of your mobile phone’s ringer tone when a mobile call is being received if:
 - your mobile phone is in do not disturb mode (depending on your mobile phone).
 - the base unit is in use.
 - 2 handsets are sharing a landline call.
- If your mobile phone is in do not disturb mode with “**On (with Talking CID)**” set, the unit announces caller information even when Talking Caller ID is turned off (page 41).

To use the handset ringer tone instead of your mobile phone’s ringer tone

Select “**off**” in step 2, “Ring as mobile mode”, page 17.

To change the handset ringer tone for a mobile line, see page 39.

Auto connection to the Bluetooth devices (mobile phones)

After pairing, your Bluetooth devices are connected to the base unit. If you move the Bluetooth devices out of base unit range, the Bluetooth devices are disconnected from the base unit. This feature allows the base unit to try to reconnect the Bluetooth devices at regular intervals when it returns within base unit range. You can set the interval. The default setting is “**1 min**”.

You can configure this setting using either the base unit or one of the handsets.

Link to Mobile

Important:

- When 3 Bluetooth devices (2 mobile phones and 1 headset) are paired to the base unit, only 2 Bluetooth devices can be used with the unit at the same time, and the base unit loses its connection from other Bluetooth devices. To automatically resume the connection to Bluetooth devices, leave the auto connection on.
- Some mobile phones lose connection after usage, please check the specifications of your mobile phone for more details.

Handset / Base unit

- 1 [MENU]#632
- 2 [↕]: Select the desired setting. → [SAVE]
- 3 Proceed with the operation for your unit.
Handset: [OFF]
Base unit: [EXIT]

Note:

- Some mobile phones may ask you if you accept the connection requirement from the base unit. In that case, select “OFF” in step 2. Check the specifications of your mobile phone.

Connecting/disconnecting the mobile phone manually

If you will not be using the paired mobile phone's link to mobile feature temporarily (for example, you do not want the unit to ring when your mobile line receives a call), you can disconnect your mobile phone from the base unit. If you want to use it again, reconnect the mobile phone to the base unit. You can configure this setting using either the base unit or one of the handsets.

Note:

- After you disconnect a paired mobile phone from the base unit manually, it will automatically be connected to the base unit in 30 minutes. If you do not use the link to mobile feature anymore, unpair the mobile phone (page 17).
- A disconnected mobile phone is not unpaired from the base unit, so pairing it to the base unit again is unnecessary.

Handset / Base unit

- 1 **To connect/disconnect:**
For MOBILE 1: [MENU]#6251
For MOBILE 2: [MENU]#6252
 - A long beep sounds.

- 2 Proceed with the operation for your unit.
Handset: [OFF]
Base unit: [EXIT]

Mobile line only mode (If you do not use the landline)

If you do not use the landline, we recommend setting the unit to the mobile line only mode. The default setting is “OFF”.

You can configure this setting using either the base unit or one of the handsets.

Important:

- If you turn on the “Mobile line only mode”, disconnect the telephone line cord from the base unit. Otherwise the “Mobile line only mode” cannot be activated.

Handset / Base unit

- 1 [MENU]#157
- 2 **To turn on:**
[↕]: “On” → [SELECT] → [↕]: “Yes” → [SELECT]
To turn off:
[↕]: “OFF” → [SELECT]

Note:

- Once you set this mode, you can use the following buttons to make mobile calls:
 - for the handset, press [↵] or [↶] instead of [MOBILE] (page 20).
 - for the base unit, lift the corded handset or press [↶] without pressing [MOBILE 1] or [MOBILE 2] set for the mobile line selection (page 19, 24).
- Once you set this mode, the following features cannot be used:
 - Landline features (page 43)
 - Answering system (page 58)
Messages cannot be received.
 - Voicemail features (page 65)
- After this mode is turned on or off, the base unit reboots.
 - Bluetooth connections from mobile phones or headset are disconnected. If the auto connection is turned on (page 17), the mobile phones are reconnected.
 - ☒ will be displayed on the handset momentarily. The handset can be used once ☒ is displayed.

When you use the landline again

Before connecting the telephone line to the base unit, select “☎” in step 2, “Mobile line only mode (If you do not use the landline)”, page 18.

Mobile line selection

This feature determines which mobile line is selected to make mobile calls when:

- you press **[MOBILE]** on the handset.
- you press **[↶]** or **[↷]** on the handset while the mobile line only mode is turned on.
- you lift the corded handset or press **[↶]** on the base unit while the mobile line only mode is turned on.

The following settings are available:

- “**Manual**” (handset only: default): You can select the desired mobile line when making a call.
- “**Mobile phone 1**”^{*1} (base unit default): MOBILE 1 is selected.
- “**Mobile phone 2**”^{*1}: MOBILE 2 is selected.

Handset / Base unit

- 1 **[MENU][#][6][3][4]**
- 2 **[↕]**: Select the desired setting. → **[SAVE]**
- 3 Proceed with the operation for your unit.
Handset: [OFF]
Base unit: [EXIT]

*1 After the Bluetooth device is paired, the device name is displayed.

Storing your area code (for local call)

You need to add your area code when making mobile calls to a phone number in your area. Once you store your area code, it is automatically added to the beginning of the 8-digit (for Australia)/7-digit (for New Zealand) phone number when making mobile calls.

You can configure this setting using either the base unit or one of the handsets.

Handset / Base unit

- 1 **[MENU][#][6][3][3]**
- 2 Enter the 3-digit area code.
• To correct a digit, press **[CLEAR]**.
- 3 **[SAVE]**
- 4 Proceed with the operation for your unit.
Handset: [OFF]

Base unit: [EXIT]

Changing the Bluetooth PIN (Personal Identification Number)

The PIN is used to pair mobile phones to the base unit. The default PIN is “0000”. To prevent unauthorised access to this product, we recommend that you change the PIN, and keep it confidential.

You can configure this setting using either the base unit or one of the handsets.

Important:

- Please make note of your new PIN. The unit does not reveal the PIN to you. If you forget your PIN, see page 75.

Handset / Base unit

- 1 **[MENU][#][6][1][9]**
 - If the unit prompts you to enter the old PIN (when the default has been changed), enter the current 4-digit PIN.
- 2 Enter the new 4-digit PIN. → **[OK]**
- 3 Enter the new 4-digit PIN again. → **[SAVE]**
- 4 Proceed with the operation for your unit.
Handset: [OFF]
Base unit: [EXIT]

Making/Answering Calls Using the Handset



Making mobile calls

Important:

- The unit can be used to talk on 2 lines at the same time (for example, 2 mobile lines, or the landline and 1 mobile line).
- Only 2 Bluetooth devices can be used with the unit at the same time (for example, 2 mobile lines, or the headset and 1 mobile line).
- Before making calls, confirm that the corresponding  on the handset is displayed (page 13).

- 1 Lift the handset and dial the phone number.
 - To correct a digit, press **[CLEAR]**.
- 2 **[MOBILE]**
 - The unit starts dialling when:
 - only 1 mobile phone is paired.
 - a specific line is set to make mobile calls (page 19).Go to step 4.
- 3 : Select the desired mobile phone. → **[SELECT]**
- 4 When you finish talking, press **[OFF]** or place the handset on the charger.

Note:

- To switch to the speaker, press .
To switch back to the receiver, press /.

Adjusting the receiver or speaker volume



Press **[▲]** or **[▼]** repeatedly while talking.

Note:

- The receiver or speaker volume you set is kept for each line (landline and mobile lines).





Making a mobile call using the redial list

The last 5 phone numbers dialled are stored in the redial list (each 48 digits max.).



- 1  REDIAL
- 2 : Select the desired phone number.
- 3 **[MOBILE]**
 - The unit starts dialling when:
 - only 1 mobile phone is paired.
 - a specific line is set to make mobile calls (page 19).
- 4 : Select the desired mobile phone. → **[SELECT]**

Erasing a number in the redial list

■ When a mobile phone is paired:

- 1  REDIAL
- 2 : Select the desired phone number. → **[MENU]**
- 3 : “Erase” → **[SELECT]**
- 4 : “Yes” → **[SELECT]**
- 5 **[OFF]**

■ When a mobile phone is not paired:

- 1  REDIAL
- 2 : Select the desired phone number. → **[ERASE]**
- 3 : “Yes” → **[SELECT]**
- 4 **[OFF]**



Making landline calls

- 1 Lift the handset and dial the phone number.
 - To correct a digit, press **[CLEAR]**.
- 2 
- 3 When you finish talking, press **[OFF]** or place the handset on the charger.

Using the speakerphone



- 1 Dial the phone number and press .
- 2 When you finish talking, press **[OFF]**.

Note:

- To switch back to the receiver, press /.

Making a call using the redial list

The last 5 phone numbers dialled are stored in the redial list (each 48 digits max.).

- 1  REDIAL
- 2 : Select the desired phone number.
- 3 

Pause (for PBX/long distance service users)

A pause is sometimes required when making calls using a PBX or long distance service. When storing a calling card access number and/or PIN in the phonebook, a pause is also needed (page 34).

Example: If you need to dial the line access number “9” when making outside calls with a PBX:

Making/Answering Calls Using the Handset

- 1 **[9]** → **[▲]** (Pause)
- 2 Dial the phone number. → **[↶]**

Note:

- A 3 second pause is inserted each time **[▲]** (Pause) is pressed.

Answering calls

- 1 Lift the handset and press **[↶]** or **[📞]** when the unit rings.
 - To answer a mobile call, you can also press **[MOBILE]**.
- 2 When you finish talking, press **[OFF]** or place the handset on the charger.

Any key answer: You can answer the call by pressing any dial key.

Auto talk: You can answer calls simply by lifting the handset (page 42).

Temporary ringer off: You can turn the ringer off temporarily by pressing **[🔕]**.

Adjusting the handset ringer volume

Press **[▲]** or **[▼]** repeatedly to select the desired volume while ringing.

Note:

- The ringer volume you set is kept for each line (landline and mobile lines).

Useful features during a call

Hold

- 1 Press **[MENU]** during an outside call.
- 2 **[↕]**: "Hold" → **[SELECT]**
- 3 **To release hold on the mobile line:**
Press **[MOBILE]**.^{*1}
 - Another handset user can take the call by pressing **[MOBILE]**.^{*1}
 - ^{*1} If you press **[MOBILE]** and the selection list is displayed, select the desired mobile line and press **[SELECT]**.
 - The base unit user can take the call by pressing **[MOBILE 1]** or **[MOBILE 2]**. → Lift the corded handset.

To release hold on the landline:

Press **[↶]**.

- Another handset user can take the call by pressing **[↶]**.
- The base unit user can take the call by lifting the corded handset.

Note:

- After holding for 10 minutes, the call is disconnected.

Mute

- 1 Press **[MUTE]** during a call.
- 2 To return to the call, press **[MUTE]**.

Note:

- **[MUTE]** is a soft key visible on the display during a call.

Recall for landline calls

[RECALL] allows you to use the special features of your host PBX such as transferring an extension call, or accessing optional telephone services.

Note:

- To change the recall time, see page 42.

Handset noise reduction

This feature allows you to hear the voice of the person you are talking to more clearly, by reducing the surrounding noise coming from the other party's telephone.

- 1 Press **[MENU]** while talking.
- 2 **[↕]**: "Noise reduction on" or "Noise reduction off" → **[SELECT]**

Note:

- The setting you made is kept for each line (landline and mobile lines).
The default settings are as follows:
 - for landline: "Noise reduction off"
 - for mobile lines: "Noise reduction on"
- Depending on the environment where this handset is being used, this feature may not be effective.
- This feature is not available while using the speakerphone.

Making/Answering Calls Using the Handset

Handset equalizer

This feature clarifies the voice of the person you are talking to, producing a more natural-sounding voice that is easier to hear and understand.

- 1 Press **[MENU]** while talking.
- 2 **[↕]**: “Equalizer” → **[SELECT]**
- 3 **[↕]**: Select the desired setting.
- 4 Press **[OK]** to exit.

Note:

- The setting you made is kept for each line (landline and mobile lines).
- Depending on the condition and quality of your telephone line, this feature may emphasize existing line noise. If it becomes difficult to hear, turn this feature off.
- This feature is not available while using the speakerphone.
- When both the “Equalizer” setting and noise reduction are activated, **NR** is shown on the display.

Call share

You can join an existing outside call.

■ While another unit is on a mobile call:

- 1 To join the conversation, press **[MOBILE]**.
 - You can join the conversation when:
 - only 1 mobile phone is paired.
 - a specific line is set to make mobile calls (page 19).
- 2 **[↕]**: Select the corresponding mobile phone. → **[SELECT]**

■ While another unit is on a landline call:

To join the conversation, press **[↶]**.

Note:

- A maximum of 3 parties (including 1 outside party) can join a conversation. (**3-way conference**)
- To prevent other users from joining your conversations with outside callers, turn privacy mode on (page 42).

Transferring calls, conference calls

Outside calls can be transferred or a conference call with an outside party can be made between 2 handsets.

- 1 During an outside call, press **[MENU]**.
- 2 **[↕]**: “Intercom” → **[SELECT]**
- 3 **[↕]**: Select the desired unit. → **[SELECT]**
- 4 Wait for the paged party to answer.
 - If the paged party does not answer, press **[BACK]** to return to the outside call.

5 To complete the transfer:

Press **[OFF]**.

To establish a conference call:

[MENU] → **[↕]**: “Conference” → **[SELECT]**

- To leave the conference, press **[OFF]**. The other 2 parties can continue the conversation.
- To put the outside call on hold: **[MENU]** → **[↕]**: “Hold” → **[SELECT]**
To resume the conference: **[MENU]** → **[↕]**: “Conference” → **[SELECT]**
- To cancel the conference: **[MENU]** → **[↕]**: “Stop conference” → **[SELECT]**
You can continue the conversation with the outside caller.

Transferring a mobile call between the handset and a mobile phone

Transferring a mobile call from the handset to a mobile phone

- 1 Press **[MENU]** during a mobile call.
- 2 **[↕]**: “Transfer to mobile” → **[SELECT]**
 - The mobile call is transferred to the mobile phone.

Note:

- Depending on your mobile phone type, you may need to set the mobile phone to be ready to talk before transferring. For example, if your mobile phone has a top cover, open it beforehand.

Transferring a mobile call from a mobile phone to the handset

During a conversation using a mobile phone, the call cannot be transferred to the handset by the mobile phone. Perform the following with the handset.

- 1 During a conversation using a mobile phone, press **[MOBILE]**.
 - The call is transferred to the handset when:
 - only 1 mobile phone is paired.

Making/Answering Calls Using the Handset

- a specific line is set to make mobile calls (page 19).
- 2 **[↕]**: Select the corresponding mobile phone.
→ **[SELECT]**
 - The call is transferred to the handset.

Answering a 2nd call

If you receive a call while talking on the phone, the interrupt tone sounds (page 41) and the 2nd caller's information is displayed if you subscribe to Caller ID service (page 49).

Answering a 2nd call during a landline call

- 1 Press **[MENU]** during a landline call.
- 2 **[↕]**: "Hold" → **[SELECT]**
- 3 **To answer the 2nd call:**
Press **[MOBILE]** while the 2nd call is being received.
- 4 To hang up the 2nd call and return to the 1st call (landline call), press **[OFF]**, then press **[↶]**.

Answering a 2nd call during a mobile call

- 1 Press **[MENU]** during a mobile call.
 - 2 **[↕]**: "Hold" → **[SELECT]**
 - 3 **To answer the 2nd call:**
Press **[↶]** or **[MOBILE]** while the 2nd call is being received.
 - 4 To hang up the 2nd call and return to the 1st call (mobile call), press **[OFF]**, then press **[MOBILE]**.^{*1}
- ^{*1} If you press **[MOBILE]** and the selection list is displayed, select the desired mobile line and press **[SELECT]**.

Making/Answering Calls Using the Base Unit

Making mobile calls

Important:

- The unit can be used to talk on 2 lines at the same time (for example, 2 mobile lines, or the landline and 1 mobile line).
- Only 2 Bluetooth devices can be used with the unit at the same time (for example, 2 mobile lines, or the headset and 1 mobile line).
- Before making calls, confirm that the corresponding MOBILE indicator on the base unit lights up (page 14).

- 1 Dial the phone number.
 - To correct a digit, press **[CLEAR]**.
- 2 Press **[MOBILE 1]** or **[MOBILE 2]**.
- 3 Lift the corded handset.
- 4 When you finish talking, place the corded handset on the cradle.

Note:

- While on a call, you can switch from the base unit to the cordless handset as follows. The privacy mode must be off (page 42).
 - ① **Handset:** **[MOBILE]***1 → **[↕]**: Select the desired mobile phone. → **[SELECT]**
 - *1 The call is taken when:
 - only 1 mobile phone is paired.
 - a specific line is set to make mobile calls (page 19).
 - ② **Base unit:** Place the corded handset on the cradle. When the speakerphone is used, press **[📞]**.
- During a conversation with the corded handset, you can switch to the speakerphone by pressing **[📞]**, then place the corded handset on the cradle.

Adjusting the receiver or speaker volume

Press **[▲]** or **[▼]** repeatedly while talking.

Note:

- The receiver or speaker volume you set is kept for each line (landline and mobile lines).

Making a mobile call using the redial list

The last 10 phone numbers dialed are stored in the redial list (each 48 digits max.).

- 1 **[REDIAL]**
- 2 **[↕]**: Select the desired phone number.

- 3 Press **[MOBILE 1]** or **[MOBILE 2]**, then lift the corded handset.

Erasing a number in the redial list

- 1 **[REDIAL]**
- 2 **[↕]**: Select the desired phone number. → **[ERASE]**
- 3 **[↕]**: “Yes” → **[SELECT]**
- 4 **[EXIT]**

Making landline calls

- 1 Dial the phone number.
 - To correct a digit, press **[CLEAR]**.
- 2 Lift the corded handset.
- 3 When you finish talking, place the corded handset on the cradle.

Note:

- You can also dial the phone number after lifting the corded handset.
- While on a call, you can switch from the base unit to the cordless handset as follows. The privacy mode must be off (page 42).
 - ① **Handset:** Press **[↶]**.
 - ② **Base unit:** Place the corded handset on the cradle. When the speakerphone is used, press **[📞]**.

Using the speakerphone

- 1 During a conversation with the corded handset, press **[📞]** to turn on the speakerphone.
 - You can place the corded handset on the cradle.
 - Speak into the base unit microphone.
- 2 When you finish talking, press **[📞]**.

Note:

- To switch to the receiver, lift the corded handset.

Making a call using the redial list

The last 10 phone numbers dialed are stored in the redial list (each 48 digits max.).

- 1 **[REDIAL]**
- 2 **[↕]**: Select the desired phone number.
- 3 Lift the corded handset.

Making/Answering Calls Using the Base Unit

Pause (for PBX/long distance service users)

A pause is sometimes required when making calls using a PBX or long distance service. When storing a calling card access number and/or PIN in the phonebook, a pause is also needed (page 34).

Example: If you need to dial the line access number "9" when making outside calls with a PBX:

- 1 **[9]** → **[PAUSE]**
- 2 Dial the phone number.
- 3 Lift the corded handset.

Note:

- A 3 second pause is inserted each time **[PAUSE]** is pressed.

Answering calls

- 1 Lift the corded handset or press **[📞]** when the unit rings.
 - You can also answer the mobile call by pressing **[MOBILE 1]** or **[MOBILE 2]**.
- 2 When you finish talking, place the corded handset on the cradle. When the speakerphone is used, press **[📞]**.

Temporary ringer off: You can turn the ringer off temporarily by pressing **[🔕]**.

Adjusting the base unit ringer volume

Press **[▲]** or **[▼]** repeatedly to select the desired volume while ringing.

Note:

- The ringer volume you set is kept for each line (landline and mobile lines).

Useful features during a call

Hold

- 1 Press **[HOLD]** during an outside call.
 - If you are using the corded handset, you can place it on the cradle.
- 2 **To release hold on the mobile line:** Press **[MOBILE 1]** or **[MOBILE 2]**, then lift the corded handset.

- A handset user can take the call: **[MOBILE]¹** → **[↕]** : Select the corresponding mobile phone. → **[SELECT]**
- *1 The call is taken when:
 - only 1 mobile phone is paired.
 - a specific line is set to make mobile calls (page 19).

To release hold on the landline:

Lift the corded handset.

- A handset user can take the call by pressing **[📞]**.

Note:

- While a landline call is on hold, the SP-PHONE indicator flashes.
- After holding for 10 minutes, the call is disconnected.

Mute

- 1 Press **[MUTE]** during a call.
- 2 To return to the call, press **[MUTE]**.

Note:

- **[MUTE]** is a soft key visible on the display during a call.

Recall for landline calls

[RECALL] allows you to use the special features of your host PBX such as transferring an extension call, or accessing optional telephone services.

Note:

- To change the recall time, see page 42.

Call share

You can join an existing outside call. To select the line that is being used for the call:

- for a mobile line, press **[MOBILE 1]** or **[MOBILE 2]**, then lift the corded handset.
- for the landline, lift the corded handset.

Note:

- A maximum of 3 parties (including 1 outside party) can join a conversation. **(3-way conference)**
- To prevent other users from joining your conversations with outside callers, turn privacy mode on (page 42).

Making/Answering Calls Using the Base Unit

Transferring calls, conference calls

Outside calls can be transferred or a conference call with an outside party can be made between a handset and the base unit.

- 1 During an outside call, press **[INTERCOM]**.
When 2 or more handsets are registered:
[↕]: Select the desired unit. → **[SELECT]**
 - To page all handsets, press **[0]** or wait for a few seconds.
- 2 Wait for the paged party to answer.
 - If paged party does not answer, press **[INTERCOM]** to return to the outside call.
- 3 **To complete the transfer:**
Place the corded handset on the cradle.
 - The outside call is being routed to the handset.**To establish a conference call:**
Press **[CONF]**.
 - To leave the conference, place the corded handset on the cradle. The other 2 parties can continue the conversation.
 - To put the outside call on hold, press **[HOLD]**. To resume the conference, press **[CONF]**.

Transferring a mobile call between the base unit and a mobile phone

Transferring a mobile call from the base unit to a mobile phone

- 1 Press **[MENU]** during a mobile call.
- 2 **[↕]**: "Transfer to mobile" → **[SELECT]**
 - The mobile call is transferred to the mobile phone.
- 3 Place the corded handset on the cradle.

Note:

- You can also press and hold **[MOBILE 1]** or **[MOBILE 2]** to transfer a mobile call instead of steps 1 and 2.
- Depending on your mobile phone type, you may need to set the mobile phone to be ready to talk before transferring. For example, if your mobile phone has a top cover, open it beforehand.

Transferring a mobile call from a mobile phone to the base unit

During a conversation using a mobile phone, press **[MOBILE 1]** or **[MOBILE 2]**, then lift the corded handset.

- The mobile call is transferred to the base unit.

Answering a 2nd call

If you receive a call while talking on the phone, the interrupt tone sounds (page 41) and the 2nd caller's information is displayed if you subscribe to Caller ID service (page 49).

Answering a 2nd call during a landline call

- 1 Press **[HOLD]** during a landline call.
- 2 **To answer the 2nd call:**
Press **[MOBILE 1]** or **[MOBILE 2]**.
- 3 To hang up the 2nd call and return to the 1st call (landline call), place the corded handset on the cradle, then lift it again.

Answering a 2nd call during a mobile call

- 1 Press **[HOLD]** during a mobile call.
- 2 **To answer the 2nd call:**
Place the corded handset on the cradle, then lift it again.
- 3 To hang up the 2nd call and return to the 1st call (mobile call), place the corded handset on the cradle, then press **[MOBILE 1]** or **[MOBILE 2]** and lift the corded handset.

Intercom

Intercom calls can be made:

- between handsets
- between a handset and the base unit

Note:

- When paging unit(s), the paged unit(s) beeps for 1 minute.
- If you receive an outside call while talking on the intercom, the interrupt tone sounds (page 41).
 - **Handset:** To finish intercom, press **[OFF]**. To answer the call, press **[↶]**.
 - **Base unit:** To finish intercom, place the corded handset on the cradle. If the speakerphone is used, press **[☎]**. To answer the call, lift the corded handset. If the speakerphone is used, press **[☎]**.

Making an intercom call

Handset

- 1 **[MENU]** → **[↕]**: “Intercom” → **[SELECT]**
- 2 **[↕]**: Select the desired unit. → **[SELECT]**
- 3 When you finish talking, press **[OFF]**.

Note:

- You can also use the **[INTERCOM]** soft key, if displayed, to make intercom calls.

Base unit

- 1 Press **[INTERCOM]**.
 - When 2 or more handsets are registered:**
 - [↕]**: Select the desired unit. → **[SELECT]**
 - To page all handsets, press **[0]** or wait for a few seconds.
 - Lift the corded handset if needed.
- 2 When you finish talking, press **[☎]** or place the corded handset on the cradle.

Answering an intercom call

Handset

- 1 Press **[↶]** to answer the page.
- 2 When you finish talking, press **[OFF]**.

Base unit

- 1 Press **[☎]** or lift the corded handset to answer the page.

- 2 When you finish talking, press **[☎]** or place the corded handset on the cradle.

Turning auto intercom on/off

This feature allows the handset or base unit to answer intercom calls automatically when it is called. You do not need to press **[↶]**, lift the corded handset, or press **[☎]**. When this feature is set to “on”, the monitoring handset or base unit for the baby monitor feature (page 47) will also answer baby monitor calls automatically. The default setting is “off”.

Handset / Base unit

- 1 **[MENU]** **[#]** **[2]** **[7]** **[3]**
- 2 **[↕]**: Select the desired setting. → **[SAVE]**
- 3 Proceed with the operation for your unit.
Handset: **[OFF]**
Base unit: **[EXIT]**

Call Block

Using the [CALL BLOCK] button

You can press the [CALL BLOCK] button in the following situations to disconnect the current call and add a phone number to the call block list:

- when an incoming call is being received
- when an incoming call is being recorded by the answering system
- when talking on an outside call

Once a phone number has been added to the call block list, the unit will block calls from that phone number in the future.

Handset / Base unit

- 1 Press [CALL BLOCK] under the situations shown above.
- 2 Confirm the call block number and press [YES].
 - The call block number is stored in the call block list, "Caller blocked" is displayed, and then the call is disconnected.

Note:

- If the call has no phone number, the call is blocked but it is not stored in the call block list.
- The call block feature is not available:
 - for intercom calls or calls received by call waiting.
 - when a landline call (or mobile call) is being received during a mobile call (or landline call).
- Blocked calls are logged in the caller list.

Storing unwanted callers

The unit can block calls by storing the desired items in the call block list beforehand (Caller ID subscribers only).

- "Single Number": The unit blocks calls from specific phone numbers stored in the call block list.
- "Range of numbers": The unit blocks calls that begin with a number stored in the call block list, such as a toll-free phone number prefix or certain area codes.
- "Withheld": The unit blocks calls that have no phone number.

Single phone numbers and ranges of numbers can be stored in the call block list up to 250 items in total.

Blocking unwanted callers:

When a call is received, the unit rings briefly*1 while caller information is being received.

If the caller's phone number matches an entry in the call block list, the unit emits no sound to the caller, and disconnects the call.

- *1 If you do not want this one ring to sound, select "No" in "Setting not to ring once for blocked call" (page 29).

Storing a single phone number

Important:

- You must include the area code when storing phone numbers in the call block list.

Adding call blocked numbers from the caller list

Handset / Base unit

- 1 [▼] CID
- 2 [↕]: Select the desired entry to be blocked.
- 3 [CALL BLOCK]
- 4 [↕]: "Yes" → [SELECT]
- 5 Edit the phone number if necessary (24 digits max.).
- 6 Proceed with the operation for your unit.
Handset: [OFF]
Base unit: [EXIT]

Adding call blocked numbers manually

Handset

- 1 [CALL BLOCK]
- 2 [↕]: "Single Number" → [SELECT]
- 3 [MENU] → [↕]: "Add" → [SELECT]
- 4 Enter the phone number (24 digits max.).
- 5 [SAVE] → [OFF]

Base unit

- 1 [CALL BLOCK]
- 2 [↕]: "Single Number" → [SELECT] → [ADD]
- 3 Enter the phone number (24 digits max.).
- 4 [SAVE] → [EXIT]

Storing a range of number

Handset

- 1 [CALL BLOCK]
- 2 [↕]: "Range of numbers" → [SELECT]
- 3 [MENU] → [↕]: "Add" → [SELECT]
- 4 Enter the desired number (2-8 digits).
- 5 [SAVE] → [OFF]

Base unit

- 1 [CALL BLOCK]
- 2 [↕]: "Range of numbers" → [SELECT]
- 3 [ADD]
- 4 Enter the desired number (2-8 digits).
- 5 [SAVE] → [EXIT]

Blocking incoming calls that have no phone number

You can block calls when no phone number is provided, such as private callers or out of area calls.

Handset / Base unit

- 1 [CALL BLOCK]
- 2 [↕]: "Withheld" → [SELECT]
- 3 [↕]: Select the desired setting. → [SAVE]
- 4 Proceed with the operation for your unit.
Handset: [OFF]
Base unit: [EXIT]

Setting not to ring once for blocked call

If you do not want the unit to sound one ring for calls from phone numbers stored in the call block list, select "No". The default setting is "Yes".

Handset / Base unit

- 1 [CALL BLOCK]
- 2 [↕]: "One ring for blocked call" → [SELECT]
- 3 [↕]: Select the desired setting. → [SAVE]
- 4 Proceed with the operation for your unit.
Handset: [OFF]
Base unit: [EXIT]

Viewing/editing/erasing call block numbers

Handset

- 1 [CALL BLOCK]
 - 2 [↕]: "Single Number" or "Range of numbers" → [SELECT]
 - 3 [↕]: Select the desired entry.
• After viewing, press [OFF] to exit.
 - 4 **To edit a number:**
[EDIT] → Edit the number. → [SAVE] → [OFF]
- To erase a number:**
[ERASE] → [↕]: "Yes" → [SELECT] → [OFF]

Base unit

- 1 [CALL BLOCK]
 - 2 [↕]: "Single Number" or "Range of numbers" → [SELECT]
 - 3 [↕]: Select the desired entry.
• After viewing, press [EXIT] to exit.
 - 4 **To edit a number:**
[EDIT] → Edit the number. → [SAVE] → [EXIT]
- To erase a number:**
[ERASE] → [↕]: "Yes" → [SELECT] → [EXIT]

Note:

- When editing, press the desired dial key to add digits and press [CLEAR] to erase digits.

Erasing all call block numbers

Handset / Base unit

- 1 [CALL BLOCK]
- 2 [↕]: "Single Number" or "Range of numbers" → [SELECT]
- 3 Proceed with the operation for your unit.
Handset: [MENU] → [↕]: "Erase all" → [SELECT]
Base unit: [ERASE]
- 4 [↕]: "Yes" → [SELECT]
- 5 [↕]: "Yes" → [SELECT]
- 6 Proceed with the operation for your unit.
Handset: [OFF]

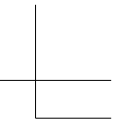
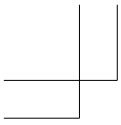

Call Block

Base unit: [EXIT]

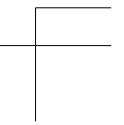
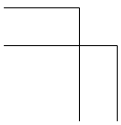
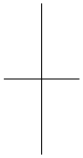

Phonebook

You can add 3,000 names (16 characters max.) and phone numbers (24 digits max.) to the phonebook, and assign each phonebook entry to the desired group (page 32). The following groups are available:

- Group 1: "Home"*1 (default)
- Group 2: "Mobile 1"*1
- Group 3: "Mobile 2"*1
- Group 4-9: You can change the group name for each group.

*1 For groups 1-3, the group names cannot be changed.

Important:

- All entries can be shared by the base unit and any registered handset.
- You can copy phonebook entries from a Bluetooth mobile phone to the unit's phonebook (page 53).

Adding phonebook entries

Handset / Base unit

- 1** Proceed with the operation for your unit.
Handset: [◀] □□ → [MENU]
Base unit: [□□] → [MENU]
- 2** [↕]: "Add new entry" → [SELECT]
- 3** Enter the party's name. → [OK]
- 4** Enter the party's phone number. → [OK]
- 5** [↕]: Select the desired group. → [SELECT]
2 times
- 6** Proceed with the operation for your unit.
Handset: [OFF]
Base unit: [EXIT]

Note for base unit:

- You can also add entries as follows:
Press [□□]. → [ADD] → Go to step 3.

Note for New Zealand:

- Your phone service provider may charge you for a local call if the number dialled has the area code prefix included. If this is unacceptable, dial only the 7-digit local number. Do not dial the "0" prefix or the area code.

Character table for entering names

While entering characters, you can switch between uppercase and lowercase by pressing [X] (A→a).

Key	Character
[1]	& ' () * , - . / 1
[2]	A B C 2 a b c 2
[3]	D E F 3 d e f 3
[4]	G H I 4 g h i 4
[5]	J K L 5 j k l 5
[6]	M N O 6 m n o 6
[7]	P Q R S 7 p q r s 7
[8]	T U V 8 t u v 8
[9]	W X Y Z 9 w x y z 9
[0]	_ 0
[#]	#

- To enter another character that is located on the same dial key:
Handset: Press [▶] to move the cursor to the next space.
Base unit: Press [▶▶] to move the cursor to the next space.
- If you do not press any dial key within 2 seconds after entering a character, the character is fixed and the cursor moves to the next space.
- _ in the above table represents a single space.

Erasing the character or number

- Handset:** Press [◀] or [▶]. → [CLEAR]
Base unit: Press [◀◀] or [▶▶]. → [CLEAR]
- Press and hold [CLEAR] to erase all characters or numbers.

Phonebook

Storing a redial list number to the phonebook

Phone numbers of up to 24 digits can be stored in the phonebook.

Handset

■ When a mobile phone is paired:

- 1 [▶] REDIAL
- 2 [↕]: Select the desired phone number. → [MENU]
- 3 [↕]: "Save" → [SELECT]
- 4 To store the name, continue from step 3, "Editing entries", page 33.

■ When a mobile phone is not paired:

- 1 [▶] REDIAL
- 2 [↕]: Select the desired phone number. → [SAVE]
- 3 To store the name, continue from step 3, "Editing entries", page 33.

Base unit

- 1 [REDIAL]
- 2 [↕]: Select the desired phone number. → [SAVE]
- 3 To store the name, continue from step 3, "Editing entries", page 33.

Storing caller information to the phonebook

Handset

- 1 [▼] CID
- 2 [↕]: Select the desired entry. → [MENU]
- 3 [↕]: "Save caller ID" → [SELECT]
- 4 [↕]: "Phonebook" → [SELECT]
- 5 Continue from step 3, "Editing entries", page 33.

Base unit

- 1 [CID]
- 2 [↕]: Select the desired entry.
- 3 [SAVE]
- 4 [↕]: "Phonebook" → [SELECT]
- 5 Continue from step 3, "Editing entries", page 33.

Groups

Groups can help you find entries in the phonebook quickly and easily. You can change the group name for groups 4-9 ("Friends", "Family", etc.). By assigning different ringer tones for different groups of callers, you can identify who is calling (ringer ID), if you have subscribed to Caller ID service.

Changing group names/setting ringer ID

Handset / Base unit

- 1 Proceed with the operation for your unit.
Handset: [◀] □□ → [MENU]
Base unit: [□□] → [MENU]
- 2 [↕]: "Group" → [SELECT]
- 3 [↕]: Select the desired group. → [SELECT]
 - If you selected "Home", "Mobile 1", or "Mobile 2" on the handset, go to step 5.
- 4 **To change group names**
[↕]: "Group name" → [SELECT] → Edit the name (10 characters max.). → [SAVE]
- 5 **To set group ringer tone (handset)**
[↕]: Select the current setting of the group ringer tone. → [SELECT] → [↕]: Select the desired ringer tone. → [SAVE]
- 6 Proceed with the operation for your unit.
Handset: [OFF]
Base unit: [EXIT]

Note:

- The ringer may be changed after the 2nd ring.

Finding and calling from a phonebook entry

Once you have found the desired entry using one of the following 4 methods, make a call with your unit.

■ Using a mobile line:

Handset

- 1 [MOBILE]
 - The unit starts dialling when:
 - only 1 mobile phone is paired.
 - a specific line is set to make mobile calls (page 19).
- 2 [↕]: Select the desired mobile phone. → [SELECT]

Base unit

Press **[MOBILE 1]** or **[MOBILE 2]**. → Lift the corded handset.

■ **Using a landline:**

Handset

[↶]

Base unit

Lift the corded handset.

Scrolling through all entries

Handset / Base unit

- 1 Proceed with the operation for your unit.
Handset: **[↶]** **[□□]**
Base unit: **[□□]**
- 2 **[↕]**: Select the desired entry.

Searching by first character

Handset / Base unit

- 1 Proceed with the operation for your unit.
Handset: **[↶]** **[□□]**
Base unit: **[□□]**
- 2 Press the dial key (**[0]** – **[9]** or **[#]**) which contains the character you are searching for (page 31).
- 3 **[↕]**: Scroll through the phonebook if necessary.

Searching by query

You can narrow down the search to enter the first characters of a name.

Handset / Base unit

- 1 Proceed with the operation for your unit.
Handset: **[↶]** **[□□]** → **[✖]**
Base unit: **[□□]** → **[✖]**
- 2 To search for the name, enter the first characters (up to 4) in uppercase (page 31).
- 3 **[OK]**
- 4 **[↕]**: Scroll through the phonebook if necessary.

Searching by group

Handset / Base unit

- 1 Proceed with the operation for your unit.
Handset: **[↶]** **[□□]**
Base unit: **[□□]**

2 **[GROUP]**

- 3 **[↕]**: Select the group you want to search. → **[SELECT]**
 - If you select “**All groups**”, the unit ends the group search.
- 4 **[↕]**: Select the desired entry.

Editing entries

Handset

- 1 Find the desired entry (page 32).
- 2 **[MENU]** → **[↕]**: “**Edit**” → **[SELECT]**
- 3 Edit the name if necessary. → **[OK]**
- 4 Edit the phone number if necessary. → **[OK]**
- 5 **[↕]**: Select the desired group (page 32). → **[SELECT]** 2 times → **[OFF]**

Base unit

- 1 Find the desired entry (page 32).
- 2 **[EDIT]**
- 3 Edit the name if necessary. → **[OK]**
- 4 Edit the phone number if necessary. → **[OK]**
- 5 **[↕]**: Select the desired group (page 32). → **[SELECT]** 2 times → **[EXIT]**

Erasing entries

Erasing an entry

Handset

- 1 Find the desired entry (page 32).
- 2 **[MENU]** → **[↕]**: “**Erase**” → **[SELECT]**
- 3 **[↕]**: “**Yes**” → **[SELECT]** → **[OFF]**

Base unit

- 1 Find the desired entry (page 32).
- 2 **[ERASE]** → **[↕]**: “**Yes**” → **[SELECT]** → **[EXIT]**

Erasing all entries

Handset / Base unit

- 1 Proceed with the operation for your unit.
Handset: **[↶]** **[□□]** → **[MENU]**
Base unit: **[□□]** → **[MENU]**
- 2 **[↕]**: “**Erase all**” → **[SELECT]**
- 3 **[↕]**: Select the desired group. → **[SELECT]**

Phonebook

- 4 [↕]: "Yes" → [SELECT]
- 5 [↕]: "Yes" → [SELECT]
- 6 Proceed with the operation for your unit.
Handset: [OFF]
Base unit: [EXIT]

Chain dial

This feature allows you to dial phone numbers in the phonebook while you are on a call. This feature can be used, for example, to dial a calling card access number or bank account PIN that you have stored in the phonebook, without having to dial manually.

Handset / Base unit

- 1 Proceed with the operation for your unit.
Handset: During an outside call, press [←]
□□.
Base unit: During an outside call, press [□□].
- 2 [↕]: Select the desired entry.
- 3 Press [CALL] to dial the number.

Note:

- When storing a calling card access number and your PIN in the phonebook as one phonebook entry, press [▲] (Pause) on the handset or [PAUSE] on the base unit to add pauses after the number and PIN as necessary (page 20, 25).

Speed dial

You can store phone numbers to the base unit and handset separately:

- Handset: up to 9 entries.
- Base unit: up to 9 entries.

Adding phone numbers to speed dial keys

Handset

You can assign 1 phone number to each of the dial keys ([1] to [9]).

■ By entering phone numbers:

- 1 Press and hold the desired speed dial key ([1] to [9]). → [ADD]
- 2 [↕]: "Manual" → [SELECT]

- 3 Enter the party's name (16 characters max.). → [OK]
- 4 Enter the party's phone number (24 digits max.). → [OK]
- 5 [SELECT] → [OFF]

■ From the phonebook:

- 1 Press and hold the desired speed dial key ([1] to [9]). → [ADD]
- 2 [↕]: "Phonebook" → [SELECT]
- 3 [↕]: Select the desired entry.
- 4 [SAVE] → [OFF]

Base unit

■ By entering phone numbers:

- 1 [SPEED DIAL]
- 2 [↕]: Select the desired speed dial key. → [EDIT]
- 3 Enter the party's name (16 characters max.). → [OK]
- 4 Enter the party's phone number (24 digits max.). → [OK]
- 5 [SELECT] → [EXIT]

■ From the phonebook:

- 1 [SPEED DIAL]
- 2 [↕]: Select the desired speed dial key. → [□□]
- 3 [↕]: Select the desired entry.
- 4 [SAVE] → [EXIT]

Note for handset and base unit:

- If you edit a phonebook entry which is assigned to a speed dial key, the edited entry does not transfer to the speed dial key.

Note for base unit:

- You can also select the desired entry as follows:
 - Press and hold the desired speed dial key ([1] to [9]).
 - Press [SPEED DIAL] and then enter the desired speed dial key ([1] to [9]).

Editing an entry

Handset

- 1 Press and hold the desired speed dial key ([1] to [9]). → [MENU]

- 2 [↕]: "Edit" → [SELECT]
- 3 Edit the name if necessary. → [OK]
- 4 Edit the phone number if necessary. → [OK]
- 5 [SELECT] → [OFF]

Base unit

- 1 [SPEED DIAL]
- 2 [↕]: Select the desired entry. → [DETAIL]
- 3 [EDIT]
- 4 Edit the name if necessary. → [OK]
- 5 Edit the phone number if necessary. → [OK]
- 6 [SELECT] → [EXIT]

Erasing an entry

Handset

- 1 Press and hold the desired speed dial key (1 to 9). → [MENU]
- 2 [↕]: "Erase" → [SELECT]
- 3 [↕]: "Yes" → [SELECT]
- 4 [OFF]

Base unit

- 1 [SPEED DIAL]
- 2 [↕]: Select the desired entry. → [DETAIL]
- 3 [ERASE]
- 4 [↕]: "Yes" → [SELECT]
- 5 [EXIT]

Viewing an entry/Making a call

Handset

- **Using a mobile line:**
 - 1 Press and hold the desired speed dial key (1 to 9).
 - 2 [MOBILE]
 - The unit starts dialling when:
 - only 1 mobile phone is paired.
 - a specific line is set to make mobile calls (page 19).
 - 3 [↕]: Select the desired mobile phone. → [SELECT]

■ **Using a landline:**

- 1 Press and hold the desired speed dial key (1 to 9).
- 2 To make a call, press [↵].

Base unit

■ **Using a mobile line:**

- 1 [SPEED DIAL]
- 2 [↕]: Select the desired entry.
- 3 Press [MOBILE 1] or [MOBILE 2], then lift the corded handset.

■ **Using a landline:**

- 1 [SPEED DIAL]
- 2 [↕]: Select the desired entry.
- 3 Lift the corded handset.

Note for base unit:

- You can dial phone numbers in the speed dial while you are on a call.

One-touch dial buttons

You can store phone numbers or extension numbers to the base unit's one-touch dial buttons (1 to 3).

- phone numbers for outside calls
- extension numbers for handsets

Note:

- You can transfer a call to a handset. While you are on an outside call, press the one-touch dial button with an extension number stored. The line is put on hold and the base unit pages the handset. After the handset answers the page, place the corded handset on the cradle to complete the transfer.

Adding phone numbers for outside calls

Base unit

■ **By entering phone numbers:**

- 1 Press and hold the desired one-touch dial button (1 to 3). → [EDIT]
- 2 Enter the party's name (16 characters max.). → [OK]

Phonebook

3 Enter the party's phone number (24 digits max.). → **[OK]**

4 **[SELECT]** → **[EXIT]**

■ From the phonebook:

1 Press and hold the desired one-touch dial button (1 to 3).

2 **[□□]**

3 **[↕]**: Select the desired entry.

4 **[SAVE]** → **[EXIT]**

Note:

- If you edit a phonebook entry which is assigned to a one-touch dial button, the edited entry does not transfer to the one-touch dial button.

Adding extension numbers for handsets

Base unit

1 Press and hold the desired one-touch dial button (1 to 3). → **[EDIT]**

2 Press **[INT]**.

3 **[↕]**: Select the desired unit. → **[SELECT]** 2 times → **[EXIT]**

Viewing/editing/erasing an entry

Base unit

1 Press and hold the desired one-touch dial button (1 to 3).

- After viewing, press **[EXIT]** to exit.

2 **To edit an entry**

[EDIT] → Edit the name if necessary. →

[OK] → Edit the phone number if necessary.

→ **[OK]** → **[SELECT]** → **[EXIT]**

To erase an entry

[ERASE] → **[↕]**: "Yes" → **[SELECT]** →

[EXIT]

Making a call

Base unit

■ Using a mobile line:

1 Press **[MOBILE 1]** or **[MOBILE 2]**.

2 Press the desired one-touch dial button (1 to 3), then lift the corded handset.

■ Using a landline:

Press the desired one-touch dial button (1 to 3), then lift the corded handset.

Note:

- You can dial phone numbers in the one-touch dial while you are on a call.

Menu list

To access the features, there are 2 methods.

Handset / Base unit





■ Scrolling through the display menus

- 1 [MENU]
- 2 Press [▼] or [▲] to select the desired main menu. → [SELECT]
- 3 Press [▼] or [▲] to select the desired item from the next sub-menus. → [SELECT]
- 4 Press [▼] or [▲] to select the desired setting. → [SAVE]

■ Using the direct command code



- 1 [MENU] → Enter the desired code.
Example: Press [MENU]#101.
- 2 Select the desired setting. → [SAVE]

Note:



- The unit column shows the unit(s) that can be used to program the item.
 - : Only the handset can program the item.
 - : Only the base unit can program the item.
 - : Both the handset and base unit can program the item.
- To exit the operation, press [OFF] on the handset or [EXIT] on the base unit.
- In the following table, < > indicates the default settings.
- In the following table,  indicates the reference page number.
- Display menu order and sub-menu may vary depending on your model.

Display menu tree and direct command code table

Main menu: ☐☐ “Phonebook”

Operation	Code	Unit	
Viewing the phonebook entry.	#280	 	32





Main menu: →) “Caller list”

Operation	Code	Unit	
Viewing the caller list.	#213	 	50





















Main menu:

Handset: ☐☐ “Answering device”



Base unit: ☐☐  “Answering device”

Sub-menu 1	Sub-menu 2	Settings	Code	Unit	
Play new message	–	–	#323		59
Play all message	–	–	#324		59
Erase all message*1	–	–	#325		60

Programming

Sub-menu 1	Sub-menu 2	Settings	Code	Unit	👉
Greeting	Record greeting* ¹	-	#302	 	58
	Check greeting	-	#303	 	59
	Pre-recorded* ¹ (Reset to pre-recorded greeting)	-	#304	 	58
New message alert* ¹	Outgoing call - On/Off	On <Off>	#338	 	61
	Outgoing call - Notification to	-			
	Outgoing call - Remote code	Activate <Inactivate>			
	Base unit beep	On <Off>	#339	 	60
Settings	Ring count* ¹	2-9 rings <5 rings> Toll saver	#211	 	63
	Recording time* ¹	1 min <3 min> Greeting only* ²	#305	 	64
	Remote code* ¹	-	#306	 	62
	Screen call	<On> Off	#310	 	63
Answer on* ¹	-	-	#327		58
Answer off* ¹	-	-	#328		58

Main menu:  "Voicemail access"*³

















Operation	Code	Unit	👉
Listening to voicemail messages.	#330	 	65

Main menu:  "Intercom"











Operation	Code	Unit	👉
Paging the desired unit.	#274		27

Programming





Main menu:  "Bluetooth"

Sub-menu 1	Sub-menu 2	Settings	Code	Unit		
Link to mobile – 1: Add new device ^{*4} (for MOBILE 1) – 2: Add new device ^{*4} (for MOBILE 2)	Connect ^{*1} / Disconnect ^{*1}	–	#6251 ^{*5}		18	
			#6252 ^{*6}			
	Ringer volume	Off-6 <6>		#6281 ^{*5}		21, 25
				#6282 ^{*6}		
	Ringer tone ^{*7}	<Tone 2> ^{*5} <Tone 4> ^{*6}		#6291 ^{*5}		–
				#6292 ^{*6}		
	Select unit to ring ^{*1}	Handset 1-6 <All>		#6271 ^{*5}		17
				#6272 ^{*6}		
	Ring as mobile (limited) ^{*1}	<On (with Talking CID)> On (without Talking CID) Off		#6141 ^{*5}		17
				#6142 ^{*6}		
	Alert settings ^{*1} – Alert On/Off	<On> Off		#6101 ^{*5}		55
				#6102 ^{*6}		
	Alert settings ^{*1} – Voice alert	<On> Off		#6031 ^{*5}		55
				#6032 ^{*6}		
Alert settings ^{*8} – Alert tone	<Tone 1> ^{*5} <Tone 2> ^{*6}		#6041 ^{*5}		55	
			#6042 ^{*6}			
Pair	–		#6241 ^{*5}		16	
			#6242 ^{*6}			
Unpair	–		#6111 ^{*5}		16	
			#6112 ^{*6}			
Phonebook transfer	–	–	#618		53	
Headset	Add new device ^{*4}	–	#621		56	
	Connect ^{*1} / Disconnect ^{*1}	–	#622		56	
	Pair	–	#621		56	
	Unpair	–	#612		56	



Programming

Sub-menu 1	Sub-menu 2	Settings	Code	Unit	
Settings	Auto connect* ¹	<1 min> 3 min 5 min 10 min Off	#632		17
	Mobile area code* ¹	–	#633		19
	Mobile line only mode* ¹	On <Off>	#157		18
	Mobile line select (Handset)	<Manual> Mobile phone 1* ⁴ Mobile phone 2* ⁴	#634		19
	Mobile line select (Base unit)	<Mobile phone 1>* ⁴ Mobile phone 2* ⁴	#634		
	Set PIN* ¹	<0000>	#619		19
	International code* ¹	–	#117		53
	Country code* ¹	–	#118		
	Trunk prefix* ¹	–	#119		

Main menu: “Set date & time”































Sub-menu 1	Sub-menu 2	Settings	Code	Unit	
Date and time* ¹	–	–	#101		14
Memo alarm	Alarm1-3	Once Daily Weekly <Off>	#720		44
Time adjustment* ¹ , * ⁹	–	<Caller ID auto> Manual	#226		–

Main menu: “Speed dial”



















Operation	Code	Unit	
Viewing the speed dial entry.	#261		34

Programming









Main menu:  "Settings"

Sub-menu 1	Sub-menu 2	Settings	Code	Unit		
Ring adjustments	Ringer volume ^{*3}	Off-6 <6>	#160	 	-	
	Ringer tone ^{*3, *7}	<Tone 1>	#161		-	
	Interrupt tone ^{*10}	<On> Off	#201	 	23, 26	
	Do not disturb mode - On/Off	On <Off>	#238	 	45	
	Do not disturb mode - Start/End	<11:00 PM/06:00 AM>	#237	 	45	
	Do not disturb mode - Select group	Home Mobile 1 Mobile 2 Group 4-9	#241	 	45	
Set date & time	Date and time ^{*1}	-	#101	 	14	
	Memo alarm - Alarm1-3	Once Daily Weekly <Off>	#720		44	
	Time adjustment ^{*1, *9}	<Caller ID auto> Manual	#226	 	-	
Talking caller ID	-	<On> Off	#162	 	50	
Key finder settings ^{*11} - 1: Add new device (for Finder1) ^{*12} - 2: Add new device (for Finder2) - 3: Add new device (for Finder3) - 4: Add new device (for Finder4)	Change name ^{*1}	Finder1	#6561		-	
		Finder2 ^{*13}	#6562 ^{*13}			
		Finder3 ^{*13}	#6563 ^{*13}			
		Finder4 ^{*13}	#6564 ^{*13}			
	Registration	-	#6571	#6571		-
			#6572 ^{*13}	#6572 ^{*13}		
			#6573 ^{*13}	#6573 ^{*13}		
			#6574 ^{*13}	#6574 ^{*13}		
	Deregistration	-	#6581	#6581		-
			#6582 ^{*13}	#6582 ^{*13}		
			#6583 ^{*13}	#6583 ^{*13}		
			#6584 ^{*13}	#6584 ^{*13}		



Programming

Sub-menu 1	Sub-menu 2	Settings	Code	Unit	☞
Nuisance call block ^{*1}	Single number	–	#217		28
	Range of numbers	–			29
	Withheld (CID: Caller ID)	On <Off>	#240		29
	One ring for blocked call	<Yes> No	#173		29
One-touch dial	–	–	#247		35
Speed dial	–	–	#261		34
Record greeting ^{*1}	–	–	#302		58
Voice mail ^{*3}	Save VM access# ^{*1, *14} Save Voicemail access# ^{*1, *15}	–	#331		65
LCD contrast (Display contrast)	–	Handset: Level 1-4 <2> Base unit: Level 1-6 <3>	#145		–
Handset name	–	–	#104		47
Display name	–	On <Off>	#105		47
Auto intercom	–	On <Off>	#273		27
Key tone	–	<On> Off	#165		–
Landline area code ^{*1, *3}	–	–	#255		51
Auto talk ^{*16}	–	On <Off>	#200		21
Set tel line ^{*1, *3}	Set recall time ^{*17, *18}	900 ms 700 ms 600 ms 400 ms 300 ms 250 ms 200 ms 160 ms 110 ms <100 ms> 90 ms 80 ms	#121		21, 25
	Set line mode ^{*19}	A 	#122		–
Privacy mode ^{*1}	–	On <Off>	#194		22, 25

Programming

Sub-menu 1	Sub-menu 2	Settings	Code	Unit	👉
Repeater mode*1	–	On <Off>	#138	 	48
Registration	Register handset	–	#130		47
	Deregistration*2	–	#131		48
Deregistration*2	–	–	#131		48
Country*1	–	<Australia> NewZealand	#136	 	47
Battery saving mode	–	On <Off>	#150		11

Main menu: ☺ “Baby monitor”

Sub-menu 1	Sub-menu 2	Settings	Code	Unit	👉
On/Off	–	On <Off>	#268		45
Sensitivity level	–	Low <Middle> High	#269		46

Main menu: 🗉 “Key finder”*11

Sub-menu 1	Sub-menu 2	Settings	Code	Unit	👉
Search	–	–	#655		–
Battery check	–	–			

*1 If you program these settings using one of the units, you do not need to program the same item using another unit.

*2 This menu is not displayed when scrolling through the display menus. It is only available in direct command code.

*3 When the mobile line only mode is turned on, these menus are not displayed (page 18).

*4 After the Bluetooth device is paired, the device name is displayed.

*5 For MOBILE 1

*6 For MOBILE 2

*7 The preset melodies in this product (“Tone 3” - “Melody 10”) are used with permission of © 2009 Copyrights Vision Inc.

*8 The preset melodies in this product (“Tone 1” and “Tone 2”) are used with permission of © 2013 Copyrights Vision Inc.

*9 This feature allows the unit to automatically adjust the date and time each time caller information including date and time is received.

To turn this feature on, select “Caller ID auto”. To turn this feature off, select “Manual”. (Caller ID subscribers only)

To use this feature, set the date and time first (page 14).

*10 This tone lets you know when you receive an outside call while you are on another line or an intercom call. If you select “On”, the tone sounds 2 times.

*11 This setting is available when you have the key finder (KX-TGA20AZ). Read the installation manual for more information on the key finder.

*12 For models with supplied key finders, the display shows “1: Finder1”.

*13 If you register 2 or more key finders.

*14 Handset

*15 Base unit

Programming

- *16 If you subscribe to a Caller ID service and want to view the caller's information after lifting up the handset to answer a call, turn off this feature.
- *17 The recall time depends on your telephone exchange or host PBX. Contact your PBX supplier if necessary.
You can access your phone service provider "call waiting" service by having the recall time set at "100 ms", and then follow your phone service provider "call waiting" instructions to operate this service. (for Australia)
- *18 The default setting will be as follows if you select the following regional codes when changing the unit's region setting (page 47):
"NewZealand" = "600 ms"
- *19 Generally, the line mode setting should not be changed. This setting automatically maintains receiver volume at the proper level depending on the current telephone line condition. Set the line mode to "A" if telephone line condition is not good.

Alarm

An alarm sounds at the set time for 1 minute and is repeated 5 times at 5 minute intervals (snooze function). A text memo can also be displayed for the alarm. A total of 3 separate alarm times can be programmed for each handset. You can set one of 3 different alarm options (once, daily, or weekly) for each alarm time.

Important:

- Make sure the unit's date and time setting is correct (page 14).

Handset

- 1 [MENU]#720
- 2 [↕]: Select the desired alarm. → [SELECT]
- 3 [↕]: Select the desired alarm option. → [SELECT]

"Off"	Turns alarm off. Go to step 10.
"Once"	An alarm sounds once at the set time.
"Daily"	An alarm sounds daily at the set time. Go to step 5.
"Weekly"	Alarm sounds weekly at the set time(s).

- 4 Proceed with the operation according to your selection in step 3.
 - **Once:**
Enter the desired date and month. → [OK]

Weekly:

[↕]: Select the desired day of the week and press [SELECT]. → [OK]

- 5 Set the desired time.
- 6 [X]: Select "AM" or "PM". → [OK]
- 7 Enter a text memo (10 characters max.). → [OK]
- 8 [↕]: Select the desired alarm tone. → [SELECT]
 - We recommend selecting a different ringer tone from the one used for outside calls.
- 9 [↕]: Select the desired snooze setting. → [SAVE]
- 10 [SELECT] → [OFF]

Note:

- Press [STOP] to stop the alarm completely.
- When the handset is in use, the alarm will not sound until the handset is in standby mode.
- Press any dial key or [SNOOZE] to stop the sound but keep the snooze function activated.
- If you want to make an outside call when the snooze function is activated, please stop the snooze function before making the call.

Do not disturb mode

Do not disturb mode allows you to select a period of time during which the handset and/or base unit will not ring for outside calls. This feature is useful for time periods when you do not want to be disturbed, for example, while sleeping. Do not disturb mode can be set for each unit. Using the phonebook's group feature (page 32), you can also select groups of callers whose calls

override do not disturb mode and ring the unit (Caller ID subscribers only).

Important:

- Make sure the unit's date and time setting is correct (page 14).
- If you have set the alarm, the alarm sounds even if the do not disturb mode is turned on.

Turning do not disturb mode on/off

Handset

- 1 [MENU][#][2][3][8]
- 2 [↕]: Select the desired setting. → [SAVE]
 - If you select "OFF", press [OFF] to exit.
- 3 Enter the desired hour and minute you wish to start this feature.
- 4 [X]: Select "AM" or "PM". → [OK]
- 5 Enter the desired hour and minute you wish to end this feature.
- 6 [X]: Select "AM" or "PM".
- 7 [SAVE] → [OFF]

Base unit

- 1 [MENU][#][2][3][8]
- 2 [↕]: Select the desired setting. → [SAVE]
 - If you select "OFF", press [EXIT] to exit.
- 3 Enter the desired hour and minute you wish to start this feature.
- 4 [AM/PM]: Select "AM" or "PM". → [OK]
- 5 Enter the desired hour and minute you wish to end this feature.
- 6 [AM/PM]: Select "AM" or "PM".
- 7 [SAVE] → [EXIT]

Changing the start and end time

Handset / Base unit

- 1 [MENU][#][2][3][7]
- 2 Continue from step 3 for handset or step 3 for base unit, "Turning do not disturb mode on/off", page 45.

Selecting groups to bypass do not disturb mode

Handset / Base unit

- 1 [MENU][#][2][4][1]
- 2 [↕]: Select the desired group. → [SELECT]
 - "✓" is displayed next to the selected group numbers.

- To cancel the selected group: [↕]: Select the group. → Press [SELECT] again. "✓" disappears.

3 [SAVE]

4 Proceed with the operation for your unit.

Handset: [OFF]

Base unit: [EXIT]

Baby monitor

This feature allows you to listen in on a room where another handset is located, allowing you to easily monitor from different areas of the house or place. The monitored handset (placed in a baby's room, for example) will automatically call the monitoring handset, base unit, or the phone number stored when it detects sound.

Important:

- You should perform a test run of the baby monitor procedure to ensure that the baby monitor feature is set correctly. For example, test its sensitivity. Check the connection if you are diverting the baby monitor to an outside line.
- This feature should not be used as a substitute for a medical or caregiver's supervision. It is the caregiver's responsibility to stay close enough to handle any eventuality.

Note:

- If the unit is connected to a PBX system, you cannot set the baby monitor.
- During the monitoring mode, battery consumption is faster than usual. We recommend leaving the monitored handset on charger.
- The monitored handset never rings while it is being monitored. If the base unit is placed near the monitored handset, we recommend turning off the base unit ringer volume (page 39, 41)

Setting the baby monitor

Perform the setting operation with the handset to be monitored (for example, the handset placed in a baby's room).

To monitor with a unit

The internal baby monitor feature is available:

- between handsets
- between a handset and the base unit

Programming

Handset

- 1 [MENU]#268
- 2 [↕]: "On" → [SELECT]
- 3 [↕]: Select the desired unit's number to monitor with. → [SAVE]
 - "Baby monitor" will be displayed.
 - The registered unit's name/number is displayed.

Note:

- When this feature is on, another handset or the base unit can hear the monitored handset by making an intercom call.

To monitor from an outside line

If you enable this feature, the unit will call a pre-programmed phone number when the handset detects sound. After you answer the call, you can listen in on the room where the handset is located. This feature is only available for landline.

Handset

■ From the phonebook:

- 1 [MENU]#268
- 2 [↕]: "On" → [SELECT]
- 3 [↕]: Select "Outgoing call" to monitor from an outside line. → [EDIT] → [ADD]
- 4 [↕]: "Phonebook" → [SELECT]
- 5 [↕]: Select the phonebook entry. → [SAVE]
 - "Baby monitor" will be displayed.

Note:

- If you edit a phonebook entry which is assigned for monitoring, the edited entry does not transfer to the monitor.

■ By entering phone numbers:

- 1 [MENU]#268
- 2 [↕]: "On" → [SELECT]
- 3 [↕]: Select "Outgoing call" to monitor from an outside line. → [EDIT] → [ADD]
- 4 [↕]: "Manual" → [SELECT]
- 5 Enter the desired name. → [OK]
- 6 Enter the desired number. → [OK] → [SELECT]
 - "Baby monitor" will be displayed.

Note:

- The registered name/number is displayed.

Turning off the baby monitor

The monitored handset cannot be used while baby monitor is set to "On".

Handset

- 1 Press [MENU] on the handset being monitored.
- 2 [↕]: "On/Off" → [SELECT]
- 3 [↕]: "Off" → [SELECT] → [OFF]

Editing an outside monitoring number

Handset

- 1 Press [MENU] on the handset being monitored.
- 2 [↕]: "On/Off" → [SELECT]
- 3 [↕]: "On" → [SELECT]
- 4 [↕]: Select the outside line. → [EDIT]
- 5 [MENU] → [↕]: "Edit" → [SELECT]
- 6 Edit the name if necessary. → [OK]
- 7 Edit the phone number if necessary. → [OK] → [SELECT]

Erasing an outside monitoring number

Handset

- 1 Press [MENU] on the handset being monitored.
- 2 [↕]: "On/Off" → [SELECT]
- 3 [↕]: "On" → [SELECT]
- 4 [↕]: Select the outside line. → [EDIT]
- 5 [MENU] → [↕]: "Erase" → [SELECT]
- 6 [↕]: "Yes" → [SELECT] → [OFF]

Baby monitor sensitivity

You can adjust the sensitivity of the baby monitor. Increase or decrease the sensitivity to adjust the sound level needed to trigger the baby monitor feature.

- This feature cannot be set during a monitoring call.

Handset

- 1 Press [MENU] on the handset being monitored.
- 2 [↕]: "Sensitivity level" → [SELECT]
- 3 [↕]: Select the desired setting. → [SAVE] → [OFF]

Answering the baby monitor

Handset / Base unit

■ When monitoring with a unit:

Handset: Press [📞] to answer a call.

Base unit: Press [📞] to answer a call.

If you want to respond from the monitoring unit, press [MUTE].

- The monitoring unit will answer calls automatically when the auto intercom feature is set to “on” (page 27).

Note:

- If you receive an outside call when communicating with the monitored handset, the interrupt tone sounds.
 - To answer the call with the handset, press [OFF], then press [📞].
 - To answer the call with the base unit, press [📞] 3 times.*1

*1 If [MUTE] is pressed, press [📞] 2 times.

■ When monitoring from an outside line:

Answer the call.

If you want to respond from your monitoring phone, press [#]1 using tone dialling.

You can turn off the baby monitor feature by pressing [#]0.

Note:

- The unit disconnects the call automatically after 2 minutes.

Other programming

Changing the handset name

The default handset name is “Handset 1” to “Handset 6”. You can customize the name of each handset (“Bob”, “Kitchen”, etc.). This is useful when you make intercom calls between handsets. To display the handset name in standby mode, turn on the handset name display feature (page 47).

Handset

- 1 [MENU][#]104
- 2 Enter the desired name (max. 10 characters).
- 3 [SAVE] → [OFF]

Displaying the handset name

You can select whether or not the handset name is displayed in standby mode. The default setting is “off”.

Handset

- 1 [MENU][#]105
- 2 [↕]: Select the desired setting. → [SAVE] → [OFF]

Changing the unit’s region setting/ Resetting the base unit

- 1 [MENU][#]136
- 2 [↕]: Select the desired country. → [SELECT]
“Australia” = Australia
“NewZealand” = New Zealand
- 3 [↕]: “Yes” → [SELECT] → [OFF]

Note:

- Changing the unit’s region setting may cause the settings for your country or your customised settings to return to their default settings.

Registering a unit

Operating additional units

Additional handsets

Up to 6 handsets can be registered to the base unit.

Important:

- See page 4 for information on the available model.

Registering a handset to the base unit

The supplied handset and base unit are pre-registered. If for some reason the handset is not registered to the base unit, re-register the handset.

- 1 **Handset:**
[MENU][#]130
- 2 **Base unit:**
Press and hold [LOCATOR] for about 5 seconds.

Programming

- If all registered handsets start ringing, press **[LOCATOR]** again to stop, then repeat this step.

3 Handset:

Press **[OK]**, then wait until a long beep sounds.

Deregistering a handset

A handset can cancel its own registration to the base unit, or other handsets registered to the same base unit. This allows the handset to end its wireless connection with the system.

Handset / Base unit

- 1 **[MENU][#][1][3][1]**
 - All handsets registered to the base unit are displayed.
- 2 **[↕]**: Select the handset you want to cancel.
→ **[SELECT]**
- 3 **[↕]**: “Yes” → **[SELECT]**
- 4 Proceed with the operation for your unit.
Handset: [OFF]
Base unit: [EXIT]

Increasing the range of the base unit

You can increase the signal range of the base unit by using a DECT repeater. Please use only the Panasonic DECT repeater noted on page 4. Contact your Panasonic dealer for details.

Important:

- Before registering the repeater to this base unit, you must turn the repeater mode on.
- Do not use more than one repeater at a time.

Setting the repeater mode

Handset / Base unit

- 1 **[MENU][#][1][3][8]**
- 2 **[↕]**: Select the desired setting. → **[SAVE]**
→ **[OFF]**

Note:

- After turning the repeater mode on or off, **Y** may be displayed on the handset momentarily. This is normal and the handset can be used once **Y** is displayed.

Registering the DECT repeater (KX-A405/ KX-A406) to the base unit

Note:

- Please use a repeater that has not yet been registered to another unit. If the repeater is registered to another unit, deregister it first, referring to the Installation Guide for the DECT repeater.

1 Base unit:

Press and hold **[LOCATOR]** for about 5 seconds until the registration tone sounds.

- The next step must be completed within 90 seconds.

2 DECT repeater:

Connect the AC adaptor, then wait until the **i** indicator and **Y** indicator light green.

3 Base unit:

To exit the registration mode, press **[LOCATOR]**.

- The registration tone stops.

Using Caller ID service

Important:

- This unit is Caller ID compatible. To use Caller ID features (such as displaying caller phone numbers), you must subscribe to a Caller ID service. Contact your phone service provider for details.

For New Zealand

- For all local and national incoming calls, your display will show the area code (e.g. 09 for Auckland) or the mobile prefix (e.g. 027 for Telecom Mobile) followed by the caller's telephone number. An Auckland caller's number will be displayed as 09XXXXXXX. The seven X's represent the seven digits of the caller's telephone number. A caller from a 7-digit Telecom Mobile number will be displayed as 027XXXXXXX. For incoming international calls, your display may only show "0000". For business users on a Centrex line, your display will show Centrex extension numbers in the shorter extension number format used within your company.
- The Caller ID information will not be presented on incoming fax calls if Telecom FaxAbility is used.

Using toll services from Telecom or another company (for New Zealand)

Your telephone company may charge you for a local call if the number dialled has the area code prefix included. If this is unacceptable, dial only the 7-digit local number. Do not dial the "0" prefix or the area code.

Caller ID features

Handset / Base unit

When an outside call is being received, the caller information is displayed.

Caller information for the last 50 callers is logged in the caller list from the most recent call to the oldest.

- If the unit cannot receive caller information, the following is displayed:
 - "Out of area": The caller dials from an area which does not provide a Caller ID service.
 - "Private caller": The caller requests not to send caller information.

- If the unit is connected to a PBX system, caller information may not be properly received. Contact your PBX supplier.

Missed calls

Handset / Base unit

If a call is not answered, the unit treats it as a missed call. The display shows "Missed call".

Note:

- Even when there are unviewed missed calls, "Missed call" disappears from the standby display if the following operation is performed by one of the units:
 - A handset is replaced on the charger.
 - Pressing **[OFF]** on a handset.
 - Pressing **[EXIT]** on the base unit.

Phonebook name display

When caller information is received and it matches a phone number stored in the phonebook, the stored name in the phonebook is displayed and logged in the caller list.

Call waiting and Caller ID compatible (for Australia)

Handset / Base unit

If you subscribe to Caller ID service, your base unit or handset displays the 2nd caller's information while talking. After you hear a call waiting tone, the caller's phone number will be displayed.

You can answer the 2nd call, keeping the 1st call on hold. Follow your phone service provider instructions using **[CALL WAIT]**. (Recall function)

- If the phone number is stored in the phonebook with its name, the caller's name will also be displayed.
- Please contact your phone service provider for details and availability in your area.

For Caller ID Type II users

When you receive a 2nd call during a conversation, you will hear a signal tone following the call waiting tone and the **conversation will be interrupted or muted for a short period of time**. This is not a fault of the product as these events are normal.

- The tones are generated by your phone service provider.

Caller ID Service

For Call Waiting or Call Waiting Caller ID service users (for New Zealand)

To use call waiting or Call Waiting Caller ID, you must first subscribe with your phone service provider. This feature allows you to receive calls while you are already talking on the phone. If you receive a call while on the phone, you will hear a call waiting tone. **If you subscribe to both Caller ID and Call Waiting with Caller ID services**, the 2nd caller's information is displayed on the base unit or handset that is in use after you hear the call waiting tone.

Handset / Base unit

- 1 Press **[CALL WAIT]** to answer the 2nd call.
- 2 To switch between calls, press **[CALL WAIT]**.

Note:

- Please contact your phone service provider for details and availability of this service in your area.

Talking Caller ID

Handset / Base unit

This feature let you know who is calling by announcing the caller information.

To use this feature, you must:

- subscribe to a Caller ID service of your phone service provider.
- turn this feature on (page 41).
- store the name and phone number in the phonebook (page 31).

Phonebook name announcement

When caller information is received from your phone service provider and it matches a phone number stored in the phonebook, the stored name is announced following every ring.

If that phone number has not been stored in the phonebook, the caller information is announced.

Note:

- Name pronunciation may vary. This feature may not pronounce all names correctly.

Caller list

Important:

- Make sure the unit's date and time setting is correct (page 14).

Viewing the caller list and calling back

■ Using a mobile line

Handset

- 1 **[▼]** CID
- 2 Press **[▼]** to search from the most recent call, or **[▲]** to search from the oldest call.
- 3 To call back, press **[SELECT]**.
To exit, press **[OFF]**.
- 4 **[MOBILE]**
 - The unit starts dialling when:
 - only 1 mobile phone is paired.
 - a specific line is set to make mobile calls (page 19).
- 5 **[↕]**: Select the desired mobile phone. → **[SELECT]**

Base unit

- 1 **[CID]**
- 2 Press **[▼]** to search from the most recent call, or **[▲]** to search from the oldest call.
- 3 To call back, press **[MOBILE 1]** or **[MOBILE 2]**, then lift the corded handset.
To exit, press **[EXIT]**.

■ Using a landline

Handset / Base unit

- 1 Proceed with the operation for your unit.
Handset: **[▼]** CID
Base unit: **[CID]**
- 2 Press **[▼]** to search from the most recent call, or **[▲]** to search from the oldest call.
- 3 Proceed with the operation for your unit.
Handset:
 - To call back, press **[↩]**.
 - To exit, press **[OFF]**.**Base unit:**
 - To call back, lift the corded handset.
 - To exit, press **[EXIT]**.

Note for handset and base unit:

- If the entry has already been viewed or answered, “✓” is displayed.
- **[1]** or **[2]** indicates the caller information was received from the mobile line.
- If you do not want to dial the area code when making calls from the caller list, you can store the area code which you want the unit to delete automatically (page 51).

Storing an area code to be deleted automatically (for landline call)

In some situations, phone numbers stored automatically in the caller list (page 50) will include area codes. If you do not want to dial the area code when making landline calls from the caller list, you can store the area code which you want the unit to delete automatically.

Example: You have stored the area code “09”. If you make a landline call from the caller list to the phone number “09-456-7890”, the unit dials “456-7890”.

Handset

- 1 **[MENU]****[#]****[2]****[5]****[5]**
- 2 Enter an area code (5 digits max.). → **[SAVE]** → **[OFF]**

Note:

- This feature does not affect a voicemail access number with an area code (page 65).

Note for New Zealand:

- The use of this feature can prevent a National Call from being dialled. E.g., in the case of the South Island, the “03” will be omitted and will therefore prevent a National Call to other areas of the South Island.

To erase your area code

Handset

- 1 **[MENU]****[#]****[2]****[5]****[5]**
- 2 Press and hold **[CLEAR]** until all digits erased. → **[SAVE]** → **[OFF]**

Editing a caller’s phone number

The caller’s telephone number, which is sent to your telephone from your local telephone exchange, includes “0” and an area code prefix.

For local calls, “0” and the area code prefix can be omitted. (for New Zealand)

Handset

■ When a mobile phone is paired:

- 1 **[▼]** CID
- 2 **[↕]**: Select the desired entry. → **[SELECT]**
- 3 Add or erase digits to the beginning of the number as necessary.
 - To add a digit, press the desired dial key.
 - To erase a digit, press **[CLEAR]**.
- 4 **Using a mobile line:**
To make a mobile call, continue from step 4, “Viewing the caller list and calling back”, page 50.
Using a landline:
[↶]

■ When a mobile phone is not paired:

- 1 **[▼]** CID
- 2 **[↕]**: Select the desired entry. → **[MENU]**
- 3 **[↕]**: “Edit” → **[SELECT]**
- 4 Add or erase digits to the beginning of the number as necessary.
 - To add a digit, press the desired dial key.
 - To erase a digit, press **[CLEAR]**.
- 5 **[↶]**

Base unit

- 1 **[CID]**
- 2 **[↕]**: Select the desired entry.
- 3 **[EDIT]** → Add or erase digits to the beginning of the number as necessary.
 - To add a digit, press the desired dial key.
 - To erase a digit, press **[CLEAR]**.
- 4 **Using a mobile line:**
Press **[MOBILE 1]** or **[MOBILE 2]**, then lift the corded handset.
Using a landline:
Lift the corded handset.

Note for handset and base unit:

- The edited phone number is not saved in the caller list.

Caller ID Service

Erasing selected caller information

Handset

- When a mobile phone is paired:
 - 1 [▼] CID
 - 2 [↕]: Select the desired entry.
 - 3 [MENU] → [↕]: "Erase" → [SELECT]
 - 4 [↕]: "Yes" → [SELECT]
 - 5 [OFF]
- When a mobile phone is not paired:
 - 1 [▼] CID
 - 2 [↕]: Select the desired entry.
 - 3 [ERASE] → [↕]: "Yes" → [SELECT]
 - 4 [OFF]

Base unit

- 1 [CID]
- 2 [↕]: Select the desired entry.
- 3 [ERASE] → [↕]: "Yes" → [SELECT]
- 4 [EXIT]

Erasing all caller information

Handset / Base unit

- 1 Proceed with the operation for your unit.
Handset: [▼] CID
Base unit: [CID]
- 2 [ERASE] → [↕]: "Yes" → [SELECT]
- 3 Proceed with the operation for your unit.
Handset: [OFF]
Base unit: [EXIT]

Copying phonebook from a mobile phone (phonebook transfer)

You can copy phonebook entries from the paired mobile phones or other mobile phones (not paired) to the unit's phonebook. A mobile phone must be compatible with Bluetooth wireless technology.

Important:

- Your mobile phone must support Phone Book Access Profile (PBAP) or Object Push Profile (OPP) specification.
- If a copied entry has 2 or more phone numbers, each phone number (6 max.) is stored as a separate entry with the same name.
- If a phonebook entry includes additional data such as a picture, that entry may fail to copy to the base unit.
- If your mobile phone includes international call entries, set the conversion codes before copying (page 53).

Handset / Base unit

- 1 **[MENU]** **#** **6** **1** **8**
- 2 **To copy from paired mobile phones:**
[↕]: Select the desired mobile phone. →
[SELECT]
 - Copied items are stored to the group ("Mobile 1" or "Mobile 2") which the mobile phone is paired to.**To copy from other mobile phones (not paired):**
[↕]: "Other mobile" → **[SELECT]** →
[↕]: Select the group you want to copy to. →
[SELECT]
- 3 **When "Use the mobile to transfer phone book" is displayed:**
 Go to step 4.
When "Select mode" menu is displayed:
[↕]: Select "Auto" or "Manual". →
[SELECT]
 "Auto": Download all entries from the mobile phone automatically. Go to step 5.
 "Manual": Copy entries you selected.
 - "Select mode" menu is displayed only when the mobile phone supports PBAP (Phone Book Access Profile) for Bluetooth connection.

- Some mobile phones may require you to perform an operation on the mobile phone even if you select "Auto".

4 Mobile phone:

Follow the instructions of your mobile phone to copy phonebook entries.

- For other mobile phones (not paired), you need to search for and select the base unit. The Bluetooth PIN (default: "0000") may be required. If your mobile phone shows PassKey confirmation on its display, follow the directions to proceed.
- The entries being copied are displayed on the unit.

5 Wait until "Completed" is displayed.

6 Proceed with the operation for your unit.

Handset: **[OFF]**

Base unit: **[EXIT]**

Note:

- Some copied entries may have characters which do not exist in the character table (page 31). These characters can be displayed but cannot be entered when editing an entry.
- The unit does not support some characters. If a copied entry includes those characters, they are replaced with other available characters or "*".
- If you receive a call while copying phonebook entries, the copying procedure stops. Try again after finishing the call.

Setting conversion codes

You must first set the following 3 dialling codes in the base unit which you want to copy to before transferring the phonebook from your mobile phone (each 4 digits max.).

- "International code": An international prefix used when you make an international call.
- "Country code": Your country code for international calls.
- "Trunk prefix": A trunk prefix; the initial digit(s) to be dialled in a domestic call, prior to the area code.

You can configure this setting using either the base unit or one of the handsets.

Handset / Base unit

- 1 **[MENU]**
- 2 To store "International code":
**1** **1** **7**
 To store "Country code": **#** **1** **1** **8**

Using Bluetooth® Devices

To store “Trunk prefix”: # [1] [1] [9]

- 3 Enter the desired number. → [SAVE]
- 4 Proceed with the operation for your unit.
Handset: [OFF]
Base unit: [EXIT]

Note:

- After you copy the entries, confirm that the numbers were transferred correctly.

Link to Mobile app

For Android users

The free Link to Mobile app helps you integrate your Android phone with your DECT phone for convenient use.

Important:

- Your mobile phone must support SPP (Serial Port Profile) specification.
- **Application (App) Alerts On/Off**
This feature alerts your DECT phone when your paired Android phone receives the following alert information:
- [Google Calendar]™
 - [Email]
 - [Gmail]™
 - [Text messages]
 - [Facebook]
 - [Twitter]
 - [Instagram]
 - [Low Battery] information
- You can turn each type of alert on or off using the Link to Mobile app. If you turn the alerting app on, your DECT phone alerts you with the corresponding information.

■ Phone Settings

Using your paired Android phone, you can program your Phone Settings for the following features:

- [Time adjustment]*1
- [Cell line only mode] (page 18)
- [International code], [Country code], and [Trunk prefix] (page 53)

- *1 When your paired Android phone is within the base unit's range, the date and time information is updated on the handset and base unit's display, if time adjustment feature is activated on your Android phone.

Installing the Link to Mobile app

Download links are also available at the web page below.



www.panasonic.net/pcc/support/tel/appalerts

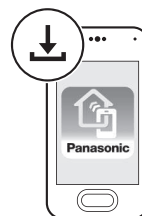

Starting the app for the first time

- 1 Make sure that your Android device's Bluetooth feature is turned on and that your Android device is paired to the base unit.
- 2 Start the Link to Mobile app by tapping its icon.
- 3 Follow the on-screen instructions.

Important:

- For further information, refer to the instructions on web page listed above.
- To use this feature, the following settings are required.
 - **Android phone:** Bluetooth must be turned on.
 - **Android phone:** [Application Alerts manager]*1 must be turned on.
 - **Handset or base unit:** “Alert On/Off” must be turned on (page 55).
- If this feature does not work, turn on your device's Bluetooth feature, unplug the base unit's AC adaptor, and then reconnect it.

- *1 **Turning on [Application Alerts manager]**
Use the following procedure after installing the Link to Mobile app.
Android 2.x: Open your device's [Settings] app. → Tap [Accessibility]. → Turn on the [Accessibility] and [Application Alerts manager] checkboxes.
Android 4.x: Open your device's [Settings] app. → Tap [Accessibility]. → Turn on [Application Alerts manager].

Requirements

- An Android device (Android 2.1 or later)

Text message (SMS) alert

For iPhone and BlackBerry® users

This feature alerts you on your DECT phone when your paired mobile phone receives SMS messages. The Link to Mobile app is not required for **iPhone and BlackBerry users**.

Important:

- Your mobile phone must support MAP (Message Access Profile) specification.
- For further information, refer to the instructions on web page listed below:
www.panasonic.net/pcc/support/tel/sms/
- To use this feature, the following settings are required.
 - **iPhone and BlackBerry Phone:** Bluetooth must be turned on.
 - **Handset or base unit:** “Alert On/Off” must be turned on (page 55).
- If this feature does not work, turn on your device’s Bluetooth feature, unplug the base unit’s AC adaptor, and then reconnect it.

Alert settings for your DECT phone

If your mobile phone is paired to the base unit and receives notifications, the handset and/or base unit can alert you:

- by briefly displaying a message
- by sounding alert tones

Important:

- For Android users: Use the Link to Mobile app to enable the desired alerts (page 54).

Turning alert on/off

Once this feature is turned on, it will alert you on the handset and base unit when your mobile phone receives notifications.

- “On” (default): The handset and/or base unit alert you.
- “Off”: The handset and/or base unit do not alert you.

You can configure this setting using either the base unit or one of the handsets.

Handset / Base unit

- 1 For MOBILE 1: **[MENU]#6101**
For MOBILE 2: **[MENU]#6102**
- 2 **[↕]**: Select the desired setting. → **[SAVE]**
- 3 Proceed with the operation for your unit.
Handset: [OFF]
Base unit: [EXIT]

Setting the voice alert

You can turn on/off the voice alert.

- “on” (default): The handset and/or base unit notify you by voice announcement.
- “off”: Voice announcement is not available as alert.

You can configure this setting using either the base unit or one of the handsets.

Handset / Base unit

- 1 For MOBILE 1: **[MENU]#6031**
For MOBILE 2: **[MENU]#6032**
- 2 **[↕]**: Select the desired setting. → **[SAVE]**
- 3 Proceed with the operation for your unit.
Handset: [OFF]
Base unit: [EXIT]

Selecting the alert tone

Handset

- 1 For MOBILE 1: **[MENU]#6041**
For MOBILE 2: **[MENU]#6042**
- 2 **[↕]**: Select the desired setting.
- 3 **[SAVE]** → **[OFF]**

Using a Bluetooth wireless headset (optional) for landline calls

By pairing a Bluetooth headset to the base unit, you can have a hands-free conversation wirelessly for landline calls.

Important:

- Your Bluetooth wireless headset must support the HeadSet Profile (HSP) specification.
- 1 headset can be paired to the base unit.

Using Bluetooth® Devices

- Only 2 Bluetooth devices can be used with the unit at the same time (for example, 2 mobile lines, or the headset and 1 mobile line).
- For best performance, we recommend using a Bluetooth headset within 1 m of the base unit. A headset can communicate with the base unit within a range of approximately 10 m.

Pairing a headset to the base unit

Important:

- Make sure that the Bluetooth headset is not connected to any other Bluetooth device.

Handset / Base unit

- 1 Your headset:**
Set your headset to pairing mode.
 - Refer to the headset operating instructions.
- 2 [MENU]# [6] [2] [1]**
- 3 If your headset PIN is "0000", go to step 4. If your headset PIN is other than "0000",** press **[CLEAR]**, then enter your headset PIN.
 - Typically, default PIN is "0000". Refer to the headset operating instructions.
- 4 Press [OK],** then wait until a long beep sounds.
- 5 Proceed with the operation for your unit.**
Handset: [OFF]
Base unit: [EXIT]
 - When **[QC]** is displayed on the base unit, the headset is available for use.

Connecting/disconnecting a headset

If you cannot connect the headset and base unit using the headset, you can connect using the unit. To use your headset with another Bluetooth device such as a mobile phone, you may need to disconnect it from the base unit. You can configure this setting using either the base unit or one of the handsets.

Important:

- Make sure that the headset is turned on.

Handset / Base unit

- 1 To connect/disconnect:**
[MENU]# [6] [2] [2]
 - A long beep sounds.
- 2 Proceed with the operation for your unit.**
Handset: [OFF]
Base unit: [EXIT]

Unpairing a headset

You can cancel a pairing of the headset that is stored to the base unit.

Handset / Base unit

- 1 [MENU]# [6] [1] [2]**
- 2 [↕]: "Yes" → [SELECT]**
 - When the headset is unpaired, the **[QC]** disappears from the base unit display.
- 3 Proceed with the operation for your unit.**
Handset: [OFF]
Base unit: [EXIT]

Operating a Bluetooth wireless headset using a landline

Important:

- Refer to your headset operating instructions for headset operations.

Answering landline calls with your headset

To answer a landline call, press your headset's button referring to your headset operating instructions.

When you finish talking, press your headset's button referring to your headset operating instructions.

Note:

- If you cannot hang up the call using your headset, press **[⏏]** on the base unit 2 times.

Switching between the base unit and your headset

You can switch between the base unit and your headset:

- during a landline call with the base unit.
- during an intercom call between the base unit and headset.
- while listening to messages recorded on the base unit answering system.

■ To switch to your headset:

Press **[☎]** on the base unit.

■ To switch to the base unit:

Lift the corded headset to talk with the corded headset.

or

Press **[⏏]** to talk with the speakerphone.

Call sharing between your headset and the handset

Important:

- To activate this feature, you should set privacy mode to off beforehand (page 42).

■ **While the handset is on a landline call:**

To join the conversation with your headset, press your headset's button referring to your headset operating instructions.

■ **While your headset is on a landline call:**

To join the conversation with the handset, press .

Adjusting your headset receiver volume

Base unit

Press **[▲]** or **[▼]** repeatedly while using your headset.

Note:

- Depending on your headset, the receiver volume may not be adjustable.

Answering System for Landline

Answering system for landline

The answering system can answer and record calls for you when you are unavailable to answer the phone.

You can also set the unit to play a greeting message but not to record caller messages by selecting “**Greeting only**” as the recording time setting (page 64).

Important:

- Make sure the date and time setting is correct (page 14).
- The unit’s answering system will not answer incoming calls on your FaxAbility number. (for New Zealand)

Memory capacity (including your greeting message)

The total recording capacity is about 18 minutes. A maximum of 64 messages can be recorded.

Note:

- When message memory becomes full:
 - “**Messages full**” is shown on the handset and base unit display.
 - **CO** on the base unit flashes rapidly if the answering system is turned on.
 - If you use the pre-recorded greeting message, the unit automatically switches to another pre-recorded greeting message asking callers to call again later.
 - If you recorded your own greeting message, the same message is still announced to callers even though their messages are not recorded.

Turning the answering system on/off

Base unit

Press **[CO]** to turn on/off the answering system.

Handset

- 1 To turn on:
[MENU]#327
To turn off:

[MENU]#328

- 2 **[OFF]**

Note for base unit and handset:

- When the answering system is turned on, **CO** on the base unit lights up.

Greeting message

When the unit answers a call, a greeting message is played to callers.

You can use either:

- your own greeting message
- a pre-recorded greeting message

Recording your greeting message

You can configure this setting using either the base unit or one of the handsets.

Handset / Base unit

- 1 **[MENU]#302**
- 2 **[↓]: “Yes” → [SELECT]**
- 3 After a beep sounds, speak clearly about 20 cm away from the microphone (2 minutes and 30 seconds max.).
- 4 Press **[STOP]** to stop recording.
- 5 Proceed with the operation for your unit.
Handset: [OFF]
Base unit: [EXIT]

Using a pre-recorded greeting message

The unit provides 2 pre-recorded greeting messages:

- If you reset to pre-recorded greeting or do not record your own greeting message, the unit plays a pre-recorded greeting asking callers to leave a message.
- If the message recording time (page 64) is set to “**Greeting only**”, callers’ messages are not recorded and the unit plays a different pre-recorded greeting message asking callers to call again.

Resetting to a pre-recorded greeting message

If you change into a pre-recorded greeting message once you record your own greeting

Answering System for Landline

message, your own recorded greeting message is erased.

You can configure this setting using either the base unit or one of the handsets.

Handset / Base unit

- 1 **[MENU]** **#** **3** **0** **4**
- 2 **[YES]**
- 3 Proceed with the operation for your unit.
Handset: **[OFF]**
Base unit: **[EXIT]**

Playing back the greeting message

Handset / Base unit

- 1 **[MENU]** **#** **3** **0** **3**
- 2 Proceed with the operation for your unit.
Handset: To exit, press **[OFF]**.
Base unit: To exit, press **[EXIT]**.

Listening to messages

Important:

- If your phone service provider offers voicemail service, the voicemail service may answer calls before the base unit's built-in answering system has a chance to answer calls and record messages.
In this case, messages you expect to be recorded by the answering system will be recorded on the voicemail service. For more information, see "For service provider voicemail subscribers (for Australia)" (page 64).
- When using the base unit or handset to listen to messages, the noise reduction feature (page 21) is activated automatically in spite of the setting (**NR** is not displayed).

Using the base unit

When new messages have been recorded:

- **[▶■]** on the base unit flashes.
- "New message" is displayed.

Press **[▶■]** (PLAY).

- During playback, **[▶■]** on the base unit lights.
- If new messages have been recorded, the base unit plays back new messages.
- If there are no new messages, the base unit plays back all messages.

Operating the answering system during playback

Key	Operation
[▲] or [▼]	Adjust the speaker volume
[◀◀]	Repeat message* ¹
[▶▶]	Skip message
[PAUSE]	Pause message To resume playback, press [▶■] .
[▶■] (STOP)	Stop playback
[ERASE]	Erase currently playing message

*¹ If pressed within the first 5 seconds of a message, the previous message is played.

Calling back (Caller ID subscribers only)

■ Using a landline:

Lift the corded handset during playback.

- To edit the number before calling back, press **[EDIT]**. Add or erase digits to the beginning of the number as necessary (page 51).

■ Using a mobile line:

Press **[MOBILE 1]** or **[MOBILE 2]**, then lift the corded handset during playback.

- To edit the number before calling back, press **[EDIT]**. Add or erase digits to the beginning of the number as necessary (page 51).

Erasing all messages

Press **[ERASE]** 2 times while the unit is not in use.

Using the handset

When new messages have been recorded, "New message" is displayed.

1 To listen to new messages:

[MENU] **#** **3** **2** **3**

To listen to all messages:

[MENU] **#** **3** **2** **4**

2 When finished, press **[OFF]**.

Note:

- To switch to the receiver, press **[↶]**.
- You can also use the **[PLAY]** soft key, if displayed, to play new messages.

Answering System for Landline

Operating the answering system

[MENU] → **[↕]**: “Answering device” → **[SELECT]**

Key	Operation
[▲] or [▼]	Adjust the receiver/speaker volume (during playback)
[1] or [◀]	Repeat message (during playback)*1
[2] or [▶]	Skip message (during playback)
[3]	Enter the “Settings” menu
[4]	Play new messages
[5]	Play all messages
[6]	Play greeting message
[7][6]	Record greeting message
[8]	Turn answering system on
[PAUSE]	Pause message*2
[9] or [STOP]	Stop recording Stop playback
[0]	Turn answering system off
[*][4]*3	Erase currently playing message
[*][5]	Erase all messages
[*][6]	Reset to a pre-recorded greeting message

*1 If pressed within the first 5 seconds of a message, the previous message is played.

*2 To resume playback:

[↕]: “Playback” → **[SELECT]**

*3 You can also erase as follows:

[PAUSE] → **[↕]**: “Erase” → **[SELECT]**
→ **[↕]**: “Yes” → **[SELECT]**

Calling back (Caller ID subscribers only)

■ Using a landline:

- 1 Press **[PAUSE]** during playback.
- 2 **[↕]**: “Call back” → **[SELECT]**

■ Using a mobile line:

- 1 Press **[PAUSE]** during playback.
- 2 **[↕]**: “Call back (Mobile)” → **[SELECT]**
 - The unit starts dialling when:
 - only 1 mobile phone is paired.
 - a specific line is set to make mobile calls (page 19).

- 3 **[↕]**: Select the desired mobile phone. → **[SELECT]**

Editing the number before calling back

■ Using a landline:

- 1 Press **[PAUSE]** during playback.
- 2 **[↕]**: “Edit & Call” → **[SELECT]**
- 3 Edit the number. → **[↶]**

■ Using a mobile line:

- 1 Press **[PAUSE]** during playback.
- 2 **[↕]**: “Edit & Call” → **[SELECT]**
- 3 Edit the number.
- 4 **[MOBILE]**
 - The unit starts dialling when:
 - only 1 mobile phone is paired.
 - a specific line is set to make mobile calls (page 19).
- 5 **[↕]**: Select the desired mobile phone. → **[SELECT]**

Erasing all messages

- 1 **[MENU][#][3][2][5]**
- 2 **[↕]**: “Yes” → **[SELECT]** → **[OFF]**

Advanced new message alerting features

Audible message alert

This feature allows the base unit to beep to inform you of a new message arrival when new messages are recorded. The base unit beeps 2 times every minute until you listen to the messages, if the “Base unit beep” setting is turned on. The default setting is “Off”. You can configure this setting using either the base unit or one of the handsets.

Handset / Base unit

- 1 **[MENU][#][3][3][9]**
- 2 **[↕]**: Select the desired setting. → **[SAVE]**
- 3 Proceed with the operation for your unit.
Handset: [OFF]
Base unit: [EXIT]

New message alert by a call

This feature allows you to receive a notification by phone when new messages are recorded. The base unit calls a phone number you specify. You can then operate the answering system remotely to listen to the new message.

To use this feature, you must:

- store a phone number to which the unit makes the call to.
- turn on the new message alert setting.

After you answer the new message alert call, you can listen to messages from that call (page 62).

This feature is only available for landline.

You can configure this setting using either the base unit or one of the handsets.

Important:

- A new message alert is stopped 1 minute after the unit starts to call. The unit will not retry the call even if the call is not answered.

Storing a phone number to which the unit makes an alert call

Handset

■ From the phonebook:

- 1 **[MENU]#338**
- 2 **[↕]: "Notification to" → [SELECT] → [ADD]**
- 3 **[↕]: "Phonebook" → [SELECT]**
- 4 **[↕]: Select the desired phonebook entry. → [SAVE] → [OFF]**

■ By entering a phone number:

- 1 **[MENU]#338**
- 2 **[↕]: "Notification to" → [SELECT] → [ADD]**
- 3 **[↕]: "Manual" → [SELECT]**
- 4 Enter the desired name (16 characters max.). → **[OK]**
- 5 Enter the desired number (24 digits max.). → **[OK] → [SELECT] → [OFF]**

Base unit

■ From the phonebook:

- 1 **[MENU]#338**
- 2 **[↕]: "Notification to" → [SELECT] → [□□]**

- 3 **[↕]: Select the desired phonebook entry. → [SAVE] → [EXIT]**

■ By entering a phone number:

- 1 **[MENU]#338**
- 2 **[↕]: "Notification to" → [SELECT] → [EDIT]**
- 3 Enter the desired name (16 characters max.). → **[OK]**
- 4 Enter the desired number (24 digits max.). → **[OK] → [SELECT] → [EXIT]**

Turning on/off the new message alert setting

Handset / Base unit

- 1 **[MENU]#338**
- 2 **[↕]: "On/Off" → [SELECT]**
- 3 **[↕]: Select the desired setting. → [SAVE]**
- 4 Proceed with the operation for your unit.
Handset: **[OFF]**
Base unit: **[EXIT]**

Editing the set phone number

Handset

- 1 **[MENU]#338**
- 2 **[↕]: "Notification to" → [SELECT]**
- 3 **[MENU] → [↕]: "Edit" → [SELECT]**
- 4 Edit the name if necessary (16 characters max.). → **[OK]**
- 5 Edit the phone number if necessary (24 digits max.). → **[OK] → [SELECT] → [OFF]**

Base unit

- 1 **[MENU]#338**
- 2 **[↕]: "Notification to" → [SELECT] → [EDIT]**
- 3 Edit the name if necessary (16 characters max.). → **[OK]**
- 4 Edit the phone number if necessary (24 digits max.). → **[OK] → [SELECT] → [EXIT]**

Erasing the set phone number

Handset

- 1 **[MENU]#338**
- 2 **[↕]: "Notification to" → [SELECT]**
- 3 **[MENU] → [↕]: "Erase" → [SELECT]**

Answering System for Landline

- 1 [↕]: “Yes” → [SELECT] → [OFF]
 - The new message alert setting is turned off.

Base unit

- 1 [MENU]#338
- 2 [↕]: “Notification to” → [SELECT] → [ERASE]
- 3 [↕]: “Yes” → [SELECT] → [EXIT]
 - The new message alert setting is turned off.

Activating/inactivating the remote access code to play messages

If you activate this feature, you must enter the remote access code (page 62) to play the new message from the new message alert call. This is so that unauthorised parties cannot listen to your messages. The default setting is “Inactivate”.

- “Inactivate”: You can listen to the message by pressing 4 to play new messages (without entering the remote access code).
- “Activate”: You must enter your remote access code and then press 4 to play new message.

Handset / Base unit

- 1 [MENU]#338
- 2 [↕]: “Remote code” → [SELECT]
- 3 [↕]: Select the desired setting. → [SAVE]
- 4 Proceed with the operation for your unit.
Handset: [OFF]
Base unit: [EXIT]

Listening to messages

After you answer the new message alert, you can listen to the messages as follows.

- When the remote access code is set to “Inactivate”:
Press 4 to play the new message during the announcement.
- When the remote access code is set to “Activate”:
 - 1 Enter the remote access code (page 62) during the announcement.
 - 2 Press 4 to play the new message.

Note:

- Within 10 seconds after listening to new messages, you can press #9 during the call

to turn off the new message alert by a call feature.

- Even if the unit makes a new message alert call, the handset redial list does not show the record. However, on the base unit redial list it is shown as “Message alert”.

Remote operation

Using a touch-tone phone, you can call your phone number from outside and access the unit to listen to messages or change answering system settings. The unit’s voice guidance prompts you to press certain dial keys to perform different operations.

Remote access code

A 3-digit remote access code must be entered when operating the answering system remotely. This code prevents unauthorised parties from listening to your messages remotely. You can configure this setting using either the base unit or one of the handsets.

Important:

- In order to operate the answering system remotely, you must first set a remote access code.

Handset / Base unit

- 1 [MENU]#306
- 2 Enter the desired 3-digit remote access code.
- 3 [SAVE]
- 4 Proceed with the operation for your unit.
Handset: [OFF]
Base unit: [EXIT]

Deactivating remote operation

Press X in step 2 on “Remote access code”, page 62.

- The entered remote access code is deleted.

Using the answering system remotely

- 1 Dial your landline phone number from a touch-tone phone.
- 2 After the greeting message starts, enter your remote access code.

Answering System for Landline

- Follow the voice guidance prompts as necessary or control the unit using remote commands (page 63).
- When finished, hang up.

Voice guidance

During remote operation, the unit's voice guidance starts and prompts you to press **[1]** to perform a specific operation, or press **[2]** to listen to more available operations.

Note:

- If you do not press any dial keys within 10 seconds after a voice guidance prompt, the unit disconnects your call.

Remote commands

You can press dial keys to access certain answering system functions without waiting for the voice guidance to prompt you.

Key	Operation
[1]	Repeat message (during playback)*1
[2]	Skip message (during playback)
[4]	Play new messages
[5]	Play all messages
[9]	Stop playback
[0]	Turn answering system off
[*][4]	Erase currently playing message
[*][5]	Erase all messages
[*][#]	End remote operation (or hang up)

*1 If pressed within the first 5 seconds of a message, the previous message is played.

Turning on the answering system remotely

- Dial your phone number from a touch-tone phone.
- Let the phone ring 15 times.
 - A long beep is heard.
- Enter your remote access code within 10 seconds after the long beep.
 - The greeting message is played back.

- You can either hang up, or enter your remote access code again and begin remote operation (page 62).

Answering system settings

Call screening

Handset / Base unit

While a caller is leaving a message, you can listen to the call through the unit's speaker.

To adjust the speaker volume, press **[▲]** or **[▼]** repeatedly.

You can answer the call by:

- lifting the corded handset from the base unit, or
- pressing **[📞]** on the handset.

Call screening can be set for each unit. The default setting is "On".

- [MENU][#][3][1][0]**
- [↕]**: Select the desired setting. → **[SAVE]**
- Proceed with the operation for your unit.
Handset: [OFF]
Base unit: [EXIT]

Number of rings before the unit answers a call

You can change the number of times the phone rings "Ring count" before the unit answers calls. You can select 2 to 9 rings, or "Toll saver".

The default setting is "5 rings".

"Toll saver": The unit's answering system answers at the end of the 2nd ring when new messages have been recorded, or at the end of the 5th ring when there are no new messages. If you call your phone from outside to listen to new messages (page 62), you know that there are no new messages when the phone rings for the 3rd time. You can then hang up without being charged for the call.

You can configure this setting using either the base unit or one of the handsets.

Handset / Base unit

- [MENU][#][2][1][1]**
- [↕]**: Select the desired setting. → **[SAVE]**
- Proceed with the operation for your unit.
Handset: [OFF]

Answering System for Landline

Base unit: [EXIT]

For service provider voicemail subscribers (for Australia)

To receive voicemail and use the answering system properly, please note the following:

- “Voicemail” is a service provided by your phone service provider (page 65). You will need to first subscribe or activate this service through your phone service provider. Contact your phone service provider on how to operate this service and how you will be notified that you have messages on your voicemail. To use this service, you will be required to leave your answering machine off on your unit. This will allow the voicemail to receive any messages.
- To use the unit’s answering machine rather than the voicemail service provided by your phone service provider, please contact your phone service provider to have it removed or deactivated permanently or temporarily. Alternatively you can leave this service connected and change the “Ring count” to a shorter duration on your unit so your unit’s answering machine can pick up the call prior to the voicemail provided by your phone service provider.

For Telecom Call Minder or TelstraClear Message Mailbox service subscribers (for New Zealand)

To receive Call Minder or Message Mailbox messages and use the unit’s answering system properly, please note the following:

- “Call Minder” and “Message Mailbox” are services provided by your phone service provider (page 65). You will need to first subscribe or activate this service through your phone service provider. Contact your phone service provider on how to operate this service and how you will be notified that you have messages. To use this service you will be required to leave your answering machine off on your unit (page 58). This will allow the service to receive any messages.
- To use the unit’s answering machine rather than the service provided by your phone service provider, please contact your phone service provider to have it removed or deactivated permanently or temporarily. Alternatively you can leave this service connected and change the “Ring count” to a shorter duration on

your unit so your unit’s answering machine can pick up the call prior to the service provided by your phone service provider.

Caller’s recording time

You can change the maximum message recording time allowed for each caller. The default setting is “3 min”.

You can configure this setting using either the base unit or one of the handsets.

Handset / Base unit

- 1 [MENU]#305
- 2 [↕]: Select the desired setting. → [SAVE]
- 3 Proceed with the operation for your unit.
Handset: [OFF]
Base unit: [EXIT]

Selecting “Greeting only”

You can select “Greeting only” which sets the unit to announce a greeting message to callers but not record messages.

Select “Greeting only” in step 2 on “Caller’s recording time”, page 64.

Note:

- When you select “Greeting only”:
 - If you do not record your own message, the unit will play the pre-recorded greeting-only message asking callers to call again later.
 - If you use your own message, record the greeting-only message asking callers to call again later (page 58).

Voice mail service for landline

For Australia

Voice mail is an automatic answering service offered by your phone service provider.

For New Zealand

To receive Call Minder or Message Mailbox messages, please note the following: "Call Minder" and "Message Mailbox" are automatic answering services offered by your phone service provider.

For Australia and New Zealand

After you subscribe to this service, your phone service provider's voice mail system answers calls for you when you are unavailable to answer the phone or when your line is busy. Messages are recorded by your phone service provider, not your telephone.

Please contact your phone service provider for details of this service.

Important:

- To use the voice mail service provided by your phone service provider rather than the unit's answering system, turn off the answering system (page 58). For details, see page 64.

Storing the voice mail (VM) access number

In order to listen to your voice mail messages, you must dial your phone service provider's voice mail access number. Once you have stored your voice mail access number, you can dial it automatically (page 65).

You can configure this setting using either the base unit or one of the handsets.

Handset / Base unit

- 1 **[MENU]** **#** **3** **3** **1**
- 2 Enter your access number (24 digits max.). → **[SAVE]**
- 3 Proceed with the operation for your unit.
Handset: **[OFF]**
Base unit: **[EXIT]**

Note:

- When storing your voice mail access number and your mailbox password, press **[▲]** (Pause)

on the handset or **[PAUSE]** on the base unit to add pauses (page 20, 25) between the access number and the password as necessary.

Contact your phone service provider for the required pause time.

Example:

083210	PPPP	8888
VM access number	Pauses	Password

To erase the voice mail access number

Handset / Base unit

- 1 **[MENU]** **#** **3** **3** **1**
- 2 Press and hold **[CLEAR]** until all digits are erased. → **[SAVE]**
- 3 Proceed with the operation for your unit.
Handset: **[OFF]**
Base unit: **[EXIT]**

Listening to voice mail messages

When new messages have been recorded, "Voice mail msg. via phone co." is displayed if message indication service is available.

Handset / Base unit

- 1 **[MENU]** **#** **3** **3** **0**
 - The speakerphone turns on.
 - Lift the corded handset if needed.
- 2 Follow the pre-recorded instructions.
- 3 When finished, hang up.

Note:

- You can also use the **[ACCESS]** soft key, if displayed, to play new voice mail messages.
- If the handset and base unit still indicate there are new messages even after you have listened to all new messages, turn it off by pressing and holding **#** until the handset or base unit beeps.

Useful Information

Wall mounting

The base unit can be mounted on a wall by changing the wall mounting adaptor's position.

Note:

- Make sure that the wall and the fixing method are strong enough to support the weight of the unit.
- Drive the screws (not supplied) into the wall.

Base unit

- 1 To remove the wall mounting adaptor, push down the release levers (1). Remove the adaptor (2).

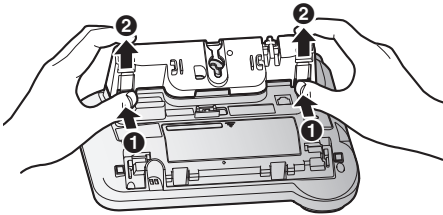

- 2 ① Turn the adaptor so that the words "UP WALL" are facing up.
② Tuck the telephone line cord inside the wall mounting adaptor.
③ Connect the AC adaptor cord and telephone line cord.

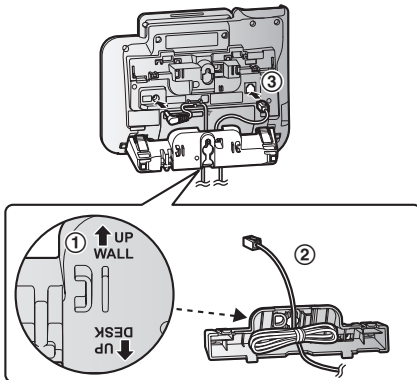

- 3 Insert the lower tabs of the adaptor into the unit's bottom slots (1), then insert by pushing

down the levers of the adaptor into the upper slots (2).

- The words "UP WALL" should be facing up.

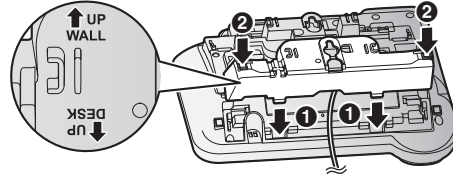

- 4 Mount the unit on a wall then slide down to secure in place.

- A Screws
- B 83 mm

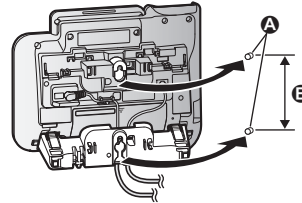

Charger

- A Screws
- B 27.2 mm

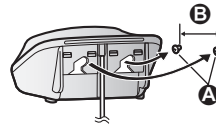

Wall mounting template

■ Base unit

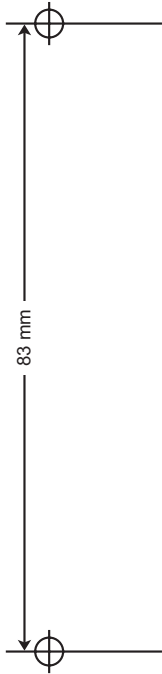

■ Charger

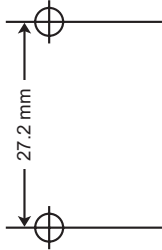

Useful Information

Error messages

Display message	Cause/solution
Ask phone company for VM access #	<ul style="list-style-type: none">You have not stored the voicemail access number. Store the number (page 65).
Base no power or No link. Re-connect base AC adaptor.	<ul style="list-style-type: none">Confirm the base unit's AC adaptor is connected to the unit and the power outlet correctly.The handset has lost communication with the base unit. Move closer to the base unit and try again.Unplug the base unit's AC adaptor to reset the unit. Reconnect the adaptor and try again.The handset's registration may have been cancelled. Re-register the handset (page 47).
Busy	<ul style="list-style-type: none">No mobile phone is paired to the base unit. Pair a mobile phone (page 16).The called unit is in use.Other units are in use and the system is busy. Try again later.The handset you are using is too far from the base unit. Move closer and try again.Only 2 Bluetooth devices can be used with the unit at the same time (for example, 2 mobile lines, or the headset and 1 mobile line).
Check tel line	<ul style="list-style-type: none">The supplied telephone line cord has not been connected yet or not connected properly. Check the connections (page 9).If you do not connect the telephone line cord and use only mobile lines, set the mobile line only mode (page 18).
Error!!	<ul style="list-style-type: none">Recording was too short. Try again.Someone is using a mobile line or headset. Try again later.The phonebook copy is incomplete (page 53). The mobile phone is disconnected from the base unit. Make sure that other Bluetooth devices are not connected to the mobile phone, and try again.
Failed	<ul style="list-style-type: none">Although the unit tried to connect to the mobile phone or headset, the connection has been failed.<ul style="list-style-type: none">Someone is using a mobile line or headset. Try again later.Make sure that the mobile phone or headset is not connected to other Bluetooth devices.
Invalid	<ul style="list-style-type: none">There is no handset registered to the base unit matching the handset number you entered.The handset is not registered to the base unit. Register the handset (page 47).
Requires subscription to Caller ID.	<ul style="list-style-type: none">You must subscribe to a Caller ID service. Once you receive caller information after subscribing to a Caller ID service, this message will not be displayed.
Use rechargeable battery.	<ul style="list-style-type: none">A wrong type of battery such as alkaline or manganese was inserted. Use only the rechargeable Ni-MH batteries noted on page 4, 6.

Troubleshooting

If you still have difficulties after following the instructions in this section, disconnect the base unit's AC adaptor, then reconnect the base unit's AC adaptor. Remove the batteries from the handset, and then insert them into the handset again.

If the base unit batteries for power backup are installed, remove the batteries from the base unit, and then insert them into the base unit again.

General use

Problem	Cause/solution
The handset does not turn on even after installing charged batteries.	<ul style="list-style-type: none"> Place the handset on the charger to turn on the handset.
The unit does not work.	<ul style="list-style-type: none"> Make sure the batteries are installed correctly (page 9). Fully charge the batteries (page 9). Check the connections (page 9). Unplug the base unit's AC adaptor to reset the unit. Reconnect the adaptor and try again. The handset has not been registered to the base unit. Register the handset (page 47).
I cannot pair a mobile phone to the base unit.	<ul style="list-style-type: none"> Depending on the compatibility of the mobile phone, you may not be able to pair it to the base unit. Confirm that your mobile phone supports the hands-free profile (HFP) specification. Confirm that the Bluetooth feature of your mobile phone is turned on. You may need to turn this feature on depending on your mobile phone. The Bluetooth technology on your mobile phone may not be functioning normally. Turn off and on your mobile phone. If your mobile phone is already connected to another Bluetooth device such as a Bluetooth headset, turn it off or disconnect it from your mobile phone. Some mobile phones may require you to enter the Bluetooth PIN to pairing. Confirm that you entered the correct PIN.

Useful Information

Problem	Cause/solution
I cannot connect a mobile phone to the base unit.	<ul style="list-style-type: none"> • Confirm that your mobile phone is turned on. • Confirm that your mobile phone is within base unit range (page 13). • Your mobile phone's Bluetooth feature is turned off. Turn it on. • Depending on the state of the wireless environment, such as the presence of any electrical interference, there may be a delay even if the auto connection feature is turned on. You can connect to the base unit manually (page 18). • The mobile phone has not been paired to the base unit. Pair the mobile phone (page 16). • If your mobile phone is already connected to another Bluetooth device such as a Bluetooth headset or other Panasonic DECT phone, disconnect the device, then perform the connecting procedure to the base unit. • If your mobile phone is already registered on another Panasonic DECT phone, this function will not work properly. We strongly recommend that you remove the registration of this phone on both your mobile phone and on the other Panasonic DECT phone.
I cannot hear a dial tone.	<ul style="list-style-type: none"> • Make sure that the MOBILE indicator lights up (page 14). • The base unit's AC adaptor or telephone line cord is not connected. Check the connections. • Disconnect the base unit from the telephone line and connect the line to a known working telephone. If the working telephone operates properly, contact our service personnel to have the unit repaired. If the working telephone does not operate properly, contact your phone service provider.
The base unit beeps.	<ul style="list-style-type: none"> • New messages have been recorded. Listen to the new messages (page 59).
The unit does not work during a power failure.	<ul style="list-style-type: none"> • You can insert 2 AAA (R03) batteries (not supplied) into the base unit that will power the unit temporarily in the event of a power failure (page 10). • The base unit display is blank if the saving mode is "on" (page 11).



Menu list

Problem	Cause/solution
I cannot register a handset to a base unit.	<ul style="list-style-type: none"> • The maximum number of handsets (6) is already registered to the base unit. Cancel unused handset registrations from the base unit (page 48).

Battery recharge

Problem	Cause/solution
The handset beeps and/or  flashes.	<ul style="list-style-type: none"> • Battery charge is low. Fully charge the batteries (page 9).

Useful Information

Problem	Cause/solution
<p>I fully charged the batteries, but</p> <ul style="list-style-type: none"> –  still flashes, –  is displayed, or – the operating time seems to be shorter. 	<ul style="list-style-type: none"> ● Clean the battery ends (\oplus, \ominus) and the charge contacts with a dry cloth and charge again. ● It is time to replace the batteries (page 9).

Making/answering calls, intercom

Problem	Cause/solution
<p> is displayed.</p>	<ul style="list-style-type: none"> ● The handset is too far from the base unit. Move closer. ● The base unit's AC adaptor is not properly connected. Reconnect AC adaptor to the base unit. ● The handset is not registered to the base unit. Register it (page 47).
<p>Noise is heard, sound cuts in and out.</p>	<ul style="list-style-type: none"> ● You are using the handset or base unit in an area with high electrical interference. Re-position the base unit and use the handset away from sources of interference. ● Move closer to the base unit. ● If you use a DSL/ADSL service, we recommend connecting a filter (contact your DSL/ADSL service provider) to the telephone line between the base unit and the telephone line socket. Contact your DSL/ADSL provider for details. (for Australia) ● If you use a DSL/ADSL (JetStream) service, we recommend that you contact your DSL/ADSL service provider to have a DSL/ADSL Splitter installed. We do not recommend the use of generic DSL/ADSL filters. Contact your DSL/ADSL service provider for details. (for New Zealand)
<p>The handset or base unit does not ring.</p>	<ul style="list-style-type: none"> ● The ringer volume for landline is turned off. Adjust the ringer volume (page 21, 25, 41). ● The ringer volume for mobile line is turned off. Adjust the ringer volume (page 21, 25, 39). ● The unit which is not selected to ring for mobile calls does not ring. To change the selection, see page 17. ● Do not disturb mode is turned on. Turn it off (page 45).
<p>I cannot make local calls with the handset or base unit using a mobile line.</p>	<ul style="list-style-type: none"> ● You need to add your area code when making mobile calls. Store your area code in order to automatically add it to the beginning of the 8-digit (for Australia)/7-digit (for New Zealand) phone number when making mobile calls (page 19).
<p>I cannot make or answer mobile calls with the handset or base unit.</p>	<ul style="list-style-type: none"> ● Depending on the mobile phone's compatibility, you may not be able to make or answer mobile calls even if the mobile phone is connected to the base unit. ● Make sure that the MOBILE indicator lights up and the mobile phone is connected to the base unit (page 18). ● Only 2 Bluetooth devices can be used with the unit at the same time (for example, 2 mobile lines, or the headset and 1 mobile line). ● The mobile phone is being used separately from your system.

Useful Information

Problem	Cause/solution
I can make and answer mobile calls but cannot hear a sound.	<ul style="list-style-type: none">• The Bluetooth technology on your mobile phone may not be functioning normally. Turn off and on your mobile phone.• Disconnect and reconnect the base unit AC adaptor and try again.
I cannot switch mobile calls from the unit to the mobile phone.	<ul style="list-style-type: none">• Your mobile phone may not support this feature. Refer to the operating instructions of your mobile phone.
I cannot make a call using a landline.	<ul style="list-style-type: none">• If you are using a BT double adaptor to connect the unit, remove the adaptor and connect the unit to the phone wall socket directly. If the unit operates properly, check or replace the adaptor. (for New Zealand)• The unit is not designed to be used with rotary/pulse dialling services.
I cannot use a mobile line or a landline.	<ul style="list-style-type: none">• The unit can be used to talk on 2 lines at the same time (for example, 2 mobile lines, or the landline and 1 mobile line).

Caller ID/Talking Caller ID

Problem	Cause/solution
Caller information is not displayed.	<ul style="list-style-type: none">• You must subscribe to Caller ID service. Contact your phone service provider for details.• If your unit is connected to any additional telephone equipment such as a Caller ID box or cordless telephone line socket, plug the unit directly into the wall socket.• If you use a DSL/ADSL service, we recommend connecting a filter (contact your DSL/ADSL service provider) to the telephone line between the base unit and the telephone line socket. Contact your DSL/ADSL provider for details. (for Australia)• If you use a DSL/ADSL (JetStream) service, we recommend that you contact your DSL/ADSL service provider to have a DSL/ADSL Splitter installed. We do not recommend the use of generic DSL/ADSL filters. Contact your DSL/ADSL service provider for details. (for New Zealand)• Other telephone equipment may be interfering with this unit. Disconnect the other equipment and try again. (for Australia)• Other telephone equipment such as a monitored Burglar Alarm or the modem in the SKY Digital decoder may be interfering with this unit. Disconnect the other equipment and try again. (for New Zealand)
Caller information is displayed or announced late.	<ul style="list-style-type: none">• Depending on your phone service provider, the unit may display or announce the caller's information at the 2nd ring or later.• Move closer to the base unit.

Useful Information

Problem	Cause/solution
Caller information is not announced.	<ul style="list-style-type: none"> • The ringer volume for landline is turned off. Adjust the ringer volume (page 21, 25, 41). • The ringer volume for mobile line is turned off. Adjust the ringer volume (page 21, 25, 39). • The unit which is not selected to ring for mobile calls does not announce caller information. To change the selection, see page 17. • The Talking Caller ID feature is turned off. Turn it on (page 41). • The ring as mobile mode is set to "On (without Talking CID)". To change the mode, see page 17. • The number of rings for the answering system is set to "2 rings" or "Toll saver". Select a different setting (page 63). • Your unit does not announce caller information while the other devices such as headset or handsets are engaged in a call.
Time on the unit has shifted.	<ul style="list-style-type: none"> • Incorrect time information from incoming Caller ID changes the time. Set the time adjustment to "Manual" (off) (page 41).

Using Bluetooth devices

Problem	Cause/solution
I cannot copy phonebook entries from a mobile phone.	<ul style="list-style-type: none"> • Confirm that the mobile phone supports Bluetooth wireless technology. • Confirm that the mobile phone supports the Phone Book Access Profile (PBAP) or Object Push Profile (OPP) specification. • If the mobile phone is already connected to another Bluetooth device such as a Bluetooth headset, turn it off or disconnect it from the mobile phone. • Someone is using a mobile line or headset. Try again later. • Turn the mobile phone off, then turn it on and try again. • If an entry is already stored in the unit's phonebook, the entry cannot be copied even by selecting another group. • iPhone does not support individual phonebook copy.
I cannot have a conversation using the headset. or I cannot connect my headset to the base unit.	<ul style="list-style-type: none"> • Confirm that the Bluetooth wireless headset supports the HeadSet Profile (HSP) specification. • Your Bluetooth headset is not paired. Pair it (page 56). • Turn your headset off, then turn it on and try again. • If your headset is already connected to another Bluetooth device such as your mobile phone, disconnect the headset from your mobile phone, then perform the connecting procedure from the base unit. • Only 2 Bluetooth devices can be used with the unit at the same time (for example, 2 mobile lines, or the headset and 1 mobile line).
Noise is heard during a call on the headset.	<ul style="list-style-type: none"> • A Bluetooth headset can communicate with the base unit within a range of approximately 10 m. The connection may be subject to interference from obstructions such as walls or electronic devices. Move closer to the base unit.
Some headset enhanced features are not available.	<ul style="list-style-type: none"> • The base unit does not support enhanced features such as Last number redial or Call reject.

Useful Information

Problem	Cause/solution
An error tone is heard when I try to program the Bluetooth feature.	<ul style="list-style-type: none"> • The Bluetooth feature cannot be accessed immediately after connecting the AC adaptor to the base unit. Wait a few seconds and try again. • The headset has not connected to the base unit yet, even though you performed the connecting procedure setting. Wait a few seconds and try again.
App alert is not displayed or announced. or Text message alert is not displayed or announced.	<ul style="list-style-type: none"> • Confirm that the mobile phone supports the Message Access Profile (MAP) specification to use text message alert feature. • Confirm that the mobile phone supports the Serial Port Profile (SPP) specification to use App alert feature. • Confirm that the [Application Alerts manager] setting of your Android phone is turned on. • “Alert On/Off” is set to “Off”. Set it to “On” (page 55). • “Voice alert” is set to “Off”. Set it to “On” (page 55). • The Bluetooth device’s Bluetooth notifications setting is turned off. • The handset selected to display and/or announce alerts is in use. • The Bluetooth device or its corresponding mobile line is in use. • Your mobile phone’s Bluetooth feature is turned off. Turn it on.

Answering system

Problem	Cause/solution
The unit does not record new messages.	<ul style="list-style-type: none"> • The answering system is turned off. Turn it on (page 58). • The answering system does not answer or record calls from mobile lines. • The message memory is full. Erase unnecessary messages (page 59, 60). • The recording time is set to “Greeting only”. Change the setting (page 64). • Your phone service provider’s voicemail service may be answering your calls before the unit’s answering system can answer your calls. Change the unit’s number of rings setting (page 63) to a lower value, or contact your phone service provider. • The answering system will not answer incoming calls while the other devices such as headset or handsets are engaged in a call.
I cannot operate the answering system remotely.	<ul style="list-style-type: none"> • The remote access code is not set. Set the remote access code (page 62). • You are entering the wrong remote access code. If you have forgotten your remote access code, enter the remote access code setting to check your current code (page 62). • The answering system is turned off. Turn it on (page 63). • You cannot operate the answering system when calling a mobile phone paired to the base unit.
The unit does not emit the specified number of rings.	<ul style="list-style-type: none"> • If the ring once setting is turned off (page 29), the number of rings decreases by 1 from the specified number of rings.

Useful Information

Bluetooth PIN

Problem	Cause/solution
I cannot remember the PIN.	<ul style="list-style-type: none">Change the PIN using the following method. Handset/Base unit: 1 [MENU]#[6][1][9] 2 [X][7][0][0] 3 Enter the new 4-digit PIN. → [OK] 4 Enter the new 4-digit PIN again. → [SAVE] → [OFF]/[EXIT]

Voicemail

Problem	Cause/solution
Voicemail msg. via phone co. is shown on the display. How do I remove this message from the display?	<ul style="list-style-type: none">This notification is displayed when your phone service provider's voicemail service (not the unit's answering system) has recorded a message for you. Typically you can remove this notification from the display by listening to the message. To listen to the message, dial the voicemail number provided by your phone service provider (for most cases, this will be your own phone number), and follow the voice instructions. Depending on your phone service provider, you may need to remove all messages from your voice mailbox to remove the notification. You can also remove this notification by pressing and holding [#] until the unit beeps.

Liquid damage

Problem	Cause/solution
Liquid or other form of moisture has entered the handset/base unit.	<ul style="list-style-type: none">Disconnect the AC adaptor and telephone line cord from the base unit. Remove the batteries from the handset and leave to dry for at least 3 days. After the handset/base unit are completely dry, reconnect the AC adaptor and telephone line cord. Insert the batteries and charge fully before use. If the unit does not work properly, contact an authorised service centre.

Caution:

- To avoid permanent damage, do not use a microwave oven to speed up the drying process.

Warranty (for New Zealand)

Panasonic New Zealand undertakes to:

Repair or at its option, replace without cost to the owner, either for material or labour, any part which is found to be defective within two years of the date of purchase.

THIS EXPRESS WARRANTY DOES NOT COVER:

- 1) Pick up and delivery.
- 2) Batteries.
- 3) Repairs when the product has not been used in accordance with the Operating Instructions Manual or has been modified.
- 4) Normal maintenance and cleaning as required in the product's Operating Instructions Manual.
- 5) Service calls to:
 - a Correct the set up of the product
 - b Instruct you how to use the product
 - c Replace fuses or correct your building's wiring
- 6) Damage to the product caused by accident, misuse or Act of God.
- 7) Repairs when the product has been dismantled, repaired, modified or serviced by other than a Panasonic Authorised Dealer authorised to service that type of product.

IF YOUR PANASONIC PRODUCT FAILS WITHIN THE WARRANTY PERIOD:

Take it to the Authorised Panasonic Dealer from whom you purchased the product who will repair it (or arrange to have it repaired) during their normal business hours. All enquiries regarding warranty or otherwise, please call – Customer Support Centre Tel. No.: (09) 272 0178

NOTE: THIS EXPRESS WARRANTY IS OFFERED AS AN EXTRA BENEFIT AND DOES NOT AFFECT YOUR LEGAL RIGHTS.

Index

- # 3-way conference: 22, 25
- A** Additional handset: 47
 - Alarm: 44
 - Answering calls: 21, 25
 - Answering system
 - Call screening: 63
 - Erasing messages: 59, 60, 63
 - Greeting message: 58
 - Greeting only: 64
 - Listening to messages: 59, 62
 - New message alerting: 60
 - Number of rings: 63
 - Recording time: 64
 - Remote access code: 62
 - Remote operation: 62
 - Ring count: 63
 - Toll saver: 63
 - Turning on/off: 58
 - Area code: 51
 - Auto intercom: 27
 - Auto talk: 21, 42
- B** Baby monitor: 45
 - Battery: 9, 11
 - Battery saving mode: 11
 - Bluetooth wireless technology
 - Headset: 55
 - Mobile phone (Link to mobile): 16
 - Phonebook transfer: 53
- C** Call block: 28
 - One ring for blocked call: 29
- Call share: 22, 25, 42
- Call Waiting: 50
- Call waiting and Caller ID compatible: 49
- Call Waiting Caller ID: 50
- Caller ID service: 49
- Caller list: 50
- Caller list edit: 51
- Chain dial: 34
- CID (Caller ID): 50
- Conference calls: 22, 26
- Control type: 12, 13
- D** Date and time: 14
 - Direct command code: 37
 - Display
 - Contrast: 42
 - Do not disturb mode: 44
- E** Eco mode: 11
 - Equalizer: 22
 - Error messages: 68
- G** Groups: 32
- H** Handset
 - Deregistration: 48
 - Locator: 12
 - Name: 47
 - Registration: 47
 - Hold: 21, 25
- I** Intercom: 27
- K** Key finder: 41, 43
 - Key tone: 42
- L** Landline calls: 20, 24
 - Line mode: 42
 - Link to mobile
 - Alert settings for your DECT phone: 55
 - Area code: 19
 - Auto connection: 17
 - Connection: 18
 - Link to Mobile app: 54
 - Mobile line only mode: 18
 - Mobile line selection: 19
 - Ring as mobile mode: 17
 - Select unit to ring: 17
 - Text message (SMS: Short Message Service) alert: 55
- M** Making calls: 20, 24
 - Missed calls: 49
 - Mobile calls: 20, 24
 - Mobile phone
 - Pairing: 16
 - Unpairing: 16
 - Mute: 21, 25
- N** Noise reduction: 21
- O** One-touch dial buttons: 35
- P** Pause: 20, 25
 - Phonebook: 31
 - PIN: 19
 - Power failure (power backup operation): 10
- R** Recall: 21, 25, 42
 - Redialling: 20, 24
 - Region setting: 47
 - Repeater: 48
 - Ringer ID: 32
 - Ringer tone: 39, 41
- S** Speed dial: 34
 - SP-PHONE (Speakerphone): 20
- T** Talking Caller ID: 50
 - Time adjustment: 41
 - Transferring calls: 22, 26
 - Troubleshooting: 69
- V** VM (Voicemail): 65
 - Voicemail: 65
 - Volume
 - Receiver: 20, 24



Index

Ringer (Base unit): 25, 39, 41

Ringer (Handset): 21, 39, 41

Speaker: 20, 24

W Wall mounting: 66

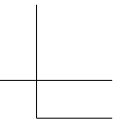
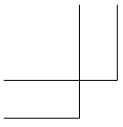

Notes

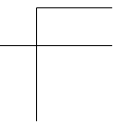
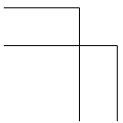
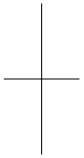

For your future reference

We recommend keeping a record of the following information to assist with any repair under warranty.

Serial No.	Date of purchase
(found on the bottom of the base unit)	
Name and address of dealer	

Attach your purchase receipt here.

<p>For Australia Customer Care Centre Tel. No.: 132600 or website www.panasonic.com/au For New Zealand Customer Care Centre Tel. No.: (09) 272 0178 or website www.panasonic.com/nz</p>



Sales Department:

Panasonic Australia Pty. Limited
1 Innovation Road, Macquarie Park NSW 2113, Australia

Sales Department:

Panasonic New Zealand Ltd.
18 Sir Woolf Fisher Drive, Highbrook, East Tamaki, Auckland,
New Zealand
Phone: (09) 272 0100
Fax: (09) 272 0137

Panasonic System Networks Co., Ltd.

1-62, 4-chome, Minoshima, Hakata-ku, Fukuoka 812-8531, Japan

© Panasonic System Networks Co., Ltd. 2015



PNQX7106ZA

PNQX7106ZA TT0615WK0 (E)