

The Genuine. The Original.

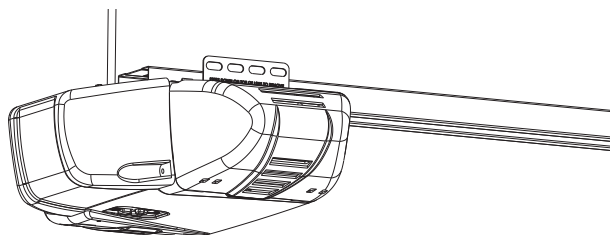

**BELT/CHAIN DRIVE GARAGE DOOR OPENER
Legacy® 920, MODELS 7020H, 7020H-B
7120H, 7120H-B**

PROGRAMMING, OPERATION & MAINTENANCE MANUAL



**INSTALLER: LEAVE THIS MANUAL WITH HOMEOWNER
HOMEOWNER: SAVE THIS MANUAL FOR FUTURE REFERENCE**



**Need help or have questions?
For answers and assistance,
visit www.OverheadDoor.com
or call Customer Service at: 1-800-929-3667**

! WARNING

To reduce the risk of injury to persons or damage to property, use this opener only with a sectional residential door.

! AVERTISSEMENT

Por reduire le risque de blessures ou de dommages materials, utilisez cet ouvre-porte uniquement pour une porte a section re sidentielle.

Alternate language manuals available at: } www.OverheadDoor.com
Idioma alternativo manuales disponibles en:
Autre langue manuels disponibles à:

SERIAL NUMBER DECAL

iDCM SERIAL NUMBER

INDEX

1	Safety Information	
	Safety Notifications.....	4
	Important Safety Instructions.....	5
2	Features	
	Safety Features.....	6
	Opener Features.....	6
3	Programming Information	
	Introduction.....	7
	Overview of Powerhead Controls.....	7
	Travel Limits	
	Closing Garage Door (DOWN Limit).....	8
	Opening Garage Door (UP Limit).....	9
	Force Control.....	10
	Contact Reverse Test.....	10
	Contact Reverse Adjustment.....	10
	Remote Control Programming.....	11
4	Maintenance and Adjustments	
	Important Safety Instructions.....	12
	Regular Maintenance.....	13
	Remote Battery Replacement.....	13
	Light Bulb Replacement.....	14
	Chain/Belt Tension.....	14
	Carriage Adjustment for Release.....	15
	Adjustment Guides.....	15
	Resetting Travel Limits.....	15
	Locating Safe-T-Beam® Pairs.....	16
	Wire Diagram.....	16
5	Troubleshooting	17-18
6	Battery Backup Installation	19
7	Optional Programming & Accessories	
	Clearing Memory for Remotes.....	20
	Programming Vehicle Remotes.....	21
	Programming Wireless Keypad.....	22-23
8	Parts	24-27
9	DASMA Information	28-31
	Warranty	32

SAVE THESE INSTRUCTIONS

READ AND FOLLOW ALL INSTRUCTIONS

FCC Part 15.21 Statement:

Changes or modifications not expressly approved by the party responsible for compliance could void the user's authority to operate the equipment.

FCC / IC Statement:

This device complies with FCC Part 15 and Industry Canada licence-exempt RSS standard(s). Operation is subject to the following two conditions: (1) this device may not cause harmful interference, and (2) this device must accept any interference received, including interference that may cause undesired operation of the device.

Le présent appareil est conforme aux CNR d'Industrie Canada applicables aux appareils radio exempts de licence. L'exploitation est autorisée aux deux conditions suivantes : (1) l'appareil ne doit pas produire de brouillage, et (2) l'utilisateur de l'appareil doit accepter tout brouillage radioélectrique subi, même si le brouillage est susceptible d'en compromettre le fonctionnement.

TRANSMITTER COMPLIANCE STATEMENT

Transmitters comply with all United States and Canadian legal requirements as of the date of manufacture. No warranty is made that they comply with all legal requirements of any other jurisdiction. If transmitters are to be used in another country, the importer must determine compliance with any local laws and regulations which may differ from United States and Canadian requirements prior to use.

Los transmisores cumplen con todas las reglamentaciones legales de los Estados Unidos y del Canadá, en la fecha de fabricación. Ninguna garantía se da que cumplan con todas las reglamentaciones legales de ninguna otra jurisdicción. Si los transmisores se van a utilizar en otro país, el importador debe determinar si cumplen con las reglamentaciones y leyes locales que puedan ser diferentes a las reglamentaciones de los Estados Unidos y del Canadá, antes de usar los mismo .

Les émetteurs sont conformes à la réglementation américaine et canadienne à compter de leur date de fabrication. Aucune garantie n'est stipulée indiquant qu'ils sont conformes à toutes les prescriptions juridiques d'autres autorités. Si les émetteurs sont utilisés dans d'autres pays, il incombe à l'importateur d'en déterminer leur conformité aux lois et règles locales pouvant différer de celles des États-Unis et du Canada avant toute utilisation desdits émetteurs.

Sendegeräte entsprechen allen gesetzlichen Bestimmungen in den USA und Kanada zum Zeitpunkt der Herstellung. Wir übernehmen keine Gewährleistung für die Einhaltung aller gesetzlichen Bestimmungen in anderen Ländern. Sollen Sendegeräte in anderen Ländern eingesetzt werden, so muss der Importeur vor dem Gebrauch sicherstellen, dass die Sendegeräte auch solchen lokalen Bestimmungen entsprechen, welche von den Bestimmungen der USA und Kanadas abweichen.

截止于制造日期,传动装置符合美国和加拿大的所有法律要求。不提供传动装置符合任何其他司法地区所有法律要求之担保。如果传动装置需在任何其他国家使用,进口商必须在使用之前确定装置符合与美国和加拿大要求不同之所有地方法规条例。

截止于制造日期,传动装置符合美国和加拿大的所有法律要求。不提供传动装置符合任何其他司法地区所有法律要求之担保。如果传动装置需在任何其他国家使用,进口商必须在使用之前确定装置符合与美国和加拿大要求不同之所有地方法规条例。

截止于制造日期,传动装置符合美国和加拿大的所有法律要求。不提供传动装置符合任何其他司法地区所有法律要求之担保。如果传动装置需在任何其他国家使用,进口商必须在使用之前确定装置符合与美国和加拿大要求不同之所有地方法规条例。

Thank you for purchasing an Overhead Door® brand garage door opener. The leader in garage door opener technology.

Please take a moment to preview this manual. **Pay particular attention to all Safety Warnings, Cautions and Information.** Remember, your garage door is the largest and heaviest moving object in your home.



DO NOT RETURN PRODUCT TO STORE

If you require assistance or have any questions, a knowledgeable Overhead Door Distributor is just a phone call away at:

1-800-929-3667

Or visit our website at:

www.OverheadDoor.com

Before setting up your new garage door opener, please note the model plate on the opener and serial number(s) located on the front of this manual. This information will be necessary should you seek technical support via our website, customer support department or local servicing Overhead Door dealer.

OVERVIEW OF POTENTIAL HAZARDS READ THIS SAFETY INFORMATION

Garage doors are large, heavy objects that move with the help of springs under high tension and electric motors. Since moving objects, springs under tension, and electric motors can cause injuries, your safety and the safety of others depend on you reading the information in this manual. If you have questions or do not understand the information presented, call your nearest trained door system technician or visit our website at www.OverheadDoor.com.

CONVENTIONS USED IN THESE INSTRUCTIONS

The following safety alert symbol and signal words are used throughout this manual to call attention to and identify different levels of hazards and special instructions.

This is the safety alert symbol. This symbol alerts you to potential hazards that can kill or hurt you and others. All safety messages will follow the safety alert symbol and the word **"DANGER"**, **"WARNING"**, or **"CAUTION"**.









- **DANGER** indicates an imminently hazardous situation which, if NOT avoided, will result in death or serious injury.
- **WARNING** indicates a potentially hazardous situation which, if NOT avoided, could result in death or serious injury.
- **CAUTION** indicates a potentially hazardous situation which, if NOT avoided, may result in injury or property damage.
- The word **NOTE** is used to indicate important steps to be followed or important considerations.

Tous les messages concernant la sécurité seront indiqués après un symbole d'alerte de la sécurité et l'une des mentions suivantes **"DANGER"**, **"AVERTISSEMENT"** ou **"MISE EN GARDE"**.









- **DANGER** signale une situation dangereuse imminente qui, si elle n'est pas évitée, risque d'entraîner des blessures graves, voire mortelles.
- **AVERTISSEMENT** signale une situation potentiellement dangereuse qui, si elle n'est pas évitée, risque d'entraîner la mort ou des blessures graves.
- **MISE EN GARDE** signale une situation potentiellement dangereuse qui, si elle n'est pas évitée, risque d'entraîner des blessures ou des dommages matériels.
- Le terme **REMARQUE** est utilisé pour signaler les étapes importantes à suivre ou d'importants éléments à prendre en considération.

IMPORTANT SAFETY INSTRUCTIONS

POTENTIAL HAZARD	EFFECT	PREVENTION
 MOVING DOOR	 WARNING Could result in Serious Injury or Death	Do Not operate unless the doorway is in sight and free of obstructions. Keep people clear of opening while door is moving. Do Not allow children to play with the door opener. Do Not change opener control to momentary contact unless and external reversing means is installed. Do Not operate a door that jams or one that has a broken spring.
 ELECTRICAL SHOCK	 WARNING Could cause Serious Injury or Death	Turn off electrical power before removing opener cover. When replacing the cover, make sure wires are not pinched or near moving parts. Opener must be electrically grounded.
 HIGH SPRING TENSION	 WARNING Could cause Serious Injury or Death	Do Not try to remove, repair or adjust springs or anything to which door spring parts are fastened such as wood block, steel brackets, cables or any other structure or like item. Repairs and adjustments must be made by a trained service representative using proper tools and instructions.

IMPORTANTES CONSIGNES DE SÉCURITÉ

DANGER POTENTIEL	EFFET	PRÉVENTION
 PORTE EN MOUVEMENT	 AVERTISSEMENT Pourrait entraîner des blessures graves voire la mort	Utiliser uniquement si la porte est en vue et libre de tout obstacle. Ne laisser personne se tenir dans l'ouverture de la porte pendant qu'elle est en mouvement. Ne pas permettre aux enfants de jouer avec l'opérateur de la porte. Ne pas modifier la commande de l'opérateur à contact momentané à moins qu'un moyen d'inversion externe soit installé. Ne pas faire fonctionner une porte qui bloque ou dont le ressort est cassé.
 CHOC ÉLECTRIQUE	 AVERTISSEMENT Pourrait entraîner des blessures graves voire la mort	Couper le courant avant d'enlever le couvercle de l'opérateur. Lorsque le couvercle doit être remplacé, s'assurer que les fils ne sont ni coincés ni près des pièces mobiles. L'opérateur doit être correctement mis à la terre.
 TENSION ÉLEVÉE RESSORT	 AVERTISSEMENT Pourrait entraîner des blessures graves voire la mort	Ne pas essayer d'enlever, réparer ni ajuster les ressorts ou toute autre pièce à laquelle le ressort de la porte est attaché, y compris blocs de bois, supports en acier, câbles ou autres articles semblables. Les réparations et les réglages doivent être effectués par technicien qualifié qui se sert d'outils appropriés et qui respecte les instructions.

IMPORTANT INSTALLATION INSTRUCTIONS



WARNING

TO REDUCE THE RISK OF SEVERE INJURY OR DEATH

READ AND FOLLOW ALL SAFETY, INSTALLATION AND OPERATION INSTRUCTIONS. If you have any questions or do not understand an instruction, call Overhead Door Corp.

- **DO NOT** install opener on an improperly balanced door. An improperly balanced door could cause severe injury. Repairs and adjustments to cables, spring assembly and other hardware must be made by a trained service person using proper tools and instructions.
- Remove all ropes, and disable all locks connected to the door before installing opener.
- Where possible, install the door opener 7 feet or more above the floor. For products having an emergency release, mount the emergency release within reach, but at least 6 feet above the floor and avoiding contact with vehicles to avoid accidental release. **DO NOT** use emergency release cord to pull door.
- **DO NOT** connect the opener to the source of power until instructed to do so.
- Locate the wall control button: A) Within sight of door. B) At a minimum height of 5 feet, so small children cannot reach it. C) Away from all moving parts of the door.
- Install the entrapment WARNING label next to the wall button or console, in a prominent location. Install the emergency release handle on the emergency release cord.
- The opener must reverse when the door contacts a 1-1/2 inch high object on the floor at the center of the doorway. This is about the size of a 2" x 4" board laid flat.

IMPORTANTES INSTRUCTIONS D'INSTALLATION



AVERTISSEMENT

POUR RÉDUIRE LES RISQUES DE BLESSURES GRAVES VOIRE MORTELLES

LIRE ET SUIVRE ATTENTIVEMENT TOUTES LES INSTRUCTIONS D'INSTALLATION ET DE FONCTIONNEMENT AINSI QUE TOUTES LES CONSIGNES DE SÉCURITÉ. Si vous avez des questions ou si vous ne comprenez pas une instruction, veuillez contacter directement Overhead Door.

- **NE PAS** installer l'opérateur sur une porte mal équilibrée. Celle-ci pourrait entraîner de graves blessures. Les réparations et les réglages des câbles, ensembles de ressort ou tout autre article de quincaillerie doivent être effectués par un professionnel qui se sert d'outils appropriés et qui respecte les instructions.
- Enlever toutes les cordes et désactiver toutes les verrous de la porte avant l'installer l'opérateur.
- Dans la mesure du possible, installer l'ouvre-porte à 2,1 m ou plus au-dessus du sol. Pour les produits dotés d'un cordon de déclenchement d'urgence, installer le déclenchement d'urgence mais au moins à 1,8 m au-dessus du sol en évitant tout contact avec les véhicules pour éviter qu'ils ne soient déclenchés accidentellement. **NE PAS** utiliser d'urgence cordon de libération pour ouvrir ou fermer la porte.
- **NE PAS** connecter l'opérateur à la source d'alimentation tant que l'instruction n'est pas donnée.
- Repérer la console murale: A) En vue de la porte. B) À une hauteur minimale de 1,5 m afin que les jeunes enfants ne puissent pas l'atteindre. C) Loin de toutes pièces mobiles de la porte du garage.
- Placer l'étiquette d'AVERTISSEMENT en cas de coinçage à proximité du bouton mural ou de la console de manière à ce qu'elle soit bien en évidence. Installer la poignée du cordon de déclenchement d'urgence.
- L'opérateur doit s'inverser lorsque la porte entre en contact avec un objet d'une hauteur de 3,8 cm placé sur le sol, au centre de l'ouverture de la porte. Ceci équivaut environ à une planche de 5 x 10 cm posée à plat sur le sol.



WARNING

Opener is equipped with grounded electrical plug for your protection, and **only fits grounded electrical outlets. DO NOT** alter plug in any way! **If you have no grounded outlets, have one installed by a licensed electrician.** Opener must be properly grounded to prevent personal injury and equipment damage. **NEVER USE AN EXTENSION CORD!** Check local building codes for any requirement that you must have a permanent hard-wired connection. Permanent hard-wired connections must be performed by a licensed electrician using proper tools and instructions.



AVERTISSEMENT

L'opérateur, qui est équipé d'une prise électrique mise à la terre pour votre protection **est compatible uniquement avec des prises électriques mises à la terre. NE PAS** modifier la fiche d'une quelconque manière. Si vous n'avez pas de prises mises à la terre, faites-en installer par un électricien agréé. L'opérateur doit être correctement mis à la terre pour éviter les blessures corporelles et des dommages matériels. **NE JAMAIS UTILISER DE RALLONGE!** Vérifiez les codes locaux des bâtiments pour connexions câblées permanentes. Les connexions câblées permanentes doivent être effectuées par un électricien agréé qui se servira d'outils appropriés et respectera les consignes.



Safe-T-Beam® (STB) Non-Contact Reversing System:

Puts an invisible beam across the door opening. The door stops and reverses to the full open position if anything passes through the beam. LED indicator lights on the powerhead and on the STBs provide self-diagnostics if an operational problem exists.

Safe-T-Beam® (STB) FUNCTION:

1. The Safe-T-Beam® has no effect on the door during an opening cycle.
2. If the Safe-T-Beam® detects an obstruction when trying to close the door, it will not allow the door to close.
3. When the garage door is closing, if Safe-T-Beam® is interrupted by a person or obstacle, the garage door will stop its downward travel and reverse automatically to its fully opened position.
4. If the Safe-T-Beam® System fails, loses power, or is installed improperly, press and hold the wall console "open/close" button until the door reaches its fully closed position. If you release the "open/close" button on the wall console during the closing movement, the door will reverse automatically to its fully-opened position.

Door Detect™ Monitoring System:

Monitors the Safe-T-Beam® system to ensure proper functionality and will automatically stop and reverse a closing door if a problem is detected.

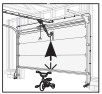

Safe-T-Reverse® Contact Reversing System:

Automatically stops and reverses a closing door within two seconds of contact with an object.



Manual Emergency Release:

Manually releases door from door opener. Used during a power failure or other emergency to allow manual opening and closing of door. **DO NOT use emergency release cord to pull door!**



SmartSet® Electronic Programming:

Easily adjust the programming to set limits and program new remotes.



Automatic Lighting System:

Dual Bulb lighting system supplies light for safer evening exits and entries. Turns ON when door is activated and automatically turns OFF 4 minutes later.



CodeDodger® Encryption:

An encryption system that enhances the security of the door opener by continuously changing the access code each time the remote is used. The door opener responds to each new code only once. An access code copied from a working system and tried again, will not control the door opener.



Vehicle Compatible:



Home Link® and Car2U® compatible. See instructions in this manual, refer to the motor vehicle manual or visit www.OverheadDoor.com for instructions.



Factory Programmed Remote Control:

For ease and speed of installation, the remote included with this opener comes from the factory already programmed. No additional steps are required to activate the door using the remote.

1 & 2



Series II Wall Console:

Operates door opener from inside garage. The wall console has an indicator light with:

Open/Close, Sure-lock™, and independent light control buttons.

1. Indicator Light: Large white button will display Red when wall console is properly wired and Sure-Lock™ is OFF. When Sure-Lock™ is ON, this light is off.
2. Open/Close Button: Use this button to open or close garage door. When Sure-Lock™ is ON the Open/Close button will CLOSE the door only.

NOTE: Constant button pressure in the CLOSE mode will override STB fault in the powerhead and close door.

3. Independent Light Control Button: Use this button to turn the powerhead lights ON. Powerhead lighting will remain ON until this button is pressed again or a door action has been completed.
4. Sure-Lock™ Button: When Sure-Lock™ is ON, and the door is closed, the powerhead cannot be activated by the wall console or a remote.
 - Slide switch up to activate Sure-Lock™ (red light goes off).
 - Slide switch down to turn Sure-Lock™ OFF (red light goes on).

4 3

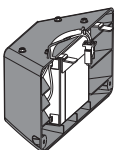

Battery Backup (BBU):

Included with 7020H-B, and available as an option on 7020H. Provides power to opener in the event of a power failure.

NOTE: Battery Backup will only operate after opener installation is completed and Travel Limits have been set.

3 OPENER PROGRAMMING

NOTE: Before programming the opener, check to make sure there are no objects in the garage door opening.

INTRODUCTION

Now that the garage door opener is installed, follow the steps in this manual to program the opener so that the door opens and closes properly and all remote devices operate correctly. The following steps are a guide to setting opener so it functions properly.

The following steps list the order of programming the opener's functional settings for use.

1. "TRAVEL LIMITS"
2. "FORCE CONTROL"
3. "REMOTE PROGRAMMING"

Term Definitions:

Travel Limits Programmable setting to adjust how far door travels up or down.

Force Control refers to how much power is needed to move (open/close) a particular door and does NOT require programming.

Remote Programming synchronizes remote devices (remote and keypad) with the powerhead.

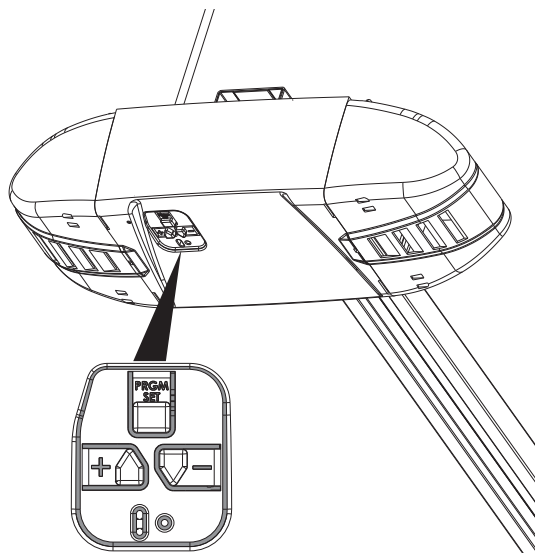

ORIENTATION

Standing under the opener's powerhead – facing the door – looking up – this is the view you will see of the programming buttons and LEDs.

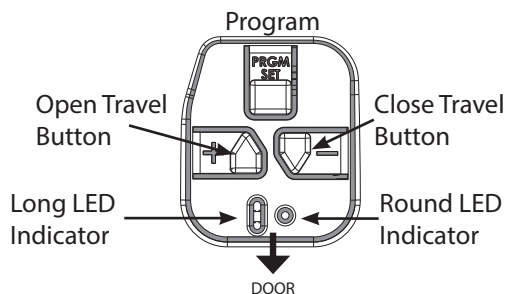

OVERVIEW OF POWERHEAD CONTROLS

This section describes the programming functions of the opener. Use the following information to understand the buttons and LED indicators used to program functions.

Powerhead: There are 3 programming buttons and 2 LED lights on the powerhead. Each of the buttons are used to enter and complete the setup programming. The LED lights indicate status or a function change by illuminating ON, OFF, or ON FLASHING.

There are 3 programs:

1. Door Travel Limits.
This program is used to set how far the door travels up and down.
2. Force Setting Program.
This program controls the force applied during the closing and opening of the door. They are factory set and will rarely require adjustment.
3. Remote Programs (default menu)—only required for added remote control transmitters.
Describes how to program remotes to sync with additional remote control devices, wall consoles, keypads and the powerhead.

NOTE: The 3 programming buttons are for programming ONLY. These buttons can NOT be used to operate the opener once the Required Programming section has been successfully completed.

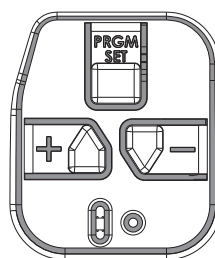

PRGM SET: Enters into and selects programming menus.

+/-: Moves door up or down during programming and advances through menus.

LEDs: Indicates various programming modes and trouble codes.

NOTE: Each programming step has a 30 second time limit for completion after the function is initiated. After 30 seconds, two LED's will illuminate RED indicating time has expired and the step must be re-started. Restart the step as many times as necessary to complete the programming.

- Just remember—the pointed end of the button (like an arrowhead) points in the direction the carriage will move when that button is pushed.

PROGRAMMING DOWN TRAVEL LIMIT

⚠ WARNING

- Make sure doorway is in full view and clear of obstacles and people to avoid injury or property damage.
- DO NOT operate this unit from the wall control before LIMITS are set. Severe damage to the opener could occur.
- The carriage MUST be engaged to turnbuckle BEFORE setting limits. See installation poster or call Customer Service at 1-800-929-3667 or visit www.OverheadDoor.com.
- DO NOT set limits with Battery Backup attached. AC power MUST be connected to the opener while setting limits for proper operation.

⚠ AVERTISSEMENT

- S'assurer que le passage de la porte est visible et dégagé, à savoir sans obstacles ni personne afin d'éviter toute blessure potentielle ou dommage matériel.
- NE PAS utiliser cette unité avec la console murale avant d'avoir réglé les LIMITES. L'ouvre-porte pourrait subir de sérieux dommages.
- La tendeur DOIT être engagée dans le chariot AVANT de régler les limites. Voir le poster d'installation (si fourni) ou appelez le service clientèle au 1-800-929-3667 ou visitez le site www.Overheaddoor.com.
- NE PAS fixer de limites en mode batterie de secours. L'alimentation CA DOIT être branchée sur l'ouvre-porte, pendant le réglage des limites, pour assurer un bon fonctionnement.

⚠ NOTE: Carriage should be locked to opener. Door should rest somewhere between full open and closed. Do not start with door fully open or closed.

Programming DOWN Limit:

1. Press and hold the DOWN arrow button.
 - Long LED will light BLUE.
2. Release DOWN arrow button.
 - Long LED will flash BLUE.
3. Press and hold the DOWN arrow button until door is fully closed.
 - Use the UP arrow button if door closes too far. Use both UP and DOWN buttons to adjust close travel as necessary.

Door should rest on the floor until the weather strip is compressed enough to seal along the width of the door. Damaged doors or uneven floors may not seal properly. Repair these conditions to achieve a proper seal. DO NOT compress seal so much that the door will bend or buckle.

4. Press and release the SET/PRGM button.
 - Both LEDs will flash BLUE then go out.

The DOWN limit is now programmed.

1-2. Enter Programming Mode

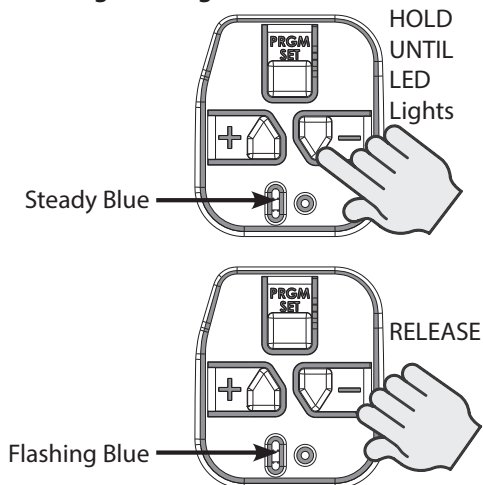

3. Adjust Door Position

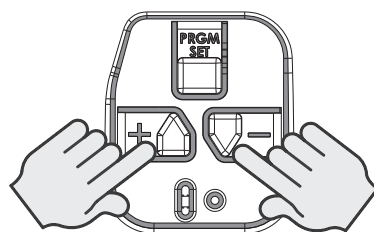

4. Lock Programming

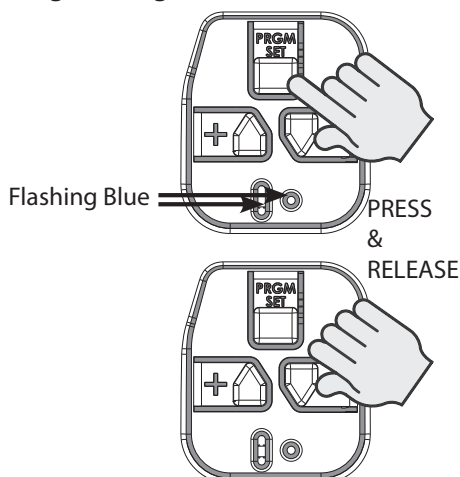

PROGRAMMING UP TRAVEL LIMIT

Programming UP Limit:

1. Press and hold the UP arrow button.
 - Long LED will light BLUE.
2. Release UP arrow button.
 - Round LED will flash BLUE.
3. Press and hold the UP arrow button until door is fully open.
 - Use the DOWN arrow button if door opens too far. Use both UP and DOWN buttons to adjust open travel as necessary.

Door should fully open so that door seal is even with door header. Do Not adjust so much that the door will bend or buckle or stretch door spring cables backward.

4. Press and release the SET/PRGM button
 - Both LEDs will flash BLUE then go out.

The UP limit is now programmed.

1-2. Enter Programming Mode

HOLD
UNTIL
LED
Lights

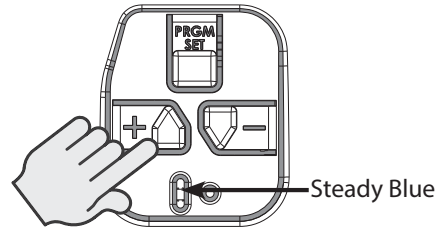

RELEASE

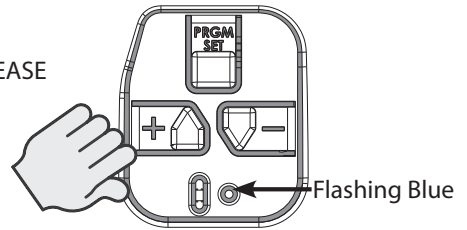

3. Adjust Door Position

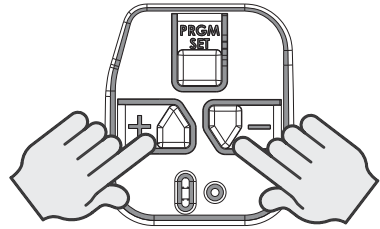

4. Lock Programming

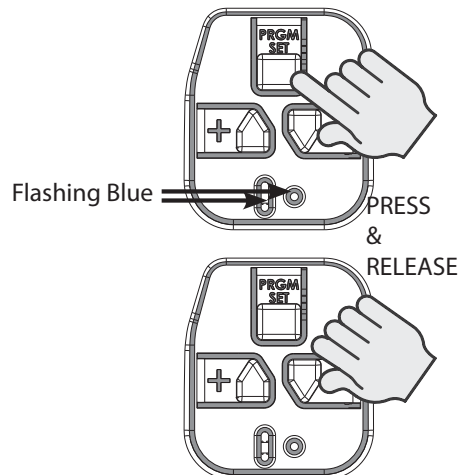

PROGRAMMING FORCE AND CONTACT REVERSE

Force Control

The force controls are automatically set when the wall control is used for the first time with garage door opener. The door **MUST** complete one full cycle, from full open to full close and then, full close to full open, before the settings are automatically recorded.

WARNING

TO AVOID INJURY OR DAMAGE

- **NEVER** adjust the force settings to adjust for damage, including an unbalanced door, binding door track or broken spring.
- Perform a CONTACT REVERSE TEST monthly.

AVERTISSEMENT

Pour éviter les blessures ou des dommages

- **NE JAMAIS** régler la force pour compenser des dommages, y compris une porte mal équilibrée, un rail de porte coincant ou des ressorts cassés.
- Tous les mois, EFFECTUEZ LE TEST D'INVERSION AU CONTACT.

1. Press and release the Wall Control button and allow the garage door to travel and stop at the DOWN limit.
2. Press and release the wall control button and allow the garage door to travel and stop at the UP limit.

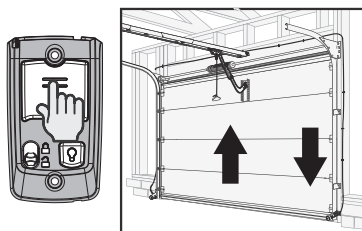

Force Control Adjustments

Force settings are programmed from the factory to remain within safe parameters. These should not require adjustments. However, certain circumstances may require adjustment. See section 4 Maintenance and Adjustments for detailed instructions pertaining to the adjustment of force controls.

Contact Reverse Test

NOTE: The limit and Force settings **MUST BE COMPLETED** before performing the Contact Reverse Test.

1. With the garage door open, lay a 2 X 4 board flat on the floor at the center of the door opening.
2. Close the garage door using the wall control.

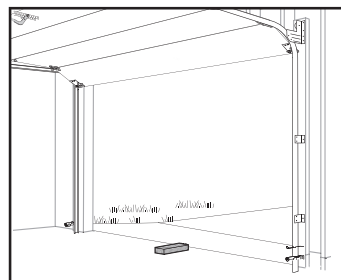
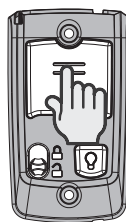

- When the door contacts the board, it should stop and reverse direction within 2 seconds to the full open position.
- The long LED light on the powerhead will begin to flash RED with the reversal of the door.
- Remove the 2" x 4" board and operate the opener with the wall control again. This cycle will clear the flashing red LEDs.

Contact Reverse Adjustment

If the door stops before contacting the board or if it does not reverse direction to fully open after contact with the board, it may be due to an improperly set DOWN limit. Verify settings by:

1. Repeat the "Down Travel Limit" section to make certain the door is closing tight against the floor.
2. Repeat the "Force Control" section on the left to set force limits.
3. Repeat the "Contact Reverse Test" above.

Repeat this process as needed until the door passes the Contact Reverse Test. For further help, refer to the "Maintenance and Adjustment" section/Regular Maintenance.

PROGRAMMING ADDITIONAL REMOTE CONTROLS

THE REMOTE CONTROLS INCLUDED WITH THIS OPENER HAVE BEEN PROGRAMMED AT THE FACTORY FOR YOUR CONVENIENCE.

NOTE: The following instructions are for remote control transmitters purchased separately in addition to those provided with this opener, but can also be used if any remote(s) may require re-programming.

NOTE: Each programming step has a 30 second time limit for completion after the function is initiated. After 30 seconds, two LED's will illuminate RED indicating time has expired and the step must be re-started. Restart the step as many times as necessary to complete the programming.

NOTE: Do not hold remote too close to the powerhead when programming remote buttons.

NOTE: Each button on each remote must be programmed separately, following these steps.

1. Remove the battery's protective film from the remote by pulling straight down.
2. Press and hold the SET/PRGM button on the opener for two seconds.
 - The ROUND LED will turn BLUE.
 - The LONG LED will then flash PURPLE.
3. Stand at least 5 feet away from opener and slowly press and release the desired button on the remote two times.
 - Both opener LEDs will flash and turn off indicating the remote has been programmed.
4. Press the desired remote button again.
 - The opener should run.

To program the same remote for other garage door openers, repeat the steps above using one of the other remaining remote buttons.

REPEAT STEPS 1 TO 4 FOR EACH OPENER AND REMOTE

NOTE: It is possible to press the remote button too quickly or lightly. If the LEDs do not go off, press the remote button several more times to achieve confirmation.

BASIC PROGRAMMING IS COMPLETE AND YOUR GARAGE DOOR OPENER IS READY TO USE.

See back of this manual to erase remote devices from memory.

1. Activate Remote

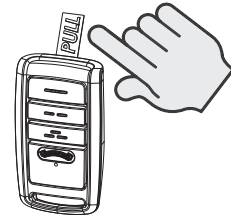

2. Enter Programming Mode

Solid Blue

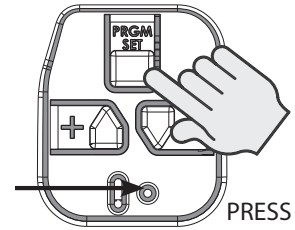

PRESS & RELEASE

Flashing Purple

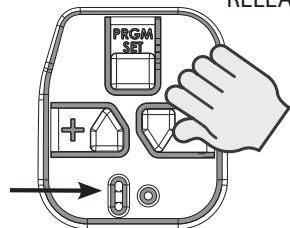

3. Press Remote Button Twice

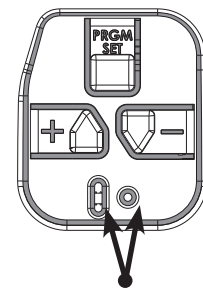

Flashing

4. Test Remote

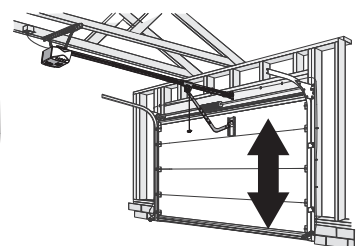

IMPORTANT SAFETY INSTRUCTIONS

⚠ WARNING

To reduce the risk of severe injury or death, read and follow all instructions.

1. **NEVER** let children operate or play with the door controls.
2. Keep remote away from children.
3. **ALWAYS** keep the moving door in sight and away from people and objects until door is completely closed. **NO ONE SHOULD CROSS THE PATH OF THE MOVING DOOR.**
4. **NEVER GO UNDER A STOPPED, PARTIALLY OPEN DOOR.**
5. Test opener monthly. The door **MUST** reverse on contact with a 1-1/2" high object (or 2" x 4" board laid flat) at the center of the doorway on the floor. After adjusting either the force or limit of travel, retest door opener. Failure to adjust the opener properly may cause severe injury or death.
6. When possible, use emergency release only when door is closed. Use caution when using this release with the door open. Weak or broken springs are capable of increasing the rate of door closing and increasing the risk of severe injury or death.
7. **KEEP DOORS PROPERLY BALANCED.** See your garage door Owner's Manual. An improperly balanced door increases the risk of severe injury or death. Have a trained door system technician make repairs to cables, spring assemblies, and other hardware.

SAVE THESE INSTRUCTIONS

IMPORTANTES CONSIGNES DE SÉCURITÉ

⚠ AVERTISSEMENT

Pour réduire le risque de blessures graves voire mortelles, lire et comprendre toutes les instructions.

1. **NE JAMAIS** permettre aux enfants d'actionner ou de jouer avec les commandes de la porte.
2. Tenir les télécommandes hors de la portée des enfants.
3. **TOUJOURS** garder en vue la porte en mouvement et tenir à l'écart toute personne ou objet jusqu'à ce que la porte soit totalement fermée. **PERSONNE NE DOIT TRAVERSER LA TRAJECTOIRE D'UNE PORTE EN MOUVEMENT.**
4. **NE JAMAIS** PASSER SOUS UNE PORTE À L'ARRÊT PARTIELLEMENT OUVERTE.
5. Tester l'ouvre-porte une fois par mois. La porte de garage **DOIT** inverser sa course au contact d'un objet de 4 cm (planche de 5 sur 10 cm) posé à plat sur le sol au centre de l'ouverture de la porte. Après avoir réglé la force ou la limite de la course, retenter l'ouvre-porte de garage. Un mauvais réglage de l'ouvre-porte peut entraîner des blessures graves voire mortelles.
6. Utiliser, dans la mesure du possible le déclenchement d'urgence uniquement lorsque la porte est fermée. Utiliser le déclenchement d'urgence avec prudence lorsque la porte est ouverte. Des ressorts faibles ou brisés peuvent faire descendre la porte rapidement ce qui peut entraîner des blessures graves voire mortelles.
7. **VEILLER À CE QUE LA PORTE SOIT CORRECTEMENT ÉQUILIBRÉE.** Consulter le manuel du propriétaire de la porte de garage. Une porte déséquilibrée pourrait entraîner de graves blessures voire mortelles. Demander à un technicien spécialisé en système de portes de se charger des réparations des câbles, des ressorts et de toute autre quincaillerie.

CONSERVER CES INSTRUCTIONS

⚠ WARNING

Opener is equipped with grounded electrical plug for your protection, and **only fits grounded electrical outlets. DO NOT** alter plug in any way! **If you have no grounded outlets, have one installed by a licensed electrician.** Opener must be properly grounded to prevent personal injury and equipment damage. **NEVER USE AN EXTENSION CORD!** Check local building codes for any requirement that you must have a permanent hard-wired connection. Permanent hard-wired connections must be performed by a licensed electrician using proper tools and instructions.

⚠ AVERTISSEMENT

L'opérateur, qui est équipé d'une prise électrique mise à la terre pour votre protection **est compatible uniquement avec des prises électriques mises à la terre. NE PAS** modifier la fiche d'une quelconque manière. Si vous n'avez pas de prises mises à la terre, faites-en installer par un électricien agréé. L'opérateur doit être correctement mis à la terre pour éviter les blessures corporelles et des dommages matériels. **NE JAMAIS UTILISER DE RALLONGE!** Vérifiez les codes locaux des bâtiments pour connexions câblées permanente. Les connexions câblées permanentes doivent être effectuées par un électricien agréé qui se servira d'outils appropriés et respectera les consignes.

⚠ WARNING

- Garage door hardware (springs, cables, brackets, pulleys, etc.) are under extreme pressure and tension.
- **DO NOT** attempt to repair or adjust door springs or any hardware, and **DO NOT OPERATE** garage door automatically or manually if door is improperly balanced or springs are broken.
- **CONTACT A TRAINED DOOR SYSTEM TECHNICIAN.**

⚠ AVERTISSEMENT

- La quincaillerie de la porte de garage (ressorts, câbles, supports, poulies, etc.) sont sous des pressions et des tensions extrêmes.
- **NE PAS** réparer ni régler les ressorts de la porte ou toute autre pièce de quincaillerie et **NE PAS ACTIONNER** la porte manuellement ou automatiquement si elle n'est pas correctement équilibrée ou si des ressorts sont cassés.
- **CONTACTEZ UN TECHNICIEN SPÉCIALISÉ EN SYSTÈME DE PORTES**

4

MAINTENANCE & ADJUSTMENTS

! WARNING

Use of any other wall control can cause unexpected operation of the door and loss of lighting feature. Locate wall console within sight of the door but far enough from door to prevent contacting it while operating the console. Control must be at least 5 feet above the floor to prevent small children from operating it.

! AVERTISSEMENT

L'utilisation d'une autre commande murale pourrait produire des résultats inattendus de la porte ainsi que le dysfonctionnement de l'éclairage. Localisez la console murale en vue de la porte et suffisamment loin de la porte pour éviter tout contact pendant l'utilisation de la console. La commande doit être à une hauteur minimale de 1,5 m au-dessus du sol afin que les jeunes enfants ne puissent pas l'atteindre.

Regular Maintenance

Basic monthly maintenance tasks include:

- Contact Reverse Test
- Lubricate door hardware
- Safe-T-Beam® System check
- Door balance
- Remote Battery Replacement (As needed)
- Light Bulb Replacement (As needed)

A. Contact Reverse Test

See page 10.

B. Lubricate Door Hardware

Inspect door rollers and hinges and lubricate as needed using a light weight general purpose grease.

D. Door Balance (Spring Tension)

Perform the check as follows:

- With the door closed, pull manual emergency release handle DOWN and away from door and let go to disengage the carriage from the drive chain or belt (see illustration).

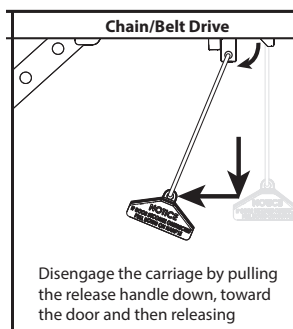

DO NOT use release cord to pull door.

C. Safe-T-Beam® (STB) System Check

Check that both the RED and GREEN LEDs are ON steady. This indicates the system is working properly. If both LEDs are not ON steady, check the appropriate items below:

- STB red LED flashes.
 - Check for obstruction.
 - Check alignment. (See page 16)
 - Verify wire routing from STBs to STB connection in powerhead
 - Check for signal interference from another Safe-T-Beam® unit (for multiple door installations).
- No STB red or green LED displayed.
 - Check wiring and wire connections

If system appears to be working properly, perform check as follows:

1. Start the door closing.
2. Pass an object through the beam. The door should stop and reverse to the fully open position.



- Raise and lower the door manually — it should move freely and smoothly.
- Raise door manually about 3' to 4' feet and let go.

- Door should remain stationary or move very slowly.
- If door moves quickly, CONTACT A TRAINED DOOR SYSTEM TECHNICIAN to have your door springs serviced.

- Close the door.
- Place the carriage in the “engage” position (see illustration).
- Operate door using remote or wall control. The carriage will reattach itself to the drive chain/belt.

E. Remote Battery Replacement (As needed)

Remote Battery Replacement (3-button)

Replace remote battery with a CR2032 coin cell battery.

1. Open remote case using a washer or coin that fits into the slot on the top of the remote.
2. Replace battery. **Be sure positive side (+) is UP.**
3. Align components and snap case closed.

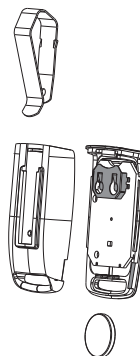

MAINTENANCE & ADJUSTMENTS

F. Light Bulb Replacement

⚠ WARNING

- Use extreme caution when working from a ladder or step stool or serious injury can occur.
- When replacing light cover, make sure wires are not pinched or near moving parts.
- Use only properly rated incandescent, LED or CFL light bulbs.
- DO NOT use bulbs with a rating greater than 60 Watts.
- Use A19 size light bulbs. DO NOT use bulbs having a short neck.

⚠ AVERTISSEMENT

- Faire particulièrement attention lors de travaux effectués depuis une échelle ou en escabeau.
- En refermant le couvercle de l'éclairage, s'assurer que les fils ne sont ni coincés ni près des pièces mobiles.
- Utilisez uniquement incandescence correctement classé, LED ou des ampoules fluocompactes.
- NE PAS utiliser des ampoules avec une note supérieure à 60 Watts
- Utilisez A19 ampoules de taille. NE PAS utiliser des ampoules ayant un cou court.

Changing Light Bulbs



1. Disconnect power to door opener.
Open powerhead light cover(s) by pressing down on upper locking tabs.
 - Replace old light bulb(s) with new.
 - Use 60 Watt MAX. incandescent bulbs or the CFL or LED equivalent.
 - Overhead Door LED light bulbs, which are specifically made for garage door openers, are recommended.*
 - Close powerhead light cover(s).
2. Reconnect power to door opener.
 - Test light operation.

NOTE: Use of standard LED bulbs may reduce the range of your remote controls.

NOTE: 7120 (iDCM) models require a minimum 40 Watt or equivalent bulb, 60 watt maximum.

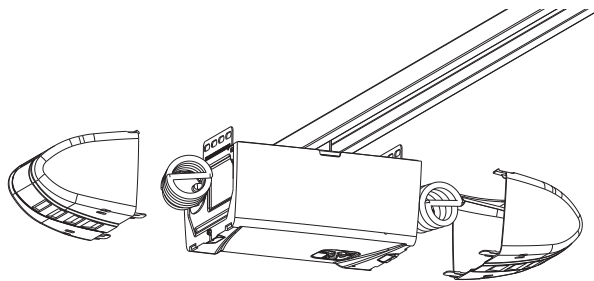

** Overhead Door LED light bulbs are designed to reduce or eliminate reduced remote range issues caused by common LED bulbs. They also offer better product life by making them resistant to vibration caused by the opener, and cold or damp weather. See website for details at www.OverheadDoor.com. recommendations for LED bulbs.*

MAINTENANCE & ADJUSTMENTS

G. Adjustment Guides

WARNING

TO AVOID INJURY OR DAMAGE

- **NEVER** adjust the force settings to adjust for damage, including an unbalanced door, binding door track or broken spring.
- Perform a CONTACT REVERSE TEST monthly. See page 10.

AVERTISSEMENT

Pour éviter les blessures ou des dommages







- **NE JAMAIS** régler la force pour compenser des dommages, y compris une porte mal équilibrée, un rail de porte coïncant ou des ressorts cassés.
- Tous les mois, EFFECTUEZ LE TEST D'INVERSION AU CONTACT. Voir page 10.

Force Settings

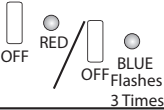



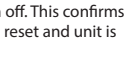













Force settings are pre-programmed at the factory and applied during the Open/Closed Limit settings steps (see page 8). For normal use, these settings should not need adjustments with this unit.

Conditions possibly requiring adjustments are:

1. Doors with very stiff weather seals.
2. Doors that start down, STOP, and reverse before closing.
3. Doors that start up, but STOP before they completely open.

Press and hold both up and down arrow buttons until round LED turns RED, release button. BLUE LED will flash 3 times.		
LEDs will now display current UP force setting (See chart).		
Press either arrow button until desired UP force setting is reached (see chart).		See Chart
Once setting is chosen, press and release. This will lock the UP force setting.		
LEDs will now show current DOWN force setting. (See Chart).		
Press either arrow button until desired DOWN force setting is reached. (See chart).		See Chart
Once setting is chosen, press and release. This will lock the DOWN force setting.		
The LEDs will now turn BLUE then off. This confirms that both force setting have been reset and unit is ready for normal operation.		
Repeat "Learn Force Limits and Contact Reverse Test" page 10		

FORCE SETTINGS CHART

Force Level	Powerhead LEDs			
	LONG LED	ROUND LED		
		OFF	Blue	Purple
Force Level 1	Off			BLUE
Force Level 2	BLUE			Off
Force Level 3	BLUE			BLUE
Force Level 4	Off			PURPLE
Force Level 5	PURPLE			Off
Force Level 6	PURPLE			PURPLE
Force Level 7	Off			RED
Force Level 8	RED			Off
Force Level 9	RED			RED

H. Resetting Travel Limits

See pages 8-9 to reset travel limits. Force setting and contact reverse test must be performed in the event of a travel limit change.

MAINTENANCE & ADJUSTMENTS

LOCATING SAFE-T-BEAM® PAIRS

Transmitter (RED LED) and Receiver (GREEN LED)

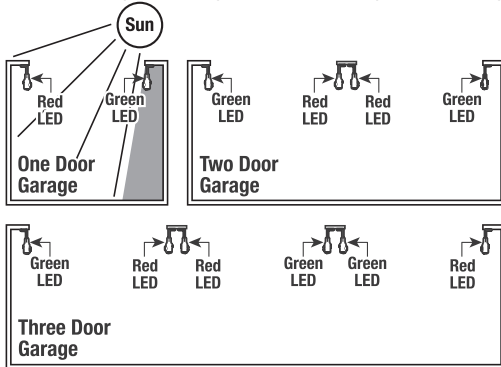

Multiple Garage Doors

- NEVER position Safe-T-Beam® modules where signals will cross.
- Place the Transmitter (Red LED) Safe-T-Beams on adjacent doors facing in opposite directions.

NOTE: Direct sunlight creates interference with Safe-T-Beam® Receiver (Green LED). STB modules CAN be positioned further away from the door opening if necessary to avoid sunlight but no further off the wall to maintain alignment with the Transmitter (Red LED) module.

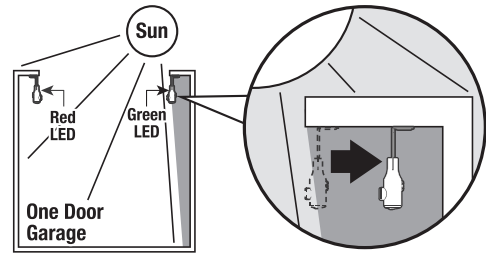

Single Garage Door

- Determine which side of the garage receives direct sunlight.
- Position the Transmitter (Red LED) on the direct sunlight side.

NOTE: Only use Safe-T-Beams® that are included with this opener. **DO NOT** use other brands or types of photocells on this opener.

WIRE DIAGRAM

⚠ WARNING

ELECTRICAL SHOCK
OPENING COVER MAY CAUSE ELECTRICAL SHOCK
Disconnect power from opener prior to removing cover

⚠ AVERTISSEMENT

CHOC ÉLECTRIQUE
OUVERTURE DE COUVERTURE PEUT PROVOQUER CHOC ÉLECTRIQUE.
Coupez l'alimentation du premier match avant de retirer le couvercle.

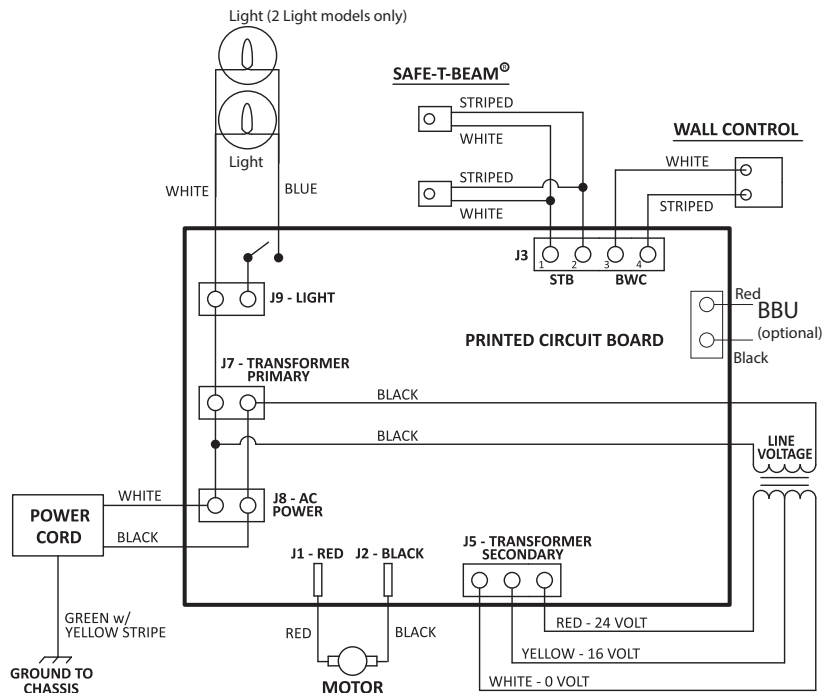

5 TROUBLESHOOTING



Need help or have questions? Call Overhead Door at 1-800-929-3667 or visit: www.OverheadDoor.com

PROBLEM:	WHAT TO DO:
Opener does NOT operate when wall control is pressed.	<ul style="list-style-type: none"> • Turn Sure-Lock™ OFF See page 6. • Check power source. <ul style="list-style-type: none"> – Plug a lamp into outlet used for powerhead. If lamp works, power source is OK. – If not, check fuse or circuit breaker. • If power is OK, <ul style="list-style-type: none"> – Check connections at powerhead terminals and at wall console. • Check for reversed, broken or cut wires. Staples can cut insulation and short wires. Repair or replace.
Opener runs, but door does not move.	<ul style="list-style-type: none"> • Make sure carriage is engaged with chain/belt turnbuckle. Refer to installation poster or download poster from www.OverheadDoor.com • Check to make sure chain/belt is not broken or off its pulley.
Opener works from wall control, but NOT from remote.	<ul style="list-style-type: none"> • Check all remotes. • Replace remote battery. See page 13. • Program remotes to powerhead. See page 11.
Remote has less than 25 feet operating range or no operation.	<ul style="list-style-type: none"> • Relocate remote inside car and /or point remote at garage door. • Replace battery. See page 13. • Reposition door opener antenna. • Eliminate possible competing signals (radio, etc.). • LED bulbs may be interfering with remote signal. See page 14.
Door starts down, then STOPS and goes back up. OR Safe-T-Beam® System malfunction.	<ul style="list-style-type: none"> • If a NEW installation, check Door Arm position. • If NEW Installation, make sure ONLY the Safe-T-Beams® that came with this opener are installed. • Check if limits are properly set. See pages 8-9. Adjust limits as needed. • Check if Safe-T-Beam® red LED is flashing. See page 16, Safe-T-Beam® system check. • Check Safe-T-Beam® system for beam obstruction or misalignment of lenses. See page 16, Safe-T-Beam® system. • Check garage door for binding. • If an operational problem exists, and opener will not close, the opener can be forced to close as follows: Press and hold the wall control button until door is completely closed. • Check for interference from adjacent Safe-T-Beam® units. See page 16. • Contact dealer at 1-800-929-3667.
Door starts down, then STOPS before it is closed. OR Door will only open.	<ul style="list-style-type: none"> • Check Safe-T-Beam® wire connection at powerhead and at STBs. See page 16, Safe-T-Beam® system check. • Check if limits are properly set. See pages 8-9. Adjust limits as needed. • Check CONTACT REVERSE. See page 10. • Check garage door for binding. See maintenance and adjustment. Page 13. • Check closing "FORCE" control. See page 10, or Force settings. Page 15.
Door starts up, but STOPS before it is completely open.	<ul style="list-style-type: none"> • Check if limits are properly set. See pages 8-9. Adjust limits as needed. • Be sure door, opener, springs are in good repair, properly lubricated and balanced. • Check closing/opening "FORCE" control. See page 10, or Force settings Page 15. • If you suspect a problem with the garage door hardware or springs, visit www.OverheadDoor.com and use the "dealer locator" to hire a local door service professional. NEVER try to repair door hardware or springs yourself.
Door will only run closed.	<ul style="list-style-type: none"> • Turn Sure-Lock™ OFF See page 6. • Check if limits are properly set. See pages 8-9. • Check door balance, condition, and door spring. • Check opening "FORCE" control. See page 10, or Force settings. Page 15. • If you suspect a problem with the garage door hardware or springs, visit www.OverheadDoor.com and use the "dealer locator" to hire a local door service professional. NEVER try to repair door hardware or springs yourself.
Door opener starts for no reason.	<ul style="list-style-type: none"> • Button stuck on wall control or remote. • Was remote lost or stolen? Erase all remotes from powerhead memory and program new remotes. See page 20.
Noisy operation.	<ul style="list-style-type: none"> • Be sure all door fasteners are tight. • Be sure garage door is in good repair, properly lubricated and balanced. • Be sure opener is in good repair.
Door opener runs slow.	<ul style="list-style-type: none"> • Check operating condition of door. Door may need professional repair/adjustment. • Is this opener installed on a one-piece door? This opener is not designed to operate a one-piece door.

TROUBLESHOOTING

POWERHEAD LEDS

Powerhead LED		Possible Problem	Solution
Round LED	Long LED		
OFF	OFF	Normal operation.	None required.
		No response from unit.	Check power supply. Contact a trained door system professional.
ON/RED/ STEADY	ON/RED/ STEADY	Limits NOT set properly.	Re-program limits, see pages 8-9.
ON/RED/ FLASHING	ON/RED/ FLASHING	Program error.	Unplug unit, wait 5 seconds, plug in.
		Component failure.	Contact a trained door system technician.
ON/BLUE/ FLASHING	OFF	Remote NOT programmed.	Program remote, see page 11.
ON/PURPLE/ FLASHING	OFF	Remote NOT programmed.	Program remote, see page 11.
ON/RED/ FLASHING	OFF	Safe-T-Beam® physical obstruction.	Remote obstruction, recheck unit.
		Safe-T-Beam® signal interference.	Check alignment of Safe-T-Beam® pair and nearest other Safe-T-Beam® pair, see page 16.
OFF	ON/RED/ FLASHING	Door contact in UP or DOWN travel.	Remove obstruction.
		Door component failure detected.	Check door spring, track, rollers, hinges and fixtures.
OFF	ON/RED/ STEADY	Thermal cutout.	DO NOT unplug unit. Wait until LED clears before operating.
ON/PURPLE/ STEADY	ON/PURPLE/ STEADY	Component error.	Contact a trained door system technician.
OFF	ON/BLUE/ FLASHING	Door will not open.	Check Sure-Lock™. Sure-Lock™ should be OFF for normal operation (see page 6).
ON/PURPLE/ FLASHING	ON/PURPLE/ FLASHING	Radio receiver error.	Unplug the unit. Wait 5 seconds and plug the unit back in. If problems persist, contact a trained door system technician.
ON/GREEN STEADY	ON/GREEN STEADY	OK=Charged, Battery Back Up	None Required
ON/GREEN FLASHING	ON/GREEN FLASHING	Discharging, Battery Back Up	Power is out. Battery in use.
ON/YELLOW FLASHING	ON/YELLOW FLASHING	Charging, Battery Back Up	None Required
ON/RED TO YELLOW FLASHING	ON/RED TO YELLOW FLASHING	Dead Battery, Battery Back Up	Replace Battery.
ON/WHITE STEADY	ON/WHITE STEADY	Battery Backup in Operation	No Fault. Courtesy light while in battery backup mode. Light will turn off after 4 minutes.

6

BATTERY BACKUP INSTALLATION

Battery backup devices from other manufacturers will not operate with this opener.

Use only Battery Backup type battery that was provided. P/N 111658.0002.S (battery only)

Installing Battery Backup

For units that included with optional battery backup (BBU)

1. Unplug powerhead from power source.
2. Tilt BBU approximately 45° and lower into slots in the top rear of the powerhead.
3. Fasten to powerhead with 2 supplied self tapping screws.

NOTE: *There are no holes in rear cover. Self Tapping screws will self tap through cover.*

4. Plug battery harness into plug located at the top of the powerhead.
5. Reconnect powerhead to power source.

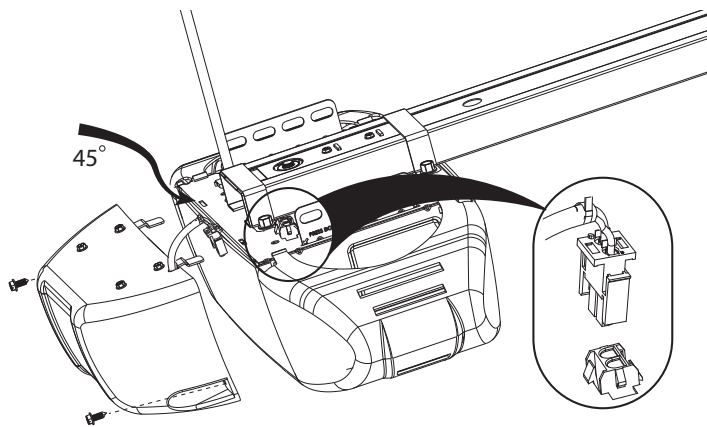

CAUTION TO PREVENT POSSIBLE SERIOUS INJURY or DEATH from electrocution AND REDUCE RISK of FIRE
 — Disconnect ALL electric power sources and battery power BEFORE performing ANY service or maintenance.
 Install only in DRY locations - NOT INTENDED FOR OUTDOOR USE.
 Use only 12V,5AH, SLA replacement battery
 (P/N 111658.0002.S).

ATTENTION POUR ÉVITER LES BLESSURES GRAVES VOIRE MORTELLE PAR ÉLECTROCUTION POUR RÉDUIRE ES RISQUES D'INCENDIE
 — Débrancher toutes les sources d'alimentation électriques et la pile avant d'effectuer des opérations de réparation ou d'entretien.
 Installer uniquement dans des endroits secs—NE DOIT PAS ÊTRE UTILISÉ À L'EXTÉRIEUR.
 Utiliser uniquement une pile de remplacement de 12V,5AH,SLA (réf.111658.0002.S).

See page 18 for Condition LED's That will illuminate once Battery Backup is operational.
 Both LED's will signal solid GREEN under normal, fully charged, operation.

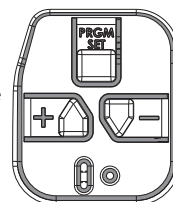

Testing The Battery Backup

NOTE: *It is recommended that the battery backup be allowed to charge for 24 to 48 hours prior to testing. Initially, the opener may not operate from the battery backup mode if battery is not fully charged.*

1. Run the opener using the wall control or remote to ensure it is working properly.
2. Turn off power to opener by unplugging from outlet or turning off breaker.
3. Press wall control or remote control. Opener will run at a slower speed than normal.

NOTE: *See troubleshooting guide (pg. 18) in this manual if any of the steps above fail. Work light will not operate while in battery backup mode. (Courtesy white LED's will illuminate.)*

4. After successful test, reconnect powerhead to power source.

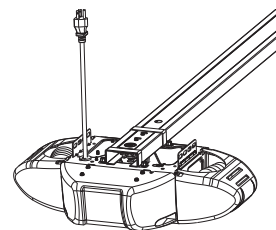

Completed Assembly

Replacing The Battery in the Battery Backup

Proper care should be used when handling a battery. Eye protection should be worn.

NOTE DO NOT reverse polarity (+) and (-) as this will damage the powerhead.

1. Unplug powerhead from power source.
2. Unplug battery backup from harness connection.
3. Remove both mounting screws from rear of battery backup.
4. Detach battery backup from back of opener by tilting the BBU approximately 45 degrees and lifting up towards the ceiling.
5. Remove 4 screws from battery hold down bracket.
6. Remove battery.
7. Disconnect harness wires from the (+) and (-) terminals.
8. Replace in reverse order

NOTE: *Allow 24-48 hours to charge battery before testing.*

9. Test as noted above.

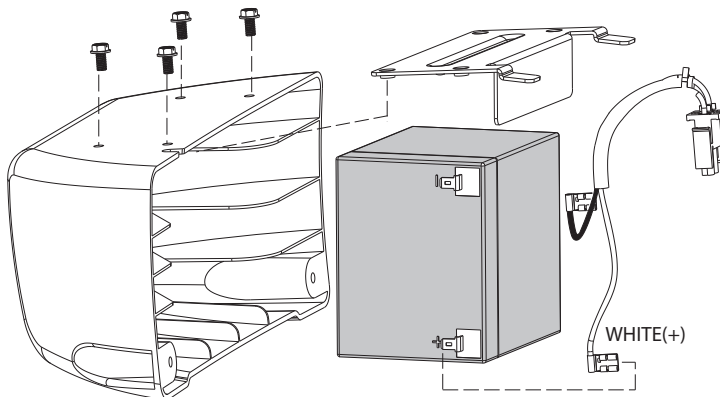

CLEARING MEMORY OF REMOTES

NOTE: Clearing memory of remotes from the powerhead will clear ALL programmed remotes, wireless keypads and vehicle transmitters. The opener will no longer recognize any signal from any remote device, including a missing remote device.

All remaining (or recovered) remotes, vehicles and wireless keypads MUST be reprogrammed.

NOTE: The garage door opener will operate normally using the wall console.

1. Press and hold the SET/PRGM button on the opener for two seconds.
 - The ROUND LED will turn BLUE.
 - The ROUND LED will then flash PURPLE.
2. Press and hold the UP & DOWN buttons at the same time until both LEDs turn off.
 - Both opener LEDs will flash and turn off indicating that all remotes have been erased.
3. Press any remote button.
 - The opener should NOT run.

To deprogram the same remote for other garage door openers, repeat the steps above using one of the other remaining remote buttons.

1. Enter Programming Mode

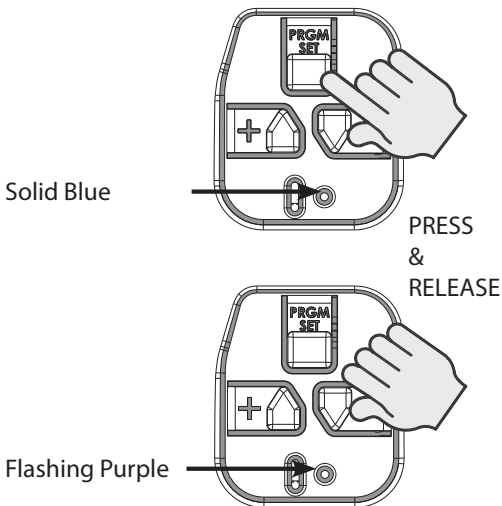

2. Press and Hold + & - Buttons

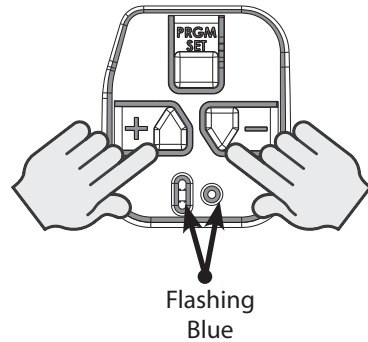

Release when LEDs turn off

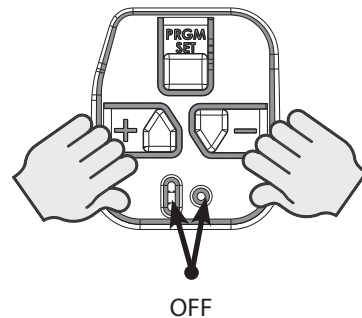

3. Test Remote

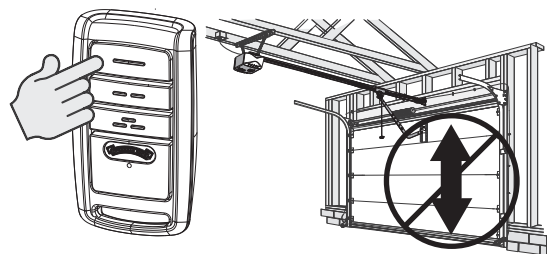

VEHICLE PROGRAMMING

Programming HomeLink® System

Step 1 Clear HomeLink

Clear HomeLink by pressing and holding down the first and third buttons until the indicator on the HomeLink blinks slow and then fast for 20 seconds; then release both buttons.

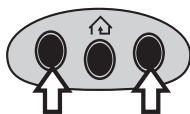

NOTE: Clearing the HomeLink will remove all previously programmed garage door openers.

Step 2 Train HomeLink to the Remote

Choose the button on the HomeLink that will be used to open the door.

NOTE: Hold the Remote two inches from the HomeLink button.

Hold down the remote button. While holding, press and hold the chosen HomeLink button.

Hold down both buttons until the indicator on the HomeLink blinks slow then fast. Once it blinks, release both buttons.

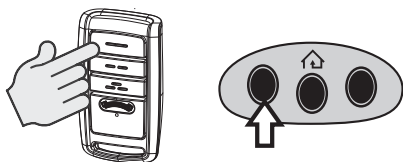

Step 3 Program HomeLink to the Opener

A. Press and hold the **PROGRAM** button on the opener until the round blue LED is ON. Release the button. The long purple LED will begin flashing.

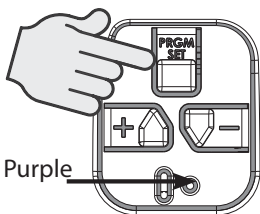

B. Press the chosen HomeLink button for two seconds and release. Press that same button again for two seconds and release. The long LED will flash blue and then turn off.

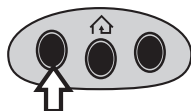

C. Press the HomeLink button a few more times until door moves.

NOTE: For additional instructions, see the motor vehicle manual, www.homelink.com or visit www.OverheadDoor.com

Programming Car2U® System

Step 1 Clear Car2U to default settings

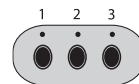

The default setting for the Car2U system is:

- Button 1 = Overhead Door Manufactured Openers
- Button 2 = LiftMaster® Manufactured Openers
- Button 3 = Wayne Dalton® Manufactured Openers

- Press and hold buttons 1 and 3 for 20 seconds or until all three LEDs begin to flash.
- Release both buttons. The Car2U system is now set to the Factory Default settings

NOTE: Clearing the Car2U remote will remove all previously programmed garage door openers.

Step 2 Program Car2U to the Opener

- Press and hold the **PROGRAM** button on the opener until the round blue LED is ON—release the button. The long purple LED will begin flashing.

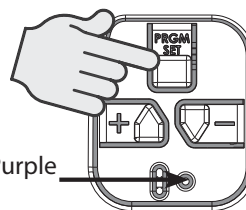

- Press the designated Car2U button for two seconds and release. Press that same button again for two seconds and release. The long LED will flash blue and then turn off.

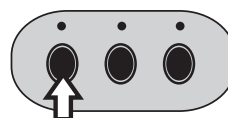

- Press the Car2U button a few times more until door moves.

Step 3 Changing Factory Default Button for a Overhead Door Opener

- Press and hold buttons 1 & 3 for **ONE SECOND** and release—all three LEDs will light solid red.
- Press and hold the button (2 or 3) to change it to Overhead Door—the corresponding LED will flash. While continuing to hold that button, press and release button 1. Press and release button 1 again.
- Release the button being held in step B and wait for the LED to stop flashing. This button is now set for Overhead Door. Repeat Step 2 for second Opener.

NOTE: For additional instructions see the motor vehicle manual, learcar2u.com or visit www.OverheadDoor.com

WIRELESS KEYPAD PROGRAMMING

Tip: Program Keypad before mounting.

Keypad Overview:

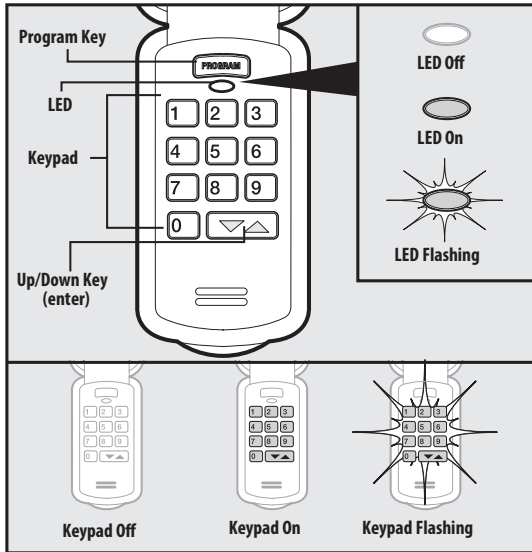

Activate keypad by opening battery compartment and pull protective tab. Reinstall compartment door to begin programming.

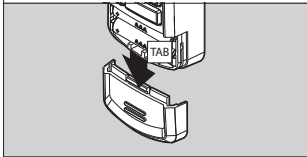

STEP 1) PROGRAMMING A PIN NUMBER

Program the keypad for the first time* with a Personal Identification Number (PIN). This PIN must be 3 to 8 digits.

1. Ensure number pad back lighting is off.
2. Press 3-5-7 in sequence.
3. Press PROGRAM key. *LED will blink once per second.*
4. Enter a PIN number (3-8 digits).
5. Press PROGRAM key. *LED will blink twice and shut off.*
 - The keypad is now programmed with a PIN number and ready to program to the garage door opener(s).
 - See STEP 2A to program 1 opener.
 - See STEP 2B PROGRAMMING FOR MULTIPLE OPENERS if using keypad to operate up to 3 doors.
 - If LED did not blink twice and shut off, please see RESETTING THE KEYPAD (FACTORY DEFAULT) section.

STEP 2A) PROGRAMMING THE KEYPAD TO 1 OPENER

1. Place garage door opener into PROGRAMMING MODE.
2. Ensure number pad back lighting is off.
3. Enter the PIN number on keypad.
4. Press the UP/DOWN key 3 to 4 times slowly until garage door opener operates.
 - This completes the programming of a single door. See STEP 3 SINGLE DOOR OPERATION for further instruction.

STEP 2B) PROGRAMMING THE KEYPAD FOR MULTIPLE OPENERS (UP TO 3)

Program the keypad with a Personal Identification Number (PIN) as described in step 1. Then follow these additional steps.

1. Ensure number pad back lighting is off.
2. Enter PIN as programmed in STEP 1.
3. Press PROGRAM key twice. *LED will blink once per second.*
4. Enter total number of openers that keypad will be operating. (2 or 3).
5. Press PROGRAM key once. *LED will blink twice and shut off.*
 - **NOTE:** Only one PIN number can be used.
 - The keypad is now programmed with a PIN number and set up for multi opener operation. Keypad is now ready to program to multiple garage door openers.
 - If LED did not blink twice and shut off, please see RESETTING THE KEYPAD (FACTORY DEFAULT) section.

PROGRAMMING THE KEYPAD TO MULTIPLE OPENERS (UP TO 3)

1. Place desired garage door opener (1, 2, or 3) into PROGRAMMING MODE as illustrated in the section below.
2. Ensure number pad back lighting is off.
3. Enter the PIN number on keypad.
4. Press the UP/DOWN key once.
5. Press the number of the desired door (1, 2 or 3).
6. Press the UP/DOWN key 3-4 times slowly until garage door opener operates.
 - Repeat steps 1 through 6 to program second and third openers.
 - This completes programming of multiple doors. See STEP 3 MULTI-DOOR OPERATION for further instruction.

PUTTING OPENER INTO PROGRAMMING MODE:

1. Press and hold the program button until the round LED turns blue, then release.
2. The round LED will go out and the long LED will begin flashing purple.
3. Return to STEP 2A or 2B.

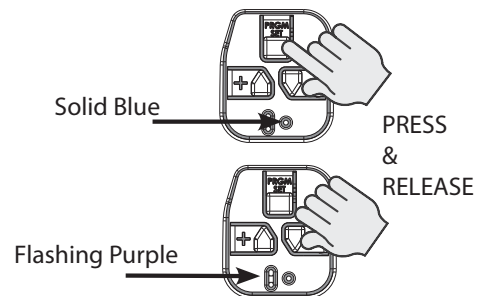

NOTE: The openers LEARN LED will time out in 30 seconds. Programming must be completed within 30 seconds.

* RESETTING THE KEYPAD (FACTORY DEFAULT):

If the keypad has already been programmed or at any time the programming should be erased and started from the factory default, follow these steps.

1. Ensure that number pad back lighting is off.
2. Press and hold the PROGRAM and UP/DOWN Keys together for approximately 5 seconds.
3. The LED will flash twice and all lights will go out indicating the keypad has been reset.
4. Start at STEP 1 to program a new PIN number.

WIRELESS KEYPAD PROGRAMMING

STEP 3) OPERATING THE KEYPAD WITH THE OPENER(S)

Single Door Operation:

1. Ensure number pad back lighting is off.
2. Enter PIN number.
3. Press the UP/DOWN key.
4. Opener will operate.

Multi-Door Operation:

1. Ensure number pad back lighting is off.
2. Enter PIN number.
3. Press the UP/DOWN key.
4. Press number key corresponding with desired door (1, 2, or 3).
5. Desired opener will operate.

NOTE: Keypad will remain active for 15 seconds after a successful entry is made. During this 15 seconds ANY key will operate the opener.

STEP 4) MOUNTING THE KEYPAD

Keypad MUST be mounted within sight of the garage door(s) at least 5 feet above floor and clear of any moving door parts.

- Programming will not be lost during battery change.
1. Remove battery cover and batteries.

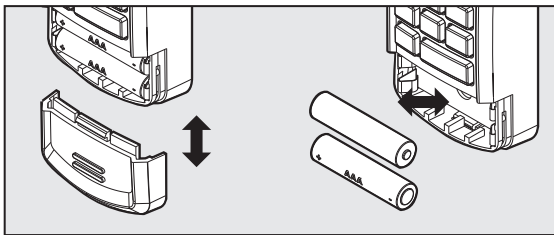

2. Drill a 3/32" pilot hole for the top mounting screw.
3. Install included screw into pilot hole, leaving 1/8" gap between the screw head and wall.
4. Hook the slotted mount on back of keypad over the screw.

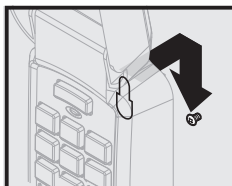
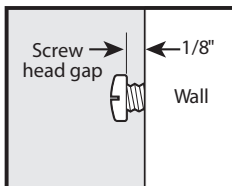

5. Mark and drill a 3/32" pilot hole for the bottom screw and secure keypad to the wall. (Do not over-tighten).
6. Reinstall batteries.

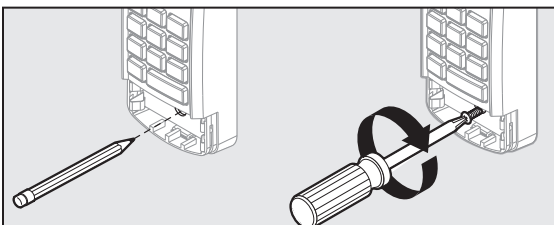

REPLACING BATTERIES

If the keypad back-lighting fails to operate, Batteries may require replacement.

- Programming will not be lost during battery change.

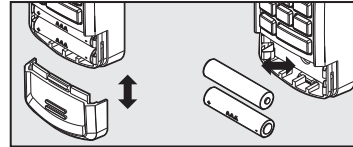

1. Remove battery cover and batteries.
2. Replace batteries with same type alkaline (AAA) and check for proper direction of (+) and (-) terminals. Rechargeable batteries are NOT recommended.

ADDITIONAL (OPTIONAL) PROGRAMMING:

Changing an Existing PIN:

1. Enter current PIN
 2. Press PROGRAM key once.
 3. Enter new PIN.
 4. Press PROGRAM key once.
- Original PIN will no longer operate keypad or opener.

Setting a Temporary PIN:

A temporary PIN allows temporary access to the garage by, normally unauthorized, personnel such as repairmen or neighbor.

1. Enter current PIN.
 2. Press PROGRAM key 3 times.
 3. Enter a temporary PIN (3 to 8 digits)
 4. Press PROGRAM key once.
- The Temporary PIN will operate garage door opener until the original PIN is used. Use of the original PIN will delete temporary PIN.

FCC Part 15.21 Statement:

Changes or modifications not expressly approved by the party responsible for compliance could void the user's authority to operate the equipment.

FCC / IC Statement:

This device complies with FCC Part 15 and Industry Canada licence-exempt RSS standard(s). Operation is subject to the following two conditions: (1) this device may not cause harmful interference, and (2) this device must accept any interference received, including interference that may cause undesired operation of the device.

Le présent appareil est conforme aux CNR d'Industrie Canada applicables aux appareils radio exempts de licence. L'exploitation est autorisée aux deux conditions suivantes : (1) l'appareil ne doit pas produire de brouillage, et (2) l'utilisateur de l'appareil doit accepter tout brouillage radioélectrique subi, même si le brouillage est susceptible d'en compromettre le fonctionnement.

8

POWERHEAD PARTS

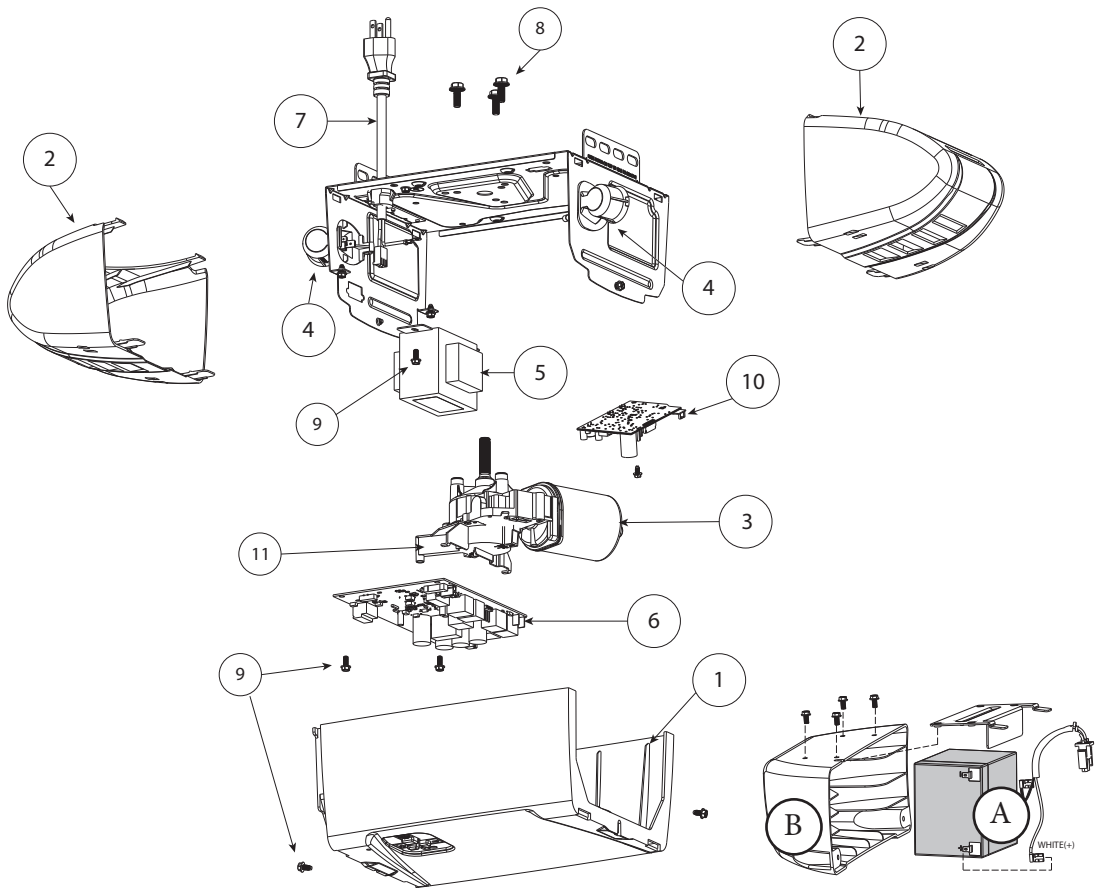

Item	Description	QTY.
1	COVER	1
2	LENS	2
3	MOTOR & OPTO ASSEMBLY	1
4	SOCKET, ANGLED LIGHT	2
5	TRANSFORMER, 120VAC	1
6	PCB, DC CONTROLLER WITH BBU	1
7	POWER CORD, 72"	1
8	SCR, M6-1 X 12 HWH THDF (3pk)	1
9	SCR, HHD, SLTD, TAP, #8X5/1 (3pk)	2
10	iDCM CONTROL BOARD	1
11	OPTO ASSEMBLY	1
A	BATTERY ONLY	1
B	BATTERY BACKUP COVER W/SCREWS	1

NOTE: The following kits will include all necessary harnesses, and/or hardware required for reassembly and detailed assembly instructions.

• Motor Assemblies	• Idler Pulley Assembly
• PCB	• Transformer Assembly
• DC Controllers	• Chain & Belt Kits
• Light Sockets	• Covers

CHANNEL PARTS

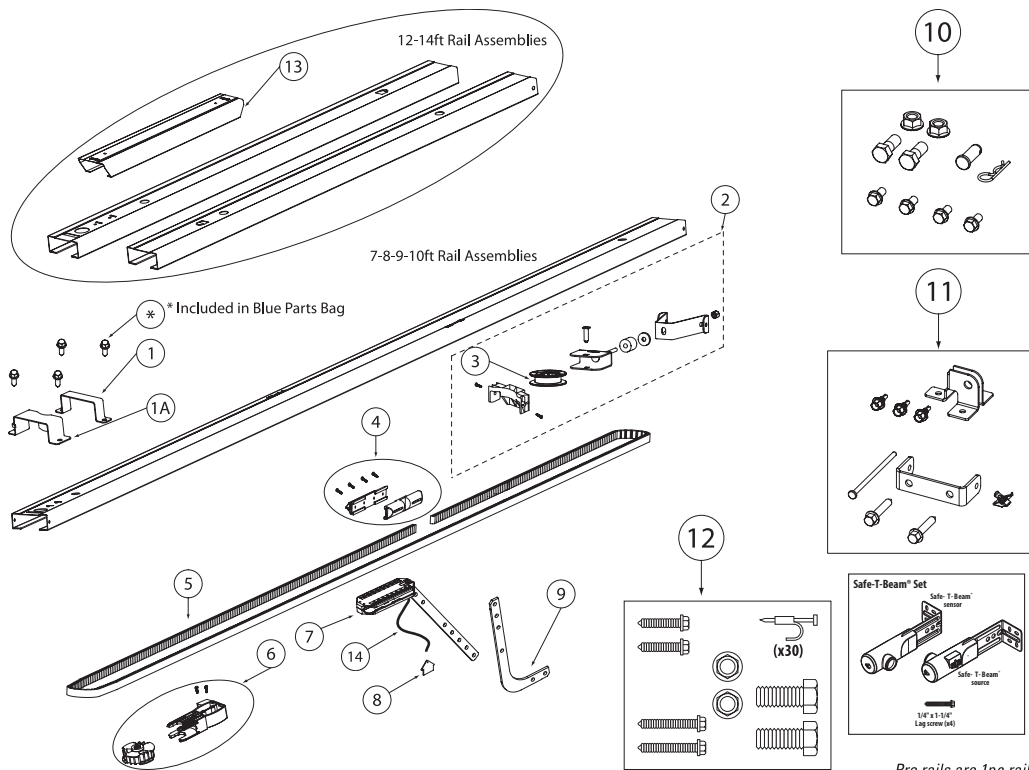

Pro rails are 1pc rails.
*Belt version shown here

Item	Description	QTY.
1	Head To Rail Bracket (2 for Chain, 1 for Belt)	1
1A	Head To Rail Bracket Belt Guard (Belt only)	1
2	Tensioner Assembly	1
3	Pulley Tensioner	1
4	Chain Bullet Assembly	1
	Belt Bullet Assembly	1
5	Chain & Bullet Assembly, 7 ft	1
	Chain & Bullet Assembly, 8 ft	1
	Chain & Bullet Assembly, 10 ft (292")	1
	Chain & Bullet Assembly, 10 ft (303")	1
	Belt & Bullet Assembly, 7 ft	1
	Belt & Bullet Assembly, 8 ft	1
	Belt & Bullet Assembly, 9 ft (268")	1
	Belt & Bullet Assembly, 9 ft (279")	1
	Belt & Bullet Assembly, 10 ft (292")	1
	Belt & Bullet Assembly, 10 ft (303")	1
6	Chain Drive Sprocket Assembly	1
	Belt Drive Sprocket Assembly	1
7	Carriage Assembly, 7 ft Doors	1
	Carriage Assembly, 8 ft Doors	1
	Carriage Assembly, 9, 10 ft Doors	1

8	Carriage Release Handle	1
9	Curved Door Arm	1
10	Installation Parts Pack (Blue Bag)	1
11	Mounting Parts Pack (Orange Bag)	1
12	Hanging Hardware Parts Pack (Green Bag)	1
14	Release Cord Assembly, 7' (32")	1
	Release Cord Assembly, 8' (44")	1
	Release Cord Assembly, 9-14' (116")	1
NS	Wire Clips, (50 pcs)	1
NS	Rail Extender Kit, 8' Chain (for 7' Retail Rail)	1
NS	3PC Service Rail, C-Channel Chain Drive Rail	1
NS	3PC Service Rail, C-Channel Belt Drive Rail	1
	Yellow parts bag, Photocells	1

IMPORTANT INFORMATION

Automatic Garage Door Opener and Garage Door Safety and Maintenance Guide

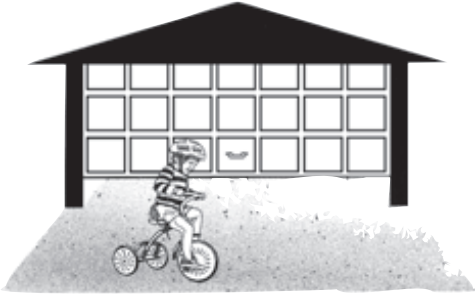

Garage Door Openers Are Not Toys



Do not stand or walk under a moving door! Do not let children or adults play "beat the door." It is dangerous and can result in serious injury or death. Adults should set a good example. Know how to use the emergency release, in case someone is pinned by the door.

Garage Door System Safety- An Automatic Decision

A garage door is the largest moving object in the home. They are often operated by electric door openers. Proper installation, operation and maintenance and testing of the garage door and automatic opener are necessary to provide safe, trouble-free operation. An improperly adjusted garage door or automatic opener can exert deadly force when the door closes. This could lead to serious injury or death from being hit by a closing garage door or from being trapped under the door.



Safety if Everyone's Business

A few simple precautions can protect our family and friends from potential harm. Please take a few minutes to read the following safety and maintenance tips. Refer to your garage door and opener owner's manual for details specific to your garage door and automatic opener.



Do not let children play with or use the transmitters or remote controls. Always place or store them out of the reach of children.



Some of the following precautions and warnings are identified with this "Safety and Alert Symbol." This symbol indicates a potential personal safety hazard that can result in injury or death.

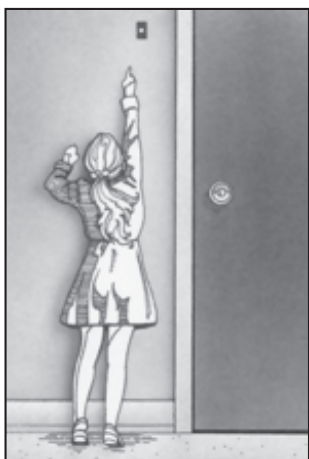

The pushbutton wall control should be out of the reach of children (at least 5 feet from the floor) and away from all moving parts. Mount and use the button where you can clearly see the moving garage door



Teach children to keep their hands and fingers clear of section joints, hinges, track, springs and other door parts. Contact with a moving door or its hardware could cause serious injury. These injuries can also happen with garage doors that don't have automatic openers.

Teach Your Children About Garage Door and Opener Safety

Garage door openers are not toys. Careless operation and allowing children to play with or use garage door opener controls can lead to tragic results. Discuss garage door safety with your children. Explain the danger of being trapped under the door.

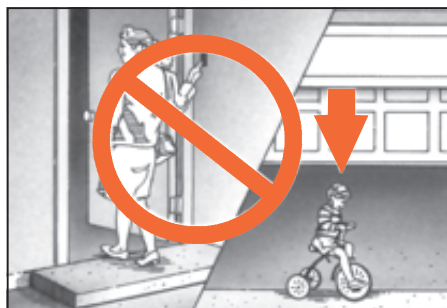

When using the pushbutton or transmitter, keep the door in sight until it completely stops moving. Teach children never to play under or near an open garage door.

Routine Maintenance Can Prevent Tragedies

Take a few minutes to inspect and test your complete garage door system. Make monthly inspection and testing a part of your regular routine. Safety is everyone's business. Make garage door and garage door opener safety automatic in your home.

Monthly Maintenance Checklist.

Garage Door Opener

- Reversal Test
- Force Setting Test
- Additional safety devices

Garage Door

- Visual inspection-springs, rollers, pulleys, cables and track
- Lubrication
- Door balance test

Consult owner's manual for additional recommended maintenance for your models of door and manual.

Testing and Maintaining The Garage Door Opener

There are routine Safety and Maintenance steps that you should follow once a month. Review your owner's manual for the door opener. If you don't have the owner's manual, look for the opener model number on the back of the power unit and request a manual from the manufacturer

Reversal Test

Make sure your opener has a reversing feature. If a reversing feature is not present, it should be replaced. Garage door openers manufactured after January 1, 1993 are required by federal law to have advanced safety features which comply with the latest UL 325 Standards. Contact your manufacturer or installer for additional information.

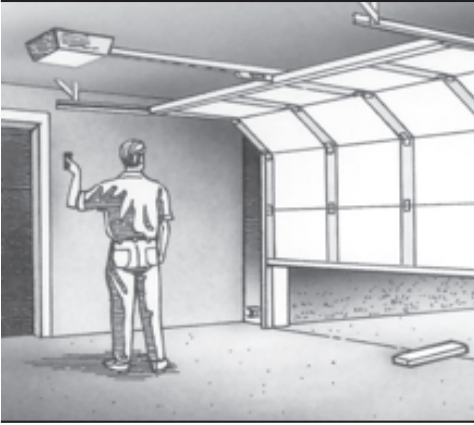

Test the Reversing Feature every month.

- First test the balance of the door (see “Testing and Maintaining the Garage Door”). If the door is properly balanced, proceed.
- With the door fully open, place a 1-1/2” thick piece of wood (a 2” x 4” laid flat) on the floor in the center of the door opening.
- Push the transmitter or wall button to close the door. The door must reverse when it strikes the wood. (Note that the bottom part of “one-piece doors” must be rigid so that the door will not close without reversing.)
- If the door does not reverse, have it repaired or replaced. Have a qualified individual adjust, repair or replace the opener or door.

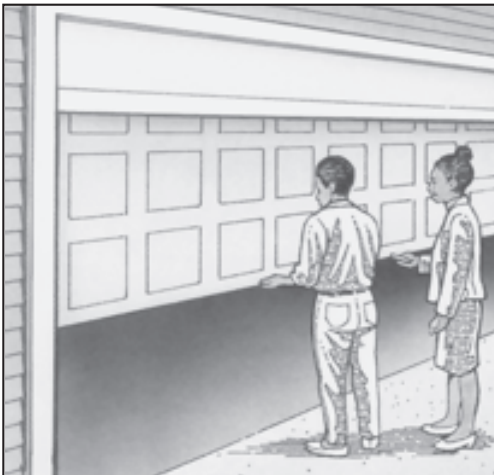

Force Setting Test

Test the force setting of your garage door opener by holding the bottom of the door as it closes. If the door does not reverse readily, the force may be excessive and need adjusting. See your owner’s manual for details on how to make the adjustment. Test the reversing feature after any adjustment.

Additional Safety Devices

Many garage door openers can be equipped with additional safety devices. Consider adding a photo eye or edge sensor as an extra measure of safety to protect against entrapment. Keep in mind that adding more safety devices will not make an old opener meet current UL Standards.

Make sure the additional safety devices, such as photo eyes or edge sensors, are properly installed and adjusted (see owner’s manual).

Testing and Maintaining The Garage Door

Perform routine maintenance steps once a month. Review your owner’s manual for the garage door. If you don’t have a manual, look for the model number on the back of the door, or check the lock handle, hinges or other hardware for the manufacturer’s name and request a manual from the manufacturer.

Visual Inspection

Look at the garage door springs, cables, rollers, pulleys and other door hardware for signs of wear. If you suspect problems, have a qualified person make repairs.



WARNING - Springs are under high tension. Only qualified persons should adjust them.

Garage door springs, cables, brackets and other hardware attached to the springs, are under very high tension and, if handled improperly, can cause serious injury. Only a qualified professional or a mechanically experienced person carefully following the manufacturer’s instructions should adjust them. The torsion springs (the springs above the door) should only be adjusted by a professional. Do not attempt to repair or adjust torsion springs yourself. A restraining cable or other device should be installed on the extension spring (the spring along the side of the door) to help contain the spring if it breaks.

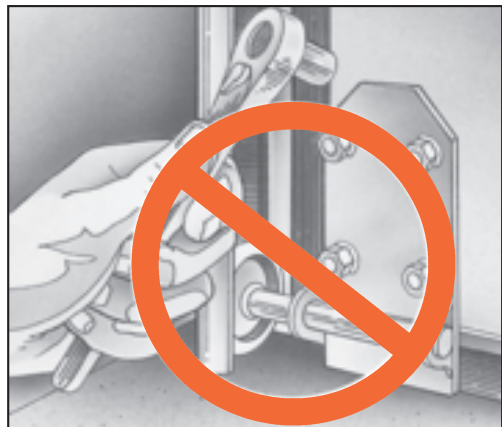

Never remove, adjust or loosen the screws on the bottom brackets of the door. These brackets are connected to the spring by the lift cable and are under extreme tension.

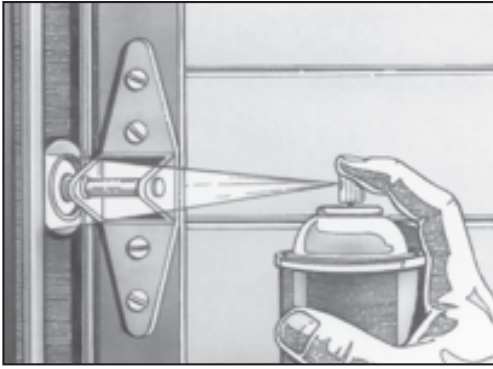

Lubrication

Regularly lubricate the moving parts of the door. However, do not lubricate plastic parts such as plastic rollers and plastic idler bearing. Consult the door owner's manual for the manufacturer's recommendation.



Door Balance

Periodically test the balance of your door.

- Start with the door closed.
- If you have a garage door opener, use the release mechanism so you can operate the door by hand when doing this test.
- You should be able to lift the door smoothly and with little resistance. It should stay open around three or four feet above the floor. If it does not, it is out of adjustment. Have it adjusted by a qualified service person.

Garage Door Opener Safety- An Automatic Decision

This important information is provided by the U.S. Consumer Product Safety Commission, the National Safety Council and the Industry Coalition for Automatic Garage Door Opener Safety.



**National
Safety
Council**



Legacy® 920, Models 7020H, 7020H-B, 7120H, 7120H-B Limited Warranty

The Distributor of Overhead Door Corporation products, whose name appears below ("Seller") warrants to the original purchaser of the Legacy® 920, Models 7020-H, 7020H-B or garage door opener ("Product"), subject to all of the terms and conditions hereof, that the Product and all components thereof will be free from defects in materials and workmanship for the following period(s) of time, measured from the date of purchase:

MOTOR/GEARBOX –
Legacy® 920, Models 7020H, 7020H-B - FIFTEEN (15) YEARS

BELT - Fifteen (15) YEARS for Belt Drive Product
or
CHAIN - Five (5) YEARS for Chain Drive Product

ACCESSORIES - ONE (1) YEAR

CORE UNIT PARTS** -
Legacy® 920, Models 7020H & 7020H-B - THREE (3) YEARS.

OTHER PARTS - Parts and components not part of the Core Unit** - ONE (1) YEAR

**Limited Lifetime" shall mean for as long as the original purchaser owns the home in which the Product is originally installed

** The "Core Unit" consists of the power head, wired wall control, Safe-T-Beam® system, J-Arm and rail.

Seller's obligation under this warranty is specifically limited to repairing or replacing, at its option, the Product or any part thereof which is determined by Seller to be defective during the applicable warranty period. Any labor charges are excluded and will be the responsibility of the purchaser.

This warranty gives you specific legal rights, and you may also have other rights which vary from state to state. This warranty is made to the original purchaser of the Product only, and is not transferable or assignable. This warranty applies only to Product installed in a residential or other non-commercial application. It does not cover any Product installed in commercial or industrial building applications. This warranty does not apply to any unauthorized or improper installation, alteration or repair of the Product, or to any Product or component which has been damaged or deteriorated due to misuse, neglect, accident, failure to provide necessary maintenance, failure to follow owner's manual instructions, normal wear and tear, or acts of God or any other cause beyond the reasonable control of Seller, and does not cover batteries, use of extension cord, missing or damaged parts from clearance or open box sales, or repairs or maintenance to door components.

ALL EXPRESS AND IMPLIED WARRANTIES FOR THE PRODUCT, INCLUDING BUT NOT LIMITED TO ANY IMPLIED WARRANTIES OF MERCHANTABILITY AND FITNESS FOR A PARTICULAR PURPOSE, ARE LIMITED IN TIME TO THE APPLICABLE WARRANTY PERIOD REFLECTED ABOVE. NO WARRANTIES, WHETHER EXPRESS OR IMPLIED, WILL APPLY AFTER THE LIMITED WARRANTY PERIOD HAS EXPIRED. Some states do not allow limitations on how long an implied warranty lasts, so the above limitation may not apply to you.

IN NO EVENT SHALL OVERHEAD DOOR CORPORATION OR ITS PARENT OR AFFILIATES BE RESPONSIBLE FOR, OR LIABLE TO ANYONE FOR, SPECIAL, INDIRECT, COLLATERAL, PUNITIVE, INCIDENTAL OR CONSEQUENTIAL DAMAGES, even if Overhead Door Corporation has been advised of the possibility of such damages. Such excluded damages include, but are not limited to, loss of use, cost of any substitute product, or other similar indirect financial loss. Some states do not allow the exclusion or limitation of incidental or consequential damages, so the above limitation or exclusion may not apply to you.

Claims under this warranty must be made promptly after discovery and within the applicable warranty period. To obtain warranty service, you must contact the Seller at the address or phone number listed below or by calling 1-800-929-3667 and, if requested, attempt reasonable troubleshooting measures, as well as provide proof of the date and location of purchase, identification as the original purchaser and a description of the claimed defect. Purchaser must allow Seller a reasonable opportunity to inspect the Product claimed to be defective prior to removal or alteration of its condition. Upon determination by Seller that the Product or any part thereof is defective during the applicable warranty period (which may require purchaser to return the Product to Seller at purchaser's expense), Seller will supply the purchaser with replacement parts or, at its option, a replacement Product (shipping and handling of any replacement Product or parts also at purchaser's expense). Seller may use new or reconditioned parts, or a new or reconditioned Product of the same or similar design.

There are no established informal dispute resolution procedures of the type described in the Magnuson-Moss Warranty Act

PURCHASER: _____
INSTALLATION ADDRESS: _____
DATE PURCHASED: _____
OPENER MODEL: _____
REMOTE CONTROL MODEL: _____
DATE OF INSTALLATION: _____
NAME OF DISTRIBUTOR/INSTALLER: _____
ADDRESS OF DISTRIBUTOR/INSTALLER: _____
SERIAL NUMBER: _____

The Genuine. The Original.



Overhead Door Corporation

1-800-929-3667

WWW.OverheadDoor.com