

# Benchmarking EV and HEV Technologies

**Tim Burress**

**Oak Ridge National Laboratory**

2014 U.S. DOE Vehicle Technologies Office Annual Merit Review and Peer Evaluation Meeting

June 17<sup>th</sup>, 2014

Project ID: APE006

This presentation does not contain any proprietary, confidential, or otherwise restricted information



# Overview

## Timeline

- Start – FY04
- Finish – Ongoing

## Budget

- Total project funding
  - DOE share – 100%
- Received in FY13:
  - \$450 K
- Funding for FY14:
  - \$500 K

## Barriers & Targets

- Integrating custom ORNL inverter-motor-controller with OEM components.
  - Optimizing controls for non-linear motors throughout operation range.
- Intercepting, decoding, and overtaking OEM controller area network (CAN) signals.
- Adapting non-standard motor shaft and assembly to dynamometer and test fixture.
- This project helps with program planning and the establishment and verification of all DOE 2020 targets.

## Partners

- ORNL Team members
  - Lixin Tang
  - Curt Ayers
  - Randy Wiles
  - Steven Campbell
  - Zhenxian Liang
  - Andy Wereszczak
- John Deere
- ANL
- NREL
- Ames Lab

# Project Objectives/Relevance

- **Overall Objective:** The core function of this project is to confirm power electronics and electric motor technology status and identify barriers and gaps to prioritize/identify R&D opportunities
  - Assess design, packaging, and fabrication innovations during teardown of sub-systems
    - Identify manufacturer techniques employed to improve specific power and/or power density
    - Perform compositional analysis of key components
      - Facilitates trade-off comparisons (e.g. magnet strength vs coercivity) and general cost analysis
  - Examine performance and operational characteristics during comprehensive test-cell evaluations
    - Establish realistic peak power rating (18 seconds)
    - Identify detailed information regarding time-dependent and condition-dependent operation
  - Compile information from evaluations and assessments
    - Identify new areas of interest
    - Evaluate advantages and disadvantages of design evolutions
    - Compare results with other EV/HEV technologies and DOE targets
- **Objectives (March 2013 through March 2014):**
  - Complete 2013 Nissan LEAF charger teardown assessments and testing.
  - Complete 2013 Toyota Camry PCU teardown assessments.

# Milestones

Date	Milestones and Go/No-Go Decisions	Status
December 2013	<u>Go/No-Go decision:</u> Identify and procure EV/HEV components.	Go.
March 2014	<u>Milestone:</u> Complete teardown of EV/HEV components.	
June 2014	<u>Milestone:</u> Complete instrumentation and fabrication and initiate testing.	On Track.
September 2014	<u>Milestone:</u> Provide report detailing benchmarking results.	On Track.

# Approach/Strategy

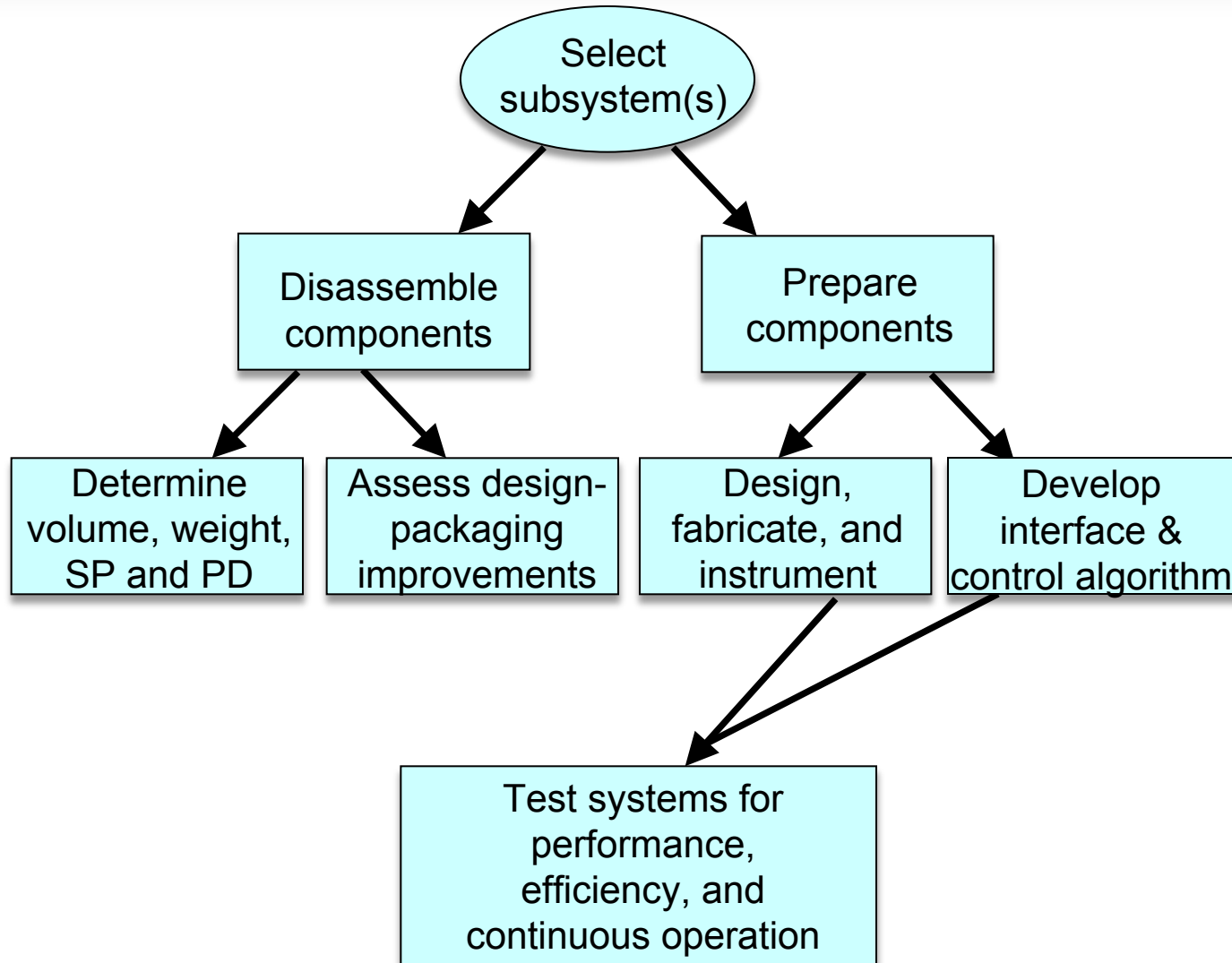

# Overall Technical Accomplishments

- Compared progressing technologies - 2004 Prius, 2006 Accord, 2007 Camry, 2008 LS 600h, 2010 Prius, 2011 Sonata, 2012 Sonata generator, 2012 LEAF, 2013 LEAF charger, and 2013 Camry PCU.

Component & Parameter	2020 DOE Targets	2012 Leaf (80 kW)	2012 Sonata HSG 23 (8.5 kW)	2011 Sonata (30 kW)	2010 Prius (60 kW)	2008 LS600h Lexus (110 kW)	2007 Camry (70 kW)	2013 Camry (105 kW)	2004 Prius (50 kW)
<b>Motor</b>									
Peak power density, kW/L	5.7	4.2	7.42 (2.7)	3.0	4.8	6.6	5.9		3.3
Peak specific power, kW/kg	1.6	1.4	1.9 (0.7)	1.1	1.6	2.5	1.7		1.1
<b>Inverter</b>									
Excludes generator inverter (parenthetical values exclude boost converter mass/volume for Toyota Vehicles)									
Peak power density, kW/L	13.4	5.7	5.6 (2.0)	7.3	5.9 (11.1)	10.6 (17.2)	7.4 (11.7)	12.7 (19.0)	4.5 (7.4)
Peak specific power, kW/kg	14.1	4.9	5.4 (2.0)	6.9	6.9 (16.7)	7.7 (14.9)	5.0 (9.3)	11.5 (17.2)	3.8 (6.2)

Note: All power density and specific power levels in table are not apples-to-apples. (e.g. LEAF and Sonata have continuous capability near their published rated power)



# Technical Accomplishments (1)

2013 Nissan LEAF On-board Charger Assessments Completed – same mass as inverter

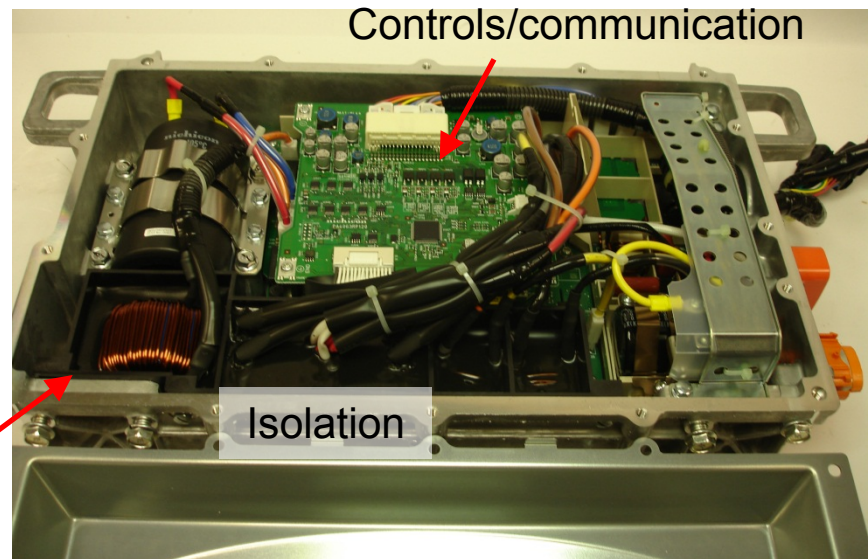
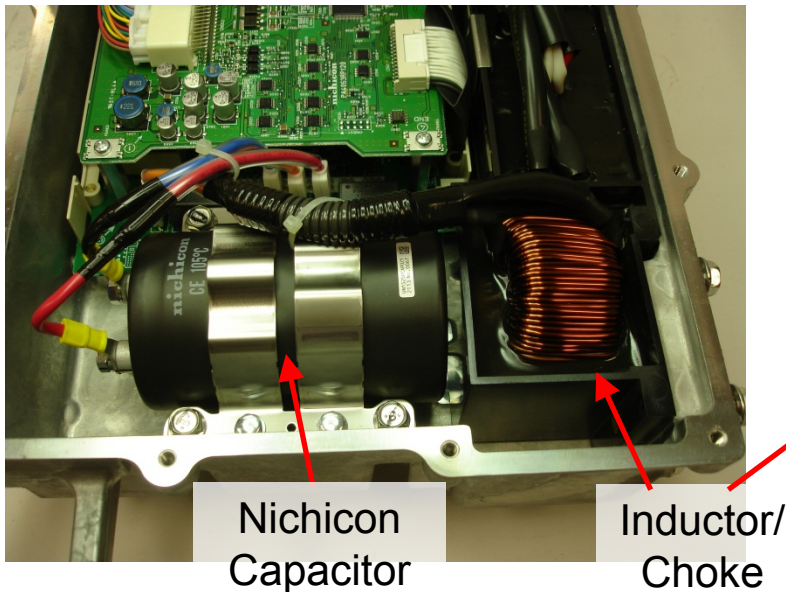
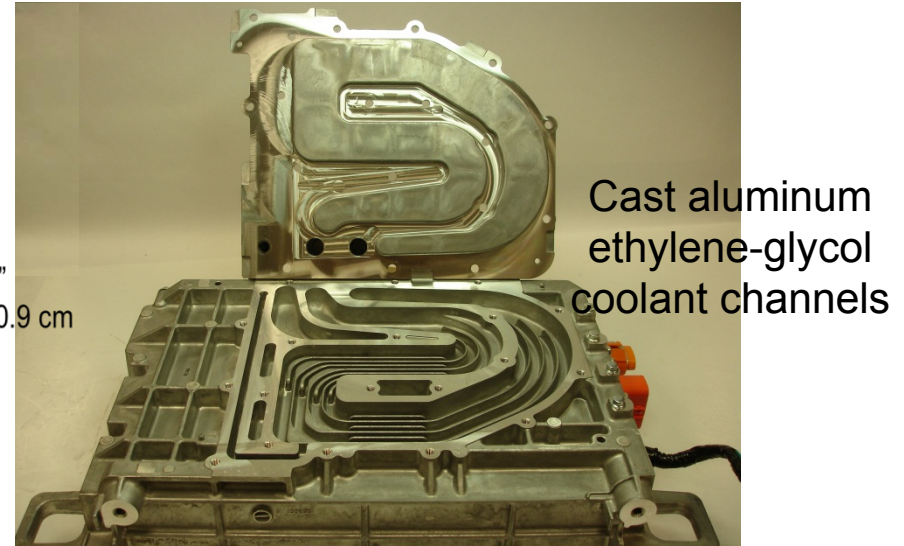
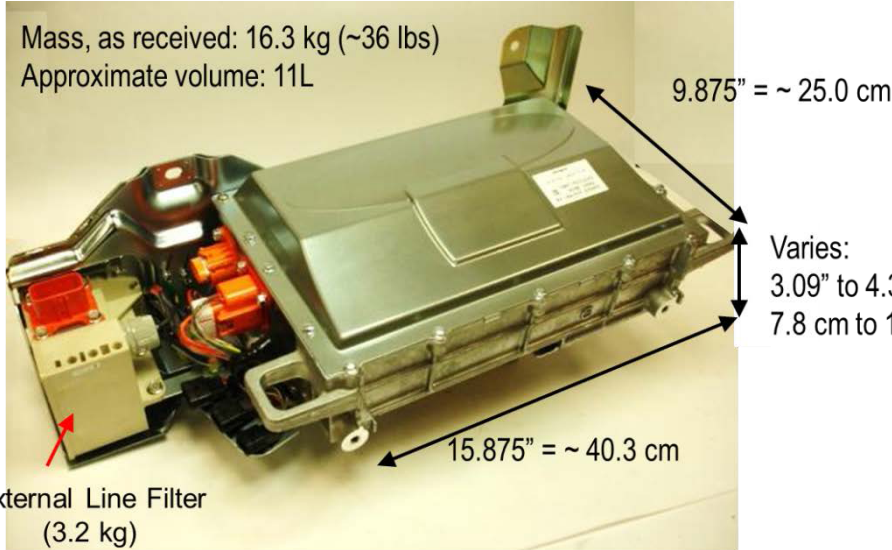

# Technical Accomplishments (2)

## 2013 Nissan LEAF On-board Charger

- Several power stages
- 124-240 VAC input
- 380 V nominal output
- Why so large?
  - Power quality concerns for both grid and battery
  - Need for isolation

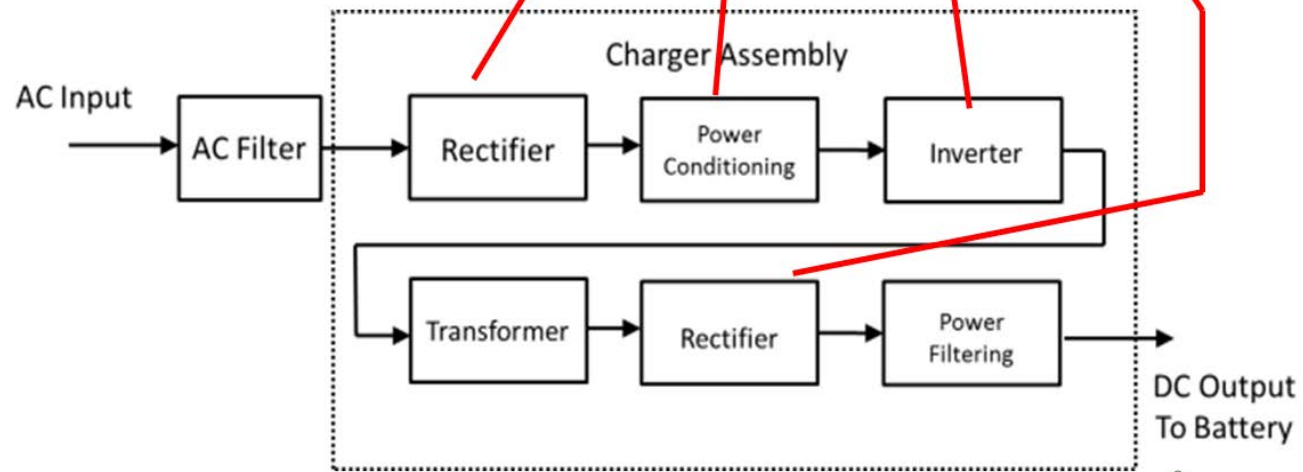
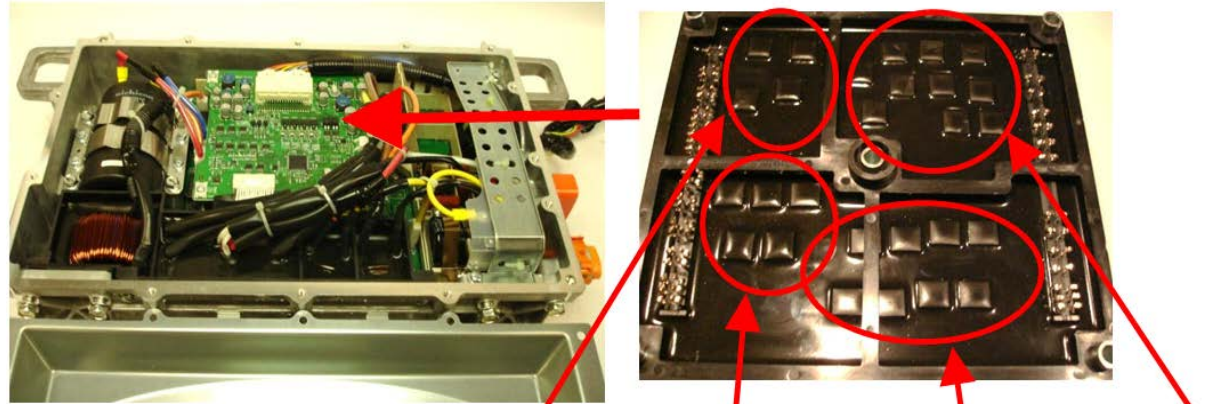



# Technical Accomplishments (3)

- Typical charger circuitry except for
  - Dual secondary isolation transformer
  - Two secondary side full bridge diode rectifiers in series
  - Combination of control and power driver isolation

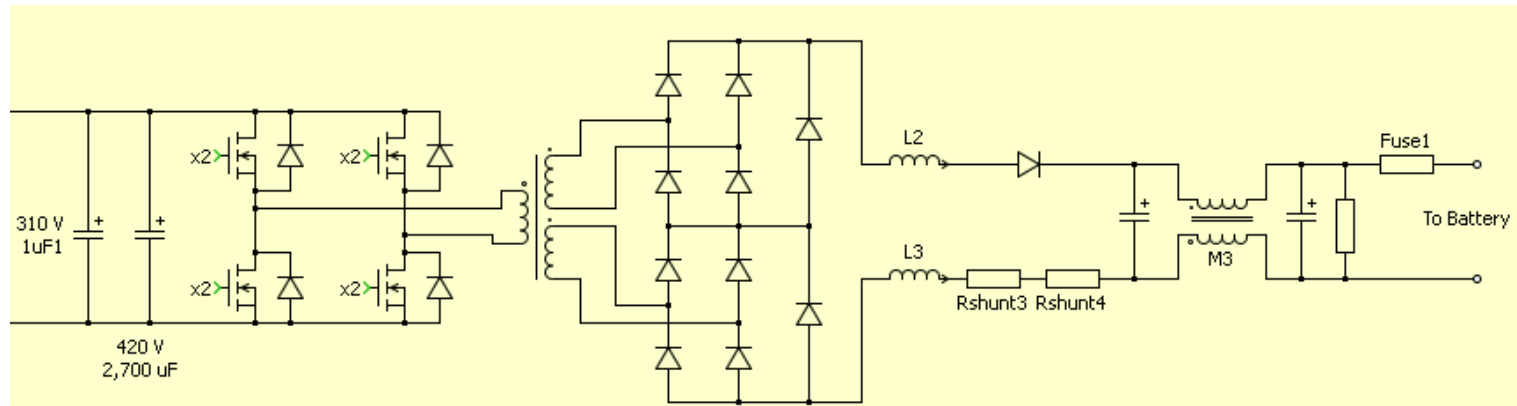
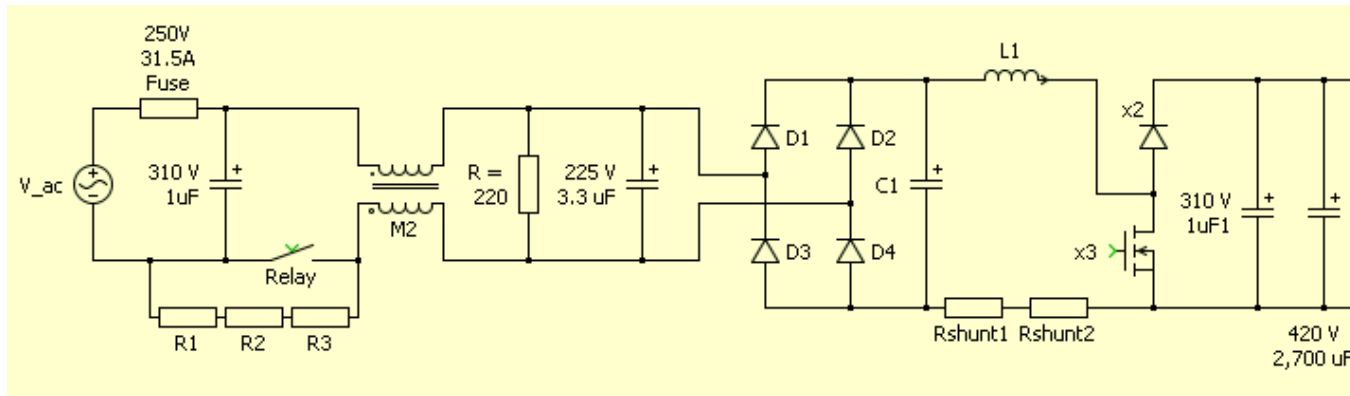

# Technical Accomplishments (4)

- Team was able to overtake OEM controls and operate the system at will.
- PFC test results
  - Zero crossing looks great (often a troublesome area)
  - 92.4% efficient for 120V operation at about 3 kW
  - 96.4% efficient for 240V operation at about 6 kW

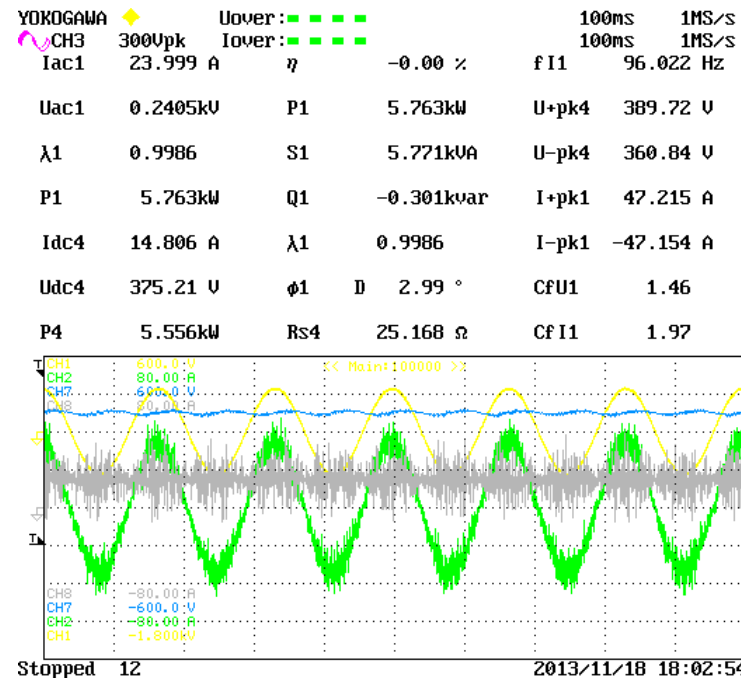
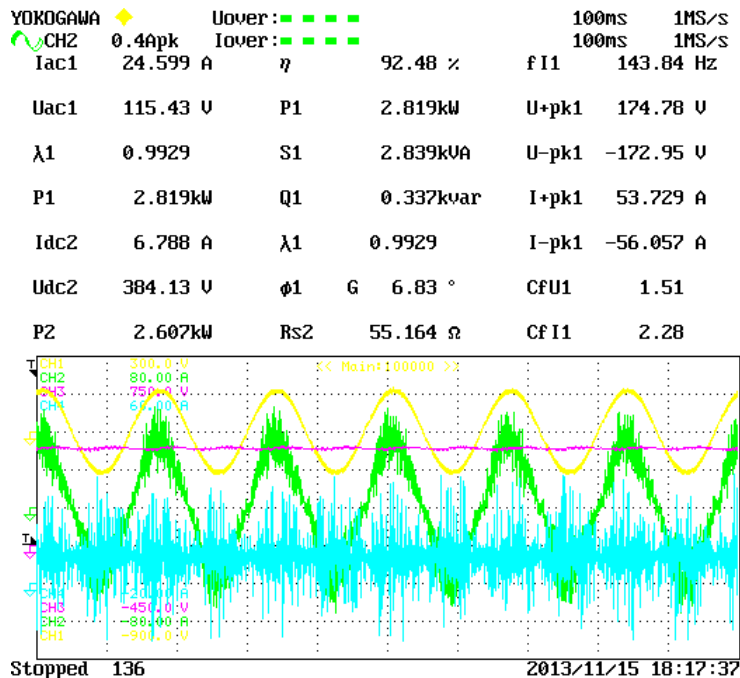

Copy
Copy to
File
File List
Format
TIFF
Color Reverse Compression
<input type="checkbox"/> OFF <input type="checkbox"/> ON
File Name SIC4
Abort

# Technical Accomplishments (5)

- PFC test results
  - Use Unitrode PFC regulator
  - Chopper frequency: 30 kHz
  - Limits AC input current at about 24 Arms
- DC-DC converter efficiency was about 94% at 3.3 kW and 120V
  - Total Efficiency: ~87%
  - Approximate total efficiency for 240V operation: 91-92%

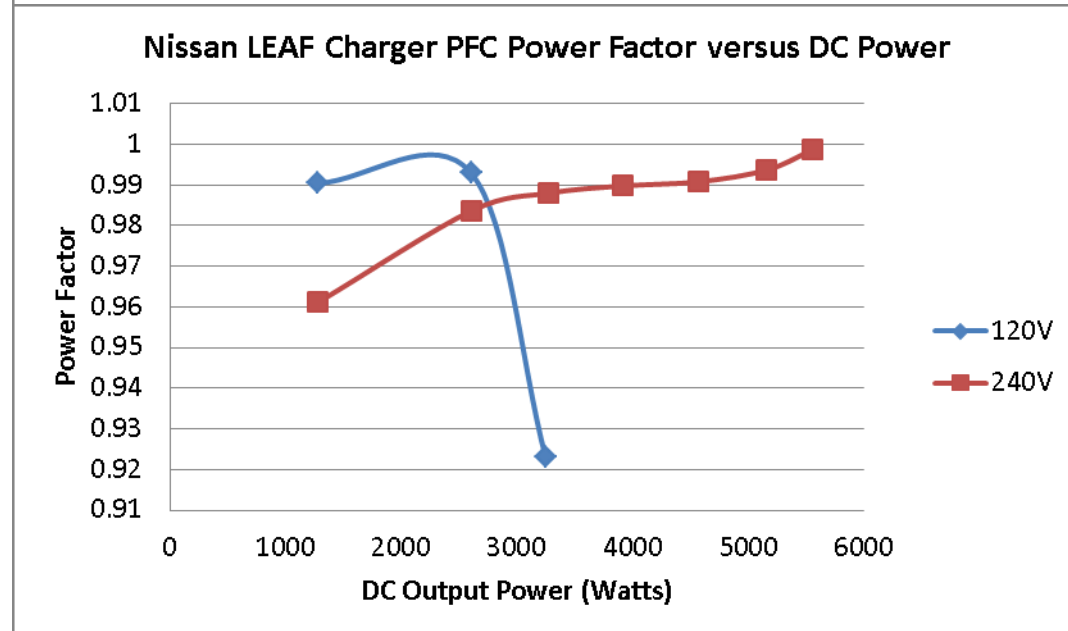
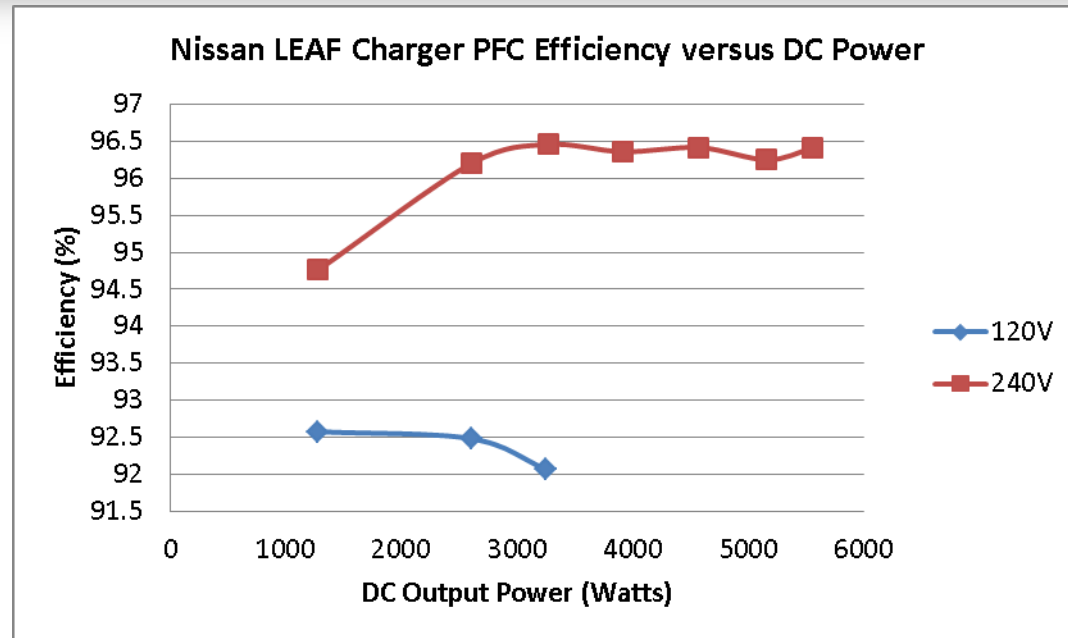





# Technical Accomplishments (7)

## 2013 Toyota Camry PCU

- Similar to 2008 LS 600h
  - Total mass: 15.3 kg
  - Total volume: 12.3 L
  - Includes several converters
    - Motor inverter
    - Generator inverter
    - Bi-directional boost converter
    - 12V ancillary converter

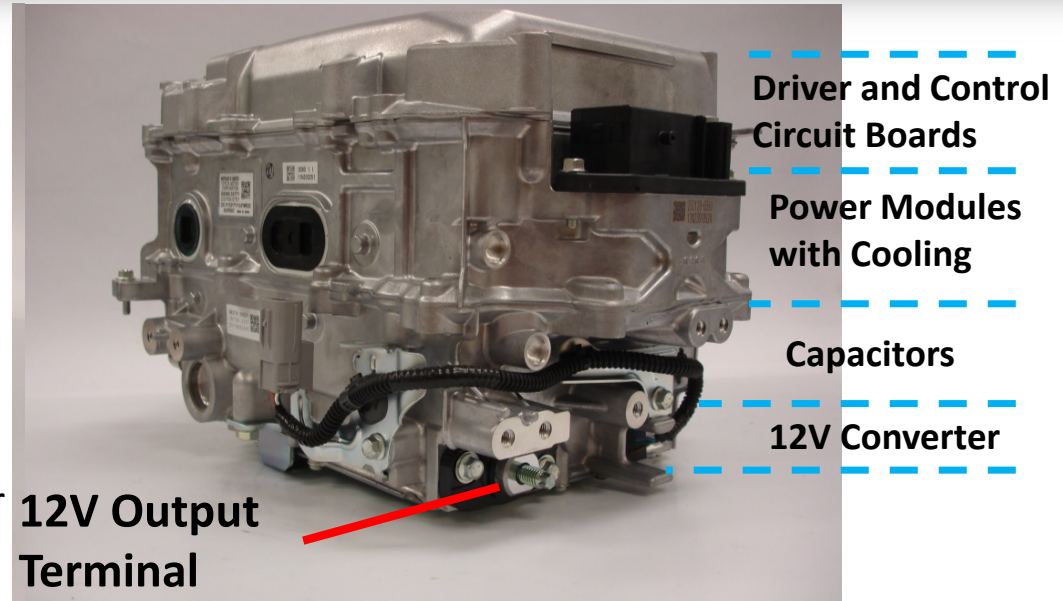

## Battery Input Terminals

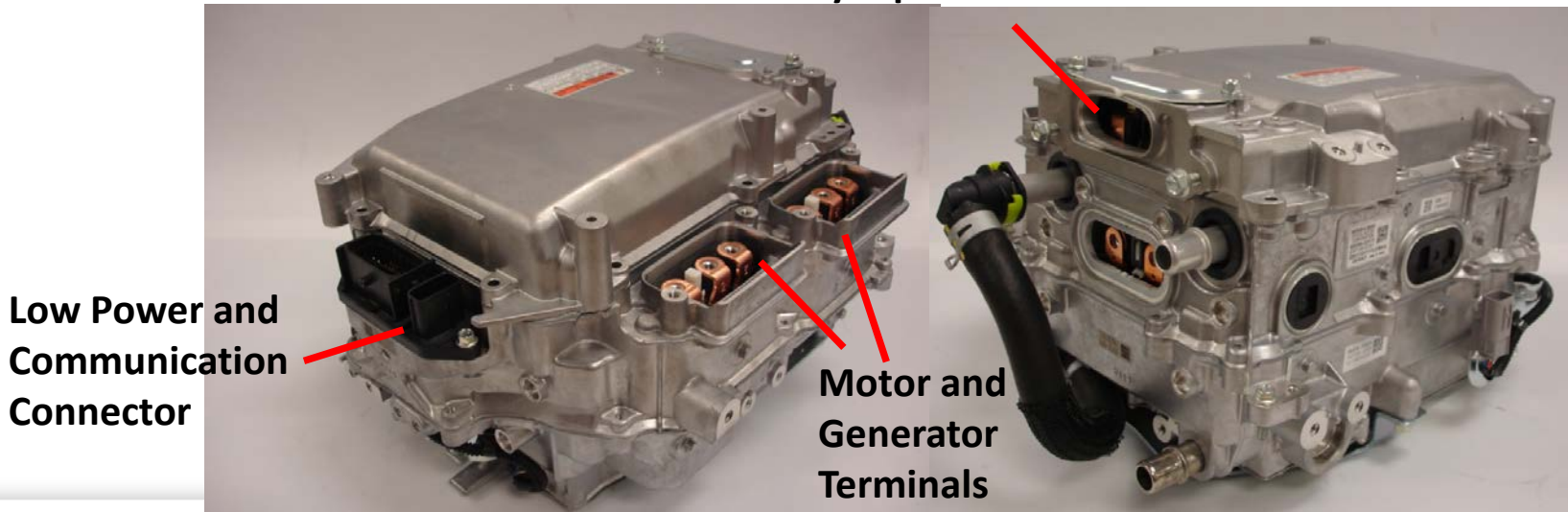



# Technical Accomplishments (8)

## 2013 Toyota Camry PCU

- Toyota System Architecture

- 420V, 320 uF capacitor at battery input
- 750V, 1600 uF capacitor on boost output/inverter DC link
- Both contained within one module made by Panasonic

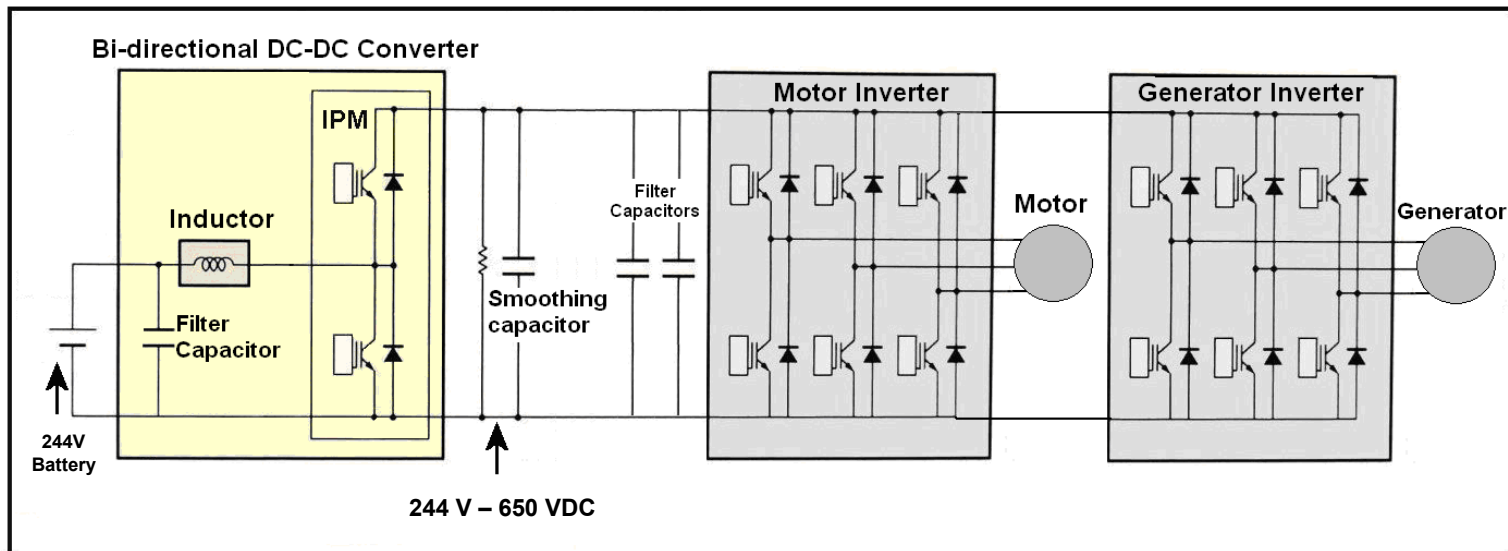

# Technical Accomplishments (9)

## 2013 Toyota Camry PCU

- Reduced size/complexity of driver circuitry
- 12 V DC-DC
  - ~3.1 kg
  - ~1.45 L

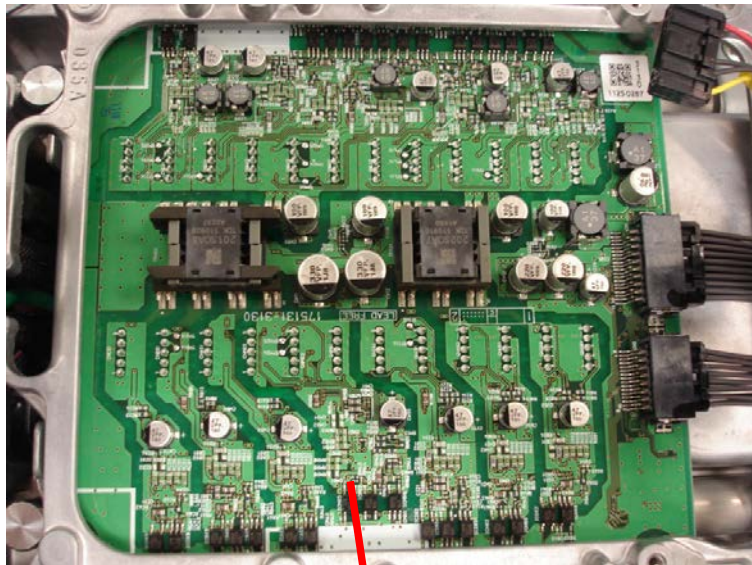
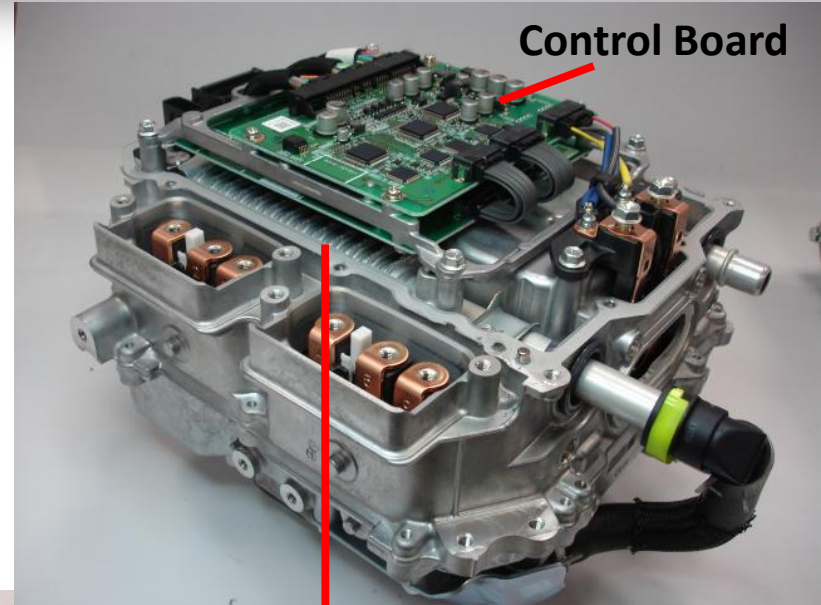

Driver Board

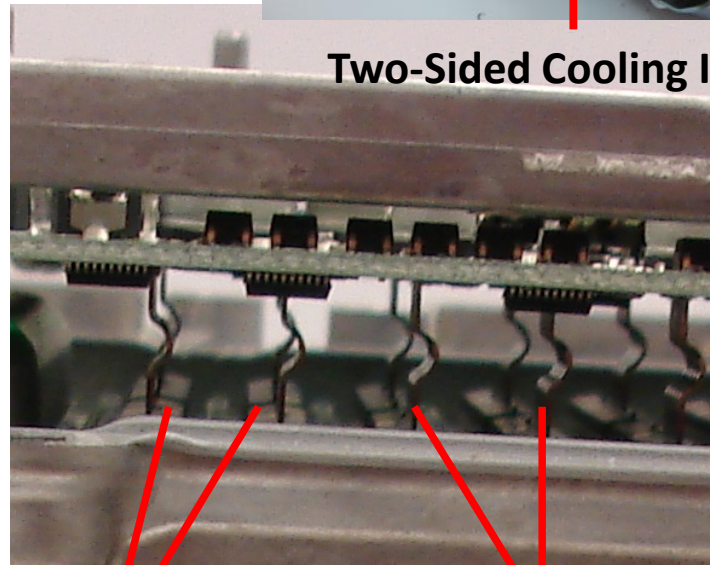

Two-Sided Cooling Infrastructure

Power Modules

Gate Drive Pins

# Technical Accomplishments (10)

## 2013 Toyota Camry PCU

- 12 Phase legs (24 IGBTs/Diodes)
  - 3 for the generator
  - 6 for the motor
    - Two in parallel for each phase
  - 3 for the boost

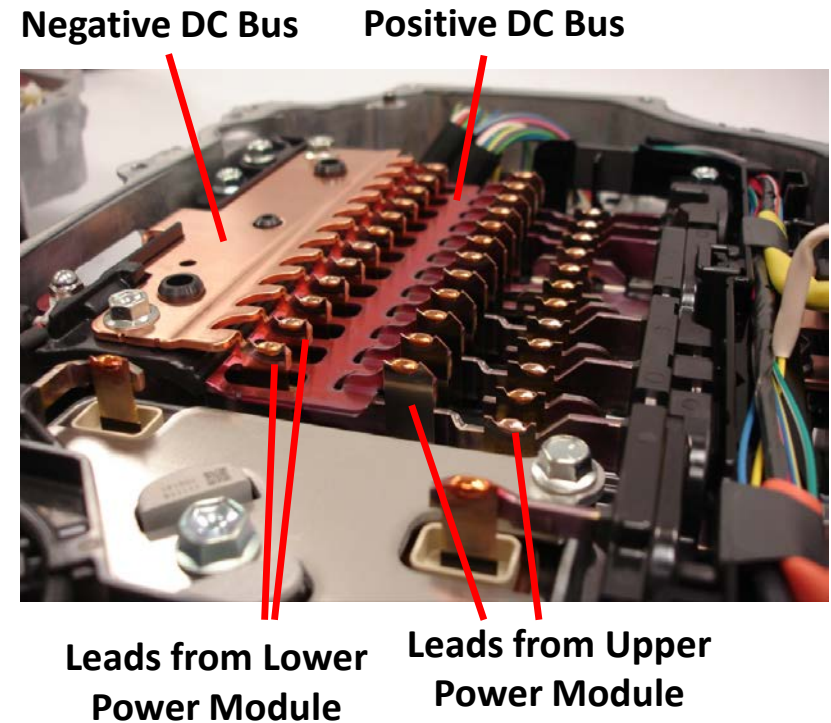
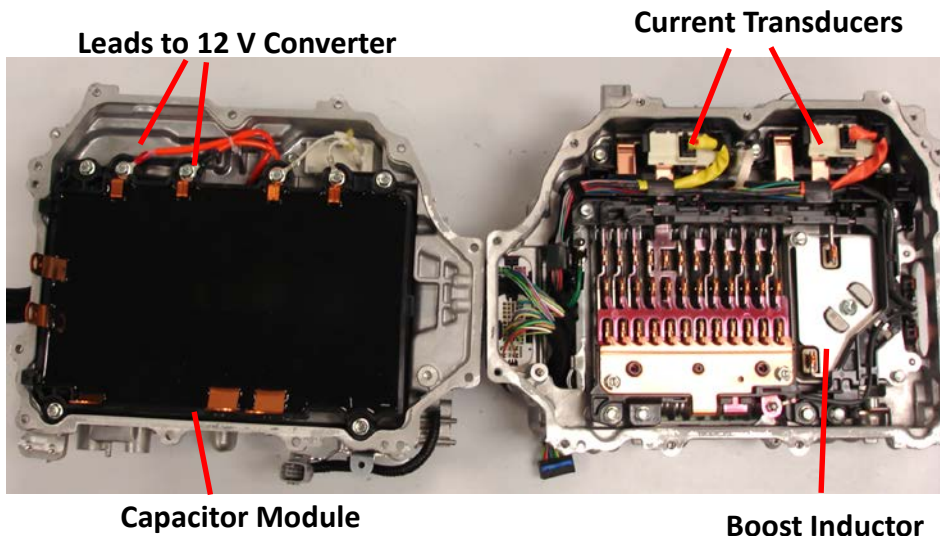

# Technical Accomplishments (11)

## 2013 Toyota Camry IGBT Characterization

- At 200A, forward voltage drop is about 400 Watts
- Two devices in parallel (400A) → ~800 Watts
- This is close to the current required to produce peak torque

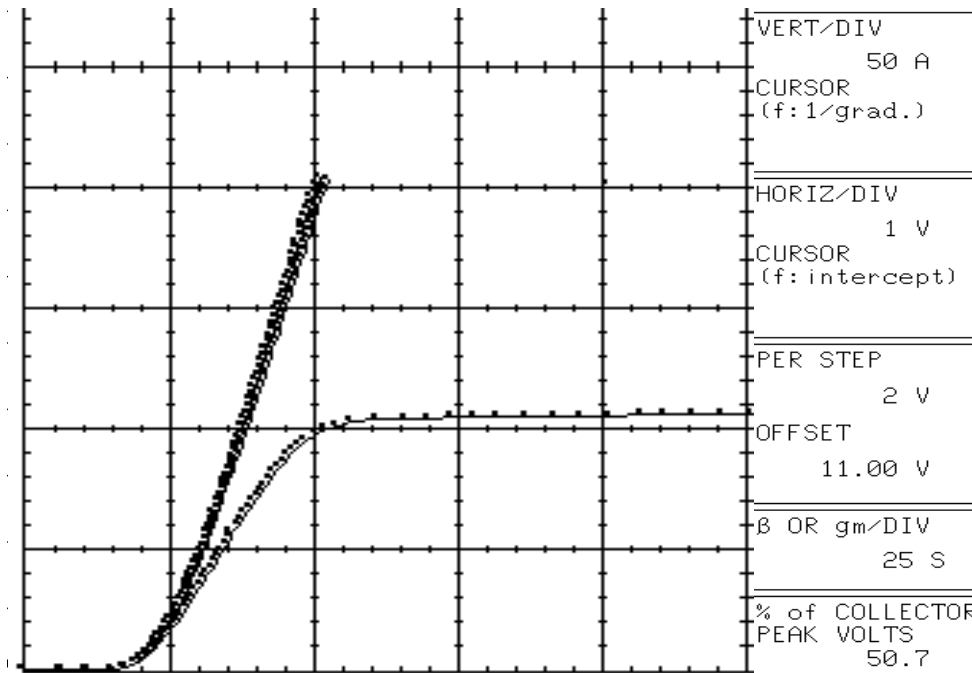





# Comments on Power Density and Specific Power

- 2013 Camry PCU power density and specific power are the highest observed thus far
  - 105 kW power rating not empirically verified
- 2012 Sonata HSG has considerably high power density and specific power given the small size
  - Uniform cooling enables this boost in performance
  - Peak efficiency is relatively low, especially with belt losses considered

Component & Parameter	2020 DOE Targets	2012 Leaf (80 kW)	2012 Sonata HSG 23 (8.5 kW)	2011 Sonata (30 kW)	2010 Prius (60 kW)	2008 LS600h Lexus (110 kW)	2007 Camry (70 kW)	2013 Camry (105 kW)	2004 Prius (50 kW)
<b>Motor</b>									
Peak power density, kW/L	5.7	4.2	7.42 (2.7)	3.0	4.8	6.6	5.9		3.3
Peak specific power, kW/kg	1.6	1.4	1.9 (0.7)	1.1	1.6	2.5	1.7		1.1
<b>Inverter</b>									
Excludes generator inverter (parenthetical values exclude boost converter mass/volume for Toyota Vehicles)									
Peak power density, kW/L	13.4	5.7	5.6 (2.0)	7.3	5.9 (11.1)	10.6 (17.2)	7.4 (11.7)	12.7 (19.0)	4.5 (7.4)
Peak specific power, kW/kg	14.1	4.9	5.4 (2.0)	6.9	6.9 (16.7)	7.7 (14.9)	5.0 (9.3)	11.5 (17.2)	3.8 (6.2)



# Collaborations and Coordination (1)

Organization	Type of Collaboration/Coordination
John Deere 	<ul style="list-style-type: none"> <li>• Provides input and general collaboration in the area of benchmarking.</li> </ul>
ANL 	<ul style="list-style-type: none"> <li>• Provides system parameters to ORNL from on-the-road tests                             <ul style="list-style-type: none"> <li>– Includes extreme hot/cold temperature tests</li> </ul> </li> <li>• Examples:                             <ul style="list-style-type: none"> <li>– Coolant temperature range and common operation conditions</li> <li>– Battery voltage range and common operation conditions</li> </ul> </li> <li>• ORNL provides component efficiency and operational characteristics for AUTONOMIE                             <ul style="list-style-type: none"> <li>– Also provides to EPA, automotive manufacturers, and public</li> </ul> </li> </ul>
NREL 	<ul style="list-style-type: none"> <li>• ORNL provides component efficiency and operational characteristics to NREL for thermal studies.</li> </ul>
Ames Lab 	<ul style="list-style-type: none"> <li>• Ames provides insight into magnet characterization and conducts quantitative analysis on samples from ORNL.</li> </ul>

# Collaborations and Coordination (2)

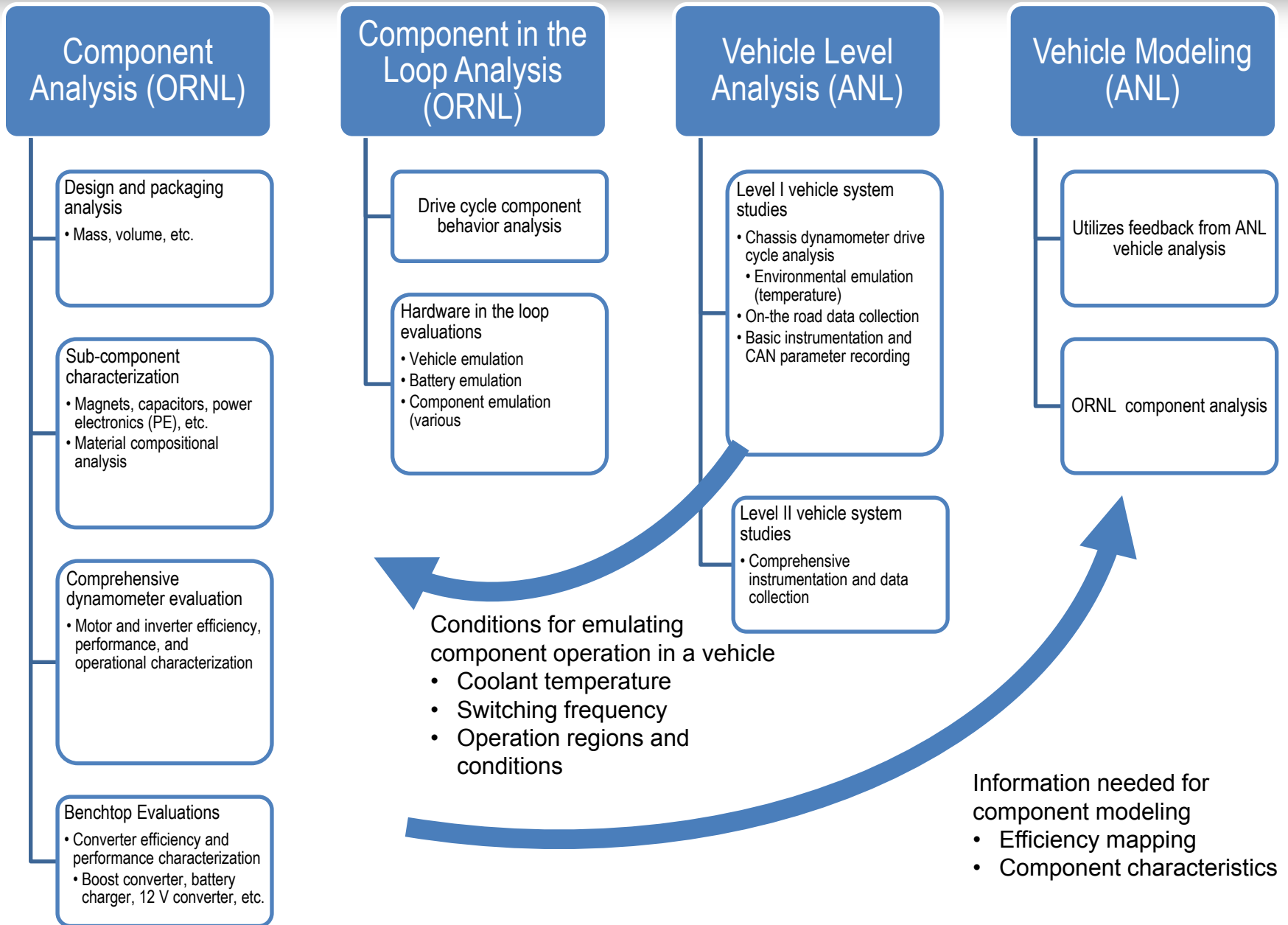

# Future Work

- **Remainder of FY14**

- Finalize teardown assessments.
- Conduct component analysis.
- Instrument and prepare for testing.
- Conduct comprehensive benchmarking.

- **FY15**

- Select commercially available EV/HEV system relevant to DOE's VTO mission. Candidates include:
  - BMW i3.
- Perform standard benchmarking of selected system.

# Summary

- **Relevance:** The core function of this project is to confirm power electronics and electric motor technology status and identify barriers and gaps to prioritize/identify R&D opportunities.
- **Approach:** The approach is to select leading EV/HEV technologies, disassemble them for design/packaging assessments, and test them over entire operation region.
- **Collaborations:** Interactions are ongoing with other national laboratories, industry, and other government agencies.
- **Technical Accomplishments:** Tested and reported on more than eight EV/HEV systems including recent efforts on the 2012 Nissan LEAF inverter, motor, and 2013 charger.
- **Future work:** FY14 efforts are delayed due to component availability, but alternative plans are in place, and FY15 plans are being discussed with DOE and EETT.