

# Electric Vehicles Rescue Manual **BERLINGO / PARTNER Electric**

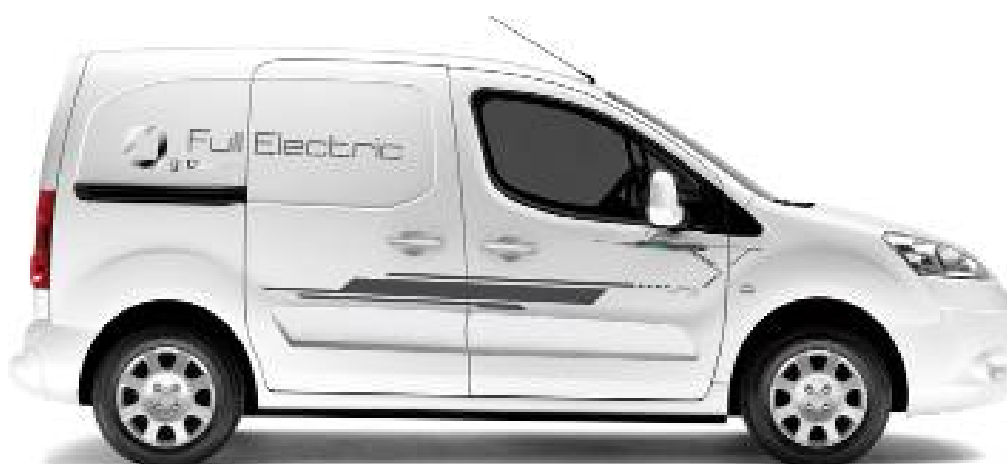

## INTRODUCTION

The purpose of this manual is to present the safety instructions that must be observed when assisting the occupants of the vehicle following an accident or following a fault resulting in immobilisation of the vehicle.

It also describes how to handle the vehicle.

This document is not intended to prepare the vehicle for its repair. For this, you must refer to the after sales manual.

Failure to follow these instructions and in particular the warnings and precautions to be observed may result in serious injuries, such as an electric shock from the "High Voltage" traction batteries present in the vehicle.

Please read and comply with this manual carefully for your safety and that of the occupants.

Throughout this manual, the words WARNING, CAUTION and NOTE appear to draw your attention specifically to certain points.

Failure to follow these instructions may result in serious injury or damage to the vehicle.

### **WARNING**

Indicates a risk of serious injury or death if the instruction is not followed.

### **CAUTION**

Indicates a hazard or an unsafe action which could cause minor injuries or damage to the vehicle.

NOTE: provides useful information.

PSA Peugeot Citroën reserves the right to make changes to the design and specifications and/or modifications or improvements to the product without any obligation to apply these to previous versions.

Please note that the content of this manual may differ slightly from the actual vehicle due to changes to the specifications of the vehicle.

## Contents

<b>1. Reference documents</b> .....	4
<b>2. Regarding the Berlingo and Partner Electric vehicles</b> .....	5
(1) Exterior features permitting identification of the vehicles .....	5
(2) Interior features permitting identification of the vehicles .....	8
<b>3. Information about the electrical architecture of the vehicle</b> .....	9
(1) Location and description of the main components.....	9
(2) Presentation of the electric motor compartment .....	10
(3) Traction battery specifications .....	12
(4) Safety measures relating to the "high voltage" .....	12
(5) Isolation of the traction battery from the "High Voltage" circuit.....	14
(6) Description of the sensitive areas .....	14
<b>4. Hazards and protective equipment on a vehicle involved in an accident</b> .....	16
(1) Hazards at the site of the accident.....	16
(2) Description of the Protection and Operating Equipment .....	17
<b>5. Summary of the work on the vehicle</b> .....	18
(1) Identify the vehicle .....	18
(2) Check the condition of the vehicle.....	18
(3) Put on Personal Protection Equipment.....	19
<b>6. Procedures for working on the vehicle</b> .....	20
(1) Actions if there is no visible damage .....	20
(2) Actions to be carried out in an emergency .....	21
(3) Vehicle on fire .....	23
(4) Cutting up the vehicle.....	24
(5) Submerged vehicle .....	24
(6) Overturning of a vehicle .....	25
<b>7. Procedure for transporting the vehicle</b> .....	26
(1) Transporting a broken down vehicle .....	26
(2) Transporting a vehicle involved in an accident .....	28
<b>8. Safety of the environment</b> .....	29

## 1. Reference documents

References	Descriptions
ECE100	Standard presenting the uniform provisions relating to vehicle approval as regards the special requirements applicable to the electric drive train.

## 2. Regarding the Berlingo and Partner Electric vehicles

### (1) Exterior features permitting identification of the vehicles

The electric vehicle has various exterior features permitting its differentiation from an internal combustion engine vehicle:

#### Distinctive features:



"Normal" charging flap:

Located on the front right wing, this permits access to the normal charging socket.

"Rapid" charging flap (according to version):

Located on the rear left wing, this permits access to the rapid charging socket.

"Full Electric" badge (according to version):

Located at the rear of the vehicle, this indicates that the vehicle is powered by electricity:



*Badge on the Partner Electric*



*Badge on the Berlingo Electric*

"Galicia" badge (according to version):

Present on each door of the electric vehicles, this is the symbol of the partnership with the Galicia region:

"Full Electric" strip (according to version):

Positioned on each front door, this completes the customisation of the vehicle:



*Badge on the Partner Electric*

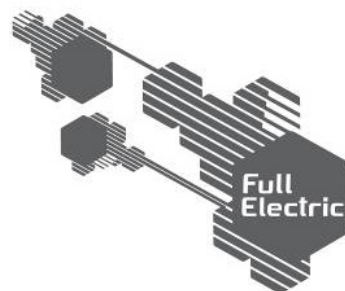

*Badge on the Berlingo Electric*

**Chassis Number:**

The Chassis Number has certain specific characteristics permitting rapid identification of the vehicle as an electric vehicle.

For this, consult the VIN code indicated at various points on the vehicle:

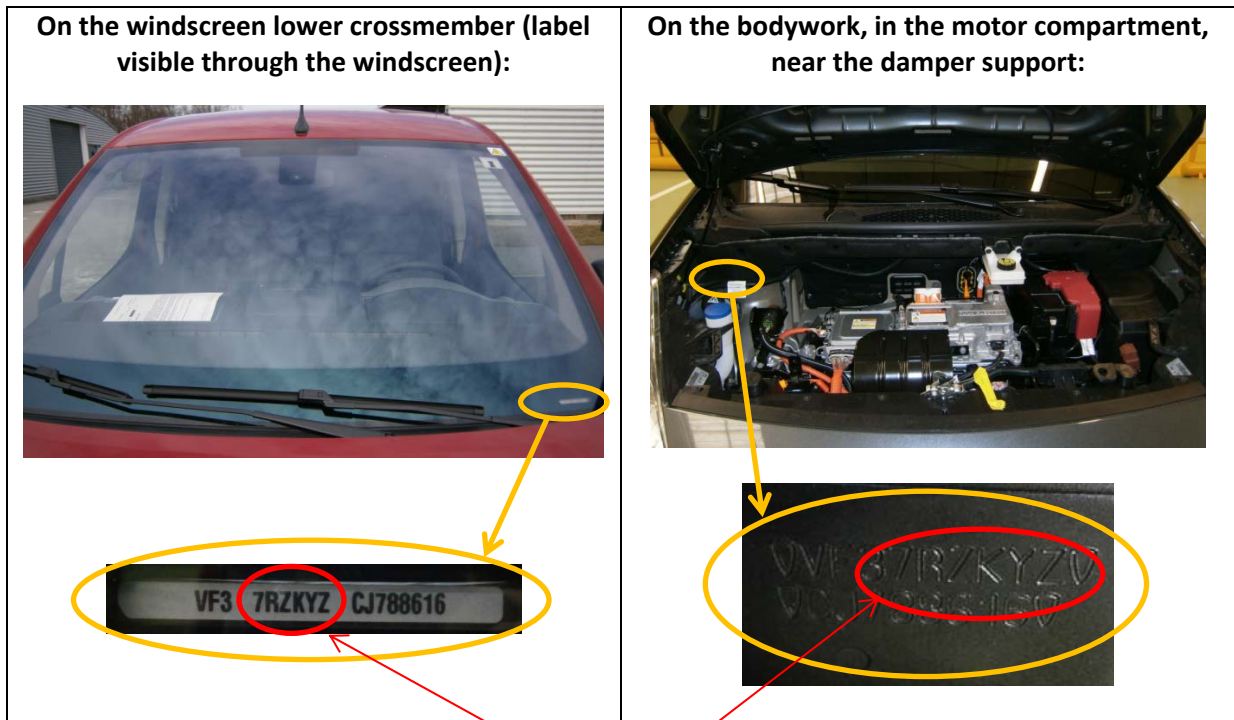

The electric vehicle can be identified by the following information (circled in red):

- 2-seat Short vehicle: **7CZKYZ**
- 3-seat Short vehicle: **7DZKYZ**
- 2-seat Long vehicle: **7LZKYZ**
- 3-seat Long vehicle: **7RZKYZ**

## (2) Interior features permitting identification of the vehicles

The interior features presented below permit differentiation of the electric vehicle from the internal combustion engine vehicle.

### Dashboard:

The dashboard is specific to the electric vehicle and groups together all the information indicated below allowing the driver to be in control of the consumption and remaining range of his vehicle at all times.



1. The "Power Meter": This indicates the power supplied or stored by the traction batteries.
2. Energy gauge and secondary consumption gauge: These indicate the electrical energy remaining in the traction batteries and the secondary consumption of electricity linked with use of the heating or air conditioning.
3. The vehicle "Ready to set off" indicator lamp: This indicates the status of the drive train. If the indicator lamp is on (green), the vehicle is ready to set off.

### P-R-N-D dial:



The vehicle has a direction of travel selector in the form of a dial with 4 positions: P (Park), R (Reverse), N (Neutral) and D (Drive). This dial is located on the dashboard, to the right of the steering wheel.



### 3. Information about the electrical architecture of the vehicle

#### (1) Location and description of the main components

The vehicle consists of an electric drive train supplied by a main battery. This latter consists of 2 packs located under the floor of the vehicle, on each side of the rear axle. The electric drive train is positioned in place of the engine block of the internal combustion engine vehicle from which it is derived.

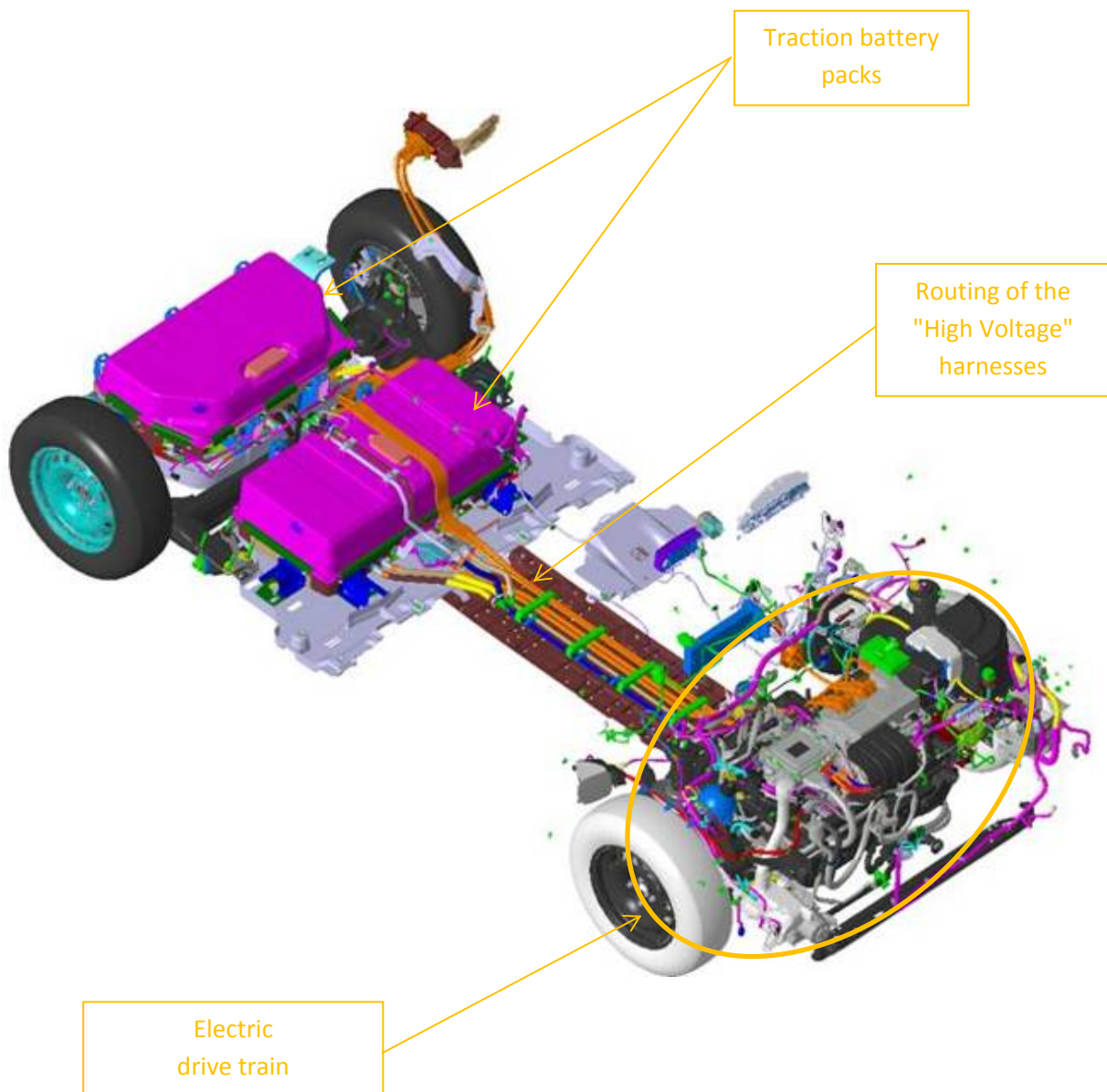

General view of the electrical units: batteries and drive train

**(2) Presentation of the electric motor compartment**

The motor compartment houses the electric drive train consisting of various "High Voltage" components as well as various other components as shown below:

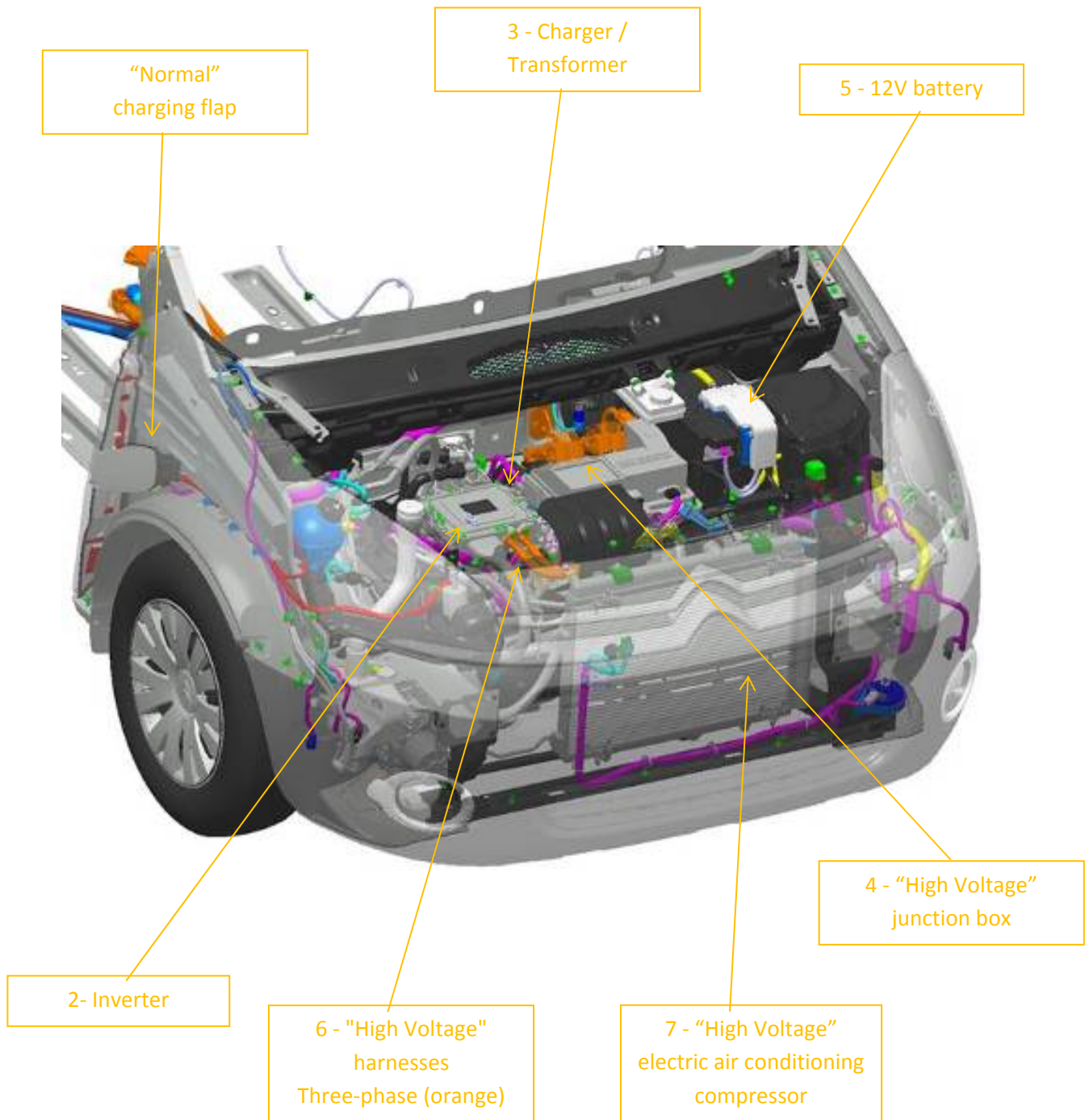

General view of the compartment under the bonnet

The main components of the compartment under the bonnet are detailed below:

Ind	Component	Location	Description
1	Electric motor	Under the bonnet	This powers the vehicle and permits the recovery of energy and charging of the batteries during the vehicle deceleration phases.
2	Inverter	Under the bonnet	This transforms the direct current from the traction batteries into 3-phase alternating current to supply the electric motor.
3	Charger / Transformer	Under the bonnet	The charger is used to charge the traction batteries during normal charging by transforming the 220 V AC (alternating) to 300 V DC (direct). The transformer transforms the 300V DC current from the traction batteries to 14.4V DC current to charge the 12V battery.
4	Junction Box	Under the bonnet	This permits electrical distribution of the "High Voltage" from the traction batteries to the various components under the bonnet. It connects the traction batteries to the following components: "High Voltage" heating, Inverter and according to version: Rapid charging flap and "High Voltage" air conditioning compressor.
5	12V battery	Under the bonnet	Conventional 12V battery supplying the vehicle's on-board network. It is charged automatically by the "High Voltage" network.
6	"High Voltage" cables	Under the bonnet, under the vehicle, at the rear of the vehicle	Cables / harnesses conveying the "High Voltage" supply to the various components of the vehicle.
7	"High Voltage" electric air conditioning compressor	Under the bonnet	The "High Voltage" electric air conditioning compressor permits lowering of the temperature in the passenger compartment, as on an internal combustion engine vehicle.
/	"High Voltage" heating	Air conditioning unit	The "High Voltage" heating consists of heating resistors which speed up the increase in temperature of the air blown into the passenger compartment.

### (3) Traction battery specifications

The traction batteries will act as an "energy tank". They will be used to supply:

- The electric motor with alternating current of 300 V via an inverter.
- The heating directly with direct current.
- The electric air conditioning compressor (according to version).

According to version, they can be charged by means of two methods:

- Via the normal charging socket connected to the alternating 220V mains. In this case, the alternating current is transformed into direct current by the charger.
- Via the rapid charging socket connected to a special terminal providing a voltage of 300V directly (if fitted).

The "High Voltage" traction batteries (sum of 2 packs) are of the Lithium-Ion type of high energy density with a capacity of 22.5 kW/h. Their characteristics are the following:

	Front battery pack	Rear battery pack
Battery voltage	330 V maximum	
Number of cells	48 cells (3 modules)	32 cells (2 modules)
Weight of the battery	178 kg	139.2 kg
Volume of the battery	Approximately 250 L	Approximately 170 L
Power of the battery	13.5 kW/h	9 kW/h

The safety rules relating to these batteries are indicated in "[Section 4.1 - Hazards at the site of the accident](#)".

### (4) Safety measures relating to the "high voltage"

To guarantee safety with regard to the presence of a "High Voltage" and avoid any risk of electrocution, the following measures have been taken:

- Identification of the "High Voltage" components by means of the presence of a warning flash label:



*NB: This label is affixed to the protection barriers which once removed provide access to the "High Voltage" components.*

- Use of orange cables to convey the "High Voltage".
- Electrical isolation of all of the components and of the "High Voltage" circuit.

-Use of IPxxB connections (as defined in regulation ECE100).

## (5) Isolation of the traction battery from the "High Voltage" circuit

The "High Voltage" circuit can be cut off by means of the following conditions:

- Ignition key:** After the ignition has been switched off, by means of the vehicle's key, the electric drive train is no longer connected to the "High Voltage" traction battery packs.
- 12 V battery:** Disconnection of the 12 V battery automatically results in cutting off of the "High Voltage".
- Emergency cut-off system:** In the event of a collision resulting in the deployment of one of the restraining devices (airbag, ...) or if certain faults occur on the vehicle, this system cuts off the "High Voltage" supply.
- Connector on junction box:** Located on the left-hand side of the junction box, the connector (see photographs below) isolates the "High Voltage" traction batteries from the rest of the "High Voltage" circuit. See "[Section 6.1 - Actions if there is no visible damage](#)".



Vehicle not fitted with rapid charging



Vehicle fitted with rapid charging (according to option)

- Connectors connecting the 2 battery packs:** Located between the two traction battery packs (see photograph below), the disconnection of one of these connectors uncouples the two traction battery packs from the "High Voltage" circuit. See "[Section 6.2 - Actions to be carried out in an emergency](#)".

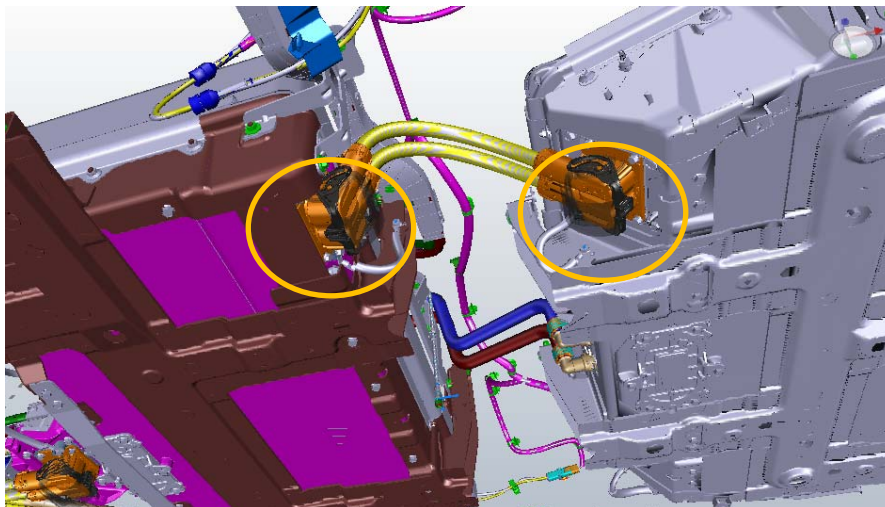

## (6) Description of the sensitive areas

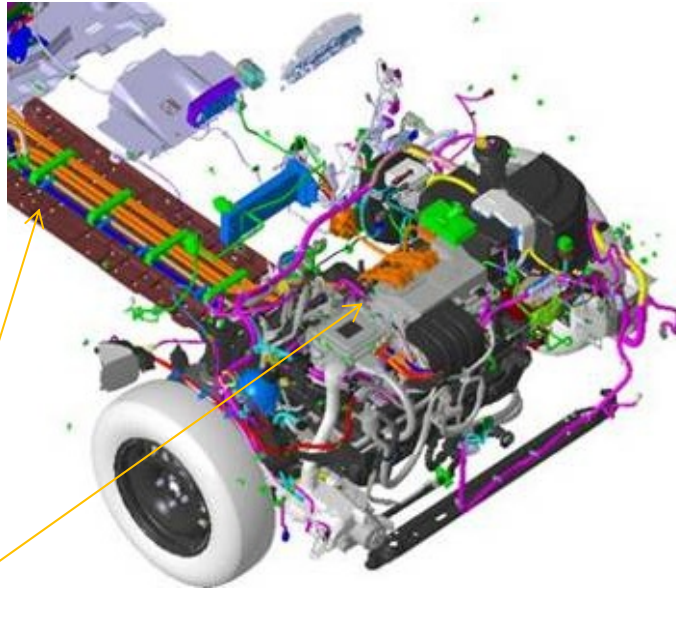

**Front area: motor compartment**

The "High Voltage" from the traction batteries is routed under the floor, via harnesses protected by sheathing, to the motor compartment (junction box). The "High Voltage" is then distributed throughout the motor compartment via orange cables.

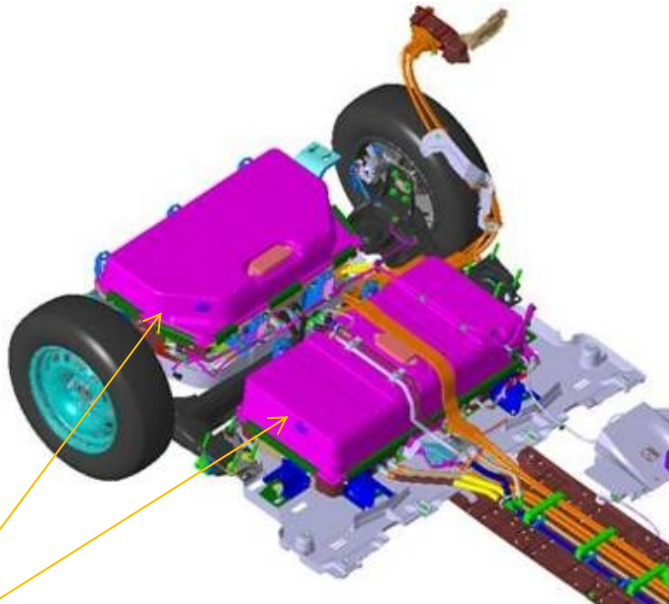
**Rear area: battery packs**

The traction battery packs store the electricity which supplies the electric motor and can be charged by receiving the "High Voltage" via normal charging, rapid charging or regenerative braking. The orange power cables which convey the "High Voltage" are routed under the load floor.

## 4. Hazards and protective equipment on a vehicle involved in an accident

### (1) Hazards at the site of the accident

#### **⚠ WARNING**

Do not touch the "High Voltage" (orange) cables directly, exposed or disconnected, nor the protective covers or "High Voltage" components which could be damaged.

#### **⚠ WARNING**

Before carrying out any work on the vehicle, switch off the ignition to avoid any risk of injury caused by automatic activation of the motor. The electric motor may be active, even if the vehicle is not making any noise. Check carefully that the **Ready to Set Off** indicator lamp is off.

#### **⚠ WARNING**

If a leak from the traction batteries is observed, the fluid may be produced by the electrolyte. Put on PPE ("[Section 4.2 - Description of the Protection and Operating Equipment](#)") then absorb the fluid using sand or an absorbent mat. The electrolyte is clear and transparent and has a slight odour. Its viscosity is similar to that of water.

The other vehicle fluids are the same as those used in conventional vehicles.

List and colour of the various fluids present in the vehicle:

Component concerned	Type of fluid	Associated colour
Transmission	ATF	Red
Cooling system	Coolant	Blue / Green
Air conditioning	Coolant	Blue / Green
Brake	Brake fluid	Colourless
Ancillaries battery	Electrolyte	Colourless
Traction battery	Electrolyte	Colourless

#### **⚠ WARNING**

In the event of an impact with visible damage to the "High Voltage" traction battery packs there is a chemical hazard.

You must not remain near the vehicle and you must inform the emergency services as soon as possible.

In the event of an electrolyte leak: Do not touch the fluid directly, clean up the electrolyte using a disposable cloth which should then be discarded into an appropriate waste receptacle, then clean the soiled area with water.

Consult a doctor if one of the following situations occurs:

- Contact with the skin or eyes: wash with plenty of water for 15 minutes.
- Ingestion: do not attempt to vomit, drink plenty of water.



- Inhalation: breathe fresh air.

**⚠ WARNING**

Do not leave the vehicle unattended. When the emergency actions have been carried out and the occupants have left the damaged vehicle, establish a safety perimeter around the vehicle.

## (2) Description of the Protection and Operating Equipment

The main Personal Protection Equipment (PPE) is presented in the following table:

Items	Equipment / Tool	Purpose
Electrical hazard	Compulsory insulated PPE: 1 - Rubber insulated gloves 2 - Visor  Recommended insulated PPE: 3 &4 - Trousers and jacket 5 - Rubber shoes	Protection against the electrical hazard during operations in contact with the "High Voltage" circuits.
Chemical hazard	Protective mask, gloves resistant to solvents	Protection of the respiratory tracts and skin.

The equipment and tools recommended for any work on the vehicle are the following:

Type of operation	Equipment / Tool	Purpose
Fluid leak	Absorbent mat, sand	To absorb the leak of electrolyte. An absorbent mat and/or sand can be used to absorb the fluids (oil).
Fire	Fire extinguisher "with additive" permitting deep and lasting cooling or a powder or CO <sub>2</sub> fire extinguisher	To extinguish the beginnings of a fire.
Electrical operation	Plastic insulating tape	To insulate the electrical circuit and tools if they are damaged.
	Insulated tools	To dismantle the components of the vehicle without risk of electric shock.
	Voltage tester	To check that a component of the vehicle is no longer connected to the "High Voltage".

## 5. Summary of the work on the vehicle

### **⚠ WARNING**

Follow the instructions in this manual to reduce the risk of injury.

### (1) Identify the vehicle

Use the information provided in "[Section 2.1 - Exterior features permitting identification of the vehicle](#)" and "[Section 2.2 - Interior features permitting identification of the vehicles](#)" to check that this is indeed an electric vehicle.

### (2) Check the condition of the vehicle

The diagram below defines the instructions to be followed according to the situation:

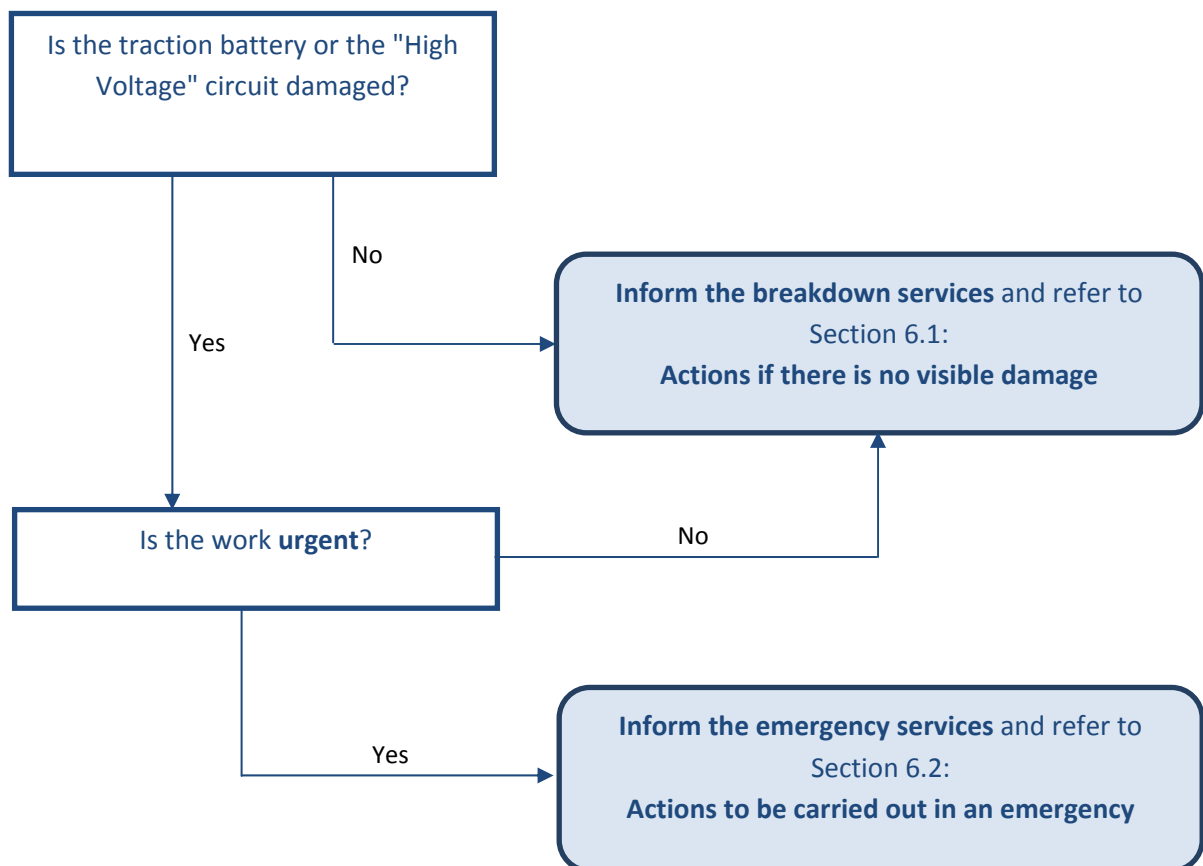

If one of the following situations occurs, please refer to the procedures listed below:

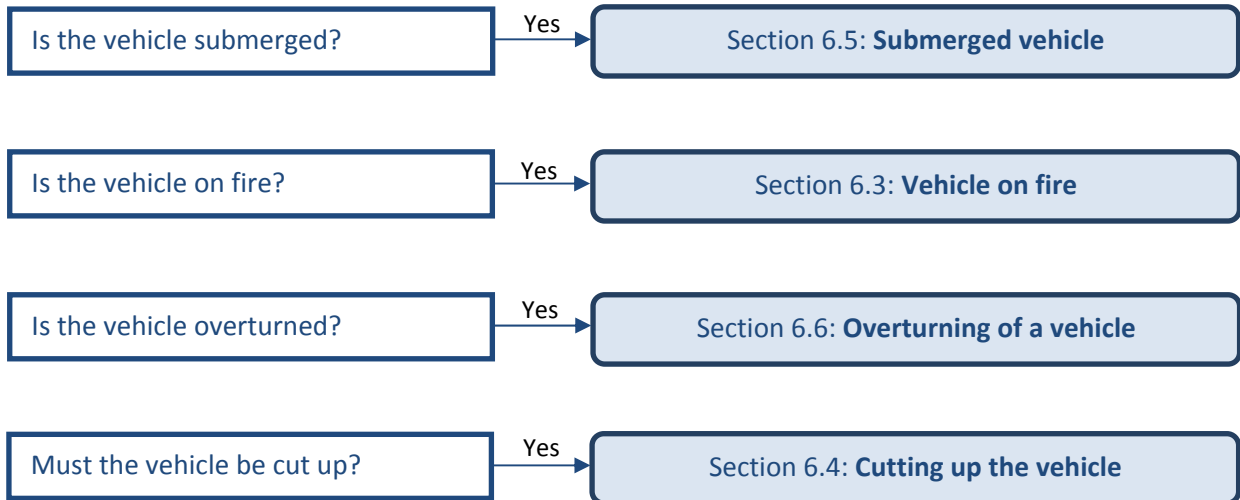

### (3) Put on Personal Protection Equipment

If an electric and/or chemical hazard is identified on a vehicle involved in an accident, put on PPE ensuring the safety of those involved and use appropriate operating equipment as detailed in “[Section 4.2 - Description of the Protection and Operating Equipment](#)”.

## 6. Procedures for working on the vehicle

### (1) Actions if there is no visible damage

The aim is to place the vehicle in a safe state preventing any electrical risk by disconnecting the "High Voltage" supplied by the traction batteries.

- 1) Put on PPE.
- 2) Immobilise the vehicle by applying the handbrake.
- 3) Switch off the ignition:
  - a. Place the selection dial in position "P".
  - b. Switch off the electric motor by turning the key to the "OFF" position.
  - c. Remove the key from the ignition. The **Ready to Move Off** indicator light should be off.
- 4) Wait for 2 minutes to ensure that all of the ECUs have become dormant.
- 5) Disconnecting the 12V battery:
  - a. Open the bonnet.
  - b. Secure the bonnet support strut.
  - c. Remove the plastic protector permitting access to the terminals of the 12 V battery.
  - d. Raise the locking lever to disconnect the positive terminal of the 12V battery.
- 6) Wait for 2 minutes before moving on to the next step.

#### **⚠ WARNING**

For one minute following disconnection of the 12V battery it is still possible that an airbag may be deployed. If you carry out the next step without waiting, there is a potential risk of serious injury due to the unwanted deployment of an airbag.

- 7) Disconnect the connector located on the junction box on the left (*This action isolates the "High Voltage" circuit from the traction battery*):

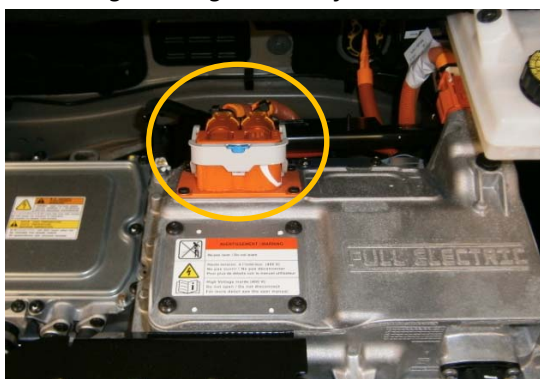

*Vehicle not fitted with rapid charging*



*Vehicle fitted with rapid charging (according to option)*

- 8) Wait for 2 minutes to allow all of the capacitors to discharge naturally.

#### **⚠ WARNING**

When the "High Voltage" battery packs are isolated from the rest of the "High Voltage" circuit, the interior of the battery packs remains live.

### **⚠ WARNING**

Risk of burns if the connector is disconnected while the "High Voltage" circuit is still live.

## (2) Actions to be carried out in an emergency

In an emergency or if "High Voltage" components or cables are damaged, it **is very strongly** recommended that the vehicle is placed in a safe electrical state before any work/action is carried out on it. Check the entire vehicle to determine whether "High Voltage" components are damaged, following the procedure below:

### **⚠ WARNING**

Orange cables indicate "High Voltage".

- 1) Put on PPE.
- 2) Immobilise the vehicle by applying the handbrake.
- 3) Set a safety perimeter around the vehicle.
- 4) Switch off the ignition:
  - a. Place the selection dial in position "P".
  - b. Switch off the electric motor by turning the key to the "OFF" position.
  - c. Remove the key from the ignition. The **Ready to Move Off** indicator light should be off.
- 5) Disconnecting the 12V battery:
  - a. Open the bonnet.
  - b. Secure the bonnet support strut.
  - c. Remove the plastic protector permitting access to the terminals of the 12 V battery.
  - d. Raise the locking lever to disconnect the positive terminal of the 12V battery.
- 6) Disconnect the connector on the left-hand side of the junction box (*This action isolates the "high voltage" circuit from the traction battery*)



Vehicle not fitted with rapid charging



Vehicle fitted with rapid charging (according to option)

7) Start an action on the vehicle such as, for example, cutting up.  
If it is necessary to remove the windows or doors, the procedure is the same as for conventional internal combustion engine vehicles.

If access to the front of the vehicle is not possible, the "High Voltage" traction batteries must be disconnected from each other and from the rest of the "High Voltage" circuit by disconnecting the connectors connecting the two battery packs to each other.

The two connectors are accessible from underneath the vehicle by opening the "Service Access" flap as shown below:



Next, the connector shown below must be disconnected to uncouple the battery packs:





### (3) Vehicle on fire

If the vehicle catches fire, **inform the fire brigade immediately specifying that the vehicle in question is an electric vehicle.**

#### **⚠ WARNING**

Failure to observe the instructions described below may result in serious injuries.

#### **Case of a fire which does not affect the traction batteries:**

In the case of a fire which does not affect the traction batteries, start to extinguish the fire observing the instructions described below:

**1) Using a fire extinguisher:**

Use a fire extinguisher suitable for inflammable liquid and electrical equipment fires (Water fire extinguisher "with additive" permitting deep and lasting cooling or powder or CO<sub>2</sub> fire extinguisher). See "[Section 4.2 - Description of the Protection and Operating Equipment](#)".

**2) Using water:**

Use a large quantity of clean water (fire hydrant)

If it is not possible to use a large quantity of water, do not try to extinguish the fire and wait for the fire brigade after setting a safety perimeter.

#### **Case of a fire affecting the traction batteries:**

In the case of a fire at the traction batteries, it is compulsory to notify the emergency services and move away from the vehicle while establishing a safety perimeter.

In the rear load area, cooling flaps permit access to direct water as close as possible to the traction battery packs. These flaps are bonded onto the floor and melt in the event of a fire:



## (4) Cutting up the vehicle

The diagrams shown below indicate the areas to be taken into account when cutting up the vehicle.

### **⚠ WARNING**

Use a suitable machine which does not emit sparks. These could seriously injure the occupants of the vehicle and the emergency services.

Observe the areas indicated below before cutting up the vehicle in order to avoid touching "High Voltage" components (orange cable, batteries, ...).

### **⚠ WARNING**

Never cut the traction batteries themselves.

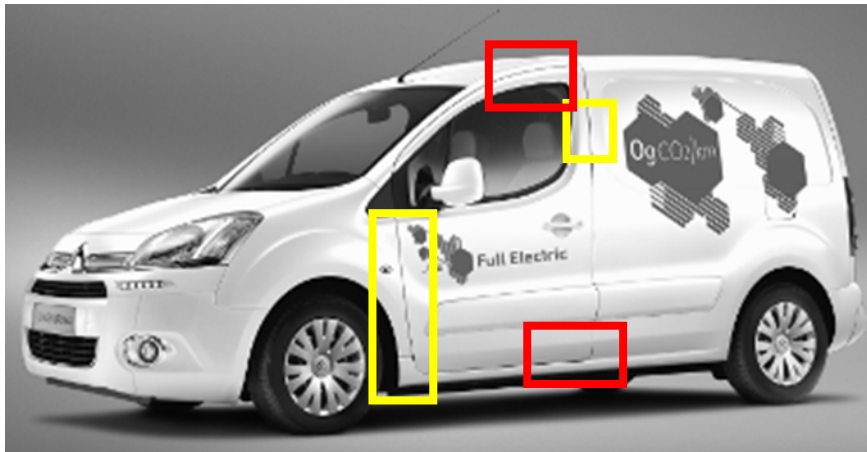

#### Key:

- Area not recommended
- Danger area
- Specific danger "High Voltage"

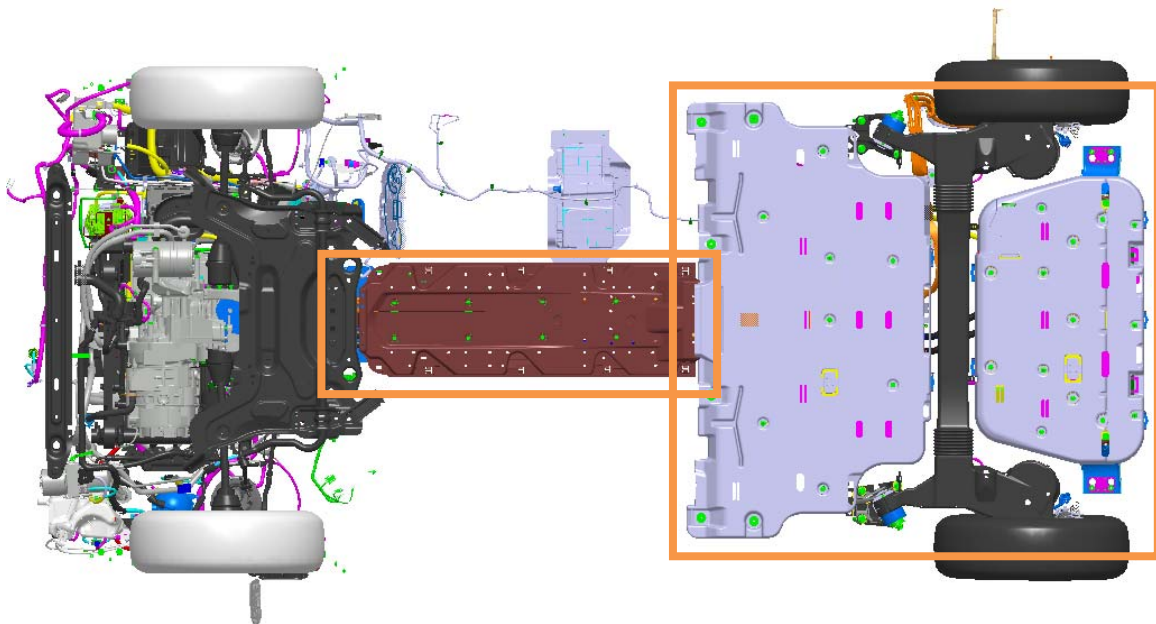

## (5) Submerged vehicle



When an electric vehicle is submerged, the procedure below must be followed:

- 1) Inspect the condition of the vehicle to detect any damage. If you notice any serious damage (distortion) to the vehicle or traction batteries, do not touch the "High Voltage components".
- 2) To extract the vehicle from the water, put on PPE ("[Section 4.2 - Description of the Protection and Operating Equipment](#)").
- 3) Once it is out, leave the vehicle outside in a ventilated area, opening all windows and doors.
- 4) Then transport the vehicle ([Section 7 - Procedure for the transporting the vehicle](#)) to the after sales department as quickly as possible.

## (6) Overturning of a vehicle

Check that there are no projecting objects on the road and gently return the vehicle to its wheels avoiding any contact with the "High Voltage" components listed below:

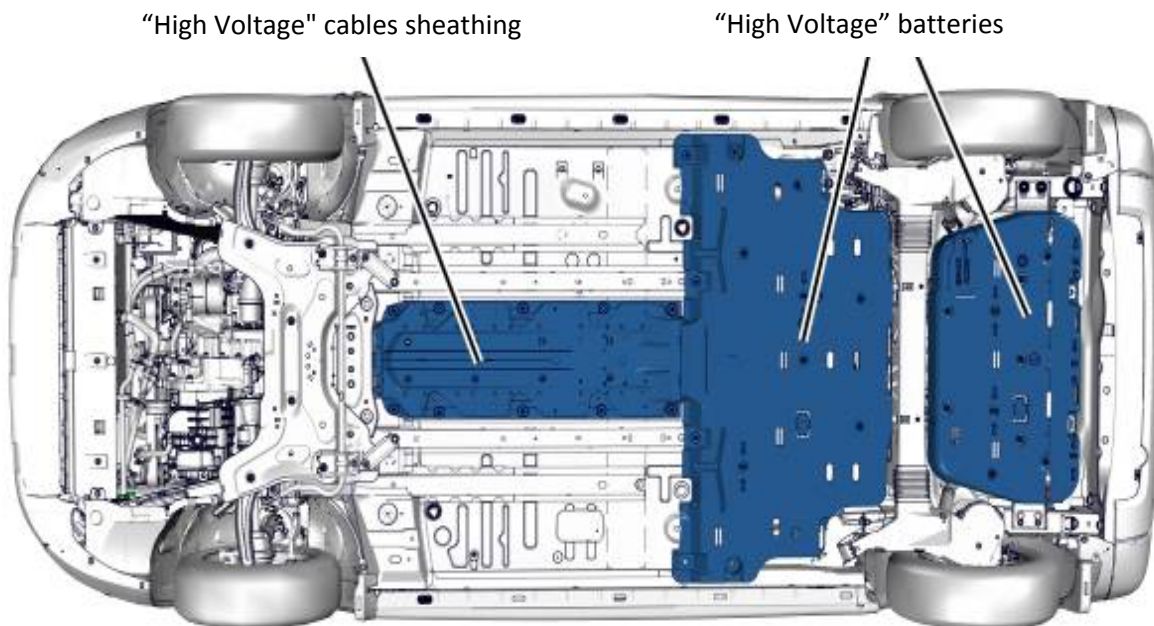

## 7. Procedure for transporting the vehicle



In order to transport the electric vehicle, the following conditions must be observed:



- Only personnel who have received special electric vehicle training (training which can be proven to the emergency services) are authorised to work on the vehicle (comply with the regulations in force in the country concerned).
- Put on PPE and use suitable operating equipment as detailed in "[Section 4.2 - Description of the Protection and Operating Equipment](#)".
- Ensure that the surrounding area and the occupants are safe before carrying out any work.
- Use the appendix "Electric vehicle towing form" to determine the receiving garage and permit traceability of the operation.

### (1) Transporting a broken down vehicle

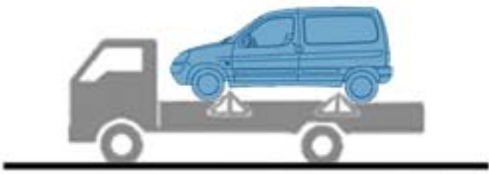
In the case of a broken down vehicle, follow the procedure "[Section 6.1 - Actions if there is no visible damage](#)" to make the vehicle safe before transporting it as shown below.

**Towing conditions permitted in the case of broken down vehicle:**

Illustrations	Explanations
	<p><b>Recommended procedure:</b></p> <p>Before putting the vehicle on the flatbed, make sure that the front wheels are not locked.</p> <p><b>Procedure:</b></p> <ul style="list-style-type: none"> <li>• Switch on the ignition</li> <li>• Turn the gear dial to position "N".</li> <li>• Put the vehicle on the flatbed</li> <li>• Remove the ignition key</li> <li>• Apply the handbrake</li> </ul>
	<p><b>Procedure:</b></p> <ul style="list-style-type: none"> <li>• Ensure that the steering wheel is in the straight ahead position, secure it firmly with a cord so that it cannot move (if it is not secured correctly, the vehicle will not be stable and could cause an accident)</li> </ul>

	<p><b>Procedure:</b></p> <ul style="list-style-type: none"> <li>• Ensure that the steering wheel is in the straight ahead position, secure it firmly with a cord so that it cannot move (if it is not secured correctly, the vehicle will not be stable and could cause an accident)</li> <li>• Release the handbrake.</li> </ul>
	<p><b>Procedure:</b></p> <ul style="list-style-type: none"> <li>• Ensure that the steering wheel is in the straight ahead position, secure it firmly with a cord so that it cannot move (if it is not secured correctly, the vehicle will not be stable and could cause an accident)</li> </ul>

**⚠ WARNING**

Towing by the rear wheels is only permitted if the front wheels are fitted on supports with castors.

**⚠ WARNING**

Any other towing condition is strictly prohibited.

When towing with 2 wheels on the ground, use professional lifting equipment. It is imperative to lift from the wheels. Lifting by any other component of the bodywork or structure is prohibited (risk of damage: bumper, batteries, etc.).

## (2) Transporting a vehicle involved in an accident

In the case of a vehicle involved in an accident, follow the procedure “[Section 6.1 - Actions if there is no visible damage](#)” to make the vehicle safe before transporting it as shown below.

In the case of a vehicle involved in an accident the only towing condition permitted is the following:

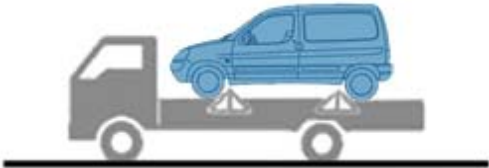
Illustrations	Explanations
	<p><b>Compulsory procedure:</b>  <b>For the transportation of a vehicle involved in an accident, only transportation on a flatbed is permitted</b></p> <p>Before putting the vehicle on the flatbed, make sure that the front wheels are not locked.</p> <p><b>Procedure:</b></p> <ul style="list-style-type: none"> <li>• Switch on the ignition</li> <li>• Turn the gear dial to position "N".</li> <li>• Put the vehicle on the flatbed</li> <li>• Remove the ignition key</li> <li>• Apply the handbrake</li> </ul>

**Any other towing condition is strictly prohibited.**

## 8. Safety of the environment

When carrying out work on the "High Voltage" components, please place this label on the roof of the vehicle by folding it in two along the dotted line.

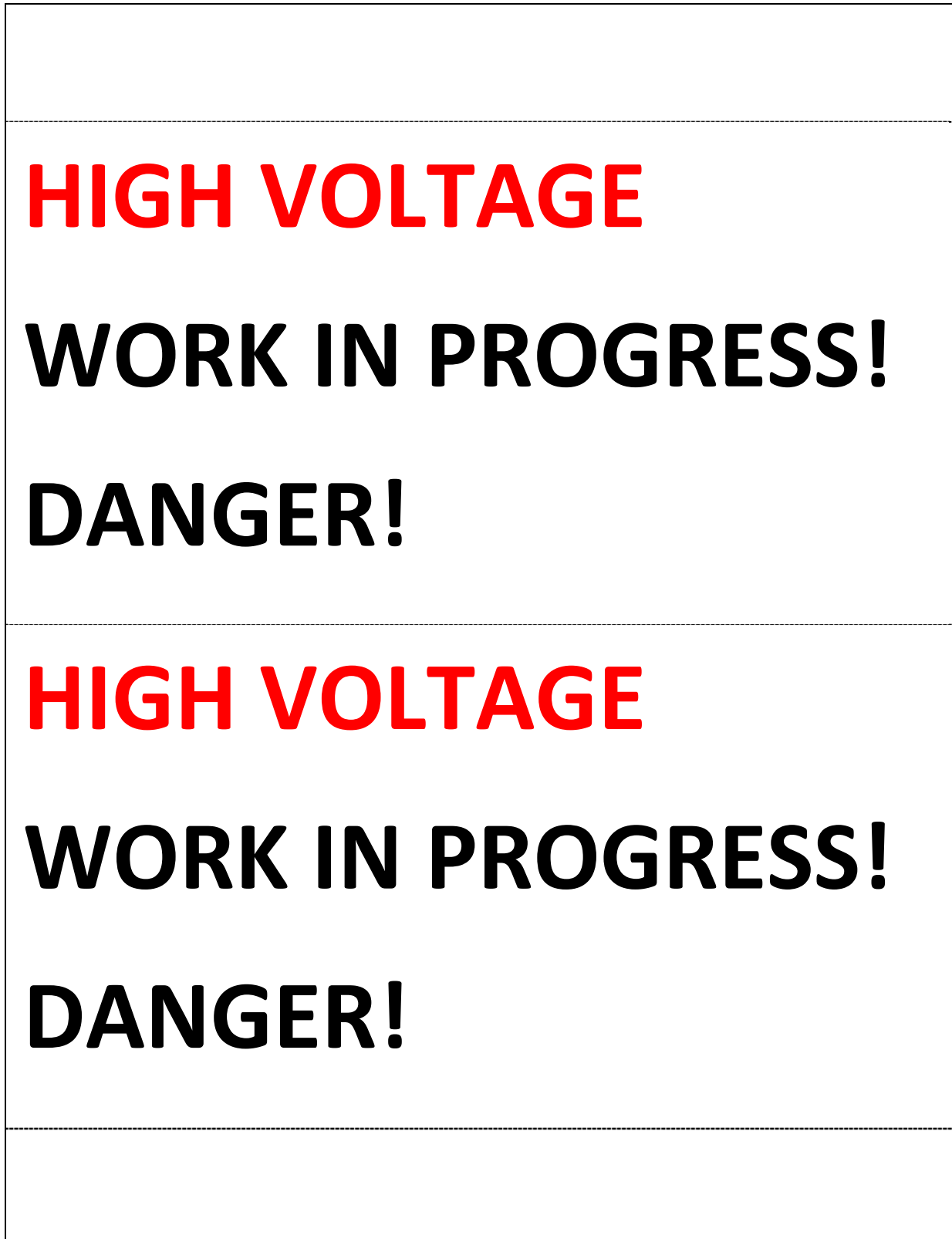

It is recommended that a label similar to that below is positioned while work is being carried out on the vehicle. The symbol shown must conform to the law in force in the country in which the vehicle is located.

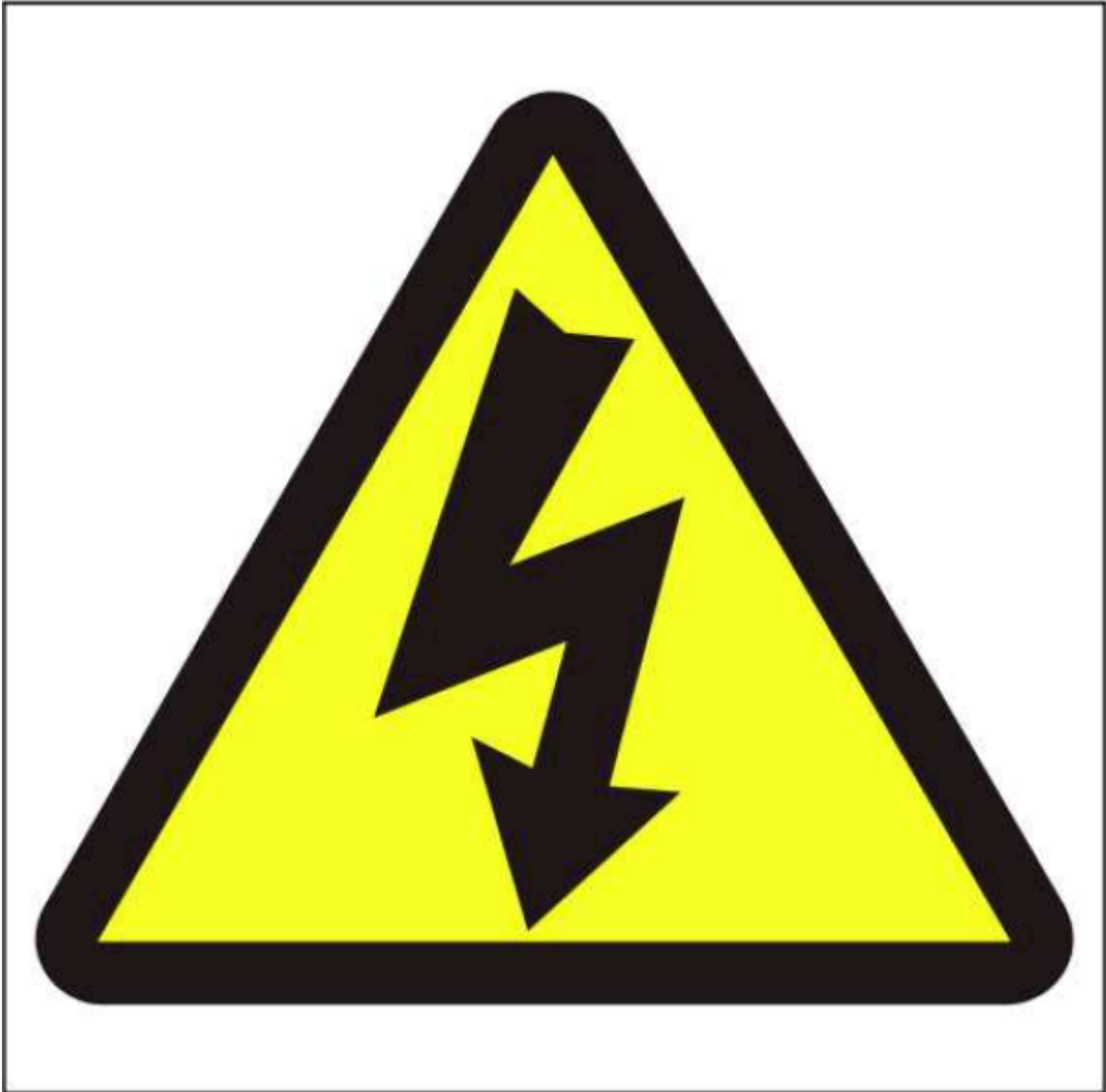





PSA PEUGEOT CITROËN 