



APOLLO

**BICYCLE OWNER'S MANUAL &
TECHNICAL HANDBOOK 2018**

IMPORTANT! Please read this manual before using your new bicycle

AUSTRALIAN CONSUMER LAW LIMITED WARRANTY STATEMENT FOR AUSTRALIA

(applies to goods sold after 1 January 2012)

This warranty is given by Apollo Bicycle Co. Pty. Ltd (ABN 60 001 914 469) of 3/333 Frankston-Dandenong Rd, Dandenong Sth, VIC 3175. Telephone: (03) 9700 9400. Facsimile: (03) 9700 9499. Email: info@apollobikes.com.

This limited warranty applies only to the original purchaser of an Apollo, Neo, or Radius bicycle and is not transferable to subsequent owners.

Subject to the terms, conditions and limitations set forth below, Apollo warrants to the original purchaser of each new Apollo bicycle (that has a wheelbase exceeding 640mm or a wheel size of 16" (40cm) or greater,) that Apollo Bicycle Company will repair or replace the frame or fork should it fail at any weld point, provided it was purchased new from, and assembled by, an authorised Apollo bicycle dealer.

This limited warranty is void if the bicycle is subjected to abuse, neglect, improper repair, improper maintenance, alteration, modification, an accident or other abnormal, excessive or improper use.

All labour charges and freight charges for warranty services are the responsibility of the bicycle's owner.

Apollo, Neo, and Radius Bicycles are designed for intended use and rider enjoyment, however bicycles are not indestructible; every frameset has a useful life cycle and may not last forever. The duration of the life cycle will depend upon the type of frame, riding conditions and the care your bicycle receives. The Apollo Limited Lifetime Warranty is defined by the life cycles shown in the following:

Item 1: Warranty coverage for Carbon Fibre frames, without rear suspension systems, shall be for a period of 5 years. Frame fatigue shall not be covered under the terms of this warranty on these frames.

Item 2: Warranty coverage for Aluminium frames, without rear suspension systems, shall be for a period of 5 years. Frame fatigue shall not be covered under the terms of this warranty on these frames. This excludes BMX/stunt frames and forks.

Item 3: Warranty coverage for frames of Hi Tensile steel or Chromoly steel construction, without rear suspension systems, shall be for 10 years. This covers the frame only or fork other than suspension forks. This excludes BMX/stunt frames and forks.

Item 4: Warranty coverage for Downhill, aluminium and carbon dual suspension systems and system components shall be for a period of one year, covering faulty workmanship or materials making up the suspension system. These frames, except Downhill main frames, are covered under the regular warranty for frames of the same material construction should they fail at any regular weld point. Rear suspension design is not covered under this warranty. The fork is not part of the frame and bushings and other pivot hardware on rear suspension frames are not part of the frame.

Item 5: Warranty coverage for BMX/Stunt frame and forks shall be for 3 months.

Item 6: Warranty coverage for front suspension systems shall be for a period of one year, covering faulty workmanship or materials only.

Item 7: Warranty coverage shall last 12 months from the date of purchase for paint finish and all other parts & accessories. Tyres and tubes are not covered by this warranty.

Item 8: Warranty coverage on electrical parts for Electric Pedal Assist bikes shall be as listed below:

- Motor - 2 years
- Battery, Controller, Sensor, Battery Charger - 1 year

The above warranty coverage periods are subject to all the limitations described below.

This limited warranty is not transferable and shall only apply to normal and ordinary use of this product.

To obtain service under this warranty, the bicycle should be returned to the authorised Apollo dealer on the same continent from which it was purchased, in an assembled condition, together with a receipt or appropriate proof of purchase document which identifies the bicycle by frame number.

Should this bicycle or any part or accessory be determined by Apollo to be defective and covered by this limited warranty, Apollo will at its option, either replace or repair any defective product, part or accessory. Dealer labour charges for installing replacement parts or accessories are not covered by this limited warranty. The cost of transportation to and from an authorised Apollo dealer for repair or replacement of any defective part and/or accessory is to be borne by the owner.

The bicycle has not been designed, manufactured or sold for use at any time or place or in any manner whatsoever as a power driven vehicle, motorcross, stunt riding, ramp jumping, acrobatics, or rental, hiring or other such commercial activity and this limited warranty does not cover these acts.

EXCLUSIONS FROM LIMITED WARRANTY

This limited warranty does not cover any personal injuries, paint damage, mechanical damage or any other damage or injury due to misuse, neglect, accident, normal wear and tear, abuse, improper use or improper maintenance, corrosion or rusting of the frame or any part or accessory due to exposure to the weather or exposure to a chemical environment, or modifications to the original specifications or factory fitted components, treatment or assembly of this bicycle. Any use of this bicycle which is incompatible with those parts and accessories installed as original equipment by the factory is not covered. The warranty on a carbon frame is voided if the bicycle has been ridden on any stationary trainer which attaches to the rear skewer.

The benefits to the consumer given by this warranty are in addition to other rights and remedies of the consumer under a law in relation to the goods or services to which the warranty relates. Our goods come with guarantees that cannot be excluded under the Australian Consumer Law. You are entitled to a replacement or refund for a major failure and for compensation for any other reasonably foreseeable loss or damage. You are also entitled to have the goods repaired or replaced if the goods fail to be of acceptable quality and the failure does not amount to a major failure.

For the latest version of this bicycle owners manual, please see apollobikes.com

Congratulations on your purchase. Your Apollo bicycle has been fully tested and carefully produced with performance, comfort and safety in mind. With proper care and maintenance your bicycle will give you years of riding pleasure.

Use this owner's manual as a guide for the recommended maintenance and safe usage of your new bicycle. Take the time to read and understand this manual; and for parents of young riders please explain the content to your child. Please note that it is not intended as a full workshop manual.

Please consult a specialist bicycle dealer if:

- a specific subject is not covered in this manual
- the subject matter seems beyond your level of experience or ability
- you have any further questions



General Warning:

It is your responsibility to correctly maintain your bicycle. Failure to maintain or inspect your bicycle may have severe consequences, such as losing control when riding and falling, which may ultimately result in injury or death.

The risk of injury or death due to falling is implicit in the many "warnings" and "cautions" stated in this manual. As such, whenever the risk of falling is stated we do not repeat the warning of possible death or injury.

Please Note:

Bicycle frames and components do not have an infinite life span and must be assessed on an appropriate timeline by a qualified expert.

Know how to operate all standard and accessory equipment on the bicycle.

Ensure that anyone who uses the bicycle has been fully instructed in the operation of bicycle functions.

Your bicycle conforms to relevant Australian Standards. Other local regulations may apply. Check with your bicycle retailer.

This is a partially assembled bicycle requiring final assembly and adjustments before riding. Final assembly and adjustment should only be carried out by a qualified bicycle mechanic at your specialist bicycle store.

For the latest version of this bicycle owners manual, please see apollobikes.com



PART 1

Warranty

Inside Front Cover



PART 2

Parts Classification

Pages 4 – 7



PART 3

Before You Ride

Pages 8 – 21



PART 4

Bicycle Care & Servicing

Pages 22 – 26



PART 5

Comprehensive Maintenance

Page 27 – 67



PART 6

Folding Bicycle Instructions

Page 68



PART 7

Electric Bicycle Manual

Pages 69 – 76



PART 8

Contact Addresses

Back Cover



Warning / Important

(take notice of this symbol throughout this manual)

2. PARTS CLASSIFICATION	4	- Tyre inspection	28
Mountain bicycles & Cross bicycles	4	- Recommended tyre pressures	28
Suspension bicycles	5	- Front wheel removal & replacement	29
BMX/Loop frame/U-Frame bicycles	6	- Rear wheel removal & replacement	30
Road bicycles	7	- Correct quick release axle setting	31
3. BEFORE YOU RIDE	8	- Hub bearing adjustment & lubrication	32
Correct Frame Size	8	- How to fix a flat tyre	33
Riding Position	10	- Tyre valve	34
- Saddle height	10	Steering System	35
- Reach	10	- Handlebar stem	35
- Handlebar height	11	- Handlebar / forks	36
- Controls Position Adjustment	11	Bicycle suspension	37
Safety Checklist	12	- Headset	38
- Brakes	12	- Quill type assemblies	38
- Wheels & tyres	12	- 'A-head Set' type assemblies	38
- Saddle	12	- Rotor installation & adjustment	40
- Steering	13	Saddle & Seat Post	41
- Chain	13	Brakes	43
- Bearings	13	- Sidepull callipers	44
- Cranks & pedal	13	- Linear pull	45
- Derailleur	13	- U-brake	47
- Frame & fork	13	- Disc brake	48
- Suspension	13	Drivetrain	49
- Accessories & safety	14	- Pedals	49
Helmets	14	- Clipless pedals	50
Riding Safely	15	- Crank set	52
- General rules	15	- One piece crank set	53
- Wet weather riding	16	- Cotterless cranks (three piece)	54
- Night riding	16	- Chain	56
- Pedalling technique	16	- Freewheel	57
- Hill technique	17	- Coaster hub	58
- Cornering technique	17	Derailleur Systems	59
- Rules for children	17	- Rear derailleur	60
Gears - How to Operate	18	- Front derailleur	62
- Derailleur gears	18	Reflectors	63
- Operating principles	19	Accessories	64
- Hand grip shifters	20	Troubleshooting	66
- Below the bar shifters	20	6. FOLDING BICYCLE INSTRUCTIONS	68
- Dual control shifters	21	7. ELECTRIC BICYCLE MANUAL	69
4. BICYCLE CARE & SERVICING	22	Basic overview	69
- Basic maintenance	22	Shimano Steps models	69
- Storage	22	Range on a full charge	71
- Security	22	Safety	72
- Special instructions for care of carbon fibre bicycles	23	Operation of pedal assistance & direct power	73
- Schedule 1. Lubrication	24	Maintenance	75
- Schedule 2. Service Checklist	25	Battery charging	76
Torque Requirements & Tools Required	26	8. CONTACT ADDRESS	Back cover
5. COMPREHENSIVE MAINTENANCE	27		
Wheels and Tyres	27		
- Wheel inspection	27		



PART 2 - PARTS IDENTIFICATION

Finding the bicycle to best suit your needs is made easy by the vast array of bicycle models and sizes available. Refer to the following diagrams to familiarize yourself with the names of the various parts on your bicycle.



WARNING: Handlebar handgrips or tube-end plugs should be replaced if damaged. Unprotected tube-ends can cause injury. Bicycles used by children should especially be checked to ensure bar end handgrips are in good condition.

Mountain Bikes & Crossbikes.

Mountain bikes are one of the most versatile bicycles. Wider wheel rims and tyres ensure maximum comfort and traction over a wider variety of surfaces and the frame and forks are strong, making them particularly suitable for rough terrain. Manoeuvring is made easier by the wider handlebars and convenient shift lever position. The Crossbike or hybrid blends features of the mountain and racing bicycles. Its frame is lighter than a mountain bike but heavier than a racing bicycle, providing stability and comfort with increased speed.

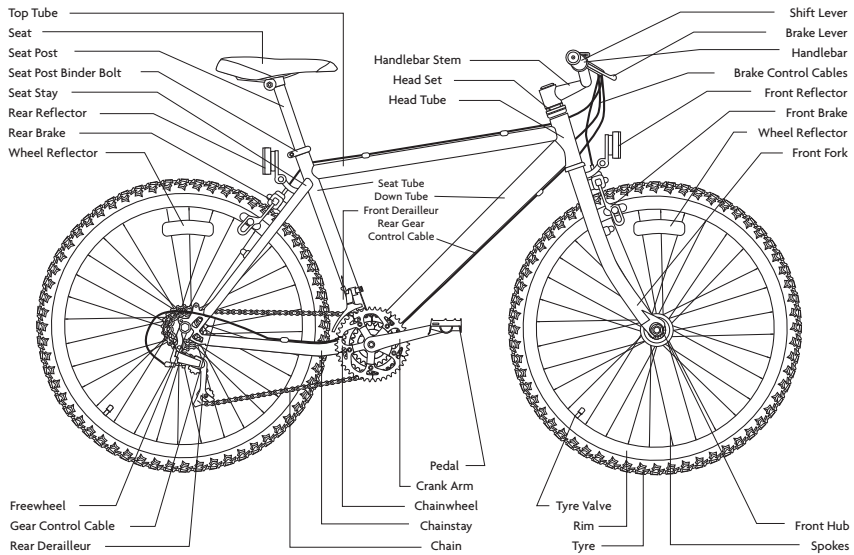



Suspension Bikes.

Suspension bicycles aim to maximize comfort and traction over rough terrain. The basis of the mountain bike frame is blended with suspension – either suspension front forks only or in combination with a rear suspension mechanism built into the frame. A special shock absorbing seat pillar may also be present for improved rider comfort. Despite the variety of suspension bikes available the basic components are similar in all models, such as wide rims and tyres for increased traction and comfort.

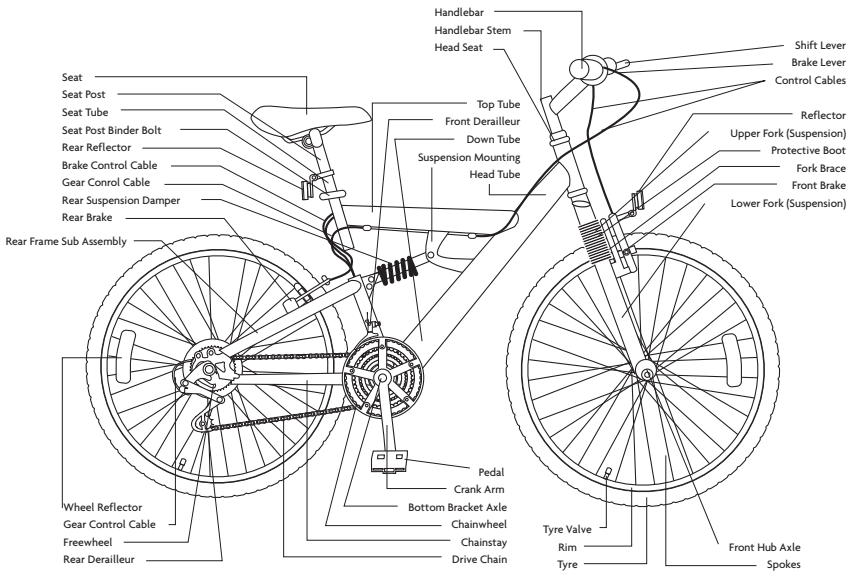



BMX Bicycles.

BMX style bicycles are ideal for young riders. Their durable, simple design makes them perfect for general purpose use with minimal maintenance required. Alternative frame styles, such as U-shape frames and loop frames, may also be used for other varieties of children's bicycles.



WARNING:

General purpose freestyle and BMX bicycles are not designed for stunting, racing, or competition use.

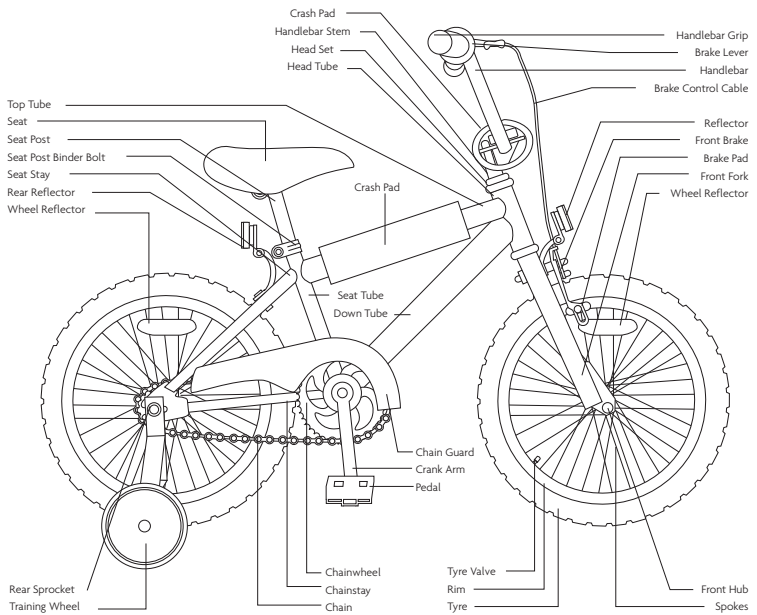



Road Bicycles.

Road or racing bikes aim to cater for fast travel over long distances on smooth surfaces. Frames are light weight and rims have a narrower profile, for maximum efficiency and speed.

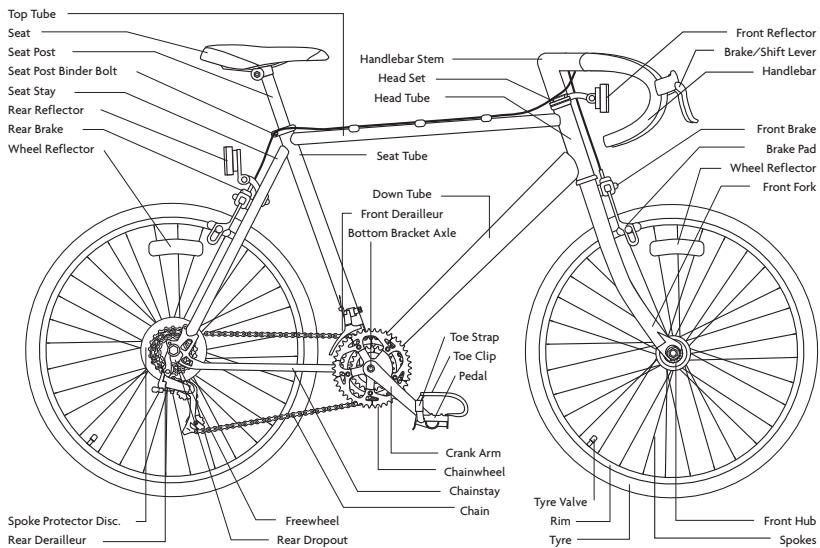



PART 3 - BEFORE YOU RIDE

FRAME SIZE

Choosing the appropriate frame and wheel size is imperative when purchasing a new bicycle.

For safe riding the size of your bicycle should properly match your build. In the case of children, a bike should never be bought with aim of “growing into it”. Riding the appropriate sized bicycle enables the child to develop confidence, as they have the necessary co-ordination to control the bicycle. To accommodate the vast array of height and size variables in children, even within the same age groups, juvenile bicycles come in different wheel sizes and frame styles to best suit the rider’s size.

Ladies and gents’ bicycles are also available in a variety of frame sizes. Sizing is based on the distance between the centre of the bottom bracket and the top of the frame seat tube.

Female riders should take into account the slope of the top tube to determine frame size suitability.



WARNING:

For safe riding your bicycle should match your size correctly, otherwise you may lose control and fall. Ideally there should be a minimum clearance of 25mm between the crotch of the intended rider and the top frame tube of the bike, while the rider straddles the bicycle with both feet flat on the ground.

Clearance over the top of the frame ensures that the rider can safely stand astride the bike when forced out of the saddle, such as stopping at traffic lights. Clearance heights vary according to rider preference and between the different bicycle models.

Please refer to the chart below to assist you in making the correct choice.

If you have any queries refer to your dealer.



Bicycling Sizing Guide

Approx. rider Inner leg length	Approx. Ages	Wheel Size (kid's models)	Suggested Frame Size for Road Bikes	Suggested Frame Size for Mountain or Hybrid Bikes
40cm min.	4-6	30cm(12")	-	-
46cm min.	5-10	40cm(16")	-	-
55cm min.	6-14	50cm(20")	-	-
61cm min.	12-16	61cm(24")	-	-
61-69cm	12 plus	-	-	37cm(14.5")
66-76cm	12 plus	-	-	43cm(17")
71-79cm	12 plus	-	50cm(19.5")	45cm(18")
76-84cm	12 plus	-	55cm(21.5")	50cm(19.5")
79-86cm	12 plus	-	57cm(22.5")	52cm(20.5")
81-89cm	12 plus	-	60cm(23.5")	53cm(21") - 56cm(22")
86-94cm	12 plus	-	63cm(25")	58cm(23") - 60cm(23.5")

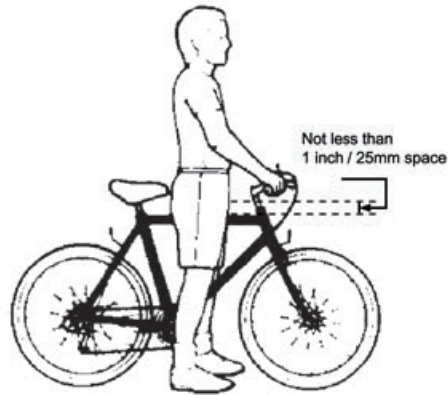



RIDING POSITION

1. Saddle Height

To ensure pedalling efficiency, safety and rider comfort it is crucial that the seat is set at the correct height. The rider's leg length is used to determine the appropriate saddle position. When the seat is positioned correctly the rider's leg should not strain from over-extension and the hips should remain level when pedalling. To establish seat height sit on the bicycle with one pedal at its lowest point, and place the ball of the foot on that pedal. If the knee is slightly bent in this position then the seat is at its correct height. The leg should be practically straight when the heel of that foot is placed on the pedal.

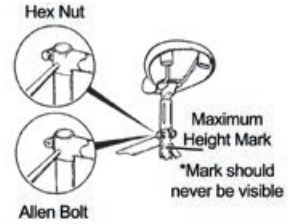
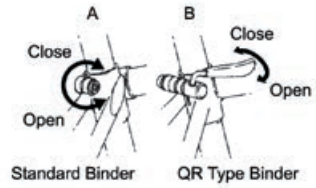

Caution:

Ensure the seat pillar post does not extend beyond the minimum insertion mark. (Refer to Page 42 on how to adjust the seat height). Take special note if your bicycle is fitted with a suspension type seat post.



WARNING:

Do not replace the seat post with a post which is: A) not of the same diameter or B) longer than the original. Either will void the warranty and could lead to seat post failure, loss of rider control and injury.

2. Reach

When riding it is important not to overextend one's reach. To determine the ideal positioning place your elbow against the seat and stretch out your arm toward the handlebars. The distance between the handlebar and the outstretched fingertips of the arm should be 20mm – 50mm. This distance can be adjusted by altering the location of the seat in relation to the seat pillar. (Refer to Part 5 on how to adjust the seat clamp)

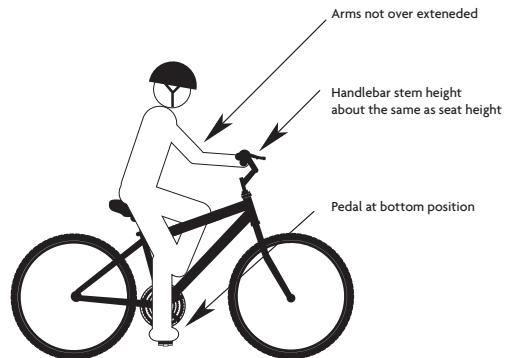

3. Handlebar Height

It is recommended you try various handlebar heights to find the most suitable position for you. Usually it is most comfortable when the handlebar height is the same as the height of the seat. The handlebar stems of some bikes can be altered to customize fit even further.



Caution:

Ensure the handlebar's stem does not extend beyond the minimum insertion mark. (Refer to Part 5 on how to adjust Handlebars).



WARNING:

The steering action may be compromised if the stem binder bolt,

the handlebar binder bolt or the bar end extension clamping bolts are not sufficiently tightened. This

could result in the rider losing control and falling. To check, try to twist the handlebar/stem assembly whilst the front wheel of the bike is positioned between your legs. If the stem twists in relation to the front wheel, the handlebars turn relative to the stem, or the bar end extension rotates in relation to the handlebar, the bolts need to be tightened.

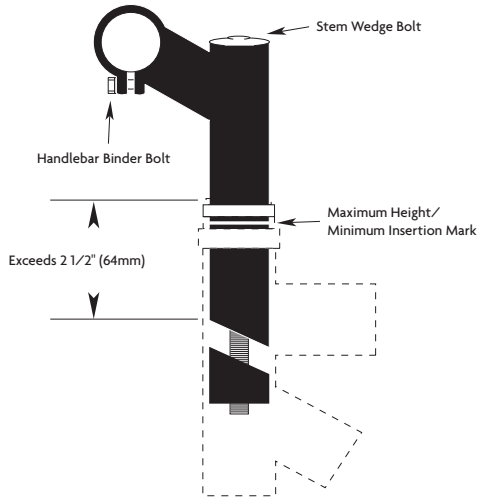

4. Controls Position Adjustment

The brake and shifting controls on your bicycle are positioned where they work best for most riders. The angle of the controls and the position on the handlebars can be changed. Ask your bicycle retailer to make the adjustments for you.

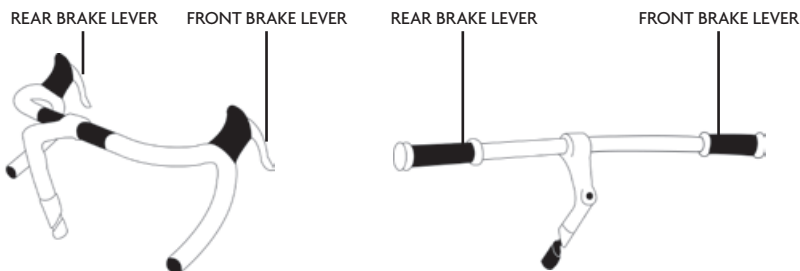

WARNING:

Front wheel brake lever must be mounted on the right hand side; rear brake lever on the left hand side.



SAFETY CHECKLIST

Safety checks are an important part of any ride. In conjunction with the recommended maintenance in Parts 4 and 5 of this manual it is also suggested that a thorough inspection should be undertaken fortnightly, tightening all nuts and bolts, replacing worn and damaged parts and ensuring all components are in their correct positions. For further details please refer to Parts 5 and 6.



WARNING:

Body parts and other objects should be kept clear from the moving components of the bicycle when in use, such as the spinning wheels and the moving chain. When riding always wear appropriate footwear – i.e. shoes that will grip the pedals and no sandals. Refrain from jumping with your bike. Jumping puts enormous stress on many components of your bicycle, especially your front fork.

Prior to every ride please complete the following safety checks.



1. Brakes

- Check front and rear brakes are working correctly
- Check brake control cables for wear and ensure they are oiled and properly adjusted
- Check brake control levers are lubricated and securely fastened to the handlebar.
- Check brake shoe pads for wear and their positioning in relation to the rims



2. Wheels and Tyres

- Check tyre pressure is as recommended according to the specification displayed on the tyre sidewall
- Check tyres for tread and ensure they do not have any bulges or excessive wear.
- Check all wheel spokes are firm and are intact
- Check rims run true and are without any obvious buckles or kinks
- Check that axle nuts are tight. For bicycles equipped with quick release axles, ensure locking levers are tensioned appropriately and in the closed position.



3. Saddle

- Check the clamp underneath the saddle is firmly secured to the saddle post
- Check frame clamping mechanism is tightly fastened
- Ensure that the minimum insertion mark cannot be seen on the saddle pillar



4. Steering

- Check that the handlebar and stem enable correct steering and are properly adjusted and tightened
- Check that the setting of the handlebars is correct in relation to the forks and the direction of travel
- Check the head set locking mechanism is appropriately fixed and fastened
- If handlebar extensions are fitted check they are positioned and secured correctly
- Ensure the minimum insertion mark cannot be seen on the handlebar stem
- Ensure the ends of the handlebars and bar ends are covered or capped.



5. Chain

- Check the chain is lubricated, clean and runs freely
- In wet or dusty conditions service the chain more frequently



6. Bearings

- Check headset, wheel bearings, pedal bearings and bottom bracket bearings
- Check all bearings are oiled, run smoothly and show no signs of excess movement, grinding or rattling



7. Cranks and Pedals

- Check cranks are securely fastened to the axle and are straight
- Check pedals are properly and firmly attached to the crank



8. Derailleurs

- Check the front and rear mechanisms are operating appropriately
- Check control levers are securely anchored
- Check derailleurs, control cables and shift levers are sufficiently lubricated
- If the gear components come with a separate, specific manual, refer to this for further information



9. Frame and fork

- Check that the frame and fork are straight and intact.
- Replace if either is bent or broken.



10. Suspension (if applicable)

- Check that components operate smoothly with no binding. Keep clean of grit, and lubricate top of outer leg seal.
- Check that all components of the fork & rear suspension are properly tightened
- Check the rear suspension components for excessive wear or side play
- If the suspension components come with a separate, specific manual, refer to this for more in depth information





11. Safety & Accessories

- Check that all reflectors are attached correctly and visible
- For riding at night, fit fully functioning dynamo or battery powered lights
- Check that the bell is fully operational
- Check all additional components on the bike are appropriately secured and functioning
- Ensure the bicycle rider and any passenger in a child seat are wearing helmets

HELMETS

When riding your bicycle it is recommended that you always wear an appropriately fitting, Australian Standards Approved bicycle helmet. This also applies to any passengers you may carry in a child safety seat.

A bicycle helmet must:

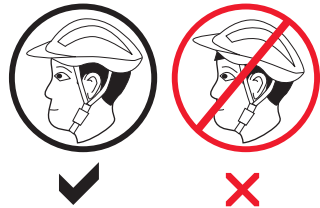

- carry the Australia & New Zealand Standards approved mark AS/NZS 2063 label
- fit properly

The helmet should be:

- well ventilated
- comfortable
- lightweight

The wearing of helmets is mandatory in most



Australian states. Non-compliance may result in an enforceable penalty.

RIDING SAFELY

General Rules

- The same road rules used for vehicles apply to cyclists. Obey the road rules at all times, such as giving way to pedestrians, and stopping at red traffic signals
- Notify the Road Traffic Authority in your state if further information is required.
- Ride on the left side of the road and never against the traffic.
- Take extra care when attempting to overtake other vehicles and at intersections.
- Indicate intended actions, such as turning or stopping, by using appropriate hand signals.
- Ride predictably and in a straight line.
- Always ride defensively. You may be difficult to see to other road users.
- Closely observe the riding terrain. Avoid obstacles such as pot holes, gravel, wet road markings, oil, curbs, speed humps and drain grates.
- Be alert. Watch for such things as motorists opening doors or backing out of concealed driveways.
- Sound your bell for a warning when required.
- Train and tram tracks should be crossed at a 90 degree and preferably walk your bicycle over.
- Know how your bicycle operates. Practice braking, gear shifts and if fitted, using toe clips and straps.
- Always apply the rear brake first, then the front when braking. The front brake is more potent and if it is not used properly you may lose control and fall.
- Allow reasonable space between yourself and other vehicles and objects when riding and stopping. Take note of weather conditions and its possible impact on safe braking distances. e.g. Wet riding surfaces increase braking distances.
- Use leg clips or elastic bands if you are wearing loose trousers to stop them catching in the chain.
- Ensure your vision or control of the bicycle is not obstructed by any items you may be transporting.
- Do not use items that may impede your hearing. e.g. Headphones

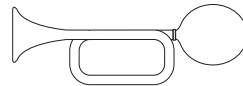

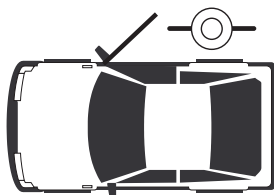

Wet Weather

- Ride more cautiously in wet weather. Avoid sudden braking, slow overall riding pace and approach corners more carefully.
- Brake sooner, stopping distance increases in wet conditions.
- Remember pot holes and slippery surfaces such as line markings and tram tracks all become more hazardous in the wet. Try to avoid where possible.
- Cornering traction will also be reduced in wet weather.

Night Riding

- Wear reflective and light coloured clothing.
- Reflectors should be fitted correctly to the bicycle and clearly visible. (Refer to Part 5 of this manual.)



Riding in the dark should never be undertaken without fully operational front and rear bicycle lights. The use of bicycle lights is mandatory for night riding in most Australian States.

- Attach a fully operational lighting set. Lights should have a white front lamp and a red rear lamp.
- Use a flashing rear light to improve visibility.
- Charge batteries if battery powered lights are to be used. Check wiring connections for dynamo powered lights.
- Avoid riding at night if possible. If not, slow down and opt for familiar roads with street lighting when able.

Pedalling Technique

- Place the ball of your foot on the centre of the pedal.
- Ensure your knees are parallel to the bicycle frame when pedalling.
- Keep your elbows slightly bent. This will help to absorb shock.
- Learn how to use the gears correctly (Refer to Pages 18-21 in this part of the manual).

Hill Technique

- Prior to a climb, gear down and continue gearing down as necessary in order to sustain pedalling speed.
- By standing up on your pedals you will be able to generate greater power from each turn of the pedal. This is useful if you are straining and are using the lowest gear.
- Use the high gears on a descent to prevent rapid pedalling.
- Take extra care when descending. Do not exceed a comfortable speed and maintain control.



WARNING:

Downhill mountain biking can be a dangerous activity. To reduce the likelihood of injury appropriate safety equipment should be worn and ensure that your bike is working perfectly. Follow all of the above instructions.

Cornering Technique

- Before entering a corner brake slightly and begin to lean your body into the corner.
- The inside pedal should be held at the 12 o'clock position and the inside knee angled slightly in the direction you are turning. The other leg should be kept straight.
- Avoid pedalling through fast or tight corners.

Rules for Children

Any child bicycle rider needs to be taught correct riding skills and behaviour, particularly addressing safety, before they take to the streets. Hopefully by doing so accidents can be avoided.

1. Always wear a correct fitting helmet
2. Follow all road rules, especially stop signs and red lights
3. Always proceed with caution before entering a street. Only enter if there is no traffic approaching.
4. Avoid riding on driveways or the road
5. Do not ride on busy streets
6. Be conscious of other road vehicles in the vicinity
7. Avoid night riding
8. Take extra care when riding downhill. Slow down using the brakes and maintain control of the steering

As suggested by the Consumer Affairs Department riding bicycles with small wheel diameter at excessive speeds can lead to instability and is therefore not recommended.



Caution:

When riding downhill never take your hands off the handlebars, or feet off the pedals.



GEARS: HOW TO OPERATE

Derailleur Gears

Derailleur gears are the most common type of gear systems used on bicycles. They are the changing mechanism used to move the drive chain up and down a series of cogs or sprockets (the cluster or cassette stack) at the rear of the bicycle and across the chainwheel at the front of the bike (if fitted). Multispeed bicycles today can range from 5-6 gears to as many as 30.

Rear derailleurs are fitted to all multispeed bicycles while front derailleurs are only present on those bicycles with the higher number of gears.

Gears enable the cyclist to select the most appropriate pedalling resistance best suited for the riding conditions. The more gears fitted to the bicycle the greater choice available to the rider.

TYPES OF GEAR SHIFTERS

- Hand Grip Shifters
- Below Bar Shifters
- Dual Control Shifters



Operating Principles

Although the number of gears present on multispeed bicycles varies greatly, how the gears function remains the same. The right shifter works the rear derailleur and the left shifter works the front derailleur. If the pedals are stationary or rotating backwards, gears cannot be changed. They can only be altered when pedalling forward. To achieve a successful gear change, either moving up or down in gears, the pedalling pressure must be relaxed. Failure to ease the pressure when changing gears may result in bicycle damage or could even cause the rider to lose control. If a rubbing sound is detected after attempting to alter gears, adjust the shifter until the sound ceases. Generally the lower gears are for ascending hills and the higher gears are for descending. To extend the life of your chain avoid using extreme gear combinations as shown in the diagrams below.

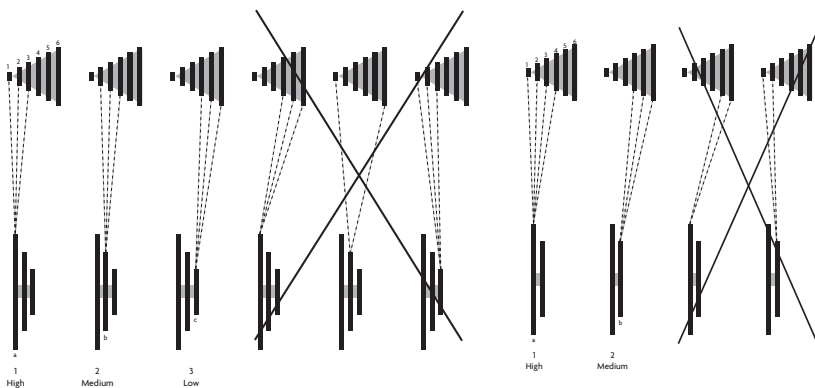

Recommended Chainwheel/Rear Sprocket Gear Combinations



Hand Grip Shifters

Hand grip shifters are built into the hand grip and attach to the handlebars. Unlike other types of shifting mechanisms the hand grip shifters mean you do not need to change your hand position to select different gears. The rider just simply twists forwards or backwards dependent upon their gear selection. By twisting the right shifter toward you, a lower gear is chosen as a larger rear cog is selected. Twisting this shifter away from you has the opposite effect; a higher gear is selected as a smaller rear cog is engaged. Turning the left shifter forward or away from you activates a smaller, front chainwheel, and a larger, front chainwheel is engaged by twisting it backwards. The number of gear changes to occur at any one time corresponds with how many turns are made of the shifter. Check the diagram below for operating instructions.

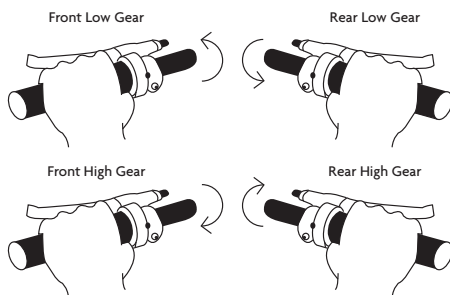

Below the Bar Shifters

The majority of mountain style bicycles use below bar shifters. These shifters are mounted on the underside of the handlebars, usually between the grips and the handlebars. It is a two finger operating system which uses the thumb and index finger to make the gear selection. By pushing the lower (larger) right shifter with your thumb, a lower gear is selected as a larger, rear cog is engaged. One cog can be selected through one firm push, or by continuing to push on the lever multiple cogs can be engaged. By pushing the upper (smaller) lever on the left inwards with your index finger, the chain moves to a smaller chainring. A higher gear can be selected by pushing the upper right lever with your index finger to activate a smaller rear cog. By pushing the lower left lever with your thumb the chain will move from the smaller to the larger chainring. To clarify please refer to the following diagram.

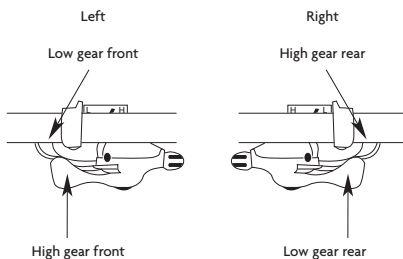

Dual Control Shifters

The majority of drop bar road bicycles produced today are fitted with dual control levers. Since both the brakes and the gears are built into the one mechanism, dual control shifters make it possible to change gears without having to remove your hands from the handlebars. Shifting can be performed whilst your hands are resting on the lower bend of the handlebars or on the brake lever hoods (in the "drops"). Pulling the shifter towards the bar activates the brakes, while shifting the dual control lever inwards towards the front wheel engages the gears. To select a higher gear, the small right lever is pushed to engage a smaller, rear cog. Pushing the large lever inwards activates the large, front chainwheel. To select a lower gear, shift the large right lever inward to engage a larger rear cog. One firm push shifts the chain one cog, while continuing to press will move the chain over multiple cogs.

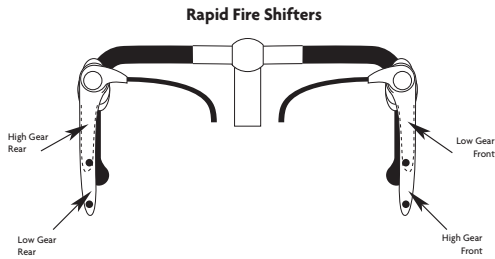



BICYCLE CARE

Basic maintenance

To keep your bicycle in prime condition follow the recommendations listed below.

Painted frames should be dusted and any loose dirt dislodged with a dry cloth. Clean by wiping with a damp cloth soaked in a mild detergent mixture. Use a cloth to dry and polish with car or furniture wax. Plastic parts and rubber tyres should be cleaned with soap and water. Wipe a rust preventative fluid over chrome plated bikes.

All moving parts should be habitually cleaned and lubricated, and components secured and adjusted as needed. (Refer to Parts 4 and 5 of this manual for further details)

Apply touch up paint or clear nail varnish to any areas where the paint has become scratched or clipped to the metal. This will help prevent rusting.

The potential for rusting is limited by the use of alloy components and B.E.D (black electronic deposit) treated steel rims.

To avoid rapid bearing deterioration the hub and bottom bracket bearings need to be removed and re-greased if the bicycle has been submerged in water.

Avoid cycling in the rain or exposure to corrosive materials, such as the salt from riding on the beach, as much as possible. If unavoidable, wash and dry your bicycle often and wipe or spray all unpainted parts with an anti-rust treatment. Dry the wheel rims so braking performance is not hindered.

Storage

Protect your bicycle from the elements by storing it in a dry, shady location. Prolonged ultra violet light exposure may cause the paint to fade or the rubber and plastic parts to crack.

The bicycle should be cleaned, lubricated and the frame waxed if it is to be stored for any length of time. Deflate the tyres to half pressure and hang the bicycle off the ground. Store away from electric motors as ozone emissions may damage the rubber and paint. Do not cover with plastic as rusting may occur due to "sweating."

Security

In an attempt to prevent your bicycle from being stolen the following precautions should be undertaken.

1. Take note of the bicycle serial number, generally located underneath the bottom bracket of the frame.
2. Register the bicycle with the manufacturer/distributor and local police
3. If your bicycle is left unattended, always secure it to an immovable object, such as a lamp post. Use a high quality bicycle lock that will resist hack saws and bolt cutters.

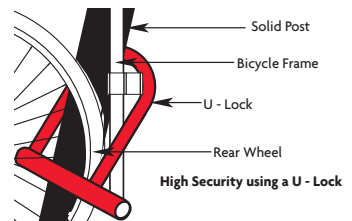



Special Instructions For Care of Carbon Fibre Bicycles

A carbon fibre frame requires special care due to the nature of its construction.

- Never clamp the bicycle using any of the carbon fibre frame tubes. Use the seat post to hold the frame during assembly.
- Do not use any solvents on the frame. Clean only with a mild detergent and water.
- Do not paint the frame.



WARNING:

Bicycles are not indestructible. This bicycle is made to withstand the stress of 'normal' riding because those stresses are well known and understood.

- Avoid scratches and direct impacts to the frame. If you are involved in a mishap, or your bicycle is scratched during use, immediately see your bicycle retailer for inspection of the damage.
- Use a chain protector to lessen the chance of chipping the carbon fibre tubing.
- Use the manufacturer's recommended size seatpost and headset. Do not attempt to alter the original sizes of these parts.
- Avoid overtightening of the seatpost.
- Any other questions? Please contact your bicycle retailer.



Regular and proper upkeep of your new bike means:

- Smooth Running
- Longer lasting components
- Safer Riding
- Cost savings

Routine bicycle maintenance is an essential component of riding. The condition of your bicycle changes every time it is used, meaning more frequent maintenance is necessary the more you ride your bicycle. The tables listed below outline the recommendations for servicing your bicycle. By referring to these and the information in Part 5 of this manual, you should be able to complete most of your bicycle maintenance yourself.

Contact your specialist bicycle dealer if you require further assistance.

Schedule 1 – Lubrication

Frequency	Component	Lubricate	How to Lubricate
Weekly	Chain	chain lube or light oil	brush on or squirt
	Derailleur wheels	lube or light oil	brush on or squirt
	Derailleurs	oil	oil can
	Brake callipers	oil	3 drops form oil can
	Brake levers	oil	2 drops from oil can
Monthly	Shift levers	lithium based grease	disassemble
	Brake cable ends	oil	1 drop from oil can
6 monthly	Hubs	lithium based grease	disassemble
	Bottom bracket	lithium based grease	disassemble
	Pedals	lithium based grease	disassemble
	Freewheel	oil	2 squirts form oil can
	Brake cables	lithium based grease	disassemble
	Derailleur cables	lithium based grease	disassemble
	Yearly	Wheels bearings	lithium based grease
Headset		lithium based grease	disassemble
Seat pillar		lithium based grease	disassemble

Note: Increase the regularity of maintenance the more you ride and use in wet or dusty conditions.

Take care not to over lubricate – excess lubricant should be removed to prohibit dirt build up.



WARNING:

Always seek expert advice for any maintenance requirements you feel unable to complete. You run the risk of potentially damaging your bicycle or yourself from falling if your bike is not correctly serviced or adjusted.

Schedule 2 – Service Checklist

Frequency	Task	Page Reference
Before every ride	Check tyre pressure	28
	Check brake operation	43
	Check wheels for loose spokes	27
	Make sure nothing is loose	26
After every ride	Quick wipe down with damp cloth	22
Weekly	Lubrication as per schedule 1	24
Monthly	Lubrication as per schedule 1	24
	Check derailleur adjustment	61
	Check brake adjustment	44
	Check brake and gear cable adjustment	44, 61
	Check tyre wear and pressure	28
	Check wheels are true and spokes tight	27
	Check hub, head set and crank bearings for looseness	32, 38, 52
	Check pedals are tight	51
	Check handlebars are tight	36
	Check seat and seat post are tight and comfortably adjusted	41
Check all nuts and bolts are tight	26	
6 monthly	Lubrication as per schedule 1	24
	Check all points as per monthly service	25
	Check and replace brake pads if required	48
	Check chain for excess play or wear	56
Yearly	Lubrication as per schedule 1	24



WARNING:

All components of the bicycle are subjected to wear and stress through use. Watch closely for any scratches, cracks or discolouration on your bicycle components. These are signs of a stress-caused fatigue and indicate that a part needs to be replaced. Failure to replace can cause the component to suddenly fail when riding, which may result in serious injury or even death.



Torque requirements

Nuts and bolts should only be adjusted using a torque wrench. This helps to prevent over tightening and damage to the threads. Different torque measurements are recommended when tightening different components. Use the following table to guide you in your torque application.

Component	Torque
Front axle nuts	22 – 27 Nm
Rear axle nuts	24 – 29 Nm
Handlebar clamp nut	17 – 19 Nm
Head stem expander bolt	17 - 19 Nm
Seat clamp nuts	12 – 17 Nm
Seat post binder nut	15 – 19 Nm
Brake cable fixing nut	7 – 11 Nm
Brake calliper centre bolt nut 1	2 – 17 Nm
Cotterless crank nut	27 Nm

Tools needed for making adjustments:

1. Adjustable wrench
2. Flathead screwdriver
3. Allen key wrenches: 2mm, 3mm, 4mm, 5mm, 6mm, 8mm
4. Tyre pump
5. Standard multi – grip pliers
6. Phillips head screwdriver
7. Open ended or ring spanners: 8mm, 9mm, 10mm, 12mm, 13mm, 14mm, 15mm
8. Torque wrench with Newton Meter increments
9. Tyre levers
10. Crank remover
11. Tube repair kit

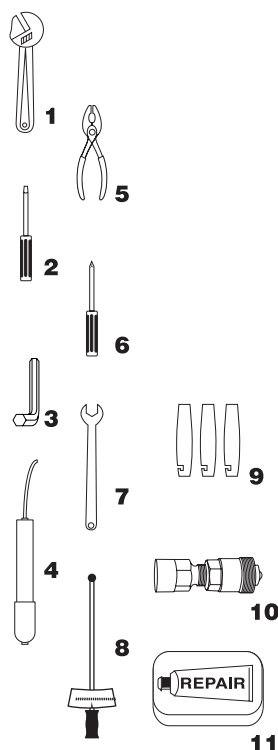

WHEELS AND TYRES

Wheels Inspection

Maintaining your wheels in prime condition is imperative for not only for riding efficiency and performance, but safety as well. When inspecting your wheels look for the potential hazards listed below.

Quick release: Caution: Quick release skewer levers should always read “closed”.

Prior to each ride check that these are set to the closed position and are at the correct tension. Serious injury may result if these guidelines are not observed.

Axle nuts: Caution: Do not ride the bicycle without first ensuring that the axle nuts are tight.

Buckled Wheels: Prior to each ride test each wheel to ensure that it is spinning straight. If the wheels are misaligned adjustment will be necessary. We recommend any adjustments should be completed by a professional bicycle mechanic as it is quite a complex task. In the case of buckled wheels that use rim brakes, braking is adversely effected.

Broken or loose spokes: Caution: Damaged spokes can create severe instability and have the potential to cause an accident for the rider. Before riding ensure that all spokes are present, intact and are taut. Spoke repairs can be difficult and are best undertaken by a professional bicycle mechanic.

Loose hub bearings: Caution: Do not ride your bicycle if the hub bearings are loose or damaged. Check the hubs by moving the wheel from side to side. If movement is detected adjustments will be needed.

Rims: Brakes can become ineffective if dirt or grease accumulate on the rims. Check that your rims are clean and dry before using. Take care to prevent oil contact on the rim braking surfaces when lubricating your bicycle.





Tyre inspection

As tyres are the rider's only contact with the road, correct tyre maintenance is crucial for stability and safety. Consider the following when inspecting your tyres:

Tread: Check the tread for signs of excessive wear or flat spots, and cuts or damage. Caution: Riding on excessively worn or damaged tyres may be hazardous so tyres should be replaced.

Inflation: Maintain tyre pressure at the level recommended on the tyre sidewalls. Preferably use a tyre gauge and a hand pump to inflate rather than a service station pump. Caution: Using a service station pump for inflation can lead to sudden over inflation, potentially resulting in a blow out.

Valves: A flat tyre is not only inconvenient but potentially dangerous. To minimise the likelihood of a flat tyre from air leaking from a valve, ensure valve caps are fitted and that valves are clean.

Bead setting: Ensure the bead is correctly fitted in the rim when inflating or changing tyres.

Recommended Tyre Pressures:

Tyre pressure directly influences the performance of a tyre on different surfaces and in varying weather conditions. Recommended tyre pressure is given either as maximum pressure or as a pressure range.

For riding on smooth, slick terrain such as hard-packed clay and on deep, loose surfaces such as deep, dry sand, tyres should be inflated to lower pressures, at the bottom of the recommended pressure range. This helps to cushion the rider against the impact.

Using high pressures, at the top of the recommended pressure range enables a faster but rougher ride. These pressures are ideal for riding on a smooth, dry pavement.

Failure to sufficiently inflate the tyres according to the rider's weight and intended use can cause the tube to puncture.

Tyres should be inflated to the recommended pressure moulded on the sidewall of the bicycle's tyres. Use this chart as a reference to convert the recommended pressure to the units displayed on your pump.

PSI	BAR	kPa	PSI	BAR	kPa
10	0.70	69	90	6.21	620
20	1.37	138	100	8.89	689
30	2.07	207	110	7.58	758
40	2.76	276	120	8.27	827
50	3.45	345	130	8.96	896
60	4.14	414	140	9.65	965
70	4.83	482	150	10.34	1032
80	5.52	551	160	11.03	1103



Caution:

Service station pumps and pencil type automotive tyre gauges should not be relied upon for consistent, accurate readings. A good quality dial gauge should be used as it is far more accurate and reliable.

Front Wheel Removal

1. Open the brake quick release, if fitted, or screw in the brake cable adjuster. You may need to undo the brake cable anchor bolt if more clearance is required.
2. Where standard axle nuts are present use a spanner to loosen. If secondary retention devices are fitted slacken the nuts enough to give clearance to remove the wheel.
3. Turn the lever to the open position if a quick release axle is fitted. Where the secondary retention devices are fitted, the adjusting nut at the opposite end to the Quick Release lever needs to be loosened sufficiently to permit the wheel to be removed.
4. Remove the wheel.

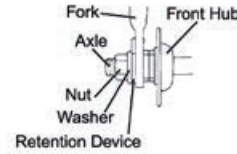
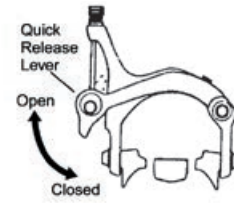

Front Wheel Replacement

1. Guide the wheel into the frame ensuring that the axle fits well up against the fork slots. The fork legs may need to be slightly prised apart.
2. If the wheel has a Quick Release axle, ensure the quick release lever is open on the left side of the bicycle. Check Quick Release tension and close the lever when adequate tension is achieved. When closed the lever should be parallel to the fork to prevent accidental opening when riding.
3. When secondary retention devices are present, ensure they are properly lodged in the fork ends.
4. If fitted, firmly fasten both axle nuts.
5. Re-set the brake quick-release and inspect the brake pad clearance. If able, adjust the brake cable/pad clearance.

Axle correctly seated in dropout

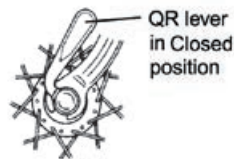

WARNING:

The secondary retention device is crucial to safe riding. Tampering with or removal of this device may cause serious injury or death. It may also void your warranty.

CAUTION:

You need to ensure the tension of the quick release lever is sufficient. To tighten, open the lever and turn the tension adjusting nut clockwise a quarter turn until you can only fully close the quick release by wrapping your fingers around the fork for leverage, and the lever leaves a clear imprint in the palm of your hand.

WARNING:

Quick release adjustments are still necessary even if secondary retention devices are fitted. Failure to properly adjust the quick release mechanism may lead to wheel instability, which ultimately could cause the rider to lose control and fall.





Rear Wheel Removal

1. Open the brake quick release, if fitted, or screw in brake cable adjuster. Undo the brake cable anchor bolt if greater clearance is required.
2. Move the chain onto the smallest rear cog if derailleur gears are fitted.
3. When the wheel is fitted with standard axle nuts, loosen them with a spanner.
4. Turn the quick release lever to the open position if a quick release axle is present.
5. Hold the derailleur unit and allow the wheel to slide forward out of the frame.
6. Rest the bike upside down on the handlebars and saddle. After wheel is removed, do not rest bike on rear derailleur, as it may be damaged or misaligned as a result.
7. For single gear bicycles with a coaster hub, disengage the brake arm clip from the brake arm, lift the chain off the rear cog and over the rear axle by hand, then allow the wheel to slide out of the frame.

Rear Wheel Replacement

1. Wheel replacement virtually follows the reverse process to rear wheel removal
2. For derailleur geared bicycles, hold the rear derailleur spring fully back and feed the top part of the smallest hub cog into the top part of the chain. Fit the wheel into the frame.
3. For single geared bicycles, lift the chain over the axle and onto the cog, and fit the wheel onto the frame.
4. Ensure the wheel is centred correctly in the frame and then firmly secure both axle nuts. To test if the wheel is centred, inspect the distance between the front of the wheel and the frame chainstay tubes on either side.
5. If the wheel has a Quick Release axle, the quick release lever needs to be open and on the left side of the bicycle. Check the Quick Release tension and close the lever when correct. For safety reasons the lever should be parallel to the frame seat stay tube.
6. On coaster hub bicycles, the brake arm needs to be reconnected to the brake arm clip on the chainstay.
7. Reset the brake quick release and check the brake pad clearance. If required, adjust the brake cable/pad clearance.



Caution:

Take care to correctly refit a rear wheel.
Failure to do so may be dangerous.

QR lever
in Closed
position

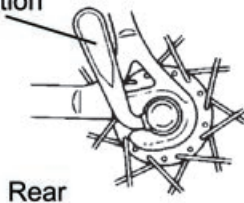

Correct Quick Release Axle Setting

The process of removing wheels is made considerably easier if a Quick Release mechanism is fitted to the wheel axle. Wheels can be removed without using tools. The Quick Release mechanism consists of a lever controlling a cam-action tightener and at the other end a long bolt with an adjusting nut.

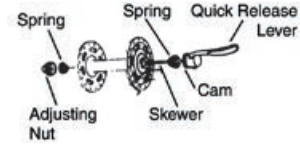

WARNING: It is crucial that the Quick Release mechanism is properly adjusted when riding. Failure to do so may cause the wheel to wobble or disengage from the bicycle, possibly resulting in harm to the bicycle, and/or the rider.

Consequently:

1. Seek instruction from your bicycle specialist on the correct process for removing and installing Quick Release wheels
2. Prior to riding your bicycle, ensure that the wheel lever is firmly clamped.

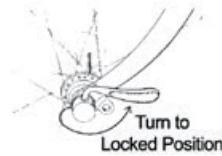
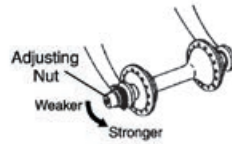

To correctly clamp your quick release wheels in place, refer to the following.

1. To set, open the lever so that the curved part faces away from the bicycle.
2. While holding the lever in one hand, spin the adjusting nut manually until it is tight.
3. Spin the lever halfway towards the closed position. Tighten the adjusting nut in a clockwise direction until there is firm resistance to turning the lever beyond that point.
4. Pivot the lever all the way to the closed position so that the curved part of the lever faces the bicycle.
5. When the jagged edges on the Quick Release clamping parts actually begin to cut into the bicycle frame/fork surfaces the wheel is firmly secured.
6. To operate a Quick Release seat post binder mechanism follow the same process.





Hub Bearing Adjustment

The hub bearings of both wheels should be inspected for side movement. Adjustment is required if there is any more than slight lateral movement.

To adjust:

1. Remove the wheel from the bicycle.
2. Use a flat, open ended cone spanner to hold the adjusting cone of the hub and simultaneously loosen the hub's locknut on the same side.
3. Turn the adjusting cone as required until there is minimal side play, and before binding of the bearings occurs.
4. Hold the adjusting cone in position and secure the locknut.
5. Test that the wheel spins freely without excessive lateral movement, or binding on the bearings.

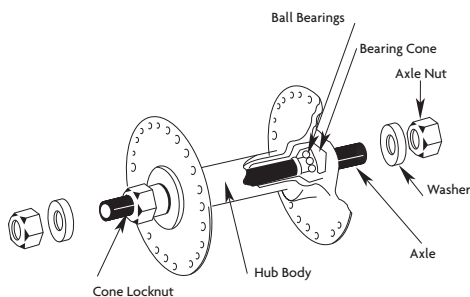

Hub Lubrication

At least once a year your wheel bearings need to be disassembled and re-greased. Riding in very muddy or wet conditions will mean more frequent servicing. Due to the complexity of the task you may prefer to have a professional bicycle mechanic perform the disassembly. However, if you feel capable the process is listed below:

1. Take the wheel out of the frame.
2. Remove the axle nut, cone lock nut, and the bearing cone from one side of the hub axle.
3. Remove the axle, complete with the cone and lock nut, from the other side of the hub.
4. If your bicycle is fitted with dust caps, carefully remove them from both sides of the hub to expose the ball bearings.
5. If ball bearings and ball retainers are present, carefully remove these from both sides of the hub.
6. Remove the freewheel on rear hubs with screw on type freewheels before disassembling the axle. (You will need to use a special tool to do this.)
7. Clean all the hub components thoroughly and check for damage, especially looking for pits or grazes in the bearing surfaces and cones, and damaged ball bearings. Replace if required.
8. Insert grease into each clean or new ball bearing and into the inner cups of the hub, and refit.
9. Re-assemble the hub axle in reverse sequence to disassembling, taking care to properly re-adjust the bearing cones.

How To Repair A Flat Tyre

There comes a time when most cyclists will need to repair a flat tyre. Use the following steps to guide you through the process:

1. Take the wheel off the bicycle.
2. Using the valve, entirely deflate the tyre.
3. Push the tyre bead inwards around the whole rim to loosen.
4. Using tyre levers only (to avoid damaging the rim), prise one side of the tyre bead up over the edge of the rim.
5. Leave the tyre on the rim and remove the tube.
6. Replace or repair the tube. Note: The replacement tube size needs to correspond with the size detailed on the sidewall of the tyre and the valve type needs to be suitable for your bicycle. Refer to the instructions in your tyre repair kit to successfully patch a tube.
7. To determine the possible cause of the leak, match the position of the puncture in the tube in relation to the tyre and mark the location on the tyre.
8. Remove the tyre completely from the rim and examine, removing any foreign objects noted, eg. glass or a nail. Also inspect the inside of the rim for other potential causes, such as protruding spokes. Replace the rim tape covering the spoke ends, if damaged.
9. Remount the side of the tyre onto the rim.
10. Partially inflate the tube with a hand pump until it starts to take shape.
11. Taking care not to twist the valve stem, place it through the hole in the rim and work the tube into the tyre.
12. Starting either side of the valve use your hands to remount the other side of the tyre by pushing the edge toward the centre of the rim. Work around the rim until the tyre is almost completely remounted.
13. Push the valve up into the rim and ensure that the tyre sits properly in position.
14. Remount the remainder of the tyre by using your thumbs to roll the last, most difficult, part on. Note: Do not use tyre levers as these can easily puncture the tube or damage the tyre.
15. Ensure that the tube is completely free of the rim and the tyre bead at all points.
16. Inflate the tube with a hand pump until the tyre begins to take shape, ensuring the tyre bead sits evenly around the entire rim. Fully inflate the tyre to the pressure marked on the sidewall when properly positioned. Check pressure with a tyre air pressure gauge.
17. Replace the wheel into the frame and adjust gears, brakes and quick release levers as necessary.

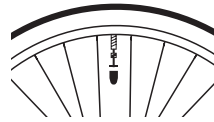



Tyre Valves

Bicycles primarily use either Schraeder™ or Presta tyre valves. To inflate tyres the pump needs to be fitted with the appropriate attachment specific to the valve stem.

The Schraeder™ valve is the most commonly used tyre valve. It is also known as the car or the American valve. Tyres fitted with Schraeder™ valves can be inflated using either a hand pump or a service station pump, as it is the same valve used on cars. Inflation involves removing the valve dust cap, then screwing or pushing on the pump connector to the end of the valve stem and inflating. By depressing the pin in the end of the valve stem the tyre can be deflated.

The Presta valve is also referred to as the French or high pressure valve. In order to inflate tyres equipped with this valve, the pump needs to have a special fitting attached to accommodate the valve's narrower profile. The service station pump can be used if an adapter is screwed onto the valve stem. Inflation involves removing the dust cap, unscrewing the valve stem locknut, freeing the valve stem by pushing down on it, then fitting the pump head and inflating. Deflation is achieved by opening the valve stem locknut and depressing the valve stem.

Note: The valve dust cap should always be replaced in order to prevent dirt entering and damaging the valve.

Using a service station pump to inflate tyres is not encouraged as tyres may blow out if sudden over inflation occurs.

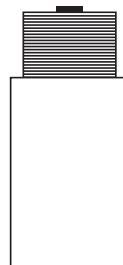

Schraeder™ Valve
(Car/American)

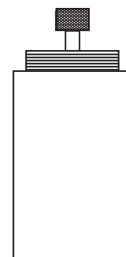

Presta Valve
(French)

™ - Schraeder is a registered Trademark
of the Schraeder Corporation Inc.

STEERING SYSTEM



Handlebar Stem

Usually the standard handlebar stem is secured into the steering column by the binder bolt and expander wedge. These bind with the inside of the fork, steerer tube when tightened. The stem may also clamp onto an unthreaded fork steerer, as is the case with the 'A-head Set' system.

Note: The handlebar height can be altered to suit the rider's preference.

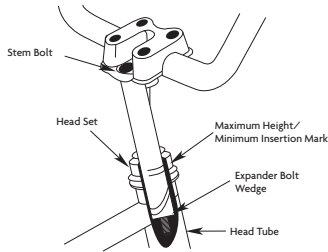

BMX Handlebar Assembly

To remove a standard stem, the expander bolt needs to be loosened two or three turns, and then tapped to free the wedge inside. Servicing involves applying a thin film of grease to the part after it has been wiped clean. Also lubricate the wedge that will be inserted into the frame.

NOTE: These same adjusting principles cannot be applied to the 'A-head Set' headstem system.



Etched on the stem is a mark about 65mm up from the bottom with the words "max. height" or "minimum insertion". Never ride a bicycle if the stem has been raised so that the minimum insertion / max. height line can be seen.

The front brake cable is routed through a hole in the front of the stem on some MTB bikes.



Adjusting the height on this type of stem means you will need to re-adjust the front brake.

Check that the suspension is intact and operating properly on bicycles equipped with a suspension type handlebar stem.

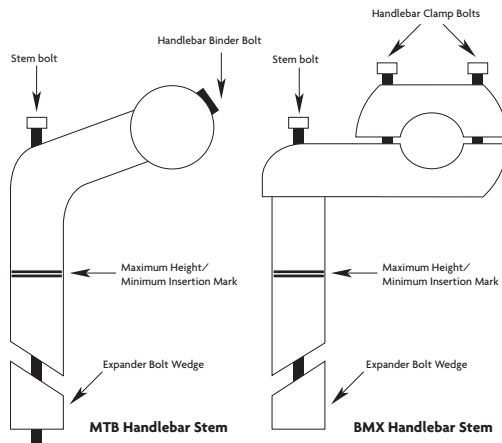



Ensure that the handlebars are appropriately aligned and are tightened to a minimum 17Nm of torque when re-fitting the stem. Use only the appropriate Allen key or hex wrench for fastening and take care not to over tighten.

Test the attachment by bracing the front wheel between your knees and try to move the handlebars up and down and from side to side. The handlebars are secure within the stem and the stem within the fork steerer tube if no movement is detected when applying turning pressure.

Handlebar / Forks

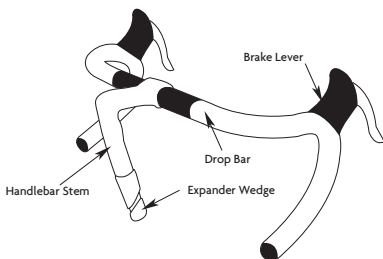

Racing Handlebar Assembly

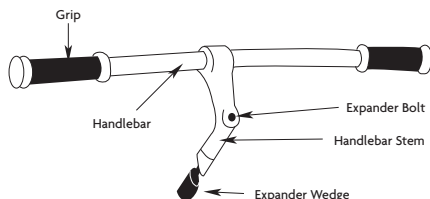

MTB Handlebar Assembly

Handlebar positioning is largely directed by rider preference. However, there are general principles governing how the handlebars should be set up for the different bicycle types. On BMX bicycles, the handlebar should remain roughly in an upright position, with slight forward or backward adjustments for rider comfort. For MTB bikes, it is recommended that the bar should be almost horizontal, with the ends pointing back and slightly down. The drop-style handlebars of racing bicycles should have the ends angled toward the rear wheel hub.

A single Allen key or hexagonal bolt is used to secure the handlebar into the stem on MTB and Racing style bicycles. BMX bicycles may have four clamping bolts.

These should be tightened to 18Nm.

Ensure that the curved rake of the fork is angled to the front of the bicycle when setting the handlebars in the fork.

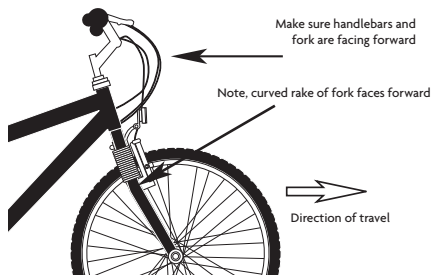

Always check the handlebar clamping mechanism has been firmly tightened prior to riding.

Regularly inspect the handlebar grips and tube end plugs. If damaged, replace, especially on children's bicycles, as exposed ends on handlebars can cause injuries.

Replacement forks must have the same rake, length and inner tube diameter as those originally supplied on the bicycle.

Bicycle Suspension

To help combat some of the jarring associated with riding on rough terrain some Mountain Bikes are fitted with suspension systems. Primarily suspension systems are built into the forks or the rear of the frame, but can also be included in seat posts as well. By equipping the bicycle with suspension can improve its comfort and handling properties, and potentially enable the cyclist to ride faster. However, for safety reasons it is imperative you still ride within your own limits. Over time as your riding capabilities improve you may be able to fully appreciate and handle the bike's features.

Please note, using your bicycle for competitive events, dirt biking, bicycle racing, ramp riding, jumping, stunt riding, downhill racing or similar activities or training for such competitive activities is not recommended.

The range of suspension systems available is vast and will not be detailed comprehensively in this manual. Instead, if your bicycle is equipped with a suspension system and you require further information, refer to the separate leaflet included with your bike (where supplied) or seek assistance from your specialist dealer.



WARNING: Failure to inspect and correctly adjust the suspension system may result in suspension malfunction, potentially causing you to lose control and fall. Keep all exposed moving portions of the suspension system clean and lubricated.

CAUTION: Suspension adjustment should only be made according to the suspension system's manufacturer instructions and recommendations. Always test-ride your bicycle following alterations to the suspension adjustment, looking for any changes to the bike's handling and braking characteristics.

CAUTION: Always refer to the bicycle's manufacturer before attempting to retrofit suspension as not all bikes can be retrofitted with some types of suspension. Please note changes from the original specifications may void your bicycle warranty.

WARNING: Please note, the front of a bicycle fitted with suspension dips under braking. The rider needs to familiarise themselves with the suspension system before attempting riding at great speeds or down hilling. Failure to do so could cause the rider to lose control and fall.





Headset Inspection

The headset is responsible for locking the fork into the frame. Every month the headset bearing adjustment should be tested. This is done by standing astride the frame top tube with both feet on the ground and firmly applying the front brake and rocking the bicycle back and forward.

If the headset is loose, it needs to be tightened to avoid potential damage to both the bicycle and the rider.

However, do not over-tighten. If the fork tends to stick or bind at any point when rotated slowly sideways, the bearings are too tight.

Quill Type Assemblies

Adjustment

To adjust the headset the top locknut needs to be loosened or removed completely, as well as the lock washer and reflector bracket, if fitted. Turn the adjusting cup clockwise until finger tight. Replace the lock washer or reflector bracket and using an appropriate wrench to re-tighten the locknut.

Note: Bearing damage will occur if over-tightened.

Prior to riding always check that the headset is properly adjusted and that the headset locknut is securely fastened.

'A-head Set' Type Assemblies

When assembling a new bike with this type of fitting, the dust cap covering the Allen head bolt needs to be removed and the bolt holding the top plug undone. Remove the cardboard cover. Slip the handlebar stem over the exposed fork steerer and replace the top plug. The handlebars and the forks need to be facing the front. Using the Allen head centre bolt, secure the steering assembly until there is no freeplay. Take care not to over tighten. Tighten up the binder bolts which clamp the handlebar stem to the fork steerer. Ensure the handlebar stem cannot turn in the steerer tube.

To adjust the headset after the bicycle is assembled:

- Loosen the stem binder bolts.
- Use the Allen bolt to re-adjust the compression mechanism.
- Re-fasten the stem binder bolt firmly.

Unlike standard headsets, the 'A-head Set' has an unthreaded, full-thickness bicycle fork steering tube. Adjustments are made using an Allen headed compression bolt, and then are fastened by clamping the handlebar stem directly onto the fork steerer.

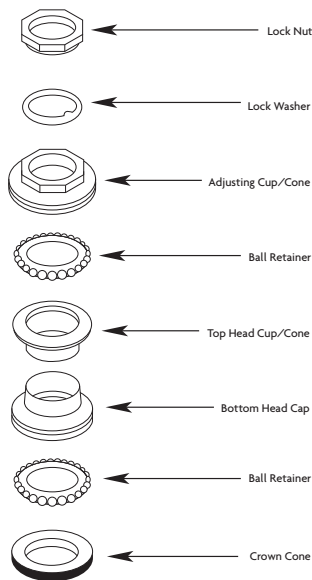

Lubrication and Attachment of An 'A-head Set' Stem To The Fork

Every year your bicycle should have a complete lubrication. This can be quite a complex task and may be best handled by a professional bicycle mechanic. However, if you feel capable the following procedure will guide you.

1. Suspend the bicycle so that the front wheel is off the ground.
2. Take the handlebar assembly from the steering tube.
3. Loosen and remove the compression bolt, the top cap assembly and then the stem clamp bolts.
4. Remove the headset wedge whilst supporting the forks with one hand, then remove the dust cover upper ball retainer.
5. Pull the forks out of the frame and remove the lower ball retainer.
6. Thoroughly clean and check each part of the headset for damage.
Replace if necessary. (See your dealer to replace the headset).
7. Grease both the head set cups. To work grease into the lower head cup re-fit a ball retainer into it. Re-attach the forks.
8. Install a bearing retainer into the bearing race and pack it with grease. Push the screw cup down onto the fork steerer and into position then re-fit the bearing dust cover/ bearing race / headset wedge and spacer.
9. Alter the upper cup by hand until no movement can be detected in the forks.
10. Firmly tighten the stem clamp bolts, then replace and secure the handlebar assembly.

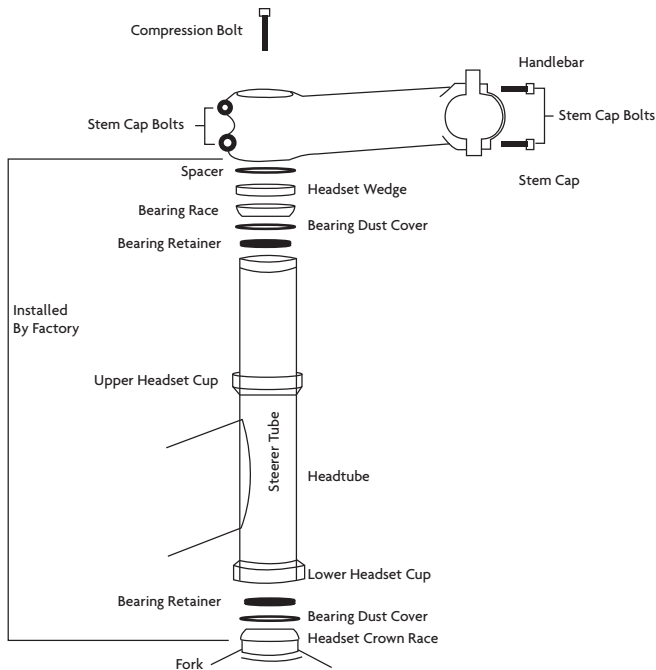



HEAD SET AND ROTOR ASSEMBLY DIAGRAM

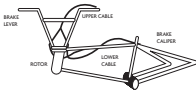
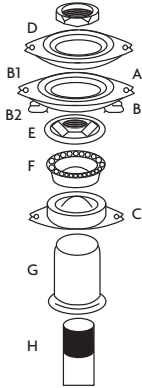

COMPLETE ASSEMBLY

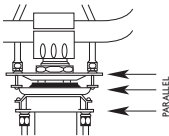

ROTOR CABLE ASSEMBLY

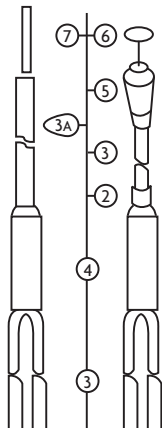

Rotor Headset

A rotor is a special headset mechanism used on some BMX Freestyle bikes. It enables the handlebars to be turned 360 degrees without tangling the brake cables. In this system the front brake cable is connected to the right control lever via the hollow headstem and the fork. The rear brake cable is split at the rotor bearing mechanism, activating the rear brake by transferring the left control lever pressure.

Rotor Installation and Adjustment

Installing and adjusting a rotor headset can be quite a complex task and one you may refer to your professional bicycle mechanic. However, if you feel capable the process for rotor installation and adjustment is listed below.

- Remove fork (H) and upper headset cup (F) from your bicycle.
- Place lower cable stop (C) on the top of the head tube (G). Replace and fasten the upper headset cup to the head tube via the lower cable stop.
- Install headset unit onto the fork neck, except the lock washer and lock nut.
- Place rotor bearing unit (B) over the head set ensuring the larger side is facing up.
- Install upper cable lock (A) onto the fork neck. (The original lock washer is now redundant.)
- Place lock nut (D) onto fork neck and alter the head set as usual.
- Connect the upper cable to the left brake lever. (Discard cable ferrule provided on the upper cable if your lever is already equipped with a cable adjuster.) Hook the two cable ends (1) to the top hooks (B1) of the rotor bearing unit. Screw the adjusting barrels into the upper cable stop.
- Pull rotor bearing unit downward to pick up the slack of cables. Adjust the height of bearing unit through the cable adjuster on the brake lever or cable splitter until the bottom hooks (B2) of the rotor bearing unit are approximately 1/8" – 1/4" away from the lower cable stop.
- Run the lower cable under the frame tube with the split cables on each side of the frame. Hook the two cable ends (1) to the bottom hooks (B2) of the bearing unit. Screw the adjusting barrels into the lower cable stop.
- Measure and cut the single measure housing (3A) to the correct length (Caution: This is the only cable that can be cut to adjust for different frame lengths.) Connect the cable to the rear brake calliper in the usual manner.

Cable Tension Adjustment

1. The rotor bearing unit should appear parallel to the upper and lower cable stops once installed. If the unit is tilted, pull each cable end one at a time, to see which one has slack on the bearing hook. Pick up the slack through the adjusting barrel. When even pull on all four cables is reached secure all four lock nuts.
2. Check for even pull on all four cables by rotating the handlebar while the front wheel is off the ground. If a fluttering noise is heard in the rotor bearing unit as the upper and lower cables pass each other, repeat the adjusting step 1.



SADDLE AND SEAT POST

Inspection

Part of your monthly maintenance tasks needs to include inspection and adjustment of the seat post binder bolt and the seat fixing bolt, ensuring both are firmly secured. When the seat post is removed from the frame, a mark about 65mm up from the bottom can be observed, with the words “max. height” or “minimum insertion”. At all times a minimum of 65mm of seat tube must always remain in the frame.



Never ride a bicycle with the minimum insertion/max. height mark visible on the seat post. Doing so may damage the seat post, the frame or potentially even the rider.

Lubrication

Remove the seat post from the frame and clean thoroughly. Lightly grease the part that will be inserted into the frame. Replace the seat post into the frame and adjust and fasten.

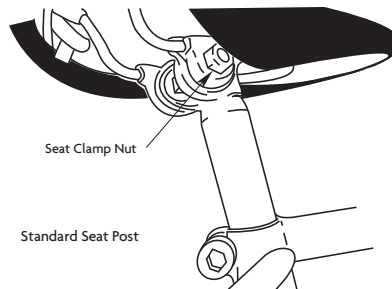
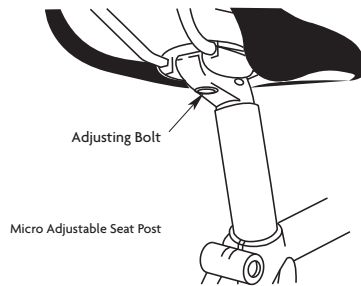



Adjustment

As covered previously in Part 3, to accommodate the individual rider the seat can be adjusted in angle, height and distance from the handlebars. Generally, the saddle is most comfortable when the top of the seat is angled almost parallel to the ground, or the front is slightly raised. The most comfortable reach to the handlebars can be identified by sliding the saddle forward or back along the mounting rails until the rider's preferred distance is located. Once identified, the saddle clamping mechanism needs to be tightened as firmly as possible.

When attaching the seat post to the seat, position the seat post into the clamp under the saddle. Place it in the frame without tightening, and adjust until the desired angle and position on the post are found. Fasten the clamping mechanism. Adjust the height to the required level and tighten the binder bolt. Note: The seat post must not extend beyond the minimum insertion/ max. height mark.

Bicycles are most commonly fitted with two types of seat clamps. The majority use a steel clamp with hexagonal nuts on either side to tightened. The second type, a micro-adjustable clamp, uses a single, vertically mounted Allen head fixing bolt which is tighten. A quick release mechanism may also be used. The operation of a Quick Release seat post mechanism is the same as for Quick Release hubs (Refer to Page 31).

To test the tension of the binder bolt, hold the seat and try to force it sideways. If the saddle moves you need to further tighten the binder bolt.



WARNING:

After making any changes to the seat's position check that the saddle adjustment mechanism is properly tightened. It is also recommended this be done prior to every ride. A loose saddle clamp or seat post binder can allow the saddle to move, which may damage the seat post, or cause you to lose control when riding and fall. Seek assistance from your dealer to ensure you know how to clamp your seat post correctly, whatever type of mechanism is fitted to your bicycle.

CAUTION:

If your bicycle is fitted with a suspension type seat post check that this is intact and functioning properly.

BRAKES



For safe riding it is crucial that your bicycle's brakes function correctly. With use the bicycle's brake pads wear and the control cables stretch. Consequently, prior to every ride the brakes should be inspected and adjusted as necessary to ensure proper operation.



WARNING: A bicycle should never be ridden unless the brakes are working correctly. Take care when using the front brake. Applying it abruptly or excessively may throw the rider over the handlebars, potentially causing serious injury or death.

Hand Controlled Brakes

There are five main types of hand controlled brakes used on bicycles - the sidepull, the "V" brake, the "Linear Pull" brake, "U" type calliper brakes, and disc brakes. All are operated by the rider squeezing the control lever attached to the handlebar, which activates the brake. Differences occur between the four hand operated brakes by how they are mounted to the bicycle. "V", "Linear Pull", and "U" type brakes use two brake pivot arms, each mounted on separate pivots on either side of the frame or fork. Sidepull calliper brakes are attached to the frame or fork by a single pivot point. Disc brake callipers are attached to the frame and fork via disc brake mounts.



Linear



Side Pull Brake



Disc Style Brake System

Foot Controlled Brakes.

The coaster brake is a pedal activated brake fitted to most juvenile bikes and some BMX bikes with out gear mechanisms. The brake is activated by pushing backwards on the pedal. This activates a brake in the rear hub and allows the rider to slow or stop.

Inspection

The brake levers and the brake pads are the two main components that need to be checked to ensure your brakes are functioning effectively. Positioning of the brake levers should be checked to ensure they can be easily reached by the rider's hands and alterations made as necessary. Some brake levers have a screw adjuster to change the distance between the lever and the handlebar grip. This should be checked for tightness every three months. Similarly, at least every three months the brake levers should be tested to ensure they do not move on the handlebars and each brake lever moves freely when compressed.

Prior to every ride inspection of the brake pads is recommended. The brake pads must be centred, with approximately 1.5mm – 2mm clearance between each pad and the rim when the brakes are not in use. Test that when the brakes are applied that the brake pads squeeze the rims sufficiently to stop the bike. Replace the brake pads if the grooves or pattern has worn away from the surface. Ensure that the brake pads are firmly secured before every ride and at least every three months check the tightness of the numerous bolts and nuts supporting the brake pads.



If your bicycle is fitted with a Quick Release wheel mechanism, ensure that this is securely closed after any brake adjustment. Never ride a bicycle unless the mechanism is firmly locked in the closed position.

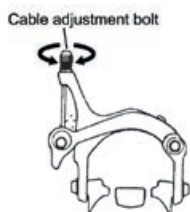
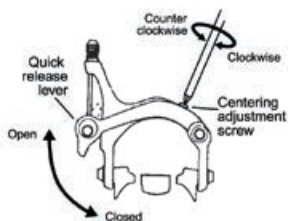

Lubrication (calliper brakes)

Lubricate the brake lever and the brake calliper pivot at least every three months with 2-3 drops of light oil. This will help to limit wear and tear and ensure smooth operation. At least every six months remove cables from their casings and grease along their entire length. Prior to fitting any new cable, always apply grease.

Adjustment – Sidepull Callipers

To make minor brake adjustments use the barrel cable adjuster, usually found at the upper cable arm. Use the following outline as a guide.

1. Squeeze the brake pads against the rim and loosen the lock nut.
2. Set the adjuster so there is approximately 1.5mm - 2mm clearance between the brake pad and the rim.
3. Re-fasten the lock nut.

If the clearance between the brake pad and the rim cannot be set to 2mm or less using the above process, the cable length may need to be altered. To do this:

1. Screw the barrel adjuster in completely.
2. Press the pads against the rim.
3. Un-fasten the cable anchor bolt and use pliers to pull the cable through.
4. Re-fasten the cable anchor bolt.
5. Test the brake lever by applying full force, and use the barrel adjuster to make any necessary minor alterations.

Note: A screwdriver can be used on some brakes to set the clearance on both sides of the rim.

Note: The leading edge of the brake pads should make first contact with the rim when adjustment is complete. Special curved washers are fitted to some brakes to allow this, but on base models a little force needs to be applied to the pad and its mounting.

Installation and Adjustment – Linear Pull Brakes

1. When assembling linear pull brakes, insert the brake body into the centre spring hole in the frame mounting boss, and use the link fixing bolt to fasten the brake body to the frame.

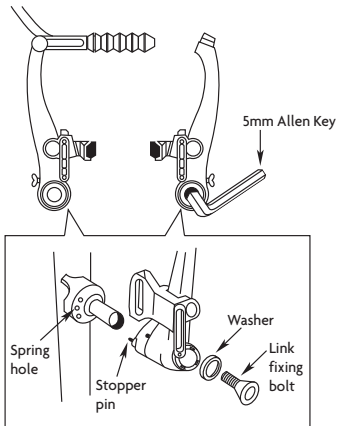

2. Hold the shoe against the rim and swap the position of the 6mm and 3mm B washer so that A is maintained at 39mm or more. (Refer to the following diagram for clarification.)

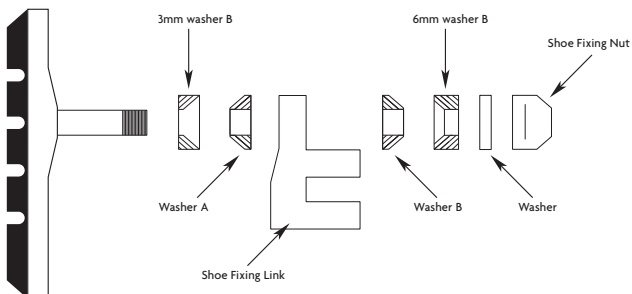
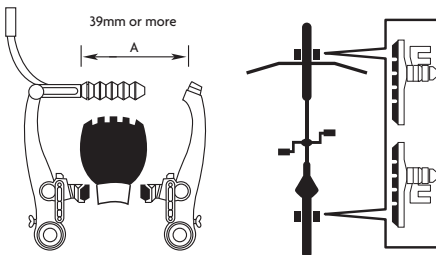



3. Fasten the shoe fixing nut while holding the shoe against the rim.

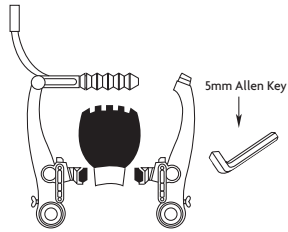

4. Thread the inner cable through the inner cable lead. When a clearance of 1mm between each brake pad and the rim is achieved, secure the cable fixing bolt.

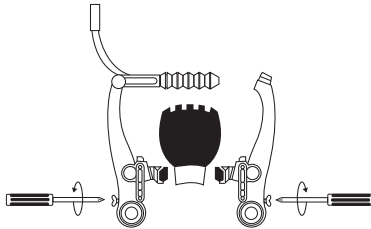

5. Alter the spring tension adjustment screws to correct the balance.

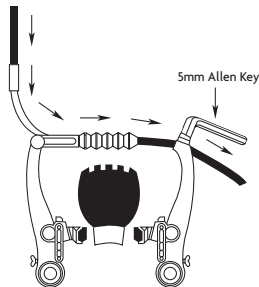

6. Check the brake operation and shoe clearance by fully squeezing the brake lever repeatedly, (about 10 times). Loosen and then re-fasten the cable fixing bolt as per Step 4 until adjustment is correct. Make any fine alterations via the adjusting screw at the brake lever.

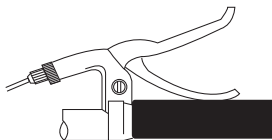

Installation and Adjustment– U-Brakes

To install U-Brakes:

1. Lubricate the contacting surfaces of the frame bosses and the brake arm attaching area.
2. Secure the spring to the hole on the brake arm, spring cover and fixing arm nut.
3. Fasten the attaching bolt with a 5mm Allen key wrench to a torque of 6 Nm to 8 Nm.

Note: The spring winds in different directions for the right and left arms. (See Fig.1)

When adjusting brake shoes, the brake arm needs to be able to move freely.

To adjust and secure brake shoes:

1. Attach the brake shoe so the direction of the arrow sign is the same as the rim rotation direction.
2. Face the shoe surface to the rim, and set it as shown in Fig 2.
3. Use a 5mm Allen key wrench to hold the brake in position and secure the nut with a 10mm wrench to a torque of 7 Nm to 9 Nm. (See Fig.3)

To connect the braking cables refer to the following steps and Fig.1.

1. Attach the braking cable to the straddle cable bridge.
2. Set the straddle cable as in Fig.1, and alter the shoe-rim until a clearance of 1.5mm on both sides is achieved.
3. Fasten the straddle cable with the cable fixing nut to a tightening torque of 5 Nm to 7 Nm
4. Trim the excess straddle cable and connect the cable cap.

Refer to Fig. 1 to help you fine tune the shoe clearance. You will need a 13mm wrench to make the adjustments.

1. If a in Fig.1 is greater than b, (the left side), turn the arm fixing nut anti-clockwise (in the A direction).
2. If b is greater than a (the right side), turn the arm fixing nut clockwise (in the B direction).

To make fine adjustments of the spring tension refer to Fig. 1 and use a 13mm wrench to:

1. Tighten the spring tension, turn the arm fixing nut to A and A' as in Fig.1.
2. Loosen the spring tension, turn to B and B'.

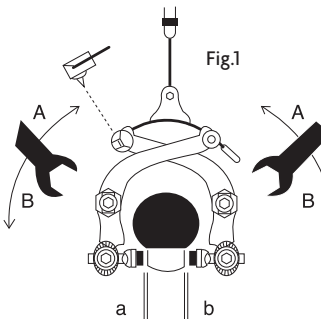

Fig.2

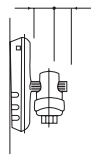
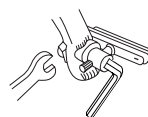
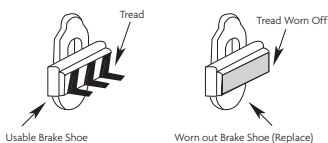

Fig.3





Brake shoes must have adequate usable tread



Brake Shoe Replacement

Check your brakes shoes monthly for any indication of wear. If the pads are worn past the “wear line” indication (See diagram), the brake shoes need to be replaced. Always replace the brake shoes in pairs – never one side only.

For replacement, disconnect the holding mechanism specific to your brake type - i.e. a hexagonal nut or an Allen screw arrangement, or a combination of both. Remove the worn brake shoes paying careful attention to the order and position in which the various curved washers and spacers are attached. Fit the new brake shoes, and tune the angle and the clearance to the rim as required. Typically, before the rim clearance can be adjusted the control cable anchor bolt needs to be loosened and then the cable adjusters fastened and the cable tensioned. (Refer to the Installation/Adjustment section relevant to your brake type for detailed instructions.) Once the adjustments are complete, securely fasten the brake shoes in place and test that the brakes are functioning correctly. Do not ride the bicycle until the brakes are working effectively.

Disc Brake Adjustment (Mechanical)



Disc Style Brake System

1. Ensure the fixing bolts are securely fastened to the disc brake mount.
2. Adjust the callipers' active lever as close to the rotor as possible.
3. Adjust the neutral side with the relevant adjuster.

If your disc brakes allow adjustment of the calliper toe-in, check:

1. The clearance is even from front to back.
2. The inner cable fixing bolt is securely tightened.

Please see brake manufacturers manual (if supplied) for detailed adjustment instructions.

Disc Brake Adjustment (Hydraulic)

Disassembly of hydraulic disc brakes systems can be a complex procedure and therefore, it is best undertaken by a professional bicycle mechanic. However, as hydraulic systems are usually self-adjusting, you should be able to manage any centring of the unit to the rotor that is required. Refer to the specific brand manual (if supplied) for more detailed instructions relating to further adjustments or fluid bleeding. Note: Check all rotor bolts at the time of assembly.

DRIVETRAIN

The drivetrain consists of the pedals, chain, chainwheel, crank set, and freewheel.

These are all the components of the bicycle that transmit power to the rear wheel.

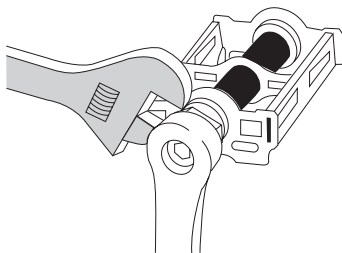

Pedals

There is a vast range of pedals available, designed for many different uses. Pedals fitted with toe clips and straps aim to make the pedalling process easier for the rider. The toe clips and straps ensure the cyclist's feet stay correctly positioned and cause a pulling force, as well as a downward pressure, to be generated on the pedals. To get the full benefit of these pedals it is recommended that the rider wear cycling shoes especially designed for use with toe clips. Consult your bicycle dealer for instruction on how toe clips and straps operate.



WARNING:

Pedals fitted with toe clips and straps require a certain level of skill to operate safely. Riders should repeatedly practice using such pedals in areas free from traffic, hazards or obstacles, until operation becomes a reflex action.

Failure to do so could result in the cyclist losing control of the bicycle and falling. It is also recommended that the straps be kept loose initially and gradually tightened as the rider's skill in using the pedals increases. However, toe straps should never be tight when riding in traffic.

Inspection

Every month the pedals should be inspected. Check that:

- Pedals are securely fastened into the cranks. Loose pedals are a potential hazard for both the rider and the integrity of the cranks.
- Pedal bearings are adjusted correctly. Alter, grease or replace if any roughness or looseness is detected in the pedal bearings when the pedals are moved up and down, laterally or rotated by hand.
- The front and rear pedal reflectors are clean and firmly attached.
- If toe clips are fitted, ensure that they are fastened tightly to the pedals.

Correct Pedal Attachment

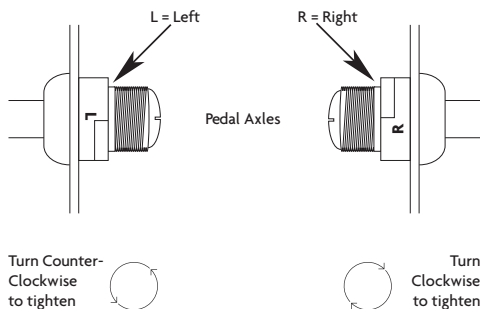



Clipless Pedals

Clipless pedals or “step-in-pedals” are designed for maximum pedalling efficiency. The rider wears specific cycling shoes with a plate on the sole which clicks into a spring-loaded fixture on the pedal. This maintains the cyclist’s foot in the most effective pedalling position.

The amount of force required to clip the foot in and out of the pedal can be adjusted on many clipless pedals. For further instruction on how to do this consult your dealer.



WARNING:

Clipless pedals should only be used with shoes specifically made to fit the make and model of the pedal being used.

WARNING:

Clipless pedals require a certain level of skill to operate safely. Riders should repeatedly practice using such pedals in areas free from traffic, hazards or obstacles, until operation becomes a reflex action. Failure to do so could result in the cyclist losing control of the bicycle and falling.

Lubrication and Adjustment

The maintenance your pedals need will depend upon whether or not they can be disassembled to enable access to the internal bearings and axle. If they cannot be disassembled, every six months a small amount of oil should be injected onto the inside bearings of pedals. Pedals that can be fully disassembled should have the bearings removed, cleaned and greased every six to twelve months. However, due to the complexity of this task it is recommended that it be completed by a professional bicycle mechanic.

Attachment

Each pair of pedals has a specific right and left pedal. It is important that a pedal is never forced into the incorrect crank arm as the thread is different for the two pedal sides. The right pedal, as indicated by the "R" stamped on the end of the axle, screws into the crank on the chainwheel side of the bicycle in a clockwise direction. The left pedal is marked with an "L" on the axle, and it is attached to the other side in an anti-clockwise direction.

To attach, place the pedals into the correct crank arm and wind on by hand as tightly as possible in the appropriate direction. Use a 15mm wrench to fasten more securely. Removing a pedal is the reverse process of attaching. The right pedals needs to be turned anti-clockwise and the left, clockwise.

Before fitting any new pedals ensure that the axle thread size is compatible with the cranks on your bicycle. The two types of cranks available each have different axle threads. Cranks that are a one piece design have no separate axle and are compatible with pedals that have a 1/2" thread. Three piece crank sets with a separate left and right crank use a slightly larger 9/16" thread.

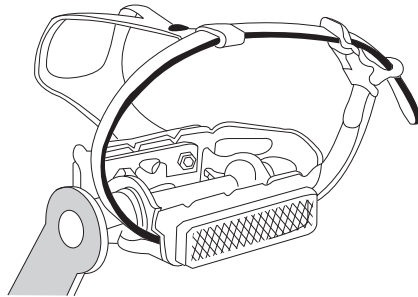

Pedal with toe clip and strap attached



WARNING:

Never attempt to force a pedal into a different sized bicycle crank.





Crank Set

Together the bottom bracket axle and bearings, the crank arms and the chainrings are known as the crank set. There are two types of crank sets - One Piece Cranks or Three Piece (Cotterless) Cranks. One Piece Cranks are relatively easy to maintain as the crank arms and the bottom bracket are a single component. In Three Piece Cranks the crank arms bolt onto the bottom bracket axle without using old fashioned type cotterpins.

This system requires more detailed servicing.

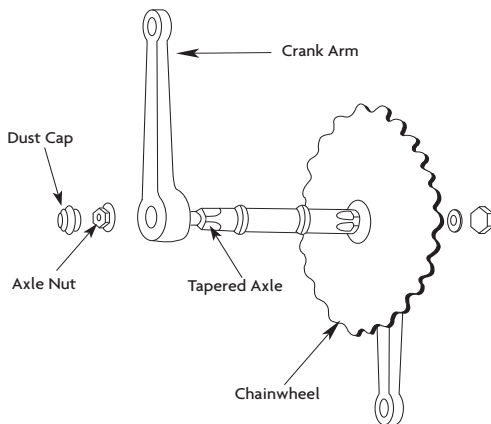

Inspection and Maintenance

Every month the crank set should be checked to ensure that it is properly adjusted.

For Three Piece Cranks:

- Check that the crank axle nuts are tight.
- Adjust the bottom bracket bearings as necessary.
- Remove the chain and test for crank movement on the axle by attempting to move the cranks from side to side with your hands. Only very slight movement in the bottom bracket should be noted.
- Rotate the cranks. Adjust and oil if they do not spin freely or a grinding noise is detected.
- Check the chainrings for any broken teeth, and clean off any excess dirt and grease.

Standard Bottom Bracket Assembly (Cotterless)

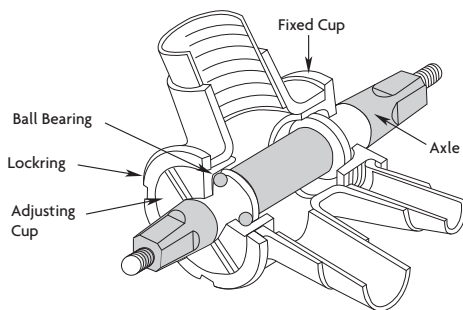

Caution:

Always ensure that your Three Piece cranks are firmly secured before riding. Riding with loose cranks is potentially hazardous to both the rider and condition of the crank arms.

Lubrication and Adjustment – One Piece Cranks

To adjust:

- Turn the locknut on the left side clockwise to loosen.
- Turn the adjusting cone anti-clockwise with a screwdriver until correctly secured.
- Turn the locknut in an anti-clockwise direction to re-fasten.

To disassemble:

1. Take the chain from the chainwheel.
2. Turn the spindle clockwise and remove the left pedal.
3. Turn the left side locknut clockwise and remove, as well as the keyed lock washer.
4. Use a screwdriver to turn the adjusting cone clockwise and remove.
5. Remove the left ball retainer, slide the crank assembly out of the frame to the right, and remove the right ball retainer.

Once the crank is dismantled, clean all bearing surfaces and the ball retainers, and check for wear. Replace any damaged parts and pack grease into the ball bearing retainers. Re-assemble the crank in the reverse order of the procedure listed above.

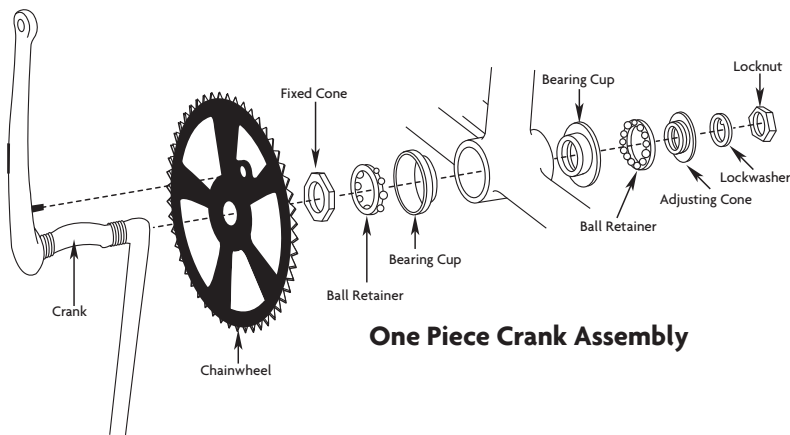



Lubrication and Adjustment – Three Piece Cranks (Cotterless Cranks)

To adjust:

- Turn the locking on the left side anti-clockwise.
- Turn the adjusting cup until appropriately set.
- Carefully re-fasten the locking without disturbing the cup adjustment.

To disassemble:

1. Remove the cranks from the axle.
2. Turn the left side locking anti-clockwise and remove.
3. Turn the adjusting cup anti-clockwise and remove.
4. Remove the left ball retainer and slide the axle out of the frame to the left.
5. Turn the right side fixed cup anti-clockwise and remove, as well as the right ball retainer.

Once the crank is dismantled clean all bearing surfaces and the ball retainers and check for wear.

Replace any damaged parts and pack grease into the ball bearing retainers.

Re-assemble the crank in the reverse order of the procedure listed above.

Three Piece Crank Removal

To remove Cotterless cranks you will need to use a specific removing tool. Follow the outline below to guide you through the process.

1. Use a coin or a screwdriver to remove the dust cap.
2. Remove the flange nut or bolt and washer after loosening.
3. Attach the removing tool into the crank and tighten.
4. Turn the screw bolt until the crank comes away from the axle.

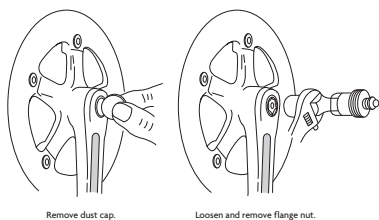
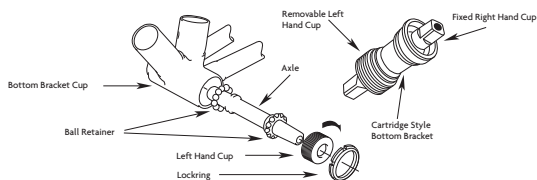
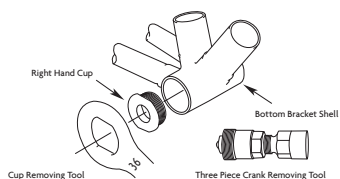

Three Piece Crank Replacement

1. Place the crank arm onto the axle.
2. Use a soft mallet to gently tap the crank arm.
3. Reattach the washer and secure the flange nut or bolt securely to a torque of 27Nm.
4. Replace the dust cover.



After fitting new three piece cranks some additional maintenance is required as components can become loose with use. The following adjustments should be made after several hours of riding, and repeated two or three times after further use. There after the cranks should remain secure.

1. Remove the dust cap.
2. Gently tap the crank arm with a mallet.
3. Re-tighten the flange nuts, and refit the dust caps.

Lubrication and Replacement - Cartridge Bottom Bracket

Freeplay cannot be removed from a cartridge bottom bracket. It is a sealed unit and is designed to be replaced as an entire unit when it is worn out. Once the cranks have been removed a specific extraction tool is required to remove the cartridge bottom bracket. Consult your specialist bicycle dealer for further advice regarding this process.

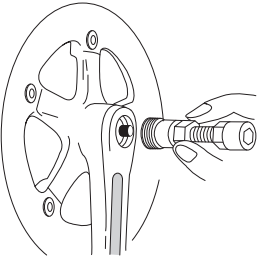

Screw in the removal tool.

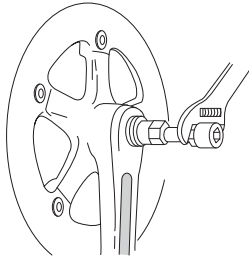

Turn the screwbolt clockwise.

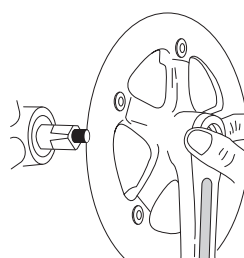

Position the crank on the axle.

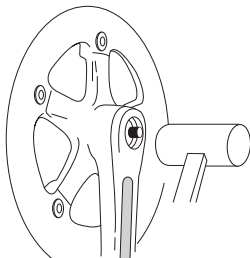

Lightly tap the crank onto the axle.

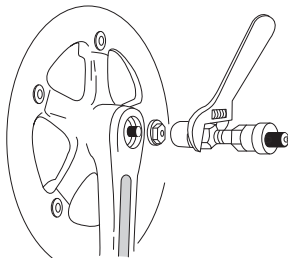

Tighten the flange nut.

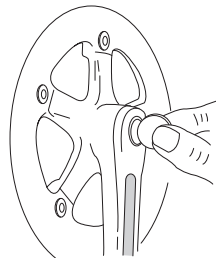

Replace the dust cap.





Chain

Inspection and Lubrication

Regular inspection and maintenance of your chain is vital to guard against premature wear. At least monthly, or after riding in wet, muddy or dusty conditions, the chain should be cleaned and lightly oiled. Any excess oil should be removed and care taken to ensure the lubricant does not come into contact with the tyres or rim braking surfaces. Check that all links of the chain move freely. Replace the chain if it appears stretched, broken or causes problems when changing gears.

Adjustment and Replacement

Note: Fitting or adjusting a chain can be a complex task and one which you may wish to refer to your specialist bicycle mechanic.

To adjust the chain on single speed freewheel, coaster hub brake or 3-speed hub geared bicycles:

1. Loosen the rear axle nuts (and coaster brake arm clip if fitted).
2. Move the wheel in the frame until the chain has approximately 10mm of vertical movement when checked in the centre between the chainwheel and the rear sprocket. (Moving the wheel forward loosens the chain and backward movement will make it tighter.)
3. Centre the wheel in the frame and re-tighten the axle nuts.

To remove a chain from one of these bicycles:

- Prise off a U-shape plate on the master link with a screwdriver.
- Disconnect the chain using a special joining link.

To replace a chain on a single speed freewheel bike, coaster hub brake or 3-speed hub bicycle:

- Thread the chain around the chainwheel and rear sprocket.
- Fit the master link into the rollers at each end of the chain.
- Position the master link side plate, and slip on the U-shaped snap-on plate.
- Ensure the open end of the U-shaped plate is trailing as the link approaches the chainwheel when pedalling forward.

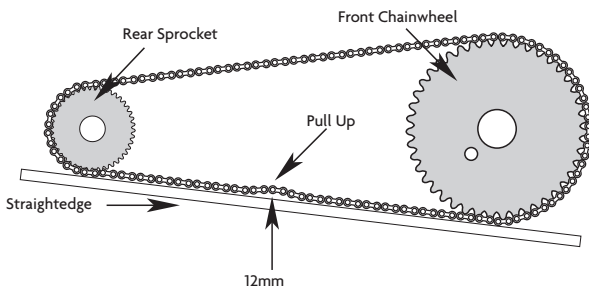

Unlike the single speed freewheel bike, coaster hub brake or 3-speed hub bicycle the chains on derailleur geared bicycles are automatically tensioned by the rear derailleur. Consequently, manual adjustment of the chain is not necessary on derailleur geared bicycles. The process for removing and replacing chains or altering the length of the chain on a derailleur geared bicycle, also differs from that used on the other bike types. The chains on derailleur geared bicycles are narrower, meaning a special tool is needed to complete any of the procedures.



To remove a chain on a derailleur geared bicycle:

- Fit the rivet tool so that the punch pin is centred over any one of the chain rivets.
- Push the rivet almost all the way out, then back out the punch and remove the tool.
- Holding the chain on both sides of the punched rivet, bend it slightly to release the link from the rivet.

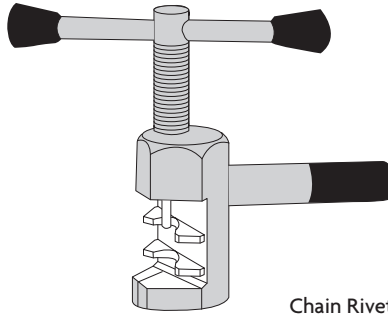

Chain Rivet Tool

To install a chain on a derailleur geared bicycle:

- Thread the chain around the chainwheel, rear sprocket and derailleur cage with the rivet facing away from the bicycle.
- Bring the two ends together within the special tool and punch the rivet into place. Take care not to push rivet too far through the side plate. Derailleur geared bicycles can now be fitted with some new types of chains that do not require special tools to remove or replace. Instead, a new, special, disposable connecting link is used every time you disassemble the chain. For further details on these particular chains, including installation guidelines, refer to the manufacturer's specific instructions.

Freewheel

Inspection and Lubrication

To prevent premature wear, the freewheel must be kept clean and well lubricated. Any accumulated dirt should be brushed from the freewheel and the component cleaned with kerosene or degreaser. Lubricate the freewheel whenever the chain is oiled. Any excess oil should be removed.

To ensure the freewheel is operating appropriately, remove the chain from the freewheel and spin it with your hand. If a grinding noise is audible or if the freewheel suddenly stops after spinning it, adjustment or replacement may be required. Such tasks are best referred to your professional bicycle mechanic, as they are quite complex and require special tools.

Note: Generally, whenever the chain needs to be replaced the freewheel should also be changed.



Coaster Hub

Coaster Hub Brakes are commonly fitted in the rear wheel of many BMX style and other children's bicycles. They are very reliable and easy to operate; the rider simply applies backward pedal pressure to activate. The rider can then "coast" without pedalling if desired.

Coaster hub brakes come in several different models. Regardless of which style is fitted to your bicycle, only minimal maintenance is required by the rider. The coaster hub sprocket should be kept clean and lubricated whenever the chain is oiled.

Any adjustments or replacements are best handled by a professional bicycle mechanic since the coaster hub's internal mechanisms are very complex.

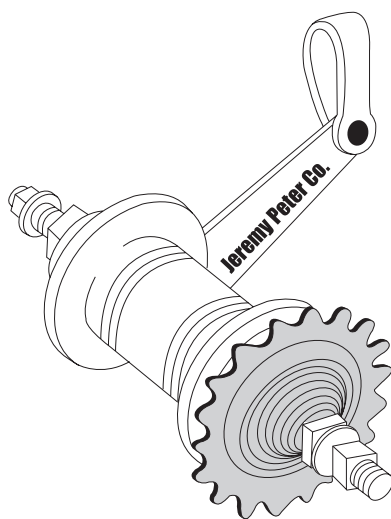

Derailleur Systems

The front and rear derailleurs, the shift controls, and the derailleur control cables collectively are known as the derailleur system. For smooth gear changes all the components of the derailleur system must operate properly. Several different types

of derailleur systems are available; the “friction” type system, the “index” system (e.g. SIS) and the fully integrated system (e.g. STI). The basic operating principles are the same for all of the different systems. With a standard “friction” derailleur system, the rider should feel each gear shift into position. With an “index” system changing gears is very easy and precise; each different gear position is linked to a positive click mechanism in the shifter. The shifting levers may be positioned above or below the handlebar, or in both locations (dual levers), or the shifting mechanism may even be incorporated into the hand-grip.

The fully integrated system is an upgrade of the index derailleur system. Braking and changing gears can occur simultaneously as the shift lever and brake lever mechanisms form an integrated unit with the derailleur system. For further information relating to your derailleur system refer to the separate, specific manual supplied with your bicycle, otherwise consult your professional bicycle mechanic.

Inspection

Review the overall functioning of the derailleur system at least monthly. Begin by testing the rear derailleur. Check that it moves the chain easily and speedily from one cog to the next, with no rubbing after shifting. Ensure the chain does not fall from the inner or outer freewheel cogs when the rear derailleur is activated. In the case of bicycles fitted with SIS derailleur systems, each notched position in the shifter must equate to a new gear position. Check that the front derailleur shifts the chain smoothly and without hesitation between each chainring. Ensure that the chain does not rub on the front derailleur when it moves onto a new chainring, and that it never falls off the chainring. In SIS derailleur systems, each click or stop in the shifter should equate exactly to a new gear position when the front SIS is activated.

It is also important to check the derailleur control cables for any signs of rust, fraying, kinks, broken strands, and any damage to the cable housing. Replace as necessary to ensure accurate shifting performance.





Lubrication

Lightly oil all the pivoting points of the front and rear derailleurs at least every month. Any excess oil should be wiped off to prevent dirt entering into the mechanisms. Clean and apply a thin layer of grease to the shifting cables every six months, or whenever new cables are fitted.

Adjustment – Rear Derailleur

If your bicycle is fitted with a SIS derailleur system, fine turning of the SIS mechanism will be the most common rear derailleur adjustment you will need to make.

To fine tune the SIS rear derailleur:

- Raise the back wheel of your bicycle off the ground (to enable you to rotate the pedals forward) and set the shift lever on SIS mode.
- Change the gears from top to second top gear and observe the chain's response. If the chain will not move to second gear, turn the cable adjusting barrel anti-clockwise to increase the cable tension. Turn the adjuster clockwise to decrease the tension if the chain moves past the second gear.
- Spin the pedals and with the chain still in second gear, turn the adjuster anti-clockwise until just before the chain makes noise against the third gear. This adjustment increases the tension of the inner cable.

If after completing the above process further adjustment is still required, stand behind the bike. Shift the chain to the smallest rear cog and the largest front chainwheel, and loosen the cable fixing bolt.

Also, check whether your SIS derailleur system is fitted with an additional adjustment screw to set the guide pulley as close as possible to the sprocket. If so, shift the chain onto the small cog and adjust until there is no sound of rubbing or fouling when the pedals are turned backwards.

Whatever type of derailleur system is fitted to your bicycle, the alignment of the chain, the rear sprockets, and the derailleur pulleys need to be inspected whilst standing behind the bicycle. Based on your findings, adjustments to high or low gear may be necessary.

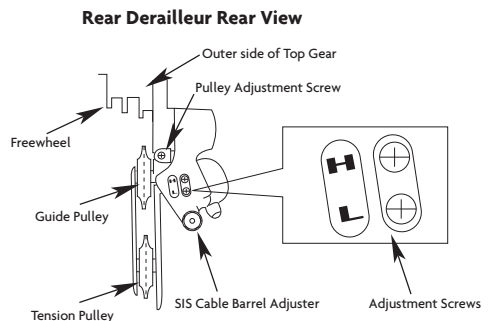
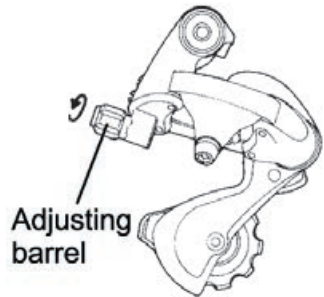

To adjust high gear:

- Turn the adjustment screw marked 'H' until the top guide pulley lines up with the outside edge of the outermost sprocket. Setting the guide pulley beyond the outside edge of the sprocket will cause the chain to come off when pedalling. Setting the guide pulley too far toward the larger cogs may prevent the chain wheel shifting onto the small sprocket.
- Re-tighten the cable fixing bolt when adjustment is complete.
- Position the right shifter all the way to the low position (fully forward for downtube shifters, fully back on MTB top bar shifters).
- Ensure that the derailleur cable is taut. If too much slack is detected, loosen the cable fixing bolt, pull the cable taut, and re-tighten the bolt.

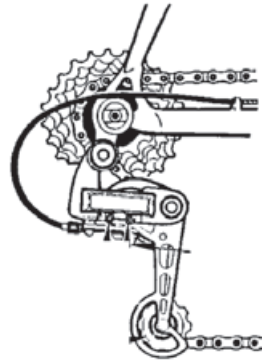

To adjust low gear:

- Turn the adjustment screw marked 'L' anti-clockwise until you can shift the chain onto the largest rear sprocket and the smallest chainring.
- Move the shifter until the derailleur guide pulley and the sprocket are aligned.
- Rotate the 'L' adjustment screw until it meets resistance. The derailleur will move outward and throw the chain off the sprocket when pedalling if the screw is turned in too far. Conversely, if the adjustment stops the derailleur moving far enough, the chain may not engage in low gear.
- Test the adjustment by rapidly shifting the chain up and down the freewheel.

Note: On bicycles equipped with indexed derailleur systems (SIS) the chain should pause when moving into each position. If the chain does not move easily onto the large sprocket while on the small chainring, screw out the 'L' adjusting screw slightly.

If the small sprocket is difficult to engage with the chain on the large chainwheel, screw out the 'H' adjusting screw slightly.

If the chain does not easily shift to the large freewheel cog or the large chainwheel, re-adjust the cable either with the barrel adjuster or by repeating the above procedures.





Adjustment – Front Derailleur

The front derailleur is positioned correctly when its chain guides are parallel to the chainrings and there is approximately 2mm-4mm of clearance between the outer chain guide and the large chainring. To achieve this ideal derailleur positioning, loosen the clamp bolt and make the necessary adjustments. To adjust the clamp position lower for top mounted cable systems, disconnect the derailleur cable.

To adjust low gear on front derailleurs:

- Shift the chain onto the smallest front chainring and the largest rear sprocket.
- Loosen off the control cable fixing bolt.
- Turn the adjusting screw marked 'L' until the inner cage clears the chain.
- With the shift lever fully in the low position, pull the control cable taut.
- Re-tighten the cable fixing bolt.

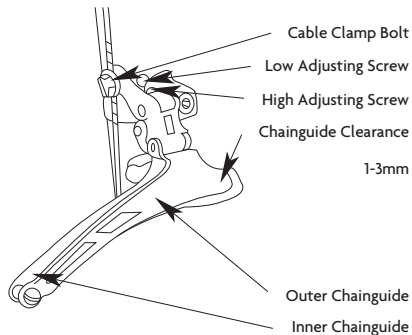

To adjust high gear on front derailleurs:

- Shift the gears until the chain moves to the smallest rear sprocket.
- Turn the adjusting screw marked 'H' until the chain moves to the largest chainring.
- Turn the 'H' adjusting screw further until the inside of the out cage of the derailleur just clears the chain.

For triple systems, altering the cable tension adjuster on the shifter levers enables the positioning to be fine tuned to a lower or higher location. Increasing tension moves the derailleur to a higher position and lessening the tension moves it to a lower position.

After making any adjustments it is important to test the gears in all possible front and rear chain positions. If the chain rubs against the cage when on the inner or outer chainring, in any rear sprocket position then turn the appropriate adjusting screw anti-clockwise. If the chain falls off either the inner or outer chainring, turn the appropriate adjusting screw clockwise. If the chain will not shift onto either the inner or outer chainring, turn the appropriate adjusting screw anti-clockwise.

To fine tune the front derailleur on MTB bicycles fitted with front SIS:

- Shift the chain to the largest rear sprocket and the largest front chainring.
- Shift from the largest to the middle chainring.
- Turn the cable adjusting barrel (located in the shifter), so that the inner chainguide just clears the chain.
- Test that the chain shifts cleanly, without hesitation between each chainring.

To fine tune racing style bicycles fitted with dual control (STI) levers:

- Shift the chain to the largest rear sprocket and the largest chainring.
- Push the left hand inner lever slightly to engage the noise prevention mechanism.
- Turn the cable adjuster mounted on the downtube until the inner chainguide just clears the chain.

If difficulties occur when shifting the chain to the small chainring, loosen the cable fixing bolt and re-tension the cable.

REFLECTORS

The reflectors fitted to your bicycle are not only an important safety feature, but a legal necessity as well. Your bicycle should come equipped with one white (front), one red (rear), and two orange (wheel) reflectors. Each pedal should also have two orange reflectors fitted.

As a part of your bicycle maintenance ensure that all reflectors are clean, intact and securely fastened. The front and rear reflectors should be vertically aligned, and the wheel reflectors should be secured opposite the valve within 75mm of the rim.

When riding at night, in addition to the reflectors, the bicycle should also be equipped with powered lights. Reflective tape on the rider's clothing is also recommended to increase visibility.

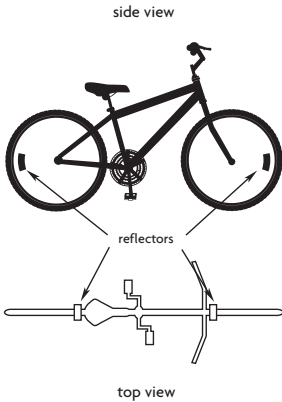

WARNING:

The reflectors and the reflector mounting brackets must not be removed from your bicycle. Doing so may reduce your visibility to other road users, potentially jeopardising your safety. Serious injury or death may result if you are hit by another vehicle unable to see you.

WARNING:

Reflectors should always be used in conjunction with powered lighting when riding at night, at dawn, dusk, or at any other time in poor visibility. Failure to do so is dangerous and may result in serious injury or death.





ACCESSORIES

To make your riding safer, more convenient or even more enjoyable, you may wish to equip your bike with some of the many bicycle accessories available. Before fitting any accessory however, it is important to check that is suitable for your bicycle. Also, ensure that the accessory is appropriately attached and will not interfere with your handling of the bicycle prior to riding.

Listed below is a sample of the many kinds of bicycle accessories available.

1. Pump

A pump is crucial if you are to maintain the appropriate tyre pressure. Check that the end connection is compatible with the valves on your bicycle's tubes.

2. Repair Kit, Tyre Levers & Spare Tube

It is recommended that you always carry these if you wish to avoid the inconvenience of being stranded with a puncture.

3. Lock

Do not risk leaving your bicycle unsecured. When your bicycle is unattended, always lock it to an immovable object to help minimise the risk of theft. Take care when choosing a lock, for the range available is considerable but not all are necessarily effective anti-theft devices.

4. Lights

For safety, it is recommended your bicycle should always be fitted with lights when riding at night or in other low light conditions. (These should be used in conjunction to your bicycle's fitted reflectors.) Although the range of lights available is extensive, all front lights must have a white beam and all rear lights a red beam. Rear lights may also have a flashing mode to increase their visibility to other road users. Lights may be powered by a dynamo generator or be battery operated. Battery powered lights can work even when the bicycle is not moving and are generally easily removable. Prior to riding always ensure that the batteries are properly charged or dynamo power cables are properly connected.

5. Safety Flag

To increase the rider's visibility in traffic, the bright, fluoro coloured flag is mounted to the rear axle.

6. Rear View Mirror

Just as when driving a car, the rear view mirror assists the rider in keeping abreast of traffic approaching from behind.



7. Child Safety Carrier

Children up to approximately 18kg in weight can legally be transported in a properly designed carry seat, attached to the rear of the bicycle. To comply with safety standards the child safety carrier needs to be securely attached, fitted with a restraining harness, support the child, and prevent access to the spokes of the turning rear wheel.

8. Rear Carrier

Transporting your goods is made easy and safe with the use of luggage carriers. They are available in many different styles and sizes to suit a variety of requirements.

Note: Only properly designed and fitted luggage carriers should be used on your bicycle.

9. Pannier Bags

Carry bags equipped with several weather resistant compartments that usually fit either side of a rear mounted carrier. Ideal for bicycle touring - i.e. enable you to carry extra gear and keep it dry.

10. Saddle Bags

As the name implies, they attach under the seat for discreet storage for all your essentials, such as tools, a spare tube or a puncture kit. Other small bags are also available to fit on the handlebars, or in the corner of the main frame.

11. Bar Ends

Fitted to the ends of Mountain Bicycle handlebars, bar ends increase the rider's hand positioning options, especially when climbing a hill.

12. Computer

A multi-function device enabling the rider to monitor their speed, distance travelled and time. Recommended for use when fitness training.

13. Mudguards

Help to minimise road dirt and water soiling your clothes and getting in eyes.

14. Water Bottles

Keeping well hydrated when riding is very important, especially in hot weather. Bicycle water bottles are available in various sizes and colours. They can be conveniently stored in frame mounted carry cages so that fluids are easily accessible.

15. Gloves

Wear gloves on long rides to prevent soreness and blisters on your hands or as means of protection in the event of a fall. They are available in a variety of colours and designs.



TROUBLESHOOTING

Problem	Possible Reason	Possible Solution
Slipping chain	Excessively worn or chipped chainring or freewheel sprocket teeth	Replace chainring/sprockets/chain
	Chain worn/stretched	Replace chain
	Stiff link in chain	Oil or replace link
	Non compatible chain/chainring/freewheel	Consult a professional bicycle mechanic
Brake not working correctly	Brake blocks worn down	Replace brake blocks
	Brake blocks/rim greasy, wet or dirty	Clean blocks and rim
	Brake cables are binding/stretched/damaged	Clean/adjust/replace cables
	Brake levers are binding	Alter brake levers
	Brakes out of adjustment	Centre brakes
Frequent punctures	Inner tube old or faulty	Replace inner tube
	Tyre tread/casing worn	Replace tyre
	Tyre incompatible to rim	Replace with correct tyre
	Tyre not checked after previous puncture	Remove any sharp objects from tyre
	Tyre pressure too low	Inflate tyre to correct pressure
	Spoke protruding into rim	File down spoke
When the brakes are applied they squeal/squeak	Brake blocks worn	Replace brake blocks
	Brake blocks/rim greasy, wet or dirty	Clean blocks and rim
	Brake block toe-in incorrect	Correct block toe-in
	Brake arms loose	Secure mounting bolts
Wobbling wheel	Axle broken	Replace axle
	Wheel out of true	True wheel
	Hub cones loose	Tighten hub bearings
	Headset bindings	Alter headset
	Hub bearings collapsed	Replace bearings
Knocking or shuddering when brakes applied	Bulge in the rim or rim out of true	True wheel or consult a bike mechanic
	Brake mounting bolts loose	Secure bolts
	Brakes out of adjustment	Centre brakes and/or adjust brake block toe-in
	Forks loose in head tube	Secure headset
Constant clicking noises when pedalling	Stiff chain link	Oil chain
	Loose pedal axle/bearings	Alter bearings/axle nut
	Loose bottom bracket/bearings	Alter bottom bracket
	Bent bottom bracket or pedal axle	Replace bottom bracket or pedals
	Loose crankset	Tighten crank bolts



Problem	Possible Reason	Possible Solution
Grinding noise when pedalling	Pedal bearings too tight	Adjust bearings
	Bottom bracket bearings too tight	Adjust bearings
	Chain fouling derailleurs	Adjust chain line
	Derailleur jockey wheels dirty/binding	Clean and oil jockey wheels
Chain jumping off chainwheel sprocket or chainring	Chainring out of true	Re-true if possible, or replace
	Chainring loose	Secure mounting bolts
	Chainring teeth bent or broken	Repair or replace chainring/set
	Rear to front derailleur side-to-side travel out of adjustment	Alter derailleur travel
Freewheel does not freewheel	Freewheel internal pawl pins are jammed	Lubricate. If problem persists, replace freewheel
Incorrect gear shifting	Derailleur cables sticking/stretched/damaged	Lubricate/tighten/replace cables
	Front or rear derailleur not adjusted properly	Alter derailleurs
	Indexed shifting not adjusted properly	Alter indexing
Steering not accurate	Wheels not aligned in frame	Align wheels correctly
	Headset loose or binding	Adjust/secure headset
	Front forks or frame bent	Consult bicycle mechanic for frame realignment
Knocking from rear end of suspension model	Broken suspension mount	repair/replace frame
	Worn suspension bushing	Replace worn components
Suspension dampers binding	Loss of internal fluid	Lubricate as necessary
	Internal rust	Disassemble damper and replace affected parts
	Damaged internal parts	Consult professional bicycle mechanic



FOLDING BIKE ASSEMBLY INSTRUCTIONS

PART 6 - FOLDING BICYCLE INSTRUCTIONS

1. Unfold / fold the bike's mainframe and lock

FOLDING THE FRAME



i. Pull the lever outward and upward



ii. Lift the handle

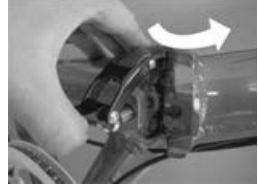

iii. Open the folding hinge.

UNFOLDING THE FRAME



i. Push back & close until the frame clicks into place.



ii. Push down on the handle to double lock for safety.



2. Unfold / fold the handlebar/stem and twist to lock



3. Adjust seat height and unfold pedals



BASIC OVERVIEW

PLEASE NOTE:

This manual is not intended as a detailed user, service, repair or maintenance manual. Please see your dealer for all service, repairs or maintenance.

IMPORTANT:

Please read all information in this manual carefully for maximum performance, safety, and enjoyment of your electric bicycle. In addition to being a full-featured bicycle, there is also an integrated on-board electric power assist unit.

Your new bike provides two types of power assistance:

Electric Pedal Assist provides motor assistance based on your pedaling activity and current speed. If you choose to operate the right hand throttle, then the electric pedal assist will deactivate and direct power (controlled by the throttle) will kick in.

PLEASE NOTE:

When using the direct power throttle mode, the range of the battery is greatly reduced compared to using purely pedal assist mode.

It is important that you understand the operation of each of these two functions. Failure to do so may cause damage to the motor, battery pack, charging unit or other major components. You should also read the standard bicycle parts operation of your new bike that comes with this owners manual, especially if you have not ridden a bicycle for some time.

While the components of this model may look similar to those of a normal bicycle, you need to recognise that many components operate differently from components in the past due to recent technological advances.

IMPORTANT:

Your electric bicycle is designed for on-road use only. Extreme off-road use, jumping or racing will put the user at risk of serious injury and death and warranty will not apply.

Taking a few minutes now to understand your electric bike's operating procedures which will help you get the most out of every journey that you make. Please be sure to read the 'battery charging' section before operating your bike's electrical functions. The electric bicycle's battery must be charged completely before the motor can be operated safely.

SHIMANO STEPS

PLEASE NOTE:

For Apollo Bicycles featuring the **Shimano Steps** system, please refer to the links below for the latest user manuals and information:

User Manuals: <http://si.shimano.com/> (Search by series **E6000**, then filter by "UM")

General Information: <https://shimano-steps.com>



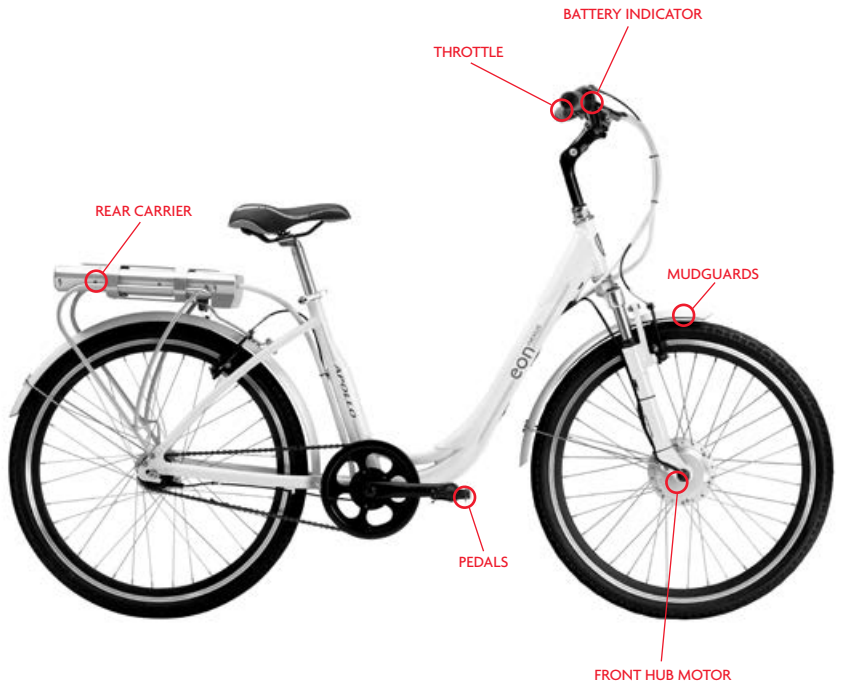

Each of the models in our range uses common components such as battery, brakes, throttle, controller, motor and derailleur or hub gears.

If you have purchased the bike in a packing condition that requires some minor assembly, we recommend you have the bike checked by a qualified local dealer before use.

Please note: The position of the motor may vary depending upon which Apollo model you have selected. You may either have a rear hub motor or front hub motor as pictured.

RANGE ON FULL CHARGE

Running distance on one charge will vary depending on the terrain, rider's weight, wind resistance, outdoor temperature, etc. The chart below reflects the approximate range based on normal road conditions and an average rider weight of 80Kg.



	Max Riding Range	Riding condition (with 80kg rider)		
		Road	Gear	Speed
Pedal Assist Mode	46 km	Flat	Top Gear (6th)	25 km/h
Direct Throttle Mode	25 km	Flat	Top Gear (6th)	25 km/h

CONDITIONS THAT AFFECT BATTERY RANGE

- Ambient temperature: Extreme cold and heat can deplete the battery's charge more quickly.
- Number of charges/discharges: The more charge/discharge cycles the battery has undergone, the less capacity it will have.
- Headwinds: Riding into a strong headwind will cause the motor to use more energy.
- Road conditions: Rough or hilly terrain will cause the motor to use more energy.
- Luggage: Carrying extra luggage on the carrier or in a backpack will cause the motor to use more energy.
- Rider weight: A heavier rider will cause the motor to use more energy than with a lighter rider.
- Acceleration from a standing stop: Since more energy is used during initial acceleration, riding in conditions that force you to start and stop often (i.e. city traffic) will cause the motor to use more energy.
- Proper gear usage: Pedaling in the correct gear for the terrain will help save energy for both you and the battery.
- Poor maintenance: A dry or dirty chain and under-inflated tyres will cause the motor to use more energy.

WHAT YOU CAN DO TO MAXIMISE RANGE

- Charge the battery under room temperature 0° - 40° C.
- Discharge the battery as much as possible before recharging.
- Use the gears appropriately while accelerating or riding uphill.
- Don't ride with under inflated tyres and keep the chain well oiled.
- Use slick or road tyres as supplied with your bike - off road tyres will increase drag and thus reduce the range.
- Pedal Assist: To maximise range, always try to use the pedal assist function as use of the direct power throttle will reduce the range considerably.
- Ambient temperatures between 10° - 30° C. will significantly enhance the range and performance of your battery.
- Get your bike serviced regularly (every 12 months) at a local approved dealer.



SAFETY

These safety precautions are provided for your benefit to protect you and those around you. Please read and follow them carefully to avoid unnecessary damage to the product or damage to other property.

BATTERY SAFETY

- Do not throw the battery into a fire. Do not overheat the battery.
- Do not connect the battery to other appliances other than your charger.
- Use only the specified charger to charge the battery.
- Do not take apart or modify the battery.
- Do not connect positive and negative terminal.

Electrolyte leakage, overheating and/or rupture may result after this type of abuse.

BATTERY CHARGER SAFETY

- Do not take apart or modify the charger.
- Do not subject the charger to shocks e.g. by dropping.
- Keep the charger away from water.
- Do not touch the charger with your skin for long periods during charging. Burning of the skin may result, as external temperature of the charger during charging may become 40° ~ 60° C.
- Do not cover the charger or place objects on it.
- Place the charger firmly on a flat dry surface.
- Do not short-circuit the terminals by using metallic objects.

WARNING:

- Keep the battery away from water. Pouring water on the battery may result in short-circuit, overheating or permanent damage of the battery.
- Do not submerge the battery. Soaking the battery in water may cause irreparable damage.
- Do not apply pressure to the cable or the plug.
- Be sure to insert the plug securely into a wall socket.
- Do not touch the plug with wet hands.
- Keep out of reach of children or pets.
- Do not attempt to use another make or model's charger to charge the battery.
- Do not use the charging plug and/or the power source plug when they are dirty, wet or dusty. Pull out the power source plug and clean it with a dry cloth.
- To remove a cable from a socket, pull the plug, not the cable.
- Do not rotate the pedals when charging the battery while it is mounted on the bicycle.
- Do not apply voltage over the rated value to the charger.
- Do not use damaged components such as charge case, power cord, plug etc.

OPERATION OF PEDAL ASSIST & DIRECT THROTTLE POWER

It is extremely important to the performance, enjoyment and safety of your electric bicycle and yourself to understand how the features of your electric bike operate. Even if you're an experienced cyclist, you should not take for granted that the way things have worked on previously owned bicycles will operate similarly on your new electric bicycle. Be sure to read and understand this section of the manual. If you have even the slightest doubt about how any of the mechanical features of the electric bicycle operate, talk to your authorized dealer.



INDICATOR

Power Button: Activates motor for pedal assist and direct throttle power. If power is not on, bicycle works as normal without electrical assistance.

Light: On/Off button for light/s. **This function is only available when a light is installed on the bike.**

Mode: Switches the mode of the direct throttle power for higher performance. **This function is only available for multi-mode electric bikes. Please check your product description for more information.**

The battery level indicator is located on the left side of the handlebar. To activate electric motor assistance, press the power button down (the battery level indicator will show a series of red bars) and then pedal, just like you would on a normal bike. When the battery is switched on, your bike provides electrical assistance whenever the rider operates the pedals. Remember that this mode provides the greatest range capability. When the bike provides pedal assist functionality, the motor power automatically shuts down at the speed of 25 km/h. The pedal assist function will only come into effect two seconds after pedaling begins. When the bike is switched on (via the battery) the throttle on the right hand side of the handlebar, automatically overrides the pedal assist system and provides direct progressive power when using the twist grip accelerator. When you switch the battery to the on position using the key switch, the red battery level indicators light up on the left hand side of the handlebar to indicate that the system is fully functioning and the battery level is indicated by the red LED lights. LED's on the battery level indicator will be lit while power is on and will shut down when the battery power is depleted.

LED STATUS ON INDICATOR

Battery Level Indicators



Twist Grip Throttle



The battery level indicators visually demonstrates the remaining battery life. The more LED lights illuminated the greater amount of battery life. If the LED lights continuously flash there is a malfunction. Reset the power. If the symptom persists even after resetting, take your bike back to an authorised dealer.



CAUTION:

If the LED battery level lamps do not light up during operation, check that the battery is charged and securely mounted.

- Power assist will not be available when indicator LED's are flashing. To reset, switch off battery for 30 seconds and then switch back on.
- If the LED lights flash while riding, it means that there is a possible malfunction. The lights will keep flashing for approx 10 minutes, and then the controller will shut off. Switch the battery to 'off' for 30 seconds and then back on to reboot the system. If the LED's keep flashing, take your bike to your authorized dealer to have it checked out as soon as possible.
- If your electric bicycle is stored with the battery in place, turn the power key switch to the "OFF" position. Leaving the power indicator in the "ON" position while stored or parked will result in rapid energy loss.

CAUTION:

When the battery is new or remains unused for a long period of time in very cold conditions the following failures may occur.

- Indicator does not light up at all even after full-charge - Re-charging is recommended again for at least 4 hours.
- Assistance power is not supplied, while the indicator is on - Re-charge the battery again.

KICKSTAND

Your new electric bike is equipped with a retractable kickstand for parking and storage while not in use. Always use the kickstand when parking or storing your electric bicycle. Do not lean it against anything (posts, fencing, wall etc.) or lay it on its side.

To park your bike, simply push down on the kickstand towards the ground until the support locks into position (fig. 1).



To ride your bike again, push the kickstand anti-clockwise and upward into its retracted position.

REAR LUGGAGE CARRIER

When a carrier is fitted - when you carry luggage on the carrier, make sure everything is securely fixed and free from the rear wheel, chain, etc. Total weight of luggage must not exceed 15 kg. The carrier is not equipped with rack straps or cords: ask your dealer for straps so luggage can be carried safely.

Never, ever carry a passenger. You may carry a child as long as he/she is placed in a proper child seat that is fitted securely to the bicycle.

MAINTENANCE



BATTERY TIPS:

Approximate life -

- If used in accordance with the guidelines in this manual, the Lithion Ion battery has a life span of more than 600 charging cycles.
- If the range per charge becomes too short, even after refreshing the battery, the battery's life may have come to an end . Replace the battery with a new one.

For extended storage -

- Charge the battery to full level.
- Operational temperature -20° ~ 30° C.
- Re-charge the battery every 3 months if left unused.

BATTERY RECYCLING PROGRAM

- At the end of useful life, Lithion Ion batteries are recyclable.
- In many countries, there are laws regulating proper disposal.
- When your battery needs to be replaced, please return it to an authorised dealer for recycling. Your dealer can also order a replacement battery for you.

WASHING

To keep your electric bicycle in peak working condition, keep it clean. If your frame or a component is dirty, clean it with a soft cloth soaked in a mild detergent mixture.

CAUTION:

Do not use high-pressure water or air hoses to clean your electric bike. This can force water into the electric components and may cause malfunction.

AVOID LEAVING YOUR BICYCLE OUTSIDE IN POOR WEATHER CONDITIONS

When not in use, keep your electric bike in a location where it will be protected from snow, rain, sun, ect. Snow and rain can cause your electric bicycle to corrode.

The ultraviolet radiation from the sun can fade the paint, or crack any rubber or plastic on the electric bicycle.

CAUTION:

The Lithion Ion battery must be fully charged before your first ride, or if the bike has not been ridden for over a month. Charge the battery in a room with an ambient temperature of between 0° ~ 40° C. If you notice smoke or a strange smell, stop the charging procedure immediately! Take your bike to your authorised dealer for immediate service or replacement. Do not recharge the battery for over 12 hours. This could seriously reduce the long-term life of the battery.



BATTERY CHARGING

CAUTION:

It is always best to charge the battery fully prior to full discharge.

Unlock the battery (top keyhole) from the frame in the OPEN position, with the finger of the same hand, tilt the top of the battery sideways until it clears the frame. Lift the battery up and out of its cradle

IMPORTANT:

The battery can be either charged when mounted on the bicycle or removed.

Insert the low voltage charger plug into the battery's charging socket.

Connect the mains power plug into an electric outlet (AC 110 - 240 volts) and make sure that all pins are fully inserted into the socket.

CAUTION:

Keep the area where the battery is charged, well ventilated and free from debris or anything else combustible to avoid fire from overheating or sparks.

IMPORTANT:

Charging time is indicative only. Actual charging time depends on the age of the battery and the number of times it has been cycled (charged and discharged)

- Turn off the power switch.
- Disconnect the charger from the battery, once the charge cycle is complete
- Side-mount the battery into the bicycle and secure by using the key lock situated above the key switch.

CAUTION:

Always ensure that the battery is secured in the "LOCK" position, so that there is minimal movement sideways.

CAUTION:

Charge the battery in a room with an ambient temperature of between 0° - 40° C.

If the bike's range per charge becomes too short even after refresh charging is repeated, the battery's lifecycle may have ended. Please replace the battery with a new one

Do not recharge the battery continuously for over 24 hours as this could seriously reduce the life of the battery.

SUMMARY

Step 1. Remove the battery from the bike.

Step 2. Connect the charger to the battery.

Step 3. Turn on the power switch. The LED goes from GREEN to RED.

Step 4. Disconnect the battery from the charger after the charge is completed.

Step 5. Side-mount the battery onto the bicycle. The key must be turned anti-clockwise to open and allow battery to fit into the frame.

Apollo is Distributed by

Apollo Bicycle Co. Pty. Ltd.

ABN: 60001 914 469

PO Box 4572, Dandenong Sth, VIC 3164

Ph: (03) 9700 9400 Fax: (03) 9700 9499

Bikes International Limited

38 Airpark Drive, Mangere, Auckland, NZ

Ph: (09) 267 1245 Fax: (09) 267 3032

FIND APOLLO ONLINE **APOLLOBIKES.COM**

