

Haemodialysis

Bloodlines, Tubing Systems, Accessories

Product Range



2010/2011



Fresenius Medical Care

5008 Therapy System – the innovation ...

Enabling the application of ONLINE Haemodiafiltration in the most practical way.



ONLINE Priming/ONLINE HDF

- Saline free priming of extracorporeal circuit
- ONLINE HDF treatment as standard
- Enabled by the SafeLine included in every bloodline set

Reliable Precision

- Exact measurement of arterial pressure via pressure dome
- Trouble-free air detection directly on system tube

Convenience

- Clear layout and optimised tube lengths
- Machine assisted set-up and disassembling
- Reduced filling volume and less blood-air contact

4008 Sustained dependability

Reliability established over several years and millions of treatments.



Superior quality and safety

- Consistent and validated manufacturing
- Rigorous testing of bloodline performance
- Highly compatible interface between bloodlines and machine

Reliable therapy

- Matured technology recognised worldwide
- Extensive experience in the production of bloodlines – ensuring consistent product quality

Meeting diverse needs

- Appropriate sterilisation to suit varying demands
- Broad product range to meet all requirements

Ensuring safety with the authentic Fresenius Medical Care Original Bloodlines....

Quality and reliability characterise the Fresenius bloodlines in function and use.



Handling

- Clearly colour-coded components
- Ergonomic components and layout

Quality

- Certified quality systems for development, production and sales
- Perfect compatibility to machine interfaces

Safety

- Assurance of highest safety and performance with our 4008 and 5008 machines
- Transducer protector with integrated inspection windows
- Injection port with enlarged finger-protection shield

Biocompatibility

- Use of plasticisers with high haemocompatibility and low cytotoxic reaction
- Free of DEHP

Product Range 5008

DEHP-free

LifeLine^{Beta}

- Phtalate free
- Beta-sterilisation by accelerated electrons (e-beam)
- Fewer material alterations in comparison to gamma-irradiation
- No radioactive source of radiation

Adult Bloodlines

Beta sterilisation – DEHP free

Type	To be used with	Filling volume	Units per box	Art.-No.
AV-Sets				
AV-Set ONLINEplus 5008-R	5008/5008S	132 ml	24	F00000384
AV-Set ONLINEplus BVM 5008-R	5008	136 ml	24	F00000385
AV-Set ONLINE Priming 5008S-R	5008S	132 ml	24	F00000700
SN-Sets				
SN-Set ONLINEplus 5008-R	5008/5008S	166 ml	20	F00000386
SN-Set ONLINEplus BVM 5008-R	5008	169 ml	20	F00000387



Paediatric Bloodlines

Beta sterilisation – DEHP free

Type	To be used with	Inner diameter pump segment	Filling volume	Units per box	Art.-No.
AV-Sets					
AV-Set ONLINEplus BVM Paed 5008-R	5008	8 mm	108 ml	24	F00001068
SN-Sets					
SN-Set ONLINEplus BVM Paed 5008-R	5008	8 mm	142 ml	20	F00001069



BVM: Blood Volume Monitor
 -R: Beta Sterilisation (Radiation)

Inner diameter of pump segment: 8 mm
 Diameter of venous bubble catcher: 22 mm

Product Range 4008

DEHP-free

LifeLine^{Beta}

- Phtalate free
- Sterilisation by accelerated electrons (e-beam)
- Less material alterations in comparison to gamma-irradiation
- No radioactive source of radiation

Adult Bloodlines

Beta sterilisation – DEHP free

Type	To be used with	Filling volume	Units per box	Art.-No.
AV-Sets				
AV-Set B-R	2008/4008	161 ml	24	F00001124
AV-Set SRB-R	2008/4008	161 ml	24	F00000257
AV-Set SRB BVM-R	4008	172 ml	24	F00000258
SN-Sets				
SN-Set B-R	2008/4008	197 ml	20	F00001125
SN-Set SRB L-R	2008/4008	211 ml	20	F00000259
SN-Set SRB L BVM-R	4008	225 ml	20	F00001132

Paediatric Bloodlines

Beta sterilisation – DEHP free

Type	To be used with	Inner diameter pump segment	Filling volume	Units per box	Art.-No.
AV-Sets					
AV-Set-FMC Paed R	2008/4008	6.4 mm	117 ml	24	F00001064
AV-Set-FMC BVM/BTM Paed R	4008	6.4 mm	126 ml	24	F00001065
AV-Set-FMC Paed/Baby R	2008/4008	6.4 mm	56 ml	24	F00001063
SN-Sets					
AV-SN-Set-FMC Paed R	2008/4008	6.4 mm	155 ml	24	F00001067
AV-SN-Set-FMC Paed/Baby R	2008/4008	6.4 mm	88 ml	24	F00001066

All paediatric bloodlines 4008 are equipped with spike, waste bag and recirculation connector.

- S: Spike
- R: Recirculation connector
- B: Waste bag
- L: Long tubes to SN expansion chamber (needed for SN-treatment with 4008 S)
- BVM: Blood Volume Monitor
- R: Beta Sterilisation (Radiation)

Inner diameter of pump segment: 8 mm
Diameter of venous bubble catcher: 22 mm





Adult Bloodlines ETO sterilisation

BasicLine

- Sterilisation by ethylene oxide
- Special pre-conditioning and degassing process leads to minimised residual ETO content

Type	To be used with	Filling volume	Spike	Waste bag	Recirculation connector	Units per box	Art.-No.
AV-Sets							
AV-Set-FMC (FA 204 C/FV 204 C)	2008/4008	161 ml	•		•	24	5000541
AV-Set-FMC (FA 204 B/FV 204 B)	2008/4008	161 ml		•		24	5000561
AV-Set-FMC (FA 204 C/FV 204 E)	2008/4008	161 ml	•	•	•	24	5003451
AV-Set-FMC (FA 204 C/FV 204 E) BVM	4008	172 ml	•	•	•	24	5016631
SN-Sets							
AV-SN-Set-FMC (FA 514 SN C/FV 204 E)	2008/4008	211 ml	•	•	•	20	5017411

BVM: Blood Volume Monitor

Inner diameter of pump segment: 8 mm

Diameter of venous bubble catcher: 22 mm

Fresenius Medical Care's bloodline components ...

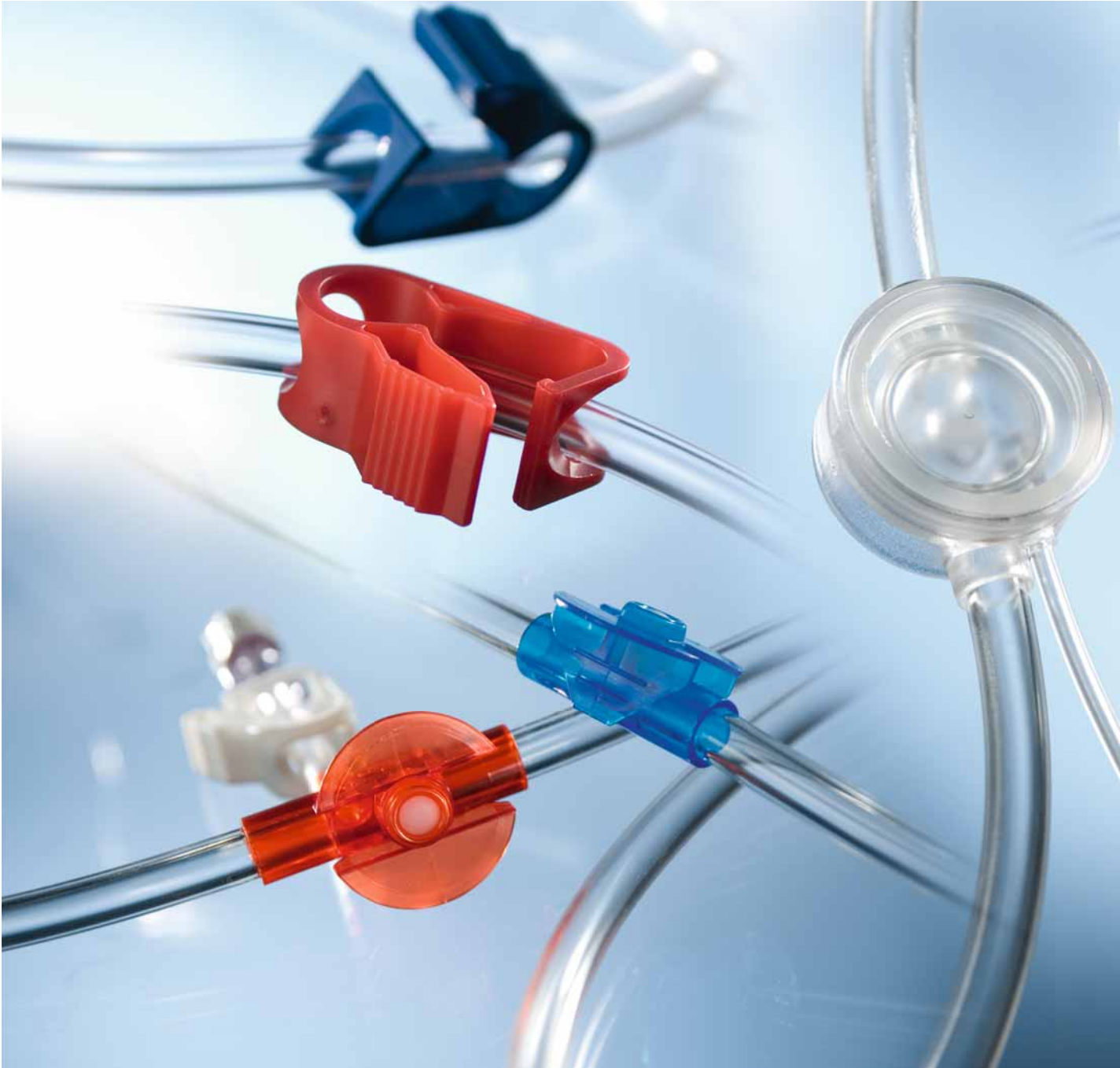

... developed to meet all your needs

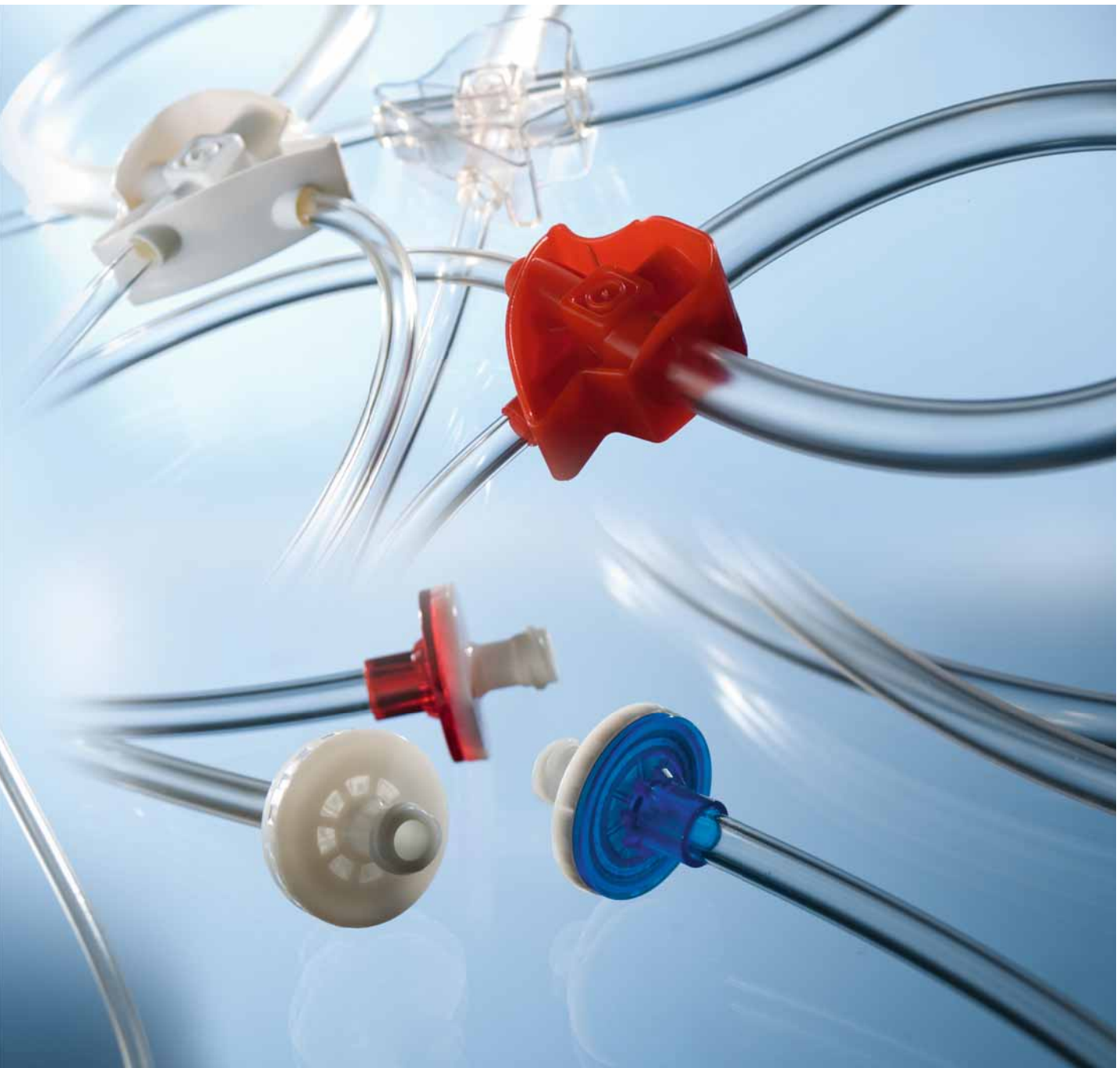

Components

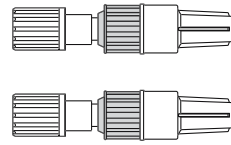

Patient connectors

Optimal handling and safety:

- Ergonomic grip on the rotating part ensures secure connection
- Easy to remove protective caps

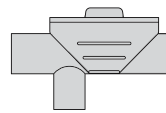
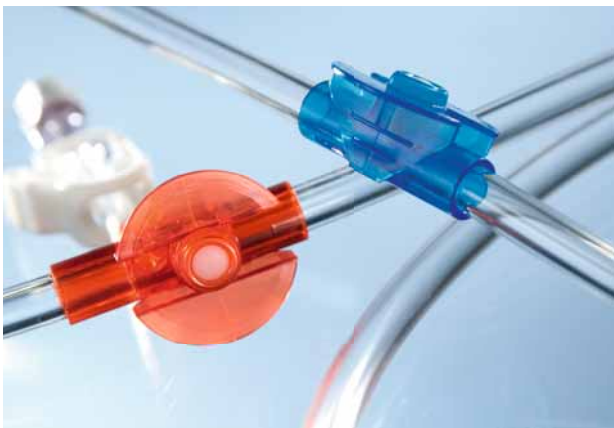

Injection ports

- Latex-free septum
- Colour coding
- Large finger-protection shield

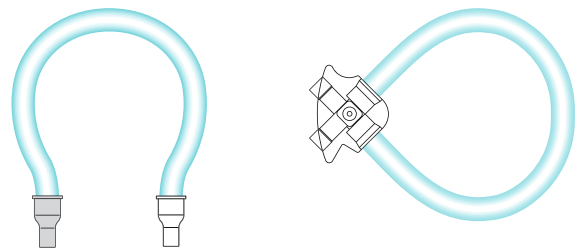

Pump segment 4008/5008

- Perfect fit to the Fresenius Medical Care dialysis machines (geometry, shore hardness, occlusion performance)
 - Qualified for the effective blood flow measurement
 - Allows achievement of prescribed dialysis dose

Components

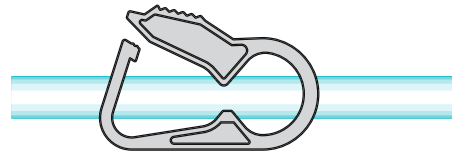

Line clamps

- Colour coding
- Optimal ergonomics for easy and reliable handling
- No additional clamps required

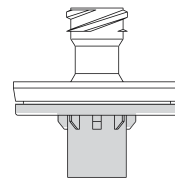

Transducer protectors

- Inspection windows
- Colour coding

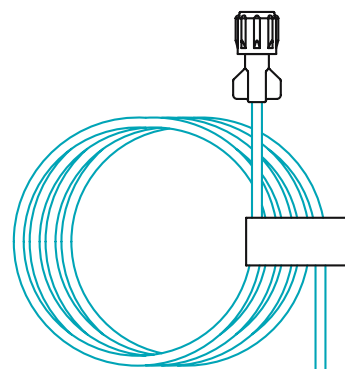

Heparin line

- Luer-Lock female Adapter with protecting cap
- Easy to remove paper tape

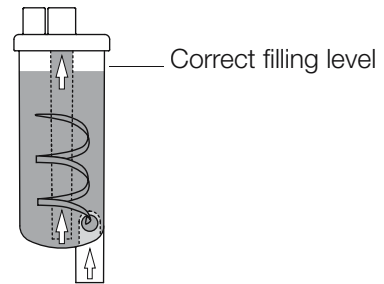

Arterial bubble catcher

- Dynamic blood flow due to special geometry
- Safe and effective air separation



Single Needle chamber

- Dynamic blood flow
- Level mark for easy handling

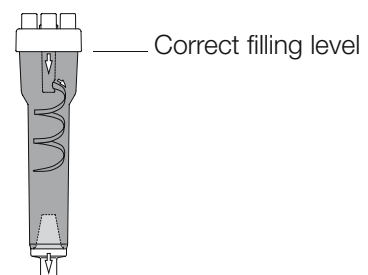

Venous bubble catcher

- Inlet distributor reduces activation of clotting
 - Directed blood flow
 - No "free fall" of blood
- Allows an easy and correct positioning in the air detector due to the special shape of venous bubble trap (22 mm Ø)

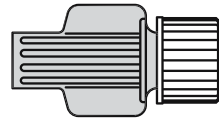

Dialyser connector

- Soft material allows safe connection to dialyser
- Easy to remove protective caps



Pressure dome

- Precise pressure measurement
- Reduced filling volume
- No blood-air contact

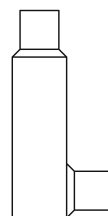

BVM cuvette

- Precise BVM measurement
- Easy handling

AV-Set ONLINEplus 5008-R (F00000384)

Arterial line

Venous line

SafeLine

Variants

(Venous line and SafeLine
unchanged)

SN-Set ONLINEplus 5008-R
(F00000386)

AV-Set ONLINEplus BVM 5008-R
(F00000385)

SN-Set ONLINEplus BVM 5008-R
(F00000387)

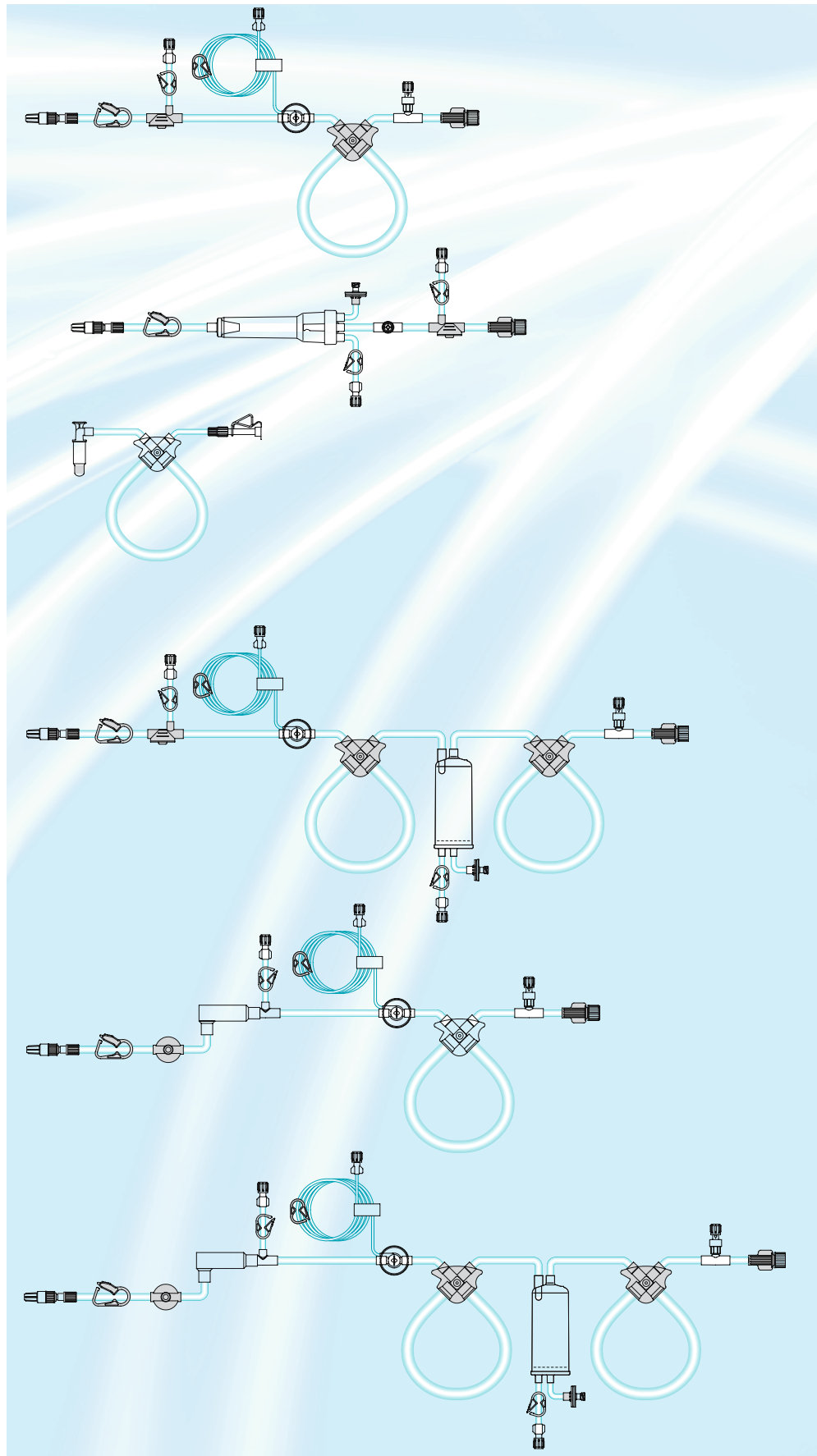

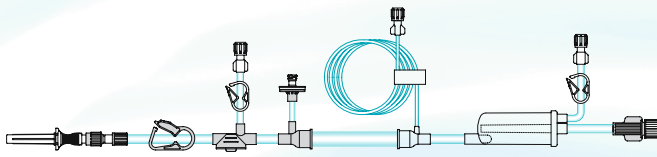

AV-Set SRB-R (F0000257)

Arterial line

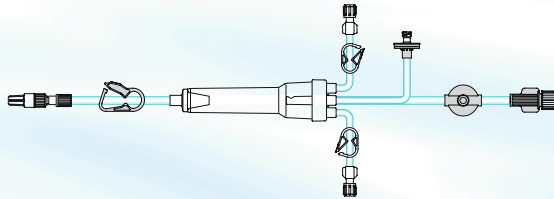

Venous line

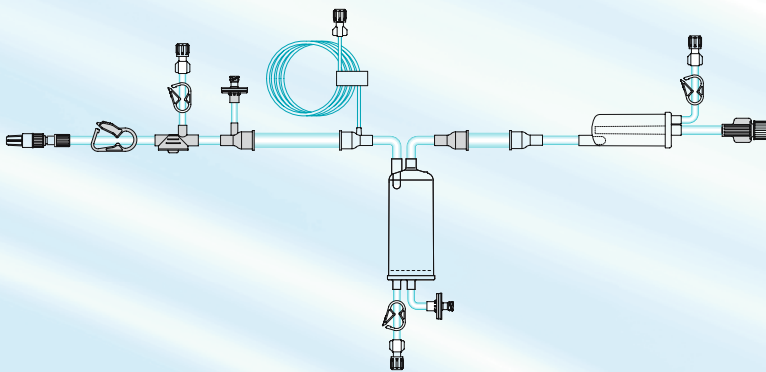

Variants

(Venous lines unchanged)

SN-Set B-R
(F00001125)

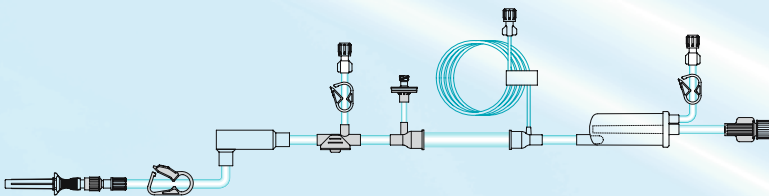

AV-Set SRB BVM-R
(F00000258)

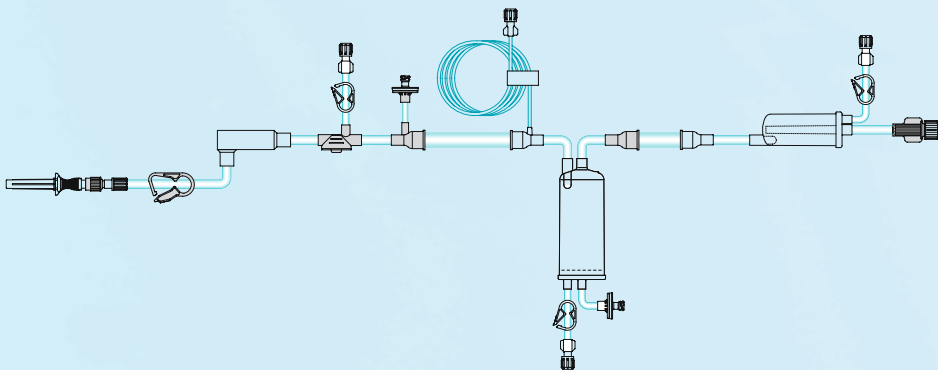

AV-SN-Set-FMC (FA 514-SN C/
FV 204E) BVM
(5017411)

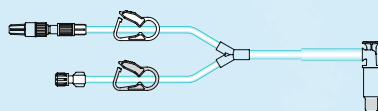

SafeLine
(F00001195)

Technical drawings paediatric lines

5008 AV-Set ONLINEplus – BVM Paed 5008-R (F00001068)

Arterial line

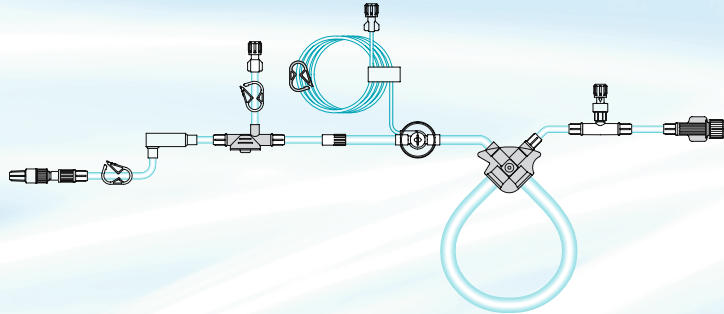

Venous line

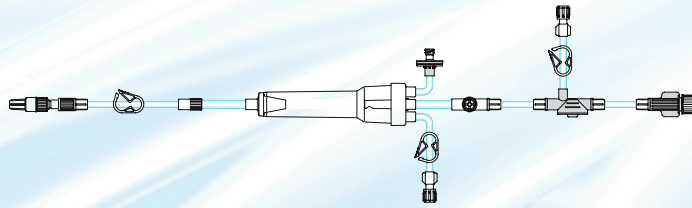

Safeline

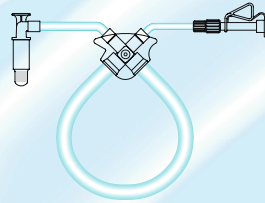

4008 AV-Set-FMC Paed R (F00001064)

Arterial line

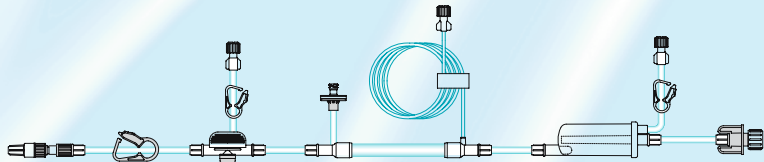

Venous line

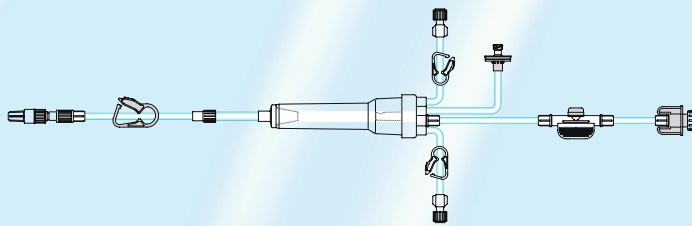

AV-Set-FMC Paed/Baby R (F00001063)

Arterial line

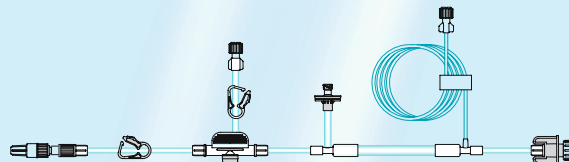

Venous line

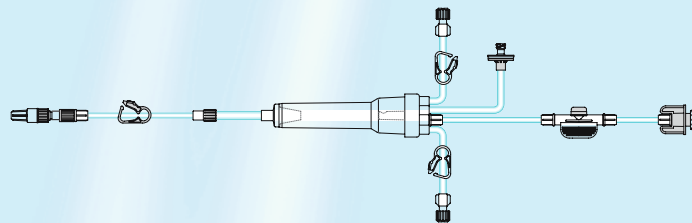

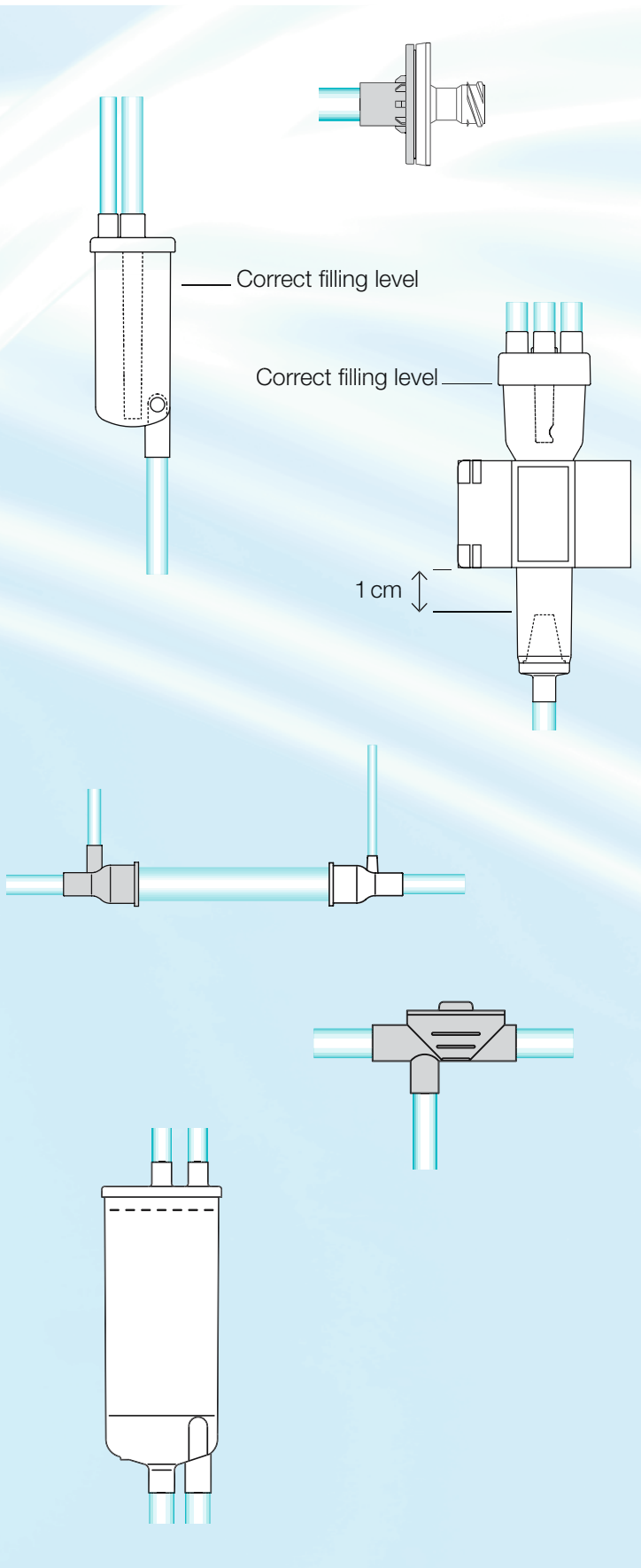

Pressure line

Connect the pressure transducer protector to the machine ensuring it is straight and secure (do not overtighten!). If the membrane is wet, replace either the bloodline or the pressure line with a new one.

Arterial bubble catcher

For level setting release the cap, raise the level slowly to the filling line. Make sure that the caps are secure and the clamps closed.

Venous bubble catcher (4008)

Rest the shoulder of the chamber on the top of the level detector holder, so the filter of the chamber is 1 cm below the level of the door.

Make sure that the caps are secure and the clamps closed.

Pump segment (4008)

Insert the pump segment with the red colour coding on the left hand side.

SN-pump segment (4008)

Make sure that all air has been removed during the priming of the pump segment.

Injection port

Clean the septum by using an alcohol wipe. Hold the injection port by the finger grips underneath the protection shield. Insert the needle directly into the septum (90°).

SN-chamber

Place the chamber into the holder.









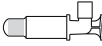

Connect the pressure line (see above).

Make sure that the caps are secure and the clamps closed.





Do not invert the chamber.

During priming, the filling level will be set automatically (do not raise the level manually).

Accessories

Type	To be used with	Sterilisation	Description	Connectors	Units per box	Art.-No.
HF / HDF						
Drainage connector	4008/5008	Beta	ONLINEplus HDF 5008		12	7030031
Safeline	4008	Beta	ONLINEplus 4008, pump segment 6.4 mm		100	F00001195
Tubing system FS 130	4008	ETO	Standard HDF, Pump segment 4.4 mm		40	5046301
Infusion sets						
Frekaflex infusion set	4008	ETO	Infusion set Luer-Lock male / Luer-Lock male with roller clamp		150	2889011
Infusion set	4008	ETO	Infusion set with vented spike, Luer-Lock male and drip chamber		150	5016371
Transfer set	4008	ETO	Infusion set Luer-Lock male / Luer-Lock male		150	5016391
Waste bags						
Waste bag 2,000 ml	4008	ETO	Rinsing of extracorporeal circuit		100	5015091
Transducer protectors						
Transducer protector	4008/5008	ETO	Luer-Lock male/female		100	5015911
Pressure line 30 cm	4008/5008	ETO	Complete pressure line 30 cm, Luer-Lock male/female		100	5014631
Pressure line 60 cm	4008/5008	ETO	Complete pressure line 60 cm, Luer-Lock male/female		200	5019151
Various accessories						
Heparin syringe 30 ml	5008	ETO	Luer-Lock male, separate closure cap, latex-free plug		100	5030321
Heparin syringe 20 ml	4008/5008	ETO	Luer-Lock male, separate closure cap, latex-free plug		120	F0000125*
SN-adaptor Luer-Lock	4008/5008	ETO	Y-adaptor, 2 x Luer-Lock female, 1 x Luer-Lock male		100	5027851

*coming soon

Type	To be used with	Sterilisation	Description	Connectors	Units per box	Art.-No.
Scissor clamp	4008/5008	---	For clamping tubes		5	2845241
Recirculation connector	4008/5008	Beta	For short-circuit of AV-set, Luer-Lock female / Luer-Lock female		100	5015971
Adapter Luer-Lock female / Luer-Lock female	4008/5008	ETO	For short circuit of blood tubings (AV-sets)		100	5014801
Adapter Luer-Lock male / Luer-Lock male	4008/5008	ETO	For short circuit of fistula needles		100	5014771
Spike	4008/5008	Beta	Spike/Luer-Lock female		100	5015921
Prolongation 75 cm	4008/5008	Beta	Luer-Lock male/female		100	7030011
Dialyser exchange set	4008/5008	ETO	Tubing system for exchange of dialyser during treatment, short-circuit AV-set		75	5018001
Mounts						
Universal mount, single	4008	---	Mount for arterial bubble trap for 4008 E/H		1	5000271
Universal mount, double	4008	---	Mount for arterial bubble trap and SN expansion chamber, for 2008 and 4008 B/S		1	5000261
HD Connection-Disconnection Set						
proHD Set S		ETO	Drape, nitrile gloves, non-woven gauzes, adhesive tapes, haemostatic plasters		170	F00000836
proHD Set M		ETO	Drape, nitrile gloves, non-woven gauzes, adhesive tapes, haemostatic plasters		170	F00000837
proHD Set L		ETO	Drape, nitrile gloves, non-woven gauzes, adhesive tapes, haemostatic plasters		170	F00000838
The letters S, M and L in the name of the proHD Sets indicate the glove size. For more detailed information see brochure F00001561						



Fresenius Medical Care

Head office: Fresenius Medical Care Deutschland GmbH · 61346 Bad Homburg v. d. H. · Germany · Phone: +49 (0) 6172-609-0 · Fax: +49 (0) 6172-609-2191
Else-Kröner-Straße 1 · 61352 Bad Homburg v. d. H.
www.fmc-ag.com