

ONKYO®

BLU-RAY DISC PLAYER

BD-SP309

Instruction Manual

Thank you for purchasing an Onkyo BLU-RAY DISC PLAYER. Please read this manual thoroughly before making connections and plugging in the unit. Following the instructions in this manual will enable you to obtain optimum performance and listening enjoyment from your new BLU-RAY DISC PLAYER. Please retain this manual for future reference.

Contents

Introduction 2

Connection 15

Playback 19

Settings 39

Troubleshooting 50

Appendix 54



WARNING:

TO REDUCE THE RISK OF FIRE OR ELECTRIC SHOCK, DO NOT EXPOSE THIS APPARATUS TO RAIN OR MOISTURE.

CAUTION:

TO REDUCE THE RISK OF ELECTRIC SHOCK, DO NOT REMOVE COVER (OR BACK). NO USER-SERVICEABLE PARTS INSIDE. REFER SERVICING TO QUALIFIED SERVICE PERSONNEL.



WARNING
RISK OF ELECTRIC SHOCK
DO NOT OPEN

AVIS
RISQUE DE CHOC ELECTRIQUE
NE PAS COUVRIR



The lightning flash with arrowhead symbol, within an equilateral triangle, is intended to alert the user to the presence of uninsulated "dangerous voltage" within the product's enclosure that may be of sufficient magnitude to constitute a risk of electric shock to persons. The exclamation point within an equilateral triangle is intended to alert the user to the presence of important operating and maintenance (servicing) instructions in the literature accompanying the appliance.

Important Safety Instructions

1. Read these instructions.
2. Keep these instructions.
3. Heed all warnings.
4. Follow all instructions.
5. Do not use this apparatus near water.
6. Clean only with dry cloth.
7. Do not block any ventilation openings. Install in accordance with the manufacturer's instructions.
8. Do not install near any heat sources such as radiators, heat registers, stoves, or other apparatus (including amplifiers) that produce heat.
9. Do not defeat the safety purpose of the polarized or grounding-type plug. A polarized plug has two blades with one wider than the other. A grounding type plug has two blades and a third grounding prong. The wide blade or the third prong are provided for your safety. If the provided plug does not fit into your outlet, consult an electrician for replacement of the obsolete outlet.
10. Protect the power cord from being walked on or pinched particularly at plugs, convenience receptacles, and the point where they exit from the apparatus.
11. Only use attachments/accessories specified by the manufacturer.
12. Use only with the cart, stand, tripod, bracket, or table specified by the manufacturer, or sold with the apparatus. When a cart is used, use caution when moving the cart/apparatus combination to avoid injury from tip-over.
13. Unplug this apparatus during lightning storms or when unused for long periods of time.
14. Refer all servicing to qualified service personnel. Servicing is required when the apparatus has been damaged in any way, such as power-supply cord or plug is damaged, liquid has been spilled or objects have fallen into the apparatus, the apparatus has been exposed to rain or moisture, does not operate normally, or has been dropped.
15. **Damage Requiring Service**
Unplug the apparatus from the wall outlet and refer servicing to qualified service personnel under the following conditions:
 - A When the power-supply cord or plug is damaged,
 - B If liquid has been spilled, or objects have fallen into the apparatus,
 - C If the apparatus has been exposed to rain or water,
 - D If the apparatus does not operate normally by following the operating instructions. Adjust only those controls that are covered by the operating instructions as an improper adjustment of other controls may result in damage and will often require extensive work by a qualified technician to restore the apparatus to its normal operation,
 - E If the apparatus has been dropped or damaged in any way, and
 - F When the apparatus exhibits a distinct change in performance this indicates a need for service.
16. **Object and Liquid Entry**
Never push objects of any kind into the apparatus through openings as they may touch dangerous voltage points or short-out parts that could result in a fire or electric shock. The apparatus shall not be exposed to dripping or splashing and no objects filled with liquids, such as vases shall be placed on the apparatus. Don't put candles or other burning objects on top of this unit.
17. **Batteries**
Always consider the environmental issues and follow local regulations when disposing of batteries.
18. If you install the apparatus in a built-in installation, such as a bookcase or rack, ensure that there is adequate ventilation. Leave 20 cm (8") of free space at the top and sides and 10 cm (4") at the rear. The rear edge of the shelf or board above the apparatus shall be set 10 cm (4") away from the rear panel or wall, creating a flue-like gap for warm air to escape.

PORTABLE CART WARNING



S3125A

Precautions

- 1. Recording Copyright**—Unless it's for personal use only, recording copyrighted material is illegal without the permission of the copyright holder.
- 2. AC Fuse**—The AC fuse inside the unit is not user-serviceable. If you cannot turn on the unit, contact your Onkyo dealer.
- 3. Care**—Occasionally you should dust the unit all over with a soft cloth. For stubborn stains, use a soft cloth dampened with a weak solution of mild detergent and water. Dry the unit immediately afterwards with a clean cloth. Don't use abrasive cloths, thinners, alcohol, or other chemical solvents, because they may damage the finish or remove the panel lettering.
- 4. Power**
WARNING
BEFORE PLUGGING IN THE UNIT FOR THE FIRST TIME, READ THE FOLLOWING SECTION CAREFULLY.
AC outlet voltages vary from country to country. Make sure that the voltage in your area meets the voltage requirements printed on the unit's rear panel (e.g., AC 200-240 V, 50/60 Hz or AC 120 V, 60 Hz). The power cord plug is used to disconnect this unit from the AC power source. Make sure that the plug is readily operable (easily accessible) at all times. Pressing the **ON/STANDBY** button to select Standby mode does not fully disconnect from the mains. If you do not intend to use the unit for an extended period, remove the power cord from the AC outlet.
- 5. Preventing Hearing Loss**
Caution
Excessive sound pressure from earphones and headphones can cause hearing loss.
- 6. Batteries and Heat Exposure**
Warning
Batteries (battery pack or batteries installed) shall not be exposed to excessive heat as sunshine, fire or the like.
- 7. Never Touch this Unit with Wet Hands**—Never handle this unit or its power cord while your hands are wet or damp. If water or any other liquid gets inside this unit, have it checked by your Onkyo dealer.
- 8. Handling Notes**
 - If you need to transport this unit, use the original packaging to pack it how it was when you originally bought it.
 - Do not leave rubber or plastic items on this unit for a long time, because they may leave marks on the case.
 - This unit's top and rear panels may get warm after prolonged use. This is normal.
- 9. Installing this Unit**
 - If you do not use this unit for a long time, it may not work properly the next time you turn it on, so be sure to use it occasionally.
 - When you've finished using this unit, remove all discs and turn off the power.
 - Install this unit in a well-ventilated location.
 - Ensure that there's adequate ventilation all around this unit, especially if it's installed in an audio rack. If the ventilation is inadequate, the unit may overheat, leading to malfunction.
 - Do not expose this unit to direct sunlight or heat sources, because its internal temperature may rise, shortening the life of the optical pickup.
 - Avoid damp and dusty places, and places subject to vibrations from loudspeakers.
 - Never put the unit on top of, or directly above a loudspeaker.
 - Install this unit horizontally. Never use it on its side or on a sloping surface, because it may cause a malfunction.
 - If you install this unit near a TV, radio, or VCR, the picture and sound quality may be affected. If this occurs, move this unit away from the TV, radio, or VCR.
- 10. To Obtain a Clear Picture**—This unit is a hightech, precision device. If the lens on the optical pickup, or the disc drive mechanism becomes dirty or worn, the picture quality may be affected. To maintain the best picture quality, we recommend regular inspection and maintenance (cleaning or worn part replacement) every 1,000 hours of use depending on the operating environment. Contact your Onkyo dealer for details.
- 11. Moisture Condensation**
Moisture condensation may damage this unit.
Read the following carefully:
Moisture may condense on the lens of the optical pickup, one of the most important parts inside this unit.
 - Moisture condensation can occur in the following situations:
 - The unit is moved from a cold place to a warm place.
 - A heater is turned on, or cold air from an air conditioner is hitting the unit.
 - In the summer, when this unit is moved from an air conditioned room to a hot and humid place.
 - The unit is used in a humid place.
 - Do not use this unit when there's the possibility of moisture condensation occurring. Doing so may damage your discs and certain parts inside this unit.

If condensation does occur, unplug the power cord and leave the unit for two to three hours in the room temperature.

12. Region Codes—The BD/DVD standard uses region codes to control how discs can be played around the world, the world being divided into three regions (BD) or six regions (DVD). This unit will only play BD/ DVD discs that match its region code, which can be found on its rear panel.

13. About this Manual—This manual explains how to use all of this unit's functions. Although the BD/DVD standard offers many special features, not all discs use them all, so depending on the disc being played, this unit may not respond to certain functions. See the disc's sleeve notes for supported features.

This unit contains a semiconductor laser system and is classified as a "CLASS 1 LASER PRODUCT". So, to use this model properly, read this Instruction Manual carefully. In case of any trouble, please contact the store where you purchased the unit.

To prevent being exposed to the laser beam, do not try to open the enclosure.

CAUTION:

CLASS 1M VISIBLE AND INVISIBLE LASER RADIATION WHEN OPEN. DO NOT VIEW DIRECTLY WITH OPTICAL INSTRUMENTS. THIS PRODUCT UTILIZES A LASER. USE OF CONTROLS OR ADJUSTMENTS OR PERFORMANCE OF PROCEDURES OTHER THAN THOSE SPECIFIED HEREIN MAY RESULT IN HAZARDOUS RADIATION EXPOSURE.

The label on the right is applied on the rear panel.



1. This unit is a CLASS 1 LASER PRODUCT and employs a laser inside the cabinet.
2. To prevent the laser from being exposed, do not remove the cover. Refer servicing to qualified personnel.

For British models

Replacement and mounting of an AC plug on the power supply cord of this unit should be performed only by qualified service personnel.

IMPORTANT

The wires in the mains lead are coloured in accordance with the following code:

Blue: Neutral

Brown: Live

As the colours of the wires in the mains lead of this apparatus may not correspond with the coloured markings identifying the terminals in your plug, proceed as follows:

The wire which is coloured blue must be connected to the terminal which is marked with the letter N or coloured black.

The wire which is coloured brown must be connected to the terminal which is marked with the letter L or coloured red.

IMPORTANT

The plug is fitted with an appropriate fuse. If the fuse needs to be replaced, the replacement fuse must approved by ASTA or BSI to BS1362 and have the same ampere rating as that indicated on the plug. Check for the ASTA mark or the BSI mark on the body of the fuse.

If the power cord's plug is not suitable for your socket outlets, cut it off and fit a suitable plug. Fit a suitable fuse in the plug.

For European Models

Declaration of Conformity

We, ONKYO EUROPE
ELECTRONICS GmbH
LIEGNITZERSTRASSE 6,
82194 GROEBENZELL,
GERMANY

declare in own responsibility,
that the ONKYO product
described in this instruction manual is in compliance with
the corresponding technical standards such as EN60065,
EN55013, EN55020 and EN61000-3-2, -3-3.



GROEBENZELL, GERMANY

K. MIYAGI

ONKYO EUROPE ELECTRONICS GmbH.

Contents

Introduction	
Important Safety Instructions	2
Precautions	3
Contents	5
Getting Started	6
Symbols Used in this Manual	6
Supplied Accessories	6
About Media Types	7
Blu-ray Disc	7
Types of Discs/Media Formats that Can Be Used with This Player	7
Discs that Cannot Be Used with This Player	8
About Disc Contents	10
Important Information	11
Disc Precautions	11
License and Copyright	12
Major Components	13
Main unit (Front)	13
Main unit (Rear)	13
Remote Control Unit	14
Connection	
Connecting to a TV/projector	15
Connecting to an amplifier/AV receiver	16
HDMI connection	16
Digital audio connection	17
Broadband Internet Connection	18
Wired connection (LAN cable)	18
Playback	
Before Starting Playback	19
Loading the Batteries in the Remote Control	19
Connecting the Power Cord	19
Turning the Power On	20
Language Setting	20
Operating ONKYO AV Receiver Using the Remote Control	21
Using HDMI Control	21
Using 3D	21
Video/Picture/Music Playback	22
Loading a Disc	22
BD/DVD Video Playback	22
BD/DVD Menus	23
Enjoying BONUSVIEW or BD-LIVE	24
DVD-R/-RW (VR format) / BD-RE/-R (BDAV format) Playback	25
Audio CD Playback	27
Audio Data (MP3 File) Playback	28
Displaying Still Images (JPEG files)	29
Accessing UPnP* servers	31
Playback Functions	33
Fast Forward/Reverse (Search)	33
Skipping to the Next or the Start of the Current Chapter (Track/Title)	33
Pause/Frame Advance Playback	33
Slow Playback (Forward/Reverse)	34
Repeat Playback of a Title or Chapter (Repeat Playback)	34
Partial Repeat Playback (Repeat Playback of a Specified Part)	35
Displaying the Audio Information	35
Switching Subtitles	35
Switching the Angle	36
Displaying the Angle Mark	36
Settings During Playback	37
Function Control	37
Settings	
SETTINGS	39
Common operations	39
Basic Operation for Playback Setting	39
Audio Video Settings	40
Smart Settings	41
HDMI Control	41
Playback Setting	41
On Screen Language	42
Version	42
System	42
Communication Setup	43
USB Memory Management	44
Software Update Settings	45
Troubleshooting	
Troubleshooting	50
Appendix	
On-screen Error Messages	54
Specifications	55
Glossary	56
About Software License	59
Information on the Software License for This Product	59
Software License Notice	59

Getting Started

Symbols Used in this Manual

Note

Indicates special notes and operating features.

Caution

Indicates cautions for preventing possible damage from abuse.

A section whose title has one of the following symbols are applicable only to the disc represented by the symbol.

BD VIDEO

Indicates the functions that can be performed for BD Video discs.

BD-RE

Indicates the functions that can be performed for BD-RE discs.

BD-R

Indicates the functions that can be performed for BD-R discs.

DVD VIDEO

Indicates the functions that can be performed for DVD Video discs.

DVD-RW

Indicates the functions that can be performed for DVD-RW discs.

DVD-R

Indicates the functions that can be performed for DVD-R discs.

AUDIO CD

Indicates the functions that can be performed for Audio CDs.

CD-R

Indicates the functions that can be performed for CD-R discs.

CD-RW

Indicates the functions that can be performed for CD-RW discs.

USB

Indicates the functions that can be performed for USB memory devices.

Supplied Accessories

Remote control unit (1)



"AA" size battery (2)

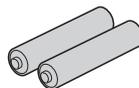

AC cord (1)



About Media Types

Blu-ray Disc

Blu-ray Disc is the ultimate next generation optical media format, offering the following key features:

- Largest capacity (25 GB single layer – 50 GB dual layer)
 - with over 5 times the amount of content possible with current DVDs, particularly well suited for high definition feature films with extended levels of interactive features
- Pristine picture quality with the capability for full high definition 1920 x 1080p resolution
- Best audio possible with uncompressed surround sound (higher quality than even theatre audio)
- Broadest industry support – ensuring more choice for consumers in the marketplace
- Hardware products will be backward compatible with DVDs, allowing continued enjoyment of existing DVD libraries.
- Disc Durability – new breakthroughs in hard coating technologies gives Blu-ray Discs the strongest resistance to scratches and finger prints.

Types of Discs/Media Formats that Can Be Used with This Player

- The following discs can be played back in this Player. Do not use an 8 cm to 12 cm adapter.
- Use discs that conform to compatible standards as indicated by the presence of official logos on the disc label. Playback of discs not complying with these standards is not guaranteed. In addition, the image quality or sound quality is not guaranteed even if the discs can be played back.

Disc Type		Recording Format	Contents	Disc Size
BD Video	Region code B/ALL 	—	Audio + Video (Movie)	12 cm
BD-RE DL BD-R DL		BDMV/BDVA format		
DVD Video	Region code 2/ALL 	Video format	Audio + Video (Movie)	12 cm 8 cm
DVD+RW/DVD+R DVD-RW/DVD-R DVD+R DL/DVD-R DL		Video/VR/ AVCHD format (finalised disc only) DivX+HD (H.264/MKV) JPEG ² MP3 ³	Audio + Video (Movie) Still image (JPEG file) Audio	12 cm 8 cm

Disc Type	Recording Format	Contents	Disc Size
Audio CD ¹	Audio CD (CD-DA)	Audio	12 cm 8 cm
CD-RW/CD-R	Audio CD (CD-DA)	Audio	
	JPEG ²	Still image (JPEG file)	
	MP3 ³	Audio	

Media Format	Recording Format	Contents
USB memory device	DivX+HD	Audio + Video (Movie)
	JPEG ²	Still image (JPEG file)
	MP3 ³	Audio

- BD/DVD video players and discs have region codes, which dictate the regions in which a disc can be played. This Player's region code is B for BD and 2 for DVD. (Discs marked ALL will play in any player.)
- BD/DVD video operations and functions may be different from the explanations in this manual and some operations may be prohibited due to disc manufacturer's settings.
- If a menu screen or operating instructions are displayed during playback of a disc, follow the operating procedure displayed.

NOTE

- Playback for some of the discs in the left side column tables may not be possible depending on the disc.
- "Finalise" refers to a recorder processing a recorded disc so that it will play in other DVD players/recorders as well as this player. Only finalised DVD discs will play back in this player. (This player does not have a function to finalise discs.)
- Some discs cannot be played back depending on the recording format.
- DivX playback may not be available depending on the DivX content. For details, refer to page 49.

Discs that Cannot Be Used with This Player

The following discs cannot be played back or will not play back properly on this Player. If such a disc is mistakenly played back, speaker damage may occur. Never attempt to play back these discs.

CDG, Video CD, Photo CD, CD-ROM, CD-TEXT, SVCD, SACD, PD, CDV, CVD, DVD-RAM, DVD Audio, BD-RE with the cartridge, CD-WMA

■ **Discs with unusual shapes cannot be played.**

- Discs with unusual shapes (heart-shaped or hexagonal discs, etc.) cannot be used. The use of such discs will cause malfunction.

■ **The following BD video discs cannot be played.**

- Discs not displaying “B” or “ALL” for the region code (discs sold outside the authorised marketing area).*
- Discs produced illegally.
- Discs recorded for commercial use.

* The region code for this product is B.

■ **The following DVD video discs cannot be played.**

- Discs not displaying “2” or “ALL” for the region code (discs sold outside the authorised marketing area).*
- Discs produced illegally.
- Discs recorded for commercial use.

* The region code for this product is 2.

The following BD-RE/R, DVD-RW/R and DVD+RW/R discs cannot be played.

- Discs on which data has not been recorded cannot be played back.
- BD-discs may not be played back depending on their recording status or the status of the disc itself. The playback compatibility will be affected by your choice of BD-recorder, BD-disc and BD-burning software. Please always ensure you are using the latest software versions on all units and contact the individual manufacturers for further help if required.

To avoid inconveniences, please check the playback compatibility of your self-recorded disc before you purchase this BD-player.

This BD-player uses the latest technology available at the time of development and cannot guarantee support for future enhancements or changes to the standard.

The following Audio CD*¹ discs cannot be played.

- Discs containing a signal for the purpose of protecting copyrights (copy control signal) may not be played back with this Player.
- This Player has been designed on the premise of playing back Audio CDs that comply with CD (Compact Disc) standards.

■ **The following CD-RW/R discs cannot be played.**

- Discs on which data has not been recorded cannot be played back.
- Discs recorded in a format other than an Audio CD and JPEG/MP3 file format cannot be played back.
- Discs may not be played back depending on their recording status or the status of the disc itself.
- Discs may not be played back depending on their compatibility with this Player.

***² About the JPEG file format**

JPEG is a type of file format for storing still-image files (photos, illustrations, etc.). The Player lets you play JPEG format still-image files.

■ **File formats that are not compatible.**

- Still images in formats other than JPEG (such as TIFF) cannot be played.
- There may be some files that cannot be played even if they are in JPEG format.
- Progressive JPEG files cannot be played.
- Moving image files as well as Motion JPEG format files cannot be played, even though they are JPEG files.

■ **Other files that cannot be played back.**

- You may not be able to play some still images which you have created, touched up, copied or otherwise edited on your computer.
- You may not be able to play some still images you have processed (rotated or saved by overwriting other images you have imported from the Internet or e-mail).

- You may experience one or more of the following symptoms when playing files.
 - It may take some time to play files depending on the number of folders, number of files and volume of data involved.
 - EXIF information will not be displayed. EXIF stands for Exchangeable Image File Format, and is a standard for storing interchange information in image files, especially those using JPEG compression. (Refer to <http://exif.org> for more information.)

*3 About the MP3 file format

MP3 files are audio data compressed in the MPEG1/2 Audio layer-3 file format. "MP3 files" have ".mp3" as extensions. (Some files that have ".mp3" extensions or files that have not been recorded in MP3 format will produce noise or cannot be played.)

■ Playing the MP3 file format

- The MP3 files are not played in the order they were recorded.
- It is recommended to record data at a lower speed as data recorded at a fast speed can produce noise and may not be able to be played.
- The more folders there are, the longer the reading time.
- Depending on the folder tree, reading MP3 files can take time.
- The playing time may not be correctly displayed during MP3 file playback.

■ The following files cannot be played on this player.

- When both Audio CD [CD-DA] format and JPEG/MP3 file formats are recorded on a disc. (The disc is recognised to be an Audio CD [CD-DA] only tracks in Audio CD [CD-DA] format are played back.)
- Multi-session discs cannot be played.

About the DivX+HD (H.264/MKV) file format

Some files may not be playable depending on the file. For details, refer to page 49.

About files/folders for Still images (JPEG files) and audio data (MP3 files)

You can play still images (JPEG files) /audio data (MP3 files) with this unit by making folder(s) on discs or USB memory devices as shown below.

Example of a folder structure:

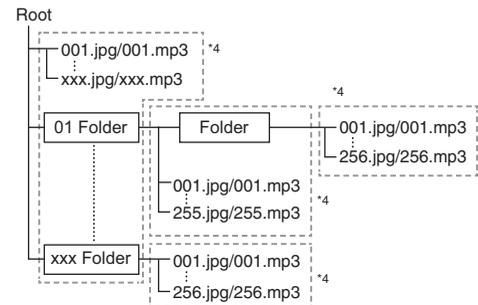

*4. Including the root directory, the maximum number of folders and files in each folder are limited to 256 in total.

■ File and folder requirements

- The discs or USB memory devices which this player can play back (recognise) are limited to the following properties:
 - Contains EXIF format files (only JPEG files)
 - Picture resolution: Between 32 x 32 and 7680 x 4320 pixels (only JPEG files)
 - Maximum number of folders and files in each folder: 256
 - Maximum hierarchy level of folders: 5
 - File size:
 - 20 MB or less (JPEG files)
 - 200 MB or less (MP3 files)

NOTE

- File and folder names displayed on this player may differ from those displayed on PCs.

ABOUT DivX VIDEO

- DivX® is a digital video format created by DivX, Inc. This is an official DivX Certified® device that plays DivX video. Visit www.divx.com for more information and software tools to convert your files into DivX video.

DivX Certified® to play DivX® and DivX Plus™ HD (H.264/MKV) video up to 1080p HD including premium content.

ABOUT DivX VIDEO-ON-DEMAND

- This DivX Certified® device must be registered in order to play purchased DivX Video-on-Demand (VOD) movies. To obtain the registration code, locate the DivX VOD section in your device setup menu. Go to vod.divx.com for more information on how to complete your registration.

BD Video

Enjoy BD-specific functions including BONUSVIEW (BD-ROM Profile 1 Version 1.1), such as picture in picture, and BD-LIVE (Page 24).

For the BD video discs compatible with BONUSVIEW/BD-LIVE, you can enjoy additional contents by copying the data from the discs or downloading it via the Internet. For instance, this function is capable of playing the original movie as the primary video while playing video commentary from the film director on a small screen as a secondary video.

NOTE

- The available functions differ depending on the disc.

Title, Chapter and Track

- Blu-ray discs and DVDs are divided into “Titles” and “Chapters”. If the disc has more than one movie on it, each movie would be a separate “Title”. “Chapters”, on the other hand, are subdivisions of titles. (See Example 1.)
- Audio CDs are divided into “Tracks”. You can think of a “Track” as one tune on an Audio CD. (See Example 2.)

Example 1: Blu-ray disc or DVD

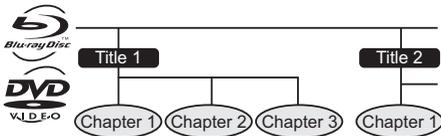

Example 2: Audio CD



Icons Used on BD/DVD Video Disc Cases

The back of the case of a BD/DVD that is commercially available usually contains various information about the contents of the disc.

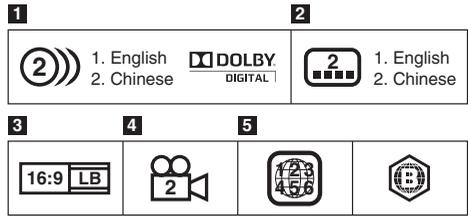

DVD Video BD Video

① Audio tracks and audio formats

BD and DVD discs can contain up to 8 separate tracks with a different language on each. The first in the list is the original track. This section also details the audio format of each soundtrack — Dolby Digital, DTS, MPEG etc.

► Dolby Digital

A sound system developed by Dolby Laboratories Inc. that gives movie theatre ambience to audio output when the Player is connected to a Dolby Digital processor or amplifier.

► DTS

DTS is a digital sound system developed by DTS, Inc. for use in cinemas.

► Linear PCM

Linear PCM is a signal recording format used for Audio CDs and on some DVD and Blu-ray discs. The sound on Audio CDs is recorded at 44.1 kHz with 16 bits. (Sound is recorded between 48 kHz with 16 bits and 96 kHz with 24 bits on DVD video discs and between 48 kHz with 16 bits and 192 kHz with 24 bits on BD video discs.)

② Subtitle languages

This indicates the kind of subtitles.

③ Screen aspect ratio

Movies are shot in a variety of screen modes.

④ Camera angle

Recorded onto some BD/DVD discs are scenes which have been simultaneously shot from a number of different angles (the same scene is shot from the front, from the left side, from the right side, etc.).

⑤ Region code

This indicates the region code (playable region code).

Important Information

Disc Precautions

Be Careful of Scratches and Dust

- BD, DVD and CD discs are sensitive to dust, fingerprints and especially scratches. A scratched disc may not be able to be played back. Handle discs with care and store them in a safe place.

Proper Disc Storage

Place the disc in the centre of the disc case and store the case and disc upright.



Avoid storing discs in locations subject to direct sunlight, close to heating appliances or in locations of high humidity.



Do not drop discs or subject them to strong vibrations or impacts.



Avoid storing discs in locations where there are large amounts of dust or moisture.



Handling Precautions

- If the surface is soiled, wipe gently with a soft, damp (water only) cloth. When wiping discs, always move the cloth from the centre hole toward the outer edge.



- Do not use record cleaning sprays, benzene, thinner, static electricity prevention liquids or any other solvent.
- Do not touch the surface.
- Do not stick paper or adhesive labels to the disc.
- If the playing surface of a disc is soiled or scratched, the Player may decide that the disc is incompatible and eject the disc tray, or it may fail to play the disc correctly. Wipe any dirt off the playing surface with a soft cloth.

Cleaning the Pick Up Lens

- Never use commercially available cleaning discs. The use of these discs can damage the lens.

Warnings about dew formation

- Condensation may form on pick up lens or disc in the following conditions:
 - Immediately after a heater has been turned on.
 - In a steamy or very humid room.
 - When the Player is suddenly moved from a cold environment to a warm one.
- ▶ **When condensation forms:**
 - It becomes difficult for the Player to read the signals on the disc and prevents the Player from operating properly.
- ▶ **To remove condensation:**
 - Take out the disc and leave the Player with the power off until the condensation disappears. Using the Player when there is condensation may cause malfunction.

License and Copyright

Audio-visual material may consist of copyrighted works which must not be recorded without the authority of the owner of the copyright. Refer to relevant laws in your country.

- “This item incorporates copy protection technology that is protected by U.S. patents and other intellectual property rights of Rovi Corporation. Reverse engineering and disassembly are prohibited. It is forbidden by law to copy, broadcast, show, broadcast on cable, play in public, and rent copyrighted material without permission. DVD videos are copy protected, and any recordings made from these discs will be distorted.”
- “x.v.Colour” and “x.v.Colour” logo are trademarks of Sony Corporation.
- Blu-ray™, BONUSVIEW™ and the logos are trademarks of the Blu-ray Disc Association.
- ABOUT DIVX VIDEO: DivX® is a digital video format created by DivX, Inc. This is an official DivX Certified® device that plays DivX video. Visit www.divx.com for more information and software tools to convert your files into DivX video.
- ABOUT DIVX VIDEO-ON-DEMAND: This DivX Certified® device must be registered in order to play purchased DivX Video-on-Demand (VOD) movies. To obtain your registration code, locate the DivX VOD section in your device setup menu. Go to vod.divx.com for more information on how to complete your registration. Covered by one or more of the following U.S. patents: 7,295,673; 7,460,668; 7,515,710; 7,519,274
- LCフォント, LCFONT, エルシーフォント and LC logo mark are registered trademarks of SHARP Corporation. This product is embedded with LC Font technology, which was developed by SHARP Corporation for clearly displaying easy-to-read characters on an LCD screen. However, other non-LCD fonts are used for displaying some screen pages.

Trademarks and Licenses



Blu-ray™ and the logos are trademarks of the Blu-ray Disc Association.



“Blu-ray 3D” and “Blu-ray 3D” logo are trademarks of Blu-ray Disc Association.



“BD-LIVE” logo is a trade-mark of Blu-ray Disc Association.



“AVCHD” and the “AVCHD” logo are trademarks of Panasonic Corporation and Sony Corporation.



DivX®, DivX Certified®, DivX Plus™ HD and associated logos are trademarks of DivX, Inc. and are used under license.



“DVD Logo” is a trademark of DVD Format/Logo Licensing Corporation.



Manufactured under license from Dolby Laboratories. Dolby and the double-D symbol are trademarks of Dolby Laboratories.



Manufactured under license under U.S. Patent #s: 5,451,942; 5,956,674; 5,974,380; 5,978,762; 6,226,616; 6,487,535; 7,392,195; 7,272,567; 7,333,929; 7,212,872 & other U.S. and worldwide patents issued & pending. DTS and the Symbol are registered trademarks, & DTS-HD, DTS-HD Master Audio | Essential and the DTS logos are trademarks of DTS, Inc. Product includes software. ©DTS, Inc. All Rights Reserved.



“HDMI, the HDMI logo and High-Definition Multimedia Interface are trademarks or registered trademarks of HDMI Licensing LLC in the United States and other countries”.



Java and all Java based trademarks and logos are trademarks or registered trademarks of Oracle America, Inc. in the U.S. and other countries.

Major Components

Main unit (Front)

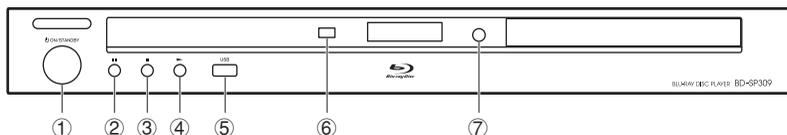

① **⏻ ON/STANDBY (p.20)**

② **⏸ (pause) (p.28)**

③ **■ (stop) (p.22)**

④ **▶ (play) (p.22)**

⑤ **USB (front) terminal (p.28)**

⑥ **Remote control sensor (p.19)**

⑦ **▲ (open/close) (p.22)**

Main unit (Rear)

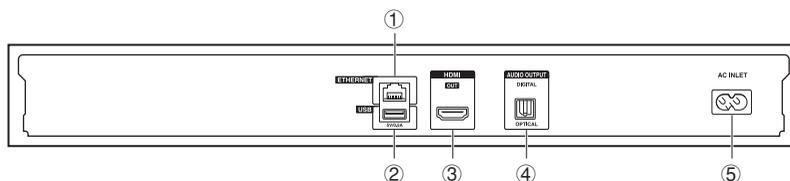

① **ETHERNET terminal (p.18)**

② **USB (rear) terminal (p.24)**

③ **HDMI OUT terminal (p.16)**

④ **DIGITAL AUDIO OUT OPTICAL terminal (p.17)**

⑤ **AC INLET terminal (p.19)**

NOTE

- When you insert or remove a USB memory device, be sure to turn the main power off. If you insert or remove the device with the player on, the data may become damaged.

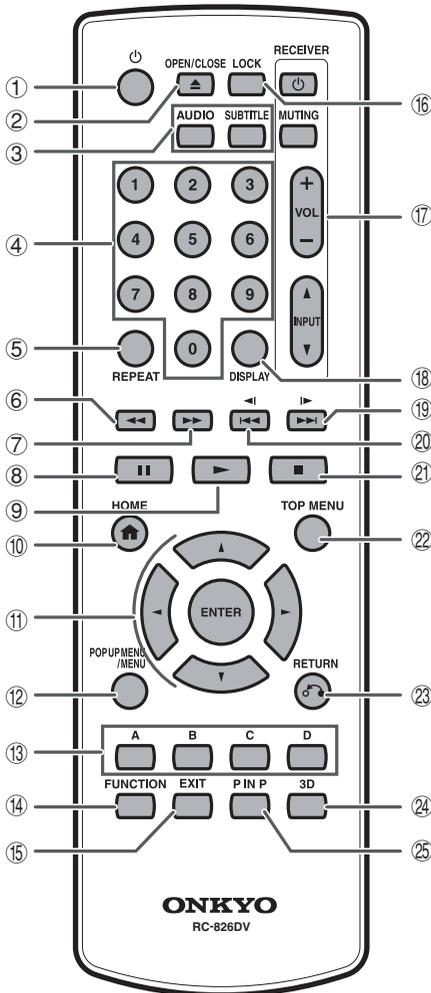

- ① ⏻ (on/standby) (p.20)
- ② ▲ OPEN/CLOSE (p.22)
- ③ AUDIO (p.35), SUBTITLE (p.35)
- ④ Number buttons (p.38)
- ⑤ REPEAT (p.34)
- ⑥ ⏮ (rewind) (p.33)
- ⑦ ⏭ (forward) (p.33)
- ⑧ ⏸ (pause) (p.33)
- ⑨ ▶ (play) (p.22)
- ⑩ HOME (p.20)
- ⑪ Cursor buttons (▲ / ▼ / ◀ / ▶), ENTER (p.39)
- ⑫ POP UP MENU/MENU (p.24)
- ⑬ A (Red), B (Green), C (Yellow), D (Blue) (p.25)
- ⑭ FUNCTION (p.37)
- ⑮ EXIT (p.39)
- ⑯ LOCK (See below)
- ⑰ RECEIVER control buttons (p.21)
Be sure to set the "Remote ID" setting to "1" on Onkyo AV receiver.
- ⑱ DISPLAY (p.23)
- ⑲ ▶ / ⏭ (slow/skip) (p.33)
- ⑳ ◀ / ⏮ (slow/skip) (p.33)
- ㉑ ■ (stop) (p.22)
- ㉒ TOP MENU (p.23)
- ㉓ ↶ RETURN (p.28)
- ㉔ 3D (p.21)
- ㉕ P IN P (picture in picture) (p.24)

Keylock function

You can set the keylock to prevent accidental operations.

Press and hold **LOCK** for more than 2 seconds.

- Each time you perform this operation, the function is activated or deactivated.
- If you try to operate the Player while the keylock function is set, "Hold" blinks on the front display panel to indicate that the keylock function is set.

Hold

Connecting to a TV/projector

You can enjoy high quality digital picture and sound using an HDMI cable. (Only TVs/projectors with an HDMI terminal can be connected to this player.)

Make sure to use a certified HDMI cable.

1. Be sure to turn off this Player and the TV/projector before making any connections.
2. Firmly connect an HDMI cable (commercially available) to the HDMI OUT terminal on the player (①) and the HDMI IN terminal of the TV/projector (②).

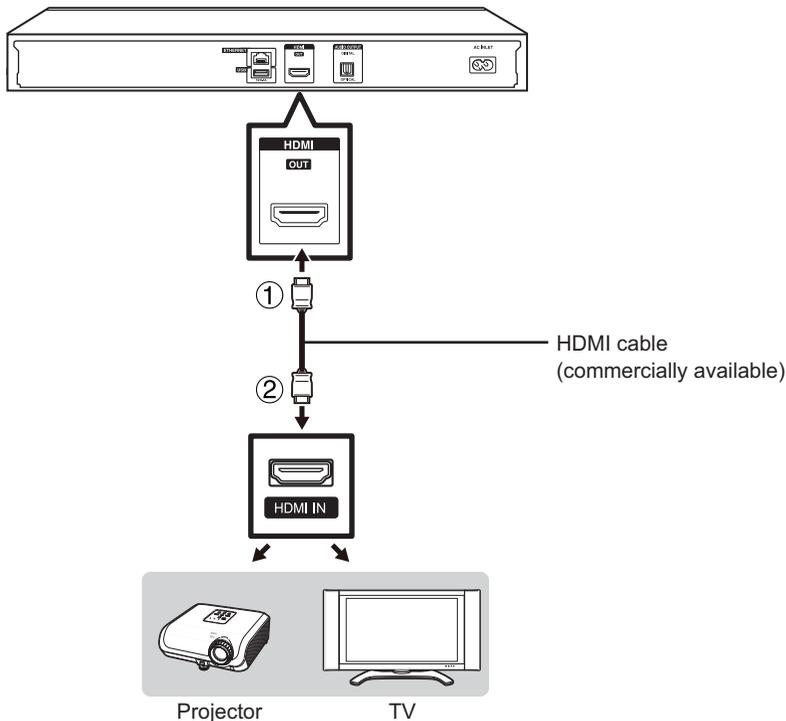

NOTE

- In this player, "HDMI Video Out" is set to "Auto" as a default (see page 40). (Normally set to "Auto".) If you don't get a stable image with "HDMI Video Out" set to "Auto", select the output resolution which corresponds to the connected equipment.
- To enjoy 3D images, connection to a 3D compatible TV is needed.
- For connection to a TV/projector, refer to the TV/projector's operation manual.

■ After connecting

- If desired, connect audio equipment. (Page 17)
- If necessary, perform the Audio Video Settings. (Page 40)
- Prepare the desired disc or content and start playback. (Page 22)

Connecting to an amplifier/AV receiver

You can connect this player to an amplifier/AV receiver to enjoy digital surround sound. With this player, the audio connection can be made using either one of the following methods depending on the capabilities of the amplifier/AV receiver you connect.

- HDMI connection
- Digital audio connection

NOTE

- Be sure to turn off this Player and the equipment before making any connections.
- For details on output of audio formats, see page 49.

HDMI connection

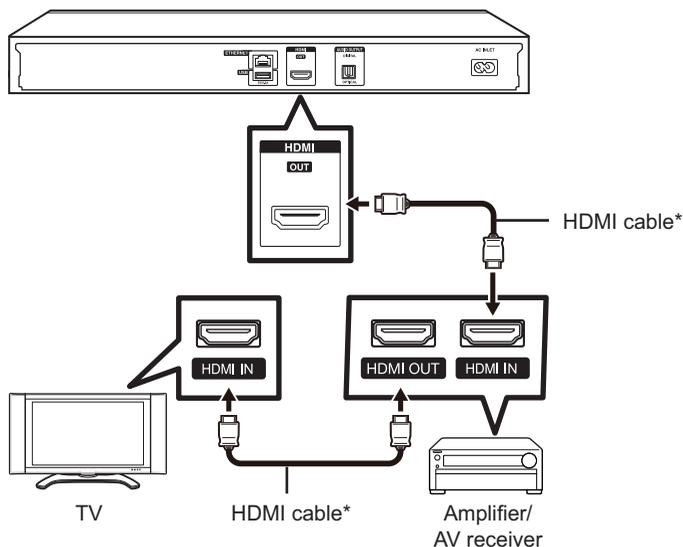

* Commercially available

NOTE

- When using an HDMI output, 7.1ch Digital Output is available.
- Audio transmitted in DTS-HD High Resolution Audio and DTS-HD Master Audio formats is output from the HDMI terminal as Bitstream. Connect an amplifier with a built-in decoder to enjoy the fine sound quality.
- When a connection to a 3D TV is made via an amplifier/AV receiver, it is necessary to connect to a 3D compatible amplifier/AV receiver. If the amplifier/AV receiver is not 3D compatible, connect the HDMI cable to the TV directly while connecting the player and the amplifier/AV receiver using an optical digital cable.

Digital audio connection

You can connect an amplifier/AV receiver using an optical digital audio cable (commercially available).

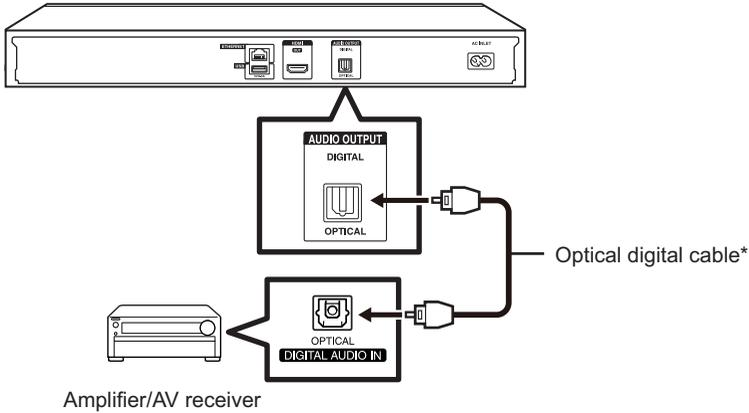

* Commercially available

NOTE

- When using OPTICAL DIGITAL AUDIO OUT, 5.1ch Digital Output is available. (7.1ch Digital Output is not available.)

■ After connecting

- If necessary, perform the Audio Video Settings. (Page 40)
- Prepare the desired disc or content and start playback. (Page 22)

Broadband Internet Connection

By connecting this player to the Internet, you can enjoy a variety of content on your TV using BD-LIVE functions, home networks and also perform software updates. In this player, the Internet connection can be made using the following methods.

NOTE

- Be sure to turn off this Player and the equipment before making any connections.

CAUTION

- When using a broadband Internet connection, a contract with an Internet service provider is required. For more details, contact your nearest Internet service provider.
- Refer to the operation manual of the equipment you have as the connected equipment and connection method may differ depending on your Internet environment.

Wired connection (LAN cable)

Connect a LAN cable (commercially available) to the ETHERNET terminal of this player (①) and the LAN port of the broadband router (②).

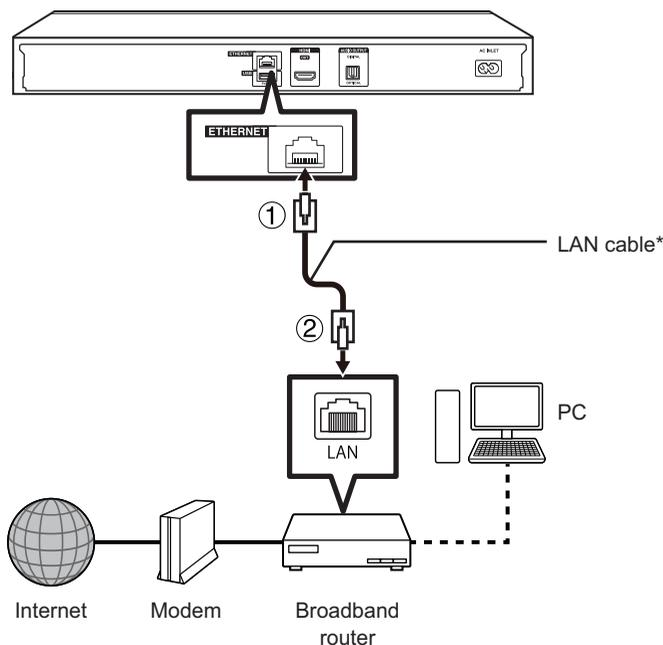

* Commercially available

NOTE

- Use a LAN cable/router supporting 10BASE-T/100BASE-TX.

■ After connecting

- Perform the communication settings. (Page 43)
- When enjoying BD-LIVE functions, see pages 25 and 42.
- To play back files via the Home Network, see page 31.
- To update the software via the Internet, perform Software Update Settings. (Page 45)

Before Starting Playback

Loading the Batteries in the Remote Control

- 1 Hold in the tab on the battery cover and pull the cover towards the direction of the arrow.

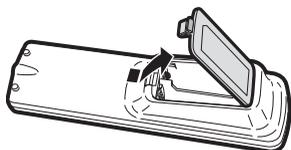

- 2 Load the two "AA" size batteries (R-06 size, UM/SUM-3). Place batteries with their terminals corresponding to the ⊕ and ⊖ indications in battery compartment.

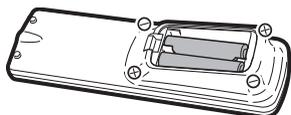

- 3 Insert the smaller tab of the battery cover into the opening 1, and press down on the cover until it clicks in place 2.

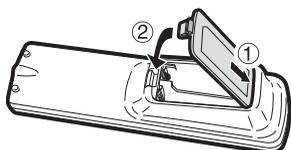

WARNING

- Do not use or store batteries in direct sunlight or other excessively hot place, such as inside a car or near a heater. This can cause batteries to leak, overheat, explode or catch fire. It can also reduce the life or performance of batteries.

NOTE

- Do not subject the remote control unit to shock, water or excessive humidity.
- The remote control unit may not function if the Player's remote sensor is in direct sunlight or any other strong light.
- Incorrect use of batteries may cause them to leak or burst. Read the battery warnings and use the batteries properly.
- Do not mix old and new batteries, or mix different brands.

- Remove the batteries if you will not use the remote control unit for an extended period of time.

Approximate operating range of remote control

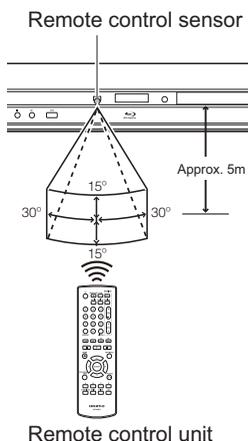

Connecting the Power Cord

Plug the supplied AC cord into the AC INLET terminal on the rear of the Player (①). Then plug into AC outlet (②).

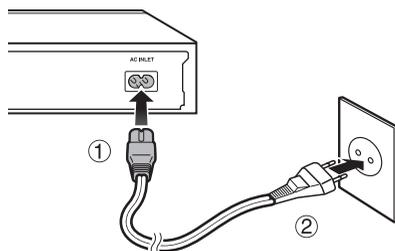

NOTE

- Place the Player close to the AC outlet, and keep the power plug within reach.
- TO PREVENT RISK OF ELECTRIC SHOCK, DO NOT TOUCH THE UN-INSULATED PARTS OF ANY CABLES WHILE THE AC CORD IS CONNECTED.
- If you are not going to use this Player for a long period of time, be sure to remove the AC cord from the AC outlet.

Turning the Power On

After all of the necessary connections are complete, Turn on your TV and switch to the appropriate AV input (Refer to your TV's operation manual). (This may be labeled HDMI/EXT/AUX etc.)

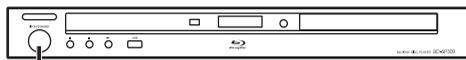
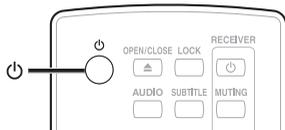

ON/STANDBY

Turning the power on

Press  on the remote control or on the Player to turn on the power of the Player.



NOTE

- When you turn on this player for the first time after purchase or when you turn on this player after you perform "System Reset" (see page 42), the language setting screen will be displayed, so please perform the language setting.

Entering standby

Press  on the remote control or on the Player to enter standby.

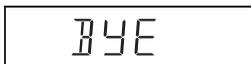

- If you press  again immediately after entering standby, the Player may not turn on. If this happens, wait for 10 seconds or more and then turn on the power again.

About the Home screen

When turning on the player, the Home screen appears.

Home screen

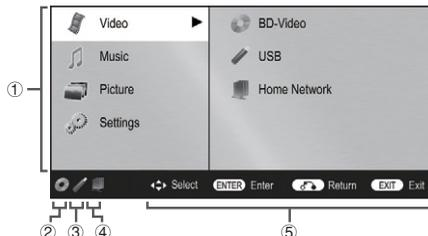

- 1 Main menu
- 2 Icon for disc inserted
- 3 Icon for USB memory device connected
- 4 Icon for LAN connection
- 5 Button Guide

Language Setting

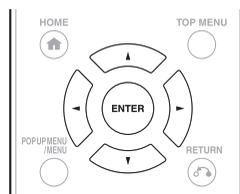

- 1 Press  /  to select "Settings", then press  or ENTER.

- 2 Press  /  to select "On Screen Language", then press  or ENTER.

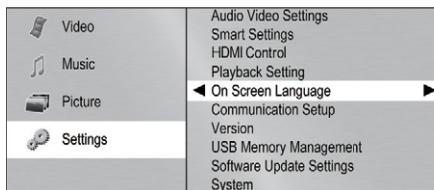

- 3 Press  /  to select the language you want to display on the screen, then press ENTER.

English	Nederlands	Česky
Deutsch	Svenska	Magyar
Français	Dansk	Slovensky
Italiano	Norsk	Slovenščina
Español	Suomi	
Português	Polski	

NOTE:

- When you turn on this player for the first time after purchase, the language setting screen will be displayed.
- To select the DVD disc language, such as subtitle language, etc., see page 23.

Operating ONKYO AV Receiver Using the Remote Control

The Universal Remote Control may operate the basic functions of ONKYO AV Receiver.

ONKYO AV Receiver

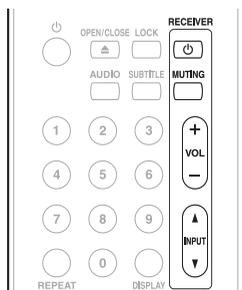

Button	Operation
	Turn the AV receiver on or off.
MUTING	Mutes or unmutes the AV receiver.
VOL +/-	Adjust the volume of the AV receiver.
INPUT ▲ / ▼	Switch the AV receiver's input source.

- Be sure to set the "Remote ID" setting to "1" on the AV receiver.
- Depending on the unit being connected, you may not be able to control your AV receiver using some of the buttons.

Using HDMI Control

■ Direct Change

When this player is turned on, the TV is also turned on and the appropriate external input channel will be selected automatically. The appropriate external input channel can also be selected on your TV automatically when you press ► when the player's power is on.

NOTE

- HDMI Control is available only when the TV is connected by an HDMI cable, and when it supports HDMI Control feature.
- Depending on the connected TV, HDMI Control may not be performed correctly.
- Onkyo does not guarantee 100% interoperability with other brands of HDMI Control compliant devices.

Using 3D

This sets output of 3D images.

To view 3D images, playback of 3D content (3D BD video) is necessary with a 3D compatible TV and 3D glasses in addition to this player.



Press **3D** to change to the 3D mode.

- Each time the button is pressed, the mode switches between "Auto (3D)" and "2D".
- The status of the selected mode will be displayed on the TV screen.

Auto: Video signals are output as 3D when 3D content (3D BD video) is played or as 2D when 2D content is played.

2D: Even if 3D content (3D BD video) is played, video signals are output as 2D at all times.

- This setting (Auto (3D)/2D) can also be performed using the menu screen (see page 42).

NOTE

- The 3D mode can be switched only when playback is stopped.
- Depending on the connected TV, the images during playback may switch to 2D images due to changes in the resolution, etc. Make sure the 3D image setting is performed on the TV.
- The 3D images may not be output as set in "HDMI Video Out".
- When performing Fast Forward/Reverse, images are shown in 2D.

CAUTION

- When viewing 3D images, viewing for a long period of time or lying on your back may cause eye strain and discomfort. In addition, 3D images may affect the eyesight of young children/infants, so keep them from viewing the images.

Video/Picture/Music Playback

Loading a Disc

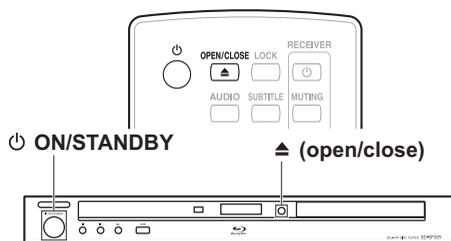

1 Press **⏻** on the remote control or on the Player to turn on the power.

2 Press **OPEN/CLOSE** to open the disc tray.

3 Load a disc on the disc tray.

- Insert the disc with the label face up.
- In case of disc recorded on both sides, face down the side to play back.

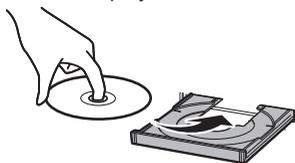

4 Press **OPEN/CLOSE** to close the disc tray.

1 Load a disc.

- Playback may begin automatically, depending on the disc.
- Playback begins from the first title.
- The menu may be displayed first, depending on the disc. Perform playback operation by following the directions on the screen.
- When loading a disc containing 3D content (3D BD video) with “Yes” selected in the “3D Notice” setting (Page 42), playback will be stopped and the 3D notice will be displayed on the TV screen. In such cases, press **ENTER** for confirmation, and then playback will start.

2 Press **▶** if playback does not begin automatically or playback is stopped.

NOTE

- The disc load time may vary depending on the disc.

Regarding playback of BD video discs

- Some of the newly released BD video discs cannot be played back unless you update the player software to the latest version. Therefore, it may be required to update the software of the player.
- Refer to page 45 for more information regarding software updates for the player.

BD/DVD Video Playback

BD VIDEO **BD-RE** **BD-R**

DVD VIDEO **DVD-R** **DVD-RW**

This section explains playback of commercially available BD Video and DVD Video discs (like movies) and recorded DVD-RW/R discs.

- This player supports DVD upscaling during DVD playback.
- For a description of other playback functions, refer to “Playback Functions” on page 33.

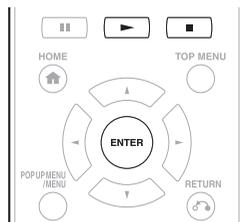

To stop playback

Press **■**.

■ Resume playback function

- If you press **▶** next, playback will resume from the point where the Player was previously stopped. To playback from the beginning, cancel resume mode by pressing **■**, then press **▶**. (This may not work depending on the type of disc. In this case, open the disc tray or enter standby.)

NOTE

- Resume playback may not function depending on the disc.

Displaying the disc information

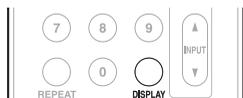

Press **DISPLAY** during playback.

- Each time you press **DISPLAY**, the display switches as follows.

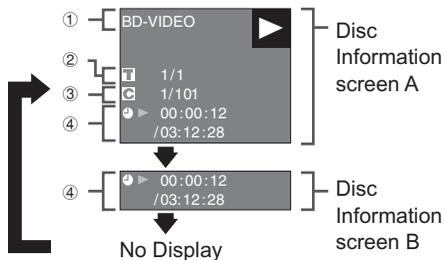

- 1 **Type of disc**
- 2 **Title number being played / Total number of Titles**
- 3 **Chapter number being played / Total number of Chapters**
- 4 **Elapsed playback time / Total playback time for the Title**

NOTE

- Disc Information Screen A disappears after about 1 minute elapses without performing any operations.
- For some commercially-released BD VIDEO discs, the total playback time display for the Chapter/Title may not appear.

BD/DVD Menus

- This section explains how to play back a BD/DVD video disc with a top menu, disc menu or pop-up menu.
- The titles listed in the top menu and a disc guide (for options like subtitles and audio languages) are given in the disc menu.

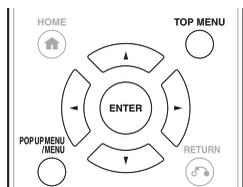

Start playback by selecting a title from the top menu

BD VIDEO DVD VIDEO

1 Press TOP MENU.

- The top menu screen is displayed if present on the BD/DVD video disc.

Example

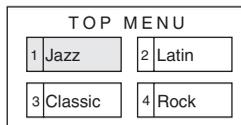

2 Press ▲ / ▼ / ◀ / ▶ to select the title, then press ENTER.

- The selected title is played back.

NOTE

- If no top menu is available, the **TOP MENU** button will have no effect.

Using the disc menu

DVD VIDEO

Example: Select "SUBTITLE LANGUAGE".

1 Press POP UP MENU/MENU.

- The disc menu screen is displayed if present on the DVD video disc.

2 Press ▲ / ▼ to select "SUBTITLE LANGUAGE", then press ENTER.

- The screen for selecting the subtitle language is displayed.

Example

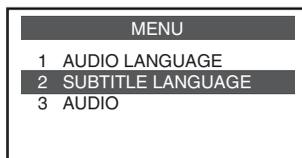

3 Press ▲ / ▼ to select the subtitle language, then press ENTER.

4 Press POP UP MENU/MENU to exit.

Using the pop-up menu

BD VIDEO

- 1 Press POP UP MENU/MENU during playback.**
 - The pop up menu screen is displayed.
 - The menu contents displayed vary depending on the disc. For details on how to see and operate the pop up menu, refer to the manual for the disc.

Example

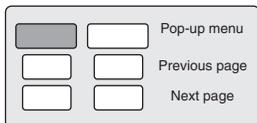

- 2 Press ▲/▼/◀/▶ to select the desired item, then press ENTER.**

- 3 Press POP UP MENU/MENU to exit.**
 - The pop up menu will automatically disappear for some discs.

- If the USB memory device is disconnected from this player during playback of Virtual Package/BD-LIVE data, playback of the disc will stop.
- Some time may be required for the data to load (read/ write).
- Refer to "USB Memory Management" on page 44 for erasing the Virtual Package data and the BD-LIVE data in the USB memory device.

NOTE

- Some USB memory devices may not work with this player.
- Only USB memory devices formatted with FAT32/16 are compatible. When formatting a USB memory device using a PC, perform the following settings.
 - Format File System: FAT32
 - Allocation Unit Size: Default Allocation Size
- Do not use a USB extension cable when connecting a USB memory device to the USB terminal of the player.
 - Using a USB extension cable may prevent the player from performing correctly.

Enjoying BONUSVIEW or BD-LIVE

BD VIDEO

This Player is compatible with additional functions of BD-Video, BONUSVIEW (BD-ROM Profile 1 Version 1.1) and BD-LIVE.

For BD-Video discs compatible with BONUSVIEW, the functions of Picture in Picture and Virtual Package are available. For BD-LIVE compatible discs, you can enjoy a variety of functions via the Internet in addition to the BONUSVIEW functions.

Virtual Package/BD-LIVE data is saved in Local Storage (USB memory device connected to this Player). To enjoy these functions, connect a USB memory device (2 GB or greater) supporting USB 2.0 High Speed (480 Mbit/s) to the USB (rear) or USB (front) terminal on this player.

NOTE

- A USB memory device can be used with either the USB (front) or USB (rear) terminal. When two USB memory devices are connected to both terminals at the same time, in certain situations the USB (rear) terminal may give priority to Local Storage and the USB (front) terminal cannot be used for Local Storage.
- If there is insufficient storage space, the data will not be copied/downloaded. Delete unneeded data or use a new USB memory device.
- If a USB memory device containing other data (previously recorded) is used, the video and audio may not play back properly.

Use of Picture in Picture function (secondary audio/video playback)

BD-Video that includes secondary audio and video compatible with Picture in Picture can be played back with secondary audio and video simultaneously as a small video in the corner.



- 1 Press P IN P during playback to show the 2-picture screen.**



Primary audio/video

Secondary audio/video

- 2 To remove the secondary video, press P IN P again.**

NOTE

- To listen to secondary audio, make sure that "Secondary Audio" is set to "On". (see page 40)
- The secondary audio and video for Picture In Picture may automatically play back and be removed depending on the content. Also, playable areas may be restricted.

Virtual Package

For BD-Video discs compatible with Virtual Package, data is copied from the discs or Internet to local storage. It is automatically copied to the local storage prior to playback. You can enjoy a variety of additional functions including secondary video, secondary audio, subtitles, movie trailers, etc.

- The playback methods vary depending on the disc. For details, refer to the disc manual.

BD-LIVE

In this Player, a variety of contents with interactive functions are available through BD-LIVE compatible Blu-ray discs by connecting to the Internet. You can enjoy the download of bonus features such as latest movie trailers to the USB memory device, communication compatible BD-J interactive games, etc.

- The available functions differ depending on the disc.

NOTE

- Regarding playback method of BD-LIVE contents, etc., perform the operations in accordance with the instructions in the BD disc manual.
- To enjoy BD-LIVE functions, perform the broadband Internet connection (Page 18) and communication settings (Page 43).
- Refer to page 42 regarding the setup to restrict access to BD-LIVE contents.
- If the BD-LIVE screen does not appear for a while after you select the BD-LIVE function in the BD disc menu, the USB memory device may not have enough free space. In such cases, eject the disc from the player, and then erase the data in the USB memory device in the “USB Memory Management” menu on page 44.

DVD-R/-RW (VR format) / BD-RE/-R (BD-DAV format) Playback

DVD-R DVD-RW BD-RE BD-R

You can play back a recorded disc (DVD: VR format finalised disc only / BD: BDAV format disc only).

- For a description of other playback functions, refer to “Playback Functions” on page 33.

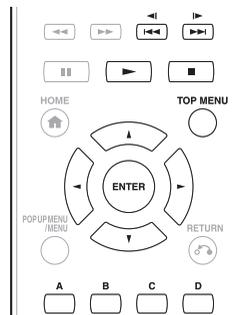

NOTE

- “Finalise” refers to a recorder processing a recorded disc so that it will play in other DVD players/recorders as well as this player. Only finalised DVD discs will play back in this player. (This player does not have a function to finalise discs.)
- Some discs cannot be played back depending on the audio format.
- BD-RE/-R discs recorded from a BD recorder comply with AACS copyright protection technology. As this player is not intended to be compliant with AACS, such discs cannot be played back. (AACS: Advanced Access Content System)

Playback by selecting a title

1 Load a recorded disc.

- The Title List screen is displayed.

Example: Thumbnail screen

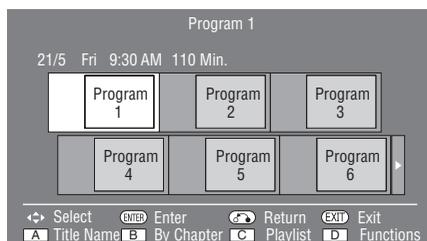

- If the Title List screen is not displayed, press **TOP MENU**.
- When loading a BD disc with usage restrictions placed by a BD recorder, the password input screen appears. Then, input your password. If you input a wrong password three times, the disc tray will open. Close the disc tray, and then input a correct password.

2 Press **▲/▼/◀/▶** to select the desired title, then press **ENTER** to start playback.

- If you want to select additional titles, switch pages by pressing **◀/|◀◀** or **▶/▶▶**.
- You can playback by pressing **▶** instead of pressing **ENTER**.

3 Press **■** to stop playback.

NOTE

- The Title List screen also can be displayed by pressing **TOP MENU** when playback is stopped.

About Title List

- The Title List can be displayed in two types, Thumbnail and Title Name.
- Each time you press **A** (Red), the screen changes between Thumbnail and Title Name.

Thumbnail

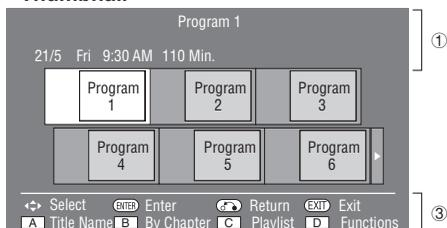

Title Name

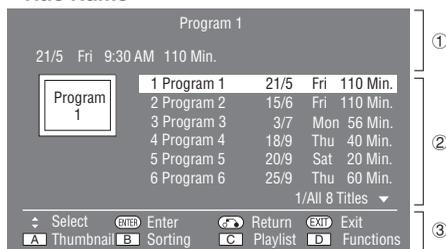

① Information of selected title

② Title Name

Recording Date

Recording Duration

③ Button Guide

Playback by selecting a chapter

1 Press **B** (Green) while the Thumbnail screen is displayed.

- The chapter screen is displayed.

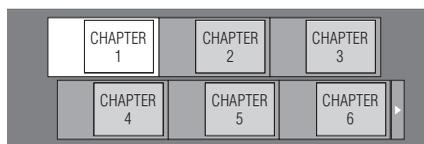

- If you want to select additional chapters, switch pages by pressing **◀/|◀◀** or **▶/▶▶**.
- To return to the Thumbnail screen, press **B** (Green).

2 Press **▲/▼/◀/▶** to select the desired chapter, then press **ENTER** to start playback.

- You can playback by pressing **▶** instead of pressing **ENTER**.

3 Press **■** to stop playback.

Sorting the titles

Each time you press **B** (Green) while the Title Name screen is displayed, the Title Name display changes between displaying the newest title first and the oldest title first.

Playback by selecting a Playlist

1 Press **C** (Yellow) while the Title List screen is displayed.

- The Playlist screen is displayed.

Example: Thumbnail screen

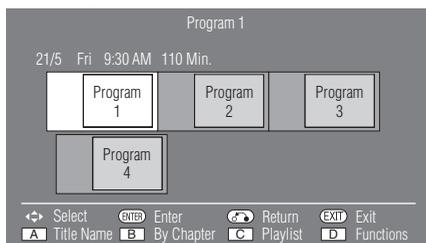

2 Press **▲/▼/◀/▶** to select the desired title, then press **ENTER** to start playback.

3 Press **■** to stop playback.

Playback from the beginning or resume playback

When you play back the title from the Title List after you stopped playback, you can select playback from the beginning or from the point where it was last stopped.

1 Press **D** (Blue) when the desired title is selected while the Title List screen is displayed.

2 Press **▲/▼** to select the type of Playback, then press **ENTER** to start playback.

- The type of Playback may be selected from "From Beginning" or "From Continued".

3 Press **■** to stop playback.

Audio CD Playback

AUDIO CD

This Player can play back audio CDs.

- For a description of other playback functions, refer to "Playback Functions" on page 33.

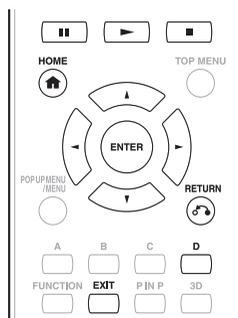

Playback from the beginning

1 Load an audio CD.

- The CD screen is displayed. (The CD screen is displayed only when a compact disc recorded in the CD-DA format is inserted.)
- Playback may begin automatically, depending on the disc.

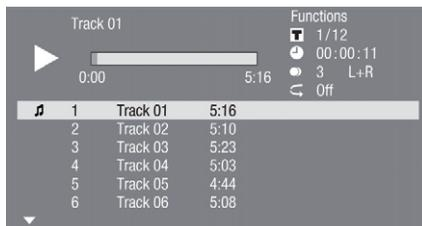

2 Press **▶** if playback does not begin automatically or playback is stopped.

3 To pause the playback at any time, press **■**.

- Press **■** or **▶** to return to playback.

4 Press **■** to stop playback.

5 To return to the HOME screen, press **■** again, and then press **HOME** or **EXIT**.

Playback by selecting a track

- 1 Press **▲ / ▼** to select the track, then press **ENTER** during playback or when playback is stopped.

- Playback of the selected track will begin.

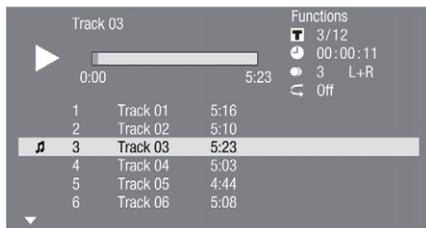

- 2 Press **■** to stop playback.

Operation procedure for the “Functions” menu

- 1 Press **D (Blue) (Functions)** when the CD screen is displayed.

- The “Functions” menu is activated.

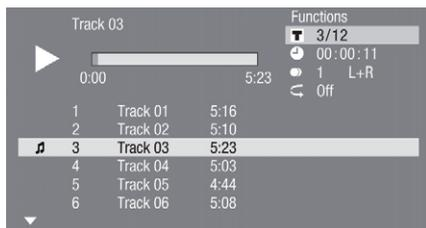

- 2 Press **▲ / ▼** to select the desired setting, then press **ENTER**.

- When playback is stopped, only “Track” can be selected.
- For a description of each setting, see “Functions which can be set” (Page 38).

- 3 Press **▲ / ▼ / ◀ / ▶** to set, then press **ENTER**.

- Operations vary depending on the setting. Follow the operation instructions on the screen.

- 4 Press **↻ RETURN** or **D (Blue)** to exit the “Functions” menu.

NOTE

- The displayed items vary depending on the disc.

Audio Data (MP3 File) Playback

CD-R **CD-RW** **DVD-R** **DVD-RW** **USB**

This Player can play back audio data (MP3 files) recorded on CD-R/RW discs, DVD-R/RW discs and USB memory devices or via a home network.

- For details on the audio data that you can play using this player, refer to page 9.
- When data in the USB memory device is played back, playback from the USB memory device will stop when **OPEN/CLOSE** on the remote control or the player is pressed or when a disc is inserted into the player.

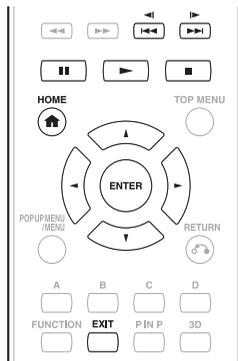

- 1 Load a disc or insert a USB memory device* containing audio data (MP3 files).

* When you insert or remove a USB memory device, be sure to turn the main power off.

Note

- A USB memory device can be used with either the USB (front) or USB (rear) terminal. When two USB memory devices are connected to both terminals, use the USB (front) terminal for playback video/music/picture files.
- This player is not compatible with NTFS formatted USB memory device. Be sure to use FAT16 or FAT32 formatted USB memory device.

- 2 Press **▲ / ▼** to select “Music”, then press **▶** or **ENTER**.

- 3 Press **▲ / ▼** to select “DISC”*, “USB” or “Home Network”, then press **▶** or **ENTER**.

* Display name varies depending on the type of media inserted.

Displaying Still Images (JPEG files)

CD-R CD-RW DVD-R DVD-RW USB

This Player can display still images (JPEG files) recorded on CD-R/RW discs, DVD-R/RW discs and USB memory devices or via a home network.

- For details on the still images that you can display using this player, refer to page 9.
- Still images are played one by one while during “Slide show”, they are automatically replaced one after another.
- When data in the USB memory device is played back, playback from the USB memory device will stop when **OPEN/CLOSE** on the remote control or the player is pressed or when a disc is inserted into the player.

4 Press ▲/▼ to select a folder or file.

- When you select a folder, press **ENTER** to open it, and then press ▲/▼ to select a file in the folder.

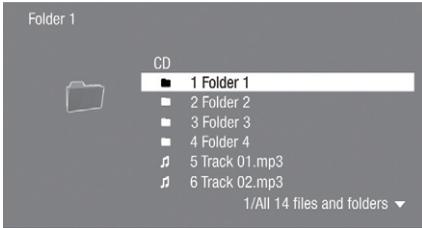

5 Press **ENTER** to play back the selected file.

- Playback of the selected file will begin.

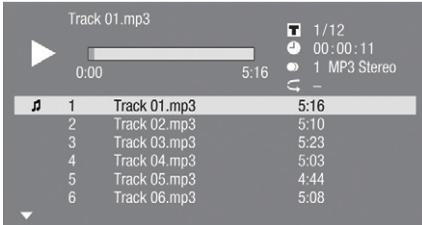

- When MP3 files are played, the “Functions” menu is not available.

6 To return to the HOME screen, press ■ (press twice if during playback), and then press HOME or EXIT.

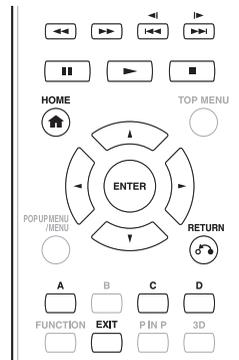

List of available buttons during playback

Buttons	Description
▲ / ▼	Select a desired audio file.
ENTER	Play back audio file.
⏸	Pause audio file playback. • Return to playback when paused.
⏮ / ⏪	Skip backward.
⏩ / ⏭	Skip forward.
■	Stop playback.

NOTE

- The Fast Forward/Reverse function does not work.
- The Repeat function does not work.

1 Load a disc or insert a USB memory device* containing audio data (JPEG files).

* When you insert or remove a USB memory device, be sure to turn the main power off.

Note

- A USB memory device can be used with either the USB (front) or USB (rear) terminal. When two USB memory devices are connected to both terminals, use the USB (front) terminal for playback video/music/picture files.
- This player is not compatible with NTFS formatted USB memory device. Be sure to use FAT16 or FAT32 formatted USB memory device.

2 Press ▲/▼ to select “Picture”, then press ► or **ENTER**.

3 Press ▲/▼ to select “DISC”, “USB” or “Home Network”, then press ► or **ENTER**.

* Display name varies depending on the type of media inserted.

4 Press ▲ / ▼ to select a folder or file.

- When you select a folder, press **ENTER** to open it, and then press ▲ / ▼ to select a file in the folder.



- To set slide show speed/repeat playback, press **D** (Blue) (Slide Show Menu).

Slide Show Menu

Slide Show Speed	Setting of slide show playback speed
Repeat Mode Setting	Setting of slide show repeat playback
Guide Display Setting	Guide display setting during still image display

5 Press **ENTER** to display the selected file.

- The selected still image appears on the screen.



6 To return to the HOME screen, press ■ again, and then press HOME or EXIT.

Operational buttons during still image display

Buttons	Description
◀ / ◀◀/ ▶/▶▶	Go to the previous/next picture in the same directory.
◀◀/▶▶	
↶ RETURN	Return to the selection screen.
C (Yellow)	Rotate the picture by 90 degrees to the left.
D (Blue)	Rotate the picture by 90 degrees to the right.
▶	Play back Slide Show. • Return to slide show playback when paused.
⏸	Pause slide show playback.
■	Stop still image display/slide show playback.
A (Red)	Guide display on/off

NOTE

- Thumbnail data will be displayed when JPEG files from a digital camera contain thumbnail data.
- An icon will be displayed for JPEG files which do not contain thumbnail data.

Accessing UPnP* servers

The player can browse and play movies, music and photos stored on your UPnP compatible media servers connected within your home network.

* UPnP: Universal Plug and Play

■ About a home network

This Player can display and play movies, photos and music content from your UPnP compatible digital media servers (such as a PC and consumer electronics).

■ Before accessing UPnP compatible media servers:

- UPnP compatible media servers and this player must be connected to the same local area network. Specify the settings required for connecting this player to the local area network.
- UPnP compatible media servers must be turned on.
- When a PC running UPnP compatible media server software or other UPnP compatible devices are connected to this player, some setting changes of software or other devices may be required.
- Please refer to the operating instructions for the software or devices for more information.

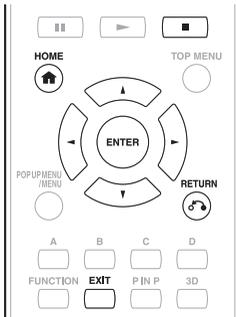

■ Types of playable files

Video	DivX Plus HD (avi/divx/mkv)
Music	mp3
Picture	jpg

NOTE

- Even if UPnP compatible, a connection may not be able to be made depending on the server, or playback may not be available even if a connection is made successfully.
- Some files may not be playable depending on the file. For details, refer to page 8.
- To enjoy this function, make a broadband Internet connection to both your PC and this player (see page 18), and then set communication settings (see page 43), then perform the following operation.
- To use this function, we recommend setting "Auto Power Off" to "No". (see page 41)

Playback by selecting a file list

1 Press **▲/▼** to select Video/Music/Picture, then press **▶** or **ENTER**.

2 Press **▲/▼** to select “Home Network” in the sub window.

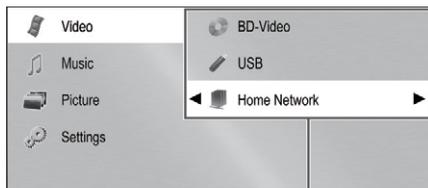

Sub Window

3 Press **ENTER** or **▶**.

- The player automatically scans and displays UPnP servers within your local network.

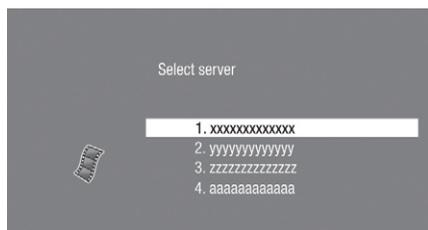

4 Press **▲/▼** to select a UPnP server which you want to access, then press **ENTER** or **▶**.

- The folder list or file list of the UPnP server which you accessed is displayed.
- The previous screen appears when **RETURN** is pressed.

5 Press **▲/▼** to select the folder or file which you want to access, then press **ENTER**.

- When you select a folder, the file list of the folder is displayed. Press **▲/▼** to select the file which you want to play, then press **ENTER**.
- Playback starts.

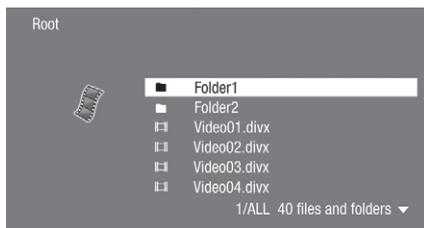

- For operation during playback, refer to page 33.

6 Press **■** to stop playback.

- The file list reappears.
- The previous screen appears when **RETURN** is pressed.

7 Press **EXIT** or **HOME** to exit playback.

- The Home screen reappears.

Playback Functions

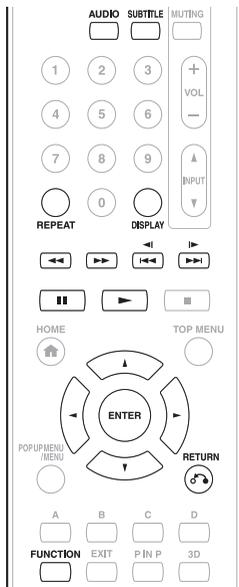

NOTE

- Some operations in the following playback functions cannot be performed depending on the specifications of the disc.

Fast Forward/Reverse (Search)

BD VIDEO **BD-R** **BD-RE** **DVD VIDEO** **DVD-R**
DVD-RW **AUDIO CD**

The Fast Forward/Reverse function is enabled when **◀◀** or **▶▶** is pressed during playback.

Example: When **▶▶** is pressed

- The search speed will change each time you press the button.

When playing back a DVD

- You cannot perform Fast Forward/Fast Reverse from one title and continue to another title (except when playing audio CDs). At the end or beginning of the title, Fast Forward/Fast Reverse will be cancelled and normal playback will automatically resume.

NOTE

- Subtitles are not played back with BD/DVD video discs during Fast Forward and Fast Reverse.

Skipping to the Next or the Start of the Current Chapter (Track/Title)

BD VIDEO **BD-R** **BD-RE** **DVD VIDEO** **DVD-R**
DVD-RW **AUDIO CD** **CD-R** **CD-RW** **USB**

The Skipping (to the beginning of a chapter, track or title) function is enabled when **◀|**/**◀◀** or **▶|**/**▶▶** is pressed during playback.

Pause/Frame Advance Playback

BD VIDEO **BD-R** **BD-RE** **DVD VIDEO** **DVD-R**
DVD-RW

The Pause function is enabled when **⏸** is pressed during playback. (If you are playing back an audio CD, audio data [MP3 files] or still images [JPEG files], these will also pause.)

The Frame Advance Playback function is enabled when **▶|**/**▶▶** is pressed during pause.

- Frame Advance Playback may not function properly with discs other than DVD-RW/R (VR format).

NOTE

- Some BD/DVD Video discs are not compatible with Pause/Frame Advance Playback.
- Frame Advance/Reverse Playback can be performed for DVD discs by pressing **◀|**/**◀◀** or **▶|**/**▶▶** during pause.
- Frame Reverse Playback cannot be performed for DivX video.

Slow Playback (Forward/Reverse)

BD VIDEO | BD-R | BD-RE | DVD VIDEO | DVD-R
DVD-RW

The Slow Playback (Forward/Reverse) function is enabled when ◀|/|◀◀ or ▶|/|▶▶ is pressed for more than 2 seconds during pause. Press ▶ to return to normal playback.

NOTE

- This doesn't work for audio CDs.
- You cannot perform Slow Playback between titles. At the end of the title, Slow Playback will be cancelled and normal playback will automatically resume.
- Reverse Slow Playback cannot be performed for BD video and DVD discs in AVCHD format.
- Reverse Slow Playback cannot be performed for DivX video.

Repeat Playback of a Title or Chapter (Repeat Playback)

BD VIDEO | BD-R | BD-RE | DVD VIDEO | DVD-R
DVD-RW | AUDIO CD

1 Play back the title or chapter you want to repeat.

2 Press REPEAT.

3 Press ▲/▼ to select the type of Repeat Playback.

- Playback Title: Repeats the title currently being played back.
- Playback Chapter: Repeats the chapter currently being played back.
- Scene Selection: Repeats the specified scene of title or chapter.

Playback Title

Playback Chapter

Scene Selection

NOTE

- Press ⏪ RETURN to cancel without setting the type of Repeat Playback.
- For Audio CD, you can select "Playing Disc", "Playing Track" and "Specify The Part" as Repeat Playback options.
- Repeat Playback cannot be performed for DivX video.

4 Press ENTER.

Example: Repeat playback of a title (TITLE)

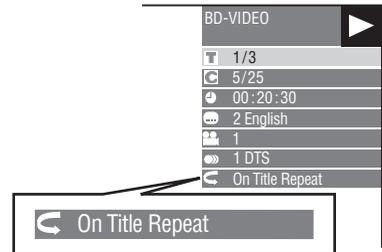

5 Press REPEAT to return to normal playback.

NOTE

- "Scene Selection" operation is not available for BD video.

Partial Repeat Playback (Repeat Playback of a Specified Part)

DVD VIDEO DVD-R DVD-RW AUDIO CD

- 1 Press **REPEAT** during playback.
- 2 Press **▲/▼** to select “Scene Selection”, then press **ENTER**.
 - “Set Start Point” displays.

Playback Title	
Playback Chapter	
Scene Selection	Set Start Point
- 3 Press **ENTER** at the scene where you want to set the start point.
 - “Set End Point” displays.
- 4 Press **ENTER** at the scene where you want to set the end point.
 - You can press **▶▶** to fast forward to the scene where you want to set the end point. When you reach the desired scene, simply press **▶** and then **ENTER** to set the end point. To cancel Repeat Playback, press **REPEAT**.

NOTE

- Press **▶/▶▶**, the Repeat Playback is cancelled and the next chapter being play back.
- Press **◀/◀◀** once, the Repeat Playback is cancelled and the player returns to the start of current chapter (track).
- If you press **◀/◀◀** again (within about 5 seconds) the player will skip to the beginning of the previous chapter (track).
- For Partial Repeat Playback, set the start and end points within the same title.
- Repeat Playback may be forbidden depending on the disc.
- Partial Repeat Playback may not work in multi-angle scenes.
- If you press **DISPLAY**, you can confirm the Repeat Playback status.

Displaying the Audio Information

You can display the audio information on the disc currently being played back by pressing **AUDIO**. The displayed contents vary depending on the disc.

BD VIDEO DVD VIDEO

The audio channel currently being played back will be displayed.

If multiple audio channels are recorded, you can switch the audio channel by pressing **AUDIO**.

DVD-RW DVD-R

When a recorded broadcast with stereo or monaural audio is played back:

“Stereo” is displayed. (Audio cannot be switched.)

NOTE

- When you play a programme recorded in stereo or monaural, and if you are listening to the Bitstream sound via the digital output jack, you cannot select the audio channel. Set “Audio Out” to “PCM” (Page 40).
- Settings for audio can also be changed in the Function Control screen (Page 37).
- The operation of audio differs according to each disc. You may need to refer to the operation manual of the disc.
- The display for audio information automatically disappears after 5 seconds.

Switching Subtitles

BD VIDEO DVD VIDEO

If subtitles are provided in multiple languages, you can switch between them.

Press **SUBTITLE** during playback.

- The display indicates the subtitle number currently being played back, and the subtitles appear. Each time **SUBTITLE** is pressed, the subtitles change.
- “—” is displayed if a disc has no subtitles.
- You can also select “Off”.

NOTE

- Settings for subtitles can also be changed in the Function Control screen (Page 37).
- The operation of subtitles differs according to each disc. You may need to refer to the operation manual of the disc.
- The display for subtitle information automatically disappears after 5 seconds.

Switching the Angle

BD VIDEO DVD VIDEO

If multiple angles are recorded, you can switch between them.

- 1 Press FUNCTION during playback.**
 - The Function Control screen is displayed on the TV.

- 2 Press ▲ / ▼ to select the Angle Number column, then press ENTER.**

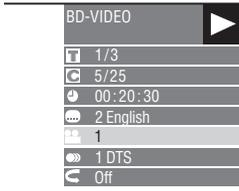

- 3 Press ▲ / ▼ to select the desired Angle Number, then press ENTER.**

- 4 Press ⏪ RETURN or FUNCTION to close the Function Control screen.**

NOTE

- The displayed items vary depending on the disc.
- If you access the Function Control screen during playback of a BD/DVD video, it may be impossible to operate the BD/DVD video playback. In cases like this, close the Function Control screen.
- The operation of angles differs according to each disc. You may need to refer to the operation manual of the disc.
- The display for angle information automatically disappears after 5 seconds.

Displaying the Angle Mark

BD VIDEO DVD VIDEO

You can change settings so that Angle Mark appears in the right bottom part of the screen when multiple angles are recorded. The settings can be changed in “Settings” – “Playback Setting” – “Angle Mark Display” (Page 41).

Settings During Playback

Function Control

BD VIDEO | BD-R | BD-RE | DVD VIDEO | DVD-R
DVD-RW | AUDIO CD

This allows you to adjust various settings at once, like subtitles, angle settings and the title selection for Direct Playback. You can adjust the video and audio to suit your preferences. The operations are the same for BD and DVD.

■ Function Control screen

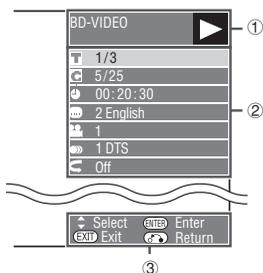

① Playback status display

Shows the operation status and the disc type.

② Setting items

Selects a title (or track) or chapter for playback, or performs video/audio settings.

- Title/Track Number (Direct Title/Track Skip)
- Chapter Number (Direct Chapter Skip)
- Playback Elapsed Time (Direct Time Skip)
- Subtitle Language
- Angle Number
- Audio
- Repeat

③ Operation guide display

Provides help on remote control button operations.

Function control operation procedure

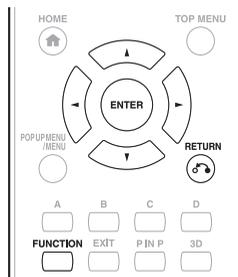

1 Press **FUNCTION** during playback.

- The Function Control screen is displayed on the TV.

2 Press **▲/▼** to select the desired setting, then press **ENTER**.

- For a description of each setting, see "Functions which can be set" (Page 38).



3 Press **▲/▼/◀/▶** to set, then press **ENTER**.

- Operations vary depending on the setting. Follow the operation instructions on the screen.

4 Press **↻ RETURN** or **FUNCTION** to close the Function Control screen.

NOTE

- If "—" is displayed for an option like title number or subtitles, the disc has no titles or subtitles which can be selected.
- The displayed items vary depending on the disc.
- If you access the Function Control screen during playback of a BD/DVD video, it may be impossible to operate the BD/DVD video playback. In cases like this, close the Function Control screen.

Functions which can be set

T Title/Track Number (Direct Title/Track Skip)

- Shows the title number being played back (or track number when playing back an audio CD). You can skip to the start of the title (or track).
- To skip to the start of a selected title (or track), press the **Number** buttons to enter the title (or track) number when this option is highlighted.

C Chapter Number (Direct Chapter Skip)

- Shows the chapter number being played back. You can skip to the start of the chapter.
- To skip to the start of a selected chapter, press the **Number** buttons to enter the chapter number when this option is highlighted.

⏱ Playback Elapsed Time (Direct Time Skip)

- Shows the time elapsed from the beginning of the current disc title (or track). This lets you skip to a specific time.
- Press **◀/▶** to select the Hour, Minute or Second, then press **▲/▼** or the **Number** buttons to set the time. Press **ENTER** to start playback at the set time.

⋮ Subtitle Language

- Shows the currently selected subtitle language. If subtitles are provided in other languages, you can switch to your preferred language.

📺 Angle Number

- Shows the currently selected angle number. If the video is recorded with multiple angles, you can switch the angle.

🔊 Audio

- Shows the currently selected type of audio. You can select the desired type of audio.

↺ Repeat

- The current Title (or Chapter) or partial segments can be repeatedly played back. Repeat Playback is also possible with the **REPEAT** button on the remote control.

NOTE

- These functions may not work with all discs.

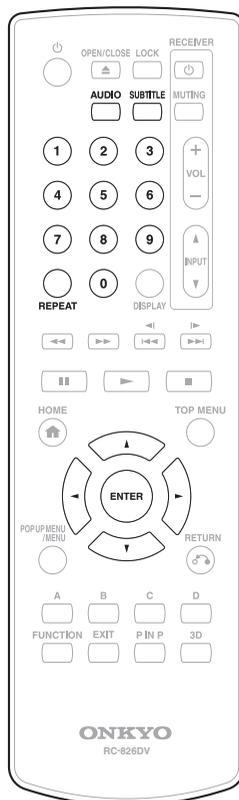

SETTINGS

Common operations

The "menu" enables various audio/visual settings and adjustments on the functions using the remote control unit. You need to call up the On Screen Display to perform settings for this player. The following is the explanation for the basic operations of the "menu".

Example: Setting "HDMI Control"

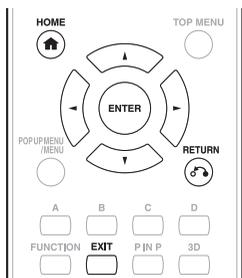

1 Home screen display

Press **▲/▼** to select "Settings", then press **▶** or **ENTER**.



2 Select a menu item

Press **▲/▼** to select "HDMI Control", then press **▶** or **ENTER**.



3 Select the next item

Press **▲/▼** to select the desired item, then press **ENTER**. Press **↶** **RETURN** to return to the previous "menu" page.

4 Exit the menu screen

Press **HOME** or **EXIT** to exit.

Basic Operation for Playback Setting

Example: Setting "Parental Control" under "Playback Setting"

1 Press **▲/▼** to select "Settings", then press **▶** or **ENTER**.

2 Press **▲/▼** to select "Playback Settings", then press **▶** or **ENTER**.

3 Press **▲/▼** to select "Parental Control", then press **▶** or **ENTER**.

- When you operate this Player for the first time, the PIN code setting screen will be displayed. See "When setting the PIN code for the first time" below.

4 Enter your 4-digit PIN code.

- You cannot move to the next setting screen until you can input the correct PIN code.

When setting the PIN code for the first time.

1. To set the PIN code for the first time, press **▲/▼** to select "Yes" to enter the PIN code setting menu, then press **▶** or **ENTER**.
2. Enter a 4-digit number for the PIN code, then the same 4-digit number for confirmation.
3. Press **ENTER** to complete the PIN code setting procedure and move to the next setting screen.

5 Press **▲/▼** to select the parental control level for DVD VIDEO, BD-ROM, and then select the country code. Press **ENTER** after making each selection.

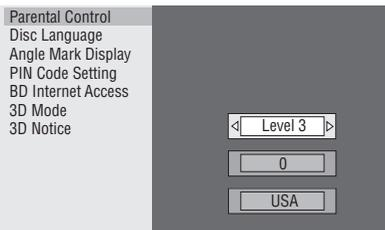

6 Press **HOME** or **EXIT** to exit.

NOTE

- Settings with (*) are the factory presets.

HDMI Video Out

This sets the resolution of the video output for the HDMI terminal of this player.
Normally set to "Auto" (factory preset value).

▶ **Item**

Auto*, 1080p, 1080i, 720p, 576/480p

NOTE

- When the BD player is connected to a 1080p 24 Hz compatible TV and the "HDMI Video Out" is set to "Auto", 1080p 24 Hz will automatically be displayed when compatible discs are played back.

Secondary Audio

This toggles the clicking sound on the menu and audio with secondary video in picture in picture mode for BD-Video.

- Select "Off" when enjoying the high quality sounds of BD-Video.

▶ **Item**

On*, Off

Audio Out

You can set the audio output when connecting to SURROUND equipment.

1. This sets the audio output connected to SURROUND equipment.

▶ **Item**

HDMI Output*

Select this when you connect using HDMI OUT terminal.

Digital Output: Select this when you connect using DIGITAL AUDIO OUT terminal (OPTICAL).

2. You can set the audio output mode for each output terminal.

A This sets the audio output mode for HDMI OUT terminal when selecting "HDMI Output".

NOTE

- When the secondary audio is set to "On", PCM is automatically selected as the audio output mode.

▶ **Item**

Bitstream:

- Select this when connecting to HDMI equipment with a built-in decoder for DOLBY DIGITAL, etc.

- Setting to Bitstream will output each audio signal by Bitstream.

PCM (Surround):

- Select this when connecting to multi-channel HDMI equipment.
- Setting to PCM (Surround) will output by LINEAR PCM by decoding audio signals recorded in each audio output mode such as DOLBY DIGITAL, DTS.

B This sets the audio output mode for DIGITAL AUDIO OUT (OPTICAL terminal) when selecting "Digital Output".

▶ **Item**

Bitstream:

- Select this when connecting to SURROUND equipment with a built-in decoder for DOLBY DIGITAL, etc.
- Setting to Bitstream will output each audio signal by Bitstream.

PCM:

- Select this when connecting to 2 channel stereo audio equipment.
- Setting to PCM will output by converting each audio signal into PCM 2 channel audio signal.

NOTE

- See page 49 for information on output of audio formats.

Dynamic Range Control

This lets you adjust the range between the loudest and softest sounds (dynamic range) for playback at average volume. Use this when it is hard to hear dialogue.

▶ **Item**

Normal: The same audio output range is played as the original recorded audio output range.

Shift: When Dolby Digital audio is played back, the dynamic range of the audio is adjusted so that the dialogue portion can be heard easily. (If the audio sounds abnormal, set to "Normal".)

Auto*: When you play back audio in the Dolby TrueHD format, the dynamic range is automatically adjusted.

* Lower the audio volume before setting. If you do not do so, the speakers may emit a loud sound or excessive output may be applied to the speakers.

SUPER PICTURE

This enhances the quality of video streaming images with pixel by pixel processing technology.

- ▶ **Item**
On*, Off

Smart Settings

Auto Power Off

This sets the Player so that power is automatically shut off if playback is stopped and you do not perform any operations for about 10 minutes.

- ▶ **Item**
Yes*, No

HDMI Control

This lets you set the Player to receive the control signal from the remote control via the HDMI cable.

- ▶ **Item**
Yes*, No

NOTE

- For details, refer to the operation manual of AV receiver.

Playback Setting

Parental Control

This lets you set the Parental Control depending on the disc content. The available Parental Control Levels are shown below.

The 4-digit PIN code number needs to be entered before the Parental Control Levels and the Country Code are set. The Parental Control Levels and the Country Code cannot be set if a PIN code has not been created or the PIN code is not entered.

- Select the rating level appropriate for the age of the user.

- ▶ **Item (Parental control level for DVD-video)**
8 and Off: All DVD-video can be played.
1–7: Prohibits play of DVD-video with corresponding ratings recorded on them.
- ▶ **Item (Parental control level for BD-video)**
No Limit: All BD-video can be played.
0–99 year(s): Prohibits play of BD-video with corresponding ratings recorded on them.

- ▶ **Item (Country code)**

Select the country code.

The ratings differ according to the country.

NOTE

- Refer to “Basic Operation for Playback Setting” on page 39 for details.

Disc Language (Disc Priority Language)

This lets you select the language for subtitles, audio and menus displayed on the screen.

- ▶ **Item (Subtitle)**
Select the subtitle language you want to display.
- ▶ **Item (Audio)**
Select the audio language you want to hear.
- ▶ **Item (Menu)**
Select the menu language you want to display.

NOTE

- When “Auto” is selected, the priority language of the disc will be played back.

Angle Mark Display

This lets you turn the Angle Mark Display on or off when BD/DVD video recorded with multiple angles is played back. (The Angle Mark is displayed in the lower right screen.)

- ▶ **Item**
Yes, No*

PIN Code Setting

This sets the PIN code for setting or changing the Parental Control Level.

▶ Item

Yes: Enter the 4-digit number.

No

NOTE

- When you forget the PIN code, you can reset the current PIN code using “System Reset” under “Settings”. (see page 42)
- You can also set the new PIN code if desired.

BD Internet Access

This allows you to set access restriction to BD-LIVE contents.

▶ Item

Permit: Allows all BD-LIVE discs.

Limit*: Allows only discs with owner certification.

Prohibit: Prohibits all BD-LIVE discs.

NOTE

- The available functions differ depending on the disc.
- Regarding playback method of BD-LIVE contents, etc., perform the operations in accordance with the instructions in the BD disc manual.
- To enjoy BD-LIVE functions, perform the broadband Internet connection (Page 18) and communication settings (Page 43).

3D mode

This sets output of 3D images.

To view 3D images, playback of 3D content (3D BD video) is necessary with a 3D compatible TV and 3D glasses in addition to this player.

▶ Item

Auto*: Video signals are output as 3D when 3D content (3D BD video) is played or as 2D when 2D content is played.

2D: Even if 3D content (3D BD video) is played, video signals are output as 2D at all times.

CAUTION

- When viewing 3D images, viewing for a long period of time or lying on your back may cause eye strain and discomfort. In addition, 3D images may affect the eyesight of young children/infants, so keep them from viewing the images.

3D Notice

This sets whether or not a notice is displayed (“Yes” or “No”) on the connected TV every time 3D content (3D BD video) is played.

▶ Item

Yes*, No

On Screen Language

You can set the language you want to display on the screen.

▶ Item

English*, Deutsch, Français, Italiano, Español, Português, Nederlands, Svenska, Dansk, Norsk, Suomi, Polski, Český, Magyar, Slovensky, Slovenščina

Version

When you select “Version”, the system software version is displayed.

System

System Reset

You can reset all settings to the factory presets.

▶ Item

Reset, Not Reset

DivX(R) Registration

The DivX registration code is displayed.

▶ Item

Yes, No

NOTE

- To learn more, visit www.divx.com/vod.

DivX(R) Deregistration

You can deactivate your DivX information on then player.

▶ Item

Yes, No

NOTE

- To learn more, visit www.divx.com/vod.

Communication Setup

This allows you to perform and/or change the communication settings and select the type of Internet connection from Cable. This setting is required to use BD-LIVE functions, home networks and software updates that connect to the Internet.

NOTE

- Make sure that the LAN cable is connected to this player (see page 18).
- For manually performing the setting, the following information of the connected router or modem is required. Confirm the information prior to the setting.
 - IP address, netmask, gateway, DNS address

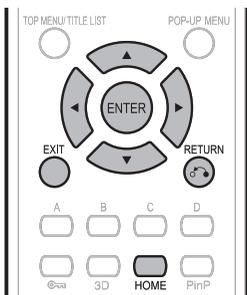

1. Press **▲/▼** to select "Settings", then press **▶** or **ENTER**.
2. Press **▲/▼** to select "Communication Setup", then press **▶** or **ENTER**.
3. Press **▲/▼** to select "Ethernet Setup", then press **▶** or **ENTER**.
4. Press **▲/▼** to select "Change", then press **ENTER**.

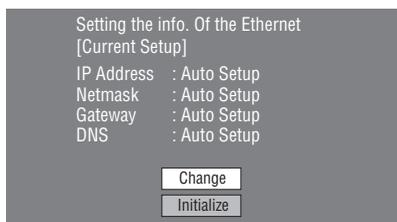

- For initializing the current setting, select "Initialize", then press **ENTER**.
5. For setting the IP address, press **◀/▶** to select "Yes" or "No", then press **ENTER**.

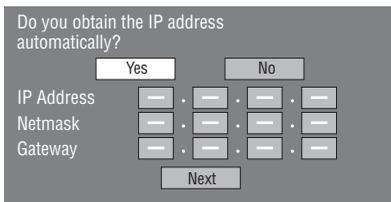

- If selecting "Yes": The IP address is automatically obtained.
 - If selecting "No": The IP address, netmask and gateway are manually entered using the screen for inputting characters. Regarding each of the setup values, confirm the specifications of your broadband router.
6. Select "Next", then press **ENTER**.
 - If selecting "Yes" in the step 5, go to the step 8.
 7. Enter your DNS address.



- The primary and secondary DNS addresses are entered using the screen for inputting characters. Regarding each of the setup values, confirm the specifications of your broadband router.
8. Select "Next", then press **ENTER**.
 9. For testing the connection to the Internet, after confirming the settings, press **▲/▼** to select "Test", then press **ENTER**.
 - "Test" is available only when setting to obtain the IP address automatically. "Test" cannot be selected if the IP address has not been obtained automatically.

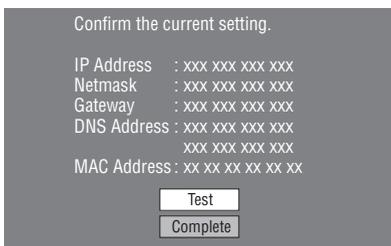

- As a result of the test, if the Internet connection fails, enter the setup values manually.
10. Press **▲/▼** to select "Complete", then press **ENTER**.
 11. Press **HOME** or **EXIT** to return to the Home screen.
 - To perform other settings, press **↶ RETURN**.

The operation procedure for inputting numbers manually

NOTE

- Numeric characters such as IP address can be entered on the input screen either by selecting each of the characters in the “Numeric” mode or using the **Number** buttons on the remote control.

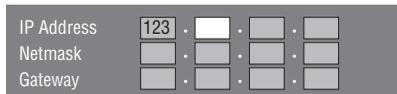

1. Press **ENTER** at the boxes in which characters are to be entered, and the input screen will appear.

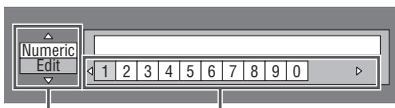

2. Press **▲/▼** to select the desired input mode.
3. Press **◀/▶** to select a number, then press **ENTER**.
4. Repeat the step 3 to display all of the desired characters in the input field.

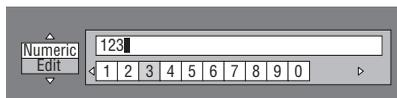

NOTE

- Press **RETURN** (Del.Char.) to delete a number you have input.
 - To change a number you have input, press **B** (Green) (Left) or **C** (Yellow) (Right) to select the number you want to change, and press **RETURN** (Del.Char.). Then, press **◀/▶** to select a new number you want to input, and press **ENTER**.
5. Press **D** (Blue) (Complete) to fix the numbers which have been input.

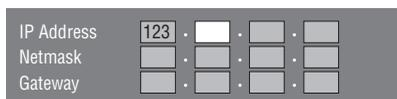

6. Repeat step 1 to 5 to finish inputting all the required numbers.

Before using the USB memory device

CAUTION

- Do not remove the USB memory device or unplug the AC cord while the operations are being performed.
- Do not use a USB extension cable.

USB Memory Management

The following instructions explain how to delete data such as the Virtual Package data and the BD-LIVE data in a USB memory device.

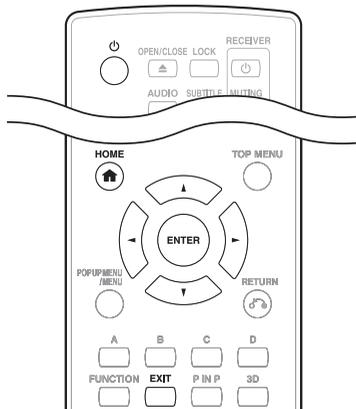

When you insert or remove a USB memory device, be sure to turn the main power off.

1. Insert the USB memory device into the USB terminal on this player.

NOTE

- A USB memory device can be used with either the USB (front) or USB (rear) terminal. When two USB memory devices are connected to both terminals at the same time, in certain situations the USB (rear) terminal may give priority to Local Storage and “Erase” and “Format” are not available for the USB memory device connected to the USB (front) terminal.
2. Press **⏻** to turn on the power.
 3. Press **▲/▼** to select “Settings”, then press **▶** or **ENTER**.
 4. Press **▲/▼** to select “USB Memory Management”, then press **▶** or **ENTER**.
 - The “USB Memory Management” screen is displayed.
 - “No USB Memory” appears when no USB memory is inserted.

5. Press ▲ / ▼ to select “Erase” or “Format”, then press **ENTER**.

Erase: Deletes only BD-VIDEO data written on the USB memory device such as BD-LIVE data.

Format: Be aware that all data including BD-VIDEO data and software update data will be deleted.

- If you want to delete only the unneeded software update data after the software is updated, delete the data on the USB memory device using a PC.



6. Press ▲ / ▼ to select “Yes”, then press **ENTER**.
 - A confirmation message is displayed. Check that the correct USB memory device is displayed, and then continue.
7. Start the process.
 - The screen for the current operation will display.



8. Press **ENTER**.
9. Press **HOME** or **EXIT** to exit.

NOTE

- Data which has been saved to the player’s internal memory (game score, etc.) will also be deleted.

Software Update Settings

In this player, the software version can be updated using either one of the following methods.

- Auto Update from Network
- Manual Update from Network
- Manual Update from USB memory device

CAUTION

- Do not remove the LAN cable or unplug the AC cord while downloading or updating software.

Auto Update from Network

This function allows you to perform the update by accessing an Internet connection automatically to check if there is a new firmware version every time the player is turned on.

NOTE

- Make sure that the LAN cable is connected to this player (see page 18).
- Make sure to perform the communication settings (see page 43).

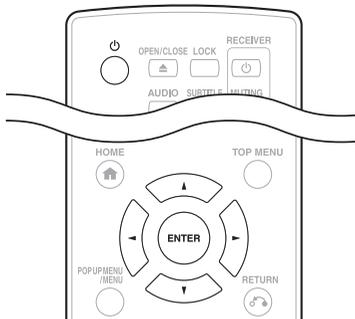

Setup

1. Press ▲ / ▼ to select “Settings”, then press ► or **ENTER**.
2. Press ▲ / ▼ to select “Software Update Settings”, then press ► or **ENTER**.
3. Press ▲ / ▼ to select “Auto Update Setting”, then press ► or **ENTER**.
4. Press ▲ / ▼ to select “Yes”, then press **ENTER**.
 - After this, an Internet connection will be made automatically every time this player is turned on.

Update process

1. When this player is turned on, the Internet connection starts automatically.
 - “Accessing...” blinks on the screen.
 - The current version of this unit software and the latest version of the update file on the network are displayed when latest version of firmware has been found.

To update this player software with update file, select “Yes”, and go to step 2.

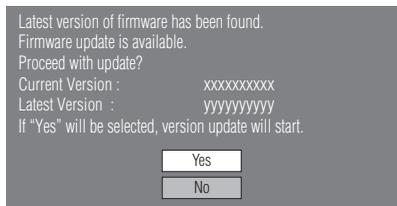

- If the latest firmware version has been already updated, nothing is displayed on the screen.
2. Press **ENTER** to start updating.

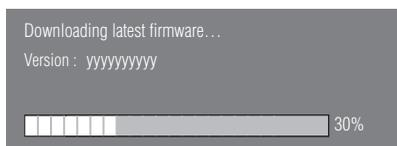

3. When the software is successfully updated, a screen is displayed indicating that the update process is completed.
 - If the update has failed, an error message appears. Retry the update after checking if the broadband Internet connection (Page 18) and communication settings (Page 43) are performed properly.
4. Press **OFF** to turn off the player before using again.

Manual Update from Network

This function allows you to perform the update operation by accessing an Internet connection manually to check if there is a new firmware version.

NOTE

- Make sure that the LAN cable is connected to this player (see page 18).
- Make sure to perform the communication settings (see page 43).

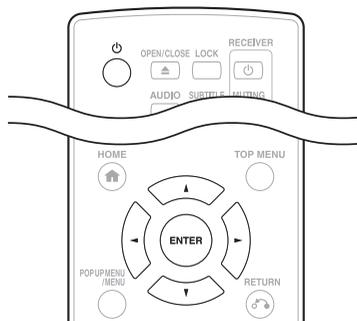

1. Press **▲/▼** to select “Settings”, then press **▶** or **ENTER**.
2. Press **▲/▼** to select “Software Update Settings”, then press **▶** or **ENTER**.
3. Press **▲/▼** to select “Manual Update”, then press **▶** or **ENTER**.
4. Press **▲/▼** to select “Network”, then press **ENTER**.
5. During access to the network and checking the latest version of firmware, “Accessing...” blinks.
 - The current version of this unit software and the latest version of the update file on the network are displayed when latest version of firmware has been found.To update this player software with update file, select “Yes”, and go to step 6.

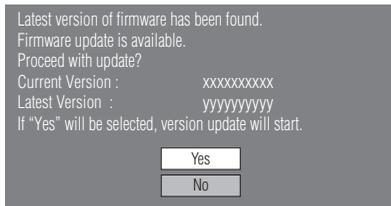

- If the Internet connection has failed, an error message appears.
Retry the update after checking if the broadband Internet connection (Page 18) and communication settings (Page 43) are performed properly.

6. Press **ENTER** to start updating.

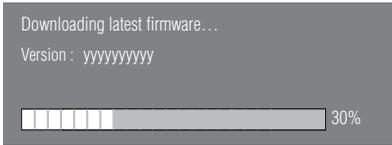

7. When the software is successfully updated, a screen is displayed indicating that the update process is completed.
- If the update has failed, an error message appears.
Retry the update after checking if the broadband Internet connection (Page 18) and communication settings (Page 43) are performed properly.
8. Press **⏻** to turn off the player.

Manual Update from USB memory device

This function allows software updates by inserting a USB memory device with the update file into the USB (front) or USB (rear) terminal on this player.

- When a software update is performed, the software update data must be written onto the USB memory device in advance using a PC.
- The USB memory device must be clear of all files except software update data to allow new software uploading.

To check for the availability of a software update, visit <http://www.onkyo.com>

- When software update data is released, copy the data onto a USB memory device after downloading it to a PC.
- For methods such as downloading and copying to a USB memory device, carefully read the description shown on the website before performing the operation.

NOTE

- Do not extract the firmware update file to any folders other than the root directory on the USB memory device. The firmware update file must be only one file directly in the root directory.

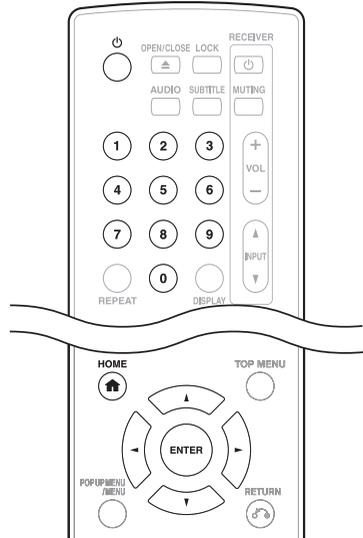

When you insert or remove a USB memory device, be sure to turn the main power off.

1. Insert the USB memory device with the update file into the USB (front) terminal on this player.

USB memory device

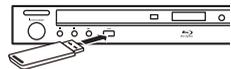

NOTE

- A USB memory device can be used with either the USB (front) or USB (rear) terminal. When two USB memory devices are connected to both terminals at the same time, in certain situations the USB (rear) terminal may give priority to Local Storage and the USB (rear) terminal cannot be used for Software Update.

2. Press **⏻** to turn on the power.
3. Press **▲ / ▼** to select “Settings”, then press **▶** or **ENTER**.
4. Press **▲ / ▼** to select “Software Update Settings”, then press **▶** or **ENTER**.
5. Press **▲ / ▼** to select “Manual Update”, then press **▶** or **ENTER**.
6. Press **▲ / ▼** to select “USB Memory”, then press **ENTER**.
 - If you have not yet set the PIN code, go to step 8.
7. Enter the 4-digit number using 0–9.



8. Press **ENTER** to start checking data in the USB memory device.



9. During the data checking, “Checking” blinks.



- The current version of this unit software and the version of the update file on the USB memory device are displayed. To update this player software with update file, select “Yes”, and press **ENTER**.

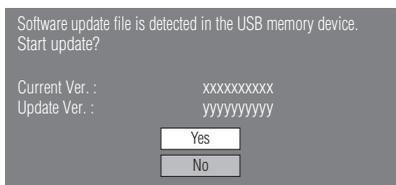

- If the USB memory device is not properly installed or the correct update file cannot be found on the USB memory device, an error message is displayed. Check the file on the USB memory device, and then reinsert the USB memory device correctly.



10. Press **ENTER** to start updating.
 - The screen becomes dark for a while until the update screen can be displayed. Please wait for the update screen to appear. Do not unplug the AC cord.

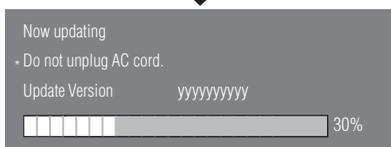
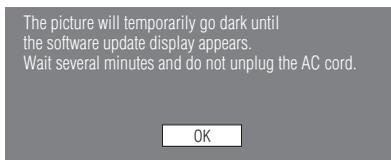

11. When the software is successfully updated, a screen is displayed indicating that the update process is completed.
 - If the update has failed, check the file in the USB device and try Software Update again.
12. Press **⏻** to turn off the player.
 - Delete unneeded software update data using a PC after the software update process is completed.
13. Remove the USB memory device.

About Output of Audio Formats

Audio format	Maximum number of channels	HDMI		DIGITAL OUT	
		PCM	Bitstream	PCM	Bitstream
Dolby TrueHD	7.1ch (48 kHz/96 kHz)	7.1ch ^{*3}	7.1ch ^{*4}	2ch ^{*2}	5.1ch ^{*1/*3}
	5.1ch (192 kHz)	5.1ch ^{*3}	5.1ch ^{*4}	2ch ^{*2}	5.1ch ^{*1/*3}
Dolby Digital PLUS	7.1ch (48 kHz)	7.1ch	7.1ch ^{*4}	2ch ^{*2}	5.1ch ^{*1/*3}
DTS-HD Master Audio	7.1ch (48 kHz/96 kHz)	7.1ch ^{*3}	7.1ch ^{*4}	2ch ^{*2}	5.1ch ^{*1/*3}
	5.1ch (192 kHz)	5.1ch ^{*3/*5}	5.1ch ^{*4}	2ch ^{*2}	5.1ch ^{*1/*3}
DTS-HD High Resolution Audio	7.1ch (48 kHz/96 kHz)	7.1ch ^{*3}	7.1ch ^{*4}	2ch ^{*2}	5.1ch ^{*1/*3}
LPCM	7.1ch (48 kHz/96 kHz)	7.1ch ^{*3}	–	2ch ^{*2}	–
	5.1ch (192 kHz)	5.1ch ^{*3}	–	2ch ^{*2}	–

^{*1} Core only

^{*2} Down mixed

^{*3} When "Secondary Audio" is set to "On", the audio is output as 48 kHz.

^{*4} When "Secondary Audio" is set to "On", the audio is output as PCM.

^{*5} When 5.1ch (192 kHz), the audio output is downsampled to 96 kHz. When 2ch, the audio is output as 192 kHz.

About DivX file

DivX HD divx/avi

Video codec	Resolution	Frame rate (720p or less)	Frame rate (more than 720p)
MPEG4 SP	320x240 - 1920x1080	60, 59.94, 50, 30,	30, 29.97, 25, 24,
MPEG4 ASP		29.97, 25, 24, 23.97	23.97
Audio codec	Sampling Frequency	Bit rate	
MP3 (MPEG Audio Layer 3)	16-48 kHz	16-320 kbps	
MP2 (MPEG Audio Layer 2)	16-48 kHz	16-320 kbps	
AC3	-48 kHz	32-448 kbps	
Subtitles			
XSUB			
XSUB+			

DivX Plus HD MKV

Video codec	Resolution	Frame rate (720p or less)	Frame rate (more than 720p)
H.264 (MPEG4 AVC)	320x240 - 1920x1080	60, 59.94, 50, 30, 29.97, 25, 24, 23.97	30, 29.97, 25, 24, 23.97
Audio codec	Sampling Frequency	Bit rate	
MP3 (MPEG Audio Layer 3)	16-48 kHz	16-320 kbps	
AAC/LC, AAC/HEv1, AAC/HEv2	6-48 kHz	8-1024 kbps	
AC3	-48 kHz	32-448 kbps	
Subtitles			
SubRip			
SubStation Alpha			
Advanced SubStation Alpha			

Troubleshooting

The following problems do not always suggest a defect or malfunction of this Player. Refer to the problems and lists of possible solutions below before calling for service.

■ Power

Problem	Possible causes and solutions
The Player power cannot be turned on.	<ul style="list-style-type: none">• Is the power cord firmly plugged into the AC outlet? (Page 19)
The Player power is turned off.	<ul style="list-style-type: none">• Is “Auto Power Off” set to “Yes”? When “Auto Power Off” is set to “Yes”, the power will be automatically turned off after 10 continuous minutes of inactivity (no playback). (Page 41)

■ Basic Operation

Problem	Possible causes and solutions
The remote control does not work.	<ul style="list-style-type: none">• Use the remote control within its operating range. (Page 19)• Replace the batteries. (Page 19)
Cannot operate the Player.	<ul style="list-style-type: none">• Are you operating the Player within the specified operating temperature range? (Page 55)

■ Playback

Problem	Possible causes and solutions
The Player cannot play a disc.	<ul style="list-style-type: none"> • Take out the disc and clean it. (Page 11) • Make sure that the disc is loaded properly (aligned in disc tray and label-side up). (Page 22) • Make sure that region code on the disc matches that of this Player. (Page 7) • Allow any condensation in or near the Player to dry. (Page 11) • Check that the disc is recorded in the compatible TV system (PAL or NTSC). • The Player cannot play back video which was not recorded normally. (Page 8) • Proper playback may be impossible due to the state of the disc recording, a scratched, warped or dirty disc, the state of the pick-up, or compatibility issues between this Player and the disc being used. (Pages 8, 11) • When the recorded time of a disc is unusually short, playback may not be possible. • BD-RE/R discs recorded in a format other than BDMV/BDAV cannot be played back. (Page 7)
The disc is automatically ejected after closing the disc tray.	<ul style="list-style-type: none"> • Make sure that the disc is loaded properly (aligned in disc tray and label-side up). (Page 22) • Take out the disc and clean it. (Page 11) • Make sure that the disc is playable. (Page 7)
Video stops.	<ul style="list-style-type: none"> • Has the Player been subjected to shock or impact? Are you using it in an unstable location? The Player will stop if it senses shock or vibration.
The Player makes a snapping sound when starting playback or loading a disc.	<ul style="list-style-type: none"> • The player may sometimes make a snapping sound when starting playback if it has not been operated in a while. These sounds are not malfunctions of the player but are normal operating conditions.

■ Picture

Problem	Possible causes and solutions
No picture.	<ul style="list-style-type: none"> • Make sure that the cable is connected correctly. (Page 15) • Make sure that the connected TV or the AV receiver is set to the correct input. (Page 16) • Take out the disc and clean it. (Page 11) • Make sure that region code on the disc matches that of this Player. (Page 7) • There is no picture from the HDMI output. <ul style="list-style-type: none"> - Are the settings performed correctly? Please check the settings. (Page 40)
Screen freezes and operation buttons do not work.	<ul style="list-style-type: none"> • Turn off the power and turn on the power again. • If the power is not turned off, perform a reset. (Page 53) • Is the disc damaged or dirty? Check the condition of the disc. (Page 11)
Square noise (mosaic) appears on the screen.	<ul style="list-style-type: none"> • Blocks in images may be visible in scenes with rapid movement due to the characteristics of digital image compression technology.
Audio is not output, or images are not played back properly.	<ul style="list-style-type: none"> • The audio may not be output or the images may not be played back properly for some discs in which copyright-protected contents are recorded.
3D images cannot be output to a TV.	<ul style="list-style-type: none"> • Is an HDMI cable used? • Are a 3D compatible TV and 3D glasses used? • Is a proper connection made between the HDMI OUT terminal of the player and the HDMI input terminal of the 3D compatible TV? • Is the 3D setting on this player correct? (Pages 21, 42) • Is the 3D setting on the TV correct? • When a connection to a 3D TV is made via an amplifier/AV receiver, it is necessary to connect to a 3D compatible amplifier/AV receiver. • Is a 3D compatible BD disc being played back?
Noise appears on the screen.	<ul style="list-style-type: none"> • When you watch TV broadcasts with the power of this player turned on, noise may appear on the TV screen. In such cases, turn off the power to this player or keep this player away from the TV.

■ Sound

Problem	Possible causes and solutions
No sound, or sound is distorted.	<ul style="list-style-type: none"> • If the volume of the TV or amplifier is set to minimum, turn the volume up. • There is no sound during still mode, slow motion playback, fast forward and fast reverse. (Page 33) • Check that the audio cable is connected correctly. (Page 17) • Check that the cable plugs are clean. • Take out the disc and clean it. (Page 11) • Audio may not be output depending on the audio recording status, such as when audio other than an audio signal or non-standard audio is recorded for the audio content of the disc. (Page 8)
Audio is not output, or images are not played back properly.	<ul style="list-style-type: none"> • The audio may not be output or the images may not be played back properly for some discs in which copyrightprotected contents are recorded.

■ Network

Problem	Possible causes and solutions
Cannot connect to the Internet.	<ul style="list-style-type: none"> • Is the LAN cable connected properly? • Is the wrong cable such as a modular cable used? Connect a LAN cable to the ETHERNET terminal. (Page 18) • Is the power for the connected equipment, such as a broadband router or modem turned on? • Is the broadband router and/or modem properly connected? • Is the proper value(s) set in the network setting? Check "Communication Setup". (Page 43)
Cannot download BD-LIVE contents.	<ul style="list-style-type: none"> • Is the LAN cable connected properly? • Is the USB memory device properly connected? Check that the USB memory device is connected to the USB (front) or USB (rear) terminal of this Player. • Check if the BD disc supports BD-LIVE. • Check the setting for "BD Internet Access". (Page 42)

■ Other

Problem	Possible causes and solutions
The Player heats up during use.	<ul style="list-style-type: none"> • When using this Player, the console cabinet may heat up depending on the usage environment. This is not a malfunction.

■ To Reset this Player

If this Player receives strong interference from a source such as excessive static electricity, strong external noise, malfunction of power supply, or voltage caused by lightning during use or a wrong operation is sent to the Player, errors like the Player not accepting an operation may occur.

- Press and hold **⏻ ON/STANDBY** on the Player until "RESET" appears on the front panel display when the Player does not operate properly even after the power has been turned off.

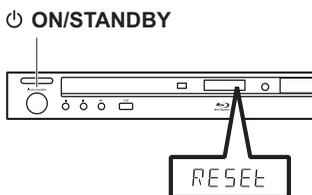

- When a reset is performed while the power is on, the Player will turn off. Turn the power on again. At this point, it may take a few moments for the system processing to finish before the Player is ready for use.
- Since all settings including the language setting stored in memory are also reset when a reset has been performed, they must be set again.
- When the problem persists even after performing a reset, unplug the AC cord and plug it in again. If this does not solve the problem, contact the nearest service centre approved by ONKYO SOUND & VISION CORPORATION.

On-screen Error Messages

The following messages appear on the TV screen in case of an error during operation.

Error message	Possible Error	Suggested Solution
Cannot play.	<ul style="list-style-type: none">• The disc cannot be played back with this Player.	<ul style="list-style-type: none">• Check the disc, and load it correctly.
Incompatible disc.	<ul style="list-style-type: none">• If you load a disc which cannot be played with this Player (i.e. a scratched disc), or if you load a disc upside down, this message will appear, and the disc tray will automatically pop out.	
	<ul style="list-style-type: none">• Occurs if the loaded disc cannot be played because it is a non-standard disc or scratched, etc.	<ul style="list-style-type: none">• Remove the disc.
Cannot operate.	<ul style="list-style-type: none">• Occurs if an operation is incorrect.	-
This USB memory is not formatted properly. Please format the memory in USB memory management.	<ul style="list-style-type: none">• Occurs if there is a formatting error.• Occurs if the USB memory is not formatted with FAT 32/16.	<ul style="list-style-type: none">• Format the USB memory again.• Format the USB memory with your PC.
The Connected USB Memory cannot be used. It should be compliant with USB 2.0	<ul style="list-style-type: none">• Occurs if USB memory not compliant with USB 2.0 High Speed (480 Mbit/s) is used (i.e. USB 1.0/USB 1.1).	<ul style="list-style-type: none">• Connect USB 2.0 High Speed (480 Mbit/s) compliant USB memory.

Specifications

Signal System		PAL/NTSC
HDMI	Resolution	576p/480p, 720p, 1080i, 1080p, 1080p 24 Hz
	Audio Format	LPCM, Dolby Digital, Dolby Digital Plus, Dolby True HD, DTS, DTS-HD
	Support	Deep Colour / x.v.Colour (JPEG only)
	Connector	A Type
Audio Output (Digital)		Optical

General

Power Supply	AC 100 ~ 240 V, 50/60 Hz
Power Consumption	16 W
Stand-by Power Consumption	0.4 W
Dimensions (W x H x D)	435 mm x 57.3 mm x 201 mm
Weight	1.7 kg
Operation Condition Temperature/Humidity	5 °C ~ 35 °C / 10% ~ 80% (no condensation)
Bus Power Supply (USB)	DC 5V, 0.5 A
Disc Compatibility	CD-R, CD-RW, DVD-R, DVD-RW, DVD-R DL, DVD+R, DVD+RW, DVD+R DL, BD-R, BD-RE (Discs that have not been properly finalised may only be partially playable or not playable at all.)

Design and specifications are subject to change without notice.

Glossary

■ AVCHD (Page 7)

AVCHD (Advanced Video Codec High Definition) refers to a recording format (specification) for digital video cameras which can record to a disc such as 8 cm DVD disc and play back digital high definition images.

■ BDAV (Page 7)

BDAV (Blu-ray Disc Audio/Visual, BD-AV) refers to one of the application formats used for writable Blu-ray discs such as BD-R, BD-RE, etc. BDAV is a recording format equivalent to DVD-VR (VR mode) of the DVD specifications.

■ BD-J application

The BD-ROM format supports Java for interactive functions. "BD-J" offers content providers almost unlimited functionality when creating interactive BD-ROM titles.

■ BD-LIVE (Page 25)

A variety of interactive content is available from BD-LIVE compatible Blu-ray discs via the Internet.

■ BDMV (Page 7)

BDMV (Blu-ray Disc Movie, BD-MV) refers to one of the application formats used for BD-ROM which is one of the Blu-ray Disc specifications. BDMV is a recording format equivalent to DVD-video of the DVD specification.

■ BD-R (Pages 7, 25)

A BD-R (Blu-ray Disc Recordable) is a recordable, write-once Blu-ray Disc. Since contents can be recorded and cannot be overwritten, a BD-R can be used to archive data or for storing and distributing video material.

■ BD-RE (Pages 7, 25)

A BD-RE (Blu-ray Disc Rewritable) is a recordable and rewritable Blu-ray Disc.

■ BD-ROM

BD-ROMs (Blu-ray Disc Read-Only Memory) are commercially produced discs. Other than conventional movie and video contents, these discs have enhanced features such as interactive content, menu operations using pop-up menus, selection of subtitle display, and slide shows. Although a BD-ROM may contain any form of data, most BD-ROM discs will contain movies in High Definition format for playback on Blu-ray Disc players.

■ Blu-ray Disc (BD) (Page 7)

A disc format developed for recording/playing highdefinition (HD) video (for HDTV, etc.), and for storing large amounts of data. A single layer Blu-ray Disc holds up to 25 GB, and a dual-layer Blu-ray Disc holds up to 50 GB of data.

■ Chapter number (Page 38)

Sections of a movie or a music feature that are smaller than titles. A title is composed of several chapters. Some discs may only be comprised of a single chapter.

■ Copy guard

This function prevents copying. You cannot copy discs marked by the copyright holder with a signal which prevents copying.

■ Deep Colour

Deep Colour can reproduce rich colours, increasing the number of bits describing colours. This Player is compatible with Deep Colour. You can enjoy this function by connecting to a Deep Colour compatible TV using an HDMI cable.

■ Disc menu (Page 23)

This lets you select things like the subtitle language or audio format using a menu stored on the DVD video disc.

■ Dolby Digital

A sound system developed by Dolby Laboratories Inc. that gives movie theatre ambience to audio output when the product is connected to a Dolby Digital processor or amplifier.

■ Dolby Digital Plus

A sound system developed as an extension to Dolby Digital. This audio coding technology supports 7.1 multi-channel surround sound.

■ Dolby TrueHD

Dolby TrueHD is a lossless coding technology that supports up to 8 channels of multi-channel surround sound for the next generation optical discs. The reproduced sound is true to the original source bit-for-bit.

■ DTS

This is a digital sound system developed by DTS, Inc. for use in cinemas.

■ **DTS-HD High Resolution Audio**

DTS-HD High Resolution Audio is a new technology developed for the next generation high definition optical disc format.

■ **DTS-HD Master Audio**

DTS-HD Master Audio is a lossless audio compression technology developed for the next generation high definition optical disc format.

■ **DTS-HD Master Audio | Essential**

DTS-HD Master Audio | Essential is a lossless audio compression technology developed for the next generation high definition optical disc format.

■ **DVD upscaling (Page 22)**

Upscaling (upconverting) refers to a function of various players and devices that enlarge the image size to fit the size of the screen of video equipments such as a TV.

■ **DVD video (Pages 7, 22)**

A disc format that contains up to eight hours of moving pictures on a disc the same diameter as a CD. A single-layer single sided DVD holds up to 4.7 GB; a double layer single-sided DVD, 8.5 GB; a single layer double-sided DVD, 9.4 GB; double-layer double-sided DVD, 17 GB. The MPEG 2 format was adopted for efficient video data compression. It is a variable rate technology that encodes the data to according to the status of the video for reproducing high-quality images. Audio information is recorded in a multi-channel format such as Dolby Digital, allowing for a realistic audio presence.

■ **DVD+/-R (Pages 7, 22)**

A DVD+/-R is a recordable, write-once DVD. Since contents can be recorded and cannot be overwritten, a DVD+/-R can be used to archive data or for storing and distributing video material. The DVD+/-R has two different formats: VR format and Video format. DVDs created in Video format have the same format as a DVD video, while discs created in VR (Video Recording) format allow the contents to be programmed or edited.

■ **DVD+/-RW (Pages 7, 22)**

A DVD+/-RW is a recordable and rewritable DVD. The re-recordable feature makes editing possible. The DVD+/-RW has two different formats: VR format and Video format. DVDs created in Video format have the same format as a DVD video, while discs created in VR (Video Recording) format allow the contents to be programmed or edited.

■ **FAT (Pages 28, 29)**

FAT (File Allocation Table) is a computer file system architecture. It is commonly found on USB memory device and many other portable devices as FAT12, FAT16, FAT32 etc. Each version of FAT differs in file size limitation and supporting OS. This player is compatible with FAT formatted USB memory device.

■ **HDMI (Page 16)**

HDMI (High-Definition Multimedia Interface) is an interface that supports both video and audio on a single digital connection. The HDMI connection carries standard to high definition video signals and multi-channel audio signals to AV components such as HDMI equipped TVs, in digital form without degradation.

■ **Interlace format**

Interlace format shows every other line of an image as a single "field" and is the standard method for displaying images on television. The even numbered field shows the even numbered lines of an image, and the odd numbered field shows the odd numbered lines of an image.

■ **JPEG (Pages 8, 29)**

JPEG (Joint Photographic Experts Group) is a still image data compression format and is used in most of digital cameras.

■ **Linear PCM Sound**

Linear PCM is a signal recording format used for Audio CDs and on some DVD and Blu-ray discs. The sound on Audio CDs is recorded at 44.1 kHz with 16 bits. (Sound is recorded between 48 kHz with 16 bits and 96 kHz with 24 bits on DVD video discs and between 48 kHz with 16 bits and 192 kHz with 24 bits on BD video discs.)

■ **MP3 (Pages 9, 28)**

MP3 files are audio data compressed in the MPEG1/2 Audio layer-3 file format. "MP3 files" have ".mp3" as extensions.

■ **MPEG-2**

MPEG-2 (Moving Picture Experts Group phase 2) is one of the video data compression schemes, which is adopted for DVD videos and digital broadcasts worldwide. Some Blu-ray Discs also use high bitrate MPEG-2.

■ Multi Angle (Page 36)

This is a feature of DVD and BD video discs. In some discs, the same scene is shot from different angles, and these are stored in a single disc so you can enjoy playback from each angle. (This function can be enjoyed if the disc is recorded with multiple angles.)

■ Multi Audio

This is a feature of DVD and BD video discs. This function makes it possible to record different audio tracks for the same video, so you can enhance your enjoyment by switching the audio. (You can enjoy this function with discs recorded with multiple audio tracks.)

■ NTFS (Pages 28, 29)

NTFS (New Technology File System) is a computer file system architecture specified for certain OS. It is mainly designed to expand the disk's capability of large size files (especially for files larger than 4GB). Note that this player is not compatible with NTFS formatted USB memory device.

■ Parental control (Page 41)

In some digital broadcasts and BD/DVD video discs, a control level for disc viewing is set depending on the age of the viewer. With this Player, you can set the control level for viewing such broadcasts and discs.

■ Pop up menu (Page 24)

An enhanced menu operation available on BD video discs. The pop up menu appears when **POP UP MENU/MENU** is pressed during playback, and can be operated while playback is in progress.

■ Progressive format

Compared to the Interlace format that alternately shows every other line of an image (field) to create one frame, the Progressive format shows the entire image at once as a single frame. This means that while the Interlace format can show 30 frames/60 fields in one second, the Progressive format can show 60 frames in one second. The overall picture quality increases and still images, text, and horizontal lines appear sharper.

■ Region code (Page 7)

Code identifying a geographic region of compatibility for a BD/DVD.

■ Resume playback (Page 22)

If you stop playback while it is in progress, the Player stores the stop position in memory, and this function lets you playback from that point.

■ Skip (Page 33)

This returns to the start of the chapter (or track) being played, or skips to the next chapter (or track).

■ Subtitles (Page 35)

These are the lines of text appearing at the bottom of the screen which translate or transcribe the dialogue. They are recorded on many DVD and BD video discs.

■ Time number

This indicates the play time which has elapsed from the start of a disc or a title. It can be used to find a specific scene quickly. (It may not work with some discs.)

■ Title number (Page 38)

These numbers are recorded on DVD and Blu-ray discs. When a disc contains two or more movies, these movies are numbered as title 1, title 2, etc.

■ Top menu (Page 23)

In a BD/DVD video, this is the menu for selecting things like the chapter to be played back and the subtitle language. In some DVD videos, the top menu may be called the "Title Menu".

■ Track number (Page 38)

These numbers are assigned to the tracks which are recorded on audio CDs. They enable specific tracks to be located quickly.

■ x.v.Colour

x.v.Colour reproduces a greater range of colour than before, showing almost all of the colours that the human eye can detect. (Applicable for JPEG files only with this system)

About Software License

Information on the Software License for This Product

■ Software composition

The software included in this product is comprised of various software components whose individual copyrights are held by third parties.

■ Software developed by third parties and open source software

The copyrights for the software components and various relevant documents included with this product that were developed or written by third parties are owned by third parties and are protected by the Copyright Act, international treaties, and other relevant laws. This product also makes use of freely distributed software and software components whose copyrights are held by third parties. These include software components covered by a GNU General Public License (hereafter GPL), a GNU Lesser General Public License (hereafter LGPL) or other license agreement.

You can obtain a copy of the GPL, LGPL licenses from <http://www.gnu.org/licenses/old-licenses/gpl-2.0.html> and <http://www.gnu.org/licenses/old-licenses/lgpl-2.1.html>.

■ Acknowledgements

The following open source software components are included in this product:

• cairo • Curl • DirectFB • Droid Sans font • Droid Sans Fallback font • Expat • Fltk • FreeType • Giflib • glib • Icu • Jpeg • libcurl • libidn • Libpng • LibPThread • Librt • libsoup • libssl and libcrypto • Libstdc++ • Libxml2 • libxml2 • lua • lua-sincryptop • lua-xmlreader • No oss • OpenSSL • Optional UnitTest++ Software • pango • swfdec • Webkit • zlib

Software License Notice

■ Software License Notice Requirements

The software components incorporated into this product include components whose copyright holders require license notices. The license notices for these software components are shown below.

■ OpenSSL License

This product includes software developed by the OpenSSL Project for use in the OpenSSL Toolkit. (<http://www.openssl.org>)

■ Original SSLeay License

This product includes cryptographic software written by Eric Young (eay@cryptsoft.com).

■ BSD License

This product includes software developed by the University of California, Berkeley and its contributors.

ONKYO®

ONKYO SOUND & VISION CORPORATION

2-1, Nisshin-cho, Neyagawa-shi, OSAKA 572-8540, JAPAN

Tel: 072-831-8023 Fax: 072-831-8163

<http://www.onkyo.com/>

ONKYO U.S.A. CORPORATION

18 Park Way, Upper Saddle River, N.J. 07458, U.S.A.

Tel: 800-229-1687, 201-785-2600 Fax: 201-785-2650

<http://www.us.onkyo.com/>

ONKYO EUROPE ELECTRONICS GmbH

Liegnitzerstrasse 6, 82194 Groebenzell, GERMANY

Tel: +49-8142-4401-0 Fax: +49-8142-4401-555

<http://www.eu.onkyo.com/>

ONKYO EUROPE ELECTRONICS GmbH (UK BRANCH)

The Coach House 81A High Street, Marlow, Buckinghamshire, SL7 1AB, UK

Tel: +44-(0)1628-473-350 Fax: +44-(0)1628-401-700

ONKYO CHINA LIMITED

Unit 1 & 12, 9/F, Ever Gain Plaza Tower 1, 88, Container Port Road, Kwai Chung,

N.T., Hong Kong. Tel: 852-2429-3118 Fax: 852-2428-9039

<http://www.ch.onkyo.com/>

ONKYO CHINA PRC

1301, 555 Tower, No.555 West NanJin Road, Jin an, Shanghai,

China 200041, Tel: 86-21-52131366 Fax: 86-21-52130396

D1104-2

SN 29400765A

(C) Copyright 2011 ONKYO SOUND & VISION CORPORATION Japan.

All rights reserved.



* 2 9 4 0 0 7 6 5 A *