



BLUMOTION for doors

The new side of perfect motion

Perfecting motion  **blum**®

Silent and effortless closing displays a new side of itself



With BLUMOTION, your customers will simply love the way their furniture doors close silently and effortlessly day in and day out. A fascinating added-value that has already become a firm benchmark in TANDEM and TANDEMBOX pull-outs.

BLUMOTION is now displaying a new side of itself – the hinge side. BLUMOTION can now be quickly integrated into cabinets with doors. It will work for almost any application and does not require any change to the hinge assembly.

BLUMOTION redefines the term; quality of motion. The system is quick and easy to install and, once fitted, creates a perfect closing motion. The effect is truly inspiring.



Contents

The adaptive system	4 – 5
Design	6 – 7
Using BLUMOTION	8 – 9
Application options	10 – 11
Ordering information	12 – 17
BLUMOTION overview	18
The Blum brand	19

The adaptive system – controlling perfect motion



- ▶▶ Even doors that are closed with force ...
- ▶ are brought to a gentle halt ...
- ◻ and close silently and effortlessly.



Exceptional comfort through a highly adaptive system.

BLUMOTION's intelligent adaptive system reacts automatically to important factors such as door size, door weight and closing speed, and then brakes the motion of the door accordingly. The result is perfect closing motion every time. Silent and effortless.



A look behind the scenes at the BLUMOTION adaptive system:

The braking element expands according to the force and this regulates the travel speed of the mechanism.

This technology enables BLUMOTION to adjust itself automatically to the each door size, weight and closing speed.

- Perfect closing motion everytime due to adaptability.

- The integrated overload safety feature protects the BLUMOTION system & hinge from damage through abuse.
- BLUMOTION lasts the lifetime of the furniture – ensuring that your customers remain satisfied.

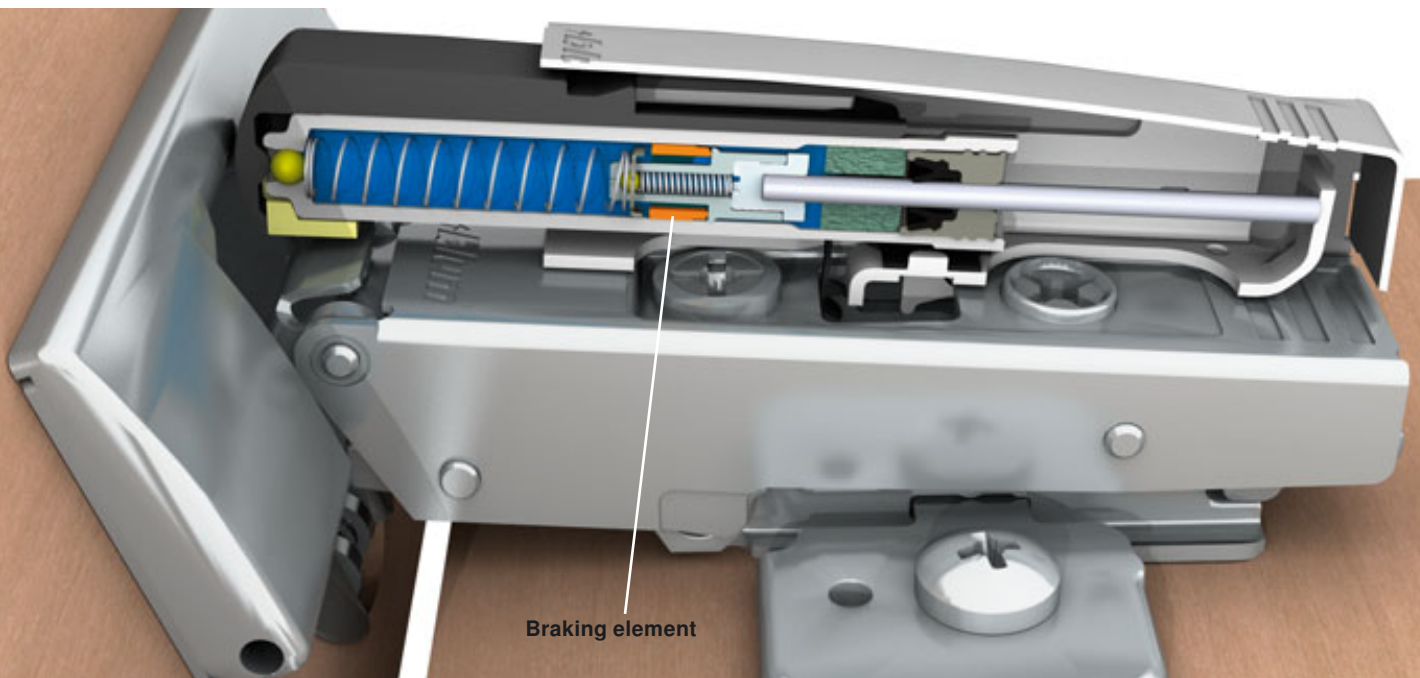

This is how the adaptive system works

Slow closing speed: The braking element expands slightly generating only modest resistance to the flow. The BLUMOTION effect is controlled via the flow speed and, in this case, remains low.

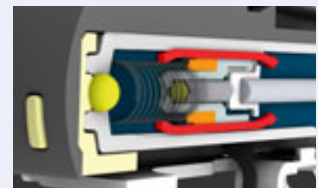

Fast closing speed: The braking element expands which constricts the flow channel to create greater resistance. This results in a strong BLUMOTION effect.

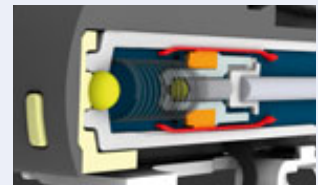

Closing speed that is too fast: The overload safety feature kicks in. The excessive force is diverted using an additional flow channel and both BLUMOTION and the hinge are protected from damage.

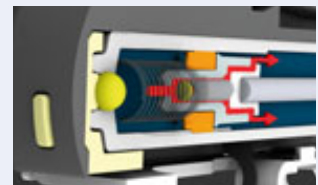

**CLIP top with BLUMOTION –
Ground breaking function behind an attractive design**





BLUMOTION satisfies the same high design standards that we set for our hinges.

CLIP top and BLUMOTION 973A work in perfect harmony - integrating both style and technology into one high-quality unit. This successful combination creates a door closing action that simply has to be experienced.



reddot design award
winner 2006

Added value that benefits everyone

BLUMOTION 973A can be installed at any point during the production and sales process. This means that everyone – from manufacturer to dealer and retailer all the way to the end customer – can make the decision at any time whether or not they want to profit from the added value of the new BLUMOTION technology.



Manufacturing: Ideally doors should be equipped with BLUMOTION during the manufacturing process. In one simple work step the mechanism is attached onto the CLIP top or CLIP hinge.

Hinge and plate drilling depths and positions remain unchanged therefore there are no additional set-up costs.

Benefit: BLUMOTION, combined with Blum's well established quality, gives the consumer new benefits and peace of mind. Each time a door is closed they will be reminded of the exceptional quality of their furniture.



Sales: Even if BLUMOTION is left out of the furniture manufacturing process, it is still not too late to add it further down the distribution chain. Thanks to BLUMOTION 973A's easy assembly feature, you can surprise and inspire your customers during sales discussions. Your customers will be unable to resist once they have experienced a practical demonstration of the perfect motion.



Assembly: The consumer still has the option to include perfect motion even when the furniture is in their house. BLUMOTION 973A can be simply attached on to the pre-assembled hinges. In next to no time the transformation is complete!



Quality of motion for all applications



Whether in the kitchen, hall, bathroom, living room or bedroom – **BLUMOTION** is at home anywhere in the house. The perfect motion creates a sense of quality and comfort in all areas of everyday life.



BLUMOTION 973A for CLIP top and CLIP hinges

BLUMOTION 973A

BLUMOTION 973A is suitable for nearly all applications and available for every hinge arm type – whether straight, 1/2 cranked or fully cranked. Naturally, the CLIP function of the hinge remains intact when BLUMOTION is added.



BLUMOTION 973A – Retrofit

BLUMOTION 973A

BLUMOTION 973A, in combination with CLIP and CLIP top hinges, is the ideal solution for perfect door motion. Assembly and removal can be carried out by hand.

- Easily assembles on to the hinge arm
- CLIP function remains intact when BLUMOTION is added
- Tool-free removal enables you to make hinge adjustments

For normal door sizes, one BLUMOTION 973A per hinge is required for that perfect motion. For smaller, lighter doors, the number can be reduced accordingly.



BLUMOTION 973A

For hinges with a straight hinge arm

- CLIP top 107°
- CLIP top 120°
- CLIP top 120° special
- CLIP top profile door
- CLIP top 95° aluminium frame
- CLIP top 120° aluminium frame
- CLIP 100°

Part No.

973A0500



BLUMOTION 973A

For hinges with a 1/2 cranked hinge arm

- CLIP top 107°
- CLIP top 120°
- CLIP top profile door
- CLIP top 95° aluminium frame
- CLIP top 120° aluminium frame
- CLIP 100°

Part No.

973A0600



BLUMOTION 973A

For hinges with a fully cranked hinge arm

- CLIP top 107°
- CLIP top profile door
- CLIP top 95° aluminium frame
- CLIP 100°

Part No.

973A0700

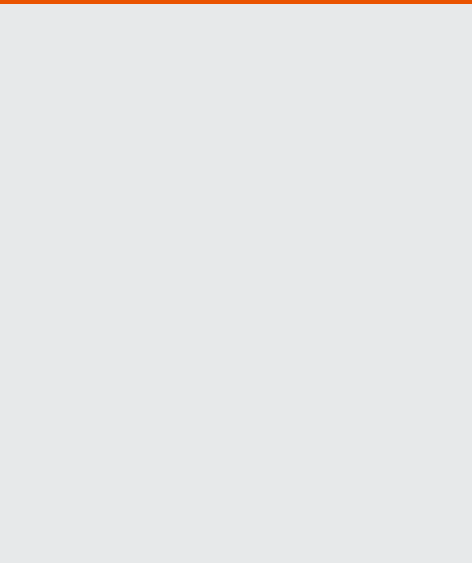

BLUMOTION 973A

For wide angle hinges with a straight or 1/2 cranked hinge arm

- CLIP top 170° – straight arm
- CLIP top 170° – cranked
- CLIP top 155° 0-protrusion hinge

Part No.

973A6000

Start of delivery 4th quarter 2006

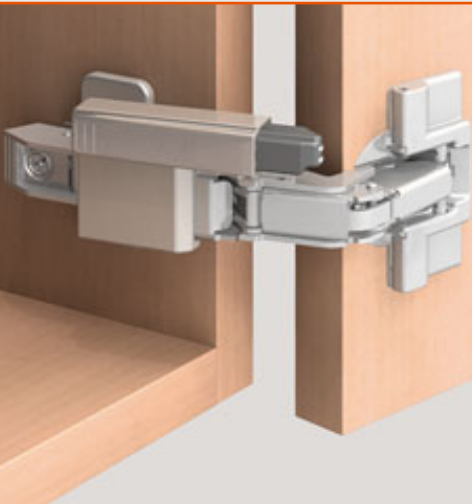

BLUMOTION 973A

For angled hinges

- CLIP top +45° I half overlay (79A96X8XT)
- CLIP top +45° II overlay (79T55X0X)
- CLIP top +30° II overlay (79A95X7XT)

Part No.

973A7480

973A7680

973A7360

Start of delivery 4th quarter 2006



BLUMOTION 973A

For CRISTALLO glass and mirror doors

- CLIP top CRISTALLO

Part No.

973A9000



BLUMOTION 971A – in adapter plate for overlay application



BLUMOTION 971A

BLUMOTION 971A can be used with CLIP top glass door or mini hinges as well as with all other „straight arm“ hinges.

For optimal BLUMOTION effect, it should be attached centrally between the hinges.

For high and heavy doors, we recommend using an additional BLUMOTION 971A between an additional hinge pair. Door gap adjustment needs to be replicated on the 971, this is easily achieved via a spiral screw depth adjustment feature (+3/-7 mm).



BLUMOTION 971A With an in-line base assembly

- Assembly using chipboard screws \varnothing 3 mm or \varnothing 4 mm
- Material: Zinc, nickel plated

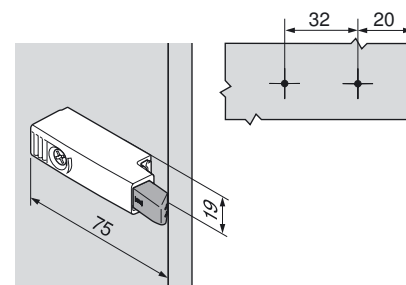

Part No.

Constr. height 25 mm **971A0200**

Constr. height 33 mm **971A2200**



BLUMOTION 971A With an in-line base assembly

- Knock-in
- Material: Zinc, nickel plated

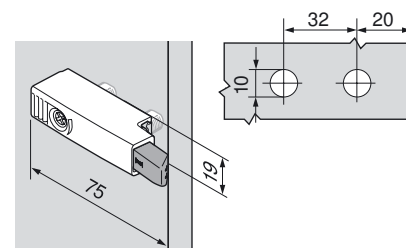

Part No.

Constr. height 25 mm **971A0230**

Constr. height 33 mm **971A2230**



BLUMOTION 971A With a cruciform base assembly (37/32)

- Assembly using chipboard screws \varnothing 3 mm or \varnothing 4 mm
- Material: Zinc, nickel plated

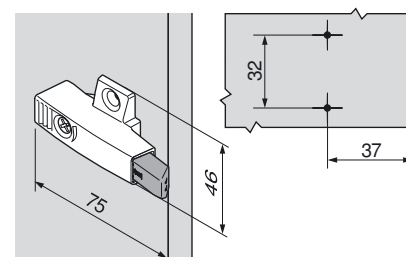

Part No.

Constr. height 25 mm **971A0500**

Constr. height 33 mm **971A2500**



BLUMOTION 971A
With a cruciform base assembly
(37/32)

- Assembly using pre-mounted special screws with split dowels (EXPANDO)
- Material: Zinc, nickel plated

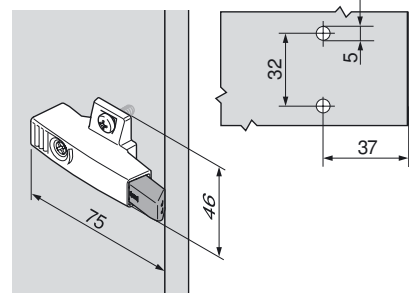

Part No.

Constr. height 25 mm **971A05E0**

Constr. height 33 mm **971A25E0**



BLUMOTION 971A
With a cruciform base assembly
(9.5/32)

- Assembly using chipboard screws Ø 3 mm or Ø 4 mm
- Material: Zinc, nickel plated

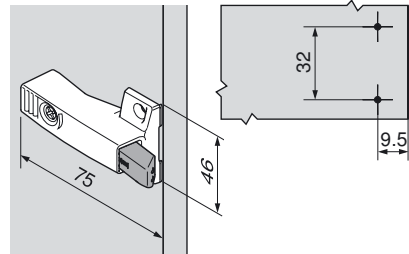

Part No.

Constr. height 25 mm **971A0700**

Constr. height 33 mm **971A2700**

Construction height 25 mm

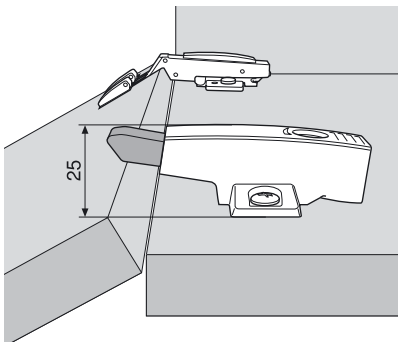

For all hinges with a straight hinge arm and a 0 mm spaced mounting plate.
 Exception: Profile door hinge 95°.

Construction height 33 mm

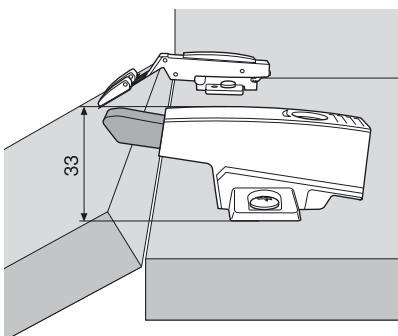

For all hinges with a straight hinge arm and a 3 mm spaced mounting plate.
 Including: Profile door hinges 95° and a 0 mm spaced mounting plate.

Assembly positions

The following figures provide the recommended BLUMOTION 971A assembly positions for doors with two or more hinges.

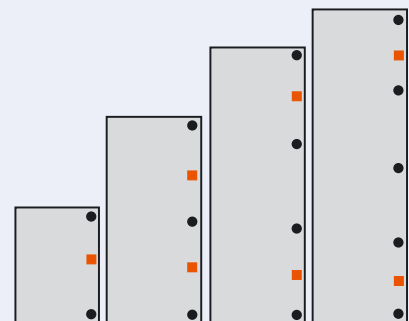

■ BLUMOTION 971AXXXX

● Hinges

BLUMOTION 970A – for drilling



BLUMOTION 970A

BLUMOTION 970A is located onto the hinge side, and produces the same perfect motion – even for angled hinges. The BLUMOTION 970A should be inserted into a pre-drilled hole, located in the cabinet top panel. The correct position is set using the drilling distance (BA).

If the BLUMOTION effect, on a particular door width, is insufficient, we recommend installing an additional BLUMOTION 970A to the bottom panel.

We recommend BLUMOTION 973A or BLUMOTION 971A for exceptionally heavy or high cabinet doors.

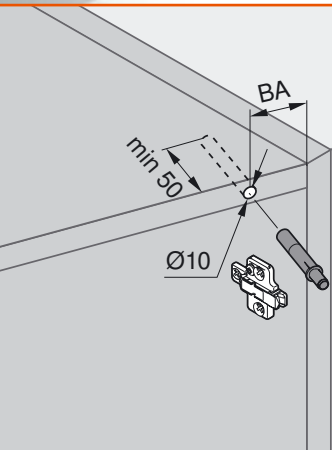

Drilling distance

The following table provides the corresponding drilling distance for each angled application.

Drilling distance (BA) in mm

N° 12	54
-------	----

Angled application



Part No.

970A1002



Drilling jig

A special drilling jig is available for BLUMOTION 970A assembly. The jig is designed to quickly locate the correct installation positions for both top and bottom panels and is suitable for every application.

Part No.

65.5010



Cruciform adapter plate

Inline adapter plate

Adapter plates

BLUMOTION adapter plates 970.XXXX are required for the following applications:



Inset application



Angled application, inset







Angled application, mitered

When dealing with narrow top rails or larger door gaps, we recommend using an adapter plate.

Part No.

(see catalogue)





Standard application

		BA in mm		BA in mm		BA in mm		BA in mm
MD	0 mm	32	0 mm	41	0 mm	50		
MD	3 mm	35	3 mm	44	3 mm	53	3 mm	51
MD	6 mm	38	6 mm	47				
MD	9 mm	41	9 mm	50				

MD: Mounting plate spacing

BA: Drilling distance

Angled application

		BA in mm		BA in mm		BA in mm		BA in mm		BA in mm
50°	N° 25	48	N° 54	48	N° 10	41	N° 45	33	N° 61	45
45°	N° 24	48	N° 53	48	N° 9	41	N° 44	33	N° 60	45
40°	N° 23	48			N° 8	41	N° 43	33		
35°	N° 22	48	N° 52	48	N° 7	41	N° 42	33	N° 59	45
30°	N° 21	48	N° 51	48	N° 6	41	N° 41	33	N° 58	45
25°	N° 20	48	N° 50	48	N° 5	37	N° 40	33	N° 57	45
20°	N° 19	48	N° 49	48	N° 4	37	N° 39	33	N° 56	45
15°	N° 18	48	N° 48	48	N° 3	33	N° 38	33	N° 55	45
10°	N° 17	48	N° 47	48	N° 2	33	N° 37	33		
5°	N° 16	37	N° 46	37	N° 1	33	N° 36	33		
-5°	N° 15	48					N° 35	37		
-10°	N° 14	54					N° 34	33		
-15°	N° 13	54					N° 33	33		
-20°	N° 12	54					N° 32	37		
-25°	N° 11	54					N° 31	33		
-30°							N° 30	33		
-35°							N° 29	37		
-40°							N° 28	37		
-45°							N° 27	37		
-50°							N° 26	45		

CRISTALLO

15°	N° 105	33			N° 102	33		
10°	N° 104	33			N° 101	33		
5°	N° 103	33			N° 100	33		
-5°	N° 106	37			N° 107	37		



































































Glass door

50°	N° 76	48			N° 68	45		
45°	N° 75	48			N° 67	45		
40°	N° 74	48						
25°	N° 73	48			N° 66	37		
20°	N° 72	54			N° 65	37		
15°	N° 71	54			N° 64	45		
5°	N° 70	48			N° 63	33		
-5°	N° 69	48			N° 62	37		

Mini

50°	N° 99	48	N° 91	48	N° 83	48		
45°	N° 98	48	N° 90	48	N° 82	45		
40°	N° 97	48	N° 89	48				
25°	N° 96	48	N° 88	45	N° 81	37		
20°	N° 95	48	N° 87	48	N° 80	37		
15°	N° 94	48	N° 86	48	N° 79	45		
5°	N° 93	48	N° 85	48	N° 78	33		
-5°	N° 92	48	N° 84	48	N° 77	37		

BLUMOTION overview

Hinge		Application											
													
		Standard door		973A0500	971AXXXX	970A1002		973A0600	970A1002				
		Standard door special		973A0500	971AXXXX	970A1002							
		Standard door		973A0500	971AXXXX	970A1002		973A0600	970A1002		973A0700	970A1002	
		Standard door		973A0500	971AXXXX	970A1002		973A0600	970A1002		973A0700	970A1002	
		Standard door		973A6000	971AXXXX	970A1002		973A6000	970A1002				
		0-protrusion hinge		973A6000	971AXXXX	970A1002							
		Profile door		973A0500	971AXXXX	970A1002		973A0600	970A1002		973A0700	970A1002	
		Blind corner				970A1002							
		Alu frame door for BLUMOTION		973A0500	971AXXXX	970A1002		973A0600	970A1002		973A0700	970A1002	
		Alu frame door for BLUMOTION		973A0500		970A1002		973A0600	970A1002				
		CRISTALLO		973A9000	971AXXXX	970A1002		973A9000	970A1002		973A9000	970A1002	
		Glass door			971AXXXX	970A1002			970A1002			970A1002	
		Mini			971AXXXX	970A1002			970A1002			970A1002	
		Angled hinge +45° I, +45° II, 30° II		973AXXXX		970A1002							
		Angled hinge remaining types				970A1002							

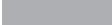

 recommended
 possible

Perfecting motion

Reliable, safe, competent

Blum is the reliable and competent partner for you: With the right products, useful services and experienced people.

The wants and needs of our customers represent the driving force for our business.

By engaging in dialogue together we discover new opportunities to perfect motion.

In this way, we can optimise and upgrade our products and services for our customers around the globe – thus benefiting everyone: Furniture manufacturers, furniture sellers, furniture installers and furniture buyers.

Our long established philosophy is to provide real advantages to each of our customers (throughout the supply chain).

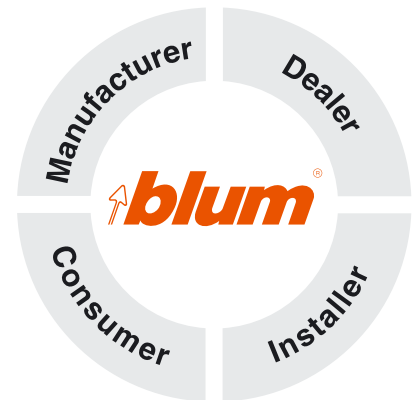

Blum innovations have become milestones in furniture hardware manufacturing. Helping you to provide high quality furniture and inspiration for your customers, through a partnership of design and function.



Our goal is to make opening and closing furniture a truly emotional experience.

“Perfecting motion” is our motto. It incorporates everything that is the best about the Blum brand.

Julius Blum GmbH
Furniture Fittings Mfg.
A-6973 Hoechst, Austria
Tel.: +43/5578/705-0
Fax: +43/5578/705-44
E-mail: info@blum.com
www.blum.com



