

BMW

R 1150 GS (Model '00)

Electrical circuit diagrams

WARNING:

Your motorcycle is equipped with Digital Motor Electronic (MOTRONIC) engine management, including a high-power ignition system.

Work on the electrical system only if the circuit has been interrupted (switch off ignition and lights).

For greater safety, disconnect and insulate the negative battery lead.

When the engine is running or the ignition is switched on, do not touch any electrically live components, terminals or wiring. Risk of fatal accident!

Wiring Harness
Left Side

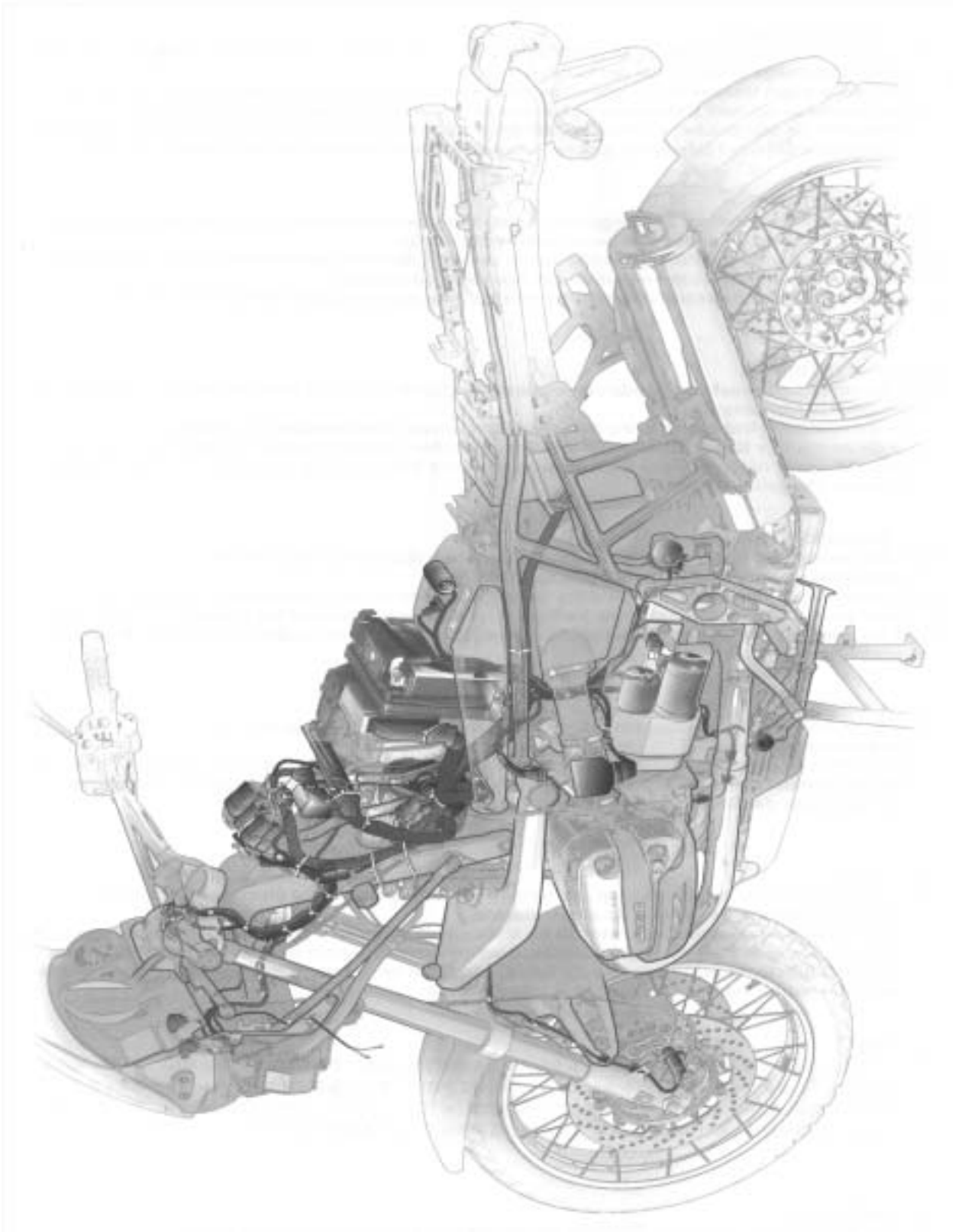

Wiring Harness
Right Side



Wiring Harness
Front side

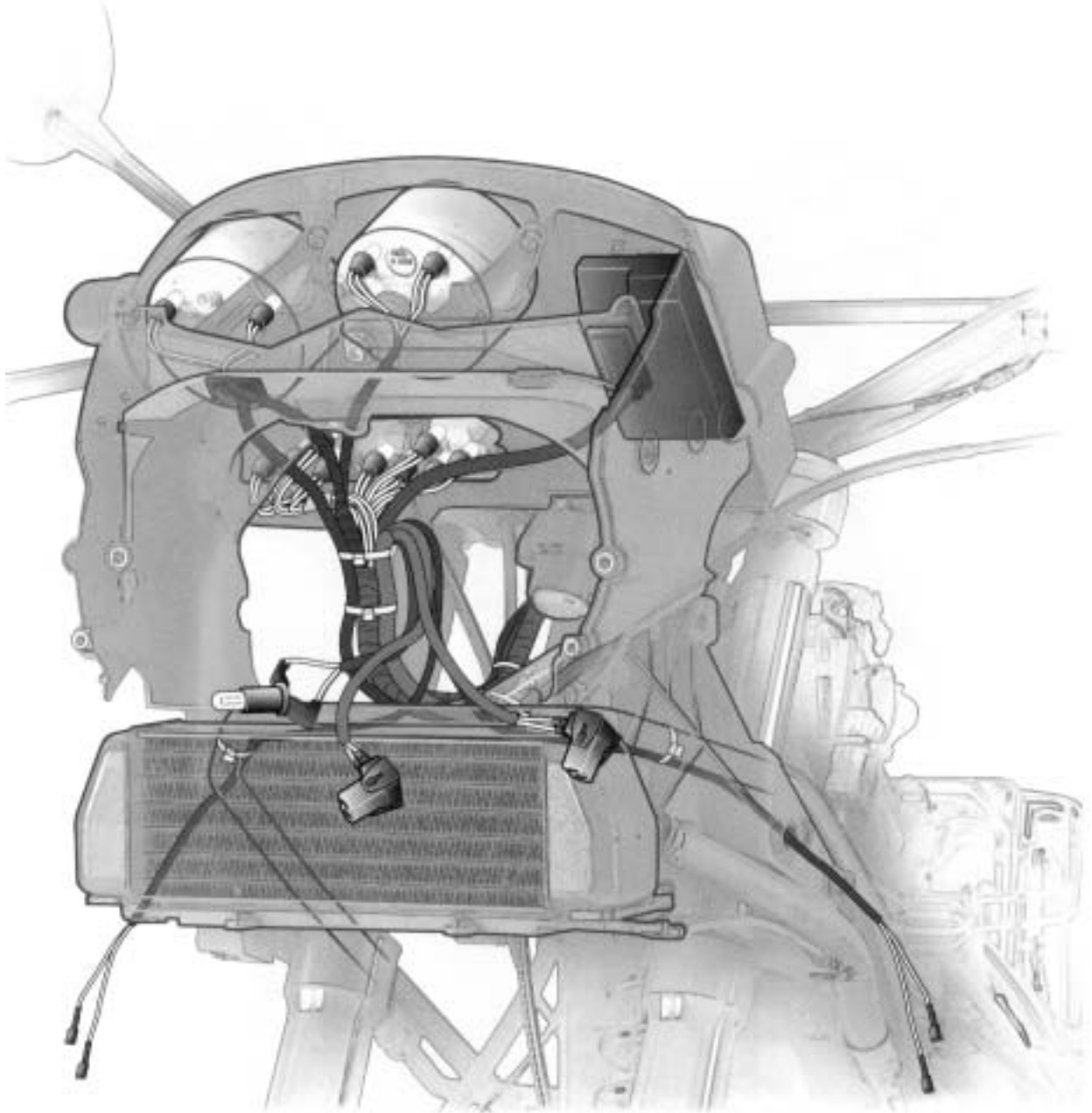

Relays

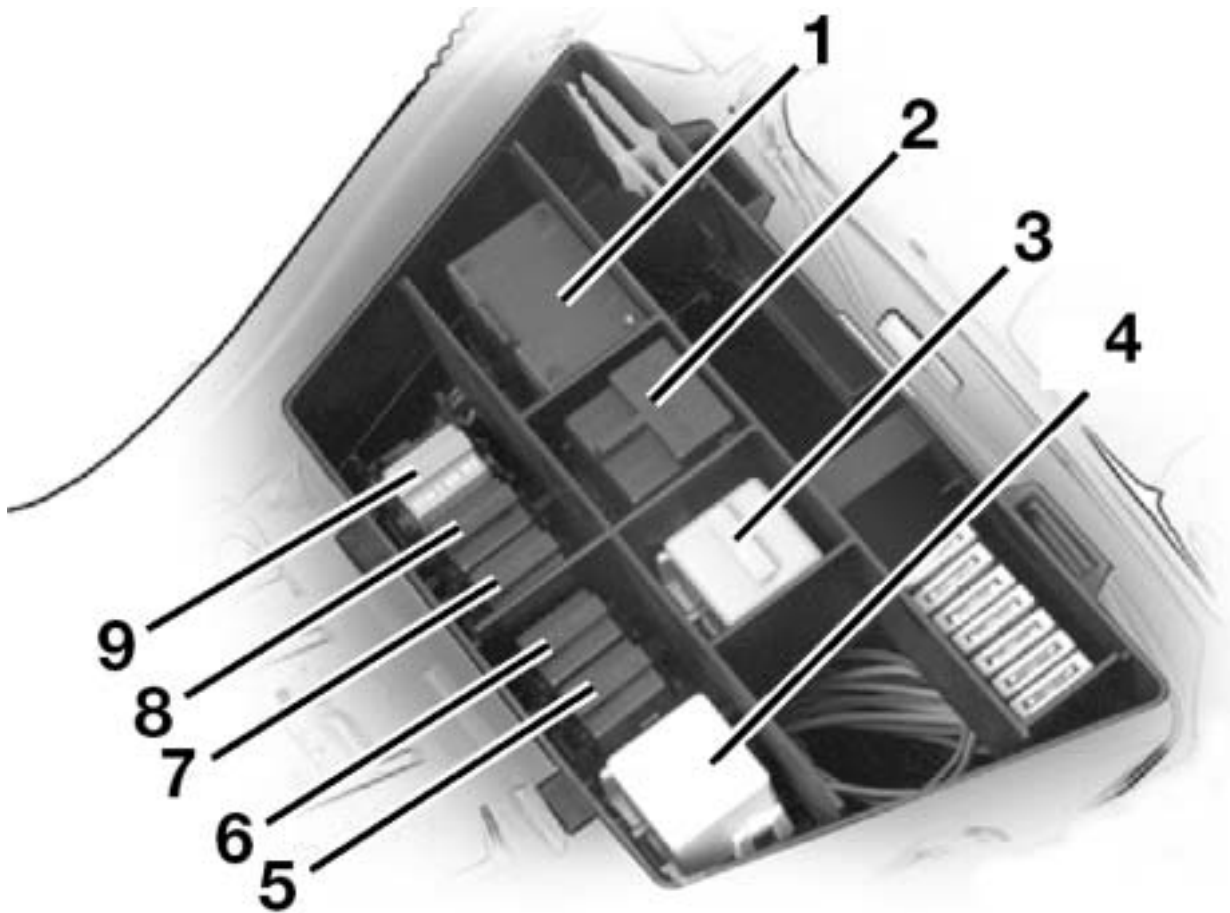

1. Flasher unit
2. Dial needle damping
3. Coding plug Motronic
4. Starter relay
5. Load relief relay
6. Horn relay
7. Fuel pump relay
8. Motronic relay
9. ABS warning relay

Fuses

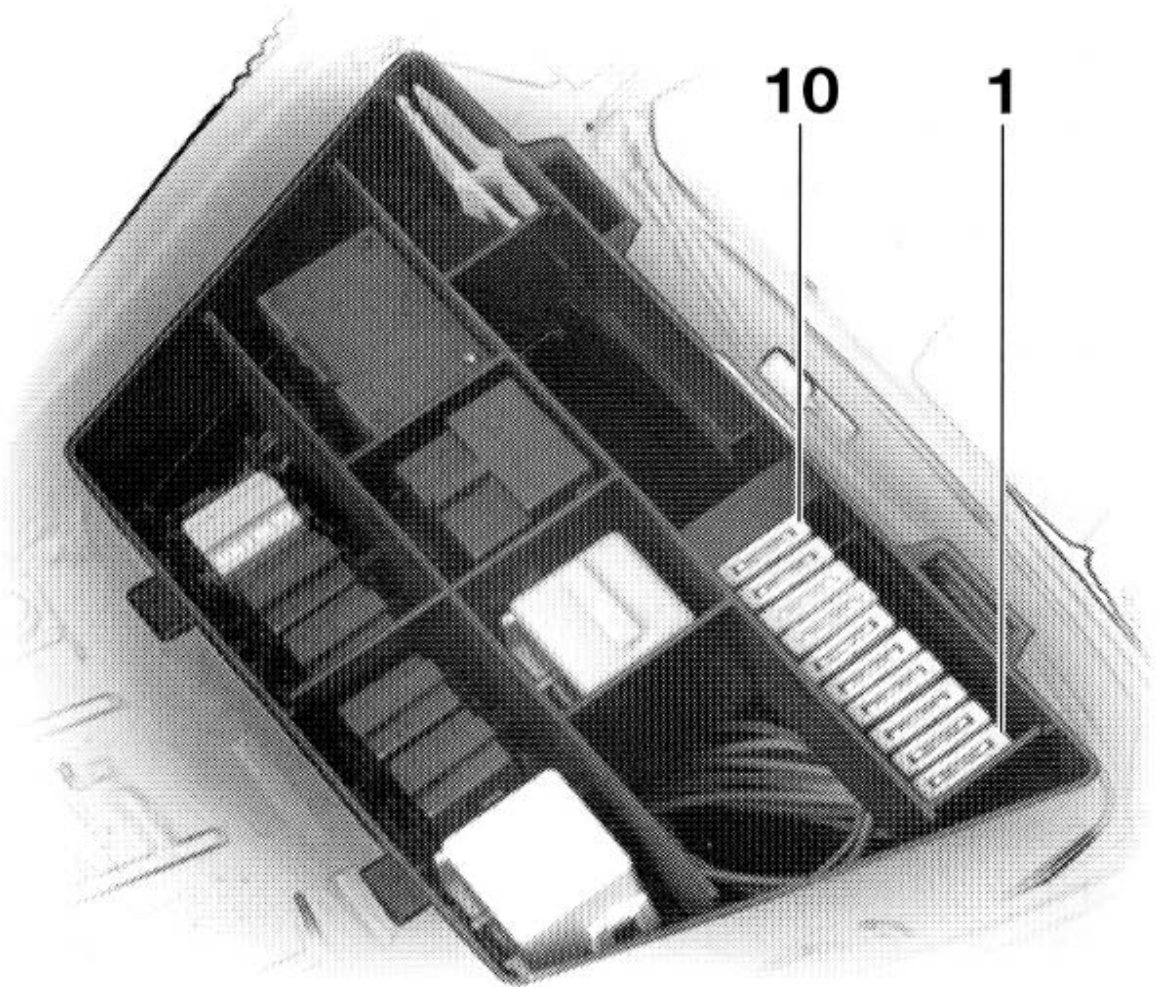

- | | | |
|-----|---|-------|
| 1. | .Instrument cluster, Dial needle damping, Brake light | 4 A |
| 2. | .Tail light, Side light | 4 A |
| 3. | .Driver information display, Socket | 15 A |
| 4. | .Horn | 7.5 A |
| 5. | .Motronic, Diagnostic connector | 10 A |
| 6. | .Fuel pump | 10 A |
| 7. | .Heated handles | 4 A |
| 8. | .Not used | |
| 9. | .Not used | |
| 10. | .Not used | |

Keys to Schematics
R 1150 GS

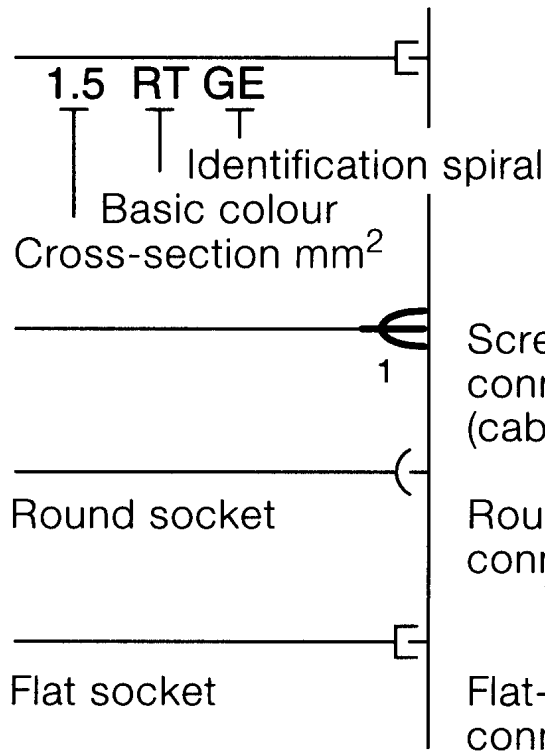

Colour codes

- BL = blue
- BR = brown
- GE = yellow
- GN = green
- GR = grey
- OR = orange
- RT = red
- SW = black
- TR = transparent
- VI = violet
- WS = white

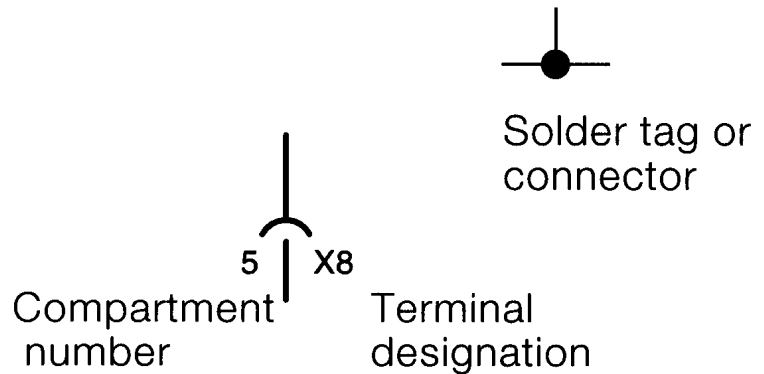
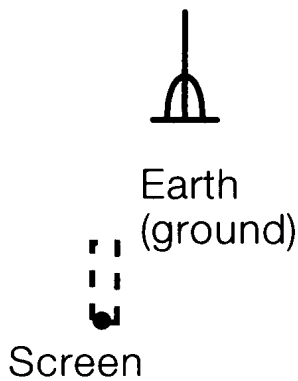

Keys to Schematics

R 1150 GS

A

A9003 Indicator lamp panel
A9020 Flasher unit
A9190 ABS control unit
A9229 Dial needle damping
A9500 Motronic control unit
A9946 Driver information display (FID)

B

B9193 Front ABS sensor
B9194 Rear ABS sensor
B9220 Fuel level sensor
B9540 Hall sensor
B9550 Air temperature sensor
B9561 Oil temperature sensor
B9690 Oxygen sensor

E

E9011 Low beams
E9012 High beams
E9013 Tail light
E9015 Side light
E9211 Speedometer light
E9215 Revolution counter light

F

F9200 Fuse box

G

G9230 Battery
G9240 Alternator

H

H9002 Idle speed indicator lamp
H9010 Lamp indicator lamp
H9012 High beam indicator lamp
H9030 Front left turn signal indicator
H9031 Left turn signal indicator lamp
H9035 Rear left turn signal indicator
H9040 Front right turn signal indicator
H9041 Right turn signal indicator lamp
H9045 Rear right turn signal indicator
H9050 Brake light
H9095 Oil pressure indicator lamp
H9150 Horn
H9190 ABS indicator lamp
H9220 Fuel warning lamp
H9240 Battery charge indicator lamp

K

K9100 Fuel pump relay
K9101 Double relay Base, motronic/fuel pump relay
K9102 Double relay base, horn/load relief base.
K9110 Motronic relay
K9120 Load relief relay
K9130 Starter relay
K9150 Horn
K9196 ABS relay
K9197 ABS warning relay
K9691 Coding plug CAT provisions

M

M9130 Starter

R

R9570 Throttle potentiometer
R9611 Spark plug 1
R9612 Spark plug 2
R9931 Left heater control
R9932 Right heater control

S

S9021 Hazard warning switch
S9051 Brake light switch, hand
S9052 Brake light switch, foot
S9060 Ignition light switch
S9070 Left combination switch
S9071 High beam switch
S9072 Horn switch
S9073 Left turn signal switch
S9080 Right combination switch
S9081 Light switch
S9082 Right turn signal switch
S9083 Emergency stop switch
S9084 Starter switch
S9085 Turn signal off switch
S9091 Clutch switch
S9093 Prop stand switch
S9095 Oil pressure switch
S9930 Switch for heated handles
S9944 Neutral safety switch

T

T9510 Ignition coil

V

V9400 Diode

X

X9002 Plug connection, tachometer
X9003 Plug connection, indicator lamp panel
X9013 Plug connection
X9014 Plug connection
X9015 Plug connection, parking light
X9016 Plug connection, parking light
X9024 Plug connection
X9025 Plug connection
X9031 Plug connection
X9032 Plug connection
X9036 Plug connection
X9037 Plug connection
X9041 Plug connection
X9042 Plug connection
X9046 Plug connection
X9047 Plug connection
X9054 Plug connection, stop light
X9100 Plug connection
X9101 Plug connection
X9102 Plug connection
X9135 Plug connection
X9136 Plug connection
X9157 Plug connection
X9188 Plug connection
X9189 Plug connection
X9196 Plug connection
X9230 Battery positive
X9231 Battery ground
X9233 Gearbox ground
X9241 Plug connection
X9242 Plug connection
X9321 Socket connection
X9351 Plug connection
X9354 Plug connection
X9380 Solder point.
X9390 Solder point
X9401 Solder point.

X9402 Solder point.
X9403 Solder point
X9404 Solder point.
X9410 Plug connection
X9411 Plug connection
X9428 Solder point
X9430 Solder point
X9433 Solder point
X9435 Solder point
X9450 Solder point
X9451 Solder point
X9467 solder point
X9480 solder point
X9481 solder point
X9482 solder point
X9483 Solder point
X9484 solder point
X9486 Solder point
X9487 Solder point
X9488 Solder point
X9489 solder point
X9501 Plug connection
X9513 Ground
X9527 Plug connection
X9573 Plug connection
X9590 Diagnostic connector
X9642 Solder point
X9643 Solder point
X9644 Solder point
X9650 Solder point
X9660 Solder point
X9671 Solder point
X9933 Solder point

Y

Y9572 Timing valve
Y9601 Valve 1
Y9602 Valve

Schematic Lighting with Stop Light

R 1150 GS (Model '00)

A

A9003 Indicator lamp panel

E

E9011 Low beams

E9012 High beams

E9013 Tail light

E9015 Side light

E9211 Speedometer light

E9215 Revolution counter light

F

F9200 Fuse box

G

G9230 Battery

H

H9012 High beam indicator lamp

H9050 Brake light

K

K9120 Load relief relay

S

S9051 Brake light switch, hand

S9052 Brake light switch, foot

S9060 Ignition light switch

S9070 Left combination switch

S9071 High beam switch

S9080 Right combination switch

S9081 Light switch

X

X9003 Plug connection, indicator lamp panel

X9013 Plug connection

X9014 Plug connection

X9015 Plug connection, parking light

X9016 Plug connection, parking light

X9024 Plug connection

X9025 Plug connection

X9054 Plug connection, stop light

X9230 Battery positive

X9231 Battery ground

X9233 Gearbox ground

X9401 Solder point

X9402 Solder point

X9403 Solder point

X9430 Solder point

X9450 Solder point

X9451 Solder point

X9480 Solder point

X9482 Solder point

X9486 Solder point

X9487 Solder point

X9488 Solder point

X9489 Solder point

Lighting with Stop Light

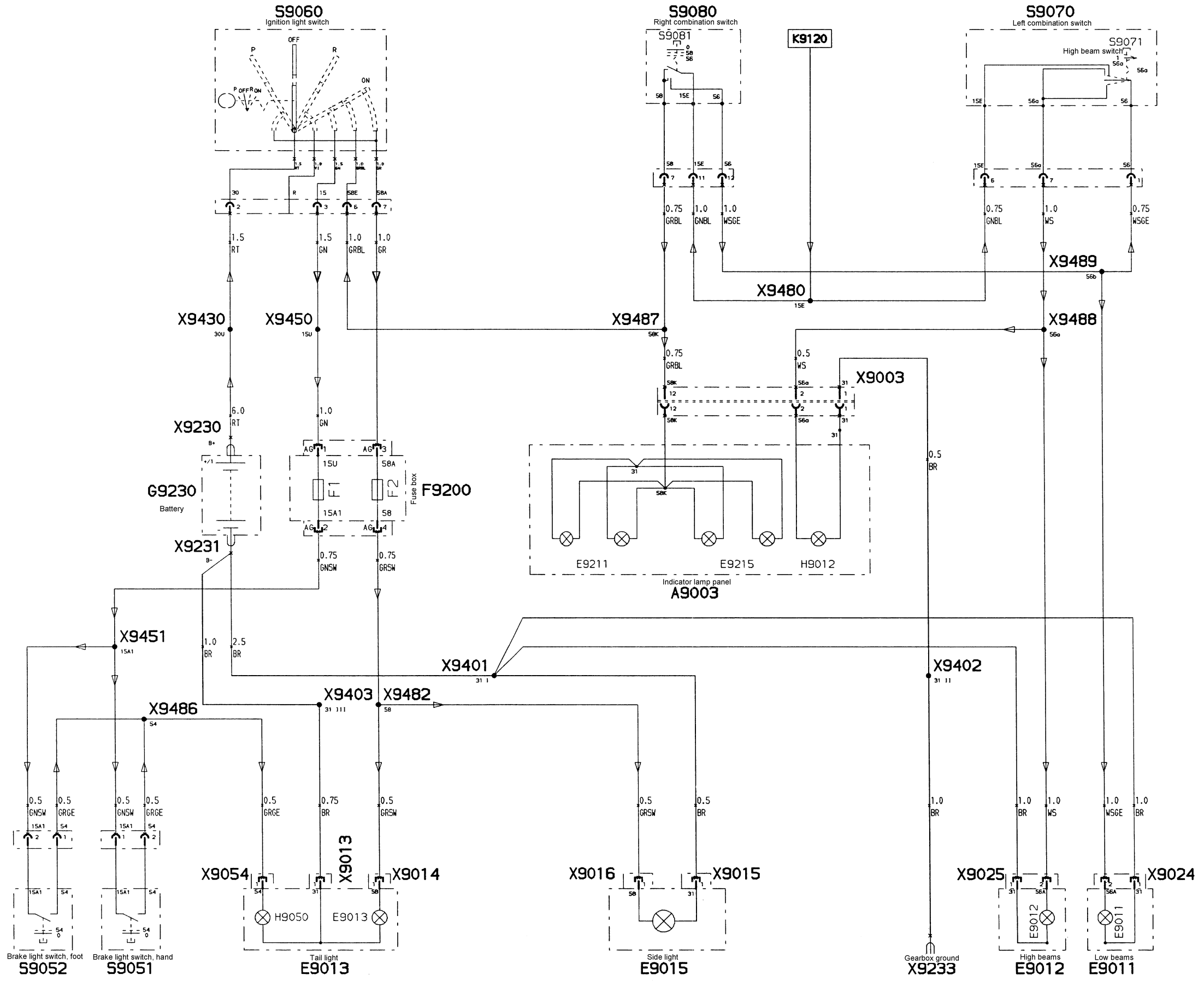

Schematic Lighting with Stop Light

R 1150 GS (Model '00) (US-Model)

A

A9003 Indicator lamp panel

E

E9011 Low beams

E9012 High beams

E9013 Tail light

E9015 Side light

E9211 Speedometer light

E9215 Revolution counter light

F

F9200 Fuse box

G

G9230 Battery

H

H9012 High beam indicator lamp

H9050 Brake light

K

K9120 Load relief relay

S

S9051 Brake light switch, hand

S9052 Brake light switch, foot

S9060 Ignition light switch

S9070 Left combination switch

S9071 High beam switch

X

X9003 Plug connection, indicator lamp panel

X9013 Plug connection

X9014 Plug connection

X9015 Plug connection, parking light

X9016 Plug connection, parking light

X9024 Plug connection

X9025 Plug connection

X9054 Plug connection, stop light

X9230 Battery positive

X9231 Battery ground

X9233 Gearbox ground

X9401 Solder point

X9402 Solder point

X9403 Solder point

X9430 Solder point

X9450 Solder point

X9451 Solder point

X9480 Solder point

X9482 Solder point

X9486 Solder point

X9487 Solder point

X9488 Solder point

X9489 Solder point

Lighting with Stop Light (US-Model)

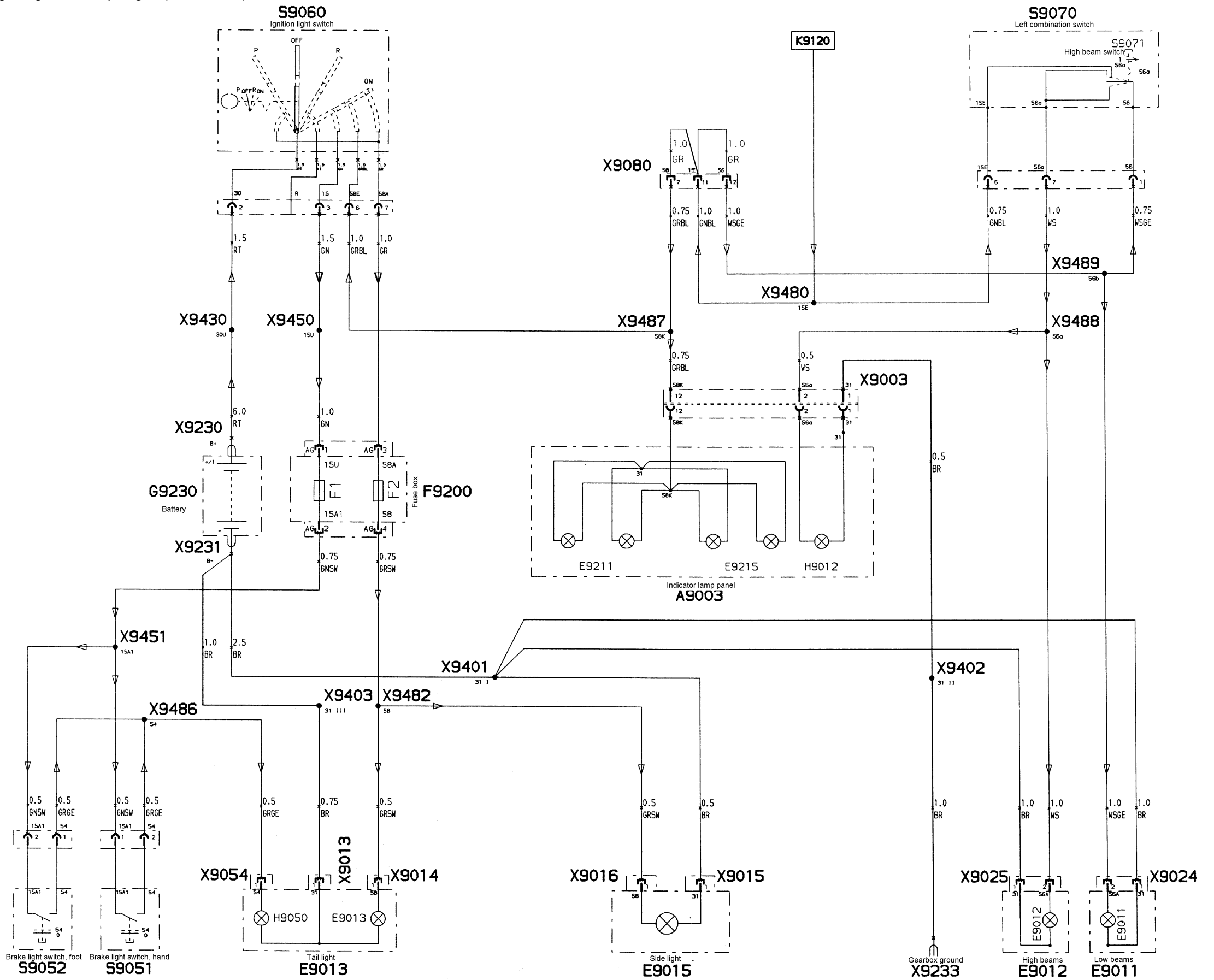

Schematic

Directional Indicator with Horn

R 1150 GS (Model '00)

A

A9003 Indicator lamp panel
A9020 Flasher unit

F

F9200 Fuse box

G

G9230 Battery

H

H9030 Front left turn signal indicator
H9031 Left turn signal indicator lamp
H9035 Rear left turn signal indicator
H9040 Front right turn signal indicator
H9041 Right turn signal indicator lamp
H9045 Rear right turn signal indicator
H9150 Horn

K

K9120 Load relief relay
K9150 Horn

S

S9021 Hazard warning switch
S9060 Ignition light switch
S9070 Left combination switch
S9072 Horn switch
S9073 Left turn signal switch
S9080 Right combination switch
S9082 Right turn signal switch
S9085 Turn signal off switch

X

X9031 Plug connection
X9032 Plug connection
X9036 Plug connection
X9037 Plug connection
X9041 Plug connection
X9042 Plug connection
X9046 Plug connection
X9047 Plug connection
X9102 Plug connection
X9157 Plug connection
X9230 Battery positive
X9231 Battery ground
X9401 Solder point
X9403 Solder point
X9428 Solder point
X9430 Solder point
X9450 Solder point
X9480 Solder point
X9483 Solder point
X9484 Solder point

Direction Indicator with Horn

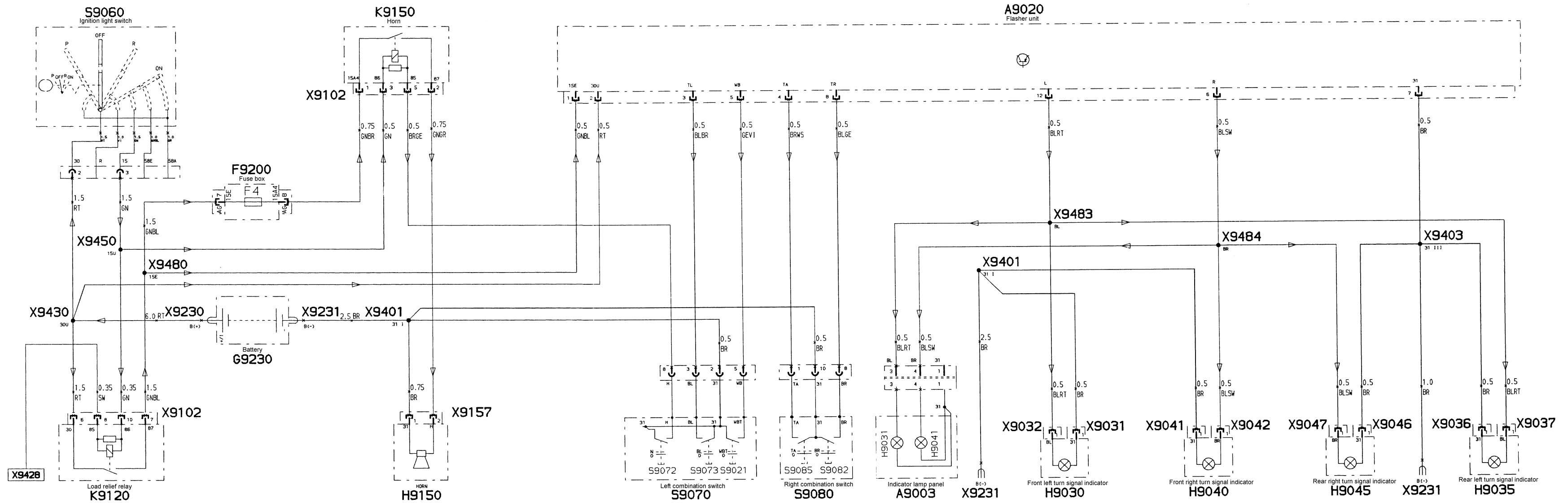

Schematic

Relays with Fuses

R 1150 GS (Model '00)

A

A9003 Indicator lamp panel
A9020 Flasher unit
A9190 ABS control unit
A9229 Dial needle damping
A9500 Motronic control unit
A9946 Driver information display (FID)

B

B9220 Fuel level sensor
B9540 Hall sensor

F

F9200 Fuse box

G

G9230 Battery
G9240 Alternator

K

K9100 Fuel pump relay
K9102 Double relay base, horn/load relief base.
K9110 Motronic relay
K9120 Load relief relay
K9130 Starter relay
K9196 ABS relay
K9197 ABS warning relay
K9691 Coding plug CAT provisions

M

M9130 Starter

R

R9611 Spark plug 1
R9612 Spark plug 2

S

S9051 Brake light switch, hand
S9052 Brake light switch, foot
S9060 Ignition light switch
S9070 Left combination switch
S9080 Right combination switch
S9083 Emergency stop switch
S9091 Clutch switch
S9093 Prop stand switch
S9944 Neutral safety switch

T

T9510 Ignition coil

X

X9002 Plug connection, tachometer
X9013 Plug connection
X9014 Plug connection
X9015 Plug connection, parking light
X9016 Plug connection, parking light
X9024 Plug connection
X9025 Plug connection
X9031 Plug connection
X9036 Plug connection
X9041 Plug connection
X9046 Plug connection
X9100 Plug connection
X9102 Plug connection
X9135 Plug connection
X9136 Plug connection
X9157 Plug connection
X9188 Plug connection
X9189 Plug connection
X9230 Battery positive
X9231 Battery ground
X9233 Gearbox ground
X9241 Plug connection
X9321 Socket connection
X9351 Plug connection
X9401 Solder point.
X9402 Solder point.
X9403 Solder point
X9404 Solder point.
X9430 Solder point
X9433 Solder point
X9435 Solder point
X9450 Solder point
X9451 Solder point
X9480 solder point
X9481 solder point
X9482 solder point
X9501 Plug connection
X9513 Ground
X9527 Plug connection
X9573 Plug connection
X9590 Diagnostic connector
X9643 Solder point
X9644 Solder point

Relay with Fuses

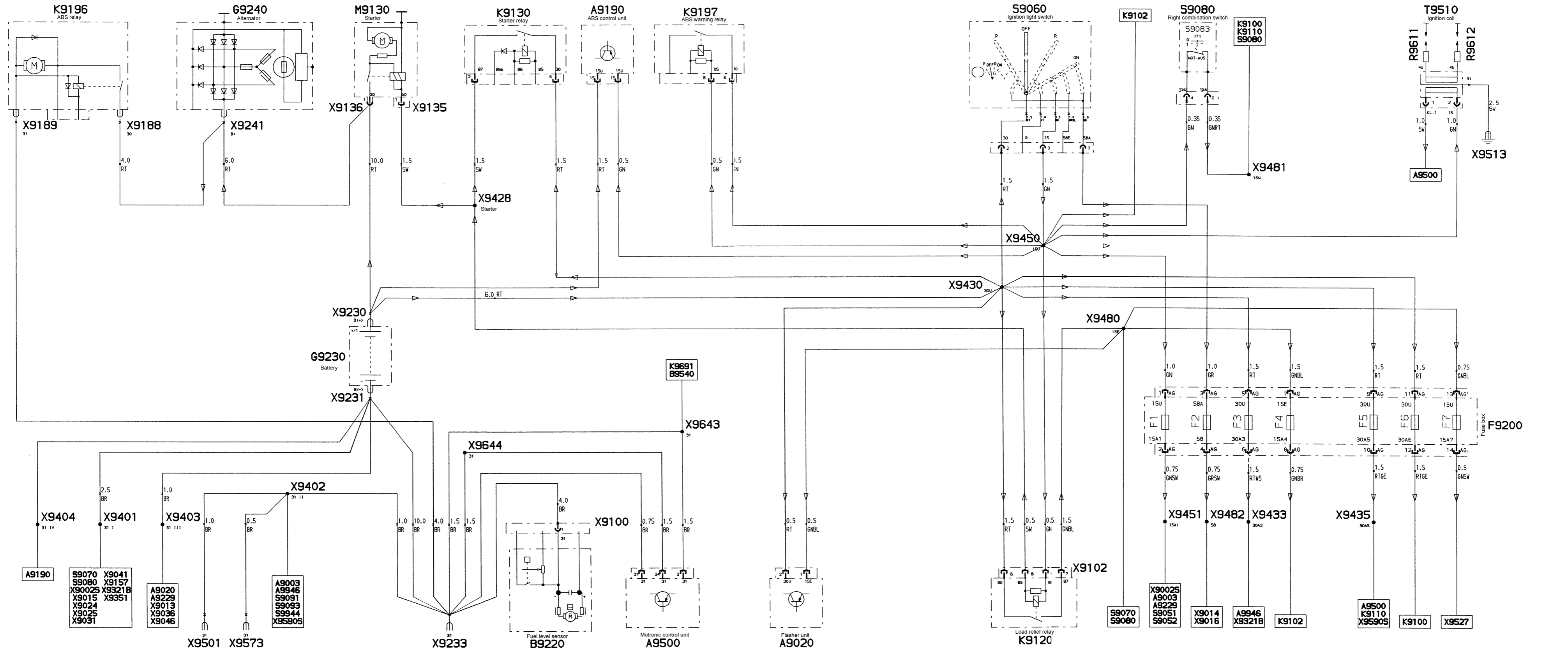

Schematic

Starter / Alternator

R 1150 GS (Model '00)

A

A9003 Indicator lamp panel

F

F9200 Fuse box

G

G9230 Battery

G9240 Alternator

H

H9002 Idle speed indicator lamp

H9240 Battery charge indicator lamp

K

K9101 Double relay Base, motronic/fuel pump relay

K9130 Starter relay

M

M9130 Starter

S

S9060 Ignition light switch

S9080 Right combination switch

S9083 Emergency stop switch

S9084 Starter switch

S9091 Clutch switch

S9093 Prop stand switch

V

V9400 Diode

X

X9135 Plug connection

X9136 Plug connection

X9230 Battery positive

X9231 Battery ground

X9233 Gearbox ground

X9241 Plug connection

X9242 Plug connection

X9380 Solder point.

X9402 Solder point.

X9410 Plug connection

X9411 Plug connection

X9428 Solder point

X9430 Solder point

X9450 Solder point

X9451 Solder point

X9481 solder point

X9590 Diagnostic connector

Starter / Alternator

DENSO GENERATOR

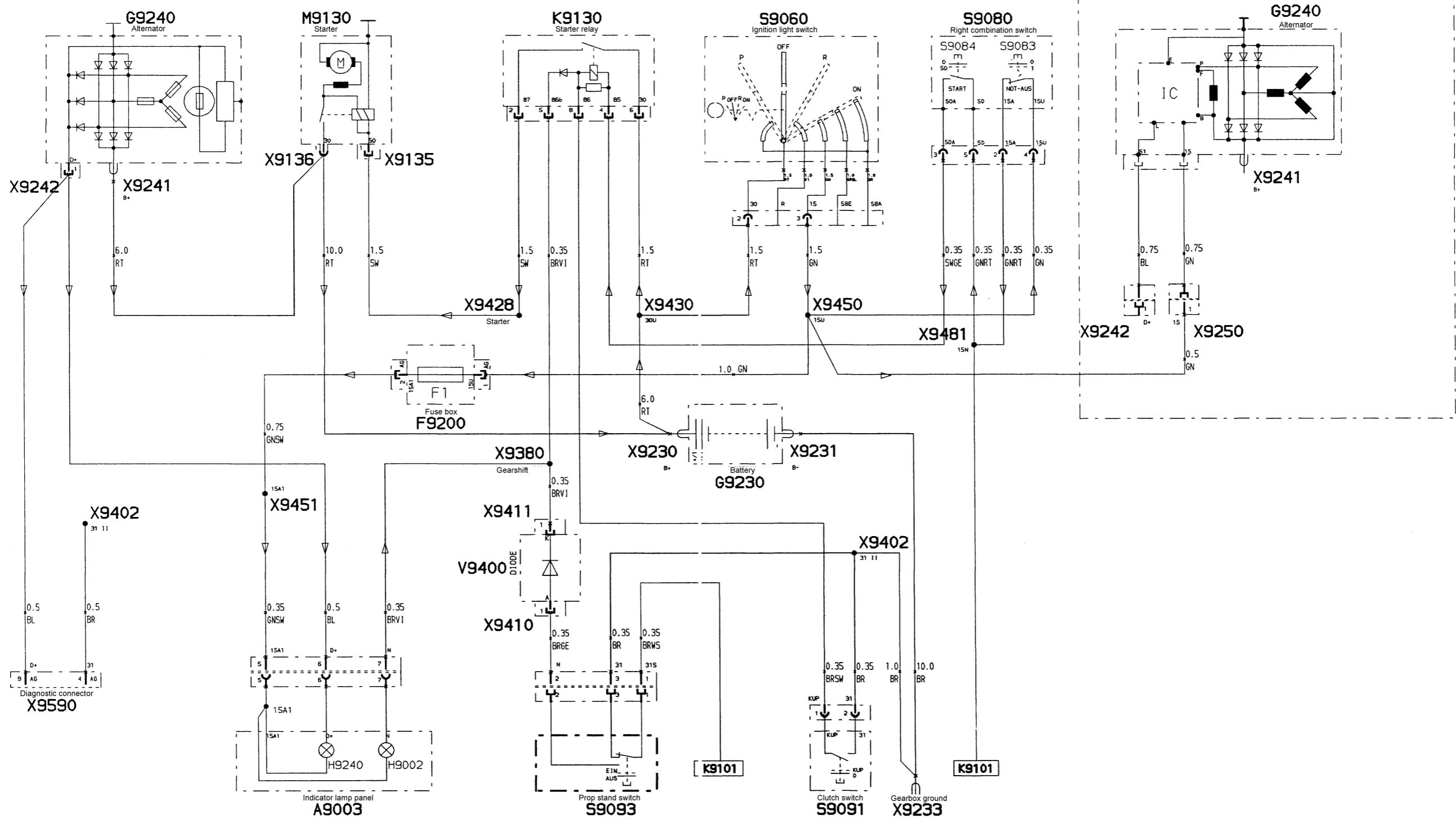

Schematic

Motronic with Outputs

R 1150 GS (Model '00)

A

A9003 Indicator lamp panel
A9229 Dial needle damping
A9500 Motronic control unit

B

B9220 Fuel level sensor

F

F9200 Fuse box

G

G9230 Battery

H

H9095 Oil pressure indicator lamp
H9220 Fuel warning lamp

K

K9100 Fuel pump relay
K9110 Motronic relay

R

R9611 Spark plug 1
R9612 Spark plug 2

S

S9060 Ignition light switch
S9080 Right combination switch
S9083 Emergency stop switch
S9093 Prop stand switch
S9095 Oil pressure switch

T

T9510 Ignition coil

X

X9002 Plug connection, tachometer
X9100 Plug connection
X9101 Plug connection
X9230 Battery positive
X9231 Battery ground
X9233 Gearbox ground
X9390 Solder point
X9402 Solder point.
X9403 Solder point
X9430 Solder point
X9435 Solder point
X9450 Solder point
X9451 Solder point
X9467 solder point
X9481 solder point
X9501 Plug connection
X9513 Ground
X9590 Diagnostic connector
X9644 Solder point
X9650 Solder point
X9660 Solder point

Y

Y9572 Timing valve
Y9601 Valve 1
Y9602 Valve 2

Motronic with Outputs

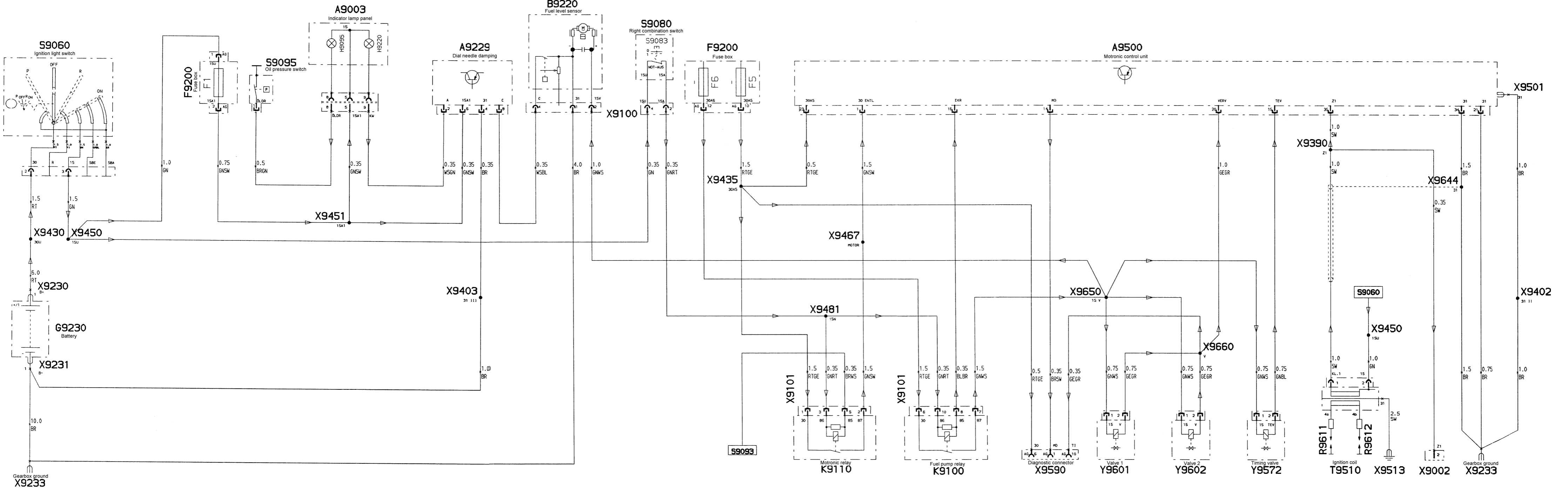

Schematic

Motronic with Inputs

R 1150 GS (Model '00)

A

A9500 Motronic control unit

B

B9540 Hall sensor

B9550 Air temperature sensor

B9561 Oil temperature sensor

B9690 Oxygen sensor

F

F9200 Fuse box

K

K9100 Fuel pump relay

K9110 Motronic relay

K9691 Coding plug CAT provisions

R

R9570 Throttle potentiometer

S

S9093 Prop stand switch

X

X9101 Plug connection

X9233 Gearbox ground

X9402 Solder point.

X9435 Solder point

X9481 solder point

X9501 Plug connection

X9573 Plug connection

X9642 Solder point

X9643 Solder point

X9644 Solder point

X9650 Solder point

X9671 Solder point

Motronic with Inputs

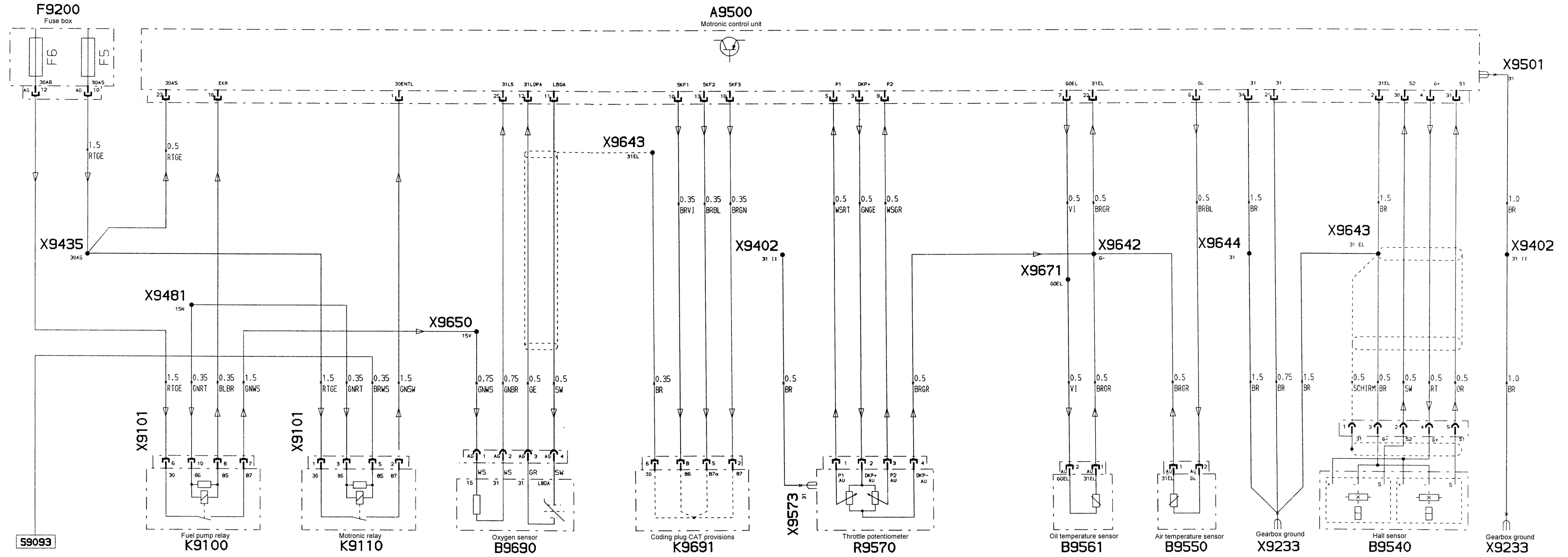

Schematic

ABS

R 1150 GS (Model '00)

A

A9003 Indicator lamp panel
A9190 ABS control unit

B

B9193 Front ABS sensor
B9194 Rear ABS sensor

F

F9200 Fuse box

G

G9230 Battery
G9240 Alternator

H

H9010 Lamp indicator lamp
H9190 ABS indicator lamp

K

K9196 ABS relay
K9197 ABS warning relay

M

M9130 Starter

S

S9060 Ignition light switch
S9080 Right combination switch

X

X9136 Plug connection
X9188 Plug connection
X9189 Plug connection
X9196 Plug connection
X9230 Battery positive
X9231 Battery ground
X9233 Gearbox ground
X9241 Plug connection
X9402 Solder point.
X9404 Solder point.
X9430 Solder point
X9450 Solder point
X9451 Solder point
X9590 Diagnostic connector

ABS

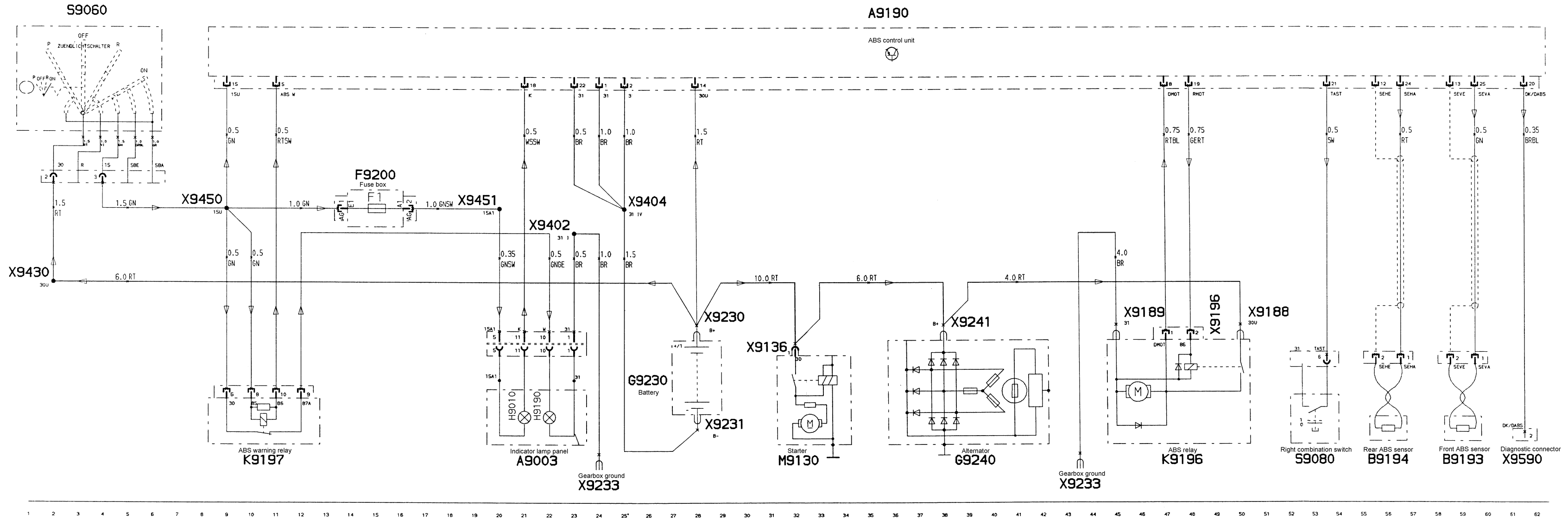

Schematic

Driver Information Display (FID)

R 1150 GS (Model '00)

A

A9500 Motronic control unit
A9946 Driver information display (FID)

B

B9220 Fuel level sensor
B9550 Air temperature sensor
B9561 Oil temperature sensor

F

F9200 Fuse box

K

K9101 Double relay Base, motronic/fuel pump relay

R

R9570 Throttle potentiometer

S

S9944 Neutral safety switch

X

X9100 Plug connection
X9230 Battery positive
X9233 Gearbox ground
X9380 Solder point.
X9402 Solder point.
X9430 Solder point
X9433 Solder point
X9467 solder point
X9642 Solder point
X9671 Solder point

Driver Information Display (FID)

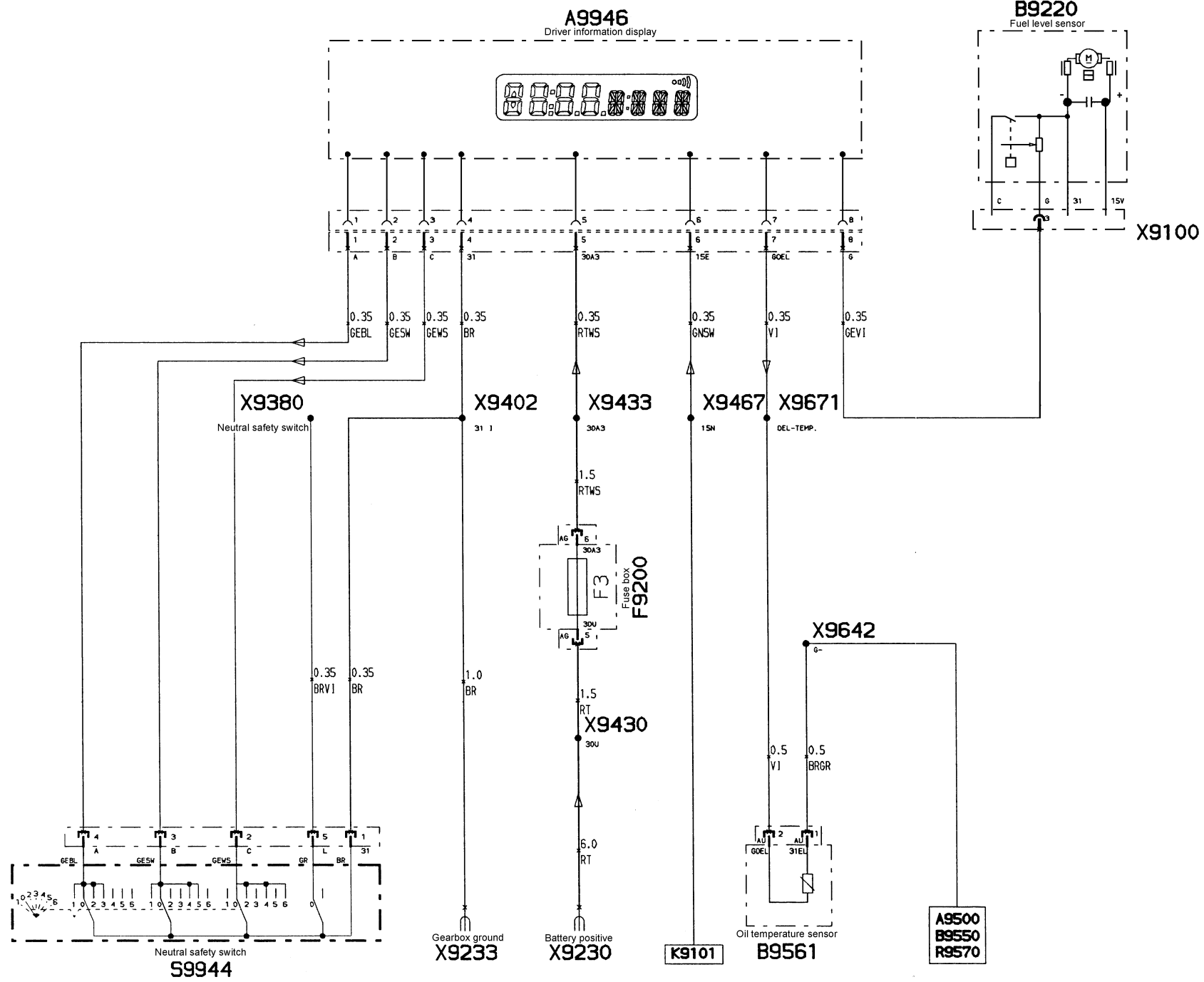

Schematic

Heating, Anti-theft system, Socket

R 1150 GS (Model '00)

A

A9020 Flasher unit

A9500 Motronic control unit

F

F9200 Fuse box

G

G9230 Battery

R

R9931 Left heater control

R9932 Right heater control

S

S9060 Ignition light switch

S9080 Right combination switch

S9930 Switch for heated handles

X

X9002 Plug connection, tachometer

X9230 Battery positive

X9231 Battery ground

X9321 Socket connection

X9351 Plug connection

X9354 Plug connection

X9390 Solder point

X9401 Solder point.

X9430 Solder point

X9433 Solder point

X9450 Solder point

X9451 Solder point

X9480 solder point

X9483 Solder point

X9484 solder point

X9527 Plug connection

X9933 Solder point

Heating, Anti-theft System, Socket

