



#51245  
10 DESIGNS



## BOUTIQUE KEY FOBS

It is a violation of Copyright law to make and distribute copies of electronic designs or artwork.  
Electronic designs are licensed to the original purchaser for use at one location. ©2020 OESD, LLC. All rights reserved.

# MATERIALS



## Isacord Thread Colors

0015 White  
0504 Mimosa  
0660 Vanilla  
1351 Starfish  
1720 Not Quite Red  
2900 Deep Purple  
3350 Lavender Whisper  
3450 Lavender  
5220 Silver Sage  
7019 (SN2) Charcoal

# DESIGNS



Note: Some designs in this collection may have been created using unique special stitches and/or techniques. To preserve design integrity when rescaling or rotating designs in your software, always rescale or rotate designs using the handles directly on-screen.

## 51245-01 Single Rose Key Fob



Size Inches:	Size mm:	Stitch Count:
<b>3.40 X 1.75 in.</b>	<b>86.4 X 44.5 mm</b>	<b>3525 St.</b>
■ 1. Cork Placement Stitch.....		7019
■ 2. Cork Tackdown.....		7019
■ 3. Gold Leaves.....		0504
■ 4. Aqua Leaves.....		5220
■ 5. Rose.....		1720
■ 6. Gray Detail.....		7019
■ 7. Back Cork Tackdown.....		7019

## 51245-02 Butterfly Key Fob



Size Inches:	Size mm:	Stitch Count:
<b>2.59 X 3.73 in.</b>	<b>65.8 X 94.7 mm</b>	<b>11019 St.</b>
■ 1. Cork Placement Stitch.....		7019
■ 2. Cork Tackdown.....		7019
■ 3. Aqua Wing Detail.....		5220
■ 4. Purple Wing Detail.....		2900
■ 5. Peach Wing Detail.....		1351
■ 6. Lavender Wing Detail.....		3450
■ 7. Gold Wing Detail.....		0504
□ 8. White Wings and Body.....		0015
■ 9. Grey Detail.....		7019
■ 10. Wing Dots.....		1351
■ 11. Back Cork Tackdown.....		7019

# DESIGNS



Note: Some designs in this collection may have been created using unique special stitches and/or techniques. To preserve design integrity when rescaling or rotating designs in your software, always rescale or rotate designs using the handles directly on-screen.

## FABRIC REQUIRED



### 51245-03 Floral Applique 1 Key Fob

Size Inches:                      Size mm:                      Stitch Count:  
**2.95 X 2.67 in.      74.9 X 67.8 mm      5527 St.**

- 1. Cork Placement Stitch..... 7019
- 2. Cork Tackdown..... 7019
- 3. Purple Fabric Placement Stitch..... 2900
- 4. Cut Line and Tackdown..... 2900
- 5. Cover Stitch..... 2900
- 6. Aqua Leaves..... 5220
- 7. Rose..... 1720
- 8. Gold Leaves..... 0504
- 9. Grey Detail..... 7019
- 10. Back Cork Tackdown..... 7019

### 51245-04 Feather Key Fob



Size Inches:                      Size mm:                      Stitch Count:  
**3.87 X 2.03 in.      98.3 X 51.6 mm      4784 St.**

- 1. Cork Placement Stitch..... 7019
- 2. Cork Tackdown..... 7019
- 3. Red Detail..... 1720
- 4. Peach Detail..... 1351
- 5. Aqua Detail..... 5220
- 6. Purple Detail..... 2900
- 7. Gray Detail..... 7019
- 8. Back Cork Tackdown..... 7019

# DESIGNS



Note: Some designs in this collection may have been created using unique special stitches and/or techniques. To preserve design integrity when rescaling or rotating designs in your software, always rescale or rotate designs using the handles directly on-screen.

## 51245-05 Initial Round Frame Key Fob

Size Inches:                      Size mm:                      Stitch Count:  
**2.89 X 2.50 in.    73.4 X 63.5 mm    2125 St.**



- 1. Cork Placement Stitch..... 7019
- 2. Cork Tackdown..... 7019
- 3. Rose..... 1720
- 4. Gold Leaves..... 0504
- 5. Aqua Leaves..... 5220
- 6. Gray Detail..... 7019
- 7. Back Cork Tackdown..... 7019

## 51245-06 Initial Diamond Frame Key Fob

Size Inches:                      Size mm:                      Stitch Count:  
**3.18 X 2.97 in.    80.8 X 75.4 mm    1845 St.**



- 1. Cork Placement Stitch..... 7019
- 2. Cork Tackdown..... 7019
- 3. Rose..... 1720
- 4. Aqua Leaves..... 5220
- 5. Gold Leaves..... 0504
- 6. Gray Detail..... 7019
- 7. Back Cork Tackdown..... 7019

# DESIGNS



Note: Some designs in this collection may have been created using unique special stitches and/or techniques. To preserve design integrity when rescaling or rotating designs in your software, always rescale or rotate designs using the handles directly on-screen.

## FABRIC REQUIRED



### 51245-07 Floral Applique 2 Key Fob

Size Inches:                      Size mm:                      Stitch Count:  
**2.95 X 2.67 in.      74.9 X 67.8 mm      7917 St.**

- 1. Cork Placement Stitch..... 7019
- 2. Cork Tackdown..... 7019
- 3. White Fabric Placement Stitch ..... 3350
- 4. Cut Line and Tackdown ..... 3350
- 5. Light Lavender Petals..... 3350
- 6. Lavender Petals ..... 3450
- 7. Red Detail..... 1720
- 8. Gold Detail..... 0504
- 9. Cover Stitch..... 5220
- 10. Gray Detail ..... 7019
- 11. Back Cork Tackdown..... 7019

### 51245-08 Floral Name Drop Key Fob

Size Inches:                      Size mm:                      Stitch Count:  
**3.63 X 2.79 in.      92.2 X 70.9 mm      4691 St.**



- 1. Cork Placement Stitch..... 7019
- 2. Cork Tackdown..... 7019
- 3. Gold Detail..... 0504
- 4. Leaves..... 5220
- 5. Red Flowers ..... 1720
- 6. Lavender Petals ..... 3450
- 7. Gray Outlines ..... 7019
- 8. Back Cork Tackdown..... 7019

# DESIGNS



Note: Some designs in this collection may have been created using unique special stitches and/or techniques. To preserve design integrity when rescaling or rotating designs in your software, always rescale or rotate designs using the handles directly on-screen.

## 51245-09 Two Roses Key Fob

Size Inches:                      Size mm:                      Stitch Count:  
**2.82 X 2.07 in.    71.6 X 52.6 mm    3827 St.**



- 1. Cork Placement Stitch..... 7019
- 2. Cork Tackdown..... 7019
- 3. Leaves..... 5220
- 4. Red Rose..... 1720
- 5. Peach Rose..... 1351
- 6. Gray Detail..... 7019
- 7. Back Cork Tackdown..... 7019

## 51245-10 Magic Rose Key Fob

Size Inches:                      Size mm:                      Stitch Count:  
**2.92 X 2.67 in.    74.2 X 67.8 mm    6026 St.**



- 1. Cork Placement Stitch..... 7019
- 2. Cork Tackdown..... 7019
- 3. Leaves..... 5220
- 4. Hands..... 0660
- 5. Rose..... 1720
- 6. Gray Detail..... 7019
- 7. Back Cork Tackdown..... 7019

# MATERIALS



## Supplies

- Fusible Woven
- Medium Weight TearAway

## Fabric/Notions

- Fabric for applique (designs 51245-03 & 51245-07)
- (2) 4" squares of cork for each fob
- Expert Embroidery Tape TearAway
- Perfect Punch



# EMBROIDERY



## Step 1 (Designs 51245-03 and 07)

- Hoop 1 layer of Medium Weight TearAway
- Stitch Machine Step 1, Cork Placement Stitch.

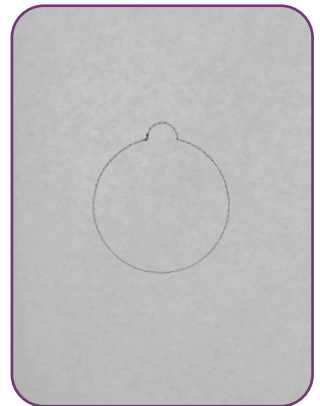

## Step 2

- Remove hoop from machine, but DO NOT remove project from hoop.
- Place cork fabric over the placement stitch, make sure it is completely covered.
- Tape in place with Expert Embroidery Tape TearAway.

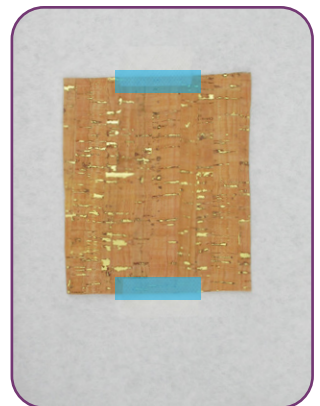

## Step 3

- Return hoop to machine and stitch Machine Step 2, Cork Tackdown.

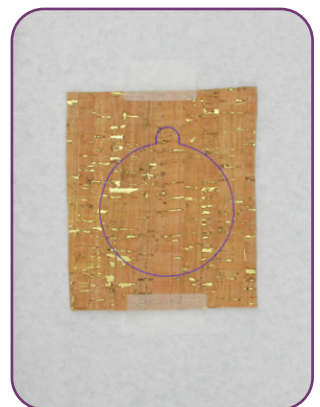

# EMBROIDERY



## Step 4

- Stitch Machine Step 3, Fabric Placement Stitch.

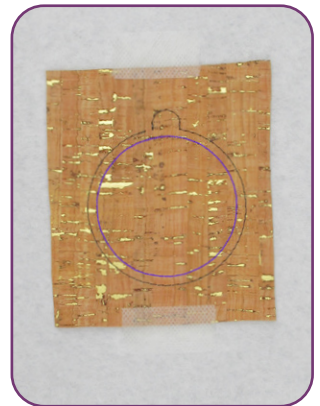

## Step 5

- Apply Fusible Woven to the wrong side of your applique fabric. Place your applique fabric over the placement stitch, making sure it is completely covered.
- Tape in place.

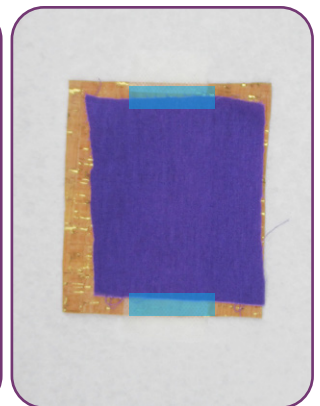
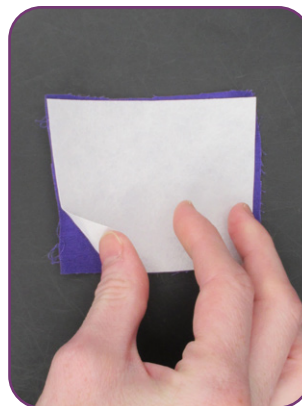

## Step 6

- Stitch Machine Step 4, Tackdown and Cut Line and Tackdown.

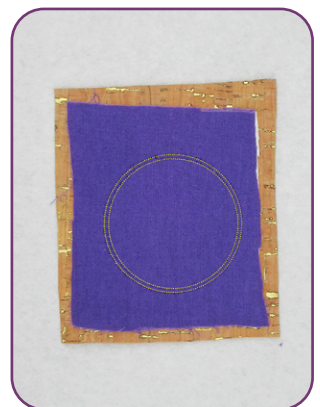

# EMBROIDERY



## Step 7

- Remove the hoop from the machine, do NOT remove the project from the hoop.
- Trim close to the the Cut Line without cutting into it.
- Return the hoop to the machine.

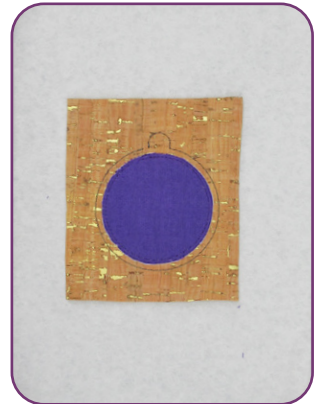

## Step 8

- Continue stitching design. Stop BEFORE the last Machine Step, Back Tackdown.
- Remove hoop from machine, but DO NOT remove project from hoop.
- Flip hoop over and place cork fabric over the design, making sure it is covered completely.
- Tape corners to hold in place.

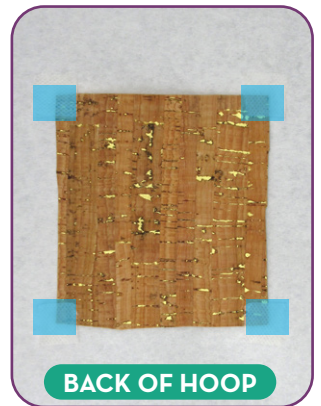

## Step 9

- Insert a bobbin with thread to match the top thread.
- Return hoop to machine and stitch final Machine Step, Back Tackdown.

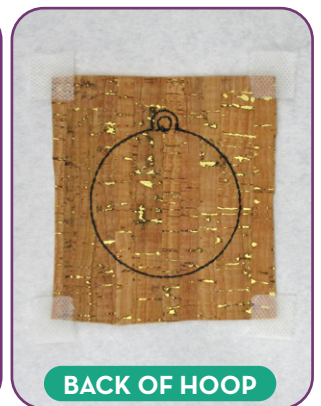

# EMBROIDERY



## Step 10

- Remove hoop from machine and project from hoop.
- Trim  $\frac{1}{8}$ " away from the outer stitching.
- Place the key fob on a small block of wood or on an outer edge of a cutting mat. Use the Perfect Punch with the 3mm tip and punch a hole in the top of the key fob as shown.



# EMBROIDERY



## Step 1 (Designs 51245-01, 02, 04,-06, & 08-10)

- Hoop 1 piece of Medium Weight TearAway.
- Stitch Machine Step 1, Cork Placement Stitch.



## Step 2

- Place a piece of cork right side up, covering the placement stitch.
- Tape in place.

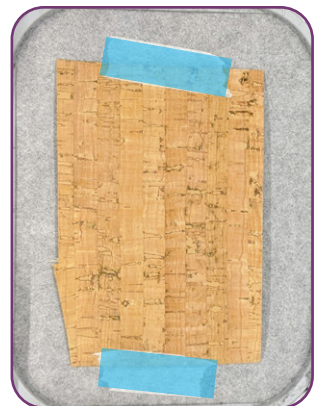

## Step 3

- Stitch Machine Step 2, the Cork Tackdown Stitch. Photo 3

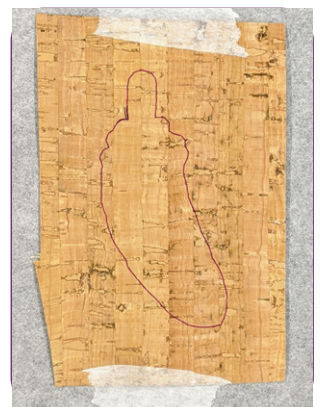

# EMBROIDERY



## Step 4

- Stitch remaining colors per thread chart, STOP before the final color change.



## Step 5

- Remove the hoop from the machine, do NOT remove the project from the hoop.
- Turn hoop over and place a piece of cork right side up, covering the placement stitch entirely. Tape in place.



## Step 6

- Return the hoop to the machine.
- Insert a bobbin with thread to match the top thread and stitch the last Machine Step, Back Cork Tackdown.



# EMBROIDERY



## Step 7

- Remove the hoop from the machine.
- Trim cork approximately 1/8" from the stitching.

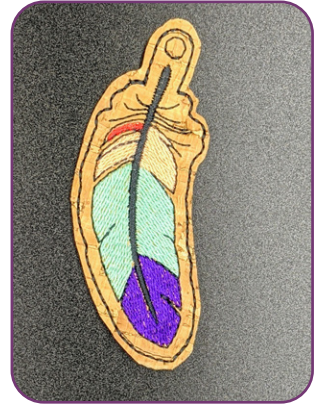

## Step 8

- Place the key fob on a small block of wood or on an outer edge of a cutting mat.
- Use the Perfect Punch with the 3mm tip and punch a hole in the top of the key fob as shown.

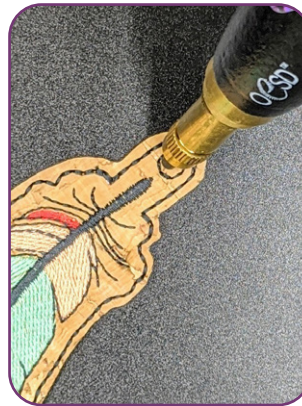

# INSTRUCTIONS



## ATTENTION

When printing this document, any page scaling or page fitting options in your print dialog box must be turned OFF or set to NONE so that your files will print out at their actual size. Images not printed at actual size will not function as intended.

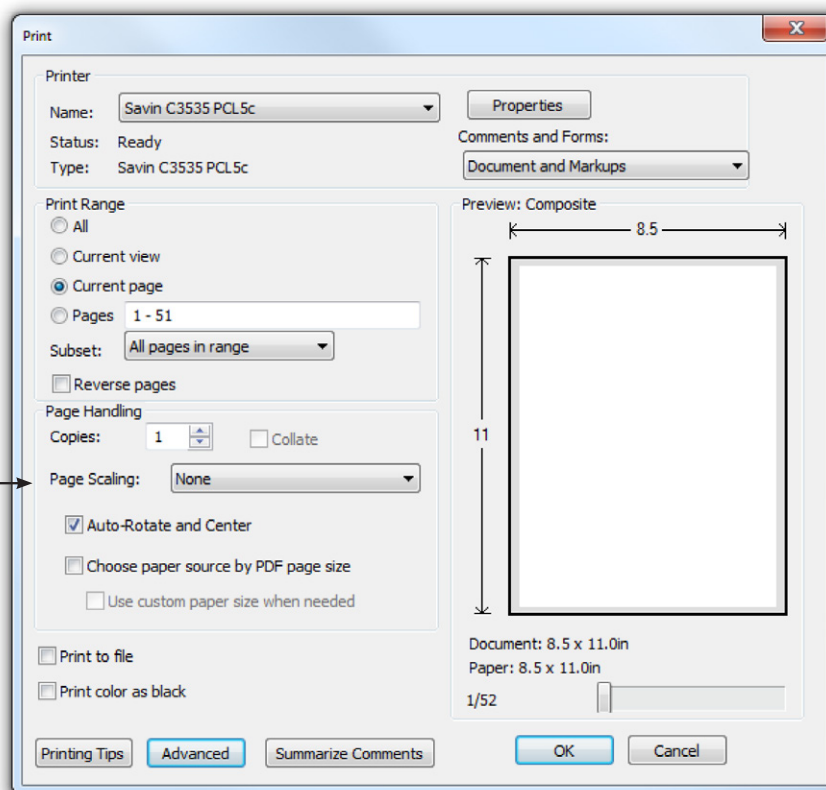

## TO SAVE PAPER

Only print the desired image by navigating to the image's page, go to File > Print and select "Current page" in the print dialog box. Repeat for each desired image.

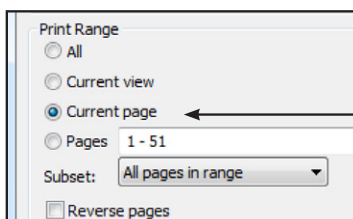



# APPLIQUE PATTERNS

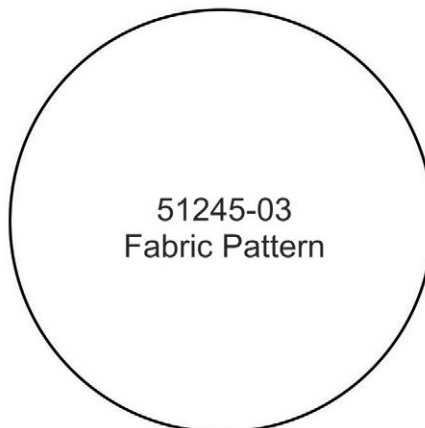
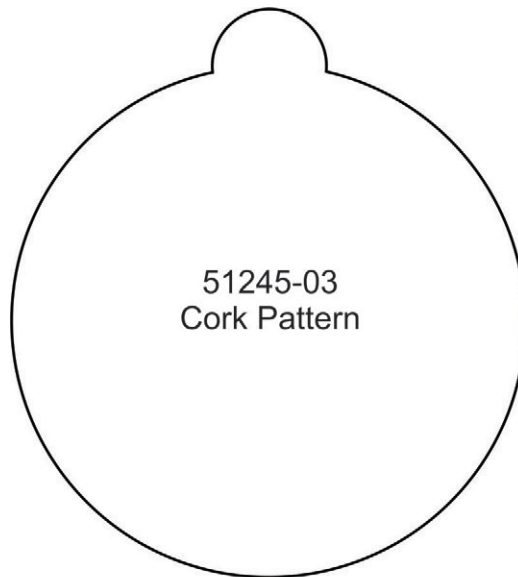
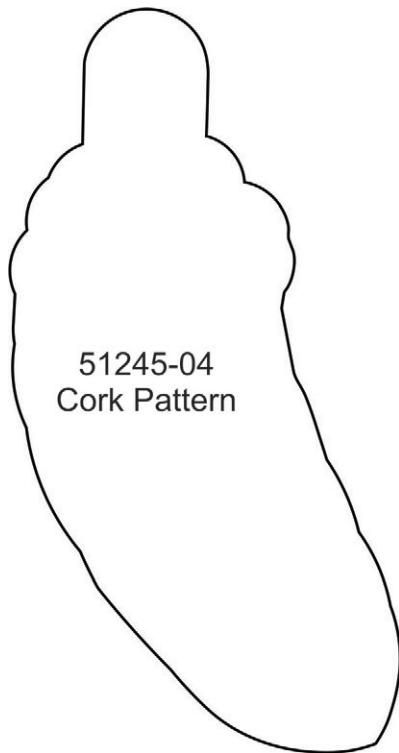
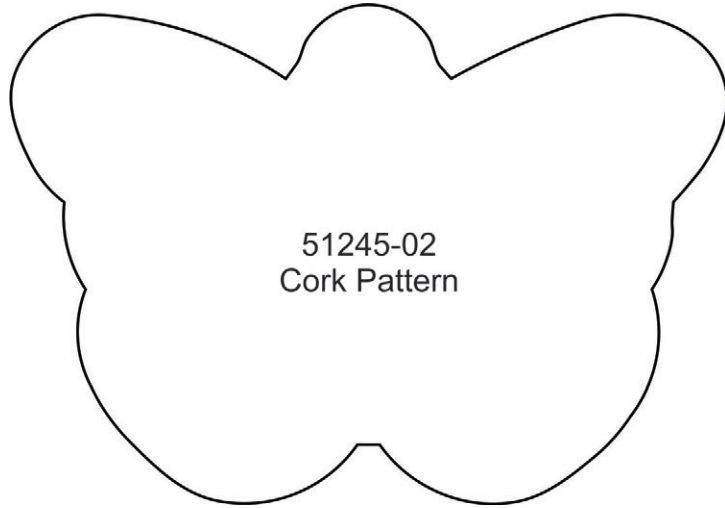

# APPLIQUE PATTERNS



51245-05  
Cork Pattern



51245-06  
Cork Pattern

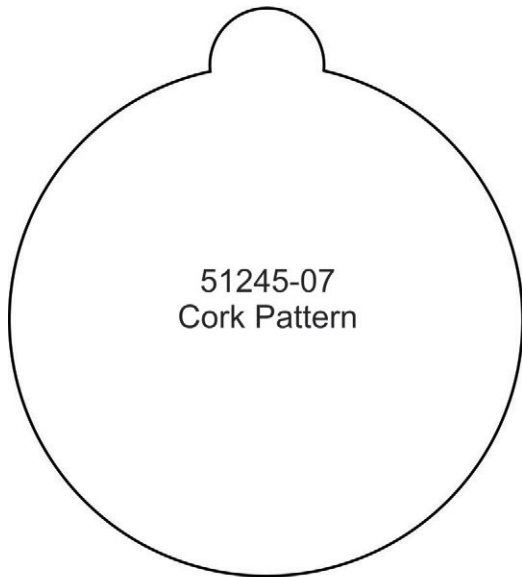

51245-07  
Cork Pattern

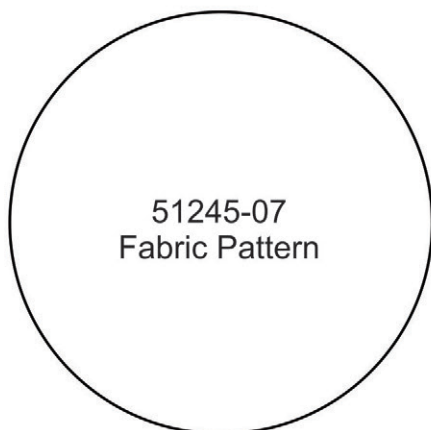

51245-07  
Fabric Pattern

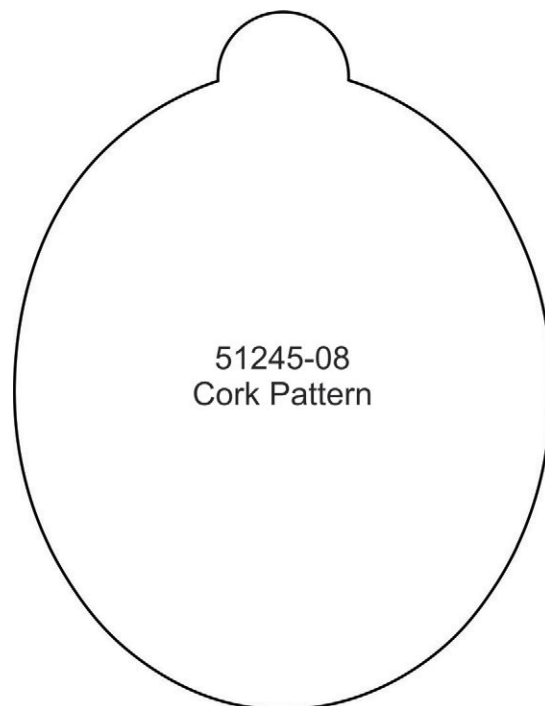

51245-08  
Cork Pattern

# APPLIQUE PATTERNS

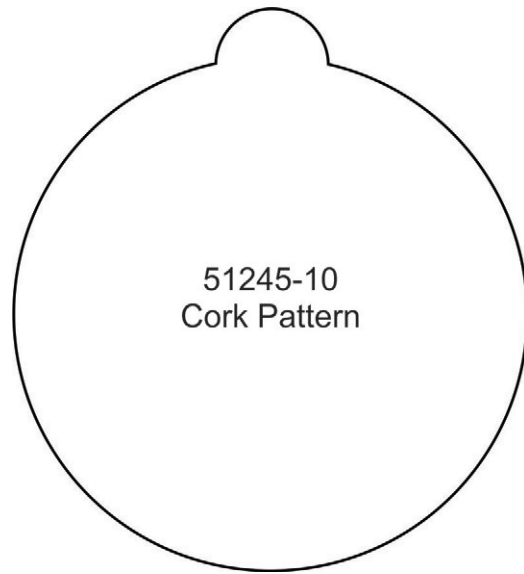
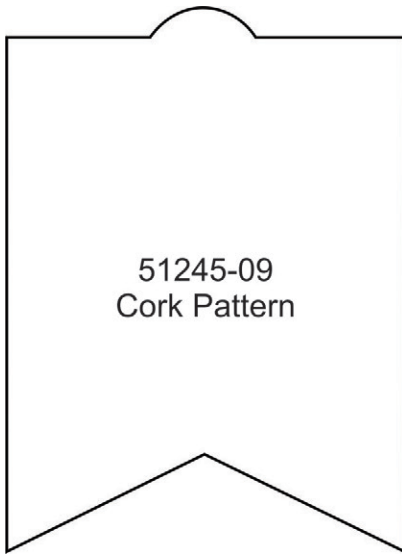

# MIRRORED PATTERNS

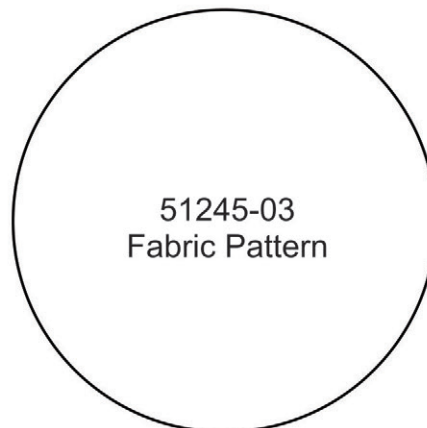
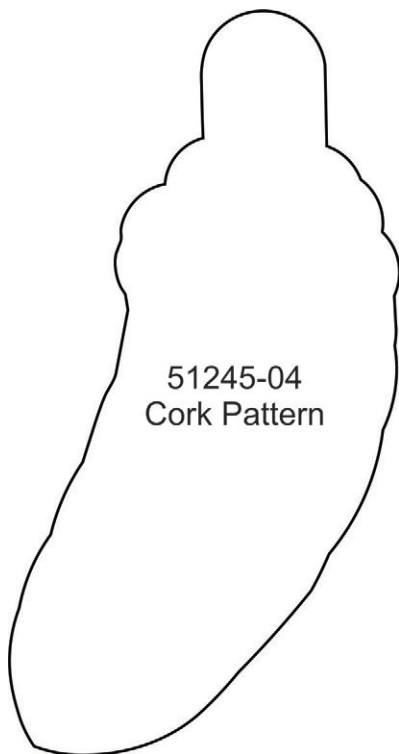
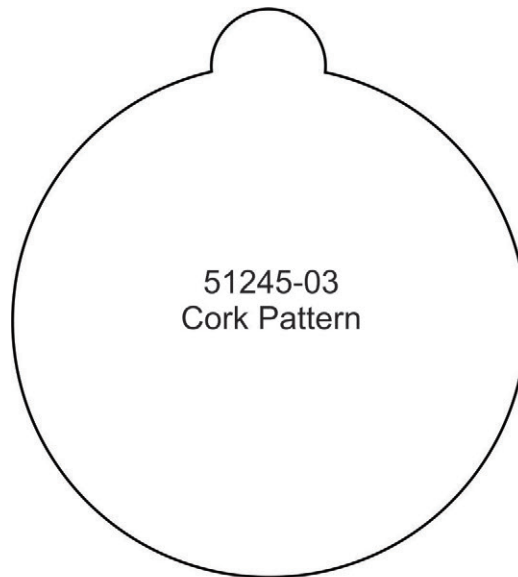
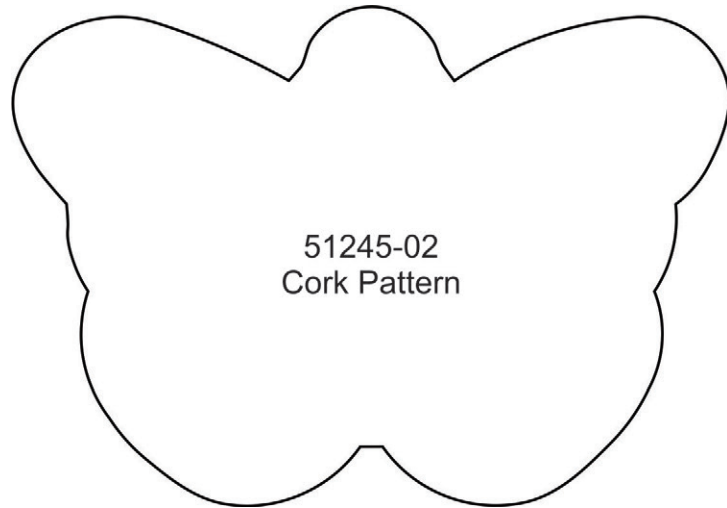

# MIRRORED PATTERNS

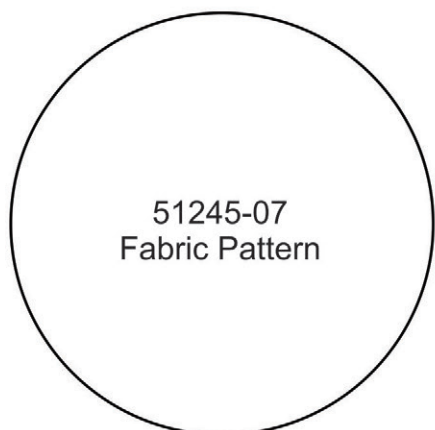
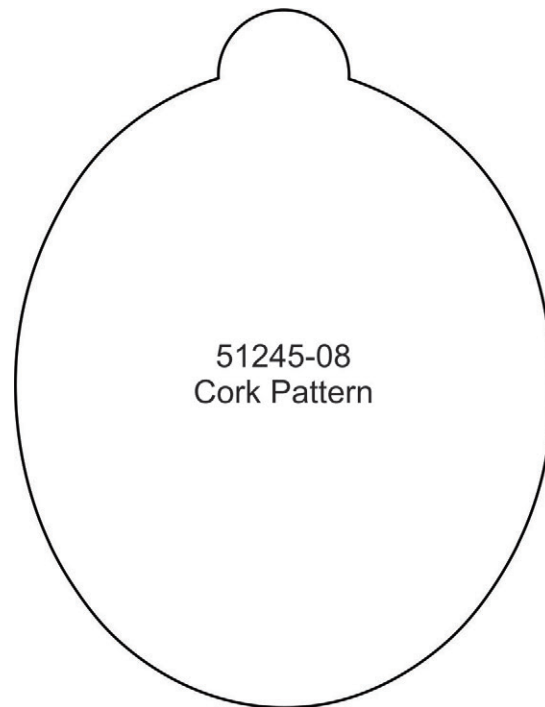
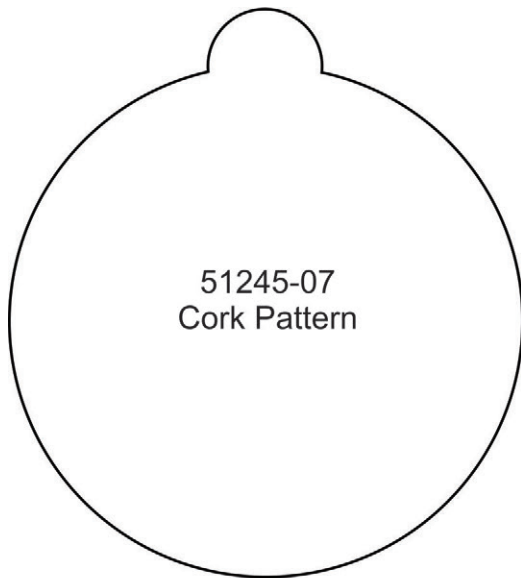

# MIRRORED PATTERNS

