

Seiko Australia Pty Ltd

SEIKO

PULSAR

 LORUS

BRACELET SIZING MANUAL

BRACELET SIZING MANUAL

Contents

SEIKO

Introduction	1
(I) General Information	2
(II) Suggested Tools	3
(III) Bracelet Sizing Codes And Methods	4
1. Sizing Code I and W	4
I Split-Pin Type	
W Waved-Split-Pin Type	
2. Sizing Code C and P	6
C Pin & Split-Pipe (C-Ring) Type	
P Pin & Pipe Type	
3. Sizing Code E	10
E Clip-Spring Type	
4. Sizing Code L	12
L Sliding-Clasp Type	
5. Three-Fold Clasp	13
6. Adjustment of The Divers' Extender	14
Diver Adjuster	
Diver Extender	
(IV) Clasp Adjustment - Tips For Tightening Clasps	16

PULSAR & LORUS

General Information	17
Two Sided Bracelet Cutting	18
One Sided Bracelet Cutting	18
Free Pin & C-Ring or Pipe	19
Pushpin Type	20
Clip Spring Type	20
Screw Pin Type	21
Center Clip Pin Type	21
Fixing Pin Type	22
Fixing Pipe & Pin Head Type	22
Sliding Clasp Type	23
Expansion Bracelet Type A	24
Expansion Bracelet Type B	24
Expansion Bracelet Type C	24
Expansion Bracelet Type D	25
Three folded Clasp	26
Cord Sizing	28
Clasp Adjustment	29

Introduction

We have compiled a new guide explaining different sizing methods by bracelet sizing codes, which is commonly used for current watch models.

The photos of the suggested tools for each bracelet type are contained.

In addition, we placed the photos of the sizing procedures for the easier understanding.

The band sizing code is engraved next to a dot after the band no. as shown below.

Ex.

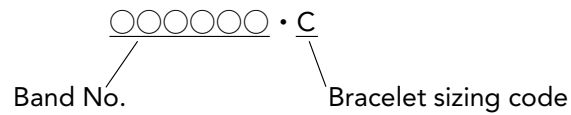

The instructions in this manual should prove to be a valuable reference guide for your service centers as well as dealers/retailers in the proper sizing of bracelets.

(I) General Information

1. Before you start sizing the bracelet:
 - 1) Understand the structure of the bracelet, know what kind of parts are involved
 - 2) Prepare all the necessary tools
2. Even for the same method of sizing, there may be some variation of parts' shapes.
3. Place watch on a soft surface so that the case, crystal, and bracelet will not be scratched.
4. Before sizing, accurately measure the length to be adjusted.
5. Bracelet should be adjusted on both ends so that the clasp is in the appropriate position of the wrist.
(Bracelet with a sliding clasp will be adjusted only at one end.)
6. Some bracelets have very small parts. Be careful not to lose them.
7. Save the detached links for possible future use.

(II) Suggested Tools



Multiple Band Sizing Tool
(S-926)



Bit Set
(S-92601)



Blade Set
(S-92602)



Bracelet Fixing
Attachment
(S-92604)



Spring Bar Tool
(A-MS46000)



Screwdriver
(S-914)



Tweezers
(A-TP13AA)



Clip Spring Awl
(A-SA14301)



Clip Spring Pliers
(S-919)

(III) Bracelet Sizing Codes And Methods

1. Sizing Code I and W

I: Split-Pin Type

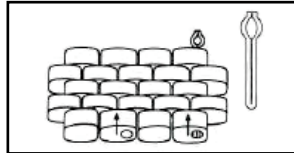

W: Waved-Split-Pin Type

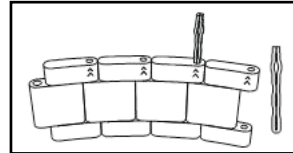

Example



SUGGESTED TOOLS



Multiple Band Sizing Tool (S-926)

Clip Spring Pliers (S-919)



Tweezers (A-TP13AA)



About the Waved-Split-Pin

The waved-split-pin is mainly adopted for the bracelets of the Seiko Elite Collection manufactured from 2009.

The features of the waved-split pin; (1) the intensity and durability is higher than the split-pin, (2) easy to adjust (pull-out force stays constant and no separated parts exist)

Removing links by using S-926

- 1) Install a removing bit on one side of the S-926 (Fig.1) , and install the band sizing holder on the other side.

Place the band on the S-926 and then turn the pressor knob clockwise so that the bit is against the link pin (from arrow direction) to push the link pin head out of the link.(Fig.2)



Fig.1

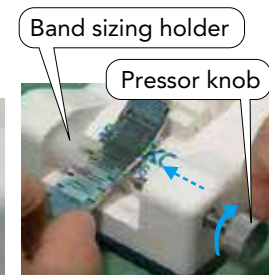

Fig.2

- 2) Turn the pressor knob counterclockwise, and then remove the band from the S-926 (Fig.3) Then remove the link pin from the link with pliers. (Fig. 4)



Fig.3



Fig.4

Note:

Be careful not to squash the open end of the pin; otherwise, the pin will become loose and will not stay in when replaced

- 3) After the pin is removed, the link will come apart.
Repeat these procedures to remove the appropriate quantities of links as required. Be sure to balance the links removed from each side.

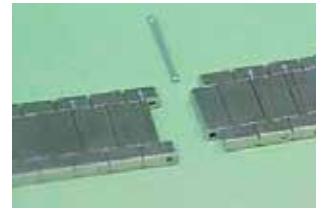

Fig.5

Reassembling

- 1) Reverse the above procedure by inserting the pin in the opposite direction of the arrow. (Fig.6)



Fig.6

- 2) After the pin is inserted in the bracelet, use the flat end of the tweezers to push it into the bracelet. (Fig.7) Then use the other end of the tweezers to seat the pin in the bracelet. Be sure that the end of the pin is pushed slightly below the edge of the bracelet.

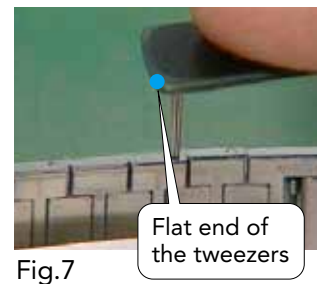

Fig.7

2. Sizing Code C and P

C: Pin & Split Pipe (C-Ring) Type

P: Pin & Pipe Type

The difference between code C and P is the type of pipe to be used as follows:

C: Split-Pipe

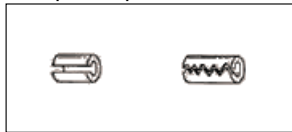

P: Pipe

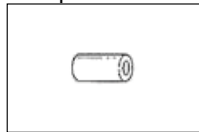

SUGGESTED TOOLS	
	Multiple Band Sizing Tool (S-926)
	Clip Spring Pliers (S-919)
	Tweezers (A-TP13AA)

There are 2 types of structures depending on the position of the pipes, [End Pipe Position] and [Hidden Pipe position]. Please make sure of the position of the pipe beforehand.

End Pipe position:

Pipe and the pin can be seen when looking sideways at the link hole (direction of arrow)

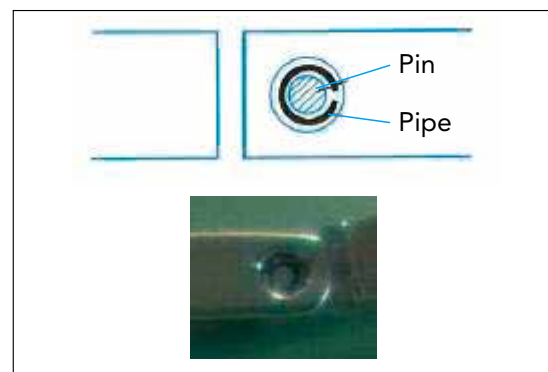
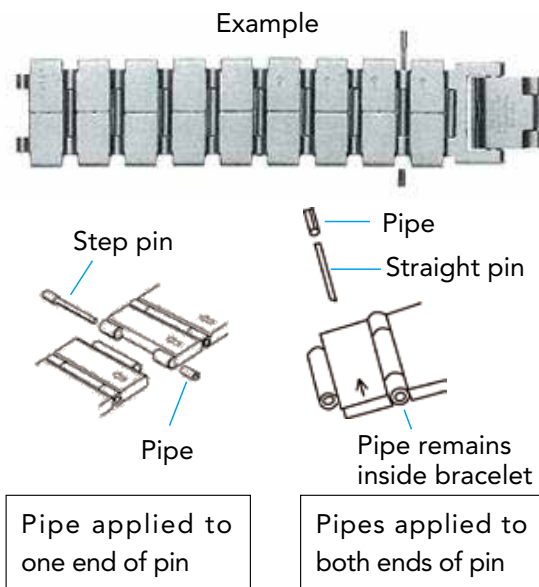

Removing links by using S-926

- 1) Install a removing bit on the S-926.(Fig.1)
Place the band against the pipe hole and press the bracelet down in the opposite direction of the arrow mark on the link.

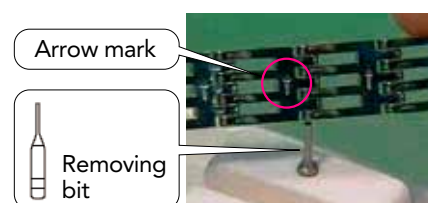

Fig.1

2) The pin is pushed out the opposite side. (Fig.2)

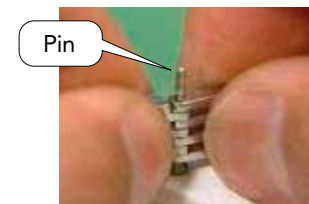

Fig.2

3) The pipe will remain on the removing bit or will remain in the side of the link from which the pin is pushed. (Fig.3)



Fig.3

4) After the pin & pipe are removed, the links may be separated. (Fig.4)



Fig.4

Repeat these procedures to remove the appropriate quantities of links as required. Be sure to balance the links removed from each side.

Reassembly

1) Align the links using the work station of S-926 (Fig.5)

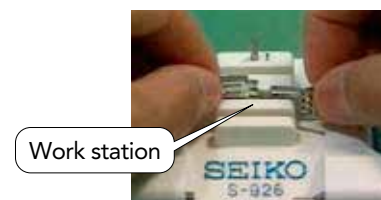

Fig.5

2) Place the pin in the opposite direction of the arrow mark on the link.(Fig.6)



Fig.6

3) Put the pipe on the tip of the S-926 holder.(Fig.7, Fig.8)

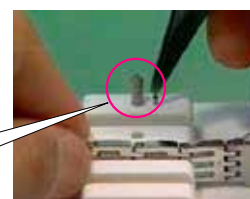
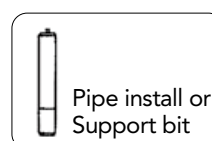

Fig.7



Fig.8

- 4) Press the pipe in the side where the pin was inserted.(Fig.9, Fig.10)

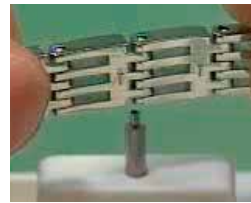

Fig.9



Fig.10

- 5) If the remaining pin is forced out, press it down by using the flat end of the tweezers. (Fig.11)

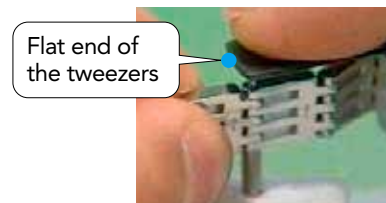
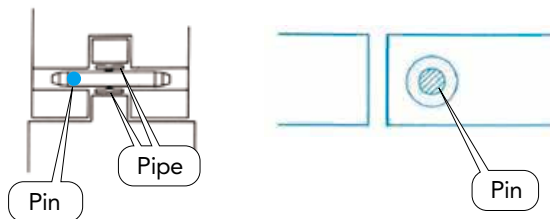

Fig.11

Hidden Pipe position:

The pin, usually straight pin, can be seen on the sides of the bracelet. The pipe is not obvious until the pin is removed.



Example



Removing links by using S-926

- 1) Using the S-926 bracelet removing bit & pin support, place the bit against the hole for the pin and press the bracelet down in the opposite direction of the arrow mark on the link. (Fig.12)

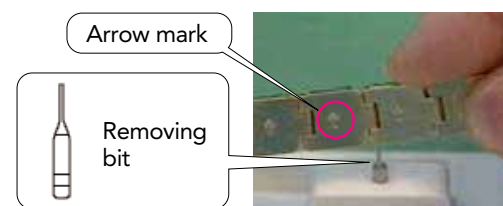

Fig.12

- 2) The pin is pushed out the opposite side. (Fig.13)

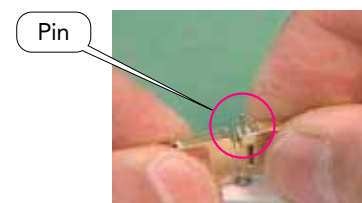

Fig.13

- 3) Hold the protruding end of the pin with pliers to pull out the pin. (Fig.14)

The pipe will remain in the middle of the link.



Fig.14

- 4) After the pin & pipe are removed, the links may be separated. (Fig.15)

Repeat these procedures to remove the appropriate quantities of links as required. Be sure to balance the links removed from each side.



Fig.15

Reassembly

- 1) Locate the hole for pipe (see the illustration).
Install the pipe into the hole of the link. (Fig.16)

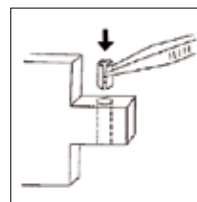

Fig.16

- 2) Match up the links together (be sure that the pipe does not fall off).(Fig.17)



Fig.17

- 3) Insert the pin into the link.
(Fig.18, Fig.19)



Fig.18

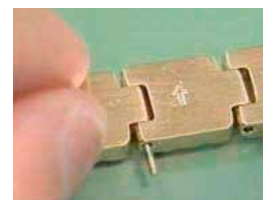

Fig.19

- 4) Press the protruding pin down by using the flat end of the tweezers. (Fig.20)



Fig.20

Press the protruding pipe down by using the pipe install bit. (Fig.21, Fig.22)



Fig.21

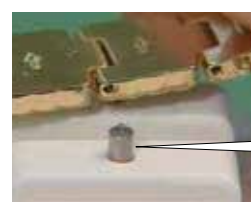
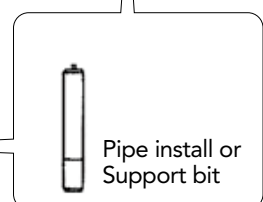

Fig.22



3. Sizing Code E

E: Clip-Spring Type

Example



Variation of clip-spring shape

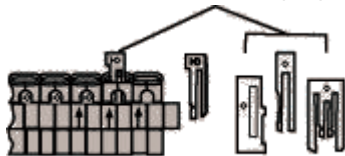

SUGGESTED TOOLS	
Clip Spring Pliers (S-919)	Clip Spring Awl (A-A14301)
	

Removing links by using S-919

- 1) Insert the pointed jaw tip of the pliers into the hole of the bracelet. (Fig.1) Catch the link frame with the other flat jaw of the pliers. At this time, be careful not to catch the clip spring. Apply force to the pliers and the clip spring is removed. (Fig.2) Be sure to push in the direction of the arrow on the back of the bracelet.

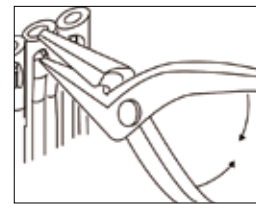

Fig.1

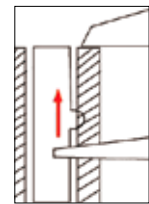

Fig.2

When using the awl (A-A14301), place it in the dimple of the clip-spring in the link. In order for the bracelet not to move, press down on the bracelet with your fingers. Push the clip-spring out of the bracelet.(Fig.3) Be careful not to hurt your fingers with the awl.



Fig.3

Arrow mark

Be sure to push in the direction of the arrow on the back of the bracelet.

- 2) Hold the protruding end of the clip-spring with pliers to pull out the clip spring. (Fig.4)

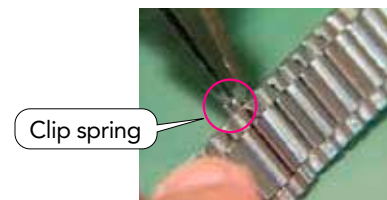

Fig.4

Clip spring

- 3) After the clip-spring pin is removed, the links may be separated.(Fig.5)

Repeat these procedures to remove the appropriate quantities of links as required. Be sure to balance the links removed from each side.



Fig.5

Reassembly

- 1) To reassemble, align the links properly and reverse the above procedure. Make sure to press down the clip spring securely into the link. (Fig.6)



Fig.6

- 2) After the clip spring pin is inserted in the bracelet, use the end of the awl to push it into the bracelet until the end of the clip spring is flat against the edge of the bracelet.(Fig.7) Instead of the end of the awl, the flat end of tweezers can be used.



Fig.7

4. Sizing Code L

L: Sliding-Clasp Type



SUGGESTED TOOLS
Screwdriver (S-914)

Loosen the locking grip of the clasp on the 6 o'clock side, and slide to adjust the clasp to the desired length.(Fig. 1)

Note:

If a slot is provided on the top of the locking grip, open the grip from only this point.

Opening the clasp

- 1) Using the screwdriver, simply pry open (up) the locking grip for adjustment (Fig. 1)
- 2) Slide the clasp (up or down) to adjust the length of the wrist size
- 3) The locking grip should be closed at the position of the depression on the reverse side of the band and the protruding point on the bottom of the clasp (Fig. 2)

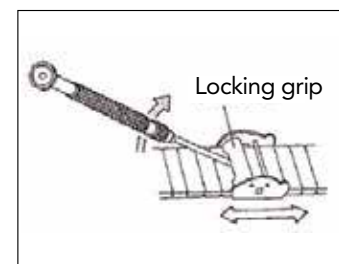

Fig.1

Closing the clasp

- 1) Press down (close) the locking grip of the clasp unit.

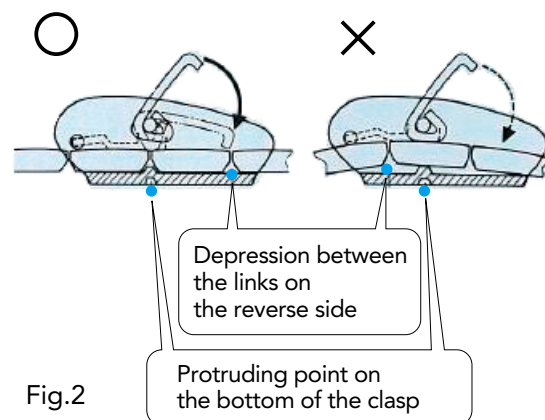
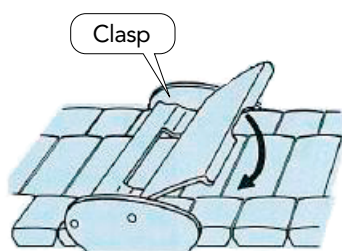
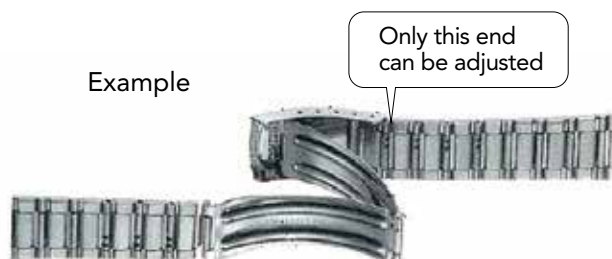

Fig.2

Note:

- * Before closing the clasp, be sure to check if the depression of the links is engaged to the protruding of the bottom of the clasp
- * After closing the clasp, be sure to check the setting condition by moving the clasp left and right strongly.

5. Three-Fold Clasp



SUGGESTED TOOLS	
Spring Bar Tool (A-MS46000)	Tweezers (A-TP13AA)

Many bracelets have threefold clasps.

These bracelets can be adjusted by moving the position of the bracelet within the clasp as illustrated.

- 1) Locate the pushpin holes on the clasp.

Use the pin pusher (Fig. 1) of a spring bar tool, press the spring bar in and twist gently for removal. (Fig.2)



Fig.1



Fig.2

- 2) Insert the pushpin in the bracelet and move the bracelet to the desired position (Fig. 3).

Make sure one end of the pin is securely in the pushpin hole and press the spring bar until it fits the top hole of the clasp. (Fig. 4)



Fig.3



Fig.4

6. Adjustment of The Divers' Extender

There are Divers' watches which have either a Diver Adjuster or a Diver Extender on the band so that the watch band can be adjusted when wearing the watch over a wet suit.

Diver Adjuster

Example



- 1) Lift up the secure lock approximately 90° until it stands upright. Do not extend the slider at this step.
- 2) Lightly push back the secure lock further approximately 20°. While more force is required than to lift up to 90°, take care not to push too forcibly.

Bracelet on the 6 o'clock side of the watch

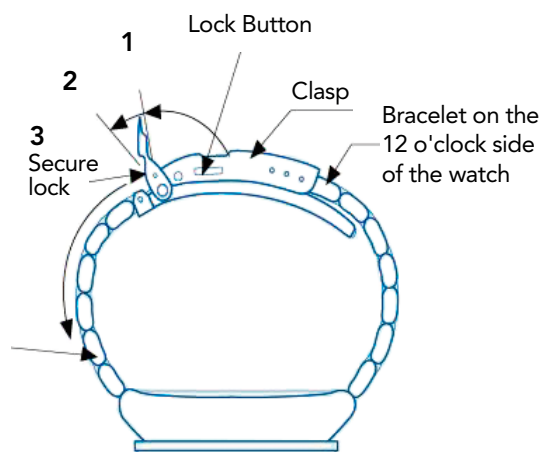

- 3) Lightly pull the bracelet on the 6 o'clock side of the watch along the curved line of the bracelet to pull out the slider. When doing so, take care not to pull the bracelet forcibly. The slider can be pulled out approximately 30mm. Be careful not to pull it out beyond the limit mark inscribed on it.

- 4) While pressing the lock button indicated by the arrow 4, lift up the clasp to release the buckle, and put on the watch on your wrist.

- 5) Close the clasp first and then, the secure lock

- 6) Hold the bracelet on both the 6 and 12 o'clock sides of the watch with fingers to reduce the length of the slider until it fits well around your wrist.

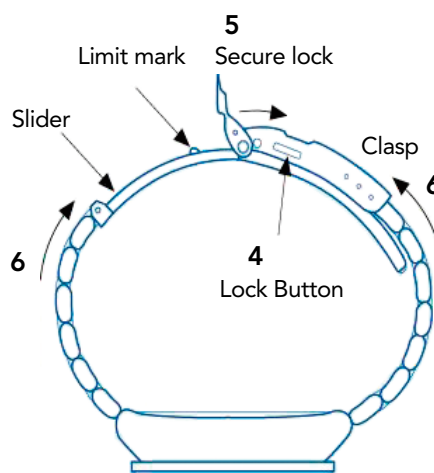

Diver Extender

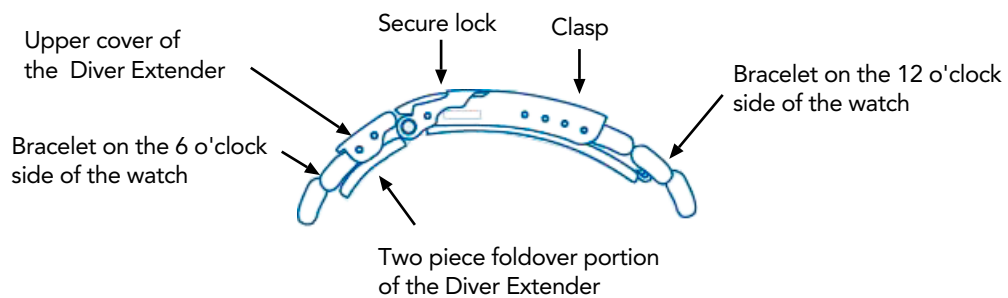
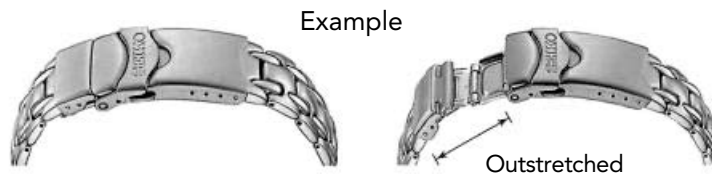

- 1) Lift up the secure lock, and then, press the button to open the clasp. After opening the clasp, push the secure lock back to the normal position for safety's sake.

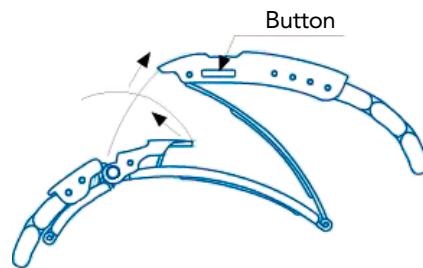

- 2) Open the two-piece foldover portion of the Diver Extender in the direction of the arrow. Some force is required to open the foldover portion, and it will click when it is opened.

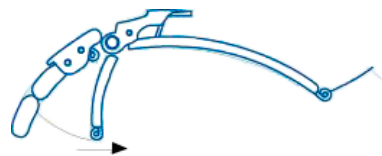

- 3) Slide the upper cover of the Diver Extender in the direction of the arrow, and then, pull it up to extend the two-piece foldover portion of the Diver Extender to the full.



- 4) Close the clasp, and then, the secure lock. When wearing your watch over a wet suit, extend the Diver Extender. To fold up the Diver Extender, reverse the procedure above. When the two-piece folder portion of the Diver Extender is folded up completely, it also clicks in the same manner as it is opened.

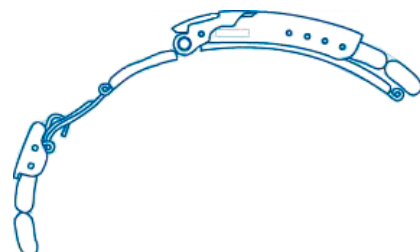

(IV) Clasp Adjustment - Tips For Tightening Clasps

Three Folded Type

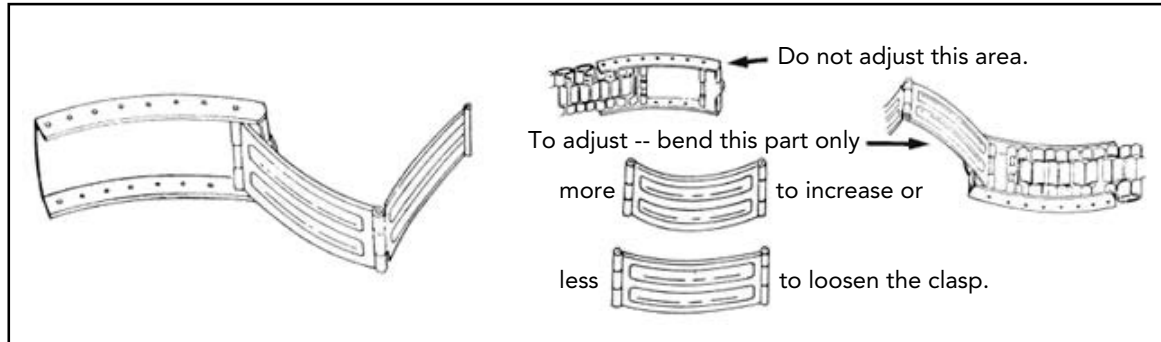

Two Folded A Type

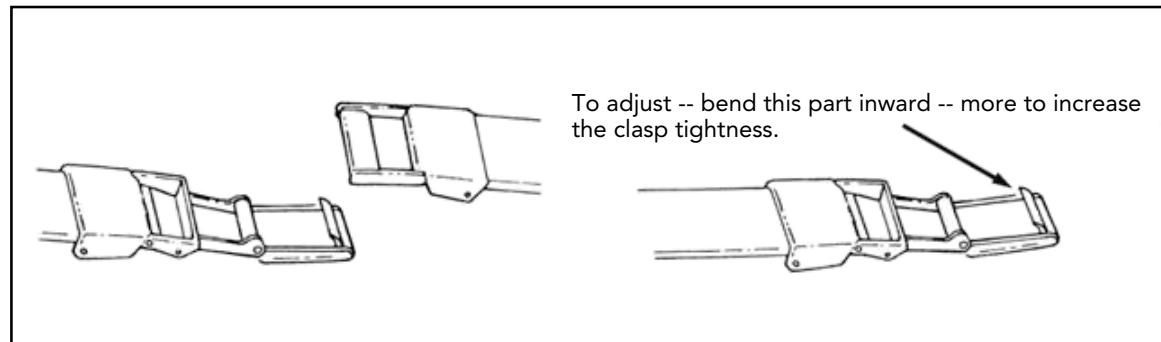

Two Folded B Type

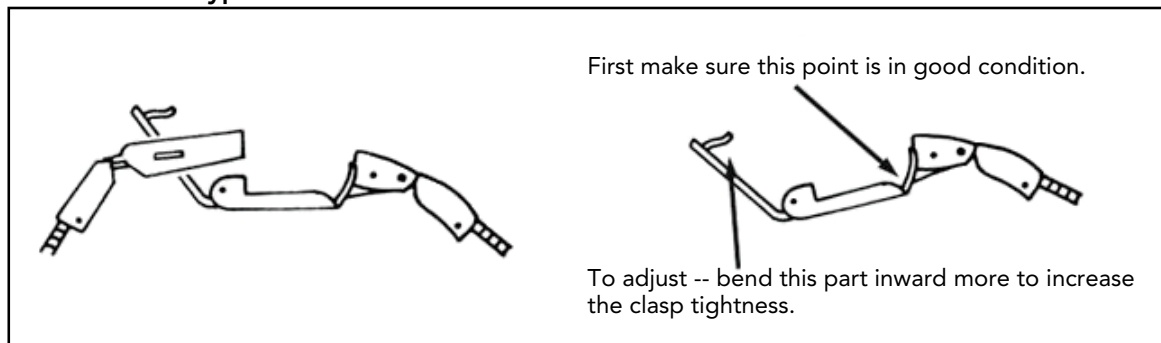



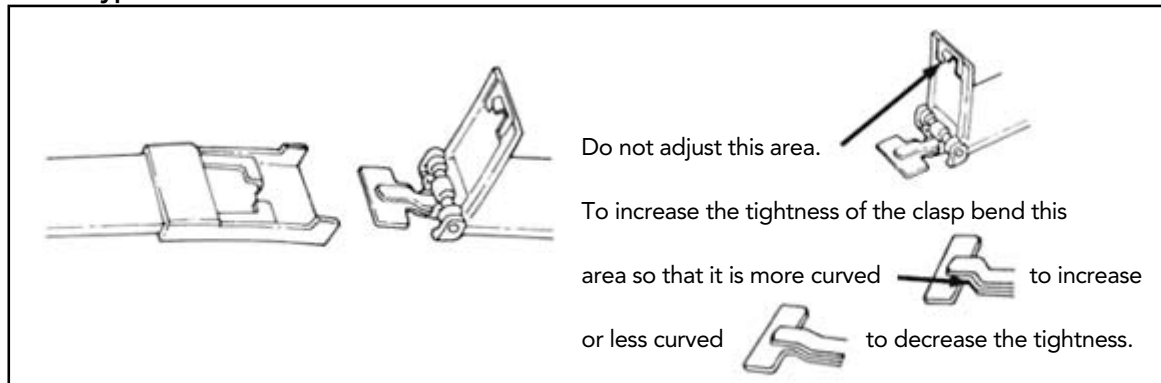

T-Bar Type



General Information

- Before you start sizing the bracelet:
 - 1-understand the structure of the bracelet and know what kinds of parts are involved, and
 - 2-prepare all the necessary tools
- Even for the same method of sizing, there may be some variation of shapes of parts.
- Place watch on soft surface so that case, crystal, and bracelet will not be scratched.
- Before sizing, accurately measure length to be cut/ adjusted.
- Bracelet should be cut/ adjusted on both ends, so that clasp is positioned right behind the wrist. (Bracelet with a sliding clasp will be adjusted only at one end.)
- Some bracelets have very small parts. Be careful not to lose them.
- Save the detached links for possible future use.

	<p>Type A bit = 2.50mm. Screwdriver blade.</p>		<p>Type B bit = 1.20mm Screwdriver blade.</p>
	<p>Type C bit = Pushing removing bit.</p>		<p>Type D bit = 0.80mm Removing bit.</p>

Two Sided Bracelet Cutting



Removing clasp

Using a screwdriver and/or tweezers pry open (up) the locking grip, and remove the fold over clasp from the bracelet. (Fig.1)

Cutting the bracelet

Place the bracelet under the cutting knife of watch bracelet cutter at the desired length to be cut and press down the lever handle firmly to cut the bracelet cleanly (Fig.2). File the cut end smooth.

Reattaching the clasp

Reattach the clasp by inserting the clasp on the bracelet and pressing down the locking grip to secure it. Be sure that the teeth of the locking grip are aligned with the "groove" on the bracelet. (Fig.3)

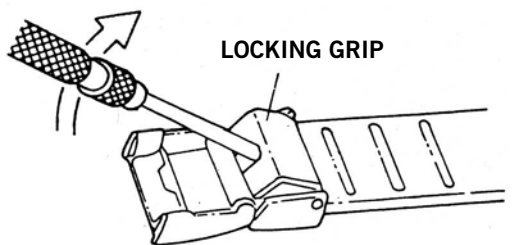
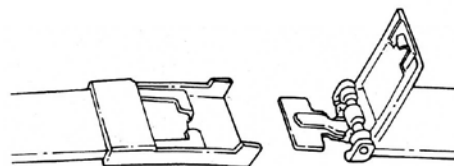

Fig.1

One Sided Bracelet Cutting



Removing the clasp

Loosen the screws on the back of the clasp. (Fig.4)

Cutting the bracelet

Place the bracelet under the cutting knife of watch bracelet cutter at the desired length to be cut, and press down the lever handle firmly to cut the bracelet cleanly (Fig.2). File the cut end smooth.

Reattaching the clasp

Reattach the clasp by inserting the screws and fitting it to the groove on the bracelet. A small amount of LOCTITE 241 must be applied to the screws to prevent the screws from falling off the clasp.

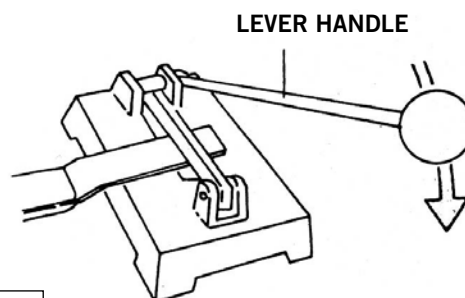

Fig.2

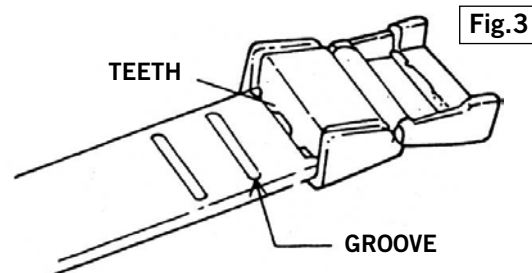

Fig.3

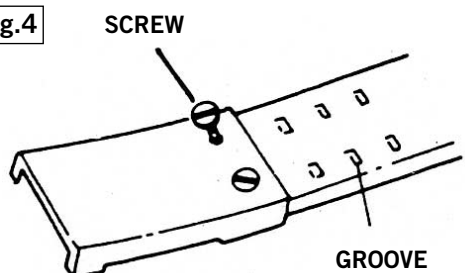
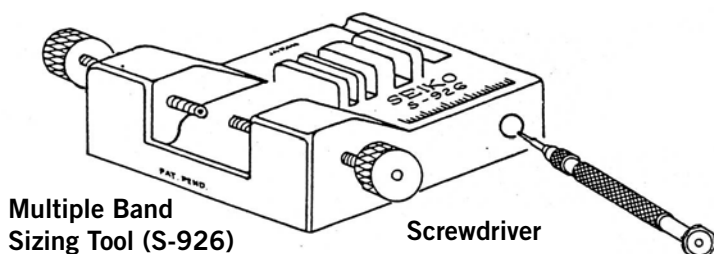

Fig.4

Tools



Multiple Band Sizing Tool (S-926)

Screwdriver

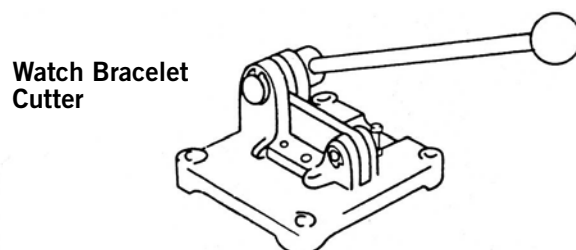

Watch Bracelet Cutter

Free Pin & C-Ring or Pipe

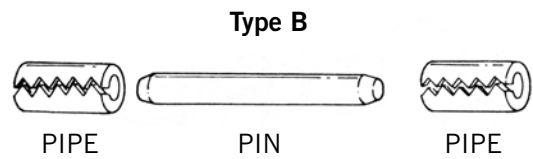
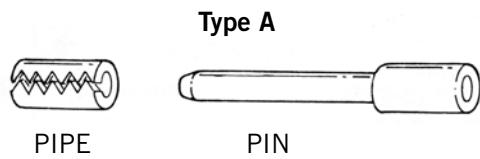

Remark: There are 2 types of pins that are used, Type A has one pin and one pipe. Type B has one pin and two pipes.

Removing Links

Install a removing bit on one side of the S-926 Pressor and place the band on the S-926 (Fig. 1) then turn the Pressor clockwise so that the bit goes through the pipe hole to push the link pin out the opposite side.

The pipe will remain in the side of the link from which the link pin is pushed. (Fig. 2)

Note: If type B pin/pipe applies then a pipe will be removed in addition to link pin.

Reassembly

Install the support bit into one side of the S-926 Pressor.

Align the link using the work station S-926 (Fig. 3) place the link pin in the side opposite from where the link pipe remained.

Place the band on the S-926 (Fig. 1) and turn the Pressor clockwise slowly so that the bit is pushing the link pin into the band.

Note: If type B applies then use the pipe installing bit (Fig. 4) to install the pipe into the link.

If hidden pipe applies, locate the hole for pipe (big opening on the link).

Install the pipe into the hole of the link. Match up the links together (be sure that the pipe does not fall off). (Fig. 5) Insert the link's pin into the link.

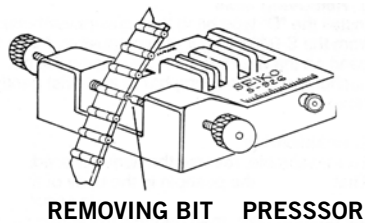

Fig.1

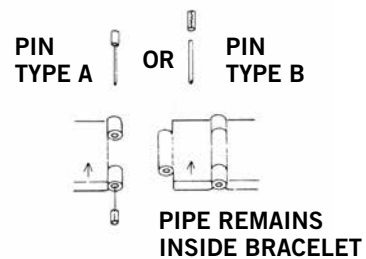

Fig.2

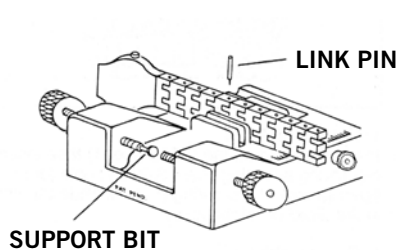

Fig.3

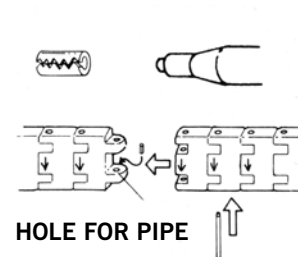
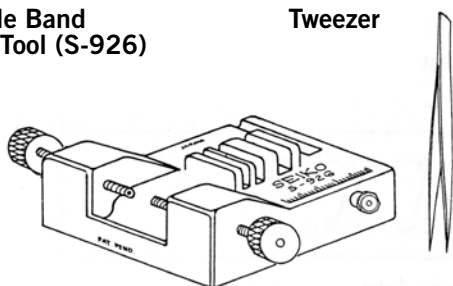

Fig.4

Tools

Multiple Band Sizing Tool (S-926)

Tweezer



Pushpin Type

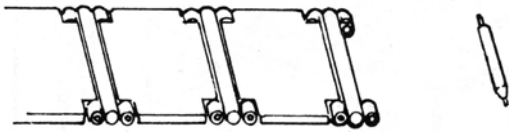

Removing links

Install the "D" type bit to the screwdriver/ holder from the S-926 using it as a pinpusher. Place the band on the S-926 (Fig. 1) then using the pin pusher press the spring bar in and twist gently for removal.

Reassembly

To reassemble, reverse the above procedure. That is, insert the pushpin in the body of the link. Make sure that one end of the pin is securely in the pushpin hole, then depress the spring bar until it fits in the top hole of the link.

Tools

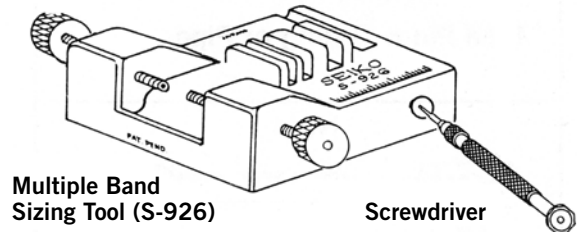

Multiple Band Sizing Tool (S-926)

Screwdriver

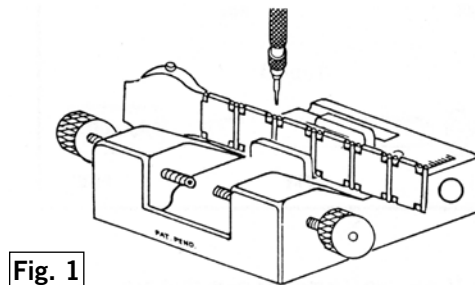
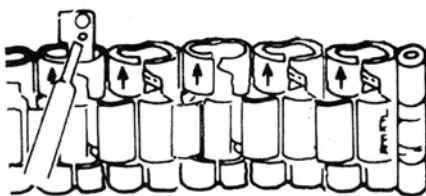

Fig. 1

Clip Spring Type



Removing links

Place the band on the S-926 (Fig. 1) then insert clip spring adjusting pliers S-919 in hole (or in open space) of clip spring (Fig. 1). Slide clip spring in the direction of the arrow.

Reassembly

To reassemble, align the links properly and reverse the above procedure. Make sure to press down the clip spring securely into the link.

Tools

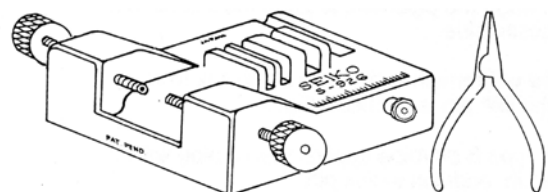

Multiple Band Sizing Tool (S-926)

Clip Spring Plier (S-919)

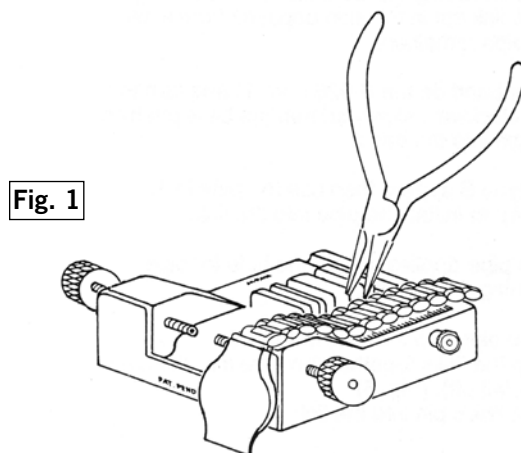
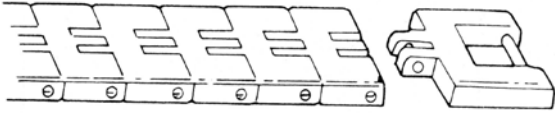

Fig. 1

Screw Pin Type



Removing links

Install the "B" type bit to the screwdriver/ holder from the S-926. Place the band on S-926 then using the adjusting screwdriver (Fig. 1) turn the screws counterclockwise.

Reassembly

Join the links together and insert the screw into the link. Turn the screw clockwise to fasten.

Tools

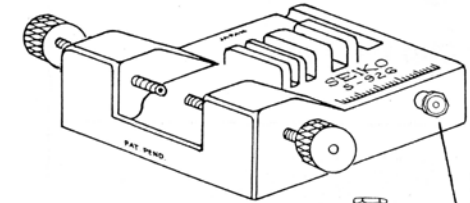

Multiple Band Sizing Tool (S-926)

Screwdriver

Fig. 1

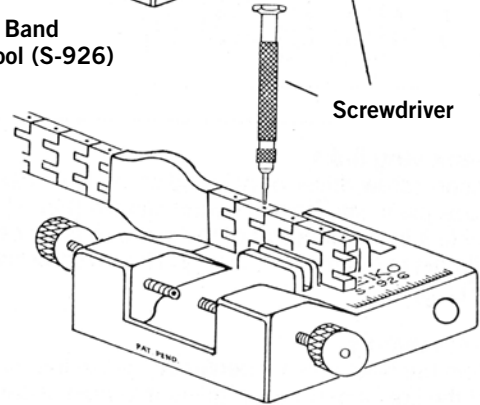

Center Clip Pin Type

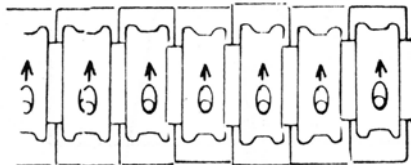

Removing links

Insert screw driver or one end of the fine needle nose pliers into hole of center clip pin (Fig. 1). Slide it in the direction of the arrow to push center clip pin out of the link. (Fig. 2) Remove the links.(Fig. 3)

Reassembly

Join the links and put center clip pin in the middle of the link. Insert Screw driver into hole of center clip pin and push it in the opposite direction of the arrow.

Tools

Multiple Band Sizing Tool (S-926)

Or

Clip Spring Plier (S-919)

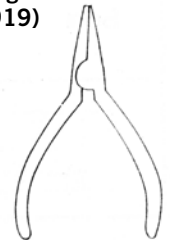
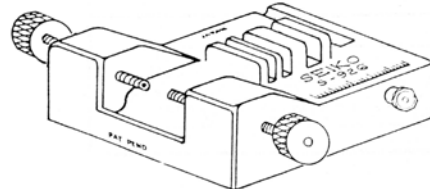
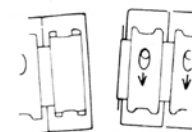
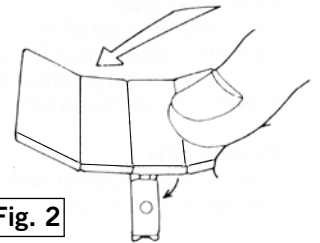
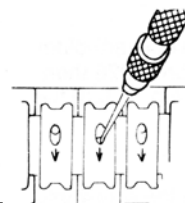

Fig. 1

Fig. 2

Fig. 3



Fixing Pin Type

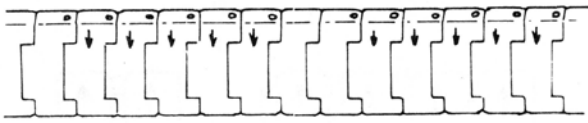

Removing Fixing Pin

Install a removing bit on one side of the S-926 Pressor and place the band on the S-926 (Fig. 1) then turn the pressor clockwise so that the bit presses against the fixing pin (from arrow direction) to push the fixing pin head out of the link.

Turn the pressor counterclockwise, remove the band from the S-926 then remove the fixing pin from the link (Fig. 2)

Reassembly

Reverse the above procedure by inserting the pin in the opposite direction of the arrow.

Fixing Pipe & Pin Head Type

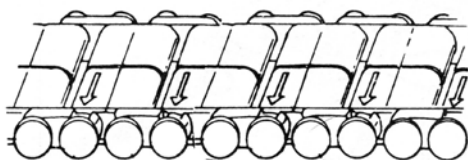

Remark: Only Links marked with arrows have removable pins. (Fig. 1)

Removing links

Install the "D" type bit to the screwdriver/ holder from the S-926 using it as a pinpusher. Insert pinpusher or one end of fine needle-nose pliers in hole (or in open space) of the link. (Fig. 2)

Slide out the pin head in the direction of the arrow and remove the fixing pipe in the opposite direction. (Fig. 3)

Reassembly

To reassemble, align the links properly and reverse the above procedure. That is, insert the fixing pipe in the body of the link. (Fig. 4)

Then insert the pin head securely. (Fig. 5)

Tools

Multiple Band Sizing Tool (S-926)

Tweezer

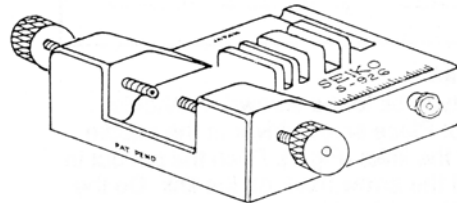
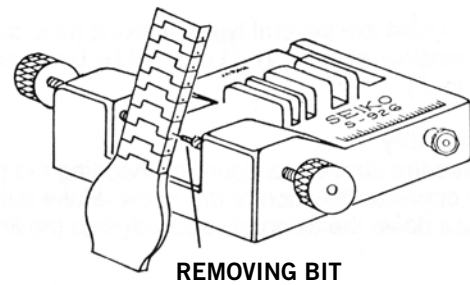
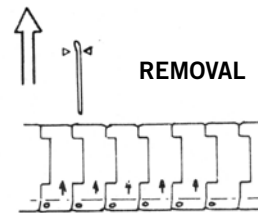

Fig. 1



REMOVING BIT

Fig. 2



REMOVAL

Tools

Tools Multiple Band Sizing Tool (S-926)

Screwdriver

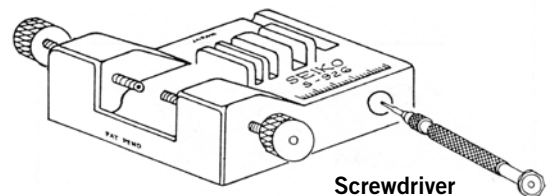

Fig. 1

REMOVEABLE PIN

Fig. 2

UNREMOVEABLE PIN

Fig. 3

FIXING PIPE

Fig. 4

PIN HEAD

Fig. 5

Sliding Clasp Type

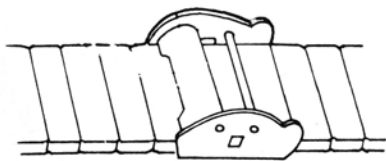

Opening the clasp

Install the "A" type bit to the screwdriver/ holder from the S-926. Using the screwdriver and/ or a pair of tweezers, simply pry open (up) the locking grip for adjustment (Fig. 1) and slide the clasp (up or down) to the desired length of adjustment.

Closing the clasp

Press down (close) the locking grip of the clasp unit.

Tools

Multiple Band Sizing Tool (S-926)

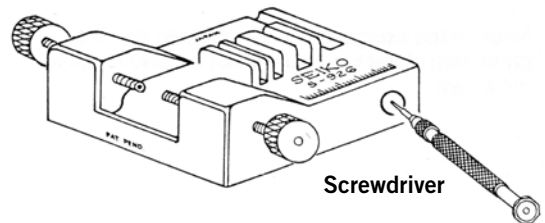

LOCKING GRIP

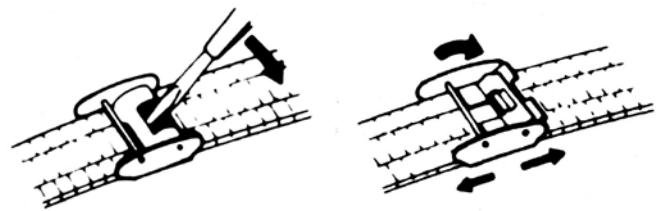
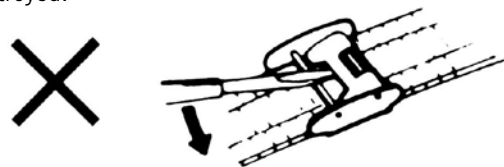

Fig. 1

Wrong method

If you do this way, the adjusting flap may be destroyed.



Expansion Bracelet Type A

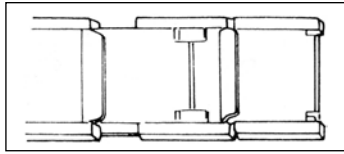

Removing links

Rolling the band taut (Fig. 1), remove the curl part of the link while pressing the flat part of the link tightly (Fig. 2)

Reassembly

Reverse the above procedure by rolling in the curl part of the link while pressing the flat part of the link.

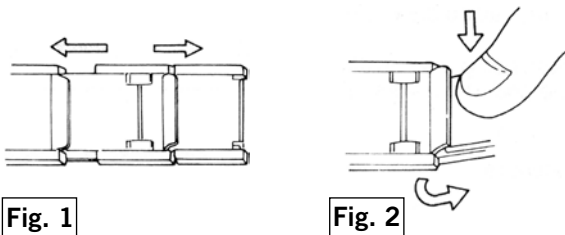

Expansion Bracelet Type B

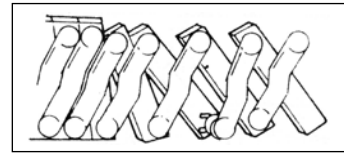

Removing Links

Rolling the band taut (Fig. 1), slide the link to take off the hook on both ends of the link. (Fig. 2)

Reassembly

Reverse the above procedure by hooking in the hole of the link while pulling the band.

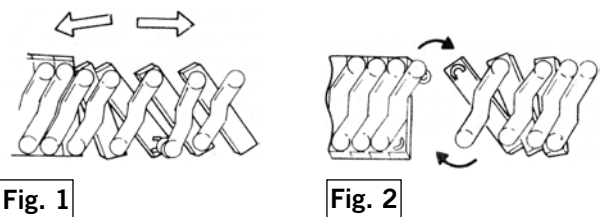

Expansion Bracelet Type C

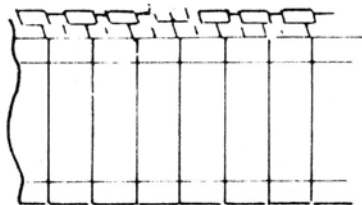

Removing links

Install the "A" type bit to the screwdriver/ holder from the S-926. Using the screwdriver, raise up the bend on the end of the links. (Fig. 1) Slide the band in the direction of the raised bend. (Fig. 2)

Note: Pay attention when using a screwdriver to raise up the bend on the end of the links. (Fig. 3)

Reassembly

Reverse the above procedure

Tools

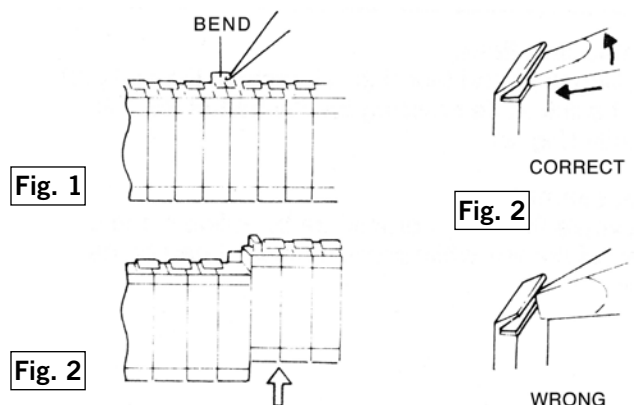
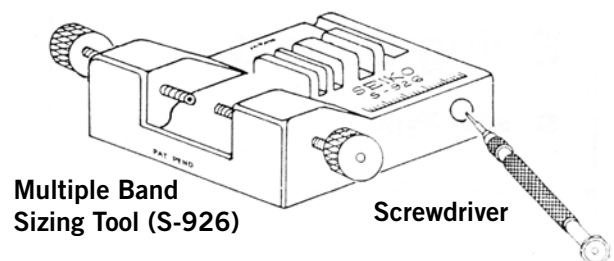

Expansion Bracelet Type D

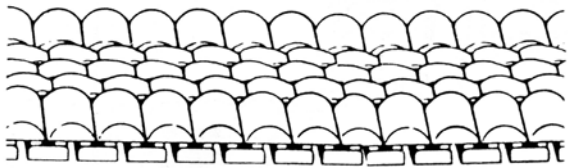

Planning the adjustment

Fig. 1

You may start your adjustment anywhere near the center of the watchband. This illustration shows the starting point as "*" with adjacent topshells and bottom boxes numbered. Decide how many links you wish to remove.

These illustrations show the removal of three links, so the topshells and bottom boxes "*" and "3" will be worked on.

Fig. 2

Use a thin blade to straighten the tab on one end of topshell.

Fig. 2A

Remove the topshell from the band by pushing the straightened end down and "unhooking" the other end (Save the topshell for step 7.) To shorten bracelet, remove additional topshell according to your plan.

Fig. 3

Bend down the bottom box end flaps diagonal to the two exposed links as shown.

Fig. 3A

Bend up the end flaps at the opposite end of the top boxes.

Tools

Multiple Band Sizing Tool (S-926)

45° Angler

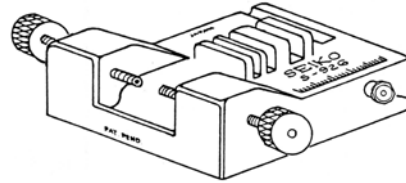

SCREWDRIVER

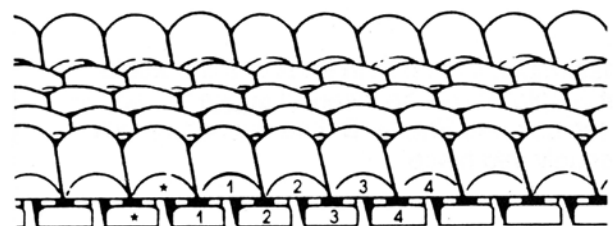

Fig. 1

Shaded area shows one link

Bottom View

SCREWDRIVER

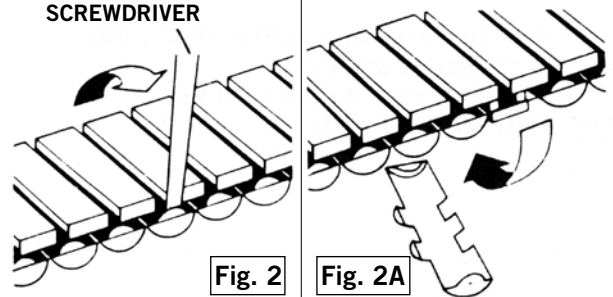
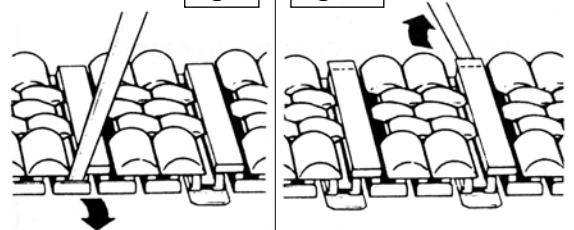

Fig. 2

Fig. 2A

Fig. 3

Fig. 3A



Three folded Clasp

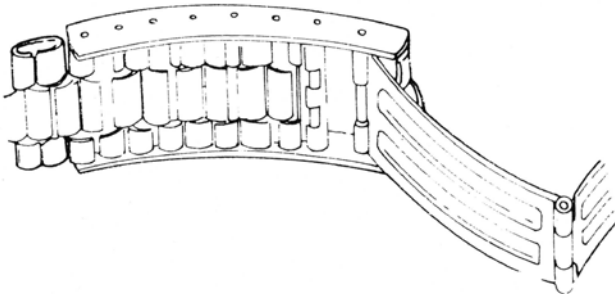

Install the "D" type bit to the screwdriver/holder from the S-926 using it as a pinpusher. Many bracelets have three folded clasps. These bracelets can be adjusted by moving the position of the bracelet within the clasp as illustrated. (illustration shows bracelet being lengthened.)

1. Locate pushpin holes on the clasp. Use a pin pusher, (From the S-926 device) press the spring bar in and twist gently for removal. **(Fig. 1)**
2. Insert pushpin in the bracelet and move the bracelet to desired position **(Fig. 2)**. Make sure one end of the pin is securely in the pushpin hole and depress the spring bar until it fits the top hole of the clasp. **(Fig. 3)**

Tools

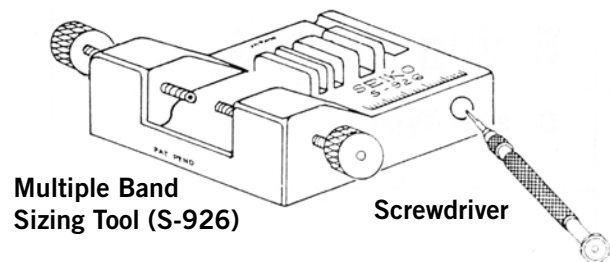

Multiple Band Sizing Tool (S-926)

Screwdriver

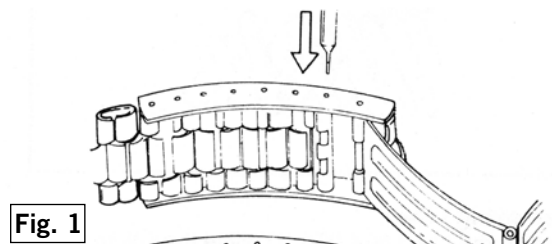

Fig. 1

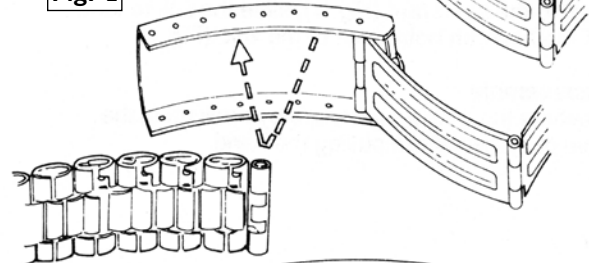

Fig. 2

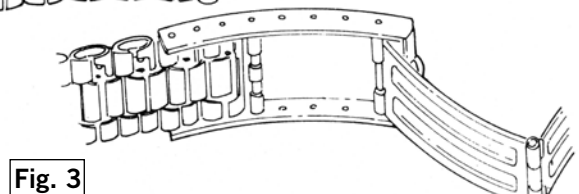

Fig. 3

Fig. 4

Push in the direction of the arrows to separate the bracelet. You now have three sections. Save the removed links for future spare parts. The other sections are now ready for assembly.

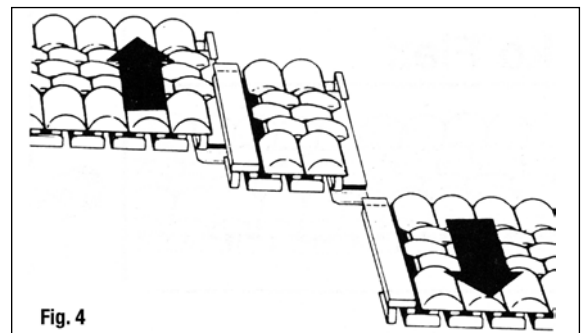

Fig. 5

To reassemble, line up both ends of the bracelet so that Staple "A" can be inserted above the spring in the top box and Staple "B" into the bottom box. Slide snugly into place.

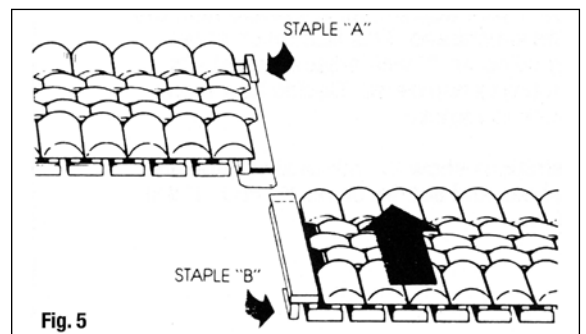

Fig. 6

Bend up the bottom end flap. Bend down the top end flap to a 45 degree angle only.
 Note: DO NOT USE PLIERS AS YOU WILL DAMAGE THE WATCHBAND

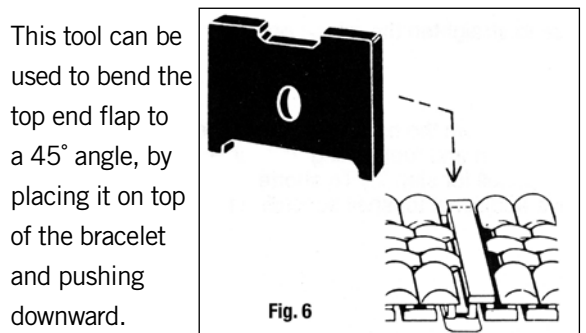

Fig. 7

Hook the unstraightened end of the topshell over top box flap and pivot into place.

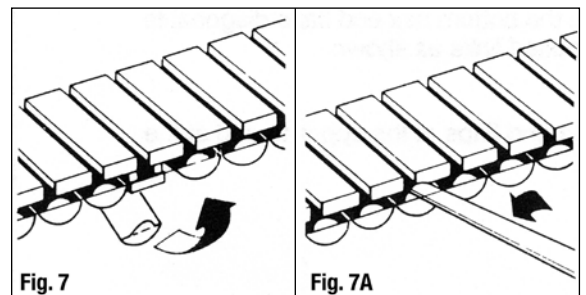

Fig. 7A

Bend down end top to lock topshell in position.



Cord Sizing

CORD SIZING

- Using a screwdriver or tweezers, pry open the locking grip on both sides of the safety clasp and remove.
- Cut both sections of the cord equally on both sides to ensure proper centering of the watch case, to the desired length.
- Melt the frayed edges (end) of the cord by heating it with a lighter or use a soldering gun instead of the lighter for safety purposes.
- Allow to cool several minutes.
- Reattach the safety clasp and press the locking grip down to secure.

DISCLAIMER

Warning... The wristband of this watch requires the use of a flame in order to reconnect the ends of the wristband after it has been sized to the purchaser's wrist. This procedure involves the risk of serious burn or injury; and therefore, the sizing of this wristband to the purchaser's wrist should be performed only by a qualified jeweler or a repair center. Seiko Hong Kong LTD hereby disclaim liability for any injury which may occur as a result of deviation from these instructions, including, but not limited to, any attempt by a purchaser to size the wristband himself.

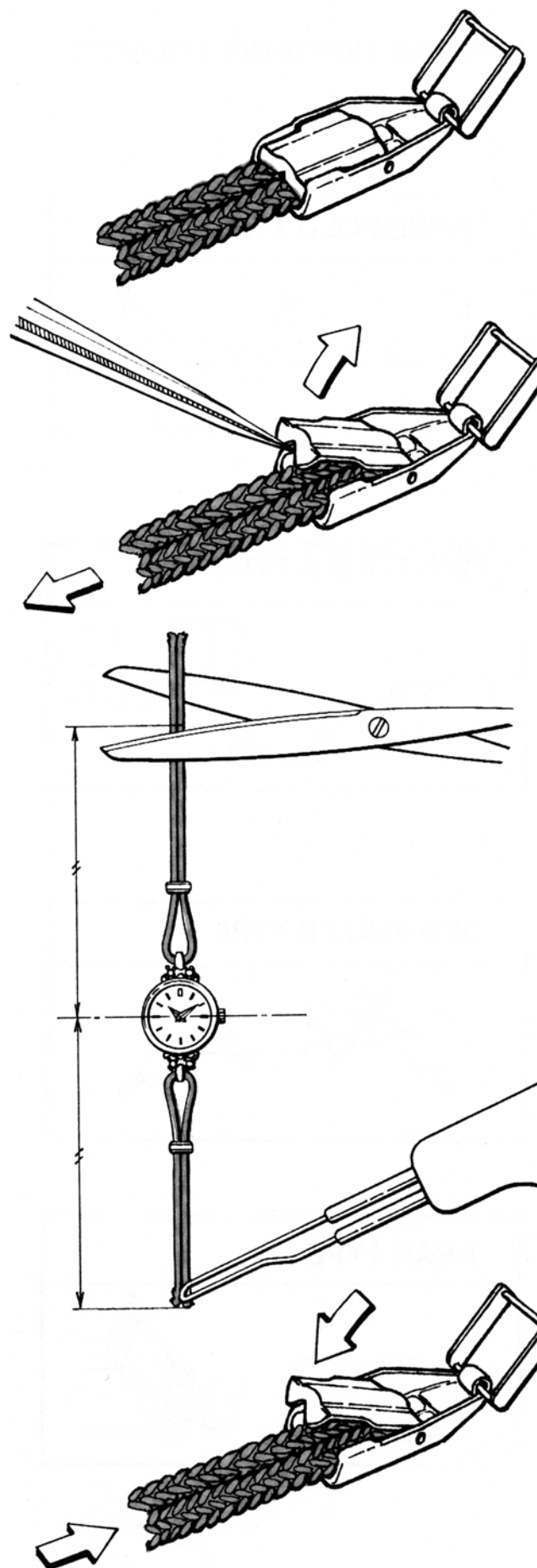

Clasp Adjustment Tips For Tightening Clasps

Three Folded Type

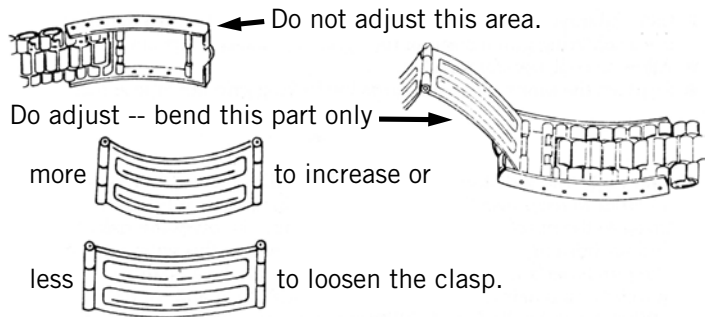
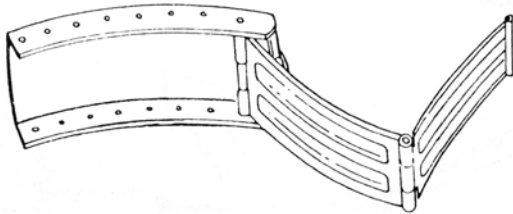

Two Folded A Type

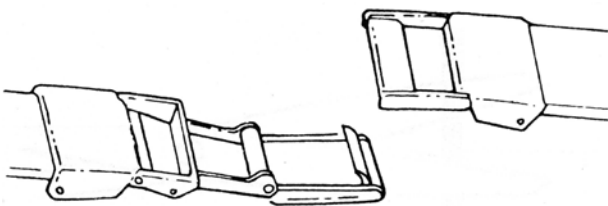

To adjust -- bend this part inward -- more to increase the clasp tightness.

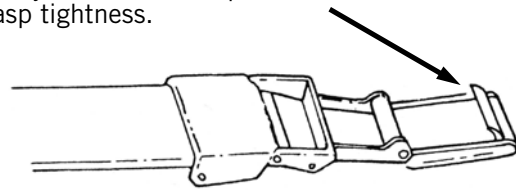

Two Folded B Type

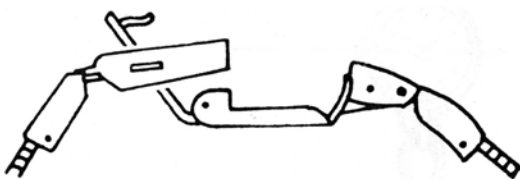

First make sure this point is in good condition.

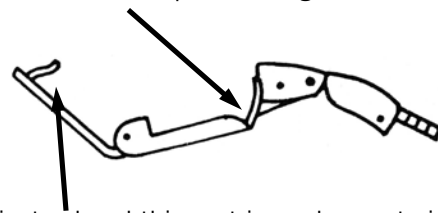

To adjust -- bend this part inward more to increase the clasp tightness.

T-Bar Type

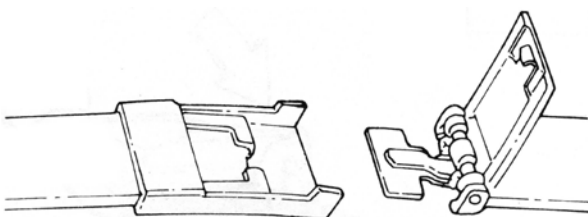

Do not adjust this area.

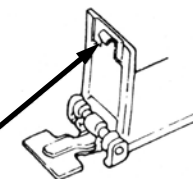

To increase the tightness of the clasp bend this

area more curved

or less

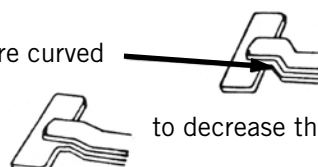

SEIKO

A battery you can trust

Environmentally friendly mercury-free batteries



Orders & enquiries – parts@seiko.com.au
Phone enquiries within Australia – 1300 300 776

SEIKO Australia Pty Ltd