

*Brain and Consciousness*

Proceedings of the First Annual ECPD International Symposium on

Scientific Bases of Consciousness

22-23 September 1997

Belgrade, Yugoslavia

Edited by

Ljubisav Rakić

George Kostopoulos

Dejan Raković

Djuro Koruga

Publisher

European Centre for Peace and Development (ECPD) of the United Nations University for Peace

Belgrade, Terazije 41

Phone: (381 11) 3246-041

Fax: (381 11) 623-169

For ECPD: Negoslav Ostojić, Executive Director

© All rights reserved. No parts of this book may be reproduced or transmitted in any form or by any means, electronic or mechanical, including photocopying, recording, or by any information storage and retrieval system, without permission in writing from the Publisher.

CIP - Каталогизacija у публикацији  
Народна библиотека Србије, Београд

165.62(082)

ANNUAL ECPD International Simposium on  
Scientific Bases of Consciousness (1st; 1997; Belgrade)  
Brain and Consciousness: Proceedings of the  
First Annual ECPD International Simposium on  
Scientific Bases of Consciousness,  
22-23 September 1997 Belgrade, Yugoslavia /  
edited by Ljubisav Rakić ... [et al.]. - Belgrade:  
European Centre for Peace and Development (ECPD)  
of the United Nations University for Peace,  
1997 (Belgrade: Čigoja štampa). -I,  
347 str. : graf. prikazi; 29 cm

Tiraž 300. - Abstracts. - Bibliografija uz svaki rad.

**ISBN 86-7236-009-5**

1. Gl. Stv. Nasl.

159.922(082) 616.89.-008(082)

616.8-009.83-073.97(082) 612.821(082)

577.38(082) 007.52(082)

a) Свест - Зборници b) Феноменологија - Зборници  
c) Електроенцефалографија - Зборници d) Неурофизиологија  
- Зборници e) Биофизика - Зборници f) Вештачка Интелигенција - Зборници

ID = 57081100

## PREFACE

Consciousness is one of the oldest scientific problems, recognized already in ancient times, both in the civilizations of East and West. However, in contrast to scientific problems related to the structure of matter and physical interactions, the problem of consciousness has remained scientifically unresolved to date. The last decade of 20th century has been proclaimed by United Nations as the decade of brain research, which certainly gave a new impulse to investigation of the phenomenon of consciousness, as the most complex brain function. It is currently estimated that the problem of consciousness belongs to ten most significant scientific problems, although it might soon become one of the most significant ones owing to its potential implications in medicine, psychology, biology, physics, engineering, and philosophy. A deeper understanding of the very nature of altered states of consciousness might also radically shift our scientific understanding of some ultimate religious questions (like spiritual and practical significance of imperative moral behavior of every individual) - with prospects for a new humanism, without meaningless and painful interpersonal, interethnic, and interreligious conflicts.

As a result of these contemporary scientific trends, European Centre for Peace and Development (ECPD) of the United Nations University for Peace in Belgrade initiated in 1996 an international scientific project *Brain & Consciousness*, which will include research, scientific meetings, publishing and organization of postgraduate studies at the specialist, master and doctor levels - with a specific aim to educate for peace and international cooperation. Along this line, the first successes were Belgrade's ECPD Symposium Consciousness: Scientific and Technological Challenge of the 21st Century, 29-30 May 1995, and Belgrade's ECPD Seminar Consciousness: Scientific Challenge of the 21st Century, 27-28 September 1996, and we certainly expect for the First Annual ECPD International Symposium and Workshop on Scientific Bases of Consciousness: Brain and Consciousness, 22-26 September 1997, to be a continuation of the above successes.

So, our symposium, with more than sixty contributions published in this proceedings, will be an important meeting point for brain researchers in the diverse fields of medicine, psychology, biology, physics, engineering, and philosophy to meet and exchange ideas and form the scientific impetus for improvements in the extremely wide and intriguing field of consciousness.

Editors and Publisher greatly acknowledge academic and/or financial sponsorship of Biomedical Department of Serbian Academy of Sciences and Arts, and Yugoslav, Serbian, Montenegrin, and Greek Ministries for Science and Technology, as well as of ICN Galenika.

We are especially indebted to the Symposium & Workshop Secretaries, Dušan Bobarević, Emil Jovanov, and Mateja Opačić for their hard organizational work, Mr. Petar Vujićin for his intense lectoral work, and Mrs. Tatjana Opačić for her high professionalism in technical preparation of the book.

Belgrade,  
September 1997

*Editors*

# CONTENTS

<b>Opening Address</b>	1
THE ENIGMA OF TODAY'S SCIENCE: STILL MYSTERIOUS CONSCIOUSNESS (D. T. Kanazir)	3
<b>1. Phenomenology</b>	5
1.1 THE DILEMMA FOR SCIENCE OF CONSCIOUS EXPERIENCE (P. Fenwick)	7
1.2 A ROBOT'S "PHILOSOPHY OF MIND": THE MONISM VERSUS THE DUALISM IN A ROBOT'S "WORLD-VIEW" (V.O. Lobovikov)	11
1.3 AN ONTOLOGICAL DEFINITION OF CONSCIOUSNESS (V. Abramović)	15
1.4 PROBLEMS OF COSMIC LIVING SPACE (V.P. Kaznatcheev)	19
1.5 THE GOLDEN FLEECE II: UNIVERSE - CONSCIOUSNESS - CIVILIZATION (Lj. Kljakić)	27
1.6 THE CONCEPT OF THE UNCONSCIOUS / CONSCIOUS IN THE THEORIES OF CONTEMPORARY PSYCHOLOGY (M. Alečković-Nikolić)	35
1.7 A HYPOTHESIS OF SELFCONSCIOUSNESS AS TRUTH AND PHENOMENOLOGICAL BASIS FOR PERSONALITY INTEGRATION (V. Desimirović)	39
1.8 TOTAL VALUE AND CONSCIOUSNESS (D. Pavlović)	43
1.9 PROPOSAL OF THE SELF-ACTUALIZATION LAW: CONSCIOUSNESS VERSUS MANAGEMENT (J. Cakić)	49
<b>2 Consciousness and Language</b>	57
2.1 THE LANGUAGE AND CONSCIOUSNESS IN SPLIT-BRAIN PATIENTS: REVISITED (T. Đurović)	59
2.2 PHONOLOGICAL DEVELOPMENT IN BABIES WITH UNI- AND BILATERAL PERINATAL BRAIN LESIONS (V. Gec and J. Ivanuš)	69
2.3 LEVELS OF CONSCIOUSNESS IN THE CHILDREN WITH GRAPHOMOTORIC DIFFICULTIES (N. Subota and V. Đorđević)	71
2.4 INFLUENCE OF CONSCIOUSNESS ON THE COURSE AND THE OUTCOME IN THE THERAPEUTIC PROCESS OF SPEECH/LANGUAGE IMPEDIMENT (R. Brakus and V. Brakus)	75
2.5 FROM SOUND TO LANGUAGE - ESCAPE FROM DEAF HABITUS (S. Pantelić and M. Sovilj)	79
2.6 AWARENESS OF SOUND SIGNALS IN CHILDREN WITH IMPAIRED HEARING (S. Djoković)	83
2.7 PALEOGLOSSOLOGY OF THE BALKANS: BECOMING CONSCIOUS OF NAMES (A. Škokljev and I. Škokljev)	87
2.8 FORM, LIGHT, AND CONSCIOUSNESS: EACH GENESIS STARTS FROM A STRUCTURE AND REACHES A STRUCTURE - EACH STRUCTURE HAS ITS GENESIS (L. Mišić)	93
2.9 AN OVERVIEW OF BASIC N.P.N.L. METHODS: NUMERICAL ANALYSIS OF LEXICOGRAPHICAL WORK (A. Margot and M. Stanojević)	101
2.10 THE UNIVERSAL CONSCIOUSNESS AS A UNIVERSAL COMPREHENSION OF THE UNIVERSAL CODE (M. M. Rakočević)	107
<b>3 Altered States of Consciousness</b>	115
3.1 PLANES OF CONSCIOUSNESS IN ESOTERIC PRACTICE: A COMPARATIVE APPROACH (P. Vujićin)	117
3.2 YOGA, SCIENCE AND CONSCIOUSNESS (S. S. Saraswati)	121

3.3	SEXUALITY VERSUS SPIRITUALITY (Lj. Klisić)	123
3.4	THE SEPARATION OF MESMERISM AND HYPNOSIS AS DIFFERENT STATES OF CONSCIOUSNESS (M. Schubert)	129
3.5	THE PHENOMENON AND COMPOSITION OF THE CONSCIOUSNESS WITHIN SORCERY PATTERNS (M. Jovićević)	133
3.6	DOLPHINS AS COTHERAPISTS FOR INDUCING CONTACT WITH CHILDREN WHO HAVE ELEMENTS OF AUTISTIC BEHAVIOR (M. Momirov)	137
3.7	AN ESSAY NO TRANSCENDENTAL MEDITATION: FROM PERSONAL TO SOCIAL OBSERVATIONS (J. Ribnikar)	141
3.8	TOWARDS A NEW/OLD HUMANISM: TRANSITIONAL STATES OF CONSCIOUSNESS AS A CLUE? (D. Raković)	145
3.9	NEUROLINGUISTIC PROGRAMMING: A NEW INTEGRATIVE MODEL FOR STATES OF CONSCIOUSNESS (G. Stanojević-Vitaliano)	151
3.10	HEALING RITUALS AND ALTERED STATES OF CONSCIOUSNESS (Č. Hadži-Nikolić and B. Petković-Medved)	159
3.11	VISUALIZATION OF ILLNESS IN A DEEP RELAXATION IN ASTHMATIC CHILDREN AND ADOLESCENTS (O. Vulićević and T. Grgurović)	165
3.12	CONCIOUSNESS AND THE CENTER OF THE WORLD (D. Mojović)	171
3.13	PSYCHOPORTRAIT (P. Perović)	173
3.14	DESCRIPTIVE GEOMETRY AND DEVELOPMENT OF VISUAL PERCEPTION AND VISUALIZATION APPLYING ALTERED STATES OF CONSCIOUSNESS (J. Kalezić)	177
<b>4</b>	<b>Brain and Consciousness: Neurobiological Aspects</b>	183
4.1	NEURONAL MECHANISMS UNDERLYING LOSS OF CONSCIOUSNESS DURING ABSENCE SEIZURES (G. Kostopoulos)	185
4.2	EPILEPTIC DISTURBANCES OF CONSCIOUSNESS: AN ARGUMENT FOR CONTEMPLATION (I. Ribarić)	195
4.3	THE ROLE OF SYNAPTIC JUNCTIONS IN THE IDENTIFICATION OF HUMAN CONSCIOUSNESS AND IN THE INTERPRETATION OF THE PATHOGENESIS OF COMA (M. Bondi and M. Bondi)	201
4.4	BRAIN CHEMISTRY AND CONSCIOUSNESS (M. Vojinović - Miloradov, J. Adamov, and M. Popović)	205
4.5	TRANSPERSONAL PSYCHOLOGY IN THE LIGHT OF THE LATEST NEUROPHYSIOLOGICAL RESEARCH (S.P. Petrović)	209
4.6	RELAXATION INDUCED BY MICROWAVE RESONANCE THERAPY: EEG CORRELATES (D. Radenović, D. Raković, Z. Jovanović-Ignjatić, M. Tomašević, V. Radivojević, and E. Jovanov)	213
4.7	FUNCTIONAL ORGANIZATION OF SOMATOSENSORY TRANSMISSION IN DIFFERENT MODIFICATIONS OF HUMAN BRAIN REACTIVITY (E.V. Damianovitch and T.V. Orlova)	219
4.8	THE CHANGES IN PURKINJE CELL ACTIVITY FOLLOWING INFERIOR OLIVE STIMULATION (M. Čulić, J. Šaponjić, B. Janković, and M. Janković)	223
4.9	EFFECT OF LOCUS COERULEUS STIMULATION ON ECoG POWER SPECTRA IN BRAIN DAMAGED RATS MODEL OF EPILEPSY (J. Šaponjić, M. Čulić, B. Janković, and M. Janković)	227

<b>5</b>	<b>Monitoring Methodologies</b>	231
5.1	PROSPECTS OF COMPUTER ACCESS USING VOLUNTARY MODULATED EEG SIGNAL (A. Kostov and M. Polak)	233
5.2	A PROPOSAL FOR EEG MONITORING (B.I. Janković, M. Čulić, J. Šaponjić, S. Udović, S. Popović, and M. Janković)	237
5.3	A METHOD OF EPILEPTIC SEIZURES RECOGNITION (N. Rajšić, S. Šuljagić, J. Ivanuš, Z. Božović, A. Kalauzi, D. Rapajić, G. Nedović, and M. Rajšić)	241
5.4	SPECIFIC AND NONSPECIFIC EEG PATTERNS IN PREDICTION OF ELECTROCONVULSIVE ACTIVITY (S. Šuljagić, N. Rajšić, J. Ivanuš, Z. Božović, A. Kalauzi, D. Rapajić, and G. Nedović)	245
5.5	SLEEP AND CONSCIOUSNESS - SOME MEDICAL AND FORENSIC IMPLICATIONS (N. Trajanović, C.M. Shapiro, and H. Driver)	247
5.6	A NOVEL NEURAL NETWORK APPROACH TO ESTIMATION OF VIGILANCE LEVEL FROM EEG POWER SPECTRUM (P. Šuković, V. Radivojević, Ž. Martinović, D. Raković, and E. Jovanov)	251
5.7	EEG CORRELATES OF TRANSCENDENTAL MEDITATION (M. Tomašević, D. Raković, E. Jovanov, V. Radivojević, and M. Car)	255
5.8	EEG CORRELATES OF MUSICOGENIC STATES OF CONSCIOUSNESS (L. Škarić, M. Tomašević, D. Raković, E. Jovanov, V. Radivojević, P. Šuković, M. Car, and D. Radenović)	263
5.9	EEG CORRELATES OF HEALER/HEALEE STATES OF CONSCIOUSNESS (M. Tomašević, E. Jovanov, D. Raković, P. Šuković, S. Stanojlović, and M. Car)	269
5.10	UNUSUAL CONSCIOUS COMMUNICATION AND THE ELECTRICAL ACTIVITY OF THE BRAIN (V. Radičević and Z. Radičević)	275
5.11	A FEW SIMPLE MIND-MATTER EXPERIMENTS (C. W. Smith)	283
5.12	KIRILIAN TECHNIQUE: A WAY FOR MONITORING DIFFERENT STATES AND DIFFERENT LEVELS OF HUMAN BIOSYSTEM (G. Ivović)	285
<b>6</b>	<b>Models</b>	289
6.1	A MODEL OF CONSCIOUSNESS: AN ENGINEERING APPROACH (E. Jovanov)	291
6.2	A BRIEF INTRODUCTION TO NOETIC FIELD THEORY: THE QUANTIZATION OF MIND (R. L. Amoroso)	297
3.3	QUEST FOR ABSOLUTE: MATTER AND SPACE AS ONTOLOGICAL CATEGORIES IN QUANTUM PHYSICS, ARTIFICIAL INTELLIGENCE AND EASTERN THOUGHT (B. Perčinkova)	303
3.4	A QUANTUM PICTURE OF A MULTIDIMENSIONAL UNIVERSE ON THE BASIS OF CONSCIOUSNESS (M. Schmieke)	307
3.5	THE SCIENTIFIC MODEL OF THE MYSTICAL FOUR WORLDS (J. A. Kovelman)	313
3.6	CREATIVITY: THE QUANTUM AND SUBCONSCIOUSNESS ASPECTS (A. Dreimanis)	317
3.7	ENERGY ASPECT OF CONSCIOUSNESS LAYERS (N. V. Delić, J. P. Šetrajčić, A. S. Utješanović, V. M. Zorić, D. Lj. Mirjanić and S. K. Jaćimovski)	321
3.8	A MISTERY OF THE WORLD - WAVE AND PARTICLE AS THE BASIS OF CONSCIOUSNESS (B. Šesterikov)	327
3.9	PUNCTUM SALIENS: TORUS AS A MODEL OF BIOLOGICAL CONSCIOUSNESS (L. Matija)	331
3.10	CONSCIOUSNESS AND NATURE-MAN-MACHINE SYSTEM (Dj. Koruga)	335

## AN ONTOLOGICAL DEFINITION OF CONSCIOUSNESS

Velimir Abramović

University of Art, Bulevar Umetnosti 20, 11070 Belgrade, Yugoslavia  
E-mail : velimir@EUnet.yu

**Abstract.** The thesis presented here is that the notions of spirit, time, force, point, zero, are identical to the notion of consciousness. The real Being is non-spatial entity. In physical terms it is Time; in psychological terms it is Consciousness. This then leads to an ontological definition of consciousness as continuity. Consequences: consciousness is the greatest cosmic force and fundamental cosmic entity. The universality of consciousness derives from continuity as a principal quality of continuum that creates infinite basis for the extension of the world. As continuity is not extending, as extension is the condition for space to exist, we conclude that consciousness is non-spatial.

**Key words:** *consciousness, ontology, continuity, continuum, discontinuity, discontinuum, spirit, space, mater, time.*

In order to define consciousness as an ontological notion, it is necessary to define it as a notion in physics, as physics is an ontological science, science of the being of the world.

If we understand ontology as a purely spiritual discipline, and recognize general notion of matter as the subject of physics, then both these disciplines would collide. All-extending spiritual entity encompasses the basis of the existence of matter, and matter understood as cosmic totality will unavoidably contain the spirit within itself.

But what is, if any, the real difference between spirit and matter? How could we define spirit, and how matter? Ontologically, spirit is nothing else but continuum, while matter is primarily discontinuum.

The principal quality of continuity is non-spatiality and this quality is shared by spirit. Here we encounter the problem of the difference between spirit and consciousness. If we define spirit ontologically as continuity, we must seriously raise the question of whether any different ontological representation of consciousness is possible. And consciousness is, in essence, continuity, and in that sense, ontologically speaking, there is no difference in content between the notions of consciousness and spirit. Of course, this is the question of a universal notion of spirit, and in turn consciousness. On the other hand, general notion of matter leads to grading. Non-spatial continuity, i.e. non-spatial spirit or non-spatial consciousness also lies in the basis of matter, as its most abstract constructive element. This shows that the existence of matter is notionally possible to describe in the shape of hierarchy of entity put in order from simple to

complex. Therefore, if we put matter in order of complexity, then the simple element of matter, ontologically speaking, would be non-spatial continuity, and this must somehow create spatial continuum. These elements are followed by ontological notions we can relate to on the basis of material world we are familiar with by our sensual experience and not pure reasoning. These are forms of ontological cognition: discontinuity and discontinuum. These notions are related to physical systems and their qualities are not the topic of this discussion. Let us go back to continuity, i.e. non-spatial basis of the material world.

How would continuity be defined in physics? Or let us put this question differently: what is the only notion in physics, or even better, what is the only phenomenon in the world of phenomena we could say is in no sense spatial? The answer is very clear - time. Only the notion of time in physics, or time in the physical world is non-spatial.

Let us now set up a univocally corresponding relation of the above-mentioned fundamental notions of ontology and physics, these two artificially separated fields of human knowledge. If we apply Leibnitz's logical principle of *principium identitatis indiscernibilium* to the notions of continuity, spirit and consciousness, we shall confirm that there is no difference between them. Spirit, consciousness and continuity are all non-spatial, infinite and not localized. This could lead us to conclude that consciousness is a psychological name for continuity, and spirit is a philosophical-religious notion for the same thing. As an ontological subject matter, consciousness represents itself in the form of continuity. As a physical subject matter, consciousness presents itself in the form of time, i.e. the only notion of physics that excludes spatiality. In other words, continuity, spirit, consciousness and time are notions of identical content - nothing else but more than one name for the same notion. Spirit is the simple basis of matter and is therefore identical to time.

Space is complex in relation to time and is dependent on it. By annulling time, space is also annulled, as without time it cannot exist, whilst by annulling space, time is by no means annulled, but only reduced to pure existence. In other words, what is non-spatial, time, can exist independently, and the existence of space depends on the previous existence

of time. Because of this, a philosophical vision of infinite space is always preceded by the vision of infinite time, as already shown by Aristotle. What Aristotle failed to notice is that time is not spatial, i.e. it is necessarily non-spatial, while the infinite space is based on concurrent (simultaneous) existence of components of space. Therefore, time is continuity, and space is continuum. As non-spatial, continuity exists independently. As spatial, continuum bases its existence on the continuity of components, i.e. in the physical sense, the basis of space is time. These relations of fundamental notions of ontology and physics could bring about an understanding of contents of the notion of consciousness as the principal notion in psychology.

Finally, what is the physical representation of consciousness, i.e. what is consciousness in physical processes and what is its relation to physics at all?

If we accept the unique and indivisible infinite reality, i.e. physical infiniteness as the basis and entirety of the world, we shall certainly ask ourselves the question of what its qualities are, how it really looks like.

Out of four fundamental notions in ontology (continuity, continuum, discontinuity and discontinuum), the only simple notion, as already shown, is continuity. It does not assume the inevitable existence of something else, therefore, it can exist for itself. If we look at its continuity mathematically, we shall conclude that its geometric representation is a non-spatial element or point, and its arithmetic representation is a number without quantity or zero. In physics, obviously, continuity is time, i.e. time is the only notion in physics that can be clearly and strictly defined excluding all attributes of space. Furthermore, the content of the notion of "time" is non-spatial as a logical entity, as the very physical time is non-spatial. The opposite can be applied for notions such as, for instance, measurement, energy and movement. It is exactly time's quality that it is expressed non-spatially which can enable the unique identity of logical form and real world. Actually, mathematical realism, i.e. realistic interpretation of mathematical objects and operations is the basis for understanding physics as an ontological science.

The fundamental series of univocally corresponding notions of special sciences that undoubtedly constitute a new philosophy of nature can be put in this order:

Ontological *continuity* is identical to geometric point, arithmetic *zero*, physical *universal time* and psychological *consciousness*.

In order to understand this correctly, each of these notions should be understood literally in its non-spatial existence. Experience imposes an error upon us: where there is no space - there is no existence. This illusion of empirical cognition has silently remained unchallenged in all sciences. For thousands of years, the existence of non-spatial time has remained unquestioned. Non-spatiality as quality has

been attributed exclusively to the non-being and never to the being. But it is exactly non-spatial time that has a positive existence. Time is not only a standard of measurement, but also a cause of physical processes. And if it is correct that time and consciousness are the same, then consciousness is *substantia*, i.e. it is the basis of everything, entire world, independent and unchangeable notions, the essence. Consciousness is what enables the existence of space, as well as the creation of matter. Physically speaking, and if time is the basis for existence of space, and if time and consciousness are the same, then the power of consciousness to transform space and matter is so great that we have to recognize its generic qualities.

World would be a boring, undisturbed, uniform, isotropic and amorphous infiniteness if there was no time or consciousness. These immaterial and therefore non-spatial principles, that actually commonly make up a unique principle according to which consciousness and time could by no means be differentiated, beside linguistic pattern they use to communicate - are main operators of infinite being. Time, that is consciousness, makes for the unique and absolutely peaceful being of the world to divide itself into layers of relatively definite phenomenon.

This game of boundless number of final entities seems to us like creation, movement and disappearance of accidental phenomena. But these accidental phenomena do not belong to our mind, but only our experience. In the world where all phenomena are within infiniteness, incident is the only ignorance of parameters of action. Infinite world is closed in itself and the way it divides itself into layers is, according to the Buddhist tradition, only an illusory change, visible movement in the reality of immobile final beings.

If we suppose that the basis of the world is real infiniteness which non-spatial constituent is consciousness, i.e. time, then we come to the question of structures of this non-spatial entity. We come to the problem of punctual structure of time identical to the punctual structure of consciousness.

Only if consciousness is of punctual structure, it can influence the change of basic elements of space and, by forming structures of various lengths it could influence the destiny of a physical system. If consciousness is not only non-spatial but also non-structured, it would lose its relation with the world of final phenomena, i.e. with discontinuum or a sum of discontinual phenomena.

On the other hand, it is very significant to critically examine the relation of time and force and define its physical sense. Does time influence physical processes, is it an active factor of physical events? Let us assume that it is. In that case, it is clear that the notion of force and the notion of time cannot equally stand in the description of the same physical event, as they are overlapping. This is where their disjunctive relationship derives from: an event would either be

described using the notion of time, or the notion of force. Let us analyze this situation.

If the movement is expressed through time, we shall get a correct and definite result. In this description, force can be left out. If we use for description only the notion of force, it would not be complete. We have to introduce time into the formula to fully include the physical event. Therefore, time is independent from force in a physical event, and force is dependent on time. If we accept Einstein's definition of the structure of matter as a spatial-temporal event, the notion of force in physics will lose the sense and role it had so far, and its exchange with the notion of time will directly enable fundamental experiments leading to new and advanced technologies based on the control of time in physical processes.

If it is true that the structure of time is punctual, as we suppose, then this could lead to very important conclusions, like, for instance: space is a virtual derivative of real time. The notion of effect of force is contained in the notion of time. Punctual structure of time points to the fact that space is created out of time. And if time is consciousness, then consciousness is what generates not only the basis of the structure of individual physical system but entire external world that surrounds it. Why? If space is created from consciousness or time, that is according to the principle of simultaneity being structured into the matter of individual physical system, then this structure also regulates all its possible relations with the external world. This also means that our entire perception, cognitive power, as well as fate of man as a physical system is strictly determined by spatial-temporal structure derived from activities of our consciousness.

Consciousness is both the most precise and the strongest cosmic force. It only operates with common elements of construction of space and matter and thus conditions the real events.

Let us look at the basic quality of time: (a) time is *indivisible reality*; (b) it is *non-spatial*; the consequence of reality and non-spatiality of time is the virtuality of the space itself; (c) time is *endless*; the consequence of its infiniteness is its *non-localizability*, i.e. non-localized time enables the creation of dimension, i.e. origin of space. How? Non-localization gives way to *structuralism*, and this is followed by *dimensionality*, as there are more than two elements of time now in spatial relation.

This genesis is strictly controlled by the punctual structure of consciousness itself or of time.

Infinite time is reality and duration is virtual. Succession or following of non-simultaneous temporal moments is the order that is imposing dimension, i.e. infinite time as an extending but virtual entity. Therefore we perceive space as temporal flow, and for us time itself is non-spatial and immobile. Namely, time is infinite and this is why virtual borders of simultaneity are being formed in time, i.e. points with the same temporal coordination that also appear as

extension. When we discuss pure time, i.e. pure consciousness that is identical to it, we discuss something that is: non-spatial, infinite, non-localized and structured.

What kind of elements is time structured from? It consists of non-extensive and actual infiniteness or simultaneity and extensive virtual and successive infiniteness or space.

We define simultaneity of time as an order of concurrent elements of temporal structure, i.e. continuity or consciousness. In other words, consciousness is the same as synchronicity, same as temporal relation of apparently unrelated events. This thesis was already pointed out by W. Pauli and K.G. Jung.

We define space as an order of nonconcurring elements of temporal structure, and not limited dimension or continuum.

The so-called final space, i.e. part of continuum, consists of two concurrent and one non-concurrent, non-simultaneous element of temporal structure, for which the natural model of any length is  $\underline{c}$  with endings A--B, while  $\underline{c}$  is non-simultaneous with A and B, i.e. the length endings are not concurrent with the length itself. If this is disturbed and simultaneity of the line and its endings imposed, the dimension would disappear and the entire system of lines would collapse into a non-spatial point.

The problems of the ontological definition of consciousness, at first sight, is not deeply related to the existence of time, space and basic elements of matter. But, it actually is. Therefore, the definition of consciousness demands not only determination of its relation with time, space and matter but appropriate ontological definitions of all of these notions. Definitions are, of course, hypothetical, but the risk of setting these hypotheses must be undertaken, if the aim is to set up a relation between psychology, physics and mathematics, and this is necessary for any scientific analysis of the phenomenon of consciousness.

In our opinion, consciousness is not separate from natural phenomena, nor is it its passive observer, but has the status of a basic cause of cosmic events. Superior identity of consciousness and time even further supports this claim. Finally, if we suppose that time is also an active factor in material developments and attribute it with the status of force in cosmos, we shall have a good foundation to introduce causality of spirit and matter. We also have to suppose that matter and space, that are practically and theoretically inseparable, have a common constructive unit. Only here the image of the basic structure of cosmos ends. What remains is the problem of movement.

Let us imagine that there is no movement in cosmos, but inducing and deactivating of identical elements of uniform construction of infinite and isotropic world, activating and deactivating performed by time as an operator of cosmic events. The activities of the temporal operator is analogous to that of



mathematical algorithm. For A and B, however they might look like in nature, we have to imagine physical interpreters that certainly include spatiality. And for any operation A and B mutually perform, or for an operation performed with them, physical interpretation that in any way includes space is unthinkable.

All mathematical objects, geometric and arithmetic, except for point and zero, are spatial. All geometric operations, if we reduce reality from movement are, in essence, non spatial. Also, and this is clear by itself, all operations with numbers are also non spatial. By omitting movement as an illusion of our experience from theoretical concepts of a unique science, we would level the quality of geometric and arithmetic operations. In that way, using the notion of non-spatiality, what would be imposed is not only a deep relation of geometry and arithmetic, but the illusion of the world of senses and measurement would be replaced by the determination of a purely theoretical anticipation. According to all this, such an image of the basis of cosmos is closer to the real one than the one given to us by contemporary scientific paradigm; eternal movement with unfamiliar cause, time as passive in physical processes, energy as modernized notion of force, space that is multidimensional and dependent on force and, finally, matter, space and time, all together and each individually as endlessly dividable.

On the basis of previously presented cosmological sketch, consciousness can ontologically be defined as continuity, i.e. as a principle quality of continuum. Continuity is non-spatial, in essence, continuity is time supporting the existence of a spatial continuum, i.e. entire extending world.

On the one hand, the identity of consciousness and time, and on the other, the identity of time and force, are enabling the establishment of a unique initial notion for consciousness, time and force - *ontological continuity*. Only from continuity, i.e. from consciousness, we see the emergence of discontinual notion. In the order of complexity, the first of these is space and the second is matter. Therefore, according to an ontological and not only psychological, anthropological and religious view, *consciousness* is *continuity* and as such it is an elementary cosmic notion of the highest order.

## References

- [1] H. Diels, *Die Fragmente der Vorsokratiker*, I & II, (Deutschland, 1974).
- [2] F. Podmore, *Mediums of the 19<sup>th</sup> Century*, I & II, (University Books Inc, New York, 1963).
- [3] B. Petronijevics, *Der Ontologische Beweis fur das Dasenn des Absoluten* (Hermann Haacke, Leipzig, 1927).
- [4] B. Šešić, *Contemporary Theories on Physical Reality* (Beograd, 1973), in Serbian.
- [5] M. Whiteman, *Old and new Evidence on the Meaning of Life, I and II* (Colin Smythe, G.Cross, 1986).
- [6] A. Einstein, *Mein Weltbild* (Europa Verlag, Wien, 1955).
- [7] W. Crookes, *Spiritualism Viewied by the Light of Modern Science* (London, 1871).
- [8] D. Raković, Brainwaves, Neural Networks, and Ionic Structures: Biophysical Model for Altered States of Consciousness, in *Consciousness, Scientific Challenge of the 21<sup>st</sup> Century* (ECPD, Belgrade, 1996).
- [9] Lj. Rakić, Time and consciousness: A neurological approach, in this *ECPD Workshop Proceedings*, 1997.
- [10] V. Abramović, Problem of ontological definition of consciousness, in *Consciousness: Scientific Challenge of the 21<sup>st</sup> Century, Proc. ECPD Seminar*, Lj. Rakić, D. Raković, Đ. Koruga, A. Marjanović, eds., Belgrade, 1996.
- [11] V. Abramović, The phenomenon of consciousness in philosophy, in D. Raković and Dj. Koruga, eds., *Consciousness: Scientific Challenge of the 21<sup>st</sup> Century* (ECPD, Belgrade, 1995). Pp. 26-33.

## AN OVERVIEW OF BASIC N.P.N.L. METHODS NUMERICAL ANALYSIS OF LEXICOGRAPHICAL WORK

Adela Margot and Mladen Stanojević

“Adela Margot” Society, Srpskih vladara 23/II, Belgrade, Yugoslavia

**Abstract.** New psychoneurolinguistics (N.P.N.L.) represents a new approach to the traditional branches of linguistics, psycholinguistics and neurolinguistics. It uses some techniques from Cabala, such as gematria, notaricon, and temura, and from Mahikari (kototama, and kazotama), but also gives its original contribution to the research of hidden meanings of words. N.P.N.L. uses three letters, Serbo-Montenegrin Cyrillic letter, English Latin letter, and Serbo-Croatian Latin letter, to determine the value (code) of each word on the spiritual, astral, and material level, respectively. It is assumed that words with the same code come from the same source, though these words can be even contradictory. All these words can be used to find hidden meanings of the word with the same code. Some additional analysis can be performed when words are written using English Latin letter according to the rules corresponding to Serbo-Montenegrin, Hungarian, Flemish, French, and English languages. In N.P.N.L. these languages correspond to five symbolic elements: Time, Space, Fire, Water, and Earth. Some other deeper insights into the meanings of words can be obtained through the specific kind of calculations and evaluation performed according to the N.P.N.L. procedures. Adela Margot is a program that performs word analyses using N.P.N.L. techniques and procedures.

**Keywords:** *Cabala, Mahikari, neurolinguistics, psycholinguistics, word analyses.*

### 1 Introduction

Adela Margot is a program-instrument aimed at helping us to better understand the world we are working in, or we are living in. This program is a result of the extensive research done in the field of new psychoneurolinguistics (N.P.N.L.). However, it doesn't mean that this program can be used only by linguists, psychologists, or neuropsychiatrists. This program can be of help to experts in different domains, but also to ordinary people. The program acts as a mirror. It reflects our knowledge so that we can see it from a different angle and notice some new dependencies that will otherwise stay hidden. In this way interesting discoveries can be made, and our knowledge in the field of interest can be enriched.

A.M. is a kind of a *decoding* program. When we want to protect a message, we usually use numbers. To obtain the source message, we must know the decoding method. Numbers are used here to hide the semantics of the original message. It is assumed that the semantics of the words that comprise the message is obvious and clear. But, is it really the case? Let us

consider the word *man*. This is a common word, and we all think that we know the semantics of this word. This is true, but everyone of us will comprehend this word from his own point of view. What we will comprehend under the word *man* is dependent on our social environment, but also on our education. One biologist will have one opinion, a politician another, while an economist will have his own, different opinion. All these opinions will be correct from the point of view of these experts.

Believing that each word, including all conjunctions, in Torah, Rabi Shimon bar Yohaya-Moshe de Leon, a famous expert for Torah and Zohar (holy Jewish books), claimed that Moses had explained Torah to Israelis in all *seventy languages* of that time. Three known methods, gematria, notaricon, and temura, are described in Cabala, Jewish esoteric teachings. A.M. program is a method that can help us to catch the hidden meanings of the words.

The basic idea is to transform words, sentences or even texts into numbers. Whereas one word has many meanings, numbers (written using digits) always have only one meaning. In A.M. [1] there are three basic ways how to transform words into numbers using gematria principles. Instead of Jewish letters we use: (1) the order of *Serbo-Montenegrin Cyrillic* (sm.c.) letters, (2) the order of *English Latin* (e.l.) letters, and (3) order of *Serbo-Croatian Latin* (sc.l.) letters. Hence for each word three numbers are obtained. These numbers correspond to three levels, spiritual (S.) or intentional level (represented by sm.c.), astral (A.) or transmission level (represented by e.l.), and material or executive level (represented by sc.l.).

We will now explain closer the meaning of these levels. (1) *Thoughts* which are not expressed in the form of words correspond to the *intentional* level. We exactly know what we want to do, but we do not express that in words. (2) A.D.P. (Automatic Data Processing) of thoughts corresponds to the *transmission* level and gives clear *Ideas*. To make plans how to accomplish our intentions, we must express them in words. Errors are possible in this stage. Sometimes we are not able to express our thoughts-ideas-intentions correctly. (3) Finally, we perform some actions based on the plans expressed in *Words*, and this corresponds to the *executive* level.

The basic assumption in A.M. is that words with the same number have something in common. These

words may be even contradictory (gematria). All these words that, together with the level (S. - brain, fiery snake in water; A. - heart, red and blue snakes of blood vessels; or M. - intestines in water), can give us some new insights in the semantics of the considered word, sentence or text. Some useful explanations can also be obtained using the different combinations of three basic numbers and the words that correspond to them. We have explained only the elementary basis of the program, while some other details will be further presented in the paper.

The A.M. program uses a few distinguished, traditional techniques for the deep examination of words. The first three come directly from the Jewish tradition – Cabala [2]: gematria, notaricon, and temura. The other two techniques [3-5]: kototama, that discovers the spiritual meaning of words, and kazotama, that finds the spiritual meaning of numbers, come from the Japanese tradition.

## 2 Basic Assumptions

The basic goal of the A.M. program is the research and extension of knowledge in different fields based on secret meanings of words. Therefore we will briefly discuss the essence of knowledge.

The history of mankind is a witness of many discoveries and inventions which had a great impact on the development of human civilization. The rhythm in which mankind collects data accelerates constantly. Whereas in the past time it took centuries to double the existing knowledge, today it takes a few decades, with a tendency of further acceleration. However, scientists still don't have an ultimate answer as to how we actually obtain new knowledge.

We can only analyze the experience of famous men that described how they got to some of their scientific discoveries. We all know the story, how Isaac Newton had discovered the law of gravity sitting beneath an apple tree, while an apple had fallen accidentally. The law of gravity is not a consequence of deep contemplation about the laws that rule the material world. The whole law was there in a second during the fall of the apple from the tree. Similarly, our most famous scientist, Nikola Tesla, described that he had got his most important discoveries in a flash of light that had happened in his mind.

Somehow, it seems that all “new” knowledge was around us, but we were not ready to accept it. In the thirties, Nikola Tesla said:

*“A man is a perfect automaton that receives impulses from the outside world.”*

And really, we all behave as a kind of antenna, which, mainly unconsciously, receives signals from the outer world. We can count many examples where mothers feel their children are in danger, though they are not physically present there. We can all consciously increase the sensibility of our antennas. We do that through our education, but also through our experience that we collected by applying the

adopted knowledge. Real experts are often able, using their experience, to give exact assessments, although they cannot explain precisely how they obtained these results. Only what they can say is, that they use their feelings to get the results.

Hence, the sensitivity of our antennas depends on the quantity of knowledge and experience that we possess in some domain. The more experience and knowledge we possess, our antenna will be better tuned, and we will be able to receive data that were hidden previously from us. We will become personally the receivers of “new” knowledge, when we collect the critical amount of knowledge and experience. All depends on us, on our interests and on the energy we are ready to invest to tune our antennas. It is interesting to notice that our antennas are rather focused. We can receive very good data from one domain, but at the same time we can be “blind” to data from some other domains.

If we are only receivers, and not real generators of knowledge, we can ask then, where this knowledge comes from. Contemporary astrophysicians explain the creation of the material universe through the “Big Bang” theory. According to this theory, all the material in the universe was created from a point of infinite density and energy which extended itself in time, and as a consequence gave known, observable universe. The scientists still don't have the answer on the question, what this incredible explosion had initiated.

On this question only religions give the answer. For instance, in the Gospel according to St. John it is said:

(1) In the beginning was the Word, and the Word was with God, and the Word was God.

(2) The same was in the beginning with God.

(3) All things were made by him; and without him was not any thing made that was made.

In Zohar, which is considered as a kind of cabalistic Bible, it is written:

“If God once spoke and if he put a period after his word and if he does not speak any more, then it means that when he spoke he said everything. All the later words, all the later teachings, all the thoughts of the scholars - all this is only a search for a new sense in the already said. God spoke. There is no discussion about that. Unarguable is also what he said - since the Torah is one, unaltered and unalterable. The only thing we can dispute is: What he was thinking when he said what he did.”

The basic sense of Cabala lies in an attempt to give an answer to this question. It is interesting to notice that Cabala in Jewish means *to receive, to deliver*. Hence we can consider Cabala as a device (receiver-transmitter) that should focus our antennas to be able to receive the hidden knowledge, but also to transmit this knowledge to other people.

### 3 Basic N.P.N.L. Techniques

The basic technique implemented in the A.M. program attaches numbers to words. On the S. level to each letter within a word we attach a number of that letter according to sm.c., on the A. level, according to e.l., while on the M. level, according to sc.l.

The natural flow of data flees from the source across S., A., to M. level.

On the S. level (level of intentions) the information is shaped, on the A. (transmission) level it is transformed, while on the M. (executive) level it is materialized. A. (transmission) level is expressed using e.l., therefore Serbian letters (e.g. š, ć, č, ž, etc.) cannot be phonetically presented. To present these letters we must use a combination of letters. In different languages (*Hungarian-hun.*, *Flemish-fl.*, *French-fr.*, *English-eng.*), these combination can differ, hence the total at the A. level will be different. These different combinations allow an additional analysis of word meanings. In the A.M. program, this analysis is performed in relationship with five symbolic elements [1]: *Time-sm.*, *Space-hun.*, *Fire-fl.*, *Water-fr.*, *Earth-eng.*, where each of these five elements, through its linguistic characteristics, has its own meaning.

In the tradition of Babylon, *Adat* was the God of *Time* and *Space*. *Tada-sm.* (*Then*) is the opposite from *Adat*, and designates a *Cable* (through in sm. language) through time from the past. *Adat-hun.* means *Data* that represent *Space* in which we can act. The meanings of *Time* and *Space* through *Adat* are obvious by themselves. *Fire* is a symbol for a law, command, for something that must be done exactly as it is ordered, without any possibility of choice or change. *Fire* is also a symbol for male, or yang energy. *Water* is a symbol for prevention-love-compassion, by its nature goes around obstacles, and does not fulfill its aims immediately, but in a longer time period. *Water* represents patience and comprehension, and a symbol for female, or yin energy. *Earth* is a symbol for matter, sensible, concrete. Using this symbol we can find a correct explanation for a concrete fulfillment of an idea (materialization of an idea).

*Time* is expressed in sm. language (*RA\AM-Vod sm.* - *I give birth-Lead*). For the letters that miss in e.l. we use: š - sj, ć - ty, ž - zs, č - tch, ...

*SPACE* is expressed in hun. language (*MA\AR-Bogaras*; capricious, unpredictable; notice that Bog sm. - God + aras hun. - harvest means: Harvest God!) We use the following combinations of letters: č - cs, ć - ty, đ - gy, lj - ly, nj - ny, š - s, ž - zs, c - sz...

*Fire* is expressed in fl. language: (*Boog fl.* - *arch*; Regen-boog fl. - rainbow; regen hun. - long time ago + Bog (*Adat-Tada*) smc. - God, gives: God long time ago). The following combinations of letters are used: i - ie, u - oe, ć - tj, c - tz, s(h) - sch, h - g, š - sj, ž - j, ž - ge, ...

*WATER* is expressed in fr. language: (*Boghai fr.* - *chariot with two wheels*. Bog eng. + hei fl. - from one extreme to another. Chariot will easily take us from the balanced state to hell if we do not remember on time that one wheel is Vod sm.c. - Lead, and the other wheel is Bog c.l. - God. From a word that designates both *Lead* and *God*, Supreme Creator, *Createur fr.*, we easily obtain *Ea*, the name of Babylon Goddess which creates new life, but also *Eau fr.* - *Water*). The following letter combinations are used: š - ch, u - ou, č - tch, ...

*Earth* is expressed in eng. language: (Bog - *Močvara sm.*, wherefrom we get *Moct cm.c.* - *Bridge + Hvara l.*, God down in a swamp. If we read down like Arabs or Jews we get in sm. n - acknowledgment and vod - lead. The mud is in the wrong pronunciation of spoken words, and in the reading of their letter). The following combinations of letters are used: š - sh, c - ts, č - tch, ...

For the same word on the A. level we can get from one to five different numbers using different transcriptions. These numbers and letters allow us an additional analysis of words according to the corresponding elements.

### 4 Calculations

Using numbers that correspond to a word on the S., A., or M. level, we can perform some other calculations.

- We first find sums on two levels: S. + A., S. + M., A. + M., from the S. wire which is the *Essence of Being*, *Biti Biti sm.* The transmitted data should help us to comprehend the *Essence of Being* and how to BE in *Essence*, *Biti Bit sm.*, through written Cyrillic letter and Latin letter;

- and then combined sums: SA + SM, SM + AM, SA + AM, which show us that if spirituality begins to diverge, *Then, Tada sm.*, a *Battle, Bitka sm.*, occurs. Instead to be conscious about how to BE in *Essence*, *Biti Bit sm.*, a *Fight, Tuča sm.*, begins, or *Beat* the *Essence, Tući Bit sm.*;

- Subtractions between levels are also considered: 1 - 2, 1 - 3, 2 - 3, where 1 represents the level to which corresponds the largest number - *Bit sm.*, the *Essence*, 2 - the level with the medium value - the verb *To be, Biti sm.*, and 3 - the level with the lowest value - *Tući sm., To Beat*;

- but also the combined retractions: I - II, I - III, II - III, where I represent the highest sum on two levels, II - the medium sum, and III - the lowest sum.

Within the calculations we also determine: |1 - 2| + |1 - 3| + |2 - 3|, and the difference between the lowest sum on two levels, and the highest value of levels: III - 1 representing the transformation of Cyrillic letter to Latin letter, and the total sum on three levels: S. + A. + M., which represents the illusion we observe on the material level.

## 5 Evaluation

Within the evaluation we consider the sum on three levels. Suppose that this sum is a three digit number  $xyz$ . We will add the digits of this sum in the following way:  $\begin{array}{r} xz \\ yz \end{array}$ , what is inside goes outside,

$\begin{array}{r} y \\ \underline{\quad} \end{array}$   $\begin{array}{r} x \\ \underline{\quad} \end{array}$   
and vice versa, what is outside, according to the boomerang principle, turns back to its source.

We will add these two numbers, and apply the same method to the sum. The method should be repeated until we obtain a two-digit sum, which represents dates, that can be compared with the words from different levels with the same value.

The evaluation for the number 197 would be:

$$\begin{array}{r} 17 \quad 97 \quad 25 \quad 05 \\ \frac{9}{107} + \frac{1}{98} \quad \frac{0}{25} + \frac{2}{7} \\ 205 \quad 32 \end{array}$$

The evaluation for the number 198 is specific, because as the result we get 189 again:

$$\begin{array}{r} 19 \quad 89 \\ \frac{8}{99} + \frac{1}{90} \\ 189 \end{array}$$

In that case further evaluation must terminate. 189 is the code of an enchanted *circle* from 1989-99, and the exit is possible only through 8.1. Each one must regain its consciousness to avoid the enchantment in nineties. In the case we have a four-digit number  $uvwx$ , the digits should be added in the following way:

$$\begin{array}{r} u \quad w \quad w \quad x \\ v \quad x \quad v \quad u \\ 13 \quad 32 \\ \frac{22}{35} + \frac{21}{53} \\ 88 \end{array}$$

When we obtain the two-digit number  $xy$ , we dissolve it into two numbers,  $Iuy$  and  $xvI$ , where:  $x = 1 + u$ , and  $y = 1 + v$ . For instance, from the number 32, we get the numbers  $\underline{122}$  and  $\underline{311}$ . For these two numbers we perform the above described addition of

$$\begin{array}{r} 12 \quad 22 \quad 31 \quad 11 \\ \frac{2}{32} + \frac{1}{23} \quad \frac{1}{41} + \frac{3}{14} \\ 55 \quad 55 \end{array}$$

The first digit represents the Japanese way of writing, the downward stream, while the second number represents the Chinese way of writing, the upward stream. These streams tell us if something is happening according to God, or according to Ancestors which may ask for help.

Note that digits here should be added only once, and not until a two-digit number is obtained. With these two sums, the evaluation is completed according to its density-heaviness.

## 6 Example

All techniques described by now will be illustrated by applying them on the word *Tesla*, the unit for the measurement of electro-magnetic induction (*S leta sm.* - *During summer, From flight, Slate sm.* - *Sent, Altes fon. fl. and fr.* - *Highness*).

The word *Tesla* can be written in two different ways on the A. level, using the transcription of hun. language (*Space* - Table 1), and using the transcription of sm. language.

**Table 1** Elaboration of the word *Tesla* (*Space-hun.*)

S.		A.		M.		CALCULATIONS	EVALUATION
T	22	T	20	T	26	S + A = 147	23 23
E	7	E	5	E	9	S + M = 140	$\frac{2}{\quad} \quad \frac{2}{\quad}$
S	21	S	19	S	24	A + M = 159	43 + $\frac{25}{\quad}$
L	13	Z	26	L	16		68
A	1	L	12	A	1	SA+SM = 287	68 = $\frac{158}{\quad}$
		A	1			SM+AM = 299	671
						SA+AM = 306	
						83 - 76 = 7	18 58
						83 - 64 = 19	$\frac{5}{\quad} \quad \frac{1}{\quad}$
						76 - 64 = 12	68 + $\frac{59}{\quad}$
							127
						159-147 = 12	61 71
						159-140 = 19	$\frac{7}{\quad} \quad \frac{6}{\quad}$
						147-140 = 7	131 + $\frac{77}{\quad}$
						7+19+12 = 38	208
						140 - 83 = 57	
$\Sigma=64$		$\Sigma=83$		$\Sigma=76$		$\Sigma=223$	

The name of Nikola Tesla symbolized the development of science and engineering, the ideal of high scientific ethics, humanity and love to people,

which is confirmed by his words: "Great man is the one that surpasses other people by his mental gifts and abilities, collects the knowledge, and discovers

*new truths, but all that does with love to mankind, to help it to get out of misery that bodes it - fear, hunger, ignorance, and illness”.*

## 7 Interpretation

As we saw, the result of the elaboration of words is given in different numbers. All words that correspond to the same number, come from the same source, hence we use the words with the same number to find the meaning of the word. We should pay attention that sometimes words with the same number do not have the same meaning and can even be contradictory. During the interpretation we do not use all words, but only those that have sense in a given context. The level of these words (S., A., M.), and the corresponding element (*Time, Space, Fire, Water, Earth*) can give some additional, useful data.

## 8 Conclusions

The A.M. program represents a precise instrument for investigation of knowledge. The data base contains words, or sentences we want to elaborate. Program analyses the words using Serbo-Montenegrin Cyrillic letter, English Latin letter, and Serbo-Creation Latin letter, as well as previously entered words (sentences), and enables observation of known facts from a different angle. In this way we can discover some hidden meanings, or some new relationships that would otherwise stay hidden. The program doesn't have an active role, because it doesn't discover anything. It acts as a mirror which reflects our own

knowledge, thus helping us to discover our own some new things. The more data we enter, the more precise and clear reflection we will get, that will make easier for us to find the hidden meanings. By use, the program is enhanced constantly. The program can be used not only for knowledge analysis, but also for the analysis of persons, happenings, or as an advisor. However, it doesn't give its own opinion, but helps us to derive the needed conclusions. In this paper we have described only the elementary techniques used in the *Adela Margot* program. The overview of all methods would require much more space.

## References

- [1] Adela Margot, *The 30-letter Handwritten Cyrillic Alphabet is the Key* (Adela Margot, Belgrade, 1995).
- [2] G. Žutić and A. Milenković, *Secret Messages* (Biblioteka tajne, Belgrade, 1987).

## A BRIEF INTRODUCTION TO NOETIC FIELD THEORY: THE QUANTIZATION OF MIND

Richard L. Amoroso

The International Noetic University, 120 Village Square #49, Orinda, CA 94563-2502 USA

E-mail: ramoroso@hooked.net

&

Cerebroscopic Systems, Inc; 48 Shattuck Sq. #148, Berkeley, Ca 94704 USA

E-mail: cerebroscopic@mindspring.com

**Abstract.** The orthodox Copenhagen interpretation of quantum mechanics, an epistemological model based on the phenomenology of measurement, and the statistical evolution of state, has been known from its inception to be incomplete. Consciousness is considered a hard problem by defining brain states of awareness as the fundamental property from which to formulate a science of consciousness. A deeper ontological model called noetic field theory includes the domain of Planck scale quantum gravity and a nonlocal noetic process enabling mind to be quantised and surmount uncertainty through the synchronicity of a delocalised noetic effect that provides the entry point of intentionality that phase regulates quantum brain dynamics. This occurs throughout the body; one pertinent level is provided by ordered water as a synchronization backbone. Quantum gravity is an essential factor in the dynamics of consciousness especially intentionality. In the spin exchange compactification model of gravity, gravitons turn out to be confined photons of the unified nonlocal field that curves spacetime. This has implications for the quantization of mind in that the phase regulation of intentionality is mediated by a nonlocal Boson called the noeon.

**Keywords:** quantum gravity, ontological, noumenon, teleological, noetic effect.

### 1 Introduction

The standard model does not describe biological systems, the large scale structure of the universe, or the high energy of the Planck scale. We have had to wait for a deeper ontological interpretation of Quantum Theory to couple consciousness to brain dynamics. *Noetic field theory - The Quantization of Mind*, in part an extension of Bohm's pilot wave model [1] and Cramer's transactional interpretation [2] into a nonlocal domain encompassing elemental intelligence, is such an ontological interpretation. In addition to solving Chalmers' hard problem [3] by showing that awareness is not a fundamental principle from which to formulate a theory of consciousness, because awareness in a field model is comprised of primary base states; Noetic Field Theory also removes Descartes error of relegating mind to immateriality by the bosonization of the Eccles' Psychon [4,5].

According to the noetic interpretation, individual intelligence is a teleological noumenon with triune parameters confined to a Psychosphere defined as the hyperstructure signifying the complete domain for events of consciousness. In this cosmology consciousness is a self organizing interaction of (1) the local matter field confined to the Heisenberg matrix of the brain holoscape described by Pribram [6], and (2) a complementary nonlocal noetic field originating in a noetic space encompassing singularities of elemental intelligence. This Psychosphere includes the dynamic raster of consciousness within which all conscious processes evolve; not in the manner often described by wave function collapse, but based on the density matrix of the matter wave [3,7,8]. The complementarity of these two domains is integrated by (3) a cosmological ordering principle, a quantum of action, that mediates cosmological and quantum gravity locally and at the Penrose twistor level. A taxis principle of consciousness called the Noetic Effect couples causally to Bohm's quantum potential to act as a phase regulator in the midst of pumped Frohlich-like coherent states for Pribram's holonomic formations of the dendritic microprocess [6].

$$k(x, t) = \nabla S(x, t) = \left( \frac{\partial S(x, t)}{\partial x^1}, \frac{\partial S(x, t)}{\partial x^2} \right) \quad (1)$$

This is an entry point of consciousness into quantum systems. Although Bohm's pilot wave model with its connection to classical dynamics has been criticized as bringing determinism back into quantum theory; the resultant causal connection of the Noetic Effect to the quantum potential does not make the system deterministic per se, for as generally known, the logic of human practical reason [9] is governed by nonlinear acausality leaving these nodes open to pertinent stochastic, chaotic, catastrophic, or tunneling influences. Because Noetic Field Theory contains a field like any other physical field, consciousness is quantifiable. Work in progress to detect the Psychon/Noeon through phase control laser interferometry and optical nutation is proceeding [10]. The measurement problem need only be applicable to

particles obeying Fermi-Dirac statistics. This is based on an ontological cosmology not limited to the standard model; but entails the pragmatic utility of a teleological nonlocal noetic process which has shown that mind is a quantised interacting noumenon not a brain phenomenology limited by the uncertainty principle, but through synchronicity maintains interaction free states of superposition. Apparently the universe is more conscious than physicists have recently wanted to admit. Noetic Field Theory thus provides a framework to formulate a comprehensive theory of consciousness [11-13].

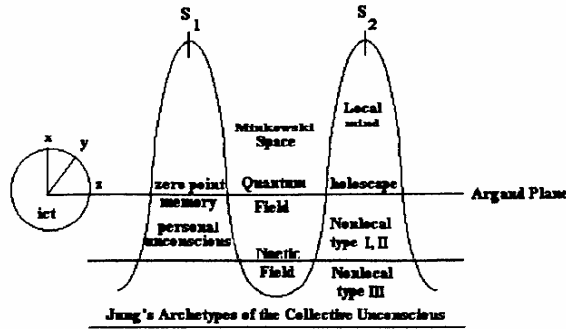

**Figure 1** A simplified spacetime diagram representing the three known cosmological domains, and the physical basis for synchronicity and Jung's collective unconscious which nonlocally store racial archetypes.

## 2 Collective Modes of Ordered Water as a Synchronization Backbone for Consciousness

For over thirty years it has been suspected that collective modes of conformation in the dipole oscillations of neuromolecular systems are a key factor in the dynamics of consciousness. Until recently even though a brain cell is almost eighty percent water, the role of water in this process was dismissed as only a background filler within which to suspend biological species. This paper discusses the spin glass properties of ordered water as a vehicle essential for the synchronization backbone of the quantum dynamics of consciousness. The utility of ordered water as part of the synchronization backbone of the conscious process is in its dipole oscillations acting as (1) a buffer for phase transitions which supplies a switching mechanism, (2) directional quenching of periodic moments which acts as an aid in maintaining coherence effects, and (3) a medium to translate microscopically distinct Hamiltonian operators into macroscopically equivalent long range correlations. This water mechanism would operate in association with the quantum dynamics of microtubules and the tunneling trigger mechanism of vesicle release at the synapse to integrate the total quantum conscious field.

### 2.1 Ordered Water

Water is electrically neutral overall; but because of charge asymmetry in the geometry of the Hydrogen

and Oxygen bond the water molecule is polar. This allows adjacent water molecules to hydrogen bond into clusters that have been found binding to protein surfaces. A (20) water cluster is very stable due to strong Coulombic interactions and believed to be associated with microtubules [14,15].

### 2.2 Collective Modes

The water molecule has a constant electric dipole moment that coincides with its axis of symmetry. Several degrees of freedom apply to the water molecule; spatial motion, rotation, and molecular vibration. The most important being molecular rotation around the axis of symmetry. This 'spinning top' can be considered a quantum mechanical spinor field which couples to the collective modes of the electromagnetic vibration of biomolecules throughout the brain. Collective modes are the key to the dynamics of living systems. When the energy Eigenstates of oscillating dipole molecules become strongly correlated it is called quantum coherence. It is the propagation of these coherent states, Fröhlich waves of between 100 billion to a trillion hertz, exchanging energy with the electromagnetic field, that is believed to be the basis for consciousness [8,16].

$$\mu = -\sum_i q_i r_i \quad (2)$$

$$\Delta E = h\nu = \frac{hc}{\lambda} \quad (3)$$

A water molecule has a dipole moment resulting from the oscillation of van der Waals radii around the covalent bond. The dipole oscillation by incident photons or coherent waves in biological systems produces conformational change in optically active molecules. Eq. (2) is the vector potential of a dipole moment; which is the product of the charge  $q$  and the radius  $r$ . Eq. (3) shows the change in energy  $E$  depends on Planck's constant and either the frequency  $\nu$  or the wavelength. Conformational variation can originate in the energy variance from the ground state by incident photons. In the case of the brain this would be by corticons and psychons or noeons.

### 2.3 Synchronization Backbone

Richard Feynman found nothing in the laws of physics to suggest that a quantum computer wasn't possible; and that the most feasible way to build a quantum computer was using a 'synchronization backbone' [17]. The synchronization backbone eliminates the time dependence of the systems Hamiltonian without which the quantum computer could not maintain data accurately and be useless. A conscious quantum computer simulating quantum brain dynamics has been designed [18,19]. The purpose of the synchronization backbone is to provide a buffer to support coherence effects. This accomplishes two things: (1) an amplification or memory effect, and (2) to ease transitions in wave propagation thus avoiding thermalization which would annihilate coherence. In



the conscious quantum computer laser phase control interferometry resonating at Fröhlich frequencies in heteroseric molecular crystals provides the synchronization backbone. Feynman's [17] synchronization backbone works by building the quantum computer on top of another quantum system. It is suggested in this paper that the human brain performs quantum computation and also contains a synchronization tier and that the synchronization backbone for consciousness is provided by the activity of ordered water and its coupling to microtubules and other dipole oscillations in the cortex. This provides the two tiered quantum system necessary to provide the synchronization backbone.

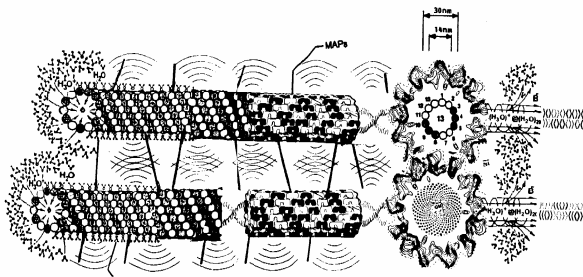

**Figure 2** Ordered water as the synchronization backbone for nonlinear switching in quantum brain dynamics. A pair of microtubules with microtubule associated proteins (MAPs) connecting them. Water is shown around the microtubule and coupled to the outer tubulin surface. The microtubules are also shown in cross section revealing the 13 protofilaments surrounded by electron density maps that shroud the length of the tubule. The electron density varies with the energy state of the dipole oscillations of the tubulin dimer and associated water molecules. Inside the microtubule is an energy field where water assembles into clusters along the inner surface. It is believed that coherence occurs in the core of microtubules through cyclotron resonance at Fröhlich frequencies. The Casimir radius inside a tubule is of sufficient diameter that this ordered state might Bose condense providing a basis for one aspect of consciousness. Ordered water also has spin glass properties and is postulated here to provide the synchronization backbone that makes this superradiance a possible aspect of consciousness information processing [14,17].

### 3 Quantum Brain Dynamics and the Noetic Field Theory of Consciousness

Quantum Field Theory has several branches, Quantum Electro Dynamics (QED) for electromagnetic interactions, and Quantum Chromo Dynamics (QCD) for strong interactions for example. Quantum Brain Dynamics (QBD) is the quantum field theory describing biological systems [8]. QBD is mediated by the corticon, a quantum of the water rotational field which interacts with the electric dipole oscillations along proteins. When synchronization of the water corticon and electromagnetic field occurs, nonlocal coherence is manifest giving rise to long range order and collective phenomena. Nonlocal coherence provides a much stronger correlation than a classical collective mode could describe.

QBD of the water rotational field and interacting electromagnetic field although providing an excellent model of neuromolecular computation is not sufficient to describe consciousness because free will or intentionality is still left out of the picture. For this we need an extension of the orthodox epistemology of the Copenhagen interpretation into the quantum ontology of Bohm and Cramer [1,2]. Bohm described the quantum potential as a nonlocal pilot wave effecting the probability matrix of the Schrodinger equation. Bohm's work was criticized for bringing causality back into the picture because the pilot wave makes a connection to classical mechanics. *Noetic Field Theory: The Quantization of Mind* completes Bohm's work. Intentionality is nonlinear and acausal, not linear and causal as the determinism of Newtonian mechanics was. So although the result of intentionality acts as a causal operator on the quantum potential; because of its nonlinear/acausal dynamics the probabilities inherent in the evolution of the Schrodinger equation are not violated. This is the entry point of mind into quantum theory and another key factor for in the operation of the synchronization backbone provided by the water corticon field. Neurocomputing models of the brain are linear closed systems; Once a computer is programmed there are no remaining degrees of freedom for rational input. The see saw action or harmonic oscillation of the synchronization backbone provides a switching mechanism called the noetic effect [12] for the entry of either intentionality or sensory phenomenology into the conscious process.

In summary water has been theorized to play two important roles in consciousness: (1) to provide a storage buffer to amplify or attenuate the corticon field, and (2) to allow switching between sensory computation and intentionality. Although the role of ordered water in the dynamics of consciousness remains a qualitative model at this point in time, a growing body of literature from both experimental and theoretical areas are converging to suggest an important role of water in the quantum physics and molecular biology consciousness.

### 4 The Noetic Effect: The Entry Point of Intentionality Phase Control

Quantum Brain Dynamics (QBD) the quantum field theory describing the fundamental mechanics of the brain consists of the corticon field of water rotation and the electromagnetic field extending throughout the brain. This is an open system interacting with the classical active manifold of entrained dendritic and neural processes called the holoscape that couples phenomenal information back to the phase space of the Heisenberg matrix of QBD below it. To provide an empirically testable model for the phase regulation of holoscape patterns, a radical framework of noetic psychotropism called the noetic effect is described in this paper: (1) formulating a

physical basis for Jung's synchronicity factor and archetypes of the collective unconscious, (2) introducing a multi-mode phase regulator into the pattern of charge carriers in the dendritic holoscape of Karl Pribram's seminal work on holonomic brain theory, and (3) describing an inherent action

$$\hbar \frac{\partial \theta}{\partial t} = -\frac{1^2}{2} |\nabla \Theta|^2 + V - \frac{\hbar^2}{2m} \frac{\nabla \cdot \nabla R}{R} \quad (4)$$

of the conscious process called the Noetic Effect. This is accomplished by applying the author's work on Noetic Field Theory (an extension of Bohm's ontological quantum theory into a teleology that includes a nonlocal conscious process) [11,12], to recent developments in the emerging science of Consciousness. This represents a first practical application of Holonomic Brain Theory.

The noetic psychotropism is based on a complementarity of mind and body [5]. The Eccles psychon is bosonized into a unified field theory to recast mind as a material entity [4], not immaterial as originally described in Cartesian dualism. Pauli and Jung [20] tried to formulate a quantum mechanical model for Jung's concepts of the collective unconscious and the synchronicity factor; but physical theory was not advanced enough at that time to accomplish the task. Now we suspect that memory operates with vacuum zero point fluctuations [21,22] by a type of neural holography [6]. There are two types of memory involved: (1) every day personal memory of learned facts and experienced events more or less under direct conscious mediation, and (2) a transpersonal 'memory of being', a dynamic Hilbert space storing archetypal forms of the personality or psyche. These forms can be compared to a dynamic backbone synchronization [17] in a quantum computer acting as a waveguide for the translation of the noetic field. Archetypal forms although they can be objects of subjective attention are generally occluded deeply in the Jamesian fringe because they provide more the bottle of rather than the experiential content of awareness.

According to *Noetic Field Theory - The Quantization of Mind*, the Psychosphere is defined as the hyperstructure signifying the domain of individual intelligence; a self organizing interaction of the local matter field confined to the Heisenberg matrix of the brain holoscape and a complementary nonlocal noetic field that includes cosmological factors of consciousness. This is the dynamic raster of consciousness within which all conscious processes evolve; not in the manner often described by wave function collapse, but based on the density matrix of the matter wave [7,8,12]. In this context action of the Noetic Effect can induce a trophic phase. In physical terms this syzygy would have active mediated moments of force. The noetic effect as mediator of the nonlocal conscious process, acts as a causal (including the acausal/nonlinear properties of rationality) operator on Bohm's quantum potential. This is a point

of entry of consciousness into quantum systems. This includes both conscious and subconscious nodes of entry. Driven by the Hamiltonian of the Conscious Potential, the resultant action of the Noetic Effect couples operators of the Noetic Field to specific loci of pumped Fröhlich-like coherent states. This is a phase regulator into the patterns of Pribram's holonomic formations [6]. The pumping mechanism for this process is inherent in the self organization of the system. The radiation pressure of the (Psychon) Bose state, Fermi-quasiparticle transitions, vacuum zero point fluctuations, and string dynamics etc (full gravitational circle - cosmological to quantum) are sufficient to drive this dynamic. This is the normal operation of energy flow by the nonlocal conscious ontology causally coupled to Bohm's quantum potential. Thus the current thinking on the involvement of wave collapse is a mathematical invention not a description of the actual logical cosmology of noetic consciousness [12,23].

The influence on development by significant others seems obvious; children are imprinted with many personality characteristics of their extended families. Under certain conditions a deeper psychotaxic noetic force causes prenatal inversion of the foundation of the psyche, providing an apparent genetic pre-disposition for attributes. The concept of noetic psychotropism applies physical theory somewhat ahead of its time. Experimental protocols being developed will rigorously quantify this model; but early application of noetic field theory to holonomic brain theory seems warranted. The noetic action of archetypes allows adjustment by self actualization or psychotherapy. Because operation of the noetic effect is deeper than current understanding at the psychosomatic level; noetic psychotropism will lead additionally to therapeutic methods for personality disorders and medical problems like colitis and Alzheimer's disease [24].

## 5 The Philosophical Foundations of Noetic Field Theory

John Bell stated that the division between classical and quantum is not one of size but a division between matter and mind [25]. He mistakenly thought that mind was immaterial; it has only seemed this way for the last three hundred years because the material aspects of the noumenon of consciousness have been hidden behind the nonlocal Planck barrier. If this were not so minds would not be safe from external influences and mental problems would be the norm rather than the exception and strong willed individuals would be easily able to harm weaker psyches. The noetic field of consciousness is mediated by Bosons, In the local brain these have been called corticons and psychons, the nonlocal Boson introduced by noetic field theory is called the noeon. This has been heretofore missed by the incompleteness of the standard model which is limited by the uncertainty

principle. Through a delineation of synchronicity by noetic field theory the noeton may be experimentally accessed through phase control laser interferometry [10]. In the past photons have been generally considered as arising from the electrostatics of atomic structure. This is not the only topology able to release Bosons. Quantum cavity electrostatics of the Planck scale vacuum backcloth also is mediated by photons - confined as gravitons in the case of matter [26,27], and noetons mediating nonlocal elemental intelligence with brain activity [4,11].

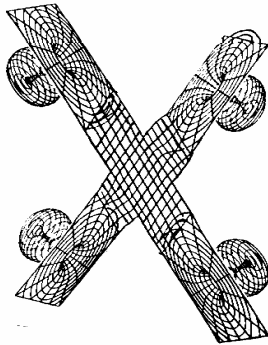

**Figure 3** Snapshot or strobeshot of an x,y dimensional Planck scale string during compactification dynamics showing the rotational symmetry and spin exchange of confined gravitons (photons) producing spacetime curvature and noetons (photons) as they translate energy as simple harmonic oscillators, local time to nonlocal atemporality. Time and the z dimension are totally suppressed. The higher dimensions are not shown. This is a three dimensional diagram in two dimensions of a four dimensional object. Full discussion appears in [26,27].

Compactification was not fixed in an original big bang cosmology, but occurs outside of time. Time and Minkowski space are a product of our conscious reality. Local annihilation and recreation of all particles reveals the nonlocal propagation of the unified field as the quantum of action governs the flow of energy in all particle interactions and mediates time in the face of atemporality; this is the reason for the compactified dimensions. The extra degrees of freedom are needed to keep our perception of the external world smooth. Reality is like a standing wave composed of many dimensions. Plato's analogy of the cave [28] provides a good metaphor if applied to a movie theater. Reality is observed on the screen before us, but at the quantum level, the film in the projector is composed of discontinuous frames of celluloid. The discontinuity is not observed because it occurs at the Planck time of  $10^{-40}$  seconds. Neither does reality fall apart because of the high order of magnitude the Planck energy.

Parting Gedankenexperimente: If it is assumed that consciousness is mediated by tensor noetons, the leading lightcone singularity is modulated by a phase of the twistor (or heterotic string) noeton field. Noetic field theory trivializes the hard problem and is the first theory to have practical applications for biosensors or sensory bypass transducers [19].

## References

- [1] D. Bohm, A suggested interpretation of the quantum theory in terms of "hidden variables", I & II. *Phys. Rev.* 85 (1952), pp. 166-179 and 180-193.
- [2] J.G. Cramer, The transactional interpretation of quantum mechanics, *Rev. Mod. Phys.* 58 (1986), pp. 647-687.
- [3] D. Chalmers, Facing the hard problem of consciousness, *J. Consc. Stud.* 2 (1995), pp. 200-219.
- [4] R.L. Amoroso and B. Martin, Modeling the Heisenberg matrix: Quantum coherence & thought at the holoscape matrix and deeper complementarity, in J. King and K. H. Pribram eds., *Scale in Conscious Experience* (Lawrence Erlbaum, Mahwah 1995).
- [5] J.C. Eccles, Evolution of complexity of the brain with the emergence of consciousness, in K.H. Pribram, ed., *Rethinking Neural Networks: Quantum Fields and Biological Data* (Lawrence Erlbaum, Mahwah, 1993).
- [6] K.H. Pribram, *Brain & Perception* (Lawrence Erlbaum, New Jersey 1991).
- [7] D. Nanopoulos, *Rivista Del Nuovo Cimento* 17 (1994), pp. 1-53
- [8] M. Jibu and K. Yasue, *Quantum Brain Dynamics and Consciousness* (Benjamins, Philadelphia, 1995).
- [9] J. Searle, The problem of consciousness, in J. King and K.H. Pribrams, eds., *Scale in Conscious Experience* (Lawrence Erlbaum, Mahwah, 1995).
- [10] R.L. Amoroso, The production of Frohlich and Bose-Einstein coherent states in in vitro paracrystalline oligomers using phase control laser interferometry, *Bioelectrochemistry & Bioenergetics* 40 (1996), pp. 39-42.
- [11] R.L. Amoroso, Consciousness a radical definition: The hard problem made easy, *The Noetic Journal* 1 (1997), pp. 32-48.
- [12] R.L. Amoroso, *Noetic Field Theory: The Quantization of Mind*, book in progress.
- [13] R.L. Amoroso, The extracellular containment of natural intelligence: A new direction for strong AI, *Informatica* 19 (1995), pp. 585-90.
- [14] D. Koruga, Information physics: In search of a scientific basis of consciousness, in D. Rakovic and D. Koruga eds., *Consciousness: Scientific Challenge of the 21st Century* (ECPD, Belgrade 1986).
- [15] J.G. Watterson, A role for water in cell structure, *Biochem. J.* 248 (1987), pp. 615-617.
- [16] H. Fröhlich, Long-range coherence and energy storage in biological systems. *Int. J. Quant. Chem.* 2 (1968), pp. 641-649.
- [17] R. Feynman, Quantum mechanical computers, *Found. Phys.* 6 (1986), pp. 507-531.

- [18] R.L. Amoroso, Engineering a conscious computer, in T. Toffoli and M. Biafore, eds., *Proc. Fourth Workshop on Physics & Computation (Physcomp96)*, 1996, pp. 12-16.
- [19] R.L. Amoroso, The theoretical foundations for engineering a conscious quantum computer, in M. Gams, ed., *Mind Computer* (in Press).
- [20] C.G. Jung and W. Pauli, *The Interpretation of Nature and the Psyche* (Bollinger, 1955).
- [21] L.M. Ricciardi and H. Umezawa, *Kybernetik* 4 (1967), pp. 44-48.
- [22] C.I.J.M. Stuart, Y. Takahashi, and H. Umezawa, *J. Theor. Biol.* 71 (1978), pp. 605-618.
- [23] Y. Orlov, The logical origins of quantum mechanics, *Ann. of Physics* 234 (1994), pp. 245-259.
- [24] R.L. Amoroso, The psychogenic initiation of Alzheimer's disease, *Proc. WPA Conv.* (1992).
- [25] J. Bell, *Speakable and Unspeakable in Quantum Mechanics* (Cambridge Univ Press, Cambridge, 1987), p. 191.
- [26] R.L. Amoroso, The origin of cosmic microwave background radiation in the intrinsic fluctuation of vacuum compactification cavity electrostatics, in G. Hunter and S. Jeffers, eds., *Causality and Locality in Modern Physics* (Kluwer Academic, Dordrecht, in press).
- [27] R.L. Amoroso, M. Kafatos, and P. Ecmovic, The origin of cosmological redshift in spin exchange between Planck scale vacuum compactification and nonzero rest mass photon anisotropy, in G. Hunter and S. Jeffers, eds., *Causality and Locality in Modern Physics* (Kluwer Academic, Dordrecht, in press).
- [28] Plato, *Plato: The Republic* (Penguin, 1955), p. 316.

## THE ROLE OF SYNAPTIC JUNCTIONS IN THE IDENTIFICATION OF HUMAN CONSCIOUSNESS AND IN THE INTERPRETATION OF THE PATHOGENESIS OF COMA

Massimo Bondi<sup>1</sup> and Manuele Bondi<sup>2</sup>

<sup>1</sup>L.D. Surgical Pathology University "La Sapienza" of Rome;  
Research Dept. "G. Mendel Institute", Rome, Italy  
Fax: (+39 6) 999 7048

<sup>2</sup>Biological Evolution Dept, University of Parma,  
Viale delle Scienze, 43100 Parma, Italy

**Abstract.** Ever since the time man became aware of his own existence, that is, "self-conscious", he has been moving along the anxious route of philosophical thought. In recent years both scientific and philosophical communities have been showing a growing interest for the human experience of consciousness. In particular, the relation between mind and brain has been explored and such investigation has thrown light on the physiology associated with thought processes, especially through the use of powerful techniques (positron emission and magnetic resonance coupled with computers).

After a review of the most important scientific discoveries of the past and of the more recent acquisitions in the field, we propose a new hypothesis on the emergence of consciousness based on the recognition of the important role played by all cortical brain synaptic junctions taken as a whole, as a newly identified structure. Such a structure, which we call Unified Synaptic Channel, could be involved in other processes, depending on its functional properties, which we try to further expound in the interpretation of the coma; such a phenomenon, we maintain, should not always entail a complete loss of mental activity [1], rather a more or less temporary loss of consciousness, due to the reversible obliteration of the Unified Synaptic Channel, and could thus be referred to as a phenomenon of "asynapsy".

**Key words:** *consciousness, cortex, mediator molecules, presynaptic and postsynaptic membrane, USC - unified synaptic channel.*

### 1 Introduction

The question of whether consciousness can be related to parts or "loci" of the brain can be traced in time at least as far back as Descartes' rigid separation between mind and matter, and even further back: both the ancient and the medieval Western cultures flourished with interpretations of the nature of the soul and of man's role in the economy of the Universe.

Amongst the great number of authors who studied the subject in more recent times, two different opinions took form, which can be termed as "materialistic" and "spiritualistic": nowadays the debate between the two currents has not yet lost its momentum (we may quote for example the

materialistic theory of Dennett [2] and Edelman [3] versus the spiritualistic one of Eccles [4]). For present purposes we shall overlook such metaphysical aspects and concentrate on a few relevant steps.

Early in the century Sherrington [5] introduced the term "synapse". In 1976 a new technique - called patch clamping - was introduced by Neher and Sakmann [6]. It became thus possible to register and amplify the movement of ions through a single synaptic membrane. In 1985 Changeux [7] spoke of neuronal "cell assemblies" - from millions to thousands of millions of cells - whose interaction could account for the origin of consciousness. Recently, Raichle [8] using PET (Positron Emission Tomography) and MRI (Magnetic Resonance Imaging) techniques, pictured a network of cerebral areas "talking to each other as individual groups gathered in assemblies"; in this way signals spread very quickly (0.01 seconds from one side of the brain to the other). Thus it can be held that each event can be registered by being "assembled" on the way.

These are among the most important data of a huge bibliography on the subject and they outline the fascinating complexity of research in the field of neurobiology. The object of the present paper is to picture a reasonable hypothesis accounting for the phenomenon known as "loss of consciousness" or as "asynapsy", which unfortunately so frequently occurs in modern everyday life in comatose patients. The recognition of the important role played in such cases by all cortical brain synaptic junctions taken as a whole, a global structure to which we synthetically refer as the Unified Synaptic Channel (USC), constitutes the central point of our hypothesis, and furthermore has led us to put forward a possible theory for the emergence of consciousness on a neuroanatomical and physiological basis.

We hope that in the near future our hypothesis may receive the comfort of clinical, radiological and neurobiological experimental data.

## 2 Discussion

We believe that it would be inappropriate, on account of the nature of this work, to recall the detailed structure of the cortical brain and of neuronal synapses. However, we consider it necessary to concentrate on a few fundamental anatomical aspects. A single cell of the cerebral cortex, a pyramidal neurone of the 5th layer, for instance, is literally saturated with synapses connecting it to numerous other neurones close by. The number of such synapses ranges from a few hundreds up to 20,000 or more for each neurone [9], *so that they can be imagined to be densely packed around the soma, the dendrites and in some cases the axon itself*. Schematically:

(1) we are conscious of the fact that quite a few such synapses are surrounded by the projections of other cells which are normally inactive during the transmission of the impulse - the *glial* cells - but such projections usually do not establish a physical contact on the neurone: a *very thin passage* is left in which intercellular fluid can move;

(2) the process known as “spatial addition” of postsynaptic potentials, which reflects the integration of incoming impulses from all the neurones contacting any given neurone, producing the variation of the frequency of the outgoing impulses, lends credit to the hypothesis *of an extreme physical contiguity of all presynaptic buttons terminating on each single neurone*;

(3) it may be recalled how *neighbouring synapses* are characteristic of all local circuits marked by dendro-dendritic connections, such as are found in many different locations along the central nervous system (olfactory bulb, retina, brain stem, thalamus and in the cerebral cortex itself);

(4) in such *local circuits* it often happens that postsynaptic potentials are *not translated* into an outgoing nervous impulse, rather they may directly cause the liberation of neurotransmitters in *nearby sites* not reached by the incoming impulse: the physical contiguity of the synaptic junctions is in this case self-evident; and

(5) we should also mention the acquired results of the experiments by M.R. Rosenzweig et al. [10] showing how synaptic junctions of selected regions of the cerebral cortex exhibit the tendency to expand up to twice their normal size when the animals are subjected to enriched environmental stimuli: this behaviour demonstrates the plasticity of synaptic membranes.

In our hypothesis, each synapse being adjacent and at any rate close to the next, all the single *synaptic fissures* should no longer be considered as separate entities; they could be regarded as merging together in a channel-like structure extended to the entire cortex, which is made up of around 100 billions single neurones. This channel should be pictured as an extremely thin, densely looped labyrinth, joining at a multi-directional level most of the cortical neurones.

We have named such a *virtual* structure USC - *Unified Synaptic Channel*. We use the expression “virtual” since it consists of an anatomical formation that emerges mainly on a functional basis (which will be discussed below); like a *river-bed* which is so called for the presence of the stream of water that flows, or is supposed to flow, along its length.

It is a well-known fact that synapses are 200 Å wide: such free space is filled with a slender lining composed of polysaccharides, glycoproteins and glycolipids. The intersynaptic fissure is crossed by neurotransmitters, among which the most common are GABA (gamma-amino-butirric acid), with an inhibitory role, and glutamate, with an excitatory role; their journey from the presynaptic to the postsynaptic membrane accounts for the transmission and regulation of the nervous impulse across the synaptic space. Once the mediator molecules - from 5,000 to 10,000 of them are released during the exocytosis of a single presynaptic vesicle - have bonded with the appropriate receptors present on the postsynaptic membrane, they are released in the synaptic fissure and are reabsorbed by the presynaptic membrane through a mechanism of micropinocytosis.

Since not all mediator molecules, once released at the presynaptic membrane, manage to bond at the receptors present on the postsynaptic membrane and not all of them are reabsorbed by the presynaptic neurone after having bonded, we gather the impression that in each synaptic transmission event a group of molecules appears to float in the synaptic fissure without any apparent relevant task to perform. In our opinion they should be referred, to a new system of non-synaptic communication between neurones of the cerebral cortex, which in recent years has focused the attention of many neurophysiologists, rather than to the classic type of synaptic transmission so far examined. Such a system does not rely solely upon the action of known neurotransmitters, but also involves other types of hormone-like substances, and particularly two gaseous molecules, NO and CO. These molecules, toxic at higher concentrations, together with the above mentioned unbounded chemical mediators, are seemingly able to enhance or reduce the efficiency of the classic, synaptic type of transmission, which therefore operates embedded in a *pool* of chemically active substances circulating in the synaptic space. Such molecules, if considered by themselves, cannot account for the transmission of any other impulse in any other synapse, due to the fact that they are no longer present in “quantic” concentration [11,12].

Rather, the above mentioned molecules are looked upon by many authors as the effectors of some sort of *low-level noise at the postsynaptic sites*, as the basic informative bricks keeping the postsynaptic membranes under a constant low-level of excitement /inhibition. They express in this way a fine mechanism of regulation of the excitatory postsynaptic potentials of single neurones. On the one hand they build up a

*threshold* that postsynaptic potentials must overcome, through quantic exocytosis, if they are to be transmitted; on the other hand, they modulate the expression of the state of “health” of the synaptic routes, that is to say, they control the quality of the response to incoming impulses.

Many cerebral functions are known to make use of the modulation system we just briefly described. Some of them, such as rage and aggressive reactions, are surely related to behavioural schemes connected to the older regions of the brain (the paleocortex and relative basal ganglia). On the other hand, the mechanisms supporting most learning and memorising processes can be related to the neocortex and to its principal, formidable characteristic: plasticity, and they are being investigated for their modulative properties. In which way may the structure we called USC help us in the definition of the plastic moulding of the *associative areas* on the different, precisely cabled, *sensorial neuronal networks*? Any proposed and proposable model would have to cope with the issue of an extreme, inevitable complexity. In our opinion, the above mentioned multi-directional spatial development of the USC has the advantage of being at the same time intuitively simple and sufficiently complex. The model refers to the totality of the *molecules present in each synaptic fissure at any given instant*, that is to say, both the mediator and the modulating molecules, and sets them in motion along the USC. In more detail: we saw that the molecules can bond with the appropriate receptors present on the postsynaptic membrane; they can also be reabsorbed by the presynaptic membranes; or they could stream, at a very slow pace if compared with the speed of synaptical impulse transmission, along the “ribbon” and thus become connected with nearby, or even far away synapses, where they could instantly get involved in the process of impulse regulation. According to this model the molecules would thus gain an additional informative value; for their presence in the synaptic fissures would become relevant apart from their bonding or reabsorption, since by moving on they would induce concentration changes in other portions of the cortex, thus designing a synchronous map of neuronal activity and inhibition. The process of spatial and temporal addition, now viewed as taking place at a more or less constant rate over the entire cortex, could account in our view for the complexity required by tentative explanations of the plastic powers of the neocortex.

The accepted models for the integration of all the different types of consciousness based on sensory (optical, auditory etc.) or “higher” information (the highly specialised centres of language - themselves probably associated with sensorial memory) are all based on the theory of selective activation of different groups of neurones, mostly arranged in hierarchies. Such theory, in turn, relies upon the deeply rooted belief that all forms of consciousness - even self-consciousness - consist of varying degrees of

perceptive consciousness. On the other hand we are convinced that self-consciousness cannot be put on the same level as the diverse forms of perceptions based upon sensory inputs. It cannot be denied that self-consciousness rests on sensorial perception; here all hierarchical models of neuronal activation are of invaluable help in defining single processes - it is enough to think of the powerful work that has thrown light on the optic system. However we believe that the process - or the result - of self-consciousness could be more clearly hinted at by considering how a constant flow of changing molecular concentrations, along a formation such as the USC, could determine a subtly regulated transmission of all incoming presynaptic impulses, *giving rise to a low-level and synchronous (non hierarchical) activation of all relevant neuronal networks*: the emergence of the awareness of the Self.

### **3 Role of USC in the Interpretation of the Pathogenesis of Coma**

If we consider the USC as a “virtual” space (200Å) that according to local physiopathological conditions becomes more or less open, we can see how the above mentioned process of modulation of synaptic impulses is likely to be reduced or blocked in the following situations:

- (1) physiological loss of consciousness when we go to sleep;
- (2) alteration and/or loss of consciousness by pharmacological induction, that is to say, the general anaesthetic; and
- (3) pathological loss of consciousness in the occurrence of the coma.

Such a new vision helps in the understanding of the coma and of its pathogenesis which have not received in our opinion an adequate theoretical consideration.

Considering that the coma is a symptom and not a diagnosis, we must ask ourselves: why does the patient “sleep” and lose consciousness?

The brain is covered by a rigid, unbending bony surface and consequently any solid or liquid formation compressing it, such as a tumour, an hematoma or an abscess, will cause an increase of intracranial blood pressure, resulting in transudation; an abnormal accumulation of fluid in the intercellular space will follow, and the physiologically harmonious equilibrium of electrochemical connections will be altered.

Eventually, after the progression of the edema which modifies the openness of the USC, the blockage of the flow of mediator and modulating molecules will follow, so that the consciousness is “turned out” and the patient “sleeps”; such is the peace of mind, such is the coma, interpreted as a phenomenon of “asynapsy”.

In simple words, we can picture the physiologically normal brain as a sponge reaching equilibrium between its fluid content and the elasticity of its inner walls. Any variation in pressure leading

the system away from equilibrium will cause the fluid either to move inside or outside of the sponge.

The level of the coma will be more or less deep, prolonged or reversible in relation to the pathology that caused it. Lesions not tearing or devastating should recover, given enough time and specific therapy for the edema to be reabsorbed. In this case, the flow of molecules along the USC starts again, so restoring and promoting the return of consciousness and the “awakening” of the patient.

#### 4 Conclusion

At the conclusion of this work we wish to further emphasise the key-role played by the supposed (by us) continuity of the USC, extending to the entire cerebral cortex: just like the banks of a river contain water, so the USC contains the flow of molecules which in our view defines the emergence of self-consciousness, just like the “river stream” in the old interpretation of William James [13]. We hope to have shown how such a view may help in the specification of the pathogenesis of the coma, with the possibility of loss and restoration of consciousness. An inanimate body, which has been left by the soul, is biologically dead, without hope; on the contrary an unconscious body is alive and can recover the lost consciousness.

#### References

- [1] R.D. Truog and J.C. Fackler, Rethinking brain death, *Critical Care Med.* 20 (1992), pp. 1705-1713.
- [2] D.C. Dennett, *Consciousness Explained* (Little, Brown, 1991).
- [3] G.M. Edelman, *The Remembered Present. A Biological Theory of Consciousness* (Basic Books, NY, 1989).
- [4] J.C. Eccles, *Evolution of the Brain: Creation of the Self* (Routledge, London, 1989).
- [5] C.S. Sherrington, *Man on his Nature* (Cambridge Univ. Press, London, 1951).
- [6] E. Neher and B. Sakmann, The patch clamp technique, *Scientific American* (1992), pp. 45-51.
- [7] J.P. Changeux, *L'Homme Neuronal* (Librairie Arthème Fayard, Paris, 1983).
- [8] M.E. Raichle, Visualizing the mind, *Scientific American* (1994), pp. 36-42.
- [9] F. Crick, *The Astonishing Hypothesis* (Macmillan Publ. Comp., NY, 1994).
- [10] M.R. Rosenzweig, E.L. Bennett, and M.C. Diamond, L'esperienza modifica il cervello, *Le Scienze* (1972), n. 45.
- [11] F. Beck and J.C. Eccles, Quantum aspects of brain activity and the role of consciousness, *Proc. Nat. Acad. Sci.* (1989), pp. 11357-11361.
- [12] H.P. Stapp, *Mind, Matter and Quantum Mechanics* (Springer, Berlin, 1993).
- [13] W. James, *The Principle of Psychology* (Harvard Univ. Press, reprint, 1981).



## INFLUENCE OF CONSCIOUSNESS ON THE COURSE AND THE OUTCOME IN THE THERAPEUTIC PROCESS OF SPEECH/LANGUAGE IMPEDIMENT

Rosana Brakus<sup>1</sup> and Violeta Brakus<sup>2</sup>

<sup>1</sup>The Institute of Experimental Phonetics and Speech Pathology,  
Belgrade, Gospodar Jovanova 35, Yugoslavia

<sup>2</sup>Primary School "Milan Rakić", Vojvodanska 62, Belgrade, Yugoslavia

**Abstract.** We monitored the group of 160 children of chronological age of 2.5 - 11 years with different speech /language pathology (autism, alalia, dysphasia, hearing impairment, stammering, dyslalia, dyslexia and dysgraphia). The aim of the monitoring was to notice possible influences between speech-language impediments and consciousness and their reflexions on the course and the outcome of therapeutic process. Besides diagnostic procedure, children were observed and followed during the therapeutic process. They had the possibility of verbal and non-verbal expression depending on: (a) chronological age; (b) level of speech/language development; and (c) type of speech/language impediment. Results show that there are 4 possible types of influences between speech/language impediments and consciousness: (1) speech/language impediment and consciousness as independent entities; (2) speech/language impediment and consciousness in action; (3) speech/language impediment and consciousness in interaction; and (4) speech/language impediment fixed in consciousness.

**Key words:** *consciousness, speech/language impediments, verbal expression, non-verbal expression, independent entities, action, interaction, fixed therapeutic process*

### 1 Introduction to the Problem

Man became a human being when he raised and started walking, using his hand and speaking.

"Speech is conscious, deliberate dynamism of endless harmonious and rhythmical waves of a sound of different frequencies and intensity which reflect psychophysiological unity of human being during adaptation [1]. No other human activity gives the possibility and such level of penetrating man's personality as speech. Although we mostly speak in order to convey and receive information, speech has different functions which often coincide and permeate each other.

When we speak, we give vent to emotions, satisfy the need to establish relations with other people, to attack somebody, fight or defend, to be different from the others, to acknowledge or prove ourselves. By the magic of speech, we can conquer people or situations, become withdrawn or open to the world.

For a long time, man has been aware of the "power" that speech gives and weakness that follows if it is disabled or impeded.

Speech/language impediments started appearing from the beginning of man's history. With the development of oratory in Greece and Rome, speech pathology was studied as well. Greeks and Romans set some therapeutic models applicable even today. Demostenes, one of the greatest orators of all times, managed to overcome stammering, inventing his own way of treatment. The annals record that he did not hurt himself, although, while giving a speech, he constantly stood under blades of swords (Fig.1)

### 2 The Spiritual Concentration on the Problem



**Figure 1** Demostenes. Attention and capability directed on the word and sword (Dr C.Brajiović and Arh. Z.Longinović)

The directing of consciousness towards thinking and speech, represent outstanding technique in the therapy of stammering. The fact that impeded functioning can be the stimulus and the driving force was proved by L.V. Beethoven, A.S. Suvorov, K.K. Demulen, H. Keller, etc. The feeling or the complex of inferiority which starts developing when a person becomes aware of his/her speech-language impedi-

ment can become the main driving force of the therapeutic process. But, the therapeutic process is a struggle, which, like any struggle, can have two opposite outcomes - victory and defeat [2].

Using available techniques and scientific methodology, this work will discuss the question of the influence of consciousness on the course and the outcome of the therapeutic process of speech-language impediments.

The aim of this work is to notice possible influences between speech/language impediments and consciousness and their reflection on the course and the outcome of the therapeutic process. The aim of the work is to develop therapeutic mechanisms which will induce positive and eliminate negative influences on the line consciousness - speech/language impediment, with the aim of faster and better outcome of the therapeutic process.

### 3 Methodology

During the period 1987-1997, we monitored a group of 160 children (chronological age: 2.5 - 11 yrs) with different speech-language pathology (alalia, autism, dysphasia).

Besides diagnostic procedure (general and differential), the children were observed (in the presence of parents, in a group of other children - with and without speech/language impediments of the same and different chronological age) and monitored during the therapeutic process. They had the ability of verbal (vocals, counting-off and nursery rhymes, unfinished sentences, associations) and non-verbal (drawings; "My family" "draw what you want", "human figure") expression depending on: (a) chronological age, (b) level of speech/language development, and (c) type of speech/language impediment.

Audiolingistic treatment was realized with the aid of KSAFA technical instrumentation.

### 4 Results and Discussion

The results show that there are 4 possible types of influences between speech-language impediments and consciousness:

- (1) speech/language impediment and consciousness as independent entities;
- (2) speech/language impediment and consciousness in action;
- (3) speech/language impediment and consciousness in interaction;
- (4) speech/language impediment fixed in consciousness.

#### 4.1 Speech/Language Impediment and Consciousness as Independent Entities

The speech/language impediment exists but the child did not bring it to consciousness. The child is not

interested in speech and falls into the category of conscious and sound relation "Sound for itself" [3].



Communication with the environment is based on the gesture which is used to satisfy basic physiological needs. These children have reduced instinct for playing, which has a negative influence on development. Disturbed attention interferes with directing and concentrating energy on concrete activities.

This type of influences on the relation speech/language impediment-consciousness, we find in autistic, alalic and disphasic as well as hearing impaired children.

It is very important to bring sound to child's consciousness and develop the wish for communication. By intensive therapy, the child is gradually introduced into the world of sound, speech and verbal communication [4].

#### 4.2 Speech/Language Impediment and Consciousness in Action



Speech/language impediment exists and the child brought it to consciousness on the basis of the reaction of the environment, mostly parents. It is interesting that bringing to consciousness of the speech/language impediment does not have a negative connotation, since the child still does not have negative experiences, for it is over-protected and mostly functions within the family. A child like this can have developed impressive and expressive speech, but his/her communication with the surroundings is poor and limited. This type of influences on the relation speech/language impediment-consciousness we find in alalic, dysphasic and hearing impaired children as well as in children with functional dyslalia and stammering.

It is important that a child like this is included in the therapeutic process as soon as possible and prevents the possibility of fixing the speech-language impediment in consciousness.

#### 4.3 Speech/Language Impediment and Consciousness in Interaction

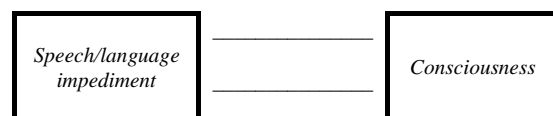

Speech-language impediment and consciousness are in interaction. The child brought the problem to consciousness and started his/her "hidden powers" to

overcome it [5]. The child maximally uses consciousness which is still awake and ready to analyze possible mistake. This is the most important moment and if a child is included in therapy it should be given maximal support and motivation.

This is the type of influences on relation speech-language impediment-consciousness which can be found in almost all types of verbal communication pathology in children and adults.

#### 4.4 Speech/Language Impediment Fixed in Consciousness



Within this relation of influences the child fixed speech/language impediment in consciousness. This relation can be very serious not only because of the causes, but also because of the consequences which are reflected onto socialization of child's personality as well as the whole development.

From the very beginning, reversible psychological changes are manifested by the appearance of high and ebb tide of negative emotions. In children with speech/language impediment-consciousness can be found in almost all types of verbal communication pathology, but it is especially characteristic of and connected with stammering.

It is important to release the pressure on the child's psyche, to remove the instigators of inner discontent (discord of parents, conflicts among children, mocking of the surroundings).

The fact is that the consciousness about the existence of the speech/language impediment problem can either block or start the "system of hidden powers" which act as a unique entirety [6]. Therefore, in certain types of speech/language impediments (hearing impairment, dyslalia, dyslexia and dysgraphia) we can notice the success in therapeutic process if this system is started, while in the case of stammering the success means blocking this system.

The effect of this system in the same speech/language impediment (stammering) can also lead to success or failure within the therapeutic process depending on the child's age.

During the final processing of therapeutic results we analyzed children's drawings: "My family", "Draw what you want" and "Human figure" [7]. The way of drawing, colouring and comments made while they were drawing certain characters, or parts of body, clearly pointed to hidden emotional contents, directing therapeutic course and emphasizing the need of continuous monitoring of this form of non-verbal

expression in children with speech-language impediments.

## 5 Conclusion

The results obtained directed us towards the following conclusions:

(1) All speech/language impediments are susceptible to the influence of consciousness, but certain speech/language impediments are more susceptible to certain influences of consciousness.

(2) Which influence on the relation speech/language impediment-consciousness is going to be realized depends on:

(a) type of speech/language impediment;

(b) reaction of the surroundings;

(c) chronological, speech/language and mental level of the child;

(3) Realized relations between speech/language impediments and consciousness influence the course and the outcome of the therapeutic process of speech/language impediments.

(4) Therapy can influence the speech/language impediment and consciousness, as well as the realized relation within these two entities.

## References

- [1] C. Brajović and Lj. Brajović, *Rehabilitation of Speech Function Impediment* (Naučna knjiga, Beograd, 1981), in Serbian.
- [2] I. Skarić, *Speech Difficulties and Their Elimination* (Mladost, Zagreb, 1988), in Serbo-Croat.
- [3] R. Brakus, The Rolle of Consiousness in Sound Detection in Children With Speech-language Pathology, in Lj. Rakić, D. Raković, Đ. Koruga, and A. Marjanović, eds., *Consciousness: Scientific Challenge of the 21<sup>st</sup> Century*, Proc. ECPD Seminar (Belgrade, 1996), pp. 34-37, in Serbian.
- [4] M. Sovilj, Sound, Hearing and Consciousness, in Lj. Rakić, D. Raković, Đ. Koruga, and A. Marjanović, eds., *Consciousness: Scientific Challenge of the 21<sup>st</sup> Century*, Proc. ECPD Seminar (Belgrade, 1996), pp. 27-33, in Serbian
- [5] P. Čimbur, *"I Defeated Stammering"*, (Mladost, Zagreb, 1988), in Serbo-Croat.
- [6] S. Vladisavljević, *Stammering-logopaedics II*, (Zavod za udžbenike i nastavna sredstva, Beograd, 1982), in Serbian.
- [7] V.M. Axiline, *Play Therapy* (Ballantine Books, New York, 1969)

## PROPOSAL OF THE SELF-ACTUALIZATION LAW: CONSCIOUSNESS VERSUS MANAGEMENT

Jovan Cakić

University of Wisconsin - Oshkosh  
&

Maharishi University of Management - Belgrade, in foundation,  
Živojina Lukića - Vajara 49, 11070 Belgrade, Yugoslavia

*My work is inspired by the teaching of His Holiness  
Maharishi Mahesh Yogi - Leading scientist in domain  
of consciousness, shining star among the brightest  
scientists of all ages. The title "His Holiness"  
should be understood as fully self-actualized.  
His scientific and humane work exceeds the imaginable.*

**Abstract.** The thesis of a New Paradigm, supported by a huge body of research, initiated the formulation of the Self-actualization Law which states: *If the flow of consciousness between the unified field and personal field is higher then the degree of the self-actualization is higher. If the flow (exchange) is frictionless and constant then the self-actualization is complete.* The obvious scarcity of money and other values that cause industry to decline is basically due to a lack of fortune, which means the lack of the support of Nature - lack of support of Natural Law - which shadows alertness, inhibits the flow of creative intelligence, limits innovation from within, and obstructs the nourishing influence from the environment, resulting in a scarcity of all that is helpful for success. The fundamental principle of the science of success is that the full development of one's inner resources provides the foundation for material abundance through skillful use of outer resources. The current system of education lacks the fundamental aspect of self-actualization, the knowledge of pure consciousness and how to experience it. Self-actualized people do exist, they are responsible for all the good in this world and all evolutionary discoveries and advances of humankind. Shall we support it?

**Key words:** *inequality, unified field, quantum physics, Natural Law, transcendental consciousness, Transcendental Meditation, Maharishi Master Management*

### 1 Introduction

Inequality is the dominant experience of our world. For centuries economic issues are a major concern for almost all individuals, households, communities and governments. Contemporary economic growth and decline, wealth and poverty, employment and unemployment, productivity and inefficiency, freedom of choice and inequalities of economic power - are some of the most important reference points by which the welfare of individuals, households, communities and governments are evaluated. Economic issues are

matter of immediate material survival, of life and death in many Third World countries. Global economic institutions and processes have become more powerful than states or social movements intending to regulate economic life in accordance with individual, or community or national political objectives.

A stream of leading intellectuals tends to measure human welfare primarily in material terms such as income and productivity, the second stream gives priority to 'higher' social values, such as equality, justice and environmental protection while the third, currently rising stream, talks of an holistic approach - it combines the above mentioned two approaches and introduces a new variable, consciousness.

The creation and appearance of new economic theories which are accepted in practice is not merely a technical process, it raises many of the most important values (ownership, distribution of wealth, order-power, religion, culture...) about which individuals and governments feel most passionately [1].

It was believed that the concept of wealth and welfare stand at the heart of economics. A country's wealth consists of its stock of resources and welfare refers to the satisfaction that an individual or a society derives from wealth - standard of living. According to Polanyi's theory, economy is the mechanism by which resources are mobilized to satisfy wants. The resources include land, labor and capital. The manner in which they are mobilized is historical variable [2].

The intention of this work is to find the interdependence of the evolution of economics including management and business and the evolution of human consciousness. It will have an immediate application in strategic planning and the further development of management and other business sciences in the 21st century.

## 2 Analysis of Present Situation - Defining the Problem

While humanity shares one planet, it is a planet on which there are two worlds, the world of the rich and the world of the poor. About 23% of the world's people earn 85% of the world's income. In 1990 the richest 20% of the world's population were getting 60 times more income than the poorest 20% [3]. Classical, neoclassical, rational and other modern streams of economic thought did not change these relations significantly.

The crisis between the blocs relaxed and attention is shifted to the growing gap between the North and the South. The development gap poses moral, political, and economic challenges for the relatively wealthy countries of the North while the Third World countries continue to press the North to agree to reforms in the international economic order which might help spur Southern development. Failure to reach agreement on some issues, such as Third World debt, could have far reaching consequences for Northern economies but other issues of great concern are equally important.

These issues are directly connected to the poverty of the Third World: the destruction of the world's rain forests, the illegal immigration, the ozone holes, the arms trade, the drug trade, increase in violence, wars and conflicts over the control of important resources, such as oil and strategic minerals... Most of these problems are directly or indirectly caused by the hidden fight for political, religious and economic power - dominance.

Dependency and Modernization theories did not help much except that we understand that the North is helping a bit the development of the South and that market relations are not free from the exercise of power, so the North can bend the rules of the game in its favor to ensure that the benefits of North-South flow its way disproportionately.

The surface appearance of the freedom of individual exchange vs. the underlying reality of control by the powerful. The problem of order is based on self-interest and power; the sources of power are ideology, politics, economics and the military [1].

The Third World debt crisis illustrates dramatically the politics of asymmetrical interdependence. Third world countries have some benefits from direct foreign investments but the cost to the host country is usually higher. Multi-National Corporations (MNCs) is earning excessive profits in Third World countries but those profits are not reinvested locally. Further, MNCs often overcharge for technology transfer to their own subsidiaries. The widely advertised contribution that foreign aid can make to Southern development is limited; in 1988 it was 1,3% of overall Third World Gross National Product (GNP), or a little less than \$9 for each Southerner and it is many times less than the cost of Northern protectionist measures against Southern exports [4].

According to the World Bank's, World Development Report, 1990 indicated that 20% of the world's population is poor and the huge part of them are hungry and approaching death.

Nevertheless, Cateora predicts the rapid growth of regional free trade areas such as NAFTA, EC, and AFTA which will affect and shape international business in future [5].

Environmental destruction is huge, many species are extinct, many rivers are polluted, food is genetically produced and it has unpredictable consequences for the human race and the living world. In the 1960s the notion of an extended equilibrium began to be formulated, with the neo-classical concept of general equilibrium being expanded to incorporate the natural environment. It describes the ecological limits on economic activity, exhaustible and renewable resource use, pollution and externality and necessity of ecology vs. economy equilibrium [6]. Yet, it is not giving the desired results.

Governments are making efforts, through their institutions, to pacify public and improve the bad situation by stimulating small businesses...; the market is saturated by business books. "How to Do a Successful Business", "Create Your Own Business", "Leadership", "Management", "Marketing", etc. All those books contain good ideas, advice, i.e. how a manager or leader should behave in order to be successful but, from our stand-point (self-actualization), real progress is made by the increased use of personal mental potentials [7].

Karl Marx said that Communism is a society where every body works as much as he can and uses goods and services as much as he needs. Among other conditions, which are necessary for the realization of Communism, *he stressed that the consciousness of the masses must be raised*, but he did not know how to realize it! So, Communism was never achieved since by reading and education they only increased the quantity of information, not the level of consciousness.

This age-old drama of human struggle for survival, possession and wealth is going on. What global changes we might expect for this increasingly tensed business world?

## 3 Towards a New Paradigm

The contradiction between the two greatest economic systems of the world, capitalist and Communist, was not satisfactorily explained, so the need to examine it from another point of view is raised. Into the existing theories and explanations based on quantitative relations of wealth and social relations and influences, I am going to implement a new variable, consciousness. Many physicists think that the final and the most important scientific frontier is consciousness [8].

The same principle that led to changes in the past is in action now; a need of our time has to be fulfilled;

old principles are going to be replaced by more appropriate, more evolutionary more dynamic, more truthful ones.

Philosophers of the Middle Ages and early theoreticians of economics paved the way to modern business and management practices. Nowadays we are witnessing the daily appearance of new research in consciousness proving that the “mystical” experience is not any more mystical, it is now the domain of science; still an old discussion, “what is primary, matter or mind” is still going on. The development of measurement theories and instruments, and new branches of science are proving the reason for its existence. The world population which accepts a new paradigm is increasing; a new stream of scientist is becoming dominant.

From the time of Albert Einstein the attention of physicists has been increasingly on the idea of the unified field. John Hegelin, states ‘since the unified field is the source of all phenomena, it is, logically, source of objective as well as subjective existence [8].

According to Dr. Salk Jonas, “we are at the point of evolution where we are becoming conscious of our consciousness, and conscious of evolution. This evolution is taking place within human mind as a result of metabolized human experience. Metabiological evolution represents survival of wise individuals. Wisdom has become a new criterion of ability to survive” [9].

Soros explains that the rise of consciousness is necessary for good perception of the market, for good prediction, investment and finally success. “...in social events it is the participants’ thinking that is responsible for the element of uncertainty, not the outside observer” [10].

Investment in human resources is subject to increasing returns on an economy wide scale. National development theories are moving from market to human factor orientation. The Human Development Index uses social and economic variables, but the influence of consciousness is not yet included [11].

## 4 The Thesis of a New Paradigm

*“Only a new seed will yield a new crop. Only a new philosophy and new efforts based on new knowledge will fulfill the age-old dream of the wise”.*

*(Maharishi)*

### 4.1 Present (static) characteristics of business life:

- Activity in business is motivated by profit: Looking for external goals, approval from others, material possessions, salary, fighting for higher position;
- Fatigue is proportional to effort: achievement and success were thought to be proportional to effort but competition often proved to be

fatiguing and distressing on the grounds of limited creativity;

- Fulfillment was thought to be based on profit, and experienced only in the accomplishment of the desire; routine work and lack of opportunity for free and full expression of creativity was the seed cause of stress;
- Time pressure and deadlines are an inseparable part of life; during performance awareness is restricted by boundaries; self-image is built up from past experiences;
- Lessons learned from past hurts and failures, fear of change, fear of death;
- Distraction by past and future (worries, regrets, anticipation’s, fantasies);
- Longing for security (never permanently achieved); and
- Selfishness, limited point of view (typical motivation: “What’s in it for me?”).

### 4.2 Future (dynamic) characteristics of business

All the characteristics mentioned below are the product of the natural increase of use of mental potential and process of self-actualization, not behavior on the basis of ethical or intellectual information.

*Personal level:*

- Internal goals (happiness, self-acceptance, creativity, satisfaction that one is doing one’s best at all times); Positive experiences of Being; Detachment from change and turmoil;
- Freedom from time pressure, sense that time is abundant and open-ended;
- Little thought of self-image, action focused on the present moment; and
- Reliance on intuition and leaps of the imagination; Sense of personal immortality; Selflessness, altruism, sense of shared humanity (typical motivation: “Can I help?”).

*Microeconomic level:*

- Economic activities will be motivated by the force of evolution from the level of fulfillment; Profit will be the by-product of fulfillment;
- Achievement and success are proportional to atunement with nature’s Principle of Least Action -how little one can do to accomplish the maximum;
- Achievement and success are inversely proportional to effort;
- Stirring the state of fulfillment brings the fulfillment of desire (Performance from the level of least excitation of consciousness - principle of TM-Siddhis);
- Skillful performance enlivening unbounded awareness at every stroke progressively unfolds and utilizes maximum creativity;

- The rigidity caused by routine work is neutralized by creating infinity, unbounded awareness, twice daily through Transcendental Meditation (TM);
- Action from the level of silent awareness stirs the infinite level of creativity;
- Routine work becomes a means to express full creative potential and max. productivity;
- Competition is revitalizing on the ground of lively creativity and attention is predominately on one's own performance;
- Performance from the level of unbounded awareness brings unlimited achievements of all possible values - material and spiritual;
- Simultaneous fulfillment of the highest interests of both individual and society brings fulfillment to every economic system;
- Fundamentals of Economics and Business: Initiative, Comprehension, Creativity, Vigilance, Foresight, Stability, Adaptability, Purification, Integration, and Growth on four levels-physiological, psychological, sociological, and ecological; and
- Emphasis on the manager learning how to manage himself and utilize the managerial skills of nature for spontaneous perfect management

*Macroeconomic level:*

- The government is the pure and innocent mirror of the nation and the national consciousness is the unseen governor of the government;
- The success of the government is ensured by raising the collective consciousness of the nation through the development of the full potential of consciousness of every individual so the emphasis will be on development of national consciousness, the true governor of all governmental action. Individual consciousness is the unit of national consciousness; and
- Policies formulated are implemented from the level of unbounded awareness, the home of all the laws of nature, bringing fulfillment to every aspect of national life.

When these principles become lively in the conscience of people the shape of micro and macro economic theories will change according to the rise in individual consciousness.

## 5 Thesis Supporting Research

The unified field is described by the supergravity theory of quantum physics as a super-symmetric (perfectly balanced), non-Abelian (self-interacting) field of pure intelligence, which generates the fundamental particles and forces of nature through its infinitely self-referral dynamics at the Planck scale of nature's functioning ( $10^{-33}$  cm or  $10^{-43}$  sec), giving rise to the infinite diversity of the universe. It is striking how the properties of the unified field are precisely the attributes of consciousness. Consciousness alone is

fully self-referral, since only consciousness has the ability to know itself in a completely self-sufficient manner. Moreover, consciousness in its self-referral state, transcendental consciousness, is the source of all mental activity and therefore a field of pure intelligence and infinite creative dynamism. Since the fundamental properties of the unified field are identical to those of consciousness in its self-referral state, it is natural to conclude that the unified field of natural law and the field of pure consciousness are equivalent. Experimental verification of the unified field comes on the level of the direct experience of the unified field in the self-referral state of consciousness [8].

The reason we perceive the world from a classical perspective, in which matter appears solid, is that we do not have access to the deeper levels of reality beyond the obvious sensory level of experience [12].

Maslow, the founder of humanistic psychology, gave the direction to new generations of researchers. His research on self-actualized personalities is still of great significance [13]. Majority of his work is not yet practically applied. I believe that his work may serve as a bridge in the process of applying knowledge of consciousness and self-actualization in daily life: education, business and every significant aspect of life. Below quoted results of modern research are supporting and proving Maslow's findings.

*[Note: Whenever we talk about pure consciousness we think of the highest quality of peak experience which Maslow described as the distinctive feature and experience of genius or self-actualized people. The Experience of Pure Consciousness Found to Be Associated with: High EEG Coherence; Marked Reductions in Respiration Rate, Heart Rate, and Metabolic Rate; Periodic Breath Suspension; absence of Spontaneous Skin Resistance.]*

Supported by an army of brilliant scientists from over the world during the last 40 years Maharishi has inspired more than 500 scientific studies on consciousness at more than 214 independent research institutions in 27 countries [14].

The effects of the rise of conscience on emerging economic theories and their effects on current management and business practices are in high correlation with the following changes proven to be the established effects of the Maharishi Transcendental Meditation program:

*Increased Organizational Ability* (increased: foresight, initiative, practicality and realism, leadership ability, decision-making, time competence, priorities making; decreased: number of situations in life perceived as problems, procrastination; etc.);

*Increased Intelligence and Creativity* (creativity, intelligence, resourcefulness, innovation);

*Optimizing Brain Functioning* (increased: orderliness of.., integration of.., adaptability of.., sensitivity, strength and flexibility of nervous system, blood flow to brain, neurological efficiency-information transfer and spinal reflex, left & right hemisphere functioning-verbal and analytical thinking, synthetic and holistic thinking; Intersubject EEG Coherence: long range effects of the group dynamics of consciousness;

*Correlation* found in subjects practicing the TM and TM-Siddhi program: duration of practice & high EEG coherence, and experiences of higher states of consciousness and superior performance on test measuring perceptual speed, flexibly, creativity, intelligence, field independence, and psycho-motor speed, high EEG coherence, higher states of consciousness, experience of the TM-Siddhis, and high levels of creativity.

*Increased Clarity of Thinking and Perception* (increased mental clarity and wakefulness, learning ability, perceptual acuity, speed & flexibility, vigilance & improved capacity for selective attention; improved: ability to focus attention, concentration, comprehension, memory & its organization, stabilization of organized memory, intellectual performance, problem solving ability, adaptability of mental orientation, efficiency of visual perception & freedom from habitual patterns of perception lower incidence of perceptual illusion)

*Increased Energy and Dynamism* (readiness for activity, alertness, energy and enthusiasm for work, liveliness, vigor, energy and endurance, persistence, physical well-being; growth of a more brave, adventurous, action-oriented nature; decreased: drowsiness, lethargy, fatigue)

*Increased Efficiency* (productivity, ability to accomplish more with less effort, job performance, faster reactions, superior perceptual-motor performance, fewer accident at work)

*Increased Job Satisfaction* (improved relations with co-workers & supervisors, reduced anxiety about promotion, decreased desire to change job)

*State of Deep Rest during TM to neutralize Stress Caused by Routine Work* (decreased: metabolic rate, minute ventilation, respiration rate, hearth rate, spontaneous skin resistance responses; increased: basal skin resistance, muscle relaxation; reduction in biochemical indices of stress - decreased: arterial lactate levels, plasma cortisol levels; EEG indications of a unique state of restful alertness)

*Increased Freedom from Stress* (decreased physiological stress-urinary free cortisone levels, increased autonomic stability, more effective interaction with the environment-stress resistance, maintenance of relaxed style of physiological functioning outside of meditation and during a task)

*Unbounded Awareness - To Neutralize the Boundaries Caused by Routine Work* (experience of pure consciousness during TM, growth of higher states of consciousness)

*Growth of Personal Integration and Fulfillment* (increased self-actualization: integration, unity and wholeness of personality; ability to bring the inner self to healthy expression; greater: commitment to personal growth, inner locus of control, optimism, open-mindedness; greater: flexibility of constructions of reality, self-control, calm in frustrating situations;

increased: inner directedness-independence and self-supportiveness, self-sufficiency, ego strength, autonomy and independence, self-reliance, self-discipline, self-acceptance, self-confidence, self-assuredness, inner calm and tranquillity, contentment, happiness, naturalness, spontaneity, emotional stability, emotional maturity, sensitivity to one's own needs, moral maturity, altruism, time competence - ability to connect past and present meaningfully; less sensitivity to criticism, less tendency to worry about other people's opinions, less need to belong and be accepted; enhanced: self-control, self-concept, self-esteem, self-regard, inner well-being, more balance mood, improved adjustment, decreased behavioural rigidity)

*Reduction in Negative Personality Characteristics* (decreased: anxiety, tension, nervousness, neuroticism, hidden mental turbulence, depression, frustration, irritability, impulsiveness, need for tranquilizers, need for anti-depressants, use of cigarettes, use of alcohol)

*Improved Social Relationships* (greater: sense of social responsibility, respect for the views of others, tolerance of authority, attentiveness to others, marital satisfaction-adjustment, happiness, harmony, intimacy, acceptance of one's spouse, admiration of one's spouse, agreement of conduct and recreation; increased: social maturity, sociability, outgoingness and tendency to participate, ability to appreciate others, ability to co-operate with others, good-naturedness, friendliness and loyalty, trust)

*Growth of Perfect Health* (improved health of the: cardiovascular system, respiratory system, nervous system, endocrine system, immune system-increased resistance to disease, musculo-skeletal system, digestive system; improved general health)

## **5.1 The Proposal: Consciousness Flow & Law of Self-Actualization**

It is proved that the Unified Field (Quantum Physics) is the field of consciousness. The process of symmetry breaking of the Unified Field is responsible for the emergence of energy and matter field which further forms the organic world (human nervous system) [8]. So, individual consciousness is perceived the time - space geometry appeared.

According to quoted research self-actualized people spontaneously live characteristics of unified field of consciousness correlated with the level of actualization. So, the law follows:

*IF the higher exchange flow between the Unified Field and individual field of Consciousness is realized THEN the higher degree of self-actualization is achieved. IF full resistance-free flow between universal and individual field of consciousness (energy, information...) is present constantly, THEN full self-realization is stabilized. Decrease of the exchange flow of consciousness increases life*



problems (health, business etc.) The further implication of this law in business life is drafted in the following example.

## 5.2 Applied Knowledge of Consciousness - Maharishi's Master Management

All areas of management that are generally taught in management institutes in the world are also taught at the Maharishi University of Management with the additional feature of the knowledge of Natural Law<sup>a</sup> - the knowledge and experience of consciousness - to enliven the total creative potential.

Maharishi's Master Management (MMM) maintains the managing intelligence of the manager in alliance with the supreme managing intelligence of the universe, and thereby renders his administration automatic, problem-free, ever-progressive, and ever-evolutionary as the administration of the universe through Natural Law.

At the basis of the Maharishi's Master Management, which has emerged to eliminate the problems of management in the world, are:

- the discovery of the all-encompassing performance of the holistic value of Natural Law in the performance of individual Laws of Nature;
- the discovery of the technology to allaying individual awareness with this level of Nature's Intelligence; and
- the performance of individual, specific values of different Laws of Nature from one single awareness.

As the skill of management has its focal point in the Principle of Least Action<sup>b</sup>, practical knowledge of this level of perfect management must be the basic requirement of training in management [15].

Currently, emotions and psychology of the people are just centered around earning money, and the real content of life: self-sufficiency, freedom, bliss, fulfillment, and progress in peace - was unduly shadowed by the blinding drive for money. *We give primary importance to life and consider money to be of secondary importance.*

## 6 Conclusion

The obvious scarcity of money and other values that cause industry and individual to decline is basically due to a lack of fortune, which means the lack of the support of Nature - Natural Law - which shadows alertness, inhibits the flow of creative intelligence, limits innovation from within, and obstructs the nourishing influence from the

environment, resulting in a scarcity of all that is helpful for success.

The actual training of top level management requires the development of the *habit* to maintain spontaneously the awareness of the total field of management while focusing on any one specific area of management. Purity of life is the basis of success.

"The success of 'great men' comes from their self-referral, unbounded field of intelligence - coherent consciousness (Satva) - and basically not from the means of operation."

The fundamental principle of the science of success is that the full development of one's inner resources provides the foundation for material abundance through skillful use of outer resources; the current system of education lacks the fundamental aspect of self-actualization, the knowledge of pure consciousness and how to experience it.

The proposal for the New Paradigm and the Law of Self-Actualization defines the mechanism and parameters of self-actualization. Self-actualized people do exist, they are responsible for all the good in this world, all evolutionary discoveries and all world-saving humanitarian ideas. Self-actualized people do not care about terminology (capitalist, communist etc.) by their nature, they always do the best - evolutionary action that is good for everyone.

Macroeconomics/microeconomics level economic events are guided and controlled by collective and individual consciousness. The self-actualized individuals are only people who are able to reorganize and raise the national economy, science, art and culture and all other aspects of social and personal life to fit expectations of 21st century.

## References

- [1] J.R. Holton, *Economy and Society* (Routledge, London, 1992), Ch. 1.
- [2] P. Hardwick, *An Introduction to Modern Economics* (Longman Publishing, New York, 1994), Ch.7.
- [3] M. Todaro, *Economic Development* (Longman, New York, 1994), pp. 135-167.
- [4] T. Larison and D. Skidmore, *International Political Economy* (Braca Jovanovic, New York, 1992), pp. 249-253.
- [5] P. Cateora, *International Marketing* (Irwin, Chicago, 1996), Ch. 1.
- [6] D. Greenaway, *A Guide to Modern Economics* (Routledge, London, 1996), pp. 45-80.
- [7] P. Drucker, *Management for the Future* (Truman Talley Books, New York, 1992).
- [8] J. Hegelin, *Is the Unified Field a field of Consciousness?* (MIU Press, U.S.A., 1983).
- [9] D. Chopra, *Creating Health* (Bantam Books, New York, 1983), Ch.4.

<sup>a</sup> Natural Law is that irresistible power of life that makes everything always evolutionary. Enlivenment of the infinite organizing power of Natural Law within the individual means that the inner intelligence of the body is fulfill awake to spontaneously function in full alliance with the intelligence of the physiology of the whole universe.

<sup>b</sup> Natural Law functions through the Principle of Least Action - accomplish maximum with minimum effort.

- [10] G. Soros, *The Alchemy of Finance* (John Wiley & Sons, New York, 1994).
- [11] Lj. Zjalic, *Human Factor and Development* (BMG, Belgrade, 1997), in Serbian.
- [12] R.K. Wallace, *The Physiology of Consciousness* (MIU press, U.S.A., 1993).
- [13] A. Maslow, *Motivation and Personality* (Harper & Row, New York, 1976).
- [14] *Scientific Research on Maharishi's Transcendental Meditation and TM-Siddhi Programme: Collected Pares*, Vols. 1-6 (Maharishi Vedic Univ. Press, Holland).
- [15] M. Mahesh - Yogi, *Maharishi University of Management* (MUM, Holland, 1996).

## THE CHANGES IN PURKINJE CELL ACTIVITY FOLLOWING INFERIOR OLIVE STIMULATION

Milka Čulić<sup>1</sup>, Jasna Šaponjić<sup>1</sup>, Bogdan Janković<sup>2</sup>, and Milena Janković<sup>1</sup>

<sup>1</sup>Institute for Biological Research, University of Belgrade, Yugoslavia

<sup>2</sup>Center for Multidisciplinary Studies, University of Belgrade, Yugoslavia,

E-mail: eculic @ ubbg.etf.bg.ac.yu

**Abstract.** Synaptic plasticity in cerebellum occurs when two distinct excitatory inputs on each Purkinje cell, one from parallel fibers and the other from climbing fibre originating in inferior olive (IO), are conjunctively activated. The aim of our study was to investigate the effect of intensifying the climbing fibre input on discharge pattern of Purkinje cells. The experiments were performed on adult Wistar male rats under nembutal anesthesia. There was a significant increase in the total number in 64 s of complex spikes 10 s after short lasting electrical stimulation of inferior olive. The decrease of total number in 64 s of simplex spikes occurred not immediately after cessation of inferior olive stimulation, but after 10 min. We may conclude that the climbing fiber suppression of parallel fiber excitation of Purkinje cell is important in reflecting olivocerebellar influences on electrocorticogram in various pathophysiological brain states and consequently on motor and other types of behaviour.

**Key words:** Purkinje cell, inferior olive, complex spikes, simple spikes.

### 1 Introduction

Interpreting the cerebellar contribution to motor, sensory, cognitive and autonomic functions requires more refined experimental studies [1,2]. The typical circuitry of the cerebellum and the organization of cerebellar afferent and efferent systems differentially result in the behavioral consequences of processing in various cerebellar regions [3]. Classical studies well established [4-7] the particular importance of two major afferent systems terminating as climbing fibers and mossy fibers in cerebellum, which excite its Purkinje cells. The climbing fibers originate from a single anatomical source, the inferior olive, carry low frequency input directly to individual Purkinje cells which generate low frequency complex spikes. On the other hand, the mossy fibers originate from multiple sources in the brain stem and spinal cord, synapse with the granule cells whose parallel fibers make synaptic excitatory contacts with many Purkinje cells which generate simple spikes of high frequency. Conjunctive activation of climbing fiber and parallel fiber synapses lead to a reduced strength of the parallel fiber-Purkinje cell synapse, a process called long - term depression [8]. The climbing fiber input activates dendritic and somatic calcium channels, leading to calcium influx, which induces long - term

depression of the activated parallel synapses [9]. Besides this one, there are two other forms of cerebellar long - term depression: the first - induced by strong parallel fiber input that largely occludes the process induced by coactivation of climbing and parallel fiber input [10] and the second is nitric oxide - dependent [11]. The long - term depression of parallel fiber synapse complemented by potentiation of inhibitory synapses on Purkinje cells [12] may be important in normalizing the total excitatory input onto a single Purkinje cell. The Purkinje cell synaptic plasticity and the modulatory effects of olivocerebellar influence on different brain functions are not completely elucidated.

The aim of this study was to investigate the pattern of complex, simplex spike and overall activity of Purkinje cells in time domain after potentiation of climbing fiber input by electrical stimulation of inferior olive. The preliminary account of this study already appeared [13].

### 2 Materials and Methods

Experiments were performed on adult Wistar male rats. The operative procedure was undertaken while an experimental animal was in deep anesthesia (nembutal- Sigma, 40 mg/kg, i.p) and stereotaxically fixed. Besides craniotomy over sensorimotor cerebral cortex for inserting the electrodes for recording the electrocorticogram (described and analyzed elsewhere [14], the small craniotomy over vermal cortex of anterior cerebellum was performed under a warm saline drip and 4% agar was placed over the exposed surface of cerebellum. The lidocaine (2%) infiltration of all wound edges was carefully done. The body temperature was maintained under physiological limits. The bipolar stimulating electrode was inserted in the inferior olive [15], with coordinates according to bregma: P:12.5; L:0.8; H:-10.8, contralateral to the location of the recording site in the cerebellar cortex. Unitary extracellular recording of Purkinje cells was performed with glass microelectrodes filled with 0.9 % NaCl (2-5 MΩ). Following the identification of a Purkinje cell by noticing the presence of complex spikes [4] in its spontaneous activity, the unitary

events were recorded (for at least 64 s) before and 10 s, 5 min and 10 min after inferior olive stimulation (15 s trains of 2 ms pulses at 3 V and 2 Hz). When the experimental conditions were sufficiently stable (in majority of cases), the testing of each cell to inferior olive stimulation was repeated several times and if the responses were in accordance, one sequence in time domain was a representative for a certain Purkinje cell. Simplex and complex spikes of each cell were amplified, filtered, digitally converted and analyzed by a special program package on personal computer. The total number in 64 s and the frequency of complex spikes, the total number and discharge rate of simplex spikes as well as the total number and mean overall (complex and simplex) discharge frequency for each cell was evaluated before and 10 s, 5 min and 10 min after inferior olive stimulation. The total number of spikes in certain period of time was a more valid parameter and was used for Analysis of variance-single factor and Paired Student's t - test in statistic evaluations. The serial frontal sections of the fixed brain stem were cut at 25  $\mu$ m and conventionally stained in order to define the proper position of the stimulating electrode.

### 3 Results

The mean simple spike frequency in spontaneous activity of 12 Purkinje cells before testing to inferior olive stimulation ranged between 2.03 + 2.17 imp/s and 104.68 + 16.5 imp/s. The frequency range of Purkinje cell complex spikes (before inferior olive stimulation) was from 0.06 imp/s up to 1.05 imp/s. Long lasting changes in discharge pattern of Purkinje cells after short lasting stimulation of inferior olive were characterized by the increase of complex spike activity and the decrease of simple spike activities with peculiar timing. The inferior olive stimulation evoked the significant enhancement of the total number of complex spikes in the period from 10 s up to 74 s after cessation of stimulation ( $p < 0.05$ ), but later on (5 min and 10 min after stimulation) the changes were insignificant as shown in Fig. 1.

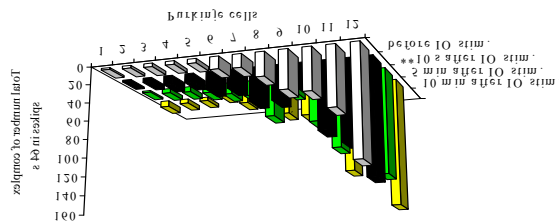

**Figure 1.** The effect of inferior olive stimulation on the total number in 64 s of Purkinje cell complex spikes (\*\*  $p < 0.05$ ).

However, decrease of the total number of simplex spikes of investigated Purkinje cells was not significant 10 s, and 5 min after inferior olive stimulation, there was a significant decrease ( $p < 0.05$ ) 10 min after stimulation as shown in Fig.2. The changes in the number of overall spike rates of these Purkinje cells mostly resembled the changes in simple

spike activity, only the decrease in the overall spike discharge rate 10 min after inferior olive stimulation was significant at the level  $p = 0.05$ .

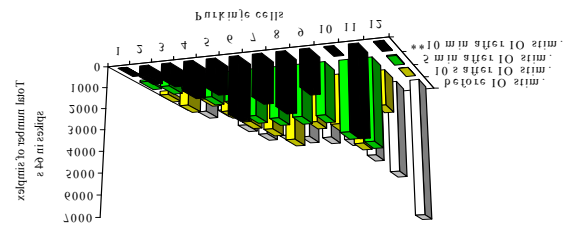

**Figure 2.** The effect of inferior olive stimulation on the total number in 64 s of Purkinje cell simplex spikes (\*\*  $p < 0.05$ ).

### 4 Discussion and Conclusions

A reduction of simple spike activity following spontaneous climbing fiber inputs was shown to be present in Purkinje cells [16,17] although a rebound in the simple spike activity following the inactivation period was confirmed by other authors [18]. The excitability changes in Purkinje cells following a spontaneous complex spike were independent of the tonic simple spike activity of the Purkinje cell [19]. The simple spike activity following the spontaneously occurring responses were compared with the activity following climbing fiber events evoked by stimulating the inferior olive [19] and the simple spike activity was significantly reduced by electrically activating the climbing fiber input. This effect was independent of the type of spontaneous simple spike firing frequency following the inactivation period. Our results appear to be in favour of these findings although the experimental design, the time course and data resolution are not the same. A potentiation of olivary neuronal activity induced by systemic administration of harmaline was also reflected in the increased rhythmicity and frequency of complex spike activity within 3 min of drug injection from 1 spike/s to 5 spikes/s, while simple spike activity of vermal and paravermal Purkinje cell were completely suppressed; the duration of these effects varied between 30 and 180 min [20]. Moreover, in climbing fiber deafferented cerebella of adult rats by parenteral administration of 3-acetylpyridine, the complex spikes of Purkinje cells were no longer present and the firing simple spike rate was significantly greater [21]. Recent observations with the use of multiple simultaneous recordings from Purkinje cells demonstrated bilateral synchrony in rat cerebellar cortex which seemed contradictory to the anatomical findings [22]. Whatever the complicated base of Purkinje cell responses to climbing and mossy fiber inputs, the study on the effect of intensifying the climbing fiber input on electrocorticogram (ECoG) showed an increase of the mean ECoG power spectra which appeared at the same time with the significant

increase of the Purkinje cell complex spikes, but lasted much longer [14].

We may conclude that the climbing fiber suppression of parallel fiber excitation of Purkinje cell is important in reflecting olivocerebellar influences on electrocorticogram in various pathophysiological brain states and consequently on motor and other types of behaviour [14,23].

**Acknowledgments.** This work was financed by Serbian Ministry of Science and Technology. The authors are also indebted to Dr A. Kalauzi for engagement in computer programming.

## References

- [1] H.C. Leiner, A. L. Lainer, and R.S. Dow, The underestimated cerebellum, *Hum. Brain Mapp.* 2 (1995), pp. 244-254.
- [2] E.De Schutter, Cerebellar long-term depression might normalize excitation of Purkinje cells: a hypothesis, *TINS* 18 (1995), pp. 291-295.
- [3] J.R. Bloedel, Functional heterogeneity with structural homogeneity: How does the cerebellum operate?, *Behav. Brain Sci.* 15 (1992), pp. 666-678.
- [4] J.C. Eccles, M. Ito, and J. Szentagothai, *The cerebellum as a Neuronal Machine* (Springer-Verlag, Berlin 1967).
- [5] D.M. Armstrong, Functional significance of connections of the inferior olive, *Physiol. Rev.* 54 (1974), pp. 358-417.
- [6] M. Ito, *The Cerebellum and Neural Control* (Raven Press, New York 1984).
- [7] K. Sasaki, J.M. Bower, and R.R. Llinas, Multiple Purkinje cell recording in rodent cerebellar cortex. *Eur. J. Neurosci.* (1989), pp. 572-586.
- [8] D.J. Linden and J.A. Connor, Long-term synaptic depression, *Annu. Rev. Neurosci.* 18 (1995), pp. 319-357.
- [9] H. Miyakawa, V. Lev-Ram, N. Lasser-Ross, and W.N. Ross, Calcium transients evoked by climbing fiber synaptic inputs in guinea pig cerebellar Purkinje neurons, *J. Neurophysiol.* 68 (1992), pp. 1178-1189.
- [10] N.A. Hartell, Strong activation of parallel fibers produces localized calcium transients and a form of LTD that spreads to distant synapses, *Neuron* 16 (1996), pp. 601-610.
- [11] S.R. Vincent, Nitric oxide and synaptic plasticity: no news from the cerebellum, *Behav. Brain Sci.* 19 (1996), pp. 362-367.
- [12] M. Kano, Long-lasting potentiation of GABAergic inhibitory synaptic transmission in cerebellar Purkinje cells: its properties and possible mechanisms, *Behav. Brain Sci.* 19 (1996), pp. 354-361.
- [13] J. Šaponjić, M. Čulić, M. Janković, G. Kartelija, S. Popović, B. Janković, and A. Kalauzi, Uticaj stimulacije donjeg maslinastog jedra na pra'njenje Purkinjeovih ćelija malog mozga pacova. *VI Yugoslav. Symp. Cl. Neurophysiol.* (Herceg Novi, 1997), p. 24.
- [14] M. Čulić, J. Šaponjić, B. Janković, and M. Janković, Olivocerebellar influence on electrocorticogram in rats, *Symp. "Brain and Movement"* (St. Petresburg – Moscow, 1997), p. 79.
- [15] G. Paxinos and C. Watson, *The Rat Brain in Stereotaxic Coordinates* (Academic Press, Sydney, 1982).
- [16] J.R. Bloedel and W.J. Roberts, Action of climbing fibers in the cerebellar cortex of the cat, *J. Neurophysiol.* 34 (1971), pp. 17-31.
- [17] A. Latham and D.H. Paul, Spontaneous activity of cerebellar Purkinje cells and their responses to impulses in climbing fibers, *J. Physiol. (Lond.)* 213 (1971), pp. 135-156.
- [18] F.J. Rubia and H. Hennemann, Discharge patterns of Purkinje cells activated through the climbing fiber system by stimulation of somatic and visceral afferents. *Pflugers Arch.* 375 (1978), pp. 125-129.
- [19] C.J. McDevitt, T.J. Ebner, and J.R. Bloedel, The changes in Purkinje cell simple spike activity following spontaneous climbing fiber inputs, *Brain Res.* 237 (1982), pp. 484-491.
- [20] S.E. Stratton, J.F. Lorden, L.E. Mays, and G.A. Oltmans, Spontaneous and harmaline-stimulated Purkinje cell activity in rats with a genetic movement disorder, *J. Neurosci.* 8 (1988), pp. 3327-3336.
- [21] R. Vigot, J.M. Billard, and C. Batini, Reduction of GABA inhibition in Purkinje and cerebellar nuclei neurons in climbing fibre deafferented cerebella of rat, *Neurosci. Res.* 17 (1993), pp. 249-255.
- [22] C.I. De Zeeuw, E.J. Lang, I. Sugihara, T.J. Ruigrok, L.M. Eisenman, E. Mugnaini, and R. Llinas, Morphological correlates of bilateral synchrony in the rat cerebellar cortex, *J. Neurosci.* 16 (1996), pp. 3412-3426.
- [23] M. Čulić, J. Šaponjić, B. Janković, M. Janković, S. Popović, and I. Milenković, Effects of kainic acid lesions of cerebellar cortex or inferior olive in the rat acute model of epilepsy, G.N. Gantchev, V.S. Gurfinkel, D. Stuart, M. Wiesendanger, and S. Mori, eds., *Motor Control VIII* (Academic Publishing House, Sofia, 1996), pp. 101-104.

# FUNCTIONAL ORGANIZATION OF SOMATOSENSORY TRANSMISSION IN DIFFERENT MODIFICATIONS OF HUMAN BRAIN REACTIVITY

Elena V. Damianovitch and Tatjana V. Orlova

Lab. of Neurocybernetics, Brain Research Institute, Russian Academy of Medical Sciences,  
Per. Obucha 5, 103064 Moscow, Russia

**Abstract.** Simultaneously recorded cortical (from hand-sensory areas contralateral and ipsilateral to stimulation) and dorsal column nuclei (DCN) median nerve somatosensory evoked potentials (SEPs) in human subjects with different brain reactivity modifications were compared with those in controls (26 healthy volunteers) in order to assess organization of somatosensory transmission in these conditions. Functional modification of brain reactivity and consciousness during transcendental meditation caused parallel statistically significant (from  $p < 0.05$  to  $p < 0.01$ ) increase in the amplitude of early cortical and DCN SEPs components without changes in their peak latencies. Common reorganization of brain activity in patients with afferent pathways lesions on different levels from upper brain stem to forebrain without cortical, thalamic or DCN lesions after acute stroke were expressed in different SEPs abnormalities. Statistically significant increase in the amplitude of early SEPs components in intact hemisphere after contralateral median nerve stimulation was observed in all patients. In damaged hemisphere 8 of them demonstrated SEPs abnormalities caused by afferent pathways lesions (an increase in peak latencies of some components, absence of early SEPs or their significant reduction), while in 4 other patients statistically significant increase in the amplitude of several components was combined with significant reduction of others. No changes were observed in patients' DCN SEPs amplitude. Common effect of cortical early SEPs amplitude enhancement can be explained by different mechanisms such as blockade of lateral interhemispheric inhibition and the local increase in the excitability of cortical neurons in patients or functional changes in the existent symmetrical and asymmetrical cortical inhibitory influences to the relay structures of brain stem in meditators.

**Key words:** *somatosensory evoked potentials; median nerve; cortex; dorsal column nuclei; brain reactivity modifications; somatosensory afferent pathways lesions.*

## 1 Introduction

This investigation was performed to estimate functional organization of somatosensory conduction in human subjects in modified brain reactivity conditions through an analysis of simultaneously recorded cortical and dorsal column nuclei (DCN) median nerve somatosensory evoked potentials (SEPs) changes. From the great number of states resulting in brain reactivity modification we chose two for our present study. First of them was transcendental

meditation (TM) - the specific technique, caused functional modification of brain reactivity and consciousness. This technique is also characterised by functional mobilisation of the brain hidden reserves [1] and is used in complex treatment of various neurologic diseases in some clinics. The second one was restorative stage of acute stroke, as one of brain destructive processes. Compensation of sensorimotor deficit after acute stroke is also due to the brain reserves mobilisation. That is why we paid our attention to these two states.

## 2 Subjects and Methods

This investigation was performed on 3 groups of subjects. The first one (control) consisted of 26 healthy volunteers, 11 men and 15 women, aged 39 - 62 years. 16 healthy volunteers, 5 men and 11 women, aged 42 - 59 years, who had been practising the TM technique for two years, formed the second group. In this group SEPs were recorded before and during TM (5 minutes after beginning the practice). TM was practiced for 20 minutes in total. 12 patients, 5 men and 7 women, aged 45 - 63 years, with hemiplegia and sensory deficit as a result of acute stroke, lasting from 8 months to 2 years before the electrophysiological study, were included in the third group. The clinical diagnosis was confirmed by CT scan in all cases. All patients had somatosensory afferent pathways lesions on different levels from upper brain stem to the forebrain and no cortical, thalamic or DCN lesions.

Cortical and DCN SEPs were evoked by transcutaneous stimulation of median nerve in the wrist by 0,1 msec square wave electrical pulses with intensity just above the thumb muscle twitch threshold and a rate of 1 stimulus per 1-2 sec with random intervals. Recordings of cortical SEPs were made by surface electrodes from the scalp somatosensory hand areas (C3' and C4'; 2 cm behind vertex and 7 cm from the midline) contralateral and ipsilateral to the stimulation with a reference, placed 6 cm anteriorly. DCN SEPs were recorded by surface electrodes from the second cervical vertebra (Cv2) with a reference at the shoulder, contralateral to the stimulated median nerve. 128 responses were averaged for cortical and

256 - for DCN SEPs. All subjects sat relaxed in comfortable conditions in dentist's chair with closed eyes in dark soundproof room. SEPs were recorded by using the Nihon Kohden electrophysiologic system (Japan), including a high gain amplifier AVH-10, averager DAT-1100, dual-beam oscilloscope VC-10, continuous recording oscilloscope camera RLG-6021, electronic stimulator SEN-7103. The amplifire bandpass was from 1.5 to 1000 Hz. The analysis time was 200 msec. The data obtained were statistically evaluated by Student's t test.  $P < 0.05$  was considered to be significant.

### 3 Results

All SEPs recorded in the first control group were the same as described in literature. We only want to notice that in 16 subjects were registered 2 components (P24 and P41) (Fig. 1a) and in 10 subjects - 3 components (P21, P35 and P48) (Fig 1b) in early positive complex of cortical SEPs when contralateral median nerve was stimulated, which also did not contradict literature [2,3].

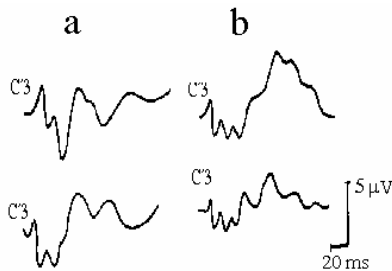

**Figure 1** Averaged contralateral hemisphere cortex SEPs in response to the transcutaneous electrical median nerve stimulation in 4 healthy subjects: (a) two components splintering of the positive complex; and (b) three components splintering of the positive complex.

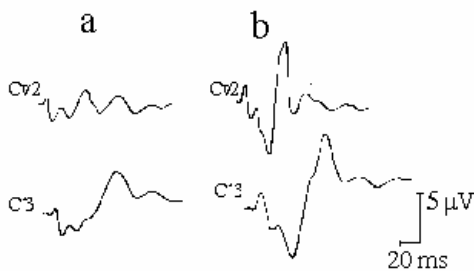

**Figure 2** Contralateral hemisphere cortex (C3') and DCN (Cv2) averaged SEPs in response to the transcutaneous electrical median nerve stimulation in one healthy volunteer, who had been practising the TM technique for two years: (a) before TM; and (b) 5 minutes after beginning TM

In the second experimental group (healthy mediators) cortical and DCN SEPs, recorded before TM were identical to those in control group. Their changes during meditation manifested in parallel statistically significant increase in the amplitude of early cortical and DCN components from 1.6 to 1.7

times (Fig. 2, Table 1), while their peak latencies were the same as before TM. These changes were not identical in different subjects. In 2 of them the amplitude increase was not significant.

**Table 1** Early SePs component amplitude before and during TM

Component	before TM	during TM
DCN		
N13	2.14 ± 0.25	3.84 ± 0.38***
P18	2.29 ± 0.24	3.74 ± 0.3***
P28	2.98 ± 0.3	5.1 ± 0.4 ***
N57	5.13 ± 0.36	8.56 ± 0.57***
Cortex		
N19	1.62 ± 0.17	2.73 ± 0.31***
P25	3.2 ± 0.44	4.3 ± 0.44
P41	4.33 ± 0.38	6.59 ± 0.49***
P24	2.93 ± 0.6	4.4 ± 0.55
P35	4.53 ± 0.45	6.26 ± 0.42
N48	2.93 ± 0.39	4.26 ± 0.34
N75	5.0 ± 0.36	8.08 ± 0.48

$p < 0.05^*$ ,  $p < 0.02^{**}$ ,  $p < 0.01^{***}$

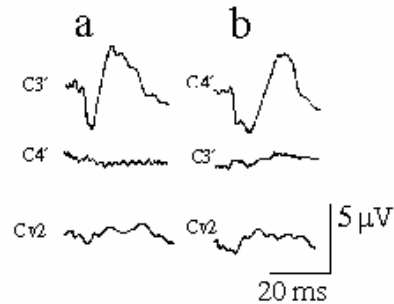

**Figure 3** Cortical (C3' and C4') and DCN (Cv2) SEPs of patient endured acute stroke 2 years before the study with the right forebrain white matter lesion in response to the transcutaneous electrical stimulation of right (a) and left (b) median nerve.

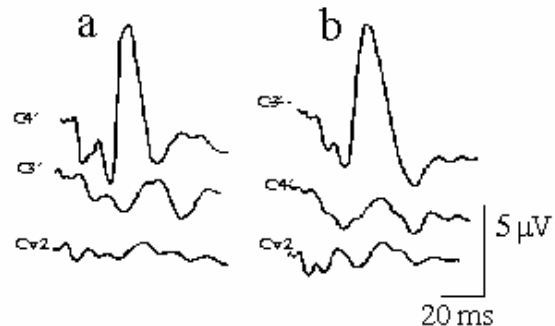

**Figure 4** Cortical (C4' and C3') and DCN (Cv2) SEPs of patient endured acute stroke 1.5 years before the study with brain stem and the left forebrain white matter lesion in response to the transcutaneous electrical stimulation of left (a) and right (b) median nerve.

The results, obtained in the third group (patients) showed statistically significant increase in the amplitude of cortical early SEPs components in intact hemisphere (Fig. 3a, trace C3'; Fig. 4a, trace C4'; Table 2) after contralateral median nerve stimulation in all patients. In damaged hemisphere 8 patients showed SEPs abnormalities caused by somatosensory

afferent pathways lesions (an increase in peak latencies of some components (Fig. 3b, trace C4'); absence of early SEPs or their significant reduction) when contralateral median nerve was stimulated. In other 4 patients we observed statistically significant increase in the amplitude of early cortical SEPs components (Fig. 4b, trace C3'; Table 2) and significant reduction of others in damaged hemisphere after contralateral median nerve stimulation. On the other hand, in no patients changes in the DCN SEPs amplitude were observed (Figs. 3, 4, traces Cv2).

**Table 2** An increase in the amplitude ( $\mu\text{V}$ ) of early cortical SEPs after contralateral median nerve stimulation in patients endured acute stroke (group 3) in comparison with controls (group 1).

component	group 1	group 3
intact hemisphere		
N19	1,6 +- 0,14	3,1 +- 0,27*
P24	3,1 +- 0,37	6,1 +- 0,49*
P41	4,3 +- 0,34	9,1 +- 1,2***
P21	3,1 +- 0,4	5,8 +- 0,59*
P35	4,5 +- 0,42	6,0 +- 0,47
P48	3,1 +- 0,28	7,5 +- 1,18***
N75	4,7 +- 0,26	9,5 +- 1,79***
damaged hemisphere		
P24	3,1 +- 0,37	7,0 +- 1,18*
P41	4,3 +- 0,34	7,7 +- 0,41***
N75	4,7 +- 0,26	9,1 +- 1,71**

$p < 0,05^*$ ,  $p < 0,02^{**}$ ,  $p < 0,01^{***}$

## 4 Discussion

Our previous animal studies indicated that hemisection of the midbrain tegmentum, containing the descending inhibitory pathways to the different structures of the back part of brain stem and spinal cord, caused increase in time and amplitude characteristics of first (N) and second (P) components of the DCN evoked responses to foreleg stimulation in chronic experiment [4]. This phenomenon seems to be due to the activation of different inhibitory elements in these structures in the vicinity of the appropriate lemniscal system relay cells. We think these results indicate at least two different influences. One of them causes the increase of P-component of the DCN evoked potentials by activating presynaptic inhibition. This phenomenon reflects activation of DCN spinal cord terminal relay (lemniscal) cells and resultant depolarization of these terminals. Other influences, reaching these structures in parallel, activate the inhibitory neuron controlling the neuron directly organizing postsynaptic inhibition of the relay cell. It therefore causes the so-called "inhibition of inhibition", decreasing postsynaptic inhibition and thereby increasing the first DCN response component. These animal studies have shown cerebral control of brain stem ascending somatosensory pathways and influences.

Investigations of the neuronal mechanisms of TM [5] showed contrasting functional changes in forebrain

and spinal cord structures during TM. An increase of spectral power of electrical activity in alpha- and theta-frequency ranges takes place in parietal and somatosensory forebrain structures, which reflects an increased activation of these structures. Wider distribution of some early SEPs components can also be observed during TM [1]. Simultaneously, muscle relaxation takes place as a result of increased inhibitory influences to the spinal cord inhibitory mechanisms from the motor cortex and nucleus caudatus. We also observed increases in the amplitudes of early cortical and DCN SEPs components during TM. Comparing our data with the literature and analysing their functional significance, we can conclude that a functional mobilization of a whole spectrum of cerebral descending coordinating influences to the back parts of brain stem and the spinal cord takes place during TM. This effect is not identical for the different afferent and motor cerebral structures. A highly selective activation of different DCN inhibitory elements, followed by changes in the balance of presynaptic and postsynaptic inhibition, causes wider distribution only of some cortical SEPs components (N21, P40, N59). Activation of structures playing the central role in intellectual activity, particularly parietal and frontal cortex, takes place as a result of this highly selective process. In the spinal cord structures activation of inhibitory elements during TM is followed by inhibition of motoneurons with consequent muscle relaxation [6]. Functional reorganization of cortical and DCN inhibitory interactions resulted in somatosensory afferent conduction facilitation in modified consciousness conditions during TM.

Early SEPs abnormalities in patients with somatosensory afferent pathways distractions after acute stroke reflect functional changes in central nervous system (CNS), characterized by common reorganization of brain activity. That is why besides SEPs abnormalities caused by somatosensory afferent pathways lesions our patients demonstrated an increase in the amplitude of several cortical early SEPs components due to facilitation of afferent transmission, as a result of compensatory processes in CNS, while their DCN SEPs did not change. An increase in the amplitude of early cortical SEPs without subcortical SEPs amplitude changes in different situations were described by some authors [7-9]. An increase in the amplitude of several SEPs components with reduction of others in damaged hemisphere was also shown in other neurologic pathology [10]. As no changes were observed in the DCN evoked responses amplitude, the descending inhibitory pathways in our patients were not damaged. Therefore an increase in the amplitude of cortical SEPs in this group can be explained by other mechanisms such as blockade of lateral interhemispheric inhibition and local increase in the excitability of cortical neurons.



Although different mechanisms underlay an increase in the amplitude of cortical SEPs in-patients and meditators, the common effect, which reflected facilitation of somatosensory transmission, was obtained in these two groups.

## References

- [1] N.N. Lyubimov, S. Rasmussen, and R.K. Wallace, *Vosstanovitel'naya nevrologiya* 2 (1992), pp. 100-101, in Russian.
- [2] J.A. Debecker and J.E. Desmedt, Les potentiels evoques cerebraux et les potentiels de nert sensible chez l'home, *Acta Neurol. Belg.* 64, (1980), pp. 1212-1248.
- [3] J.E. Desmedt, Somatosensory cerebral evoked potentials in man, in *Handbook of EEG and Clinical Neurophysiology* (Elsevier, Amsterdam, 1971), Vol. 9, pp. 55-82.
- [4] T.V. Orlova, and E.E. Grechkina, *Bull. Exper. Biol. Med.* 9 (1985), pp. 346-349.
- [5] R.K. Wallace, *The Maharishi Technology of the Unified Field: The Neurophysiology of Enlightenment* (Farfield, Iowa, 1987).
- [6] E.V. Petrenko, T.V. Orlova, and N.N. Lyubimov, Cerebral control of afferent somatosensory projections, *Bull. Exper. Biol. Med.* 9 (1993), pp. 229-231.
- [7] J.E. Desmedt and G.Cheron, Central somatosensory conduction in man: Neural generators and interpeak latencies of far-field components recorded from neck and right or left scalp and earlobes, *EEG Clin. Neurophysiol.* 50 (1980), pp. 382-403.
- [8] J.C. Rothwell, J.A. Obeso, and C.D. Marsden, Electrophysiology of somatosensory reflex myoclonus, *Adv. Neurol.* 43 (1986), pp. 385-398.
- [9] M. Seyal, J.K. Browne, K. Masuoka, and A.J. Gabor, Enhancement of the amplitude of the somatosensory evoked potentials following magnetic pulse stimulation of the human brain, *EEG Clin. Neurophysiol.* 88 (1993), pp. 20-27.
- [10] F. Maugiere, J.E.Desmedt, and J. Courjon, Astereognosis and dissociated loss of frontal or parietal components of somatosensory evoked potentials in hemispheric lesions, *Brain* 106, (1983), pp. 271-311.

## ENERGY ASPECT OF CONSCIOUSNESS LAYERS

Nenad Delić<sup>1</sup>, Jovan Šetrajčić<sup>1</sup>, Aleksandar Utješanović<sup>1</sup>, Vojkan Zorić<sup>1</sup>,  
D. Mirjanić<sup>2</sup> and S. Jaćimovski<sup>3</sup>

<sup>1</sup>Institute of Physics, Faculty of Science, University of Novi Sad, Yugoslavia,  
E-mail: bora@umsim.im.ns.ac.yu

<sup>2</sup>Faculty of Medicine, University of Banja Luka, Serbian Republic, Bosnia

<sup>3</sup>“Dositej Obradović” High School, Novi Kneževac, Yugoslavia

For we, in fact, represent the local realization of the cosmos who reached the self-consciousness. We have started to think about our own origins: the stellar matter that thinks about the stars; an organized set of ten billions of billions of billions of atoms which questions the evolution of the atoms, comprehending the long road which, at least here, the consciousness has crossed during its arising. Our loyalty belongs to our species and our planet. We speak on behalf of the Earth. The obligation to survive we owe not only to ourselves, but in the same amount to the cosmos, ancient and immense, from which we originate.

(Carl Sagan)

**Abstract.** In this paper we describe the consciousness layers - from non-living matter, including living creatures up to intelligent beings and present their energy and functional characterization. The very fact that non-living matter possesses two active layers, living creatures - eight, and intelligent beings - a total of seventeen, represents the logical basis for the explanation how living creature arises from the non-living matter, changing into the intelligent being. Since the modern quantum physics is not capable of excluding the perturbation of the system due to the role of the observer in the measurement act, so it can not offer the adequate explanation, the basis of the presented results in David Bohm's holographic theory according to which each particle in the Universe contains the complete information about the complete Universe. The consciousness layers are energy entities whose attributes can be viewed through the energy presentations of mutual interactions of consciousness layers present at the certain organization degree (non-living matter, living creatures, intelligent beings). By the thinning of the barriers separating consciousness layers we arrive to the necessary information, which is ubiquitous according to Bohm's theory. The perspective of a possible evolution of the intelligent beings was considered, which would evolve through the informational interaction through potentially common consciousness layers. This paper deals also with the energy aspects of a single individuality.

**Key words:** *evolutionary intelligence, emotional intelligence, logical intelligence, intuitive intelligence.*

"The physicists have reached the knowledge that universe in fact, might be interconnected in more subtle ways than it was previously thought. This new kind of interconnectedness which appeared recently, not only enforces the similarity between the view of physicists and mystics, it also represents extremely interesting possibility for connecting the subatomic physics with Jung psychology and maybe, even parapsychology..." [1].

In this work we present the results obtained on the basis of the D. Bohm's Holographic Theory (see the

Table 1 of consciousness layers). The scientific point of view of the world used in the classical and subatomic physics assumes the existence of local variables. In the classical physics, local variables are located in the objects themselves and determine the flow of the events. In the subatomic physics they are represented by the connections transmitted by the fields such that no signal can be transmitted with the velocity higher than the velocity of the light. Quantum physics assumes nonlocal variables, which represent the instantaneous relations to the universe as a whole. Einstein was never willing (or able) to accept the existence of non-local connections. John Bell, however, derived a theorem based on the EPR - experiment proving that the existence of local variables contradicts the statistical predictions of the quantum theory. Bell in fact proved that the understanding of the reality in which all interactions are transmitted by local connections is unacceptable within the quantum theory. In this work, the nonlocality property is explained by the function of 17th layer, which is possessed by everything existing.

The consciousness is defined as the sum of all perceptive, governing and control mechanisms (potential and functional) which enable activation, dynamics, perspective and duration to a certain form of the existence. It represents the realization of the intelligence, which is the understanding of the existence from four aspects:

- (1) aspect of the perspective (evolutionary intelligence),
- (2) aspect of the need (emotional intelligence),
- (3) aspect of the concrete causality (logical intelligence),
- (4) aspect of the universal causality (intuitive intelligence).

From this list one can conclude that the form of the existence which could not understand its own

existence could not be able to preserve it and would instantaneously cease to exist (see the example of the neutron later). Non-living matter has two active consciousness layers (11th and 17th) and only two forms of the intelligence - evolutionary and emotional one [2]. In living beings there are eight active consciousness layers (1st, 3rd, 6th, 9th, 10th, 11th, 16th and 17th) and three forms of the intelligence - evolutionary, emotional and logical one. Intelligent beings use actively all 17 consciousness layers and all four forms of the intelligence. Consciousness layers are ideal functional units for the optimal functioning of the integral interactive dynamics of the consciousness function. There exist 17 such layers on the level of total integral interactive dynamics of consciousness function. The 1st layer is entitled the conscious one while the other 16 are unconscious. Due to the fact that consciousness layers are independent energetical units, their individual characteristics manifest in the interactions of particular consciousness layers of certain organization level (non-living matter, living beings, intelligent being).

Although physics initially dealt with the study of non-living matter, during its scientific evolution it started to include the observer into its experiments. One can not imagine modern physics without mathematics. It is interesting to mention Nietzsche's vision of mathematics: "It is an illusion that we have knowledge of something when we possess the mathematical expression for that what happened: it is only sketched, described, nothing more" [3]! Further in this work, we shall avoid the mathematical formalism in dealing with the interactions of consciousness layers in terms of energy characteristics trying to show that physics can not only describe, but also explain the phenomena without using mathematics.

We shall start from the particle which is obtained as the final product of the partition of the matter which is entitled Ki. More complex structures built from Ki-s should be explained by transformative functional analysis - a particular field of mathematics. Modern physics will probably have to wait for the Grand Unification Theory to prove its existence. Since it is an elementary spatial particle in permanent motion, it also represents the elementary quantum of the energy. Our each action, mental or physical, is followed by an adequate extension of the Ki particles, so they can be directed by our attention towards various parts of sick organism, which is the basis of the bioenergetical treatment of the diseases (one can consult the excellent book *Secret Life of Plants* [4] about the action of the bioenergy to the plant growth).

Elementary particles which are the basis of the modern physics are the quarks [5]. They were never registered free. The energy necessary to separate the quarks within the proton is such that when the proton decays, quarks within it have already spent that energy for bonding and we obtain a variety of particles depending on the energy spent.

From the point of view of the consciousness layers, the quarks are non-living matter and they possess two active consciousness layers (11th and 17th) and two forms of the intelligence (understanding of the existence): aspect of the need - emotional and aspect of the perspective - evolutionary one. Since they can not exist isolated, they have large needs to interact with the environment and the need to create a structure that would remain stable during the interaction. We are interested in two subatomic structures: proton and neutron. The proton has stable structure while neutron decays. Let us consider the proton needs and its perspective. The proton is positive and has the need to bond one electron. The perspective of such bond gives the stable configuration of the hydrogen atom. The neutron has no need to bond any charged particles and as such has no perspective for creating further superstructure, so in 900 seconds it decays spontaneously.

The next level of the matter organization is the atomic structures. All interactions at the atomic level occur through the electron shell which is the basic characteristics of an atom. Each chemical element has the characteristic spectrum [6]. This important property characterizes not only atomic spectra, but can be extended to molecules and nuclei. All these systems emit and absorb the electromagnetic radiation of strictly determined frequencies that range from radiofrequencies (for molecules) to X-rays with very short wavelengths or gamma-rays (for nuclei). To each system there is assigned a set of energy levels or stationary states which represent the basic characteristics of the system. It is interesting to notice that with the increase of the system organization, energy for interaction decreases implying that systems with simpler structure have stronger evolutionary needs.

To summarize, the realistic needs of the non-living matter are existential and evolutionary [7]. The existential ones are the survival of the very structure and the attraction of other structures. Evolutionary needs represent the creation of more and more complex structures from two aspects: the superstructure of cohesion ones (constituent parts lose their individuality) and the initialization of the bipolar (constituent parts retain their individuality) gravitational associations of love.

If we mix and then expose to the action of electric sparks the gasses of the primitive Earth [8]: hydrogen, vapor, ammonia, methane, hydrogen-sulfide, which all occur on Jupiter, after about ten minutes of sparks there appear stripes on the pot sides, built of brown tar. Tar represents extremely rich source of complex organic molecules, among them also the constitutional parts of proteins and nucleic acids. It turns out that the building blocks of life can be produced rather easily. The most interesting fact for us is that under certain circumstances nucleic acids are able to synthesize their own copies in the test tube. The transition from non-living towards living matter occurs at that

moment when the non-living matter achieves the organization level at which it can reproduce itself, or in other words when consciousness layers are activated which have no functions in the non-living matter. These are the 1st, 3rd, 6th, 9th, 10th and 16th consciousness layer, which together with the 11th and 17th represent eight consciousness layers and bring a new quality of the matter organization which we entitle the living being. The essential characteristics of the living being is the logical intelligence, i.e. the understanding of the existence from the aspect of cause and effect, which is located in the 1st layer. The 3rd layer includes sorting and deposition of the information from the current life. The 6th controls the self-defense mechanisms and genetic knowledge. The computer of the biological automation is located in the 9th. The 10th regulates the work mechanisms and emotional accumulators. The 16th includes the gravitational associations of love on the level of living beings (collective unconscious on the level of living beings). Together with 11th and 17th consciousness layers we have a totality of the consciousness which represents the living being.

Living being has real needs: existential, sexual and evolutionary ones. The existential needs are: the need for the preservation of one's own life, the need for the preservation of one's own descendants' life, and the need for interactivity. Sexual needs of living beings represent the biological need for a sexual intercourse as the means for the continuation of species (appears in the first third of the evolution of living beings). The need for the sexual intercourse with individual or individuals with the goal of the biological evolution of the species (arises in the second third) and the need for the sexual intercourse with the individual with the goal of creating a family community will enable the optimal protection of oneself and its descendants (arises in the last third of the period of being evolution). Evolutionary needs of the living beings manifest through the extension of the genetic characteristics of one's own species in four aspects: extension of the intellectual capacity, extension of the bipolar gravitational associations of love, extension of the adaptability to the living conditions and the extension of the creative potentials.

Such organization of the consciousness can explain also the function of the sleep. The existence of two phases of the sleep - slow-wave or NREM and paradoxical or REM sleep [9] - and the fact that during the phylogenetic development of the sleep stadiums, the slow-wave appeared first, and paradoxical only later, can be explained in terms of consciousness layers. The basic function of the sleep is the communication with the unconscious. Slow-wave sleep is characteristic for the communication with the 16th and 17th consciousness layer (16th - collective unconscious of the living beings and 17th - collective unconscious of the non-living matter). Paradoxical sleep maintains the communication with the 1st layer (logical intelligence) and compares it

with the information received from 16th and 17th layer. This sleep demands a more developed level of the logical intelligence, so it is clear why it appears later in the phylogenesis of the mammal sleep. Other living beings, of course, have no access to 16th and 17th consciousness layer, but other mechanisms seem to be relevant. The plant communication with the intelligent being through 16th and 17th layer is explained in the mentioned work [4]. When creating mentally the intention to burn a leaf connected to an electrode, the observer registers the plant reaction because the polygraph recorder makes a sharp peak. Later, when pretending the burning activity, no reaction was registered.

"It seems however that the sensitivity does not stop at the cell level, but goes further and deeper up to molecular, atomic or even subatomic level. If this is true, we shall have to re-examine our attitude towards many things considered today as non-living only because it is more comfortable to us" - [4] yet another example of the communication of the non-living matter through the 17th consciousness layer.

Living beings evolve through the development of the logical intelligence. The existence of the logical intelligence can lead to the existence of non-realistic needs which are the consequence of the causality illusion. Non-realistic needs of the living beings include: greed, inertia and addiction. We stress that non-living matter has no non-realistic needs since it does not possess causal intelligence (neither logical, nor intuitive one).

Living beings develop during the evolution with the increase of the logical intelligence. When living beings reach the "critical mass" of the logical intelligence, i.e. when one can not transfer any more to the descendants global and special knowledges of the current life neither by training nor genetically, there arises the need for the individuality preservation. Individuality preservation occurs in such a way that an energy field is formed which keeps together the knowledge which provides the individuality of the living being and activates (2nd, 4th, 5th, 7th, 8th, 12th, 13th, 14th, and 15th) consciousness layers - there arises an intelligent being. (On our planet the dolphins have reached the transition level, yet their further progress is mostly prevented by the human beings.) This energy we entitle the soul. The proofs of its existence can be found in the work of Jung and Pauli [11] when they speak about the people who went through clinical death. During the period of clinical death the soul "separates" from the body and the persons are completely aware that they are looking at their own lifeless body from a certain height. Later, when they "return to life", they are able of telling what was going on around them during all the period.

It is the soul that enables the intelligent being the permanent existence, yet like any other energy field it can be destroyed, most often in two ways: by the non-ethical mental or physical activities (untrained or uncontrolled practicing of creative meditations) and

the barrier breakdown (the illusion of the cognition of the spiritual progress and increase of powers - the illumination).

Consciousness layers, which are activated in the intelligent being, are: 2nd, 4th, 5th, 7th, 8th, 12th, 13th, 14th and 15th. The 2nd layer includes the development and the realization of the ability of abstract thinking, the 4th - the center of the optimal functioning (karmic aspect), the 5th - integrational processes of the intelligent being, the 7th - intuitive intelligence, the 8th - the archives of the total knowledge of the soul and the mechanisms of serving the 7th layer, the 12th - connection to the beloved person, the 13th - connection on the parent - child relation, the 14th - connection with other representatives of the same type of intelligence [10], the 15th - connection to the representatives of other types of the intelligence. Energetical aspect of such consciousness integrity of an intelligent being can be studied through encephalographic measurements of the brainwaves. The meditation is the achieving of deeper levels of consciousness in the awake state. Creative meditations are based on the Holographic theory by D. Bohm according to which each particle of the universe possesses all the information about the whole universe, and for whose experimental proof D. Gabor received the Nobel prize. The basic point here is that the part possesses the information about the whole, which at the same time is the basic problem of the quantum theory of measurement. The holographic picture is two-dimensional, yet gives the three-dimensional information about the subject because the recording uses the phase difference between incoming laser beams and those reflected from the object. This would be the physical explanation how a two-dimensional picture leads to a three-dimensional information. What physics is not able to explain, however, is why the parts of this picture possess the information about the whole picture. These pictures are produced on the glass, which when broken, does not produce two halves of the picture but two pictures which, each for itself represents the object as a whole yet diminished in size. Splitting each of these pictures again would again lead to a picture of the complete object.

The theoretical framework of this problem is the Holographic theory by D. Bohm, while the final explanation is given only by the existence of the 17th consciousness layer, due to the fact that it is possessed by everything existing (non-living matter, living beings and intelligent beings) and that it is the common consciousness layer, the information deposited in it is available to everything existing. In the same way, in Quantum Mechanics, the parts which can not exchange light signals (EPR-paradox) possess the information about each other, which would imply that the information is transferred by the velocity higher than the velocity of light. In the final instance, this indicates that the consciousness as a kind of subjective observer in this kind of experiment should

possess the non-local properties [12]! Where does this non-locality come from? The fact that everything existing possesses the 17th consciousness layer (this is collective unconscious on the level of total existence), explains the non-locality of the Quantum Theory. Since even living beings consist of non-living matter, when the living being is formed, the information about it is transferred to the collective unconscious (16th and 17th layer) so that the remaining non-living matter possesses all the necessary information about the possibility to achieve the organization level of the living being. This would imply that the evolution in the nature is not occurring completely at random (through mutations and selection) but possesses a collective character.

Intelligent beings are the peak of the cohesional evolution (constitutional parts lose its individuality) and as such they are all equally worth with the only difference that each person does not use its potentials equally. Real needs of the intelligent being are: the evolutionary ones, superstructural ones, sexual ones, creative ones, needs for the extension of one's own powers, essential and development needs. Intelligent beings, possessing the logical intelligence (concrete and universal), also have a larger chance of erroneous causality so there appear also the non-realistic needs, which are: fictitious (the loss of the awareness of the illusion), autoritary (caused by the syndrome of discrimination - domination - destruction), religious (caused by one's own helplessness) and destructive ones (caused by the panic fear of one's own helplessness) [7].

The tendency towards happiness is the motive power which certain form of existence activates towards the realization of the real needs which permanently supplies the motive mechanisms of the evolution. The further evolution of the intelligent beings takes place by using potentially common consciousness layers (7th, 8th, 9th, 10th and 11th) through sexual interactions. The importance of sexual interactions and their energetic manifestations to the health is probably best expressed in the work of W. Reich [13]. In that aim the ethics (not-threatening the real needs of the others and helping them) and the power (ability to protect one's own real needs) represent the basis for the superstructuring of the development of the intelligent beings.

Further evolution of the intelligent beings, however, is not possible without the synchronous action of all four forms of the intelligence, i.e. without the connection of the conscious and unconscious parts of the consciousness (mind). In practice, one often uses the expression "the unification of the mind and body", which arose from a false translation from Japanese to English of the Shin - Shin Toitsu Aikido [14]. Since, however, nothing in the body occurs without the leadership of the mind, if conscious and unconscious act synchronously and optimally, the body will also function optimally. The opposite is also valid: if the body functions optimally, there exists a

synchronous action of the conscious and unconscious part of the mind. Based on this principle, in Toitsudo Ryu Aikido there were developed about a hundred of tests which enable the control of the mind through physical tests, and also its correction if forms of the intelligence do not act synchronously. The basic principles of the unification of mind and body [6] have been extended using the 17th consciousness layer (which causes the nonlocality of the Quantum Theory and enables the communication with overall existence) in such a way that particular aspects of the functioning could be tested. These tests have the basic

function which is the same as the role of the experiment in Physics - to prove the reality of the cognition. The basic tests are: the reality test (the walk with the positive Ki) - controls the reality of the cognition; the test of the individuality - controls if the acceptance of the information, cognition and knowledge - controls the individual level of development of consciousness, knowledge, abilities and powers; evolutionary test - controls the evolutionary directioning and radioesthetic check with the awareness that radioestesty is 86% correct.



**Table 1** Consciousness Layers

functional division	orbital division	consciousness layer	nonliving matter	living beings	intelligent beings	
conscious	individual consciousness layers	1			Logical processes, global and special knowledge of the current life (logical intelligence). The fund of information necessary for the optimal functioning at the conscious level, instinct and 2nd emotional generator.	
		2			Development and realization of the ability of abstract thinking (automatic processes).	
		3			Sorting and deposition of the information (the archives of the forgotten from the current life) and the recall mechanisms (automatic processes).	
		4			Center of the optimal functioning (gender structure of the soul and its relation to the incarnation gender, internal leadership in the realization of karma, the control of the vegetative nervous system).	
		5			Adaptation of the soul to the form of existence and concrete individual in which it is incarnated and all other integrational processes of the intelligent being.	
		6			Control mechanisms of the creative processes from their aspect of self-defense and genetic knowledge (instincts).	
unconscious	potentially common consciousness layers	7			Intuitive creative processes and the whole of the creation by connection to the 1st layer (intuitive intelligence) and 3rd emotional generator.	
		8			Archives of the total knowledge of the soul and the mechanisms for the optimal informational servicing of the 7th consciousness layer.	
		9			Basic mechanisms of the functioning of the intelligence. The computer of total biological (or adequate) automatics.	
		10			Work mechanisms (conditional reflexes, automatization) and emotional accumulators.	
		11			Control of chakras of the emotional functioning, emotional regler and 1st emotional generator (emotional intelligence).	
	common consciousness layers	12				Common consciousness on the level of the gravitational association of true love between the sexes and the transversal love.
		13				Common consciousness of the children and parents on the level of the gravitational association of the love towards one's own child.
		14				Common consciousness of the gravitational association of love on the level of one's own species.
		15				Common consciousness of the gravitational association of love on the level of total intelligence.
		16				Common consciousness of the gravitational association of love on the level of living beings.
		17				Common consciousness of the gravitational association of love on the level of total existence (evolutionary intelligence).

During the tests, one uses the verbal and nonverbal provocation for verifying the correctness. Toitsudo Ryu Aikido is a new field developed about ten years ago in Novi Sad. Within its framework there exists and operates the central sanification and scientific research team.

Summarizing everything presented till now, one can rightfully ask if the modern science with all its instruments, can alone, without the ancient wisdom

incorporated in the modern Toitsudo Ryu Aikido, finally understand and explain the man and his consciousness, as well as his communication with non-living matter, living beings and other intelligent beings. If we were based on the science only, we would deny the functions of consciousness layers. Yet, both the science and Toitsudo Ryu Aikido openly recognize that consciousness might be one of ubiquitous aspects of the universe which will be, no

doubt, included in all future theories of the physical phenomena.

This paper has tried, based on Bohm's theory and the results of Toitsudo Ryu Aikido, to present one of the most interesting, most imaginative and philosophically extremely interesting approaches to the physical reality. It presents the interactions between the consciousness layers through energy manifestations. One of the most important results that we have reached is the explanation of the non-locality of quantum mechanics as the consequence of the existence of the 17th consciousness layer, possessed by everything existing. The next result is the existence of the energetic field - the soul, which provides a permanent existence of the intelligent beings and their progress through the evolution. The key role in preserving the soul has the ethics in the sense of not threatening the real needs of the others and the power - ability to protect one's own real needs. Talking about the meditation and illumination, it is important to draw attention to the danger of the breakdown of the barriers. The illumination is the illusion of the spiritual progress and yet another way of distracting one's soul.

Finally, we draw the attention to the importance of the testing. The basic function of tests is to verify the knowledge that was reached.

Since modern physics is an experimental science, just as the majority of natural sciences, and since Toitsudo Ryu Aikido verifies all its statements by physical tests, and also possesses the subject and the methodology of the research, one can conclude that it should be expected to find its application within the science.

## References

- [1] F. Capra, *The Tao of Physics* (Fontana/Collins, 1976).
- [2] D. Marković, *General Theory of Toitsudo Ryu Aikido* (Novi Sad, 1993), unpublished manuscript.
- [3] F. Nietzsche, *Der Wille zur Macht* (Alfred Kroner Verlag, Stuttgart, 1980).
- [4] P. Tompkins and C. Bird, *The Secret Life of Plants* (1973).
- [5] W.E. Burcham, *Nuclear Physics* (London, 1972).
- [6] E.H. Wichmann, *Quantum Physics* (Education Development center Inc., Newton, MA, 1967).
- [7] D. Marković, *Survey of General Theory of Toitsudo Ryu Aikido* (Novi Sad, 1995).
- [8] C. Sagan, *Cosmos* (C. Sagan Productions, 1980).
- [9] V. Šušić and D. Živanović, Waking - sleeping cycle, in Lj. Rakić, D. Raković, Đ. Koruga and A. Marjanović, eds., *Consciousness: Scientific Challenge of the 21st Century*, Proc. ECPD Seminar, Belgrade, 1996, pp. 59-62, in Serbian.
- [10] C.G. Jung, *Dynamics of the Unconscious* (Novi Sad, 1990), Serbian transl.
- [11] C.G. Jung and W. Pauli, *Naturerklarung und Psyche* (Walter - Verlag AG, Olten, 1970).
- [12] D. Raković, Brainwaves, neural networks, and ionic structures: Biophysical model for altered states of consciousness, in D. Raković and D. Koruga, eds., *Consciousness Scientific Challenge of the 21st Century* (ECPD, Belgrade, 1995), pp. 291-316, and references therein.
- [13] W. Reich, *The Function of the Orgasm* (World Publishing, New York, 1970).
- [14] K. Maruyama, *Aikido with Ki* (Ki No Kenkyukai, H.Q. Tokyo, 1984).

## A HYPOTHESIS OF SELFCONSCIOUSNESS AS TRUTH AND PHENOMENOLOGICAL BASIS FOR PERSONALITY INTEGRATION

Vladimir Desimirović

Institute of Psychiatry, KBC Zvezdara, Belgrade, Yugoslavia

**Abstract.** A hypothesis of personality integration is offered on two levels. The first one is the level of neuronal organization of memory in system in which hippocampus plays outstanding role. Through phasic (desynchronization) and tonic (theta synchronization) activities hippocampus is conspicuously involved first with integration of cognized elements into totality and consolidation of engrams afterward. Besides, it should be noticed that hippocampus and related anatomical structures are constituent parts of limbic system known as upper control and integration level for emotions, drives and autonomous or vegetative functions, i.e. irrational part of man.

The second level of putative integration is integrative concept of truth. Truth is result of mergence of belief with rationally apprehended set of facts, rational knowledge with irrational feeling of trust. It is ideoaffective composite with subjectively defined meaning and value. By this fusion neutral information gets the status of truth and converts into attitude with motivational incitement. It becomes behaviour vector. Rational and irrational parts of man compose every truth so we may say that any truth as transitory absolute is a unit, an atom of integrative personality process. Total sum of truths makes system-referent axis or network. This serves as global orientation parameter.

Selfconsciousness reduced to identity and identity defined as knowledge of oneself is itself fusion of irrational and rational spheres as well as any other truth or transitory absolute. And, consequently it is also part of referent network, but with central position in it. Whatsoever intervention on selfimage is most sensitive, traumatic operation which testifies about its importance for personality function. Contradictory transitory absolute should be conformed to identity if possible. Elimination of disharmony increases integration of personality.

The link between these two levels, neuronal and psychological, memory role of hippocampus and truth complex is found in the fact that every truth is a sort of knowledge, and every knowledge is a sort of engram. Therefore, every engram has to do with hippocampus and entorhinal cortex, the parts of emotional brain. So, this might be neural basis of elementary integration, as *personality integrative atom* giving birth to general personality integration through identity as specific truth incorporated in selfconsciousness.

**Key words:** *consciousness, selfconsciousness, knowledge, identity, integrity, truth, transitory absolute, referent network.*

Whenever it is said - conscious, it is meant that a person not only feels, thinks, wants and does, but *knows* [1,2] about his own performances as an impartial spectator of his own show on the mental

stage illuminated by his consciousness. Wakefulness is presumed.

### 1 Relationship Between Consciousness and Selfconsciousness

We can talk about selfconsciousness without paying any attention to the difference between it and consciousness. Because consciousness is always related to subjective sphere content, in a way conscious man is necessarily selfconscious of his own perception, memory, emotion, need, volitional movement [3,4] or more sophisticated elements of selfconscious experience, such as: self, thinking - ideation, making decisions, free will, integration of past-present-future experiences, or moral feelings. And this justifies the approaches in which consciousness and selfconsciousness are analyzed as plain synonyms. But if we think of identity and integrity [5] supposing to be principal parts of selfconsciousness, then there appears reason to think of selfconsciousness as a separate entity of consciousness. And this is what we are going to do. It is free from cognitive sin as much as intelligence extraction from general thinking process [6].

### 2 Identity and Integrity

When selfconsciousness (selforientation) is decomposed and enriched by the concepts of identity and integrity of personality we are enabled to make a few further steps in the field of research we are interested in.

Identity means several things: it means that an old man knows it is himself in the photographs of a baby, young boy and middle aged man he is actually looking at. Identity also means to have a clear cut picture of personality features, characteristics with well developed attitudes, interests and so on. Or simplified, identity means to possess mental *picture* of oneself, to possess *knowledge* of oneself, or possession of a autopsychic orientation. Identity means also the acceptance of one's physical image, and explorers, Gallup for instance [7], used the fact to reduce very intricate composition of identity to physical component in identification test by mirror.



Integrity also means a few things. It means that person all his ambivalencies, ambipendencies, and complex affective states (composed of antagonistic feelings which should mutually exclude each other) accepts as his own conditions, controls himself, and reacts after choice is made, behaving without splitting his personality to alternating persons and letting them exist disharmoniously, as separate and different life styles. It also means that a person reacts as a whole in relatively stable, lasting fashion, so that a person is predictable in his reactions.

### 3 Three Ways of Testing Consciousness

There are three different investigation techniques, each one appropriate for wakefulness, consciousness and selfconsciousness. Wakefulness is examined by rough sensory stimulation and observation of its effects. Judgement of awareness is done on the ground of three criteria, and all of three are objective and reactive in essence: emotional reactions are adequate to the circumstances; in reactions there is some degree of intelligence; reactions reveal that appropriate, useful patterns of behavior can be learnt. These two techniques are not necessarily verbal. But selfconsciousness is most subjective experience approachable only through introspection. It can be later shared with other people relating it to them through verbal report. Verbal inquiry on selfconsciousness means asking questions about selforientation, autopsychic orientation. Yet, there is a non verbal method completely different from the previous ones, to be used for selfconsciousness examination. If a stain is painted on our face, and we have a look at mirror, we become aware without delay it not to be part of our normal portrait. In Gallup's studies [4,7] the complexity of selfconsciousness was reduced to identity. And when you sinned once, why not make it - twice. Additionally, complexity of identity was reduced to somatic identification - recognition of normal face view, or more precisely - abnormal presence of blot.

So three different nonverbal testing ways for three different levels of consciousness (using word consciousness as non specific term comprising all tree levels), give us additional support to think of selfconsciousness as separate part of consciousness with its own meaning and role in individual mental function and structure.

Selfconsciousness could be thought of as truth, too. Knowledge of oneself formulated as personal identity is *truth* of oneself, and also an attitude towards oneself, whatever it might be. Normally, man does not doubt whether his knowledge of himself is truthful or not. It is accepted the picture of oneself to correspond to real qualities and values, because only under such circumstances selfrespect is not shattered.

If we intend to understand hypothesis about identity as truth of oneself and part of selfconsciousnes on one side, and then truth per se on

the other side and their impact on personality integration, we should try to define meaning of truth. So, before we continue, let us see how truth could be described.

### 4 Transitory Absolute and Referent Network or Axis

Truth is union of rational with irrational part of personality.

It is supposed [8] for truth to be any knowledge built upon information in which emotion of belief in its exact and unequivocal meaning is included. By the act of mergence of trust in rationally apprehended set of facts (directly and indirectly), neutral information gets the status of truth and converts into attitude with motivational incitement. It becomes behaviour vector. Therefore, truth is ideoaffective composite with subjectively defined meaning and value. It is meeting point of rational knowledge with irrational feeling of trust. Though we believe that truthful information corresponds to relationship found objectively, it is clear that truth cannot be reduced to pure reason. The bare act of trust has always its roots in sphere where the pleasure principle rules. And without trust truth has no power, no influence. It is deprived of significance and even of meaning.

Truth is dynamic phenomenon as well. It develops through cognitive progression [9,10]. So we can suppose every phase of progression to be not part of process, but final result meaning different truth. And at any level of its development truth becomes: (1) knowledge, (2) thought, (3) ideoaffective union, (4) attitude, and (5) motive with directing power over persons behaviour, though it can be changed what indeed intermittently happens. *Therefore, truth is transitory absolute* [8]. Until its content is transformed it has absolute power in a sector of practice as specific partial knowledge and belief.

Transitory absolute represents union of two mental sides of human mentality - rational and irrational. It is always so, even when truth is made logically, after rigorous critical evaluations and strictest control. The final result must include - the trust. *From this fusion moment on, it has strong impact on cognition and behaviour.* Because every new situation-event-information-input is compared with relevant transitory absolute as a specific parameter from experience, meaning and significance of new information is judged according to transitory absolute and its meaning deciphered by. So we may say that *any truth as transitory absolute is a unit, an atom of integrative personality process.*

All transitory absolutes compose the system as net or chain of accepted truths with power of attitude. They make personality *referent network, or referent axis* [8] and it serves as global orientation parameter. Anything is judged in comparison with it. The result is behaviour modification.

## 5 Truth as Identity and Selfconsciousness

Among transitory absolutes forming referent network of truths outstanding position belongs to knowledge about oneself or *truth of oneself*, i.e. image of oneself - selfconsciousness. *Identity is truth of oneself, and has all characteristics of transitory absolute.*

Identity is global image of self as a resultant totality. In it rational, irrational, moral and social aspects are fused. And outcome is compared with ideal image a man strives for. Selfconsciousness as an image of oneself, as identity, has central position in referent network. It is inherent orientation point for other transitory absolutes making relatively stable system of truths in interactions.

## 6 Integrity

An outline of personality integration may be proposed on two levels. The first one is on level of neuronal organization of memory in system in which hippocampus plays very important role, and the second is on the phenomenological level by integrative concept of truth. The link between these two levels is found in the fact that every truth is a sort of knowledge, and every knowledge is a sort of engram. And every engram has to do with hippocampus and entorhinal cortex, the parts of emotional brain [4,11-16].

It seems hippocampal phasic and tonic activities are first engaged to associate synchronously perceived elements (after elaboration in distant brain regions) into totality, and afterward this newly cognized information is consolidated as engram. So far it is cognition process. If we know that hippocampus and entorhinal cortex belong to limbic system, Papez circuitry [17] for emotional expression, and improved Mac Leans version of the system [4,18], it should not be unexpected that in every truth we find emotional ingredient. So this might be neural basis of elementary integration, as *personality integrative atom* giving birth to general personality integration through transitory absolute network.

On phenomenological level, the very core of integration may be found in personality integration atom - in truth (synonym - transitory absolute). As we see, in truth meet results of reasoning with trust, an emotional attitude of acceptance, belief in lawful correspondence between intrapsychic apprehension, and extrapsychic stimuli, this meaning being taken in most general sense.

If we think of selfconsciousness as identity which among other things means image of oneself, i.e. truth of oneself, than it necessarily is combination of logic reasoning and emotion, and it holds true for any truth.

Truth of oneself - identity is an entity among many truths. As any other transitory absolute, truth of oneself is included into "referent axis", general

intrinsic orientation parameter having exceptionally important position in hierarchy of significance. Because of that truths in transitory absolute network should be brought into accord with the image of oneself. The clash among disharmonic attitudes (intolerance is derived out of emotions) creates unbearable intrapsychic tension. Harmony is created by discrepancy removal, which starts defensive integrative processes. conscious and/or unconscious [19].

## References

- [1] Cousin (?) in C. Spearman, *Psychology Down the Ages* (Macmillan and Co. Ltd, London, 1937), Ch. 1, 4.
- [2] V. Desimirović, in V. Desimirović, *Contemporary Medical Psychology* (Nauka, Beograd 1994), Ch. 10. in Serbian.
- [3] S. Sutton, N. Braren, and J. Zubin, Evoked potential correlates of stimulus uncertainty, *Science* 150 (1965), pp. 1187-1188.
- [4] V. Desimirović, Biological Basis of consciousness, in D. Raković and Dj. Koruga, eds., *Consciousness Scientific Challenge of 21st Century* (ECPD & Čigoja, 1996), pp. 45-86.
- [5] K. Jaspers, Awareness of the self, in K. Jasper, *General Psychopathology* (The University of Chicago, 1968), § 7.
- [6] V. Desimirović, The knowledge of oneself - selfconsciousness, in Lj. Rakić, D. Raković, Dj. Koruga, and A. Marjanović, eds., *Consciousness: Scientific Challenge of the 21st Century* (ECPD, Belgrade, 1996), pp.67-72, in Serbian.
- [7] G. Gallup, Selfrecognition in primates, *Am. Psychol.* 32 (1977), pp. 329-338.
- [8] V. Desimirović, Essay on truth from psychological standpoint, unpublished manuscript.
- [9] B. de Spinoza, *Ethica*, (BIGZ, Belgrade, 1970), in Serbian.
- [10] N. Hartman, *Neue wege der ontologie* (BIGZ, Belgrade, 1973), in Serbian.
- [11] Z. Elazar, and W. Adey, EEG correlates of learning in subcortical and cortical structures, *EEG and Clininic. Neurophysiol.* 23 (1967), pp. 306-319.
- [12] P. Parmeggiani, Of the functional significance of the hippocampal theta rhythm, *Progress in Brain Research* 27 (1967), pp. 413-431.
- [13] Y. Yamaguchi, N. Yoshii, K. Miyamoto, and N. Itoigawa, A study of the invasive hippocampal theta waves to the cortex, *Progress in Brain Research*, 27 (1967), pp. 281-292.
- [14] J. Green, and A. Arduini, Hippocampal electrical activity in arousal, *J. Neurophysiol.* 23 (1954), pp. 403-420.
- [15] C. Euler, and J. Green, Excitation inhibition and rhythmical activity in hippocampal pyramidal cells in rabbit, *Acta Scand. Physiolog.* 48 (1960), pp. 110-125.

- [16] J. Eccles, Remembrance, in *The Human Psyche*, (Springer, Berlin, 1980), Ch.7.
- [17] J. Papez, A proposed mechanism of emotion, *Arch. Neurol. Psychiat.* 18 (1937), 725-744.
- [18] P. Mac Lean, Psychosomatic disease and the "visceral brain", *Psychosom. Medicine* 11 (1949), pp. 338-353.
- [19] V. Desimirović, Consciousness in personality organization, in V. Desimirović, *Medical Psychology* (Nauka, Belgrade, 1997), Ch 15, in Serbian.

## AWARNESS OF SOUND SIGNALS IN CHILDREN WITH IMPAIRED HEARING

Sanja Djokovic

Faculty of Defectology, University of Belgrade, Yugoslavia

**Abstract.** J.G. Herder once said that man as a rational being, integrates in his mind the representations produced by the sense of touch, on one side, and the sense of sight, on other side, and all these representations converge to the point where specific features become sounds [1]. The sense of hearing has become the central and integrating sense. If we use this thesis to explain the relation between thought and language, at least at physical level, the inevitable link will be the sense of hearing, i.e., human ability to process hearing sensations and perceptive level [2]. In this paper we tried to outline some clarifications pertaining to perception and introduction of sound signal in persons with hearing impairment. The experiment comprised monitoring of perception and production of certain sound stimuli in children with impaired hearing. On the basis of the responses obtained in examined population, it was possible to establish which particular features of the offered sound are first perceived, adopted and produced. There were 24 children of pre-school age with hearing impairment who participated in this experiment. They underwent rehabilitation by KSAFA method at the "Institute for Experimental Phonetics and Speech Pathology". An expert commission of three members evaluated the results. This research project showed that children with hearing impairment may develop hearing attention if they start rehabilitation at an early age, with help of appropriate equipment and methodology, and consequently perceive the basic elements of sound in accordance with the same selective and successive pattern found in children with normal hearing.

**Key words:** *consciousness, sound signal, hearing impairment, KSAFA method, pre-school age.*

If we approach the sense of hearing as a neurophysiological organ the purpose of which is to collect auditive sensations and partially participate in processing of these sensations for the purpose of information decoding, we are bound to meet, sooner or later, the works and ideas of a great scientist - Alexander Luria [3].

Functioning of the human brain requires continual participation of at least three functional blocks - one of which provides awareness of the cortex and enables selective functions, the second provides reception, processing and storage of information, and the third programming, regulation and flow control (Luria [3,4]). Every instance of repetition or action with a purpose, including auditive perception, is possible only through joint operation of these three blocks.

Injuries or damage to the first block preclude the right tonus of the cortex which is necessary for

selective course of mental operation. An injury of the second block results in change of conditions necessary for reception and processing of information. Functional-organic disorders in the third block result in inability for active processing of information, and, consequently, inability for control of their further flow.

Children with impaired hearing have problems in reception and processing of auditive sensations, i.e. in the second functional block according to Luria. This means that these children cannot receive and process auditive information in a clear and precise manner. This defect results in absence of spontaneous development of speech and language, since this process is based on correct and unhindered auditive perception. Since statistical indicators suggest that a relatively small number of children suffer from complete absence of ability for perception of auditive stimuli and that there is a much greater number of children with certain remains of the sense of hearing, Surdoaudiologists have been trying to make use of these minimal remains to establish a channel for transmission of auditive sensations, providing a base for deposition of auditive impressions. These deposited impressions could be sufficient to provide an experience base for development speech and language in children with impaired hearing.

This paper is one of those which strive to determine what is the minimal amount of auditive information which may serve as a basis for hierarchical development of all levels of language. More precisely, we are dealing here with phoneme, i.e. its distinctive features: intensity, duration, voiced and voiceless).

Research work presented in this paper is focusing on the relation between various degrees of hearing impairment and ability for auditive perception of said distinctive features for certain phonemes in children with hearing impairment, and which of these distinctive features are the first to be used by these children in verbal production of phonemes. We also examined if certain planning of speech and language exercises, with help of selected auditive aids, can help in achieving progress in language reproduction in children with hearing impairment. These are the objectives of this research work.

The results of the phenomena examined have been procured by an assessment and analysis of reproduced verbal expressions of children with impaired hearing.

## 1 Research Methodology

There were 24 subjects in this research project: 13 girls (54.16%) and 11 boys (45.83%) Children were divided into two age groups: younger group with 12 subjects, from 2.6 to 4.6 years, and older group with children aged 4.6 to 6.6 years. Subjects were also divided into four groups according to the level of hearing impairment, in accordance with classification of Đ.Kostic [5]. Each group consisted of 6 subjects hierarchically graded from the most severe to the lightest cases of hearing impairment. Six subjects make 25% of total population. Examined subjects were also classified according to the time spent in programs for language and hearing rehabilitation. This classification resulted in formation of three groups. One group with subjects who have been in rehabilitation process for two years - 6 subjects (33.33%), the second group with 10 subjects with three years of rehabilitation (41.66%) and the third group with 8 subjects with four years of rehabilitation (25%).

Here is an outline of the technique and instruments used in testing of speech, language and hearing ability. For all subjects who participated in the testing and retesting after six months we used Ksafa-m apparatus. This apparatus is a contemporary auditive aid using the principle of selective filter amplification. Ksafa-m enables selective amplification of sound signals, precisely in that frequency range which is needed, with necessary intensity [6]. All subjects were requested to repeat certain language on the basis of examiner's production, and their performance was recorded on a professional tape recorder. Recorded material was subsequently analyzed by an expert commission consisting of three members. Reproduced language material was analyzed for parameters of intensity, duration and presence of voiced or voiceless quality of a sound. On the basis of reproduced materials conclusions were made as to what the subjects have perceived from the presented language material. On the basis of the same material it was possible to make conclusions concerning the sequence of adoption of the sound parameters under examination, which indicated awareness of these parameters. Only what has been learned and adopted may enter the region of awareness.

Language samples used in the testing consisted of simple two-syllable words and multi-syllable words. Formation of particular sounds was tested within these words.

## 2 Results and Discussion

Purpose of the analysis was to establish the possibilities for perception and adoption of the

parameters under examination (intensity, duration and voiced / voiceless) in children with hearing impairment in relation to age. The grades represent negative points, i.e., the greater grade signifies poorer results. Maximal negative grade is 30 points, minimal positive grade is 0.

In the Chart 1 it is clearly visible that the older children are better in production of the parameters under examination than the younger children. Statistical processing of the results revealed that the subjects from the older group achieve results which are statistically significantly better for all parameters under examination, namely, intensity  $t = 0.003$ , duration  $t = 0.002$  and voiced/voiceless  $t = 0.001$ . The results procured indicate that the subjects from the younger group were most successful in production and, therefore, perception of duration and its voiced quality. Their results were not so good in perception and reproduction of intensity. The same distribution of ability of perception and adoption was found in the older groups, as shown in Figure 1.

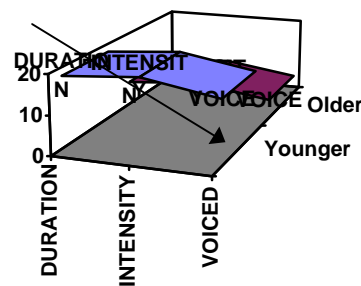

**Figure 1** Graphic presentation of the relation between arithmetic medians of duration, intensity and voiced/voiceless quality in subjects with impaired hearing from the younger and older group.

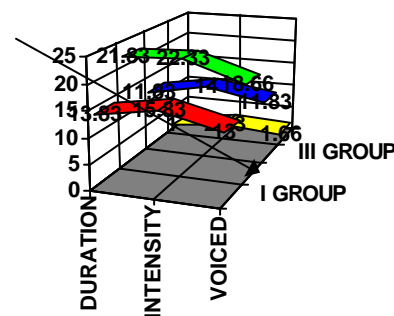
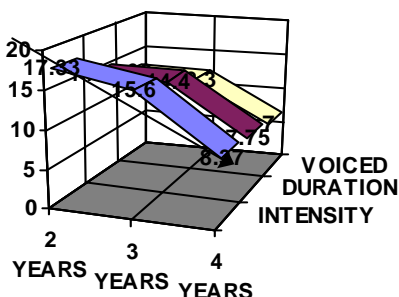

**Figure 2** Presents results procured for examined parameters in relation to the level of hearing impairment. The poorest results are those of the subjects from the second group of hearing impairment. Better results were achieved by the subjects from the first group, then those from the third group, and the best results are those of the subjects from the fourth group of hearing impairment.

Subjects from the second group were the best in perception and production of voiced and voiceless

sounds and duration. They were not so good in perception of intensity.

Tested subjects of all other groups of hearing impairment displayed the same pattern in acquisition of examined parameters of sounds and ability for their perception and reproduction. The difference between the groups with different levels of hearing impairment was only in grades. Statistical analysis of inter-group differences revealed that members of the fourth group of hearing impairment have had statistically significantly better results than all other subject, whereas correlation between the results of other groups had no statistical significance, except at the level of arithmetic average values.



**Figure 3** Graphic presentation of the relation between arithmetic average values for voiced/voiceless quality, intensity and duration for the groups of subjects who have attended rehabilitation programs for four, three and two years.

The best results were achieved by the subjects who spent four years on rehabilitation and the poorest results were achieved by those who spent two years on rehabilitation. Better perception, adoption and production of examined sounds is present at the level of arithmetic medians, but this difference bears no statistical significance in relation to groups of subjects.

It is interesting to note that the subjects from the first group achieved the best results in perception of voiced/voiceless quality, then duration and finally intensity. This order of the parameters under examination is evident in all examined groups.

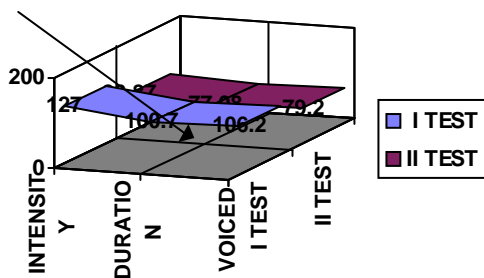

**Figure 4** Graphic presentation of the relation between arithmetic medians of intensity, duration and quality of voicing in the first and second test.

This project included repeated testing after six months. Surdoaudiologists-therapists worked with children on improvement of their auditive attention and abilities for adoption and production of speech material using Ksafa-m machines and following the instructions given after the first testing. The purpose of the project was to assess the potentials of properly organized and realized rehabilitation program using Ksafa-m machine.

The results obtained during the repeated tests revealed statistically significant improvement in perception, adoption and production of intensity ( $t = 0.000$ ) and duration ( $t = 0.013$ ) and voiced/voiceless quality (0.004). The most notable improvement was in intensity and slightly less in voiced/voiceless quality. The smallest improvement was achieved in duration. It turned out that the subjects achieved greatest improvement in the parameter which yielded the poorest results in the first round of tests - which is intensity. This shows that rehabilitation of hearing, speech and language is very important for development of ability of perception and production of speech.

### 3 Conclusion

The results of this research project indicate a number of important elements in the field of perception and production of speech elements in subjects suffering from damaged reception and processing of information. The level of hearing impairment evidently affects the perception and speech production, but it has no decisive significance for development or lack of development of speech and language. These subjects show that even at the minimal level of hearing remnants, e.g. the first group, it is possible to perceive both the basic features of sounds and produce them. This is a solid auditive foundation for development of speech language. Auditive attention can be directed as any other attention. This is very important for children with hearing impairment. Those subjects with smaller hearing remnants require more intensive work than those with better hearing. In certain cases these remnants are so small that they are called islands of hearing, but even these islands are sufficient to enable the child to get an impression of sound with help of Ksafa-m machine, i.e. its duration, intensity and voiced/voiceless quality.

The findings show that children with impaired hearing achieve best results in perception of duration, voiced/voiceless quality, and poorest results in perception of intensity. This means that children with hearing impairment are able to acquire the form and shape of a sound or a word in the form of suprasegments through a relatively short period of rehabilitation, whereas the structure or contents manifest in perception of subtle distinctive features of certain groups of sounds (fricatives, plosives...) are built over this prosodic base. Development of speech

in children with normal hearing goes along the same lines, the only difference being spontaneity of the process in comparison to planned and targeted work aiming at development of speech processes [7].

The younger group of subjects achieved poorer results than the older group of subjects, which is quite predictable and logical if take into account the process of maturation of the central nervous system.

The significance and successfulness of rehabilitation in the process of development of auditive attention, speech and language is reflected in two groups of the data obtained, namely duration of the rehabilitation process and improvements achieved over the course of six months of rehabilitation which was a part of the project. The results show that the best results were achieved by subjects who spent four years in rehabilitation and the poorest results by those who spent two years in rehabilitation.

The difference between results obtained in the first and second round of tests is statistically significant for all examined parameters. This confirms necessity of early auditive rehabilitation even in cases with the smallest hearing remnants, because this is the only way to develop true and authentic impression of sound. We must not deprive them of this option, because we could help them expand the wealth of their

of experience and cognition with one of the most precious gifts from the nature.

## References

- [1] G.J. Herder, *Abhandlung über den Ursprung der Sprache* (Philipp Reclam Jun. Stuttgart 1979).
- [2] A.S. Vygotski, *Thought and Speech* (IPS, Moscow, 1956), in Russian.
- [3] A.R. Luria, *Fundamentals of Neuropsychology* (Moscow State University, Moscow, 1973), in Russian.
- [4] A.R. Luria, *Fundamental Problems in Neurolinguistics* (Moscow State University, Moscow, 1975), in Russian.
- [5] Đ. Kostić, *Speech and Child With Hearing Impairment* (Kulturni centar, Gornji Milanovac, 1980), in Serbian.
- [6] Ž. Vlajić, *Methodics of Work with Speech Impaired* (Zavod za udžbenike i nastavna sredstva, Beograd, 1993), in Serbian..
- [7] D. Crystal, *The Cambridge Encyclopedia of Language* (Cambridge University Press, Cambridge, 1987).

## THE LANGUAGE AND CONSCIOUSNESS IN SPLIT-BRAIN PATIENTS: REVISITED

Tatjana Đurović

Faculty of Economics, Department of Foreign Languages, University of Belgrade, Yugoslavia

**Abstract.** The paper deals with the theoretical re-examination of the split-brain patients and the ensuing consequences both on language and consciousness. It has been known for quite a long period of time that certain regions in the brain are responsible for language. Therefore, the neurophysiological aspects of language are presented first. Since one of the techniques used to determine the (non) linguistic capabilities of the two brain halves are split-brain experiments, the link between the brain and language is further investigated. Apart from language, the brain, or rather some of its parts, also provides for consciousness, that is, the state of our mental awareness. Thus we establish the mutual link between the brain, language and consciousness where the brain has somewhat honorary position since it generates both language and consciousness. Finally, we try to prove the justification of this link returning again to the split-brain patients who confront us with the question: In case of the split brain and language, are our minds split as well?

**Key words:** *split-brain experiments, brain, language, consciousness.*

### 1 Introduction

The ultimate purpose of the brain - mind relationship, that is, the relationship between the brain, its structures and processes on the one hand, and mental states on the other. Far from being positive as to reaching some firm conclusions, but not being absolutely negative as to proposing some tentative statements, we share the opinions of those authors who ventured to tackle this complex relationship and think that every possible consideration about the brain-mind problem will surely mean one step further. The link between the brain and mind is so sophisticated that just one scientific approach to it, will not suffice. Only the efforts, knowledge and results from seemingly disparate scientific fields such as neurology, linguistics, physics, or psychology to mention just a few "pure" sciences can get us closer to better understanding of the man, his capacity for language, and his consciousness, as the highest mental faculty of the human beings.

Certain parts of the brain are responsible for both language generation and processing. It is language that distinguishes us from other living beings and represents our very unique feature.

It is not only language, however, that makes us remarkable in our existence. The mental awareness, or

the state of our consciousness, is, as pointed out above, just as unique as the capacity for language itself. But at this very spot, when the topic of consciousness has been raised, one find himself both baffled and fascinated, because every neuroscientist (the one who deals with the brain-mind issue from this or that scientific point of view) gives his own definition of consciousness. Moreover, the neutral observer gets the impression that not a single definition would ever be proposed. Partly because the mind matters are so exceedingly difficult and most of the definite solutions lie fathoms under waiting to be discovered, partly because every scientist considers the relationship in question from a specific angle, due to his specific experience, experiments, and ideas.

Therefore, we will try to shed another light on the specific brain-mind link. In other words, the split-brain studies provide us with the angle from which we would try to bring into relationship the brain, mind which has its seat in some parts of the brain, or at least is thought so, and language, firstly because it also represents the output of the brain mechanisms, and secondly, because it is believed that it serves to give verbalisation to our mind, that is, language is the embodiment of our mental states. (We don't plead, of course, that consciousness could always be expressed in language. We are speechlessly aware of many events and processes more often than not). Why the split-brain operations anyway? The reasons are twofold. The first line of reasoning is that splitting the two hemispheres of the brain apart, the full capacity or incapacity for language becomes fully noticeable. The second reason is derived from the first one (although, it is fully justifiable to look at the matter the other way round), and this is the mental issue concerned, or rather, whether the split hemispheres mean the splitting consciousness as well. It seems that by way of this radical medical treatment (cutting the way of information transfer between the two halves of the brain) both hemispheres are free to demonstrate their full contribution not only to language but to higher cognitive functions as well.

### 2 Neurophysiology and Language

Geschwind [1] wrote some thirty years ago that language is some "special gift of a man" and summarised views about it in two different categories:



“There is nothing qualitatively distinctive about human language; man only possesses *more* language than lower animals.” The opposite view is that “*Only* man has language”. In order to emphasise the differences between man and non-human living beings we will give a short overview of language centers in the brain (which are, naturally, not examined thoroughly).

It has been firmly established that the nervous systems of all animals have some basic functions in common - the control of movement and the analysis of sensation. But the human brain is capable of learning, the most notable example is language, which man does not share with any other animal. (Beside language, music is also universal in man). These higher functions are governed by some regions of the brain. We can think of the brain not to be a monolithic organ, but rather, a group of organs, each of them having its own function and anatomy.

Whitaker [2] divided the cortical language areas into four central and four peripheral language systems. Central language areas fall into *Wernicke’s Area*, *Naming Center*, *Supramarginal Gyrus*, and *Arcuate Fasciculus*. Peripheral language systems are broken down into two subsystems: two subsystems for speech production - *Broca’s Area* and *Exner’s Center*, and two for speech recognition - *Heschl’s Gyrus* and *Angular Gyrus* (Fig. 1).

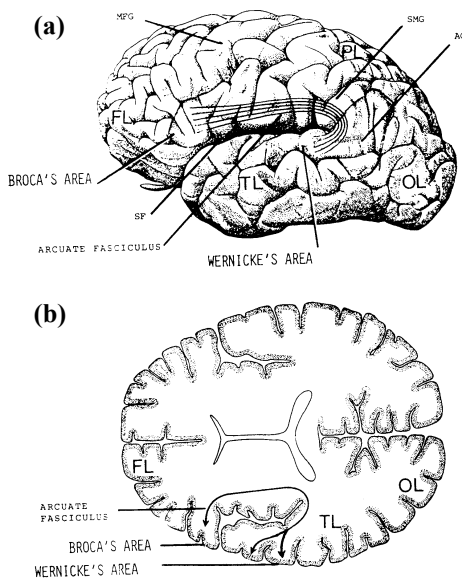

**Figure 1** The Principal Speech Regions of the Human Brain Lamendella [3]: (a) Lateral view of the dominant (left) cerebral hemisphere; (b) Horizontal view of both the left and the right cerebral hemispheres; (FL = Frontal Lobe, TL = Temporal Lobe, PL = Parietal Lobe, OL = Occipital Lobe, SF = Sylvian Fissure, SMG = Supramarginal Gyrus, AG = Angular Gyrus, MFG = Middle Frontal Gyrus)

Virtually everything we know about the organisation of language in the human brain has been learned from pathological conditions or under some pathological circumstances (such as brain injuries or the effects of drugs on brains, to mention some of

them). Thus we know that damages to Broca’s Area (Brodmann areas 44, 45, Fig. 2) also called the anterior language area, lead to *aphasia* or disorders of speech. More importantly, Broca determined (in 1860’s) that these disorders were associated with lesions on the left side of the brain while similar damages to the corresponding right side, left the speech intact. Broca’s Area lies just near the motor cortex, which controls the speech muscles and that is the reason why the lesions of Broca’s Area result in *apraxia*, or disorders of articulation (poor speech, slow articulation). Broca’s speech has also been called “telegraphic speech” since small grammatical words and the endings of nouns and verbs are omitted. Nevertheless, the patient with Broca’s aphasia retains the ability to understand spoken language.

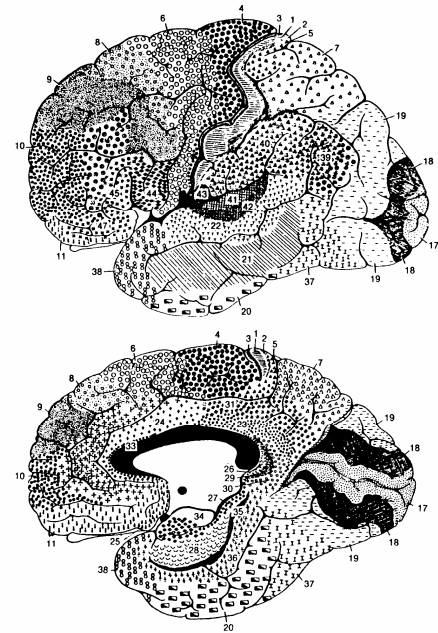

**Figure 2** Brodmann’s cytoarchitectural map of the human brain. The various areas are labelled with different symbols and their numbers indicated by figures. Upper drawing is lateral view of left hemisphere, and lower is medial view of right hemisphere (Eccles, [4a]).

A much more important language area and a quite different aphasia described for that matter, is Wernicke’s Area. Wernicke’s Area lies between Heschl’s Gyrus, which is the primary receiver of auditory stimuli, and the Angular Gyrus, which belongs to Brodmann area 39 and is responsible for visual reception - lesions cause *alexia* (disorder in connection with reading) and *agraphia* (disorders in writing). Wernicke’s Area is associated with the ideational aspect of speech. In the aphasia of Wernicke’s type the speech is phonetically, even grammatically correct, but semantically is remarkably devoid of content. Even when the usage of words is correct (which is rarely the case) Wernicke’s speech is, in fact, a nonsense jargon (“salad of words”).

Exner’s Center, situated just above Broca’s Area, is responsible for writing since destruction of this

center leads to agraphia. Finally, we shall point out the Arcuate Fasciculus, which presents a bundle of nerve fibers connecting Wernicke's Area and Broca's Area. Lesions of the Arcuate Fasciculus result in conduction aphasia - comprehension of spoken language, but a gross defect in its repetition and in normal speaking.

The above-mentioned functional specialization of the brain has been associated only with the left side of the brain, because it has been determined that the corresponding areas on the right side do not exhibit the same linguistic competence. It seems that the right hemisphere has some other specialized abilities, including some aspects of music and of complex patterns. But Geschwind [5] warns that "the anatomical regions associated with these faculties, however, are not as well defined as the language areas. Even in the left hemisphere the assignment of functions to sites in the cortex is only approximate: some areas may have functions in addition to those indicated, and some functions may be carried out in more than one place."

Beside the cortical language regions performance of the subcortical regions is also necessary for language functioning. Thus, cerebellum is important for the coordination of the whole process of language production; limbic system is indispensable for non-verbal communication, and thalamus, the last, but mostly important, is directly involved in the speech production.

Having analyzed the above mentioned defects of some of the brain areas Wernicke proposed a model of language production in the brain, which, although more than 100 years have passed, could be accepted as still valid. According to this model the basic structure of an utterance is connected with Wernicke's Area. Through the Arcuate Fasciculus it is transferred to Broca's Area in which a thorough plan for vocalization is generated. Since Broca's Area is adjacent to the face area of the motor cortex, the plan starts the work of the muscles of the face, the tongue, the larynx and so on. We have already said that Wernicke's Area is most responsible for language comprehension in reading and writing, not only in speaking. When we hear a word, the sound of it is first received in the primary auditory cortex, but soon after it must be transferred to Wernicke's Area if we want to understand it as a verbal message. When we read a word, the visual pattern is transferred to the Angular Gyrus, which transforms the word into the auditory form to be read in Wernicke's Area. Writing a word calls for the same neural pathways but in the opposite direction: from the auditory cortex to Wernicke's Area to the Angular Gyrus (Fig. 3).

There are at present five distinct approaches to language-brain relationships [6]. They fall into: (1) stimulation of the brain, or, in other words experiments on exposed brains carried out by Penfield and Roberts; (2) recording neurophysiological correlates of language - a technique which is in use today is the measurement of "event-related potentials"

and involves recording of normal electrical activity of the brain; (3) anesthetization of a single hemisphere-by injecting sodium amytal (barbiturate) into the internal carotid artery which supplies blood to the particular hemisphere; (4) metabolic scanning-the two techniques are very much in use, the measurement of regional cerebral blood flow and Positron Emission Tomography. Eventually, (5) lateralized stimulus presentation, which in contrast to the previously mentioned techniques permits investigation with healthy subjects and does not use elaborate and expensive equipment. These lateralized stimulus presentations are used widely in psychological laboratories. The most significant technique is the dichotic listening task, which stems from the neuroanatomical organisation of the brain, that is contralateral neural pathways (the left side of the brain directly receives visual information from the right visual field and auditory information coming from the right ear, and the opposite, for the right brain side), as well as ipsilateral pathways when the information received in the right visual field is sent out to the right hemisphere; the opposite is true for the left side of the brain. Using the stimuli in this way it is possible to determine which hemisphere - dominant or non-dominant one - will first be activated. Often in case of normal right-handers, the identification or processing of stimuli are more accurately and quickly carried out when they are presented to the right eye or the right ear.

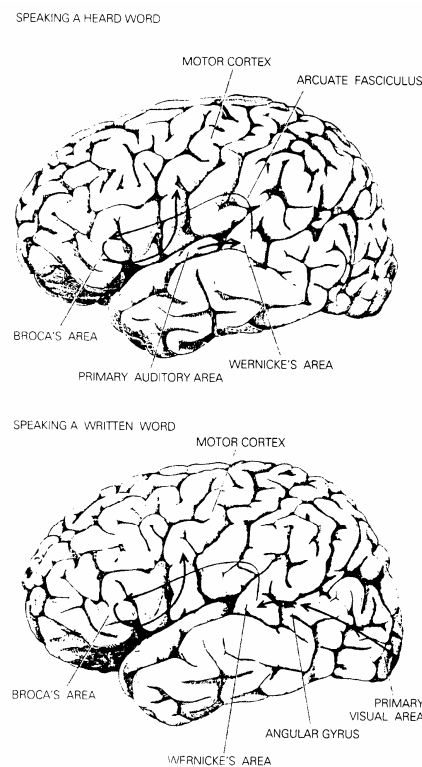

**Figure 3** Wernicke's model of language production in the brain (Geschwind, [5]).

At this very spot we wish to relate the split-brain experiments to the previous technique, i.e. dichotic

listening tasks. We have seen what happens during normal states of patients when stimuli projected either to the right ear or to the left ear are equally transmitted to both hemispheres. Due to stronger contralateral connections, stimuli are better processed in the left hemisphere (rarely in the right hemisphere). It is now very interesting to see what happens when the major fiber tract, which connects the two hemispheres, the corpus callosum, is surgically cut. It follows that stimuli are transmitted to both hemispheres no more, at least, not by the usual transmission channels of the corpus callosum. In that way, the patient's response to a unilateral stimulus seems to be again primarily a function of the opposite hemisphere. The full contribution of each hemisphere in language and other psychological functions could be made by unilateral stimulus presentation in split-brain patients.

### 3 The Language and Consciousness Aspects in Split-Brain Patients

It has been known that the brain is a tissue, very complex and puzzling though, and like any tissue it is composed of cells. Of course, these are highly specialized cells, but monitoring the results obtained from different studies, these cells function according to some laws that are applicable to any other cells. In other words, the brain can be studied in the similar way as some other organ of our body.

The real problem is how to understand the brain (which is, unfortunately and this is not a cliché, far from any definite answers). Or, to put in David H. Hubel's [7] words: "Can the brain *understand* the brain? Can it *understand* the mind?" Consciousness can even be sometimes used to stand for the brain but then the previous questions become even harder.

What is consciousness and where it is really situated are questions to which every serious neuroscientist has his/her particular definition. What is more, it seems that there is little agreement of opinions for so extremely important phenomenon. Gazzaniga [8] wrote that according to Sperry [8a], consciousness is an "emergent property of cerebral activity... and is an integral component of the brain processes...". Thus he surely places the consciousness in the brain, but where it is really seated in the brain and what its mechanisms are still leave us with no definite answers.

However, it is known that not all parts of the brain equally participate in the manifestation of consciousness. Penrose [9] in search of the answer where consciousness is situated proposes several regions. He thinks that the phenomenon of consciousness is surely much more associated with the cerebrum than with the cerebellum, since the latter seems to act as a kind of "automaton" of whose actions one does not have to have awareness (for example, motor activities such as walking and our unconscious detailed plan of muscle movements needed for controlled motion). Investigations done by

Penfield as evidenced in numerous brain operations on conscious subjects reveal that maybe the "seat of consciousness" is not associated with cerebral activity, but rather with the activities of some subcortical regions such as thalamus and the midbrain. Nevertheless, these regions are in communication with some regions of the cerebral cortex, and Penfield stated that "conscious awareness" would emerge only when this region of upper-brain stem is brought into direct connection with the appropriate region of the cerebrum.

Some other neuropsychologists (Moruzzi & Magoun) according to Penrose [9] situated consciousness in reticular formation, which is indeed responsible for the general state of alertness of the brain. In case of damage, unconsciousness will occur. Two strong objections have been raised: the first is the phenomenon of dreaming, where in cases of awareness of the dream, parts of the reticular formation which are normally active act as though they were not active; the second objective is that the reticular formation, viewed from evolutionary aspects, presents the ancient part of the brain so that one can be tempted to conclude that some animals, such as frogs, also have consciousness. (This last sentence contains significant controversy which we due to the length of the paper have to put aside). Another author, O'Keefe puts the conscious state into the hippocampus, which is indeed responsible for long-term memories, which are, then, associated with consciousness.

On the other hand, in the opinion of many philosophers and psychologists, consciousness is in link with human language [9]: "... it is only by virtue of our linguistic abilities that we can attain a subtlety of thinking that is the very hallmark of our humanity - and the expression of our very souls ... it is language that allows us to philosophize and to describe how we feel, so we may convince others that we possess awareness of the outside world and are aware also of ourselves. From this viewpoint, our language is taken to be the key ingredient of our possession of consciousness".

What is the link between consciousness and language? We will tentatively answer: both direct and indirect one. Direct link is manifested in the fact that we really become aware of our mental states when we give them verbal/linguistic properties. Indirect link is the brain, since it generates both the language and consciousness. Language is in great majority of people situated in the left side of the brain. Does it mean that the consciousness is then in correlation only with the left hemisphere, and consequently not with the right? In order to indicate the complexity and significance of these questions especially in today's brain sciences we will synthesize the opinions of two authors about the dilemma in question: the relationship between mind, the brain and language, as evidenced in split-brain patients - Sir John Eccles and Michael Gazzaniga.

The split-brain experiments or commissurotomy experiments provide perhaps the richest source of

information on specific aspects of language of both the right and left hemispheres. As a neurological technique intended to give relief of epilepsy by cutting 200 million fibers of corpus callosum, the neural bridge between our right and left halves of the brain, commissurotomy has provided experimentalists with a unique opportunity to examine the abilities for language of two hemispheres respectively.

The surgical technique of commissurotomy was first introduced by Van Wagenen and Herren in 1940. The crucial step came in 1962 when Joseph Bogen and P.J. Vogel decided to operate a forty-eight-year-old war veteran, who could not even recover from one epileptic seizure before another one would start. The authors who have made famous the above mentioned daring operation are Sperry and his student, Gazzaniga.

Although the disconnection syndrome in commissurotomy subjects raises questions from various aspects it undoubtedly lends support to the striking differences between abilities of the two hemispheres to process language. In one of the experiments responses to visual stimulation were tested. Data were visually presented (the so-called tachistoscopic tests) to one or other visual half-field while the subject focused on a central point on a board. Visual stimuli were flashed in duration of tenth of a second in order to prevent eye movements from inadvertent deviating of visual data to the other half of the visual field. When asked what they had seen, the patients were able to report only when the lights had been flashed in the right half of the visual fields, but not the other way round. Namely, when lights were flashed only in the left visual half-field, the patients denied that they had seen any lights. Since the visual paths in the brain are crossed ones (the same as auditory paths), so that the right side of the visual field is projected to the left hemisphere of the brain, while the left visual field is projected to the right hemisphere, the patients were able to express in language what they had seen only if stimuli had been presented to the right visual field (Fig. 4). Because of that, Gazzaniga concluded that the left hemisphere is the dominant hemisphere for language; the patients were able to deal with the information visually presented to the right field both orally and in writing. "They were able to read out written messages and to perform problems in calculation that were presented to the left hemisphere" [10]. While the left hemisphere was termed dominant, the right hemisphere was called minor by depriving it of any capabilities to express itself linguistically, both in speaking or writing. "A picture transmitted to the right hemisphere evoked either a haphazard guess or no verbal response at all" [10]. The findings of these early split-brain patients even made Geschwind call the right hemisphere blind or deaf for language.

Gazzaniga and Sperry have soon tried another kind of experiments. Changing the angle of testing, it turned out that the right procedure, which would give

some results, should be exposure to stimuli by giving non-verbal responses in order to assess the linguistic capabilities of, in this case, the right hemisphere. Instead of requiring that the patient should identify the stimuli verbally, he now had to either point to a picture of the stimulus or find it with his left hand among other various objects which were behind the slot, hidden from sight.

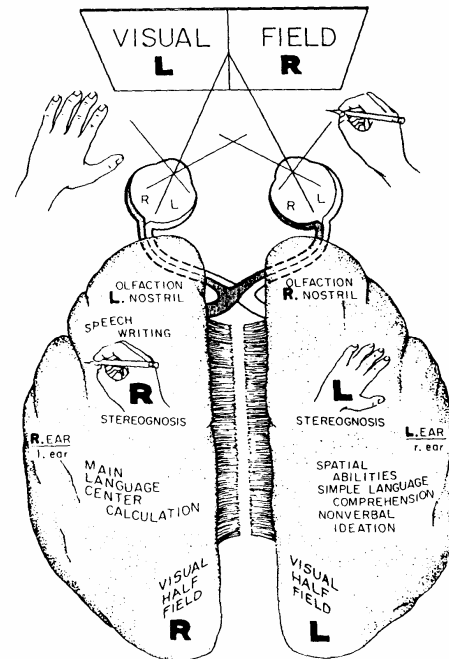

**Figure 4** Schema showing the way in which the left and right visual fields are projected onto the right and left visual cortices, respectively, due to the partial decussation in the optic chiasma. The schema also shows other sensory inputs from right limbs to the left hemisphere and that from left limbs to the right hemisphere. Similarly, hearing is largely crossed in its input, but olfaction is ipsilateral. The programming of the right hand in writing is shown pictorially to come from the left hemisphere (Eccles, [4b]).

For example, if the word "spoon" was flashed to the left visual field the subject was able to point to the picture of a spoon with his left hand. Furthermore, it has been proved that the right brain could make some complex mental associations, as in the example when the subject was shown a picture of a cigarette and he responded by picking out an ashtray with his left hand among ten other objects not related to cigarettes. One experimenter, Sugishita, revealed that the right brain can make four out of five kinds of mental associations [11a]. For example, an acallosal (N.G.), after picking out a plastic spoon with her left hand behind the slot, could choose "fork" - coordinate association, "soup" - contingent, "silverware" - superordinate, and "cook" - occupation, among similar words from lists. But she was not able to make an abstract association. She chose "truth", but not "nutrition" as the abstract word associated with the spoon. Nevertheless, while the subjects were holding the spoon or the ashtray in their left hands, they were not able to name or describe either the object or the picture. Therefore, Gazzaniga

concluded: "Evidently the left hemisphere was completely divorced, in perception and knowledge, from the right."

Some other tests have shown that a certain amount of language comprehension could be attributed to the right hemisphere. When the subject correctly picked out the required word among other unseen objects, although he was not able to say its name or describe it, he could later point to a card where the name of the required object was written. Simple words can even be spelt when flashed in the left visual field by using letter cutouts screened from the subject. But the spelt words cannot be pronounced. In one interesting test the word HE/ART was flashed on the screen with the line in the middle as indicated. HE portion was flashed to the left visual field while ART portion to the right. The speech left hemisphere said it had seen ART, but when asked to point with his left hand the word the subject had seen he pointed to HE rather than ART. "The experiment showed clearly that both hemispheres had simultaneously observed the portions of the word available to them and that in this particular case the right hemisphere, when it had had the opportunity to express itself, had prevailed over the left." [10]

Zaidel using the optical device he himself developed which blocks half of the visual field no matter how the subject moves his eyes, proposed that although the right brain cannot express itself verbally, it is able to understand a large number of words. By the aid of the mentioned device picture vocabulary tests were given to test the abilities of each hemisphere separately. "However, it is sometimes difficult to get the left brain to sit back and be quiet, since the left brain sees nothing but darkness while the right brain is being tested. The lower score /of the right hemisphere/ typifies what happens when the left brain seizes control and makes guesses because it feels that the right brain doesn't know what it is doing." [11b]

Word recognition, however, in case of the right hemisphere is restricted to common words and sometimes a few verbs. Still, this recognition reveals that the right hemisphere has considerable language comprehension when more complex definitions are projected, such as "measuring instrument" for ruler, for instance. But the ability to recognize and understand words, even simple sentences does not mean that the right hemisphere can create sentences. In an experiment when a subject had to complete the sentence "Mother loves..." he at random chose "baby". The explanation is that the minor hemisphere (the same experiment was done with chimpanzees with similar results) does not have a Wernicke's Area which provides the necessary semantic abilities. Therefore, expressive language of the right brain has not been evidenced in split-brain patients. If there is no conflict in understanding of speech simultaneously by both hemispheres surely there will be some if they both would try to express themselves at the same time.

Although one patient (P.S.) was reported by Gazzaniga to have considerable expressive language in his right hemisphere (however, it was assumed that this rich language expression of the right brain was due to early damage to the left hemisphere of P.S.), one exception to the monopoly of the left hemisphere when verbal expression is concerned could be cursing and other short emotional exclamations associated with automatic aspect of language.

Beside remarkable discoveries concerning language (in) capabilities of both hemispheres, split-brain subjects have revealed intriguing facts about the state of our mental/conscious awareness. Most surprisingly, the patients who underwent the brain-splitting operations did not seriously show impairment of mental functions; moreover, they behaved at the first glance as perfectly normal, healthy beings. The experimenters were met, then, with questions of far-reaching consequences - can the transfer of information be effected without corpus callosum as a link between our brain halves, is it possible that the two hemispheres can perform their operations without being informed what is going on in the other. If we ask ourselves: can we have a man with two minds, each with its respective stream of consciousness, our answer can be both "yes" and "no". If we state that only language is an ingredient of consciousness then we do not have splitting mind, since the language hemisphere is only the left hemisphere, or rather, the dominant hemisphere. Changing the angle of looking at matters and not holding language the sole component of our mental states we can assume then that we have two separate conscious minds. But again, are we speaking of consciousness as it is, or about self-consciousness? Do we know that hemispheric transfer could be effected over some subcortical structures which are not split? What about the problem of cross-cueing between hemispheres if not by way of contralateral neural pathways then by way of, though weaker, ipsilateral pathways? Are there some physical ways based on wave function that can provide this phenomenon? These questions complicate the matter further and we are still left with a puzzle.

Both Sperry and Gazzaniga state firmly that "... in the split-brain syndrome we deal with two separate spheres of conscious awareness, i.e. two separate conscious entities or minds ... each with its own sensations, perceptions, cognitive processes, learning experiences, memories..." [11c]. The minor, right hemisphere is surely a superior brain showing its remarkable stereognosis and pattern recognition abilities, even understanding of some common nouns and simple sentences. Nevertheless, the patient does not have any conscious experience of goings-on in that hemisphere, "except by delayed and very diffuse pathways in the brain, or by sensory recognition of movements brought about by the minor hemisphere" [4c]. (Moreover, Eccles described linguistic capacity of the right hemisphere as "automatism".) Yet, we cannot discard the matter so lightly. If we plead that

only the left hemisphere has consciousness since it gives verbal content to it, in an experiment with the previously mentioned patient, P.S. his right hemisphere learned to speak as well. Under strict laboratory conditions where a series of questions could be visually presented only to the right hemisphere P.S. could say his name, describe his mood, and name his favorite hobby. Therefore, both hemispheres were conscious. Most surprisingly it seems they were separately conscious since in naming occupational choice the right hemisphere spelled "automobile race" although his left hemisphere said he wanted to be a draftsman. P.S. clearly shows that human consciousness could be split and perhaps doubled by split-brain surgery. Of course, any firm conclusions based only on one case are hard to be reached. Maybe if it could be found which neural substrates distinguish his right hemisphere from the right hemisphere of other split-brain patients we could have some notions about the nature of our conscious processes.

If we return to the question of contribution of verbal system to consciousness (we have seen that P.S. could spell his answers to verbally stated questions), Gazzaniga thinks then that "the person is engaged in much more activity than can possibly enter consciousness at once, and ... much of what does enter is what is registered by the verbal system. It is the one system that is capable of continuously monitoring our overt behavioral activities ... we believe that the verbal system provides for a personal sense of conscious reality" [8b]. Therefore, on the basis of experiments with P.S. in which commands were known only to his right hemisphere and afterwards vocalized by the left hemisphere, Gazzaniga concluded that the left hemisphere could not have consciousness of what was going on in the right hemisphere and thus it produced answers only by conjectures attributing cause to the action. Our verbal self looks out and sees what a person is doing, and interprets reality accordingly. In other words, Gazzaniga thinks that our mind is not a psychological entity but a sociological one, which is composed of many "submental states". We have so many "selves" - verbal, emotional, perceptual which don't have to have a knowledge of one another internally. The verbal system has its own way of processing information, and other mental systems have their respective ways of doing that. Therefore, we have many conscious states which are latently present but of which we are not consciously aware, except in case of our verbal consciousness. It follows that the right hemisphere has its own consciousness with its specific mental states, which are sometimes in accord with the mental states of the left hemisphere, sometimes in conflict. All these states of mental awareness come together in one - verbal or linguistic consciousness which makes the uniqueness every one of us.

Theoretically, we may raise objection here and ask ourselves as Penrose did: which consciousness - the

left or the right, is the consciousness of split-brain patients before the operation, when they had a single consciousness? Still further, what if by some technique these cut nerve fibers could be brought together and again have one-consciousness man? What would be conscious experience of a person who once had two minds in one body?

On the other hand, Eccles thinks that even before the surgical removal of the corpus callosum the patient does not have any direct conscious experience of the goings-on in the minor hemisphere. It is hard to talk about the consciousness of the other half of the brain since its activities are surgically isolated from those cerebral areas that are linked with the conscious self. The right hemisphere is surely superior to non-human brains according to abilities it excels. Still, regarding its conscious awareness it is somewhat dissonant with the dominant hemisphere. In order to show explicitly Eccles' hypothesis we'll present a diagram which is not in fact originally associated with split-brain patients but rather with the cases of intact brains. Yet, it is our opinion it could be applied to split-brain patients as well (Fig. 5).

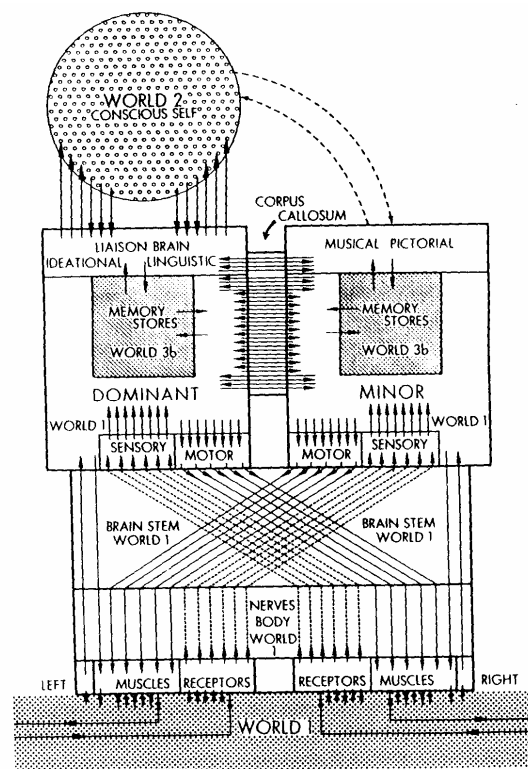

Figure 5 Modes of interaction between hemispheres (Eccles, [4d]).

## 4 Discussion

It has been previously postulated that in case of split-brain operations the state of mental awareness of subjects arises only in connection with neural activities in the dominant hemisphere. Eccles calls this

ability of the dominant hemisphere ability for self-consciousness or conscious self. Since he terms the minor hemisphere conscious hemisphere he does not deny that the minor hemisphere could have conscious awareness as well. But as can be seen even on taxonomy level, we are talking about two different states: self-consciousness and consciousness. If we suppose that the normal subject is consciously aware of all the goings-on in his minor hemisphere only after their transfer to the dominant hemisphere, i.e. to the conscious-self mind does it mean that in cases of the removal of the corpus callosum the conscious self does not have an access to the neural activities of the minor hemisphere? It should be noted, however, that information transfer via corpus callosum is in no case one-way transfer, but, rather sophisticated transmission between the two hemispheres in both directions. We can presume, though, that there are maybe the same pieces of information in both hemispheres, and the dominant one chooses that information which is worth to be vocalized. Self-consciousness is not something which is necessarily situated in the left hemisphere. (We do not even know where it is really seated). Yet, the experiments with split-brain patients serve as justification of the idea of dual minds, whereas the left hemisphere is in direct link with the self-conscious mind, while the right hemisphere is not under the control of self-conscious mind. So, the left hemisphere or the dominant one has both consciousness and self-consciousness, while the right hemisphere or minor one has only consciousness. We can hypothesize that even in cases of intact brains the corpus callosum is mediator of consciousness only, not self-consciousness. We further assume that self-consciousness is remnant of much higher structures of consciousness, something so unique that it would be inconvenient, even blasphemous to reside in two places. The minor hemisphere can be in relationship with mind but not with self-conscious mind. A considerable number of experiments done with split-brain patients revealed that although the minor hemisphere did not lack insight and intelligence it could not be associated with self-consciousness of the dominant hemisphere as reported by conscious subjects. It could also be evidenced in experiments which showed that subject had the conscious, voluntary motor control, while the motor movements of the right hemisphere were done thoughtlessly.

We can't help mentioning here that maybe during the period of brain plasticity when it is supposed that the two hemispheres could freely exchange their functions, including language, it could be tentatively concluded that self-consciousness resided in the right hemisphere as well. Due to the hemispheric specialization when linguistic functions are in most people firmly established in the left hemisphere, we can assume that self-consciousness also becomes located virtually in one site. Perhaps it still latently exists in the right hemisphere, but the right

hemisphere being deficient in major linguistic centers cannot report it.

## 5 Conclusion

Many questions concerning the complementary cognitive styles and conscious awareness brought to light by commissurotomed patients remain still unanswered. The conclusions derived from some of the experiments described indicate that neither hemisphere has the monopoly of either linguistic or non-linguistic, conscious or unconscious abilities complete, and cerebral specialization is rather a matter of degree. The brain, although unique in its existence, is empowered to participate in social and cultural environment by two complementary conscious systems, which in cases of split-brain patients act rather as two competing conscious systems, each hemisphere trying to compete for control over the other. Therefore, sometimes a person becomes aware of logical-analytic control system of the left hemisphere, sometimes of global-synthetic control system of the right hemisphere. This does not indicate two simultaneous streams of consciousness; this only means that sometimes consciousness of the left hemisphere holds reins, sometimes consciousness of the right hemisphere.

Split-brain patients are not in sharp contrast with normal, healthy people. Although a healthy man in his conscious behavior uses the faculties of both hemispheres together, not premeditating whose cognitive style he is employing, there could be some situations characterized by his social environment that put him "in two minds" what to do. In this way he acts rather similarly to a split-brain man. The question is again a matter of degree since a split-brain man will have to face the choice between severe right or left hemispheric approach which sometimes could prevent him to select right strategies to a given situation. Most importantly, the unity and continuous character of consciousness remain preserved. It can only vary in its content from time to time, depending on which hemisphere takes conscious control. In healthy, normal beings as well as in split-brain subjects there is a constant generation of dynamic, both cooperative and competing, partnership between the intuitive, creative, "unconscious" side of the minor hemisphere, and analytical, rational, conscious side of the dominant hemisphere. Incorporating the third element of our triad, language, the relationship between the brain, mind and language could be viewed as one big interaction, both direct and indirect.

"The problem of how the mind relates to the brain stands as the greatest challenge to a scientific age which seeks an objective explanation for all nature. Our physicalist world view and our pragmatic approach to social problems may both be transformed by significant discoveries concerning the way human experience and human social consciousness arise in cerebral activity", it was written as an introduction to

“Split-brain and the mind” part in one of the companions to medicine. The work with split-brain patients exactly has provided the most fascinating results of the functioning of the human brain and its relationship to language and conscious experience. “... the extraordinary implications of this work for the self-brain problem have not yet been fully realized by philosophers and scientists. This has occurred because the climate of opinion is not yet ready for a searching evaluation of these most surprising and revolutionary results”, wrote Eccles in 1977. His words have not lost their scientific vigor even twenty years after.

## References

- [1] Geschwind, N. “The Development of the Brain and the Evolution of Language” in Geschwind, N. *Selected Papers On Language And The Brain*, (D. Reidel, Dordrecht) (1974), p. 89.
- [2] Whitaker, A.H. *On The Representation Of Language In The Human Brain*. (UCLA Working Papers in Phonetics 12. Los Angeles, California) (1969).
- [3] Lamendella, J.T. “The Neurofunctional Basis of Pattern Practice”. *TESOL Quarterly* Vol. 13, No. 1 (1979), pp. 5-19.
- [4] Eccles, J. Part II in Popper, K.R. and Eccles, J.C. *The Self And Its Brain*, (Routledge & Kegan Paul, London) (1977), pp. a) 234, b) 319, c) 316, d) 375.
- [5] Geschwind, N. “Specializations of the Human Brain”. *Scientific American* 241, (1979), pp. 158-168.
- [6] Caplan, D. *Neurolinguistics And Linguistic Aphasiology. An Introduction*. (Cambridge University Press, Cambridge) (1987), pp. 27-33.
- [7] Hubel, D.H. “The Brain”. *Scientific American* 241, (1979), pp. 39-46.
- [8] Gazzaniga, M.S. and LeDoux, E.J. *The Integrated Mind*, (Plenum Press, New York & London) (1978), pp. a) 141, b) 146.
- [9] Penrose, R. *The Emperor’s New Mind*, (Oxford University Press, New York. Oxford) (1989), pp. 381-384.
- [10] Gazzaniga, M.S. “The Split Brain in Man”. *Scientific American* 217, (1967), pp. 24-29.
- [11] Blakeslee, R. *The Right Brain: A New Understanding Of The Unconscious Mind And Its Creative Powers*. (Macmillan Education, Ltd, Houndmills & London) (1987), pp. a) 214, b) 131, c) 121.



# CREATIVITY: THE QUANTUM AND SUBCONSCIOUSNESS ASPECTS

Andrejs Dreimanis

Elizabetes 69-16A, LV-1050 Riga, Latvia

**Abstract.** The quantum and subconsciousness factors of creative act are considered and interpreted. The properties of stochasticity and chaos in the central nervous system (CNS) on different levels - from the neuronal membrane to cortical fields - predetermine the possibility to consider from the probability and quantum viewpoints the nature of creative act, in particular, its main - subconscious - elements: incubation and insight.

Stochastic elements of creativity, being especially important in subconscious stages of problem solving, can be represented by quantum physics and probabilistic logic concepts. The probabilistic character of quantum phenomena in the CNS, their uncertainty and unpredictability features are analyzed.

A qualitative jump in creative thinking process can be associated with a quantum tunneling act - with a jump of the thought into the classically forbidden region - a hardly accessible region in the frame of the classical logic.

The following hypothesis is proposed: the subconscious incubation stage is an actual stage calling forth generation of a qualitative jump in creative thinking process: the probability of insight arrival would grow with increasing of intensity and duration of thinking over the problem, due to elevated levels of neuronal network excitation and enhanced probabilities of redistribution of interneuronal connections.

A correlation between fluctuation phenomena in neuronal networks during dream sleep and creative insight during dreams is considered: specific for dream sleep pronounced chaos and fluctuations in neuronal activities promote emergence of discrete events - jump-like creative acts in subconscious stages of problem solving.

Possible mechanisms of control and stimulation of a human creative capabilities, associated with quantum macroscopic states in the CNS, are analyzed and probable routes of achieving of highly efficient creative state are indicated.

**Keywords:** *quantum phenomena, tunneling, subconscious processes, illumination, probabilistic effects, self-organization.*

## 1 Introduction

A permanent rise of complexity of our world and concomitant emergence of complex problems has called forth a necessity for appropriate creative approaches of proper solving of current actual problems: scientific-technological, socio-economical, ecological, psychological and other type.

On the other hand, in parallel with the current rise of forementioned complex problems, a recent striking progress of a new branch of physics - nonlinear physics, as well as concepts of quantum physics open a possibility to design an unified interdisciplinary

approach to analysis and revealing of nature of such highly complex objects as consciousness and creativity and, in particular, to clarifying of consciousness/subconsciousness and quantum aspects of creative phenomena.

A whole set of results of contemporary nonlinear science (especially - of modern nonlinear physics as well as of neuroscience) enables us to treat the multilevel and multistage phenomenon - creativity - from the viewpoint of synergetics - an interdisciplinary theory of chaos and formation of qualitatively novel structures and states.

To the present time, there exist several indications at the crucial role of self-organization (SO) as well as of chaotic and probabilistic features in creative acts [1-4] which, however, treat only separate some synergetical aspect of the creative act.

Below there is presented - on the basis of nonlinear and quantum physics concepts - a qualitative model of a creative thinking process, in particular, of: (1) basic subconscious stages of creative process, (2) interplay of subconscious and conscious creative phenomena, (3) features of subconscious creative processes during sleep, and (4) possible routes of stimulation of creative capabilities.

## 2 The Model Description

### 2.1 SO, Chaotic and Probabilistic Phenomena in the Brain

A whole set of results derived in the modern neuroscience indicate: SO is really a fundamental principle of structure and functioning of the brain:

(a) the human brain is the most complex creation of the nature: the amount of interacting neurons is of the order of 10 billions, but the number of synaptic connections - even by 4 orders greater;

(b) according to a theorem of statistical neurodynamics [5], the level of activity of a neuronal network (NN) is macroscopic state, but NNs themselves are capable of SO as well as of various kinds of information processing modes, including formation of concepts and associations;

(c) NMs of the brain possess the main properties, for a generalized net to be a self-organizing system: (i) a high level of complexity, (ii) functional redundancy,

(iii) distributiveness, (iv) hierarchical organization, and (v) multifunctionality;

(d) due to the genetically layed capability of growing neurons to self-organize [6], neural activity is capable of SO into dynamical patterns as well as to generate [7] a macroscopic value - the order parameter;

(e) such SO principles as cooperation, coherence and competition are manifested in existence of various brain rhythms - alpha, beta, delta, theta rhythms. Furthermore, coherence as manifestation of SO phenomenon in the central nervous system (CNS) is at the same time a quantum effect serving as a binding link in the conceptual chain: stability of neurons and their nets - SO of neural activity into macroscopic state - quantum nature of the thinking process [8].

Nowdays there exists a multitude of proofs of chaotic, probabilistic and quantum phenomena on various levels of the CNS - from the neuronal membrane to the cortical field levels [9-15] and even in consciouness manifestations [16-18] - which predetermine a possibilitu to consider - from the probability and quantum viewpoint - the nature of creative act.

## 2.2 A Possible Subconscious Mechanism of Creative Insight

Despite of slightly differing viewpoints at the definition of subconscious creative insight stage [19] we consider incubation and illumination as the key elements of the insight.

### *The origin of illumination*

A whole set of neuroscience and modern physics data enable to draw following proposal: basic mechanisms of illumination and incubation are to be associated with such synergetical phenomena and concepts as generation of dissipative structures, chaos and intermittency in neural assemblies. Various fluctuations which are inherent to macrosystems (also to NNs) and occur in parallel with probabilistic quantum-like phenomena on microscopic levels (in particularly - probabilistic character of action of synaptic boutons [15] and action potential trains), one can consider, according to nonequilibrium thermodynamics, as a basis of emergence of dissipative structures and states. The latter, in turn, can be regarded as qualitatively novel states in neuronal interconnection and activity patterns as well as novel modes of macroscopic neural activity, for example, of activity of formation of associations by NNs. Subsequent fixation of spontaneously and randomly arisen associations will signify the generation act of novel information.

Solutions of nonlinear equations for neural activity (of the logistic equation for the NN activity [9] as well as of the Duffing equation for coupled thalamo-cortical oscillations [14] can be represented in the form of various nonlinear structures including strange attractors (SAs). Concomitant transitions between

different (in the chaos level) SAs one can refer to spontaneously arising qualitative jump in the problem solving process - in particularly, to stochastic nature of emergence and synthesis of novel associations and, correspondingly, to arrival of illumination in the problem solving process. Such hypothesis, in particularly, conforms with the proposal [1] about the basic role of SAs in creating unpredictability as well as of novel information.

According to statistical mechanics of NNs [20], a random walking process between two attractors can be considered as a model of associations formation where the presence of fluctuations will promote transitions between attractors and generation of novel associations. Taking into account L. Zadeh thesis [21] about the elements of thinking as being the elements of fuzzy sets, one may suppose: stochasticity and probabilistic nature of inherent to the brain functions (in particularly, in subconscious stage) can be represented by the use the concepts of quantum mechanics and of probabilistic quantum logic [22,23] where "possibility" represents objective undecidedness of physical reality [23]. Thus, a qualitative jump in a creative thinking process can be associated with quantum tunneling act - a jump of the thought in the classically forbidden region which can be considered as a hardly accessible region from the classical theory approach. One can suppose: a creative illumination act is a quantum neurodynamics phenomenon where higher level brain functions and real macroscopic states emerge from processes on the quantum level and organizational constraints provided by the brain anatomy [17].

Furthermore, it is reasonable to suspect: the appearance of illumination is associated with some kind of macroscopic quantum behaviour in the CNS - a phenomenon which, according to the proposal of Domash [24], occur during transcendental meditation state, when phase correlations of localized regions lead to expansion of wave functions.

### *Interplay of chaos and order in the creative process*

In parallel with the essential role of chaotic and probabilistic neural phenomena in the arrival of illumination, as a basic tendency of a creative process can be considered a guided motion from chaos to the order [2], governing the activity of the whole complex system.

Such - already deterministic and conscious in its nature - process of organizational ordering of thoughts may succeed to purposeful guidance of the thinking proces and to constraining of the chaos level and reducing of entropy [25].

Likely, it should be superposition of order and chaos elements which ensures a creative process. So, a sufficient degree of fluctuations in neural ensembles could serve as a basis for a rise of novel information - taking into account that the amount of generated information increases with strengthening of fluctuations. In addition, a moderate chaos on various

hierarchical levels of the brain can destroy rigid thinking plans, thereby providing conditions for a rise of a broad spectrum of various versions of problem solutions, thus strengthening such SO elements as cooperation and competition (among various versions of solution) and providing the thinking process with evolutionary directedness. Besides, chaotic activity of NNs enables rapid transitions among various states of NNs [13], thus promoting creative information processing in the brain.

#### *The role of dreams in subconscious stage of the creative process*

The significance of chaos, unpredictability and fluctuations for the creative thinking process is soundly pronounced in the role of sleep and dreams in arrival of illumination. In view of the fact that during the Rapid Eye Movement (REM) sleep (essential for dreams sleep stage) thalamo-cortical oscillators are subjected to significant fluctuations which by exceeding the threshold level succeed to generation of SAs [11], as well as taking into account other chaos and noise manifestations in sleeping state [10,11,26] (in particular, indications at the 1/f noise during sleep [26]), one could propose: such specific for sleep pronounced chaos and fluctuations in neural activity promote creative acts in subconscious stage, in particular, an arrival of illumination during dreams.

#### *Incubation period*

The evolutionary nature of the creative problem solving process is soundly manifested in such intuitive subconscious component of creative thinking as incubation period. In the present time there exists a multitude of data showing the presence of intermittency at several hierarchical levels of the brain [9,10,27]. In one of its modes - selective forgetting [27] - the information being newly generated or coming from environment, forces out the previous one and, thus, provides forgetting of initial information (or the previous problem solving plan) during generation of qualitative novel structures. Due to existence of unstable fluctuations, the system in this case is ceased to depend on initial conditions as well as on initial information. By means of such turbulent-like forgetting, the information which has been dissipated over microstates, is jumped out and self-accumulated [28] causing already a macroscopic effect: generation of new information which reflects collective properties of the system.

### **2.3 Interplay of Subconscious and Conscious Stages**

On the basis of a series of arguments we can propose: the incubation period is really the stage calling forth generation of a qualitative jump in the creative thinking process - as the probability of illumination arrival would grow with increasing of duration and intensity of the thinking process (conscious as well as subconscious) over the problem.

According to statistical neurodynamics [5], the probability of formation of new interneuronal connections and modes and their subsequent SO into qualitatively new states of NNs increases with rising of excitation level of neural excitations.

Therefore, one can consider the creative problem solving as a cyclic, evolutionary developing process of subsequently alternating subconscious and conscious stages: (i) incubation period, (ii) spontaneous rise of various solutions, as well as (iii) the conscious deterministic analysis and selection of solutions. Thus, on the basis of a newly generated or acquired from the environment information, every subsequent cycle completes and improves the conclusions or hypotheses having been acquired at the previous cycle of the problem solving.

### **3 Possible Routes of Stimulation of Creativity**

On the basis of the above proposals one can put forward the problem of control and stimulation of human creative capacity. One can suppose: a continuous long stay in a modified condition [29] is a real possibility of activation of unactivated neural groups, as well as succeeds to appearance of novel series of neural activity acts. Thus, at certain sensorimotor intensity level the creative activity might become independent on the ability of an organism in initial information processing [29] and at obtaining a certain threshold there exists a possibility of isolation of consciousness from the physical environment. Such a meditation state can be considered, according to [24], as a phase transition, occurring in the brain, into macroscopic quantum state where coherent phases appear via quantum Josephson-like tunneling, and the expanded wave function is the likely cause of unbounded expansion of self-awareness and a rise of enlightenment. On the other hand, one can be noticed some analogy with quantum symmetry breaking effect (Goldstone process) of the wholeness of consciousness into particular localization [30].

Achieving of such highly effective creative state might be promoted by self-disposal of the subject's psyche [31], in order to amplify such precursors of creative thinking as self-consciousness as well as internal motivation. These are just self-organized chaotic activity patterns which would modify the motivation state [13]. Moreover, internal motivation can be regarded as a possible mechanism of synergetical strengthening of particular quantum states over the competing ones, resulting into general orientation of conscious and subconscious states of the human Self towards the problem solving.

### **4 Conclusion**

A probable mechanism of subconscious creative thinking is due to occurrence of multilevel probabilistic, quantum-logical phenomena in the brain

leading to emergence of discrete quantum-like jumps in the creative thinking process. A qualitative jump in the creative thinking process can be associated with generation of novel neural macrostate which corresponds to quantum tunneling of the thought, occurring on subconscious level, into the classically forbidden region. The probability of subconscious insight arrival is predetermined by previous conscious tuning to problem solving, the actual state of neural excitations and activities as well as on interplay on of subconscious and conscious neural processes.

## References

- [1] J. Gleick, *Chaos: Making a New Science* (Viking, New York, 1987).
- [2] P. Kruse and M. Stadler, Stability and instability: cognitive systems - multistability, suggestion and psychosomatic interaction, in H.Haken and M.Stadler, eds., *Synergetics of Cognition* (Springer, Berlin, 1990)
- [3] G. Blank, Beyond the looking glass, in G. Richardson, ed., *Windows of Creativity and Invention* (Lomond, 1988)
- [4] E.L. Rossi, Archetypes as strange attractors, *Psychological Perspectives* 20 (1989), pp. 4-14.
- [5] S. Amari, A method of statistical neurodynamics, *Kybernete* 14 (1974), pp. 201-215.
- [6] J. Szentagothai, The modular architectonic principle of neural centers, *Rev. Physiol. Biochem. and Pharmacol.* 98 (1983), pp. 11-61.
- [7] J. d'Humier and B. Huberman, Dynamics of self-organization in complex adaptive networks, in *Dynamical Systems and Cellular Automata* (Academic Press, New York, 1985).
- [8] H. Haken, Operational approaches to complex systems: an introduction, in H. Haken, ed., *Complex Systems: Operational Approaches* (Springer, Berlin, 1985).
- [9] J. Harth, Order and chaos in neural systems, *IEEE Transactions on Systems, Man and Cybernetics* 13 (1983), pp. 782-789.
- [10] C. King, Fractal and chaotic dynamics in nervous systems, *Progress in Neurobiology* 36 (1991), pp. 279-308.
- [11] J. Nicolis, Chaotic dynamics applied to information processing, *Rep. Progr. Physics* 49 (1986), pp. 1109-1196.
- [12] K.Sato and K.Kobatake, Order and chaos in neural networks, *Kenkju* 46 (1986), pp. 233-235.
- [13] C.A. Skarda and W.J. Freeman, Chaos and the new science of the brain, *Concepts in Neuroscience* 1 (1990), pp. 275-285.
- [14] A.V. Gaponov-Grekhov and M.I. Rabinovich, Nonstationary structures - chaos and order, in H. Haken, C. Flohr and E. Bassar, eds., *Synergetics of the Brain* (Springer, Berlin, 1983).
- [15] J. Eccles, Do mental events cause neural events analogously to the probability fields of quantum mechanics? *Proc. Roy. Soc. Lond. B* 237 (1986), pp. 411-428.
- [16] M. Peruš, Neuro-quantum parallelism in brain-mind and computers, *Informatica* 20 (1996), pp. 173-183.
- [17] G. Bernrolder, Endoneurologic virtual imaging of neural ensemble signals by quantum neurodynamics, in *Conference on Neural Modelling, Abstracts* (Lyons, 1994).
- [18] B.Souček, Quantum intelligence, QI; quantum mind, QM, *Informatica* 19 (1995), pp. 591-597.
- [19] P. Langley and R. Jones, A conceptual model of scientific insight, in R.J. Sternberg, ed., *Nature of Creativity: Contemporary Psychological Perspectives* (Cambridge University Press, Cambridge, 1991).
- [20] A.A. Vedenov et al., Nonlinear systems with memory and modelling of functions of neural ensembles, in E.P. Velichov and A.V. Chernavsky, eds., *Intellectual Processes and Their Modelling* (Nauka, Moscow, 1987), in Russian.
- [21] L. Zadeh, Fuzzy sets as a basis for a theory of possibility, *Fuzzy Sets* 1 (1978), pp. 3-28.
- [22] T.Oi, Biological information processing requires quantum logic, *Zeitschrift fur Naturforschung C* 43 (1988), pp. 777-792.
- [23] P. Mittelstaedt, The dialogic approach to modalities in the language of quantum physics, in *Current Issues in Quantum Logic* (Plenum Press, New York, 1981).
- [24] L.H. Domash, The transcendental meditation technique and quantum physics: is pure consciousness a macroscopic quantum state in the brain? *Scientific Res. on the Transcendental Meditation Program: Collected Papers* 1 (1975), pp. 652-670.
- [25] V. Rotenberg, Sleep dreams, cerebral dominance and creation, *The Pavlovian Journal of Biological Sci.* 20 (1985), pp. 53-58.
- [26] F. Gruneis, M. Nakano, M. Yamamoto, T. Musha, and H. Nakamura, Fluctuations in neuronal spike trains during dream sleep, *Biological Cybernetics* 60 (1989), pp. 161-169.
- [27] S. Smith and S. Blackenship, Incubation effect, *Bull. Psychonom. Soc.* 27 (1989), pp. 311-314.
- [28] R. Shaw, Strange attractors, chaotic behaviour and information flow, *Zeitschrift fur Naturforschung A* 36 (1981), pp. 80-112.
- [29] C.S. Findlay and C.J. Lumsden, The creative mind: Toward evolutionary theory of discovery and innovation, *Journal of Biol. Soc. Struct.* 3 (1986), pp. 3-55.
- [30] D.W. Orme-Johnson, G. Clements, C.T. Haynes, and K. Badaoui, Higher states of consciousness: EEG coherence, creativity, and experiences of the Siddhis, *Scientific Res. on the Transcendental Meditation Program: Collected Papers* 1 (1975), pp. 705-712.
- [31] A. Geraskov, Some aspects of intuition and setting, *Voprosi Psichologii (in Russ.)* 5 (1988), pp. 117-121.

## THE DILEMMA FOR SCIENCE OF CONSCIOUS EXPERIENCE

Peter Fenwick

Institute of Psychiatry, De Crespigny Park, Denmark Hill,  
London SE5 8AF, U.K.

**Abstract.** It is clear that we are a long way from understanding consciousness. Our current science is of little help because it uses an epistemology, which has already excluded consciousness by definition. Even more serious, science has introduced a mode of thinking into our culture, which has led to the alienation of an individual from his sensory experience. We relate to sterile models of the universe which science calls "real" as opposed to the wonders of sensory experience which science calls subjective and so "unreal". Clearly the way forward is through a new science, the science of the subjective. It is only then that we shall come to understand that consciousness is likely to be the very basis of the universe.

**Key words:** *objective vs. subjective, science vs. new science, consciousness.*

### 1 Introduction

When I look out of my window on a summer's morning I see in front of me a wonderful world. It is colorful, there are birds singing, I can feel the gentle summer breezes blowing across my face. The way the tree is leaning on the horizon has meaning for me in that I can tell its history, I know that it stands in the path of the winter gales, and that its form has been shaped by them. All the world has meaning.

If I was to stand by the same window on another day, with the same blue skies and warm sunshine, the same light gentle breezes, the same waving of the grasses, but I had a depressive illness, all would appear dull and gray, overshadowing me and pointing to destruction.

If I now go to my textbook of neurophysiology and look up the word 'meaning' it does not appear in the index. However detailed the textbook or scientific paper I read with regards to the mechanism of the brain and its structure, I see nothing about meaning. How is it that on the one hand I live in a world full of meaning but on the other I have a science which denies its presence?

### 2 Our Current Dilemma

For many centuries there has seemed to be no place in the physical universe for consciousness. Newtonian mechanics in the 18<sup>th</sup> Century assumed a totally materialistic universe without consciousness, evolving according to a set of immutable physical

laws. Descartes had a vision in which he saw the "extended thing of the world" and the universe fulfilling mathematical principles. The mathematician Laplace said that if he knew the position and momentum of every particle in the universe he could predict how the world would evolve. Descartes gave mind and consciousness no physical location and this has been one of the difficulties that science has had to tackle. For how can consciousness be weighed and measured if it does not exist in physical space?

Now, in the 20<sup>th</sup> Century, most scientists would claim that mind cannot exist as a separate entity. Certainly, so far as neuropsychiatry is concerned, there appears to be no place in the brain for consciousness or mind. Both psychology and psychiatry suffer from the lack of a satisfactory theoretical framework for the explanation and investigation of consciousness. If you cut a brain you cannot find a soul, for soul stuff and brain stuff are different. The unitary "I" of the middle ages and of our own experience become fractionated into a multifaceted psychological structure with numerous functions such as memory, language, facial recognition etc.

But the idea of a mechanical universe which excludes consciousness is unsatisfactory from an experiential point of view. The electrical probe of the neurophysiologist defines only the objective electrical mechanisms of cellular action, while the psychologist defines the objective aspects of subjective experience. There is as yet no clear understanding of how these two are linked. In order to understand why, it is important to understand how consciousness came to be excluded from our science.

### 3 Descartes and Galileo's World

Descartes, in the 17<sup>th</sup> Century, maintained that there were two radically different kinds of substance, the *res extensor* the extended substance, that which has length, breadth and depth and therefore can be measured and divided; and the thinking substance, the *res cogitans* which is unextended and indivisible. The external world of which the human body is a part belongs to the first category, while the internal world of the mind belongs to the second.

By suggesting that mind is indivisible and unextended with no spatial locale, Descartes shot himself and science in the foot. By definition, mind and consciousness became unavailable for scientific investigation. For how can you investigate that which is nowhere? I suspect that Descartes needed to take this view, so that he did not fall foul of the Church. But the consequences have been enormous. Mind, consciousness and soul have been beyond the realm of scientific investigation for the last 300 years, and it is only now that we are beginning to understand that they are unavailable for examination not because they truly cannot be examined, but simply by Descartes' definition.

Western science is based on the rationalism of Descartes, Galileo, Locke and Newton. Galileo defined a two-stuff universe, composed of matter and energy. These stuffs, he said, had primary and secondary qualities. The primary qualities were those aspects of nature that could be measured such as velocity, acceleration, weight, mass etc. There were also secondary qualities, the qualities of subjective experience, such a smell, vision, truth, beauty, love, etc. Galileo maintained that only primary qualities were the domain of science. Secondary qualities, the stuff of human experience, were non-scientific.

*To excite in us tastes, odours and sounds, I believe that nothing is required in external bodies except shapes, numbers and slow or rapid movements. I think that if ears, tongues, and noses were removed, shapes and numbers and motions would remain, but not odours or tastes or sounds. The latter, I believe, are nothing more than names when separated from living beings, just as tickling and titillation are nothing but names in the absence of such things as noses and armpits.*

(Galileo, *The Assayer*, 1623)

It is this view has conditioned science ever since, and which has led to the rejection by science of secondary qualities or subjective experience. Einstein's recognition that mass and energy are equivalent changed Galileo's two-stuff universe into a one-stuff universe, the universe that we have today. The advent of quantum mechanics has done something to broaden this view. In quantum theory matter, rather than being seen as discrete particles, can also exist in wave packets, each one of which are distributed throughout the universe, but has the statistical probability of appearing in space-time where the particle is. There is thus a possibility that effects in this matter are not necessarily limited to one specific area, but may be non-local. Quantum mechanics also asserts that the presence of an observer in a quantum mechanical experiment interacts with the experiment and its outcome. Although this is a matter of debate among physicists at the present time, it would suggest that subjective experience may be a necessary part of the objective world.

## 4 Problems with Idols

Owen Barfield, in his groundbreaking book *Saving the Appearances* describes the difficulties that we run into when our explanations of events are such that they cannot be witnessed by the senses. He points out that any model of reality which seeks to describe phenomena available to the senses by principles and mechanisms which are hidden from the senses, does an injustice to the world of experience. For it is not long before the model comes to "stand for" the experience, and is taken as real. He points out that we then have an unknown, unexperientable principle which we use to account for the phenomena of the experienced and knowable world. This process may be taken so far that finally the experience becomes secondary to the covert features of the explanations.

With this idea in mind, let us take an example. From the time of Lucretius, physical matter has been regarded as divisible into smaller and smaller units until we come to atoms. Atoms are said to underpin the structure of matter. The new quantum mechanical theories divide the atoms into quarks, and possibly into further sub-units. But the fundamental principle that the atoms are unavailable for sensory experience remains. It is now important to see what effect this has on the world in which we live. When I open my eyes and the sensory world appears in front of me, I know that it is composed of myriads of little particles - atoms - dashing about hither and yon. These particles which used to be likened to billiard balls bouncing here and there, with "hooks" or valences when they combined themselves into molecules, now have charge and valency shells. But they are still inanimate, sterile and meaningless. Thus, I have to conclude that the world I see in front of me is inanimate, sterile and meaningless, because the very nature of its components gives it this quality. This lack of meaning alters the way I feel and think about the world. Instead of approaching it with reverence, as part of creation, I approach it as something I can control and mould. I am not longer of it, but I work on it.

This brings about a subtle change in attitude that I bring to all scientific explanations of the way the universe is created. The model of the universe includes black holes, microwave radiation, and so on, none of which I can see, and none of which have any qualities except the sterile nature of the model. Because I believe that my model is reality, and note here the change from the perception of stars and their mathematical relationships, to models, which cannot be viewed or experienced, I have to conclude that the whole of the universe is sterile. It has no meaning, it has no purpose, it has no qualities apart from the qualities of the model which represents it.

It is not surprising that we have moved from the theocentric culture of the Greeks and Romans to a secular culture dominated by scientific thought and models, which has banished God entirely from the universe. Neither is it surprising that our models tell

us that all is random chance and that there is no meaning and no purpose because these are the very facts that we have used when creating these models. So when we come to look at consciousness, the only vehicle for consciousness that we can see is the brain, but as this is mainly composed of scientific models in which electrically charged particles move about in random fashion, the brain cannot be capable of any quality except that of the sterile universe of which it is part. Thus consciousness is excluded.

## 5 Taking the Models Further

Our scientific view carries with it a reassuring and intellectually satisfying consequence. Consider the following thought experiment. When you shut your eyes, the room in which you are sitting ceases to exist for you. Open your eyes and it is again there. Ever since Bishop Berkeley philosophers have given up discussing what happens to the world when it is viewed by none. This phenomenon is no longer thought to be of interest. But it is of fundamental interest, because it shows how subtle our current scientific view is and how it moulds our attitudes to the world around us. When we open our eyes again and see the world we know it will be there because it is composed, in our model, of atoms and molecules that are independent of us and which, in the last resort, cannot be created or destroyed. We thus use our science to confirm the principle that we built into science, of an objective external world, independent of us.

Now imagine that when you shut your eyes, the world truly disappears. One will be left with acute existential anxiety, as there will be no reference point to return to, because the world will be dissolved and created by movement of the eyelids. This, science says, is ridiculous. But it is only ridiculous because we believe in a model which we can't see or feel or touch or know directly with the senses. What is more ridiculous, to say that there are little particles flying about, surrounding by vast voids of space and it is these that make objects? Or to say that the objects disappear when we close our eyes, and reappear when we open our eyes? The first is a story we tell ourselves, the second is an observation. The first is comforting, the second is threatening.

Now to return to Owen Barfield. He points out that the world comes into view not because there is an objective fixed world which impresses itself on the sense, but because of the concept that is in the mind. It is when this concept touches the world that the concept creates the world we see. This view, that the world we know is structured by the mind we have goes back to Kant who pointed out that we can only perceive those things for which we have the brain structures to perceive.

Goethe also argued for the concept being primary and the perception secondary. This is fundamental, as it means that there is no fixed objective world out

there, composed of a myriad of small particles, but only a concept of it within the mind, which allows the perceived world to flower in accordance with that concept. This gives quite a different view of the world we live in, because we can see straight away that it is created by our own consciousness. We can also understand that when we see the world in this way, as a subjective world, dependent on us and containing qualities such as love, truth and beauty as part of its fundamental nature this is because these are parts of our own fundamental concepts.

## 6 Philosophies of Consciousness

There is as yet no explanation of consciousness that satisfies both those who have had the experience of consciousness and those who seek a scientific explanation for consciousness. Two major philosophical schools currently attempt to explain this difficulty. Dennett's neurophilosophy is at one extreme. He argues that consciousness and subjective experience are neither more nor less than the functions of neural nets. Nothing is required to explain personal consciousness except a detailed knowledge of these neural nets. This is clearly a reductionist approach, equating subjective experience with neural mechanisms (Dennett 1991).

At the other extreme is the philosophy of Nagel (1974), who argues that it is never possible to learn from an objective third-person point of view what it is like to have a first-person experience. Subjective experience is not available to the scientific method, as it is not in the third person and cannot be validated in the public domain. Nagel argues that however much we understand about the neurophysiology of the functioning of a bat's brain, we cannot know what it is like to be a bat. This view suggests that the explanation of subjective experience require a new principle that is beyond neural nets.

Searle, 1992, takes an intermediate position. He regards subjective experience as a property of neural nets, but he does not agree with Dennett that a full understanding of neural net functioning is all we need to explain subjective experience. Searle's view is that we need a "Newton" of neurophysiology to produce an entirely new principle - a synthesis between first and third person experience.

Until there is a satisfactory philosophical explanation of the nature of consciousness it will not be possible to answer questions relating to the nature of subjective experience. Some fields, for example extra-sensory or religious experience, remain outside the realms of science. At present, every scientific theory must explain everything in terms of brain function. However, I expect there are many people who, like Schrödinger, 1967, feel uneasy when asked to accept that the broad sweep of the soul is contained only within the gray porridge of the brain. Will the neurophysiologist ever be able to probe the soul with his micro-electrode?

## 7 Cosmic Consciousness

The following experience comes from a book written by a 19<sup>th</sup> Century Canadian psychiatrist, R. Bucke, who was one of the first Western scientists to attempt to define mystical experience.

Now came a period of rapture so intense that the universe stood still as if amazed at the unutterable majesty of the spectacle: only one in all the infinite universe. The all-caring, perfect one, perfect wisdom, truth, love and purity: and with rapture came insight. In that same wonderful moment of what might be called supernal bliss came illumination...what joy when I saw that there was no break in the chain - not a link left out - everything in its place and time. Worlds, systems, all blended in one harmonious world, universal, synonymous with universal love.

Bucke called this type of experience cosmic consciousness, as the individual's subjective consciousness expanded to encompass a full understanding of the universe. These experiences are very common in the population - about 10% in some surveys have deep experiences like this at least once in a lifetime. A fundamental feature of these experiences is that the universe is always seen as perfect and complete. It is never seen as evolving or developing, but always as having been created in its full perfection.

Religious experience as a whole is very common in the population and there are many studies of mystical or religious experience. Gloch and Stark (1965) showed that over 45% of Protestants and 43% of Roman Catholics had had weak mystical experiences when they had had "a feeling that you are somehow in the presence of God". Gallup surveys in the United States in 1963, 66 and 67, showed that 20.5%, 32% and 44% respectively had had religious or mystical experiences and the percentage increased as the decade advanced. However, by 1978 after the hippie revolution was over, the Princeton Religious Research Center found that in answer to a similar question that the positive response was down to 35%, possibly a reflection of a waning popular interest in the mystical. In Britain, David Hay organized an NOP survey in 1966 asking a similar question, and found a similar rate: about 36% gave positive responses. Of interest is the finding that although about a third of all people had had the experience, only 18% had had it more than twice, and only 8% "often and more". There was no correlation with age, but positive replies were commonest with those whose education went beyond 20, e.g. the more articulate university graduates. There was also, interestingly, a sex difference: 42% of women gave positive replies against 31% of men.

These experiences raise the question of whether this kind of experience is part of a natural human capacity, or whether it is in some sense pathological. It is difficult to argue for a pathological basis since the

experience is so common that it is in some sense normal.

The ecstatic mystical states in which the subject describes a feeling of universal love (as in the experience quoted by Bucke, above) occur much less often. These states can occur spontaneously but they, or fragments of them, may also occur in other circumstances, as in the near death experience, far example. Occasionally they can occur in temporal lobe epilepsy, and frequently in psychosis, when they are often associated with an elevation of mood. Psychedelic drugs can also induce similar experiences. It therefore seems probably that the ability to experience these wide mystical states is a normal part of brain function, and indeed there are techniques in many eastern religions directed at inducing these wide feelings of universal love at will.

## 8 Conclusion

It is clear that we are a long way from understanding consciousness. Our current science is of little help because it uses an epistemology, which has already excluded consciousness by definition. Even more serious, science has introduced a mode of thinking into our culture which has led to the alienation of an individual from his sensory experience. We relate to sterile models of the universe which science calls "real" as opposed to the wonders of sensory experience which science calls subjective and so "unreal". Clearly the way forward is through a new science, the science of the subjective. It is only then that we shall come to understand that consciousness is likely to be the very basis of the universe.

## References

- [1] Back, K., and Bourque, L. B. (1970) Can feelings be enumerated? *Behavioural Science* 15: 487-96.
- [2] Barfield, O., *Saving the Appearances*.
- [3] Barfield, O., *The Rediscovery of Meaning*.
- [4] Bucke, R. (1961), *Cosmic Consciousness; A study in the Evolution of the Human Mind*, Concord, MA: Ye Old Depot Press.
- [5] Bortoff, H. (1996), *The Wholeness of Nature*, Floris Books.
- [6] Dennett D. C. (1991), *Consciousness Explained*, London: Penguin.
- [7] Gloch, C. Y. and Stark, R. (1965), *Religion and Society in Tension*, Chicago: Rand McNally
- [8] Nagel, T. (1974), What is it like to be a bat?, *Philosophical Review* 83: 435-50.
- [9] Searle, J. (1992), The problem of consciousness in P Nagel (ed) *CIBA Foundation Symposium no 174 Experimental and Theoretical Studies of Consciousness*, Chichester: John Wiley, pp. 61-80.



## PHONOLOGICAL DEVELOPMENT IN BABIES WITH UNI- AND BILATERAL PERINATAL BRAIN LESIONS

Vida Gec<sup>1</sup> and Julius Ivanuš<sup>2</sup>

<sup>1</sup>Center for Hearing and Speech Rehabilitation, Vinarska 6, 2000 Maribor, Slovenia

<sup>2</sup>Center for Multidisciplinary Studies, University of Belgrade, Kneza Višeslava 1, Yugoslavia

**Abstract.** Babies, both sexes, 60 of controls and 30 with uni- and bilateral perinatal brain lesions were followed on their phonological development from 6 to 24 months of life. A delay in vocalization was evident in certain critical vowels. On the other hand, the standard utilized scale in controls undergoes sequential corrections.

**Key words:** *phonological development, perinatal brain lesion, habilitation.*

This study deals with early habilitation of phonological development in babies with uni- and bilateral brain lesions. The brain is a marvelous thing and it has been called the only human organ capable of studying itself. Although the metaphoric heart has been rhapsodized in song and sonnet much more frequently, the brain and its peculiar music have met increasing attention, not only popularly, but notably from researchers, scholars, educators and clinicians who must deal with attempts to understand it. The commitment to understanding the brain and its disorders focused, as we can see it also now, bright attention maximizing human potential not only by the neuroscientist's, but even more related disciplines which interact their knowledge contributing to the UN aim at this proclaimed Decade of the Brain. As we go close to the end of this century, and so to this Decade, we are aware, that by all efforts invested, we made big, but in absolute terms only small steps in understanding one of the brain's most miraculous function - consciousness. Can neurobiology explain it, or - as some philosophers argue - does this most elusive and inescapable of all phenomena lie beyond experimental reach?

What was once the greatest mystery of biology, the human brain, is gradually yielding its secrets. Investigators are probing its deepest recesses with increasingly powerful tools, ranging from microelectrodes, which can discern the squeaks of individual neurons, to magnetic resonance imaging and positron emission tomography, which can amplify the cortical symphony evoked by sensory inputs. With these and other techniques, researchers have begun elucidating the physiological process underlying such facets of the mind as memory, perception, learning and language.

Having in mind, that if the human nervous system goes awry, the cost is enormous. Recently, Leonard

LaPointe from the Arizona State University reported, that direct and indirect economic impact of brain disorders has been estimated to be over half a trillion dollars [1]. It is impossible to measure the toll that brain disorders extract in terms of human agony from victims and their families. Each disruption of delicate neural balance can cause problems in moving, sensing, eating, thinking, speaking and a rich array of human behaviors. Certainly, not the least of these are those unique human attributes involved in communication. To speak, to understand, to write, to read, to remember, to create, to calculate, to plan and myriad other cognitive and communicative acts are the sparks and essence of human interaction. When they are lost, or impaired, isolation can result, or at the very least, quality of life can be compromised.

Brain damage, that can affect these human cognitive and communicative functions give us reason for engagement in rehabilitation, relearning, intervention, recovery, adjustment, acceptance, and reintegration as the rewards for challenge. Apart from the bright field of neuropathology and clinical tools, there is an although not modern, but ancient still effective approach to correct language impairment caused by brain lesion. And our attempt with this publication was, to rise attention to that small but so essential contribution for integrative nervous activity underlying the great facet of conscious behavior.

In an urban district health care associates decided to focus their attention to language disorder appearing in newborns following perinatal brain lesions. From prenatal, perinatal and postnatal newborn evidence they could provide a lot of relevant information about the babies curricula, and this was followed up to their second year of live. Beside the aforementioned medical assessment special attention was paid to vocalization. 30 cases of perinatal uni- or bilateral brain lesioned babies were also logopedically treated in order to evolve early habilitation of vocalization and then matched to a group of 60 babies with normal development, in the course of five years. Both sexes were equally represented.

The results obtained showed, confirming our hypothesis, that perinatal brain lesion significantly influences the psychomotor development as well, as the phonologic in prelingual and also in the lingual

phase too. Selectively, most serious delay in vocalization was in those babies who suffered from bihemispheric brain lesions, reaching half of the normal score in their phonologic development. Similar results, only slightly better are those in babies with left hemisphere lesion, but quite good with a trend of 40% improving at the end of the observation period, i.e. two years of life.

The aim of this study was not only to match an actual phonologic development to a utilized standard, but after critical observations to propose another standard, which is more adapted to the real situation and the time in which we live! So, we are witnesses of that message that "no test is a test until it is tested!" And in the figure below we show it how:

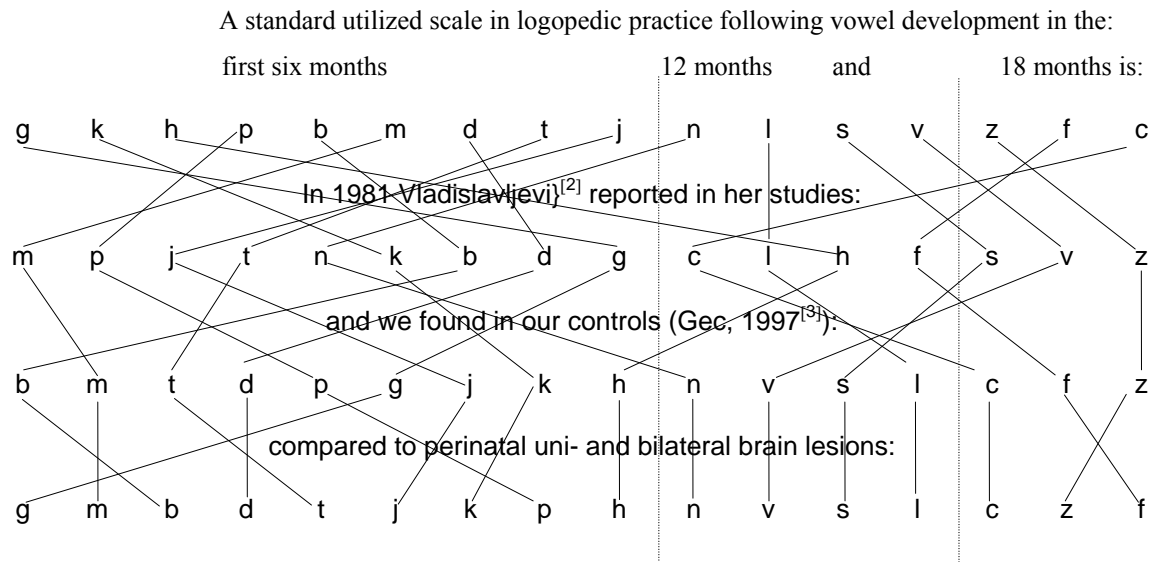

Which gives the impression, that babies develop today a quite different pattern in their phonological order than even a decade before, and highly different than the classic standard which is still utilized. On the other hand, there is only a small shift between controls compared to impaired referred in this study, but we are still far from understanding the basic interactive mechanisms who rule with compensatory reorganization of a new set up randomized pattern.

reintegration. This stage of rehabilitation emphasizes the strengths of an individual and the ability of the individual to learn new skills and strategies that will improve in their ongoing life everyday functioning on a conscious level.

Brain injury rehabilitation is a relatively new field that has been full of challenges and changes since its conceptions. This is particularly so at the post acute level of rehabilitation. At this stage of recovery, the focus is on reestablishing individual's meaningful relationships, restoring daily living skills, and rebuilding a productive lifestyle, despite any residual cognitive, communicative and physical limitations. This level of rehabilitation generally follows a medical rehabilitation of inpatient rehabilitation phase and is provided in either a residential program, day program, or outpatient program aimed at community

## References

- [1] L. Hartley, *Cognitive-Communicative Abilities Following Brain Injury - A Functional Approach* (Singular Publishing Group, Inc., San Diego, CA, 1994).
- [2] S. Vladislavjević, *Pronouncing Disorder* (Privredni pregled, Beograd 1981), in Serbian.
- [3] V. Gec *Phonological Development in Newborn with Uni- and Bilateral Perinatal Brain Lesions*. Doctoral Thesis (Belgrade University, Medical Faculty, 1997), in Serbian.

## HEALING RITUALS AND ALTERED STATES OF CONSCIOUSNESS

Časlav Hadži-Nikolić and Branka Petković-Medved

Railway Health Centre, Belgrade, Yugoslavia

**Abstract.** In the societies settled on the upper course of the Amazon river, hallucinogens in the potion named Ayahuasca are used in the special psychotherapeutic ritual. The main person, the leader of the ritual is shaman, devoted to that profession by his own choice, of his own deep need for researching the modes to help the society he is living in. Therapeutic ritual itself is based on the experiences of his teachers and his own, and has a form of a special kind of treatment, special not only because of the technique, but, also, because of the purpose. Entering into the another reality world, visualising and liberating individual and collective unconscious material, with shaman's and the group's support, patient is looking for the answers about his own personality, his place in the group and in the universe, and, at last, but not the least, for the protection, security and encouragement that almighty cosmic forces deliver to him. The shaman sends the patient on that trip, follows him, grasps and interprets all the events in that shifted consciousness state as the messages the altered reality sends. This is the way to correct the disturbed balance between the positive and the negative influences, that caused the illness or misfortune or even something worse. Bringing the patient back again to the community he finds supportive and removing the danger for one's or group's physical, spiritual, social and cultural integrity by re-establishing the harmony between them and cosmic powers is the purpose of the treatment and the condition sine qua non for a healthy individual and a healthy society.

**Key words:** *shaman, hallucinogenic, transpersonal experience.*

The person, responsible for the activity called the psychiatric medical treatment according to the Western rite, is, in tribal societies settled on the upper course of the Amazon river [1], without any doubt, the shaman. He himself exclusively takes care of the group members and the entire group psyche integrity. To understand the therapeutic aspect of the shaman's activity, the most important is to be close with his special technique, the technique that is the essence of his competence and that makes him to differ from the others, similar categories, persons Jerbatero, the medicine man etc.). We are talking about the technique called by Mircea Eliade the Ecstasy technique or the Ecstatic state technique, or, perhaps more suitable, shamanic states of consciousness, by Michael Harder.

Anyway, we are talking about *the altered states of consciousness*, that the shaman reaches in the different ways and that enables him to enter the scope of his

contacts with something Castaneda called a separate reality; that means, he perceives unusual reality manifestations, parallel to the everyday reality, but hidden, invisible, attainable only through the ecstatic state drama. By the shaman's universe and the world concept, in such a latent reality the Pantheon resides, the powers that possess the absolute knowledge and the absolute force. To realise his mission, the shaman has to be an expert in finding the ways to reach the ecstatic state (that is, the shifted state of consciousness), in contacting another reality through that altered state of consciousness and, also, to understand the events in it, that means, to grasp and to interpret messages another reality sends to him. Hallifax claims that shaman's mission is, in fact, waking up to the another things system, the ecstatic experience and visual scope opening [2].

Another important element that distinguishes the shaman from similar tribal important persons is *the goal* of his trip to another reality. There are practical reasons for such a trip: to search for and to discover the cause of disease, to find the suitable medicine for treating it and to recognise signals threatening the individual or the group... On that occasion, he is dealing with the problem of the disease in a very broad context, considering it to be the negative forces (the Evil) effect that endangers spiritual, physical and social integrity of the individual or the group. It is important here to emphasise that in the observed groups mystic experiences appear through the therapeutic seances, but, in this context, it has solely practical importance, that means that nothing changes exclusively a practical importance of the shaman's trip to the altered reality. The mystic experience in this context has no religious background, but exclusive practical significance in the sense of looking for the human's place in the huge cosmic scheme.

The shaman, certainly, can participate in the religious rituals, but it is not the main goal of his activity. His main task is to make a contact with the world of another reality and in such a way to achieve some practical gains important for the whole society. The relationship with the forces possessing the absolute knowledge and the absolute power he makes contacts with, is still another characteristic of Amazon societies shamans. Regardless of the intensity of this relationship, the essence is in fact that the shaman never undergoes their influences. *He is never*

*possessed*. The shaman is always his own. He is the one who knows, the interpreter of the hidden, an expert for the communication with the Pantheon. In the observed groups, no idea of possession was noticed and there was nobody who could even explain what possession means.

There is another characteristic of the Amazon shamans that makes them unique. In contrast to others, in the first place Asian and Australian shamans, who were "called for" by delivering "from above" during their illness or the dreams, or who became shamans by succession, Amazonian shamans devote themselves to the profession by their own will. The decision to become a shaman is their own choice, the consequence of the filling the deep need for the "great search", for researching the hidden cosmic spaces, internal or external. It is understood that such a decision makes shamans insulated in some way and may be the reason for some investigators to proclaim the elements of psychopathic structure in shaman's behaviour, neurotic arrangements or even psychotic conditions. Those kinds of assumptions have no reason, at least concerning the shamans in the upper course of Amazon river. Investigating shaman's psychotherapeutic rituals we have noticed no apparent psychotic or psychopathic behaviour among them.

Concerning the first demand related to attainment of the ecstatic state which is the prerequisite for penetrating the world of altered reality, the Amazonian shamans, following the traditions of their psychedelic culture, use solely psychotropic potions. Keeping in mind the inexhaustible possibilities offered by the surrounding flora, it is quite understandable. The use of psychotropic herbs is the most dramatic and perhaps the most dangerous one, but, undoubtedly the most effective way to reach the shifted states of consciousness and to enter the "another reality". But, a more difficult task is to understand the symbols and messages delivered from that world and solving such a task is attainable exclusively to the exceptional ones. This kind of knowledge the shaman acquires in two ways. In one way, the shaman teachers deliver knowledge to future shamans during months and years of intensive training under the conditions of deep asceticism, and in another, the shaman himself enriches that knowledge by personal experience acquired on his solo trips. The shaman has to be the expert in other reality's morphology through which he is moving together with the creatures he meets, so that he would be able to identify them and to translate their messages. The specific meaning that these creatures' movements, their language, the mode of appearance and vanishing always is of great importance that is necessary to be understood. All the events that the shaman recognises have their own meaning and the teacher clues him in it. Without that key, everything seems to be chaotic, unintelligible, indistinct and deterrent. Understanding the events in that world, recognising pictures that arise, creates a system and puts order in the chaos, structures it and gives a

meaning to it. So, the shaman has to learn how to manage, deal with and to understand that world in the same way he is managing, dealing with and understanding the common world his group lives in.

Alone, or accompanied by other members of the group, the shaman immerses himself into hallucinogenic experience during special rituals, entering from one state of consciousness into another (that is, from the common state of consciousness to the shamanic state of consciousness). So, he reaches "another reality" where he tries to find the cosmogony and theogony echoes of the group he belongs to, using his own experiences and the knowledge his teacher gave to him, and, in that context, to interpret to himself and his companions the messages delivered from that reality. All the members of the observed group are allowed to take psychotropic potion, that is, to enter another reality, but the shaman is the only one that understands and interprets that reality.

There is not enough place to describe the ritual itself, but, intending to make some decor of the situation, we will mention only that five to seven selected people, "the patients", that the shaman has carefully chosen before, together with the shaman himself and, eventually, his assistants, take part in the ritual. The whole ceremony happens exclusively at night, at special, for that purpose-determined places, outside the village or at its edge. Psychotropic agent is the potion known as Ayahuasca, not yet quite identified. The main ingredients of the potion are the plants from Malpighia family: *Banisteriopsis caapi* and *Banisteriopsis inebrians*, both of them the jungle lianas, but, besides those plants, Ayahuasca contains a great number of other ones, chosen carefully by the shaman, depending on his own knowledge, experience and the goal he wants to achieve. Some of those herbs are identified (*Psychotria viridis*, *Banisteriopsis rusbiana*), but, most of them are not. The main chemical compound is alkaloid harmalin (the ingredient of *Banisteriopsis caapi*), but. The other compounds are not chemically identified yet. The ritual itself is rather complex, but it is impossible here to consider it completely regardless of the importance of its anthropologic and psychotherapeutic implications. The crucial thing of the ceremony is the drinking of Ayahuasca that happens one hour after the ritual begins. Ayahuasca effects are expected about one hour after, sometimes more, depending on the type, dose and the purpose of the potion given to the patient.

It is necessary to mention, once again, that in these societies consciousness is experienced as the balance between the positive and the negative (evil) forces. When this balance is thrown off towards the negative forces, misfortune, illness and death occur. So, illness is considered in a very broad context, as exposing to a danger not only of one's or group's physical, spiritual, or social integrity, but their cultural integrity, too, and, also, as the disturbance of their harmonious relationships with the cosmic powers. Such a view of

disease makes the shaman, as an expert in supernatural sphere and cosmic space interpretation and comprehension, not only more responsible, but, also, forces him to work on several levels, from a selection of snake bite balm to the situation when he is expected to be acquainted with the answer to the question such as: who am I, what am I, or what's my place in the Universe? According to the described comprehension of the disease and the treatment in the observed groups, we are permitted to designate a few shaman's work domains and to define them as following:

- empirical-rationalistic (phytotherapeutic, first of all)
- magical
- social
- psychological
- transpersonal or integrative.

It is clear that all the shaman's work levels overlap, so that it is hard to distinguish them at a first glance, but, therapeutic act contains the totality of them and they can be followed as the therapeutic entitles. We are going to leave aside the first three levels here, that means, the empirical-rationalistic, magical and social context of the therapeutic management and not to consider their importance for understanding the entirety of shaman's therapeutic actions.

Those psychotherapeutic group ritual aspects that are unfolding as open, specialised and directly guided group, use the disleptics to reduce self-defence, to make it easier to throw the repressed contents out and to facilitate the communication between members of the group, to magnify the suggestibility in the relation to the leader and to expand the insight. Disleptics are, also, of great importance in the therapeutic sense, but, it does not enter the scope of this text nor corresponds to its aim, so, we are not allowed to dwell more on them.

In our work we emphasise those implications of the shaman's action that have therapeutic aspects that enreach the domain of transpersonal psychology.

The most impressive part of the seance is, of course, the appearance of the visual contents under action of the hallucinogenic potions. The patient is overflowed with pictures he does not understand so that he is forced to turn to the shaman, to call the tradition and the myth for explaining these events to him. The appearance of these pictures offers plenty of possible interpretations and the opportunities for reaching their meanings, too. Those meanings will differ if observed from the point of view of a theologian, psychologist or psychiatrist. The last one has his own variants, depending on the professional ideology he accepted. So, without maintaining at the different theoretical aspects, we'll mention only that the most of the therapists dealing with the psychotherapeutic effects of the hallucinogens consider the hallucinogenic experience as the authentic subconscious material that emerges on the surface in the form of pictures after the defensive walls destruction. If we accept that the visual contents

that dominate in the Ayahuasca session are the subconscious material manifestations [3], then the shaman makes some kind of cultural arabesque by projecting the subconscious content to the supernatural sphere. His interpretation places patient's subconscious contents into the cultural content attaining in that way different results. In the first place, the patient avoids painful meeting with his own consciousness. Instead of the confrontation with himself, there is a meeting with the world of the ghosts. And no matter how horrible that world is and those meetings unpleasant, disturbing and frightening, it is still much easier to meet it than to confront with oneself, especially when crossing that world with the guide help and the group support. We could, perhaps, say that the patient got some kind of insight, but, a culturally determined insight, modified, less painful and culturally more acceptable. The internal danger is projected to the external space. Supernatural world becomes a marvellous vault of the subconscious contents in that way. The shaman is capable of recognising wishes, fears and needs placed in that vault and of interpreting them according to the group's cosmogony and theogony. It can be supposed that at least some of the pictures are explicitly individual ones; those pictures enable the shaman to create the base for interpretations of his fellow tribesmen's problems.

Nevertheless, the most significant dimension of the hallucinogenic experience, the experience that, practically represents therapeutic essence in the isolated Amazon groups, is the dimension that touches universal themes, from the questions about the personal identity to the question of his place in the cosmic model. This experience, described as transcending boundaries of the entire reality experience, as going beyond the profane living framework, penetrating the cosmic existence sphere and going toward the highest principle, is often called the transpersonal experience in the literature, to differ from religious terminology that denotes it as a mystical experience.

There is still a question about the characteristics of such an experience and if it even exists in the shamanic concept, because many shamanism experts (and Eliade among them) didn't find such mystical component in the concept that is directed solely towards the practical use.

According to the shaman's practice, these categories do not exclude each other and the mystic or transpersonal experience is directly related to the function of the treatment, if the treatment is carried out in the context that corresponds to the shamanic concept of the illness. No matter how defined the mystic experience, it's clear that it leads to the experience of the direct contact with the highest forces, to the "communication with the nonconditionated world" [4] or, quite concise, to the "realisation of the relationships between someone's consciousness and the Absolute" [5]. In the ecstatic

state the shaman tries to make a contact with creatures that possess the absolute knowledge and the absolute power, crossing cosmic spaces. Through these contacts he tries to get the answers to the questions like: who am I, where am I from, to whom I do belong, where am I going to, what's my place in the Universe? - the questions that lie in the base of every mystic search. In such a context, shaman's trip, based on searching for the absolute, has, without any doubt, mystical elements. The mystical, nevertheless, does not exclude the practical purpose of this trip. Quite the opposite, mystic or the transpersonal experience is complementary with this aim. In other words, this experience is in the immediate function of the purposes of the shaman's action, and in the first place, for the purpose of treatment. As one is "constantly coming back to his mystic, transsubjective roots and to his beginnings" through these experiences, the trip from here and now to there and then is quite understandable; the same is true for one's coming back to the myth past and the dramatic contacts with the myth scenes and symbols, through which one realises important human connections with the cosmos. Following the idea of the unconscious contents liberated by the influence of the psychotropic substances, it could be supposed that on this level the deeper layers of the unconscious material are released, the layers that belong to the collective unconscious material. This would be related to already mentioned assumption that some hallucinogens in defined doses wake certain layers of the unconscious material up [6]. The transpersonal experience in this context would correspond to the waking archetypes contents up, the contents whose origin is so deeply buried in the mystery of the past that it seems that they have no human origin.

It is possible to observe the whole thing in another way, a way that seems very logical and acceptable, because it is not based on hypotheses and speculative arrangements, but on some objective details that cannot be avoided in this context. First, it is important to keep in mind that psychotropic substances, including hallucinogens, influence the brain parenchyma, and not the perceptual and emotional contents of the mind. So, it can be said that those substances modify the synaptic transmission, that means that hallucinogenic drugs "modify the brain, not the soul". Such a modification would be reflected to the psychological acts and ongoing activity connections, relaxing and destroying them. In other words, there may be some kind of splitting: imaginations, feelings, thoughts etc. escape the immediate and often unpleasant reality control. So, we could talk about hallucinogens that liberate the brain from a great number of stimulation and information that the reality imposes on the human. The consciousness regarded as a function of the central nervous system becomes free from the tyranny of the ongoing reality. By closing the immediate reality information conducting channels, hallucinogens

release the consciousness, so that released consciousness is capable of distinguishing everyday problems and actual questions and concentrating to the universal questions. Universal questions, from an individual point of view, are those that denote one's relationship to oneself, to the group and the universe. So, everyone's consciousness begins with the relationship to he himself, that means, the consciousness about oneself. The next important relationship is the one towards the group, and the third level is the relationship to the universe.

By lowering down the intensity of the ongoing reality or making it disappear together with its meanings, the spiritual world becomes the only and true reality. In such a reality, the shaman or his companion transforms into the thinker confronted to himself, his group and the universe. In common life, he may be without the consciousness of the individual, group or cosmic symbols and concepts, or, better, he may not catch the ability to operate them. Hallucinogens that eliminate disturbances originating in the ongoing reality, revives the contents that would remain, probably, hidden forever and out of the individual consciousness without the shaman's help. They (hallucinogens) disturb the realistic consciousness, but release the spirit. In other words, during such an experience, the "primitive hunter" changes into a thinker who is looking for the lost spiritual balance, not during the practical act he is used to, but in the spiritual strain that has to integrate him with the world he depends on and the universe he is the part of. Acting on the described way, hallucinogens make an individual capable of entering the world of visions, memories, fantasies and dreams. Such experiences (visions, pictures, memories), can be, on the one hand, products of the individual experience elements, but on the other, of the processes common to all people. By this concept, if there is anything that exceeds all the limits of the individual knowledge representing the property of the collective, mankind, then it has to be the activity built up of some psychological operations. Using the delivered knowledge and personal experience as the base, the shaman makes the decision which, from the awoken pictures, is the individual experience, and which is a result of the common psychological processes and adapts his therapeutic attitude to them. On this therapeutic measure level, shaman potentates hallucinogens properties to "turn the consciousness" from the actual happenings in the normal reality towards "another reality", the spiritual world, leaving the patient to his adventure and following him on this travel. It was already mentioned that such a trip contains three important levels. The first level is represented with the relationship to oneself and contains questions such as: who am I, where am I from, where am I going, to whom do I belong, how can I survive in this world? Here, the central theme is one's own identity. But, investigating one's own identity makes the next level closer and easy and fast

to reach so that often it is impossible to separate them. On this second level, the most important personal dimension exists: the individual relationship to the group. In Machigenka group it is said: "Ayahuasca is something that is consumed... it shows you where you are from, where all Machigenka are from, Machigenka that were and that are... Then you know that nothing can happen to you... On this level, the comprehension of the things order is crucial, that means, in such a context it is necessary the way of clan operating and the individual needs to be settled in the structure of the clan, the society structure. Only when he finds himself integrated, one dares to meet the absolute forces. Shaman's aim is to direct his patient to a close contact with the forces that possess the absolute knowledge and the absolute power. Questions about cosmic forces, absolute, deity, do not originate from academic needs to understand the time and space infinity and the origin of the Universe, but are the expression of the impossibilities and needs for protection, security, and encourage merit. All the thoughts about time, the origin and the infinity are based on the invincible human need for security and support. The shaman is, of course, more curious than his fellow tribesmen and more confident in the search for almighty cosmic forces, but his own deep needs for the knowledge about the beginnings and the ultimate meaning of everything have the same base: the need to be protected, supported, encouraged, and his effort to connect his personal meanings with the meaning of the universal order, to find his place in the great cosmic model and, once again, in that way to affirm the fact that he is integrated into the absolute power's world because without such an integration his fortune and the fortune of the whole group will be denied to the helpless human beings; all those efforts have the same purpose. His therapy is directed to the same aim: to make the contact between his own people and the absolute powers and to assure them by the immediate experience, that those forces are friendly and omnipotent.

Reaching this level, the individual and the group identities acquire a definite value and it brings the self-confidence and the self-trust back. From the shaman's point of view, it is quite irrelevant if the cosmic forces he contacts are revived from the collective consciousness and the long time ago buried experiences, or their base is universal psychological process elaboration. We could take this theme for our thoughts and the professional ideologies, but, for the shaman, it is important only that these forces exist on the level of another reality, that authentic communication with them is possible and that they can be reached by changing the normal into the "shamanic state of consciousness", so that they can be lived and that his people can be ensured in their friendliness and protection. That is the crucial place and the substance of the shaman's cure.

Our research in Nigeria in 1997 demonstrated that in large part healing cults, especially among Yoruba

and Ibo tribes, follow a basically similar structure of altered states of consciousness induced by drumming and specific dance which accompany that drumming. During these "juju" rituals specific cathartic states are reached accompanied by expulsion of control content.

After the completed ritual, the final interpretation is offered by the juju (shaman, medical man). This interpretation is as sophisticated as among groups of the Amazon and Andes, and is defined by similar principles - resolving of individual problems and facilitating into the group, based on theogonic and cosmologic concepts.

Acting therapeutically, the shaman uses common and global forces, such as: the community and the higher (gods) powers for solving individual problems. Going from the common to the individual, the shaman begins from the most common collective consciousness to apply it on the individual case. It differs from the psychiatric treatment in that psychiatrist takes the individual case, the individual and his responsibility and tries to make him capable and adjusted to the common and general demands. Native culture member regards the general as the ally, friendly and supporting, but in the Western culture, the individual and common are regarded as confronted forces that he cannot cope with.

We'll repeat, once again, that the essence of the shaman's therapeutic procedure could be interpreted in many different ways, beginning with the already mentioned ones that we found acceptable for explaining this phenomenon, to the very exciting concept of the "biophysical model for altered states of consciousness" [7] that is still waiting for its place in the current intellectual jargon. So, interpretations depends upon one's professional, philosophical and even religious views. The shaman himself will, however, remain indifferent, carrying out efficiently his psychotherapeutic job in the scope of his experience of the human, the world, and the universe.

## References

- [1] This work has resulted from
- investigations carried out in the regions settled with the groups: Aguarunas, Shipibos, Machiguengas in the upper course of Amazon river, mainly along Maranon, Ucayali and Madre de Dios river;
  - processing of the missionary, anthropology, and linguistic sources, and the other accessible literature:
- G.Baer, Religion y shamanismo de los Matsigenka, *Amazonia Peruana* 2 (CAAP, Lima, 1979); G.Baer and W.Snell, An Ayahuasca Ceremony among the Matsigenka (Eastern Peru), *Zeitschrift für Ethnologie* 99 (Braunschweig, 1974); R.W.Bergman, Shipibo Subsistence in the upper Amazon Rainforest, Ph.D. thesis (University of Wisconsin, USA, 1974); B.Berlin, Bases empiricas de la

- Cosmologia Botanica Aguaruna in A.Chirif, ed., *Etnicidad y ecologia* (CIPA-Centro de investigacion y promocion Amazonica, Lima, 1979); A.Chirif, M.Carlos, and M.Rogue, *Los Shipibo-Conibo del Ucayali diagnostico socio-economico* (SINAMOS-Unidad de Apoyo a las Comunidades Nativas, Lima, 1977); W.Dubin, The use of Meditative Techniques in Psychotherapy Supervision, *J. Transpers. Psychol.* 23 (1991); A.Klenman, Rethinking Psychiatry: From Cultural Cathegory to Personal Experience, *Transcult. Psychiat. Res. Rev.* (Qebec, Canada) 36, No 3 (1989); V.Manafield, Looking into Mind: An Undergraduate Course, *J. Transpers. Psychol.* 23, No 1 (1991); S.Penzik, Drama Therapy as a Form of Modern Shamanism, *J. Transpers. Psychol.* 20, No 1 (1991); A.Roland, The Influence of Culture on Self-Object Rehabilitation an Asian American Comparation, *Transcult. Psychiat. Rev.* 26, No 2 (1991).
- [2] Joan Halifax, *Shaman the Wopunded Healer* (Crossroad, New York, 1982).
- [3] Here, perhaps one could say that COEX system is activated (The System of Condensed Experience)
- [4] N.Drury, *The Shaman and the Magician* (Routledge & Kegan Paul, London, 1982), p. 89.
- [5] E.Underhill, *Mysticism* (Methuen, London, 1972), p. 97.
- [6] C.Jung, *Man and his Symbols* (Dell, New York, 1968), pp. 41-42. Here, biological past memories would be without any significance. The experience would be meeting deeply burried collective past memories.
- [7] D. Raković, Brainwaves, neural networks, and ionic structures: Biophysical model for altered states of consciousness, in D. Raković and D. Koruga, eds., *Consciousness Scientific Challenge of the 21st Century* (ECPD, Belgrade, 1995), pp.291-316, and references therein.



# KIRILIAN TECHNIQUE: A WAY FOR MONITORING DIFFERENT STATES AND DIFFERENT LEVELS OF HUMAN BIOSYSTEM

Gradimir Ivović

V. Tankosića 7/20, Niš, Yugoslavia

**Abstract.** In this paper a Kirlian technique as a way for monitoring different states and different levels of human biosystem has been applied. A special emphasis was put on the evaluation of hydrogeopathogenic effects upon the human "bioplasmatic corona", and on the evaluation of its fine-structured levels within the Kirlian photographs in the one-minute exposed X-ray films. The observed effects clearly demonstrate high sensitivity of human biosystem on exogenous hydro-geopathogenic effects, as well as four levels of the fine-structure in human "bioplasmatic corona".

**Key words:** Kirlian technique, "bioplasmatic corona", hydrogeopathogenic effects, fine-structure levels.

## 1 Introduction

Beside muscles, bone, cardiovascular, and nervous systems, established in medicine so far, there is also *biosystem*. Its energy is distributed through the channels all over the body, but outside of it as well. Confirmation for the channels are the acupuncture channels [1], while outside of the body they can be seen on Kirlian photographs [2]. It is quite clear that biosystem has unbreakable bounds with the physical one. They constantly have either positive or negative influences one to another, but still they are *two* separate systems.

So far, the classical methods, EEG, ECG, or EMG measure only *bioelectrical* activities, but they cannot measure activities or characteristics of the biosystem. For the time being, it can be seen only by the Kirlian method.

Does Kirlian technique provide a way for monitoring different states and different levels of human biosystem?

By visual observation during photographing, a shiny corona can be seen, continuously pulsing and changing its shape and length of spreading, with periodical eruptions.

It has been noticed that human "bioplasmatic corona" undergoes certain changes due to endogenous influences, as well as exogenous factors. It reacts almost instantaneously to any more significant influence. And yet, it is much stronger than assumed, and more delicate and vulnerable than it was thought of.

By photographing the pictures are obtained, but they only give the state within the given time

estimated for exposition. We have tried to film corona with a TV camera, but still there is no so perfectly delicate one to perform this job correctly.

## 2 Aim and Method

In this paper, our aim was to see whether by Kirlian photography we could confirm the existence of hydrogeopathogenic fields [3], and their influence on human biosystem.

We have started from the fact that, above the subterranean water flows, there is a field of forces which spreads vertically and can be of different width, and also that longer exposure to the field could cause not only smaller or bigger damages of biosystem, but also some evident organic changes. There is a project on that matter, led by Academician Suša and Prof. Momčilović, at the Serbian Academy of Sciences and Arts.

Using a nonconventional Kirlian camera, pictures were taken of fingers in the neutral zone, HGP field, and Hartman knot (presenting a zone of intersection of the two fields). There were four persons examined. Initially the camera was set in the previously marked neutral field, HGP field and Hartman knot. Obeying all the rules of shooting, as well as prerequisites for valid photographs, we have inserted X-rays films of 10 x 10 cm size. Exposition was exactly one minute.

## 3 Results

In the neutral field, the "bioplasmatic corona" showed peaceful regime, where there was shining of blazing and glowing energy. The length of corona was about 1.5 cm (Fig. 1a) Almost identical pictures were obtained with all four persons examined.

In the second case, all four persons stood in the HGP field. There were significant changes noticed in all four cases.

The compactness of corona was missed. Almost perfect circle in the neutral field disappeared. There was an uncontrolled shining in certain parts, and missing or weaker corona in other places. A discrete, illegible bright field was noticed, which had not been previously seen. In several places, there were visible traces of energy, which were no more in relation to the corona (Fig. 1b).

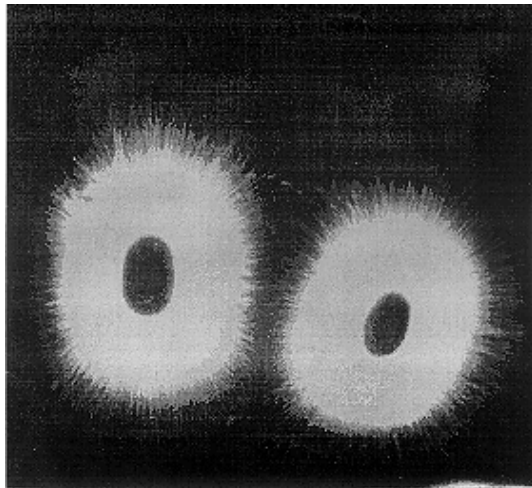

(a)

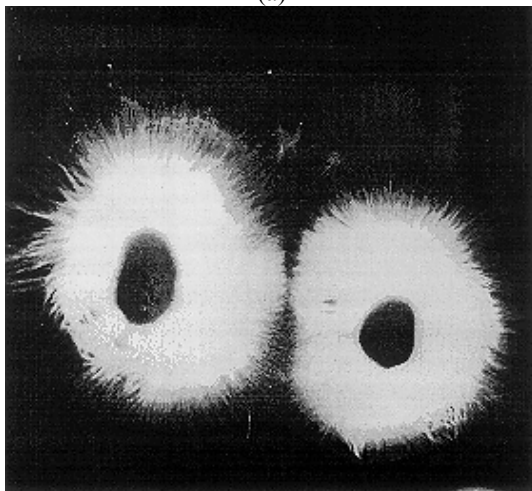

(b)

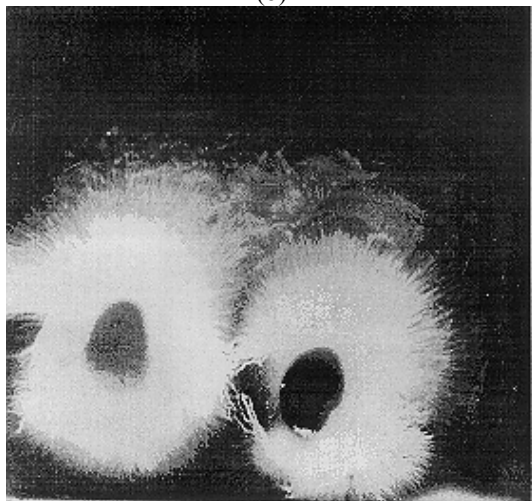

(c)

**Figure 1** Kirlian photographs of fingers in: (a) neutral zone; (b) Hydrogeopathogenic (HGP) field; and (c) Hartman knot (zone of intersection of the two HGP fields).

In the third case, the persons examined were placed in the Hartman knot. The coronas show even greater and more significant disorders. The compactness of the corona was significantly disturbed. Uncontrolled emissions of the biosystem energy were also significant. In one part, a chaotic emptying could

be noticed, and a turbulent reaction of the biosystem was evident. The persons examined subjectively felt only certain uneasiness that they were not able to define (Fig. 1c).

The aim of the whole research was not only the influence of the exogenous factor, that is, the influence of HGP field, but establishing the characteristics of the visible part of the biosystem, as much as it was possible using this technique of work.

\*

I have been working on this for 20 years already, and not only in this experiment, but also in many previously made, I managed to obtain not only various shapes of the corona, but also different levels, which I consider most significant.

I have obtained, or better say, registered, four levels of aura spreading, in other words, the biosystem visible on the photographs taken by Kirilian method.

The first level spreads around the pulps of hand fingers, since they seem to be the most suitable for photographing. The field was thick, there was no disorder, so almost concentric circles were obtained (Fig. 2a).

The second level showed two different parts. In the first part of the aura, closer to the finger, a compact field could be seen, similar to the first example. In the other part, a field was registered that seemed to have weaker intensity, and seen as substantially sparse shining with bright separated strips with spaces between them, where no energetic activity could be seen. The width was around 3-5 cm, taking into account both fields. The width of the other field differed, depending on the example (Fig. 2b).

The third level was even more interesting. It was registered as bright circles around the previous two. It was about 5 mm wide. On the negative, it was seen as a bright circle, while on the positive it was dark and very difficult to obtain, due to characteristics of the technique, and maybe even the paper used. It was much more visible on the negative (Fig. 2c).

The fourth level was obtained accidentally. One of the persons tested asserted that, at a certain position of his hand, he could see shining field "rising" from the fingers of his hand, or emitting shining field the intensity of which depended on the person's mood. The shining field was spreading upwards.

I turned the Kirilian camera sidewise in order to eventually catch this shining field and take a picture on the X-rays film as I did with the others.

The shining field was visible. It filled the whole film up to its end. Even more interesting were the islands of energy (not artifacts), noticed within the field itself, for which I had no explanation (Fig. 2d).



(a)

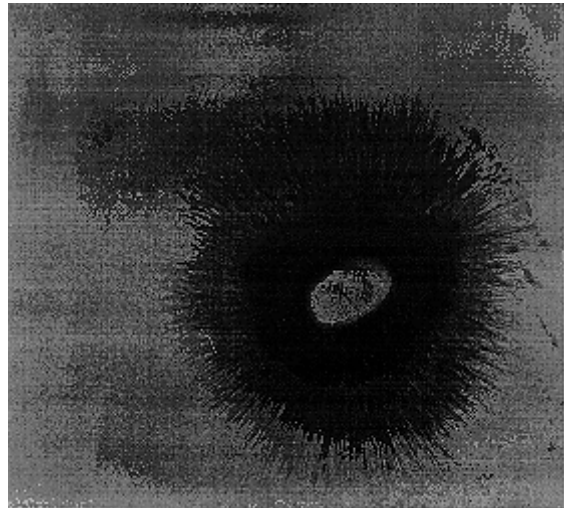

(b)

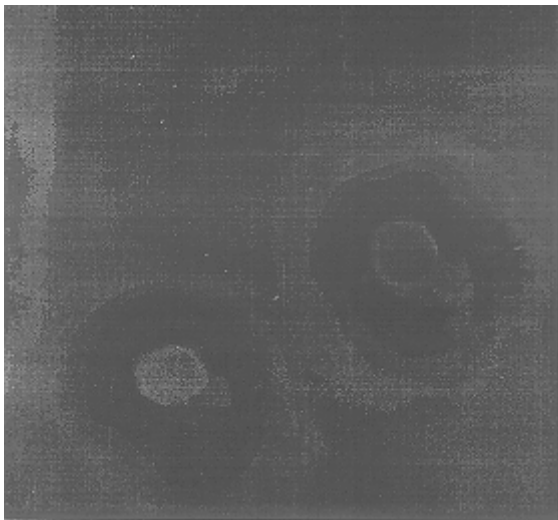

(c)



(d)

**Figure 2** Kirlian photographs of fingers with observed four different levels (a-d) of the fine structure in human “bioplasmic corona” around fingers (see the text for details).

#### 4 Conclusion

In this paper, an irrefutable influence of the hypothetical hydrogeopathogenic field can be seen. Its characteristics are still to be established. However, the influence of this field on the biosystem is evident. The biosystem, gradually but undoubtedly, gets damaged, changed and finally, due to the biofeedback influence on the somatic, it becomes seriously and sometimes irretrievably damaged (like in endemic nephropathy of neoplasm [4]).

The human biosystem seems to be in constant interaction with the surroundings. It receives and emits signals or messages, being only a part of the universal biosystem on the micro or the macro planes. The human biosystem might be also closely related to human consciousness itself. According to which laws it functions, it is going to be discovered once the nature of the biosystem is discovered.

#### References

- [1] Y. Omura, *Acupuncture Medicine* (Japan Publ. Inc., Tokyo, 1982).
- [2] Y. Omura, Acupuncture, infra-red thermography and Kirlian photography, *Acup. & Electro-Therapeut. Res., Int. J.* 2 (1976), pp. 43-86.
- [3] J. La Maya, *La médecine de l'habitat* (Editions Dangles, St. Jean de Braye, 1983).
- [4] V. Momčilović, Environmental factors and habitation locations as a possible influence on appearance of endemic nephropathies, in D. Raković and Đ. Koruga, eds., in *Exogenous and Endogenous Biological Interactions: Biophysical and Biochemical Aspects* (Molecular Mashines Research center, Belgrade University, 1996), in Serbian, and references therein.





## A PROPOSAL FOR EEG MONITORING

Bogdan Janković<sup>1</sup>, Milka Čulić<sup>2</sup>, Jasna Šaponjić<sup>2</sup>, Slobodan Udović<sup>1</sup>,  
Slaviša Popović<sup>2</sup>, and Milena Janković<sup>2</sup>

<sup>1</sup>Center for Multidisciplinary Studies University of Belgrade,

<sup>2</sup>Institute for Biological Research, Belgrade, Yugoslavia,

E-mail: ejankovb@ubbg.etf.bg.ac.yu

**Abstract.** Pathological as well as normal physiological states provoke characteristic EEG forms. For evaluation of EEG signals many different methods were proposed. One of well known methods which is routinely applied is spectral analysis of EEG signals, and among them the most popular are power spectra. The proposed method is based on evaluation of "energetic" state of EEG. So, different physiological states could be distinguished by corresponding energetic states of EEG signal. For evaluation of these energetic states, a special parameter, named *Q-factor*, is proposed. The parameter *Q* has also its physical meaning and represents an amount of released energy in a half period of mean alternating signal of EEG sample in observed time-interval. This parameter is a measure of energy of alternating part of EEG signal, and function of time of this parameter, so-called "*Q*-diagram" represents energetic function of EEG signal. In some cases this parameter gives better estimation than total power spectra. One of advantages of *Q* parameter is that time-interval could be relatively shorter (about 1s, and less), than the duration of an epoch for power spectra evaluation (typically 8s), so this parameter could be used as an announcement of a new energetic situation, which can correspond to a new state.

**Key words:** *electroencephalogram, EEG monitoring, signal analysis.*

### 1 Introduction

"The electroencephalogram (EEG) is defined as electrical activity of an alternating type recordable from the scalp surface after being picked up by metal electrodes and conductive jelly" [1]. The EEG can also be recorded from the cortical surface (for instance, during surgery in humans or through implanted electrodes in animals), which is known as the electrocorticogram (ECoG), or from implanted depth probes, so called "depth electrogram".

It is known that different normal physiological states like waking (alertness, or even cognitive engagement), or drowsiness and sleep, provoke characteristic EEG patterns. So, the phases of sleep correspond to the particular EEG. On the other hand different pathological states like coma, different damages of brain following head injury, stroke, tumor etc., some neural diseases, like epilepsy, sleep disorders and even brain death are characterized by

different electroencephalograms. Thus, the EEG is an important diagnostic test in clinical neurology. Many drugs affect the EEG, particularly when administrated in some pathological states, for instance in epilepsy. However, the nature of EEG activity has not been completely explained by today's neuroscience.

So, it is very important to have effective methods for monitoring and quantification of EEG activities, which characterize states mentioned above. Many of such methods are based on different analysis of EEG signals, which are defined as functions of these activities in time [2]. Some of these methods are adapted for computer processing. Among them the most popular is spectral analysis, which has been used in clinical practice for a long time. Now, one new method is proposed, which also could be used on computers. The main premise of this method is that different physiological and pathological states correspond to "energetic" states of EEG activity, which could be effectively estimated by EEG signals. In Section 2 the notion energetic state of EEG is defined, and it is shown how it could be evaluated. Various applications of this method are presented in Section 3.

### 2 Methodology

From the signal analysis viewpoint, it has to be supposed that EEG activity is produced by nonstationary random processes, and consequently EEG signals could be classified as nonstationary, whose statistical parameters generally are time-varying functions [3]. However, most methods in signal theory are applicable for signals with stationary statistical parameters. So, EEG signals are analyzed in "representative" epochs, time-intervals where these statistical parameters could be considered stationary. This is the main assumption for most computer-based processing of EEG signals, and this is also applicable for the proposed method.

As it was mentioned earlier, this method is based on the estimation of energetic state of EEG signal. A sample of an alternating EEG signal, where DC component - mean value is removed, in a representative epoch (8s) is displayed in Fig. 1.

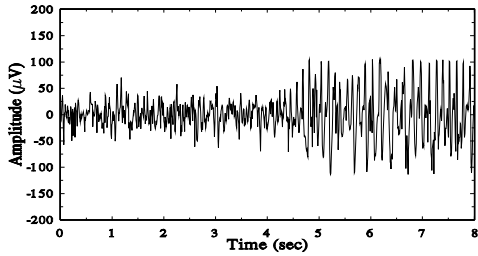

Figure 1 A Sample of EEG signal

Let  $x(t)$  be a potential value of EEG signal at the moment  $t$ , then the amount of released energy  $E(\tau)$ , during the interval  $\tau$ , is given by

$$E(\tau) = c \int_t^{t+\tau} x^2(t) dt. \quad (1)$$

Unfortunately, the function  $x(t)$  is unknown, hence, the problem is how this released energy can be estimated? In order to solve the problem, let us try to evaluate the released energy of some well defined signals. The first such candidate is a simple sinusoidal signal

$$y(t) = A \sin 2\pi ft. \quad (2)$$

For this signal the energy which is released in one half of its period is given by the following transformation

$$E(T/2) = c \int_0^{T/2} A^2 \sin^2 2\pi t dt = \frac{cA^2 T}{4} = \frac{cA^2}{4f} \quad (3)$$

For the simple periodical signal the released energy in a half of its period is directly proportionate to the amplitude square and inversely proportionate to the frequency of signal. On the other hand, the released energy is given as effective power multiplied by passed time interval ( $T/2$ ), or divided by frequency of signal ( $f$ ). This value is defined as a measure of the energetic state of this simple periodical signal

The same results could be derived for signal sampled, if it has to be processed by computer. In case of a stochastic signal, which an EEG signal in fact is, for the computer processing, this signal must be first sampled, according to Nyquist sampling theorem [3]. To estimate released energy of sampled EEG signal during time-interval  $\tau$ , the following two parameters are evaluated. The first is  $V$ , the variance of sampled values of EEG signals in interval  $\tau$ . The second parameter  $NZ$  is a number, which shows how many times this signal crosses a mean-value line. This parameter is also known as "zero-crossing number". For the first parameter  $V$ , it is known from signal analysis theory [4], that the variance of a sampled signal in a time-interval is proportionate to the mean power value of the alternating component of the analog signal in the same interval. On the other hand,

$NZ/\tau$  correspond to a number of semicycles of a mean alternating signal in the interval  $\tau$ .

The parameter derived,

$$Q = \frac{V}{NZ/\tau} = \frac{V}{NZ} \tau, \quad (4)$$

is proportionate to the work, or an amount of released energy in a semicycle of a mean alternating signal in observed time-interval  $w$ . This parameter is named  $Q$ -factor and could be used for an estimation of energetic state of EEG signal.

### 3 Applications

One of the first applications of  $Q$ -factor was a methodology specially developed for detection of an appearance of desynchronization in EEG signals [5]. The phenomenon of desynchronization is observed, for instance during recording of EEG activity, when patient opens his eyes, or in some mental engagements, or in states of human and animal alertness, etc. This phenomenon is characterized by changes in EEG signals from slow high-amplitude activity to fast low amplitude activity. From the point of view of signal analysis, the phenomenon of desynchronization could be treated as simultaneous changes of amplitude and frequency of an observed EEG signal. In order to interpret this in terms of "energetic states", it could be concluded that during the appearance of EEG signal desynchronization, it changes abruptly its energetic states from high to low values, which correspond to same values for  $Q$ -parameter. It could be said that  $Q$ -factor is an appropriate parameter for detection of similar changes in EEG signals. The proposed method is not only used for detection of the beginning of desynchronization, but also of its duration. The method is adapted for computer processing. The evaluation of desynchronization is done in relative terms. The current value of parameter  $Q$ , and its "background" value,  $Q_b$ , are computed. This "background" value is also called "moving average", and represents the mean value for the last  $k$  values of  $Q$ :

$$Q_b = \frac{1}{k} \sum_{i=j}^{j+k-1} Q_i, \quad j=1,2,\dots \quad (5)$$

The criterion of desynchronization is formulated as a condition when the current value of parameter  $Q$  is smaller or equal to the given percentage of  $Q_b$ . This method was implemented as a program on a mini computer, DECLAB 11/40, and was used for examination of states of EEG activity of cats during conditioning. Similar methodology and the program were used for evaluation states of relaxation, which correspond to particular values of  $Q$ -factor [6].

A second application, where  $Q$ -factor could be used, is the on-line separation of characteristic samples of EEG signal during ongoing EEG activity

[7]. Fig. 1 gives a sample of EEG signal, which contains characteristic pattern -"spike-wave" complex, which is accompanied with an epileptic discharge in penicillin evoked epilepsy, known also as "petit mal" epilepsy. The presence or the absence of these epileptic patterns in EEG samples, influences very much the variability of their signal characteristics (power spectra, for instance). In order to investigate this phenomenon more completely, three consecutive intervals are of peculiar interest. These intervals are: (1) the interval of EEG signal, which precedes immediately an epileptic discharge; (2) the interval of EEG signal during the attack itself; and (3) the interval of EEG, which takes place immediately after an attack. The  $Q$ -diagram (for  $\tau = 0.5s$ ) of the same sample of EEG signal (Fig. 1), is displayed in Fig. 2.

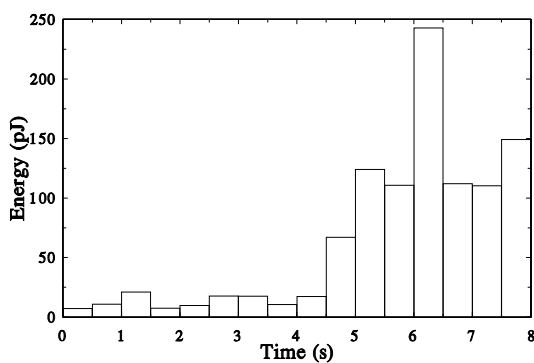

Figure 2  $Q$ -diagram of EEG sample

$Q$ -diagram points with abrupt increase of  $Q$  values coincide with the beginning of the epileptic discharge. Thus, the occurrence of this discharge could be detected on-line, if in current  $\tau$  interval the value of  $Q$ -factor exceeds some prescribed value. The separation of EEG signal, which corresponds to these three consecutive intervals, based on detection by  $Q$ -factor, is implemented as procedure SEP DAT. The detection by  $Q$ -factor acts like "pretriggering facility" of a digital oscilloscope, for storing a sample of EEG signal immediately before an epileptic discharge. The prescribed value for  $Q$ -factor could be defined either absolutely, as fixed value, or relatively as a percentage of so called "background" value  $Q_b$ , (5). If the current value of  $Q$ -factor exceeds a given percentage (the threshold) of  $Q_b$ , or of a fix defined value, then the appearance of an epileptic attack could be expected. The separated samples of EEG signal are stored as files on hard disk. The time precision - the resolution of interval separation, is determined by value of  $w$ , in which  $Q$ -factor is evaluated. This value is 0.5s in this example. This value could be reduced even more, but it should not be less than 0.25s, as the lowest dominant frequency in an attack could be 4Hz. This resolution is much better than it could be obtained by other techniques, for instance based on FFT, where analyzed epoch must be at least 1s or more.

A third possible application of  $Q$ -factor is based on using its mean value and dispersion, which are

obtained from longer intervals of EEG signal. These values are used as evaluation parameters to distinguish various physiological states or treatments. For instance, in order to compare different EEG activities, EEG signals are observed in a number of intervals, called epochs. For each epoch, the mean values of  $Q$ -factor, for given  $\tau$ , are computed. Then, for all epochs, the overall mean value of  $Q$ -factor and its dispersion are computed. These values, with the corresponding values of another EEG activity, are compared according particular statistics (Student's t-test,) in order to evaluate the difference between these activities. If duration of epochs is the same as for spectra analysis, then this method could be compared with methods based on some parameter of spectra analysis, the total power spectra, for instance [8]. The conclusion of this investigation points out that  $Q$ -factor and total power spectra are in high correlation, and in some cases, this method gives better estimation than method based on total power spectra [8].

For computer processing of all of the above mentioned applications, a series of program procedures was implemented and organized as a package for acquisition and analysis of EEG signals [9].

## 4 Conclusion

The proposed method for EEG monitoring has the following characteristics:

- (1) The  $Q$ -factor is a measure of energy state of alternating component of EEG signal. Therefore, the changes of amplitude and frequency could be observed simultaneously.
- (2) The evaluation of  $Q$ -factor is simple and fast. In fact, it is necessary to compute only two parameters: variance  $V$  and zero-crossing number  $NZ$  of EEG signal in time interval  $\tau$ . The following consequences are: (a) it could be used in on-line applications, and (b) several independent EEG channels could be processed simultaneously.
- (3) The resolution in EEG pattern separation is better than it could be achieved by other methods, e.g. Fast Fourier Transform.
- (4) The criterion for EEG pattern separation in practical application, demands certain experience of the user, especially in choosing appropriate values for threshold parameter and number of time intervals  $k$ , for determination background mean value  $Q_b$ . Also, in certain cases it is difficult to distinguish one EEG pattern from another, e.g. it is difficult to distinguish an epileptic discharge from a spindle in slow-wave sleeping. Therefore, in such cases, after separation of EEG patterns, more sophisticated methods should be used for successful classification of these patterns.
- (5) Statistical parameters of  $Q$ -factor, such as mean value and dispersion, could be used for evaluation of different physiological states, based on EEG signal. It was pointed out that in some cases these parameters give more significant estimation.



## References

- [1] R.G. Bickford, EEG, in G. Adelman, ed., *Encyclopedia of Neuroscience* (Birkhauser Press, Boston, 1987), pp. 371-373.
- [2] E. Niedermeyer and F. Lopes da Silva, *Electroencephalography: Basic Principles, Clinical Applications and Related Fields* (Urban & Schwarzenberg, Baltimore, 1982).
- [3] J.S. Bendat and A.G. Piersol, *Random Data: Analysis and Measurement Procedures* (John Wiley&Sons, 1971).
- [4] P.A. Lynn, *An Introduction to the Analysis and Processing of Signals* (The Macmillan Press Ltd., 1977), pp. 80-84.
- [5] Z. Damjanović, J. Ivanuš, B.I. Janković, and Lj. Kojić, Fast analysis of changes in EEG signals, *Proc. of DECUS Symp.*, Hamburg, Sept. 1981, pp. 153-155.
- [6] B.I. Janković, A. Kostov, and S. Šuljagić, Some new research techniques and technologies of relaxation state by using EEG signals, *Proc. 6th Int. Conf. Psychotr. Res. "Psychotronics - Science Nowadays - New Technology"*, Zagreb, Nov., 1986, pp. 251-253.
- [7] B.I. Janković, J. Ivanuš, N.N. Lyubimov, R. Veskov, and Lj. Rakić, On-line separation of EEG intervals during systemic penicillin epilepsy, *Abstracts 5th Sym. Restor. Neurol.*, Irkutsk, March 1990, p. 248.
- [8] S. Udović, *Electroencephalographic Changes in Acute Model of Epilepsy in Rats Treated by Neurotoxin DSP-4*, M.Sc. Thesis, University of Belgrade, 1995.
- [9] B.I. Janković, A. Kalauzi, M. Čulić, J. Šaponjić, and M. Janković, Programming package for acquisition and analysis of EEG signals, *XLI ETRAN Conf.*, Zlatibor, June 1997, (in press), in Serbian.

## A MODEL OF CONSCIOUSNESS: AN ENGINEERING APPROACH

Emil Jovanov

Institute "Mihajlo Pupin", Volgina 15, Belgrade, Yugoslavia  
&  
Faculty of Electrical Engineering, University of Belgrade, Yugoslavia  
E-mail: ejovanoe@ubbg.etf.bg.ac.yu

*The Kingdom of Heaven is not a Place,  
but a State of Mind*

**Abstract.** Consciousness, as a complex phenomenon, arises on a hierarchy of human rhythms and their interaction with environment. We present here a model of consciousness represented as a parallel distributed multiprocessing system with rhythmic scanning within a set of active modules. Dominant "gestalt" activity is then created by global exchange of information on "system bus" and by means of common electromagnetic field of brain waves. Module priority is dynamic and determined by available time slot on the system bus, electric potential, and module's metabolism (energy budget). The main system strategy could be defined as minimizing energy consumption. Limbic system has a crucial role, as evolutionary role of module activation distracts stable mentation and stream of consciousness. Proposed model is used to analyze normal as well as possible states of expanded consciousness.

**Key words:** *consciousness, engineering model, rhythms, brainwaves, distributed multiprocessing system.*

### 1 Introduction

At present prime time of consciousness studies, the main mistake of many researchers is expectation to resolve consciousness phenomena on a single level, either micro (atomic) or macro level (universe). We believe that consciousness exists as eternal play on a hierarchy of processes, and that different states of consciousness represent only our ability to comprehend its complexity. Measure of consciousness is therefore span of our awareness of this multitude of processes.

One possible approach to analysis could be to observe man as a complex system, and use engineering methods to analyze its performance. Normal human performance is reasonably well explained in different scientific disciplines. However, altered states of consciousness, as the most boundary phenomena, are indispensable for system identification and characterization [1]. Although human performance in normal state of consciousness is amazing, its expansion during some altered states is really fascinating. How can it be possible to enormously increase processing performance? It is often reported that when our life is in danger, our

possibility to analyze the situation, retrieve images, and other information, becomes incomparable to our normal state. The crucial question is what makes this activation of hidden reserves happen, and is it possible to systematically improve one's performance?

Main problems facing scientific investigation of these phenomena are poor reproducibility and inadequacy of objective measures. What makes one meditation successful, can we rely on subjective report of the meditant, how can we judge healer, and what is a successful healing session? How can we set weighting factors on any objective measure we got from our experiments? Transient nature of phenomena observed makes results of statistical analysis even fuzzier.

Our interaction with environment is usually missed from exploration. Man's functions are very well adapted to changes in his environment. Although not crucial for basic functions it should be carefully analyzed in analysis of subtle phenomena. Our internal rhythms interact with external rhythms. The most important slow rhythm is daily rhythm sensed directly as change of light. Rhythms connected with daily rhythm are called circadian (example is pineal gland melatonin secretion). Some experiments in the absence of natural light have shown that basic human "clock" is actually slightly longer than one day, and closer to one lunar day (24h 50min) [2]. Lunar day has similar period (24h 50min). On a slower scale strong influence on Earth's geomagnetic field have the following periods: Moon rotation (29.5 days), Earth rotation (365.25 days), Sun spots (11 and 22 years), nutation cycle (18.6 years), rotation of planets (88 days to 247.7 years), all the way to galaxy rotation cycle (250 million years) [2].

Very important rhythms are in the order of 1-2 hours, as hormone extraction, and dominant nostril exchange [3]. In the range of human EEG we have Sun's electromagnetic oscillation of 10Hz [2], while system Earth-ionosphere is resonant at frequencies in theta, alpha, beta1 and beta2 band (so called Schumann resonances [4]). Different species often have internal generators of environment rhythms,

which could be extremely precise, up to  $10^{-4}$  [5]. Frequency of these oscillators is then PLL synchronized with natural rhythms. Environmental synchronization sources are often called "zeitgebers". Mechanism of optical synchronization is shown in [2, 6]. Presented rhythms should inspire better understanding of interaction of internal and external rhythms during specific states of consciousness.

At the present moment neurophysiological basis of consciousness is represented by thalamocortical model with different modalities (as a reference we advise proceedings of electronic symposium "Thalamocortical Foundations of Conscious Experience" - <http://www.phil.vt.edu/assc/esem.html>)

Crick first emphasized the importance of thalamocortical connections in 1984 [7]. He pointed out on its remarkable position and connections. Most neurons have their dendrites spread around thalamus and "gate" access to the cortex, which makes possible extensive exchange of information. LaBerge hypothesized that attention can be expressed as a relative increase of information flow on particular pathways against the others, emphasizing possible role of thalamocortical structures in this process.

Baars developed the model of Global Workspace [8] (GW), in which the most active coalition of modules receives control over GW. The most important part of this model represent ERTAS (Extended Reticular Thalamic System), which in addition to RAS emphasize the role of thalamus and its projection to cortex.

This paper introduces a model of conscious processing analogous to distributed real-time multiprocessing system. Although primarily theoretical, this model also makes possible simulation and analysis of altered states of consciousness.

## 2 Electromagnetic Activity of CNS

It may look that search for EEG correlates of subtle states of consciousness is similar to the analysis of modem signal transferring text between two computers. Although spectral analysis of modem signal will not reveal the nature of the story, the same analysis of speaker's voice may have. We believe that subtle states have their EEG correlates, the same way as gross neurophysiological states of consciousness. As an example, it has been reported that EEG correlates of low concentration odors appear at lower concentration, even without being perceived.

Conscious processing has very dynamic nature and includes variety of spatio-temporal patterns of activity. William James wrote in 1890 about "stream of consciousness" and "centrality of attention". Rhythms of EM activity of CNS evolved from epiphenomenon (during 50's EEG was considered as brain "noise") to correlates of successful cognitive tasks [9, 10]. Different frequencies of brain's EM activity may represent different levels of hierarchical processing (see Jovanov [11]).

It is supposed that integration of sensory information is performed by 40Hz scanning (synchronous oscillations) [7, 12]. MEG studies of cognitive tasks have proved the existence of impulse packets on 1000Hz, every 12.5ms. Even more important is the fact that consciousness of separate sensory information exists only if inter-stimulus time exceeds 13.7ms [12]. It is interesting to notice that some species of electric fish living in muddy waters "scan" its environment using continuous sinusoid of 50-1000Hz, or using impulses lasting 1ms on every 25ms (which is 40Hz) [5].

EM field perception for different animal species is well confirmed, but still has to be proved at man [5]. Possible mechanisms for this perception are outlined by Adey [9], and Raković [4]. Excessive exposure to EM field is proved to distract function of the pineal gland, and specifically the mechanism of circadian rhythm control [13]. Possible role of magnetite crystals in brain tissue is still not discovered. The open question is also interaction of environment EM fields and human brain rhythms, especially if we have in mind their close frequency. It is logical to assume that these rhythms are developed as a response to changes in environment, and a better understanding of mechanism of interaction of internal and external rhythms may lead to understanding of human subtle phenomena. Raković developed biophysical model of altered states of consciousness based on these characteristics of human environment [4].

## 3 Conscious Processing Model

This hypothetical model of consciousness as a real-time distributed, parallel, multiprocessing system with common bus is developed having in mind anatomy and physiology of central nervous system (CNS).

Processing of distinct sensory signals is performed by specific thalamocortical system [6], which consists of functional unity of specific thalamic nuclei with projected cortex cells. This unit (or module) is represented in our model as a single processor on a common system bus. Some modules are dedicated (like audio, motor, visual, etc.) while the others are general purpose or associative. Module is characterized by processor (CPU), permanent memory represented by genetically inherited anatomic organization (ROM), temporary working memory (RAM), and local connections with neighboring modules. Associative modules carry dynamic pictures of working space, that can be represented as successful copies of working programs or memorized experience.

In the case of an already experienced situation these modules control the activity (automatic action), while in a new situation modules have to intensively cooperate to modify existing (or create new) programs for this particular situation. On neural level, learned experience is "hardwired" (static mapping) with

established synaptic weights, while the new situation is resolved by simultaneous activation and synchronous activity of different regions (modules).

Global exchange of information is accomplished as:

- exchange on global system bus (neural transmission), and
- by means of common EM field of brainwaves.

Possible role of system bus, according to the existing findings, may have nucleus reticularis (NRT). The main issue in this case will be control of system bus and global exchange of information.

Global coordination should be performed on two levels:

- (a) detection of synchronous activity in different modules, and
- (b) information exchange between synchronous modules.

The first level is equivalent to acquisition of information from the environment, and it is possibly realized using synchronous 40Hz oscillation [12]. It is important to emphasize that system "gestalt" is formed 100-200ms after the stimulus, although analysis, cognitive processing and preparing of action goes in the meantime. Having this in mind Gray represented consciousness as an output of comparator that compares "inner plan of action" with outer state [14].

Most models consider permanent requests for global workspace from different modules, and grant it to the most active set of modules (Winner Take All neural network). However, in the proposed model control of system bus is seen as a serial scan of set of active modules, where every module receives particular time to control the system bus (time slot). Scan clock is possibly internal clock ("pacemaker") synchronized with some rhythm from the environment. For the sake of global synchronization EM rhythms of Earth and Sun probably have significant role. This function could be contributed to Intralaminar Nucleus (ILN formation) [12]. It is shown that injury of this small group of neurons cancels conscious state as well. This fact can perfectly fit in our model where lack of global synchronization breaks off global exchange of information, and therefore consciousness itself.

Global state of the system can be characterized by a set of active processes and processors (modules). Every processor has dynamically given time slot on the system bus, when its local process becomes global. An active set of processes represents a set of uninhibited modules that access system bus, or global workspace. Total system cycle is then given as the sum of individual time slots of active modules.

Change of module priority can be represented as a combination of the following mechanisms:

- (a) increase of available time slot on the system bus,
- (b) change of processing performance that can be realized as:

- local change of region potential (it can be seen as CNV potential for evoked responses or long term integral of module activity [9, 15, 16]), and
- increased metabolism, supported with regional blood flow, and manifested as a slow-frequency EEG component [17, 18].

Different methods of functional brain imaging have shown that even when your attention flits, it flits to one thing at a time.

Default inherited modules bus priority is evolutionary developed as a set of priorities established to increase probability of surviving. As a characteristic example, we can take animal which on a potentially dangerous sound "becomes an ear", suspending all the other modules. As a consequence all available energy budget is given to the sound processing modules, and its result is globally available.

Module activation increases local metabolism of the region. As a consequence, part of ANS will be activated to support control of increased metabolism, which includes a number of biochemical and neural processes. All this activity further increases metabolism as well as overall activity in the region, acting as a passive "noise" interfering with module output. Moreover, activation of limbic system itself decreases available system bus throughput, and increases energy consumption. We refer to this complex of problems as "*metabolic noise*".

Therefore, unlike computer systems, processing change processing conditions, influencing retroactively the process itself (stream of consciousness)!

Consequently, in normal state you can not allow large number of active modules. As extreme case clinical death represents extreme decrease of metabolic noise, which allows for a short time super consciousness of subtle signals that are not available in normal state. It can be basis for explanation of Near Death Experience phenomena.

Basic strategy of the system is defined as minimization of energy consumption, and can be realized using following mechanisms:

- Decreasing system scan frequency,
- Decreasing number of active modules, and
- Decreasing energy consumption for individual modules.

We can find all these mechanisms in dream state. Decreased mean EEG frequency may represent lower scan frequency. Fast spindles during sleep onset could be considered as manifestation of "check out" procedures that take place to define state of the system before the module is set to low activity mode of operation. Then some senses are deactivated to decrease number of active modules, and activity on specific modules is decreased to the level of possible recognition of dangerous situation. It can be also considered that during sleep associative regions modify their model of reality according to the previous experience. Improved model (and its

effectiveness) is, of course, of great evolutionary value for animal species.

A second characteristic state is meditation. It makes use of consciously decreased physical awareness, and therefore decreased number of active modules. As a consequence decrease of scanning frequency is visible (which can be represented as decreased mean EEG frequency [19, 20]). In addition, decreased activity of physical awareness modules makes available additional energy within the existing energy budget. This energy could be used either to increase the activity of currently active modules or to activate additional set of associative modules.

During normal states of consciousness associative modules make possible centralized control with minimal energy consumption. Modified or new situations further energize sensory and associative modules to modify existing spatio-temporal pattern of activity. It is equivalent to the modification of existing memorized program. Automatic activity can also de-energize nervous system to the sleepy state (reduced wakefulness).

### 3.1 Role of Limbic System

In the proposed model limbic system is not just an ordinary module. Its role is crucial because of its influence on vegetative nervous system. Evolutionary, this function is of great importance, because it makes possible high priority activation of the set of modules necessary for survival.

However, the same reaction takes place even in a case that dangerous content is not real, but existing only as a mental content. That will definitely change "stream of consciousness" and processing itself. As we can not consciously control function of limbic system, we can not control stream of our consciousness either. That it is the reason for the wandering mind that can not be stable on one particular point. In this light we can understand Patañjali's sutra ("yogah cittavrtti nirodhah") as a cessation of movements in the consciousness, or attaining stable flow of consciousness.

### 3.2 Toward Super-Consciousness State

What is psycho-physiological basis of super-consciousness state that characterizes some altered states of consciousness [1]? Based on the proposed model we can analyze the following mechanisms:

- *Inhibition of sensory and motor modules* which have no relevance to the current focus of attention. As an example we can consider focusing on music with inhibited other senses and physical consciousness. Consequently, decreased flow of sensory information releases new energy within the available energy budget, decreases system bus overhead in favor of active processes, and decreases system metabolic noise.
- *Stable focus of attention* independent of its content. Perpetuated effort to stabilize focus of

attention leads to willingly regulated limbic system and weakening of its feedback on the flow of consciousness. After that change, normal consciousness is not "fighter for ends" anymore, while new, extended consciousness represents "detached observer" capable of observing his environment as it is. That way leads toward "ultimate reality" [22], without sympathetic burst of unsupervised ANS [23].

- *Stabilization of basic physiological rhythms* and constituting consciously controlled center of physical consciousness. As a consequence, global information exchange cycle is increased for amount necessary to control these rhythms in a normal state, and metabolic noise becomes discrete instead of wide-band. It is shown that stabilization of physiological rhythms stabilizes CNS rhythms as well [20]. We can compare this effect as an effort to look at a far-away scene from a boat on a lake. If waves rocking the boat were irregular it would be very hard to concentrate. On the other hand, if waves are regular (no matter if they are large) it would be much easier to maintain stable focus of attention. It could be considered that stable physiological rhythms could provide the base on which extended consciousness arises. It has been shown that insights objectively characterized as sudden and instantaneous, are preceded by characteristic pattern of brain electrical activity [24].
- *Decreased energy consumption.* With stable consciousness decreased energy consumption decreases metabolic noise, bringing awareness of subtle phenomena.

## 4 Conclusion

The proposed model offers an alternative view of conscious processing, providing a theoretical framework for practical experiments. From this perspective it looks like Rodin's sculpture "The Thinker" represents a wrong archetype, as intensive physical effort visible on this statute in our model increases metabolic noise, and energy consumption and decreases available time slot for conscious processing of the higher level. Physical effort is useful only as association to situation that required the same effort. It is not strange therefore that a large number of great inventions is conceived during sleep, while metabolic noise is minimal, and motor and sensor areas inactive.

Many experiences of expanded consciousness are described as sudden and without obvious cause. They could be triggered by a simple sound or visual stimulation (flow of water, falling leaf, etc.). Missing link for those descriptions is long period (usually 3-12 years) of preparation for that sudden moment of clear consciousness. During this period, we believe, certain psycho-physiological base is prepared for higher state to land. Systematic investigation of that preparatory

period, changes on all hierarchical levels of human existence, and practices supporting this kind of change could bring us closer to the ultimate phenomenon of Being, the Consciousness.

## References

- [1] In C. Tart, ed., *Altered states of consciousness* (Academic, New York, 1972).
- [2] *Britannica CD 2.0* (Encyclopaedia Britannica, Inc., 1995).
- [3] *Swara yoga* (Bihar School of Yoga, Munger, Bihar, India, 1983).
- [4] D. Raković, Neural networks, brainwaves, and ionic structures: Acupuncture vs. altered states of consciousness, *Acup. & Electro-Therap. Res., Int. J.*, 16 (1991), pp. 89-99.
- [5] I. Wickelgren, The strange senses of other species, *IEEE Spectrum*, March 1996 (1986), pp.32-37.
- [6] A.C. Guyton, *Medical Physiology* (Medicinska knjiga, Beograd, 1978), in Serbian.
- [7] F. Crick, *The Astonishing Hypothesis. The Scientific Search for Soul* (Charles Scribner's Sons, and Maxwell Macmillan International, 1994).
- [8] J. Newman, Thalamocortical Foundations Of Conscious Experience, <http://www.phil.vt.edu/assc/newman/default.html>, 1996.
- [9] E. Basar, ed., *Dynamics of Sensory and Cognitive Processing by the Brain* (Springer Verlag, Berlin, Germany, 1988).
- [10] P.L. Nunez, *Neocortical Dynamics and Human EEG Rhythms* (Oxford University Press, 1995).
- [11] E. Jovanov, On methodology of EEG analysis during altered states of consciousness, in D. Raković, and Đ. Koruga, eds., *Consciousness: Scientific Challenge of the 21st century*, (ECPD, Belgrade, Yugoslavia, 1995), also on <http://www.vxm.com/21R.94.html>
- [12] K. Sauve, *Time in thalamocortical processing*, <http://www.phil.vt.edu/assc/newman/sauve.html>, 1996.
- [13] B.W. Wilson, R.G. Stevens, and L.E. Anderson, Neuroendocrine mediated effects of electromagnetic-field exposure: Possible role of the pineal gland, *Life Sciences*, 45 (1989) pp.1319-1332.
- [14] J.A. Gray, On binding and timing, <http://www.phil.vt.edu/assc/newman/gray.html>, 1996.
- [15] S. H. Curry, and C. Pleydell-Pearce, Use of DC recording in the demonstration of functional specialization, *J. of Med. Engin. & Techn.* 19, Nos. 2-3 (1995), pp.42-51.
- [16] N. Konttinen, and H. Lyytinen, Brain slow waves preceding time-locked visuo-motor performance, *J. Sports Sci.* 11 (1993), pp. 257-266.
- [17] J.G. Okyere, P.Y. Ktonas, and J.S. Meyer, Quantification of the Alpha EEG Modulation and Its Relation to Cerebral Blood Flow, *IEEE Transactions on Biomedical Engineering*, 33 (1986), pp. 690-696.
- [18] E. Jovanov, D. Raković, V. Radivojević, and D. Kušić, Band power envelope analysis - a new method in quantitative EEG, *Proc. 17<sup>th</sup> Ann. Conf. IEEE EMBS* (1995).
- [19] G.C. Ray, Higher stages of Rajayoga and its possible correlation with process of evolution, *Journal of the Institution of Engineers (India)*, ID 68 (1988), pp. 37-42.
- [20] M. Satyanarayana, K.R. Rajeswari, N.J. Rani, C.S. Krishna, and P.V. Rao, Effect of Santhi Kriya on certain psychophysiological parameters: a preliminary study, *Indian J. Physiol. Pharmacol.* 36 (1992), pp.88-92.
- [21] B.K.S. Iyengar, *Light on the Yoga Sutras of Patanjali* (Thorsons, San Francisco, CA, 1993).
- [22] G.C. Ray, Likely sympathetic burst on autonomic system just on landing ultimate reality, *Journal of the Institute of Engineers*, April 1997.
- [23] G.C. Ray, A.Y. Kaplan, and E. Jovanov, Morphological Variations in ECG During Music-Induced Change in Consciousness, *19<sup>th</sup> Annual Int'l Conf. IEEE/EMBS*, Chicago, USA, 1997.
- [24] T.A. Vorobieva, and Tcheremouchkin, "Insight" phenomenon: Neurophysiological and psychological characteristics, *The Meeting of European Neuroscience*, Abstract Book, (1995), pp. 183.

## THE PHENOMENON AND COMPOSITION OF THE CONSCIOUSNESS WITHIN SORCERY PATTERNS

Milanko Jovičević

Department of Neuropsychiatry, Military Medical Academy (VMA), Belgrade, Yugoslavia

**Abstract.** The phenomenology of the consciousness, increasingly preoccupies scientific thought within theoretical, practical and investigating domain. This problem today may only be successfully studied in a circle of interdisciplinary areas, by applicable methodology from various scientific disciplines. Human anthropological and ontological, personal and behavioral development, lays upon interactive and complementary relations with the state of his mind and its own development. Within this field, the contemporary science is facing a serious question of contents and state of mind in ancient cultures, for two basic reasons: the first is in order to achieve more realistic relationship and continuity with contemporary knowledge about consciousness phenomena, and the second one is to strive towards understanding the essence of social cultures within Jung's, archetype-like sense about the collective - unconscious psychology. This is emphasized due to the fact that archetype-like motives have very important role and influence over the modern human's behavior as well as over the composition, essence, and a state of his mind. Namely, diversity of magic behavior, and symbolic comprehension and creativity, are co-existing in mutually dependent, functional and co-related bond with the same strength today as it has been in the past. Huge archetype heritage of the old, primitive cultures, in characteristic and symbolic fashion is evident within contemporary societies, reflected in common human behavior. Quite so often, man is even unaware of that. These phenomena-like conscious manifestations are expressed on rational level, and even more so on unconscious, individually irrational and collective scale. In ancient past, and partially even today, this has been so, in order to get relieved and protected from demonic forces, evil and sickness. Practical actions and deeds usually applied and practiced, i.e. heal-crafting over sick person to regain health and other magical maneuvers, are different in protective and healing function, but in essence these are equally dependent on the development level of the ancient cultures' conscious composition, as well as of contemporary societies' one.

**Key words:** *unconscious psychology, archetype-like motives, folk magic, anthropology.*

Ontological and anthropological human personality's behavioral development is followed by the archetype-like contents of the conscious within ancient cultures. Evolution and progressive stream of these processes has undoubtedly basic medical and biological foundations, meaning that the development level of central nervous system anatomy structure, under the influence of triggering environmental factors and also under individual needs and activities, determines the state of conscious functions. Within the

primitive, ancient societies, the conscious composition is determined by magic, symbolic, superstitious beliefs and other kind of archaic thinking. The basic signification of these sorcery acts comes down to humans' protection from evil, demonic creatures and diseases.

Archetype-like forms of magic behavior in ancient cultures are characterized in different forms. For instance, the charms usage in Indo-European culture was aligned with the female cults and was patronized by "Big Mother" - the Ancient Parent, who is the solemn provider of life but also entitled to take it away. Upon the acceptance of Christianity, the Big Mother was identified and replaced with the Mother of God (Virgin Mary) still, keeping certain, previously magical functions. For that reason, the clergy has negative and intolerant attitude towards folk-crafting and sorcery, whilst and its magic act relies upon the church and turns for help to Mother Mary and to the saints. The church, additionally, condemns all other rituals that differ from the officially accepted and recognized ones, heal-crafting inclusive and it prescribes all sorts of punishments for those who derange these, official rituals. For illustration, the clear example (source from the data obtained from [2] Branislava Paunovska-Starcevska), is a case of the village Tearc in Tetovo county, FYROM, and a healing icon in St. Nikola's church which says: "Who turns to heal-crafting, make devils rejoice, and they are ones you take the remedy from, not from God." This clearly explains, in Catholic countries from medieval time unto XVIII century, why the witches have been cruelly punished, beaten and burned on stakes.

The Eastern Christian-Orthodox church was rather tolerant towards pagan and magical rituals in comparison to the attitude of the Western clergy.

Magic actions of crafting are steered towards demonic, impure force, considered as the source for the illness and the damage done to humans. Demonic, evil forces are classified in four groups: Human-like creatures (Anthropomorphic), Windy-build creatures, the creatures in a shape of worm or bugs, and Furry-fairies. Demonic humanoid creatures, most commonly are presented in a form of female, a women who torture and eat people, or suck their blood. Among the diseases, commonly spread on the Balkan region, the most dangerous was plague, called "chuma". This

contagious disease have several understandings: The plague in Serbs', Macedonians' and Bulgarians' interpretation is personified as a woman with loose and long hair, with a clay or twig made pot with the arrows in it, holding it in hand. She also carries a list of humans she is to kill. The other demonic creatures also identify the plague, and also cholera, fever and several other lethal diseases are considered as materialized demonic creatures.

Windy-build creatures also fall under demonic forces, imperiling humans' well being with the dangerous diseases. The recognition sign of the demonic force presence in the air is its appearance within the shape of whirl or windstorm gale. In Kosovo region, it was believed that "gale represents the Satan" which is to be spit at three times. According to the Uspensky's opinion [2], "windy" diseases are in magical act of crafting under patronage of St. Nicholas, which may come as a substitute for the God of the dead.

The creatures in a shape of worm are demonic forces provoking diversity diseases. The ways in which these creatures operate are speculated by several archaic beliefs. Similar role has evil-fairies as demonic souls coming from wild, outer space. In people's belief the ultimate danger threats when the evil-fairies are furious in case of stepping on and taking their physical gathering place, already taken by them. Subsequently, they punish the man for this obscure intrusion.

Sorcery crafting act has protective function from diabolic, unsure force, regarded as the cause of the disease or the major damage inflicted to mankind. There is no official, commonly accepted name for such demonic powers or beings among the Southern Slavs. These creatures among the Serbs are popularly regarded as "different diseases".

In folk magic, a special place belongs to bewitchment and bewitchment spelling. It is believed that the commencement of the bewitchment is exclusively connected with the man as its cause, and it is greatly delegated among the Southern-Slav people. The comprehension of the bewitchment forces and evil creatures, able to provoke diseases were found in folklore and ethnic monuments of ancient Babylon, Assyrian and other cultures. Magical, protective signs and objects, even today, may be found clipped on infants' beds in a shape of red yarn, or swinging charms, hung by the rear-mirror in driver's car. The entire bewitchment territory remained in the aria of sorcery medicine.

Within research essays, there are different interpretations of magical act conjuring. Thus, Poznanski this act's origin sees [2] in pre-historical phase when it was believed that no one can escape the magic force of verbal communication. By the acceptance of Christianity and the idea of the God as one and only, who created the world, the formula for sustenance of the folk crafting has been found, and presents pre-Christianity era of the magical strength of

the spoken word. Therefore, prayer saying is not confronting the idea of the all mighty God existence. By this, the symbiosis of pagan, primitive thinking and Christianity occurred, which mislead in wrong direction some scientists, dealing with the subject. However, conjuring had the purpose to resolve man's conflict situations and to protect him from the evil and illness.

The conjure-teller, in magic procedures of folk crafting and conjuring is supposed to expel impure demonic force out of man's body, his spiritual life and living environment. In order to achieve that, selected objects are being chosen in a manner that on one end is turned to the man, and with the other to the outer world.

For this purpose, water, plants and animal parts, as well as variety of other objects, aligned with the fire and the fire-place are being commonly used. All those means have its designation functions while manipulating with magical act of conjuring. A fireplace and the objects above it, represented cult-colored place in pre-historic period. A fireplace, as per Radenković [3], symbolizes the cosmic axis that connects three world life aspects; heavenly, earthly and underground. Over the fireplace, through the smoke, people used to "accomplish" the connection with the celestial world, and through the depth of the ashes they were able to reach the kingdom of the dead.

Fireplace is also a place of practicing magical deeds. Thus, speaking out loud the words of conjure, assigned person expels the fear from the child by enforcing special ritual. During the procedure, conjure-teller (usually a woman), covers the child with some kind of cloth, and than melts the lead in spoon over the fire. Further, in the presence on the mother, she throws the melted lead in a pot of cold water, placed beneath the child's bed of feet. Than she speaks magical words and ultimately, picks out the lead figurines from the water and explains the mother, what the child got spooked from. The conjure-teller is convinced that, with such a procedure, the child will be relieved from the fear and thus will be returned to the normal life. Undoubtedly, craft-teller sub-consciously influences the mother, and in a way the child too, in the attempts to stabilize him. Diversity of lead made figurines, placed on conjure-teller's palm, as per her own belief, represent certain behavior disorders or the animals or situations that scared the child. This proceedings in folk population is known as "Pouring the scarce", meaning - the release of all patient's fears. This magical procedure has been noticed in the region of old Vlach (eastern Serbia), also with Muslims, and most probably on the broaden areas of Balkan peninsula.

Time and space, in magical deeds, may be observed as annual circle or calendar time, determined by lunar position, placement of the day within a week, or day and night relation. Even some holidays out of the annual cycle, have magical, protective power over illnesses.



It is also believed that demonic force influence is emphasized at the certain time of the year. According to this, Christmas, Easter, St. Gorge's Day (Đurđevdan, May, 6) and St. John's Day (Ivandan, July, 7) carries special significance.

Thus, there is a belief that at the time of Christmas the chaos is restored into the new cosmic order, which have it's own sacral power. Getting ill is considered as a way of disturbing the order and its restore and re-establishment symbolizes the fertile ground for magical performances. And so, for each of these Christian holidays, a magical justification is being found to be applied at the specific, most favorable time.

Macedonians and Bulgarians believe that freshly picked flowers before the Sunrise, on the St. John's Day have healing power. Dried flowers latter on are being plaited in to the garlands, further used for magic purposes.

The water wells are considered as special magical places for healing the sick. People taken ill, pay a visit to these wells, wash their faces in them, throw coins, etc., and perform magic rituals. Usually this is being done at the Spasovdan (May, 23) and summer's St. Nicholas (May, 22). By these cult-like customs, it is deep appreciation that is being showed to the existence of the water. That's why the coins are being thrown to the water, but also to the deceased before funeral, and to the mythical ruler of the water as well. In urban environments, throwing coins in the fountains undoubtedly possesses mythical, symbolic significance. For the same reason, tourists often throw coins into the "di Trevi" fountain, in the heart of the Rome with such a delight and curiosity. Many trust it will help them in gaining more money and in bringing them closer to wealth.

On the magical lever of verbal and manipulative activities, the men, from primeval times, attempted to confront the demon force in order to shield him self from evil, bewitchment and illness. Magical functions are testified in all basic life areas and within medical, economical and social preoccupations. These daily-life, ancient experiences are met on broad geographical areas, and on the region of Balkan and other southern-Slav countries, magical comprehension and behavior was further stimulated by written magical literature, prayers, sworements, magic written heritage and other sources.

Multi-cultural, Byzantine, Roman, German and Islamic oriented influence has been spotted within magic contents. Byzantine influence is mirrored through Greek, Roman/German influence through Latin and German, and Islam/Oriental influence

through Turkish and Arabic language. Byzantine influence area covers the borders of Orthodox Church, and it were monks and the priests who have translated scripts bearing magic weight.

Magic contents of Byzantine culture served as a solid build for Balkan people magic tradition. Therefore, archetype-like psychological heritage consisted at this level of consciousness, are sheer and evident in contemporary conditions. They kept changing and went through transformations, build up with new cultural experiences and kept finding it's presentation in different forms, first verbal, and latter on in written documents of the literature, arts, paintings, religion and other cultural formations. Thus, in written and unwritten magical symbolism, on a mental scale, very magical models were formed, mostly situated within the irrational mental sphere. This is, certainly, the antipode of the scientific and philosophical understanding of the world and occurrence that have its legal stream within the human being, nature and social and environmental surroundings. Finally, should Jung's archetype theory [1] in ancient cultures remain within the sphere of hypothesis and fantasy, for further science and philosophy development it would bear sense as an awesome and original idea, challenging the search of new principles of methodology destruction within scientific creative work. Therefore, his merit for the achievements in this research area are unmeasured and proven and thus bear perspective for the future, and certainly will arouse increasing scientific interest. Penetrating the depth of the conscious contents is impossible without studying this phenomena within it's ontological and anthropological continuity in the past, and present, and based on this founding, making prognoses for the future.

## References

- [1] K.G. Jung: *The Human Being And His Symbols*, (Narodna knjiga, Belgrade 1996), in Serbian.
- [2] In *Consciousness: Scientific Challenge of the 21st Century*, Proc. ECPD Seminar, 27-28 September 1996, Lj. Rakić, D. Raković, Đ. Koruga, and A. Marjanović, eds. (ECPD, Belgrade, 1996), in Serbian.
- [3] Lj. Radenkovic: *Southern Slavs' Folklore Sorcery*, (Prosveta, Belgrade, 1996), in Serbian.
- [4] J. Strikovic: *Following the Paths of Njegos' Psychoanalysis* (Obod, Cetinje, 1980), in Serbian.

# DESCRIPTIVE GEOMETRY AND DEVELOPMENT OF VISUAL PERCEPTION AND VISUALIZATION APPLYING ALTERED STATES OF CONSCIOUSNESS

Jelisava Kalezić

Faculty of Civil Engineering, University of Montenegro  
Cetinjski put b.b., Podgorica, Yugoslavia

**Abstract.** The work explores the role of Descriptive Geometry in the educational process at engineering and other faculties, as well as the application of the altered states of consciousness (the  $\alpha$ -level) in course of studying. Throughout the work the hypothesis is examined, stating achievement of better results in studying descriptive geometry while applying meditative exercise; applying methods for improvement of visual perception, visualization and imagination, overall results, achieved by students in the educational process, are improved. Contemporary needs and reasons for the studying of this subject are also considered and these needs and reasons are noticed as being shifted from areas predominant a hundred or fifty years ago, to new ones. If previous reasons are seen as correlated to industry production (mechanical, civil engineering) nowadays we find them in closer connection with developing the students creative capabilities. Descriptive Geometry is considered as an area in the process of student education, which enables stimulation of imagination, concentration, memory and, as a final results, the stimulation of creativity, all due to development of visual perception, and visualization.

**Key words:** *descriptive geometry, visual perception, visualization, imagination, symbolic forms, symbolic meanings, altered states of consciousness, meditative exercise,  $\alpha$ -level.*

## 1 Introduction

The question of more efficient learning and development of mental and spiritual abilities such as perception, memory, concentration, imagination, and creativity is of prime importance for the contemporary world. In this particular research, which is based on the hypothesis that Descriptive Geometry can represent a "bridge" for better synchronization of rational-logical and holistic way of thinking, the necessity to link arguments and results from different areas of science is obvious. This should be an initial research with the aim to connect researchers with similar interests from the fields of psychology, physiology, and biophysics, with those people who deal with education in order to find the key for stimulation creativity. The starting points in this paper are awareness of the importance of experiencing deeper reality following the findings of modern physics on dual nature of matter (particle - wave), as well as the existence not only of causality (cause - effect) but also of a-causality (synchronicity, i.e. non-

caused linking) relations, Jung's studies [1] on collective unconscious for which the modern physics and biophysics find more and more exact arguments, information on functioning of human brain important for the understanding of the learning process, knowledge on the processing of information on the level of biological species (Sheldrake's experiments [2]), knowledge on the possibility of accelerating the information processing in the altered states of consciousness (Raković [3]).

Descriptive Geometry as a university subject starts from visual perception of forms [4], i.e. space, and by way of geometrical methods and the accepted rules presents a particular experience of reality or one's own imagination. We note that Descriptive Geometry serves as a "language" for communicating certain experiences of the outside world or of the imaginary.

## 2 Outline

From the earliest beginnings of human civilization till our time a picture i.e. drawing, and even the technical drawing has had the same place in the mental process. Material reality perceived through senses has been the starting point for some kind of generalization i.e. abstraction which is expressed through a picture, and the picture is read, understood, felt and experienced in the field of spiritual. An exceptional account of this process (almost universally applicable to different fields of human interests and activities) was given by contemporary Montenegrin architect and philosopher Petar Perović [5], as presented in Fig.1(a-e).

It is clear that the process is two-sided, i.e. that we receive solution expressed through picture, i.e. even through technical drawing, from the field of the spiritual, which is then taken to the field of reality through the process of materialization.

Descriptive Geometry as a university subject permanently links the field of the material (materialization) with the field of the spiritual by finding new solutions (creation). It is worthwhile asking the question whether this subject has such an importance to be applied as a *system of mental exercises for development of creativity.*

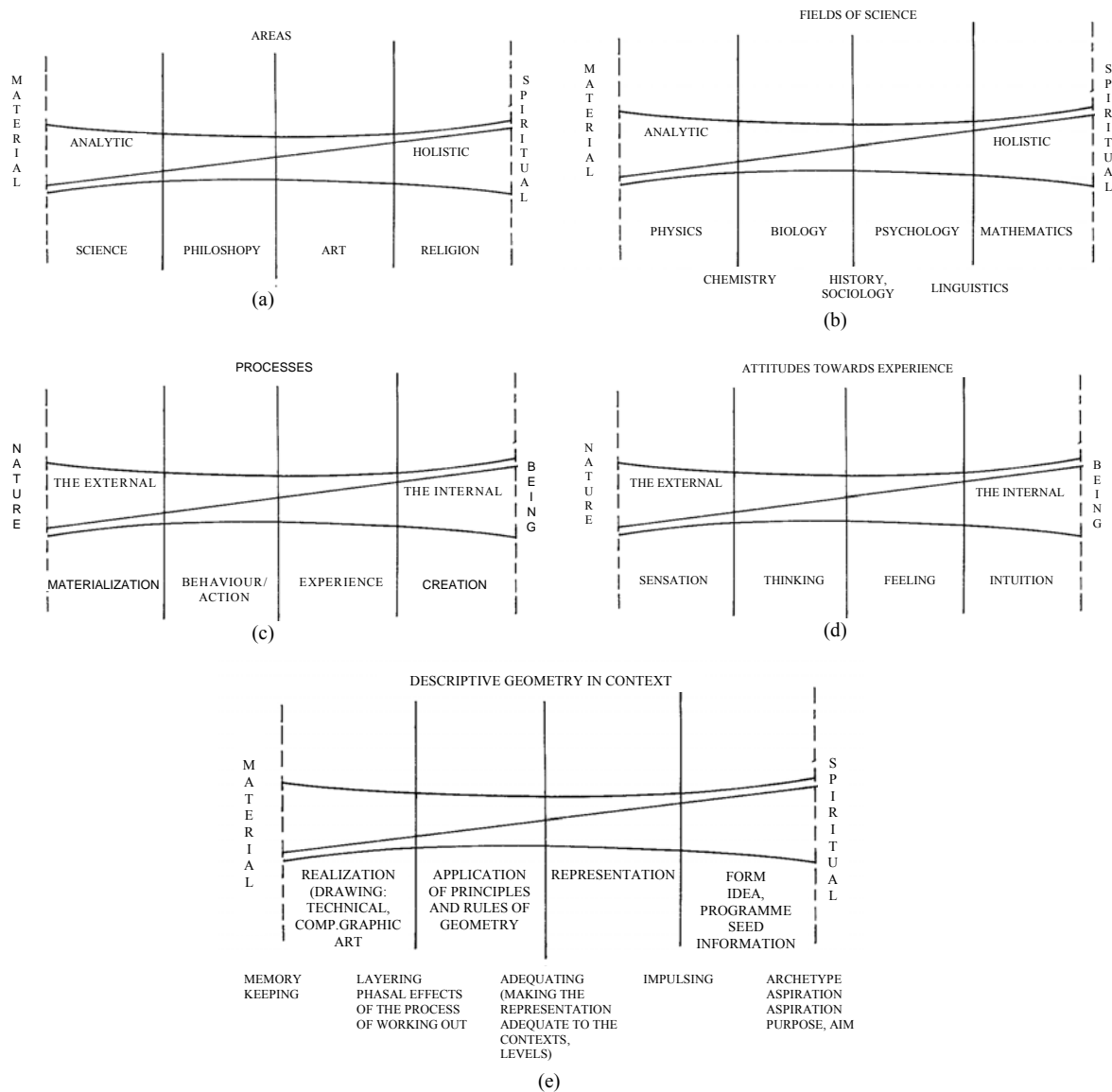

**Figure 1** A process of abstraction from material to spiritual, and from nature to being, for different human interests and activities: (a) areas; (b) fields of science; (c) processes; (d) attitudes towards experience; and (e) Descriptive Geometry in context.

### 3 Hypotheses

*Hypothesis 1:* By teaching the students to use willingly the meditative level, i.e.  $\alpha$ -level of brain frequencies (8-13 Hz) and by introducing these exercises into the curriculum of Descriptive Geometry, better results in studying the subject matter should be achieved, in other words visual perception and visualization should be improved.

*Hypothesis 2:* By using methods for improvement of visual perception, visualization and imagination through Descriptive Geometry, the overall results achieved by the students in the process of education should be improved.

### 4 Research

The starting hypothesis, already pointed out in the first paragraph, represents the skeleton of the research program [6]. It could be formulated through several precepts:

- ◆ Starting from the available information on the specialization of brain hemispheres, the left one for rational-logical understanding and the right one for holistic understanding, the specificity of the subject of Descriptive Geometry should be noted;
- ◆ This specificity is that studying of Descriptive Geometry should require easy and fast switching from logical-rational to holistic way of thinking;

- ◆ Students who can switch in a natural, spontaneous way from one to the other way of thinking should show excellent results in acquiring Descriptive Geometry. For the rest, it should be necessary to introduce new methods to improve the ability to switch from one to the other way of thinking; and
- ◆ By teaching the students to use willingly brain frequencies of 8-13 Hz, the desired easy switching from rational-logical to holistic understanding should be achieved. The use of these frequencies is most often-called  $\alpha$ -level or meditative level, and more generally altered states of consciousness [7].

Along with the starting hypotheses it is important to mention that the objective of this research is not only the development of visualization to achieve better results in Descriptive Geometry, but also the development of visualization through Descriptive Geometry in order to investigate students' creativity, which should give better results throughout studies.

The research has been carried out at the Faculty of Civil Engineering of the University of Montenegro with four groups of students three of which were control groups (K1, K3, K4 = KO), and one was experimental (E2). The groups were of average level. All the students had done tests (AF1 and PSI1) before the beginning of Descriptive Geometry lessons (Fig.2), throughout the teaching of Descriptive Geometry they did practice (preliminary exams), and after the two-semester teaching they did tests (AF2 and PSI2).

## 5 Results

The results obtained and elaborated show that at the beginning the groups were homogenous, and throughout the research and the teaching of Descriptive Geometry all the groups generally showed an improvement in understanding space and form. The experimental group, which apart from the program of Descriptive Geometry was trained to use willfully the meditative level, shows better results according to all the set up parameters. It achieved better results in doing AF2 and PSI2 tests, preliminary tests, as well as better results in other subjects in the first year of studies.

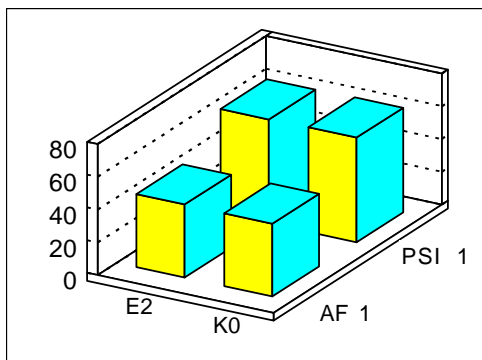

**Figure 2** Results of the previous AF and PSI tests, varied for the experimental and the whole of the control group [6]

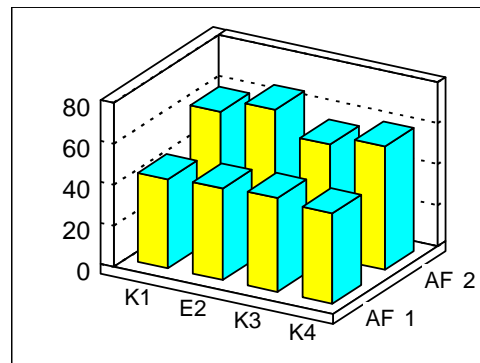

**Figure 3** Comparison the increase in the results in AF test

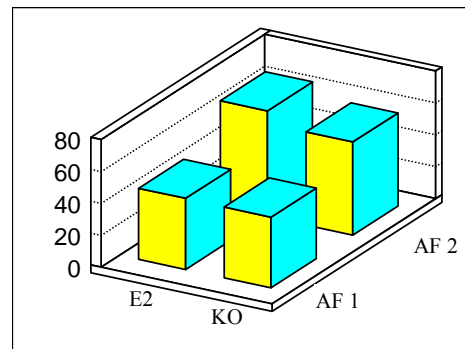

**Figure 4** The increase in the results in AF test varied for the experimental group and the whole of the control group [6]

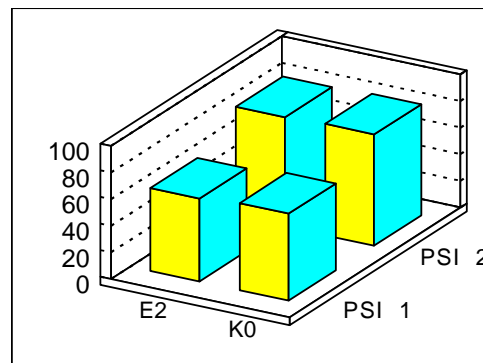

**Figure 5** Comparison of the increase in the results of actual groups [6]<sup>1</sup>

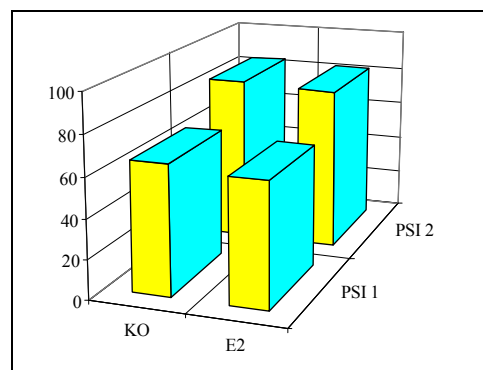

**Figure 6** Comparison of the increase in the results of comparable groups [6].

<sup>1</sup> During the research changes happened in the groups: some students had not done previous (AF1 and PSI1) tests, but they did AF2 and PSI2. Also, some students had done AF1 and PSI1 tests but did not do AF2 and PSI2. Therefore all the results were varied for the real as well as for the compared groups.

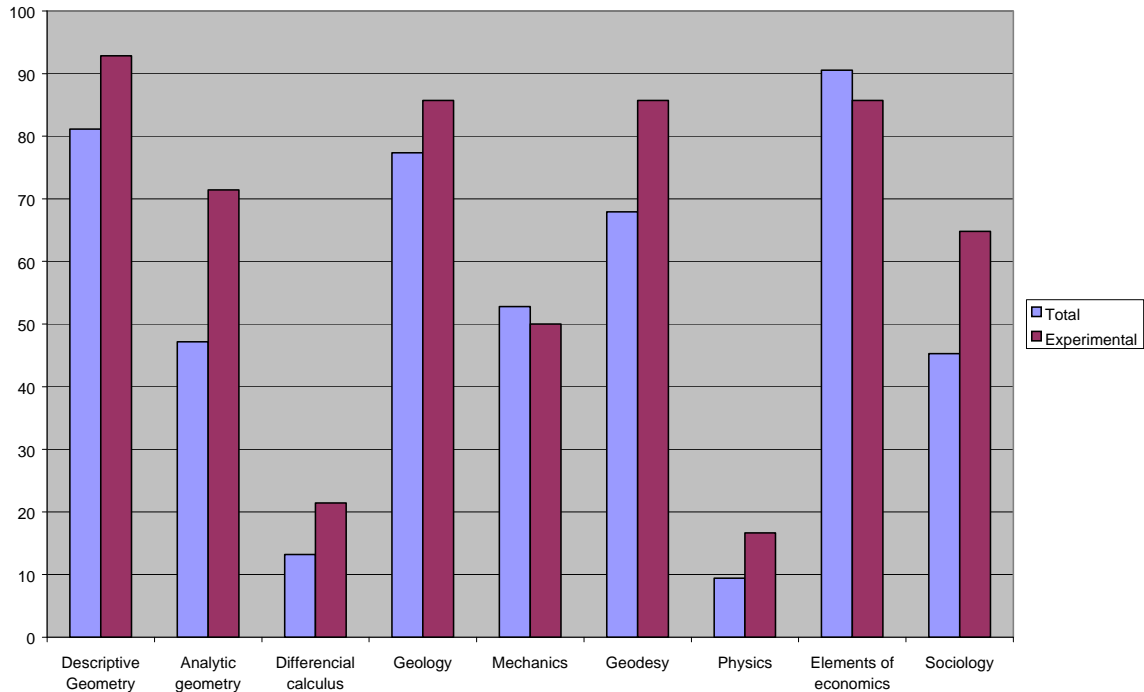

Figure 7 Pass of the experimental and control group in the first year subjects [6]

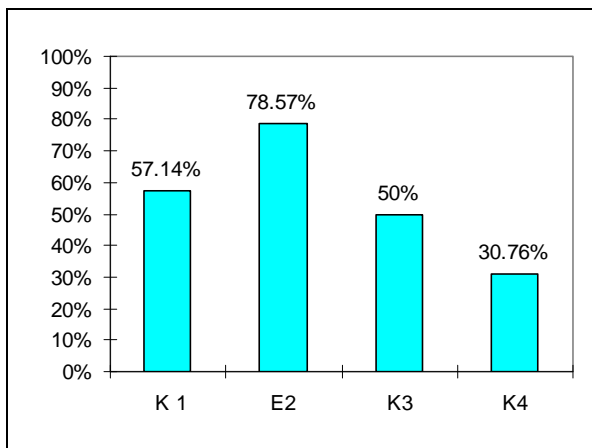

Figure 8 Pass from the first to the second year of studies of the groups involved in the research [6]

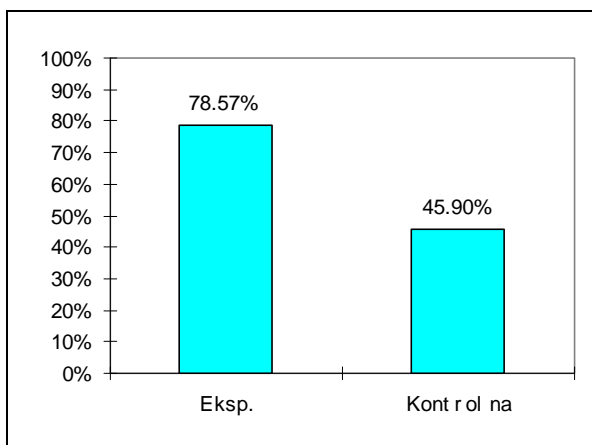

Figure 9 Results varied for the experimental and joint control group [6]

## 6 Conclusion

The first hypothesis is the very core of this research. Generally the results confirm that the experimental group (E2), according to all the applied parameters, achieved better results than the control group (Ko), i.e. control groups K1, K3 and K4.

The parameters are as follows:

- ◆ Results of test AF2 in relation to AF1 test (Figs. 3 and 4);
- ◆ Results of PSI2 tests in relation to PSI1 test (Figs. 5 and 6);
- ◆ Results of preliminary exams pass;
- ◆ Average mark in the preliminary tests;
- ◆ Pass in other subjects (Fig. 7);
- ◆ Average mark in other subjects; and
- ◆ Pass from the first to the second year of studies (Figs. 8 and 9).

The groups with which the research has been carried out were homogenized previously by a psychologist. The differences in work with the experimental group in relation to control groups were as follows:

- ◆ Teaching the willful use of  $\alpha$ -level, i.e. the meditative exercises at the beginning of each class;
- ◆ Visualization exercises when solving Descriptive Geometry problems (these exercises were applied in work with the control groups students who were interested in it); and
- ◆ Listening to the selected music when doing exercises with the experimental group.

The second hypothesis was set up expecting that should the first hypothesis prove right i.e. that by using meditative level and meditative exercises in

studying Descriptive Geometry visual perception and visualization are improved, then the development of these abilities will have effect on the other results achieved by the students in the process of education.

It could be concluded that even this hypothesis was confirmed as Figs. 7-9 show.

*The conclusion* is that both hypotheses have been conformed:

◆ By teaching the willful use of meditative level, i.e. the level of brain frequencies and by introducing these exercises into the program of Descriptive Geometry, better results in learning are achieved, in other words visual perception and visualization, imagination and probably even creativity are improved. The results of the experimental group when compared to the results of the control group/groups confirm the set up hypothesis. Research of D. Raković [3] explains in a more complex way the possibility of applying the altered state of consciousness in the creative process: "Control of transitional states of consciousness, with "addressing" to a particular problem, could be the basis of creativity process, where the answers are obtained as anticipation of optimal problem solution (of course if the problem is of scientific or technical nature, an individual must be an expert in the given field in order to be able to express the anticipated solution in the "language" of the given scientific or technical discipline)!"

◆ By using methods for improving visual perception, visualisation and imagination through Descriptive Geometry the overall results achieved by the students in the process of education are improved. The overall presented results, in the Descriptive Geometry as well as in other subjects in the first year

of studies when the research was carried out, give evidence for the claim that the experimental group generally achieved better results. Pass from the first to the second year of studies was especially interesting as a specific "final product" of this phase of students' work.

## References

- [1] K.G. Jung, *Man and His Symbols* (Dell Publ., New York, 1972).
- [2] R. Sheldrake, *A New Science of Life* (Paladin Grafton, London, 1987).
- [3] D. Raković, *Fundamentals of Biophysics* (Grosknjiga, Belgrade, 1994), in Serbian; D. Raković, Brainwaves, neural networks, and ionic structures: Biophysical model for altered states of consciousness, in D. Raković and Dj. Koruga, eds., *Consciousness: Scientific Challenge of the 21 Century* (ECPD, Belgrade, 1995), pp 291-316.
- [4] R. Arnhajm, *Visual Thinking* (UU, Belgrade, 1985), in Serbian.
- [5] P. Perović, unpublished.
- [6] J. Kalezić, *Descriptive Geometry and Development of Visual Perception and Visualization Applying Altered States of Consciousness*, Ph. D. Thesis (Center for Multidisciplinary Studies, University of Belgrade, 1997), in Serbian.
- [7] S. Petrović, *Altered States of Consciousness* (Dečje Novine, Gornji Milanovac, 1990), in Serbian.

## THE ENIGMA OF TODAY'S SCIENCE: STILL MYSTERIOUS CONSCIOUSNESS

Dušan T. Kanazir

Serbian Academy of Sciences and Arts, Belgrade, Yugoslavia

The fundamental question in brain sciences today is the mind-brain-body relation. In the past, almost up today, the mind or soul was often regarded as something immaterial and separated from the brain, but interacting with it in still unknown ways.

Today, most scientists believe that mind, including consciousness, generates from dynamic molecular interactions, processes regulated by genes' expressions in brain cells of different structures. There are claims that consciousness is product of neurons and their firing caused by signal transductions. As it might be expected, this field is so new and many diverse and conflicting theories are raised based either on materialistic (physical, chemical) or philosophical reasoning.

The views on consciousness and mind range from reductionist and material theories of neuroscience and of psychology to those mysterious ones claiming that we will never understand the background and truth of consciousness at all. That might be partially true since, at the present, we do not know why consciousness exists, what is its function and what is the mechanism of its genesis.

The most complex problem today is the question how physicochemical processes and molecular interactions within the brain cells give rise to consciousness and to subjective experience.

In studying higher functions of the brain, a special problem represents complex functioning and composition of the brain and as well as that of neurons and glia cells; there are numerous possibilities for synaptical connections and synaptical transmissions in the brain. There are numerous neurotransmitters, neuropeptides and neuromodulators in the brain. So, the problem lies in the fact that possibilities of interactions and information transfer and signal transduction are far greater than we believed.

It is well established that different pharmaca can modulate consciousness, and if so, than the question raises, what is happening in these processes on the molecular level, namely at the level of genes functions? How do nucleic acids, proteins, and lipoproteins, that are components of neuron membrane, especially how receptors, that are at the surface of neurons, regulate genes expression and functions of signal transduction? How do all these cell constituents participate in genesis modulation and processes of consciousness? General anesthetics, as it is known lead to loss of consciousness by modulating functions of ionic channels,

when they react directly or indirectly (modified) with the lipoproteins of membrane of neurons, namely with receptors, and thus change actions of receptors and processes of transfer of information from the cell surface to genomes through different systems of kinesis. An interesting fact is that, for example, specific mutations in acetylcholine receptor within the range of M2 increase sensitivity of receptors to general anesthetics, as are for example hexanol, octanol (and propofol), which means that these compounds bind either for specific domains of receptors or very close to "M" domain. In the same way ionic postsynaptic channels in brain represent targets for the anesthetic actions, all this leading to modulation of consciousness. The above facts suggest that consciousness has certain physico-chemical basis and is connected with the function of certain gene sets in brain cells.

A survey of recent literature supports the view that material basis of consciousness can be clarified without a recourse to new properties of matter or quantum physics. Current neurobiology appears to be able to handle the problem. The synthetic and dynamic views provided by brain imaging may be decisive for discovering the neural correlates of the integration aspects of consciousness. The neurobiological approach may, beyond the findings of cellular, molecular and even genetic mechanisms, improve the general concepts of consciousness.

### References

- [1] Explaining consciousness: The "hard problem", Special issue of *Journal of Consciousness Studies* Vol. 2, No. 3, (1995).
- [2] D.J. Chalmers, *The Conscious Mind: In Search of a Fundamental Theory* (Oxford University Press, 1996).
- [3] *Cold Spring Harbor Symposia on Quantitative Biology*, Vol. LV: *The Brain* (Cold Spring Harbor Laboratory Press, 1990).
- [4] F. Crick and C. Koch, Towards a neurobiological theory of consciousness, in *Seminars in the Neurosciences*, Vol 2 (1990).
- [5] J. Delacour, Neurobiology of consciousness, *Behavioural Brain Research*, Vol. 85 (1997), pp. 127-141.

## PROBLEMS OF COSMIC LIVING SPACE (Tool of Intellect)

Vlail P. Kaznatcheev

Institute of General Pathology and Human Ecology,  
Siberian Branch of the Russian Academy of Medical Sciences  
&  
International Institute of Cosmic Anthropoecology,  
630117 Novosibirsk, Russia

**Abstract.** The living matter of Earth is a combination of numerous forms, the protein-nucleic formations that are unsuccessfully looked for in space under SETI programs being a particular case of the living and inhabited Cosmos. In terms of the concept set forth by us, the entire evolution of the Universe, from the point of Big Bang, originated from the cosmic living space, *i.e.* a vast population of cosmic living flows and organizations, where we are only infinitesimal part.

The greatest cosmic event happened about 3.5 billion years ago resulting in synchronous association of field forms of protohominids' brain neurons into a united soliton-holographic formation at several sites of the planet. The spasmodic transition from neuron-conducting kind of control of the brain activity to a kind of 'field computer' allowed for an increase in the informative capacity of protohominid's brain by 6-8 orders of magnitude. The result was the emergence of man on Earth who possesses a phenomenon referred to as intellect.

Since that time not only evolutionary progressive but also simplifying processes have proceeded in our consciousness, in arrangement of our intellect. Soliton-holographic intellect coexisting with the protein-nucleic body was step-by-step overcoded to verbal forms of intellectual tools (semantic fields).

The knowledge of man and his intellect is less than 1% of general scientific image of world. Variations in the living matter caused by the global ecological crisis are too fast for scientific conceptions to discover the reasons which bring us to ruin. The intellectual 'black hole' seems to be that principal fault of the intellectual progress of humankind which can cause its technocratic self-destruction.

A comprehensive self-understanding of humankind as a derivative and an element of living Cosmos is, perhaps, the only way to saving the civilization and surviving Earth planet.

**Key words:** *Universe, living matter, living space, soliton-holographic intellect.*

This is a controversial problem. The author represents some knowledge areas of the schools, philosophies underlying achievements of the Russian natural science, history of native culture and science.

### 1 Fundamentals

A number of schools contribute to the world cosmogonic area. These are extreme theosophical, religious notions based on certain empiricism of humankind on the one hand, and extreme astrophysical, physical concepts on the other hand, which seek to prove certain unity of Universe where inert and living forms of the matter are reduced to their common primal origin. Several attitudes are distinguished in the Russian cosmism and natural science.

(1) Beginning from the works by K.E. Tsiolkovsky, V.I. Vernadsky, P.A. Florensky, A.L. Chizhevsky, N.A. Kozyrev [1-5], planet's living matter is considered as an integral organic part of the planetary and cosmic world. Therefore, the basic notion of the Russian cosmism is that the living matter, its intellectual, physical and material properties are only an element of the united cosmic living matter.

(2) An attempt to classify the material and informative (spiritual) properties of the planet's inert and living matters as a cosmic natural phenomena is traced.

(3) It is emphasized that thermodynamics of the cosmic and planetary living matters are different from those of the inert matter in that they reveal a distinct non-entropic trend to evolution. The interaction of the living and inert matters is the permanent intimate flow of subatomic, ethereal, atomic and molecular processes, where the matter ordering is ever improved on the basis of the programs of the living matter.

Three basic principles must be recalled; they were set off in the work "Study on Phenomena of Life and New Physics" by V.I. Vernadsky in 1930's. He wrote (p. 260): 'The first biogeochemical principle of living matter is: The geochemical biogenic energy seeks its maximal manifestation in the biosphere'. 'The second biogeochemical principle is: Only those organisms survive in evolution which increase the geochemical energy while living'. And the third, the



most important principle after V.I. Vernadsky is: 'Human intellect and human activity, initiated by it, change the course of natural processes to the same extent as the other known energetic phenomena do, but do this in a new manner'. 'This activity is controlled by the second biogeochemical principle and always tends to its maximal manifestation' [2].

V.I. Vernadsky ("On the Fundamental Material-Energy Exchange between Living and Inert Natural Bodies of the Biosphere" published in 1939 [2]) gave detailed Tables, two columns of which distinguish chemical, atomic, thermodynamic properties and the properties resulting from the interaction of living and inert matter. He emphasized that a flow of atomic, subatomic phenomena which may reveal as isotopic processes, transmutations, and inherent ethereal properties, unknown at that time, must be looked for in the living matter. Thus, based on these principles we can say that even the emergence of our planet in the space as long as 12-14 billion years ago brought about certain prerequisites for the advent of life: protein-nucleic living matter at first, and then this one in combination with field forms of living matter. Later these properties became sophisticated, and some 3.5 million years ago the creatures appeared who possess a higher informative organization, referred to as human intellect. Then these creatures were united into a common living form. The joined intellectual and creative interaction, working, cultural, and social activity resulted in the formation of the planet as a united intellectual process, an intellectual flow on the scale of cosmic living space.

If we turn back to the definition of intellect, the level or the principle should be found which is distinctive for this definition from the known ones with respect to the intellect of an individual man, or a group of men, or their communities. The united living matter is the universum classified by Teilhard de Chardin [6], the noosphere phenomenon which differs essentially from the nature of an individual intellect of each man. It unites the scientific, cultural, spiritual, engineering thoughts and the way of life into a single intellectual flow of the planet, and transforms the Earth spacecraft by making the whole crew, all the 5.5 billions of the planet's inhabitants dependent on the planet's intellectual activity.

If we turn back to physical hypotheses [7-12] which seek to unite living and non-living matters at the level of excited ether, spin-torsion fields, or anthropic principles, or back to attempts of finding the 'project' inherent in the singular point at the instant of "Big Bang" and emergence of our Universe, then one should ask question. If, after the eminent physicists [13], the anthropic principle implies that the Nature was created in such a manner that there was an Observer, then the question is: if there was not an Observer at the moment of formation of the Nature itself, hence there was no project for the formation. This is contradictory to the physicists' statements.

According to Yu.A. Baurov's diagrams, A.E. Akimov's and G.P. Shipov's models, the Great Nothing, meonic cosmos looks like uniting living and inert matters, living matter being different from intellect by definition: living matter of protein-nucleic nature possesses a property of intellectual activity. After L.V. Leskov [14], intellect, or consciousness is characterized by receiving information from the outside, retaining it in memory, logic operations, intuitive obtaining new information, free play of imagination, and, eventually, it is treated as a property of information synthesis. But if so, then another question is permissible: If intellect is the property of synthesizing information, then what is the source of this information in the geocosmic environment? If the Big Bang occurred indeed, then Who charged that Great Project, which would be characterized by the appearance of the Observer who would create intellectual living forms to interact with the surrounding world, and When did he do this?

From the viewpoint of evolution of protein-nucleic species, the problem of the appearance of living matter is likely to be a particular case, as the protein-nucleic form of life is among numerous alternatives of the living matter flow, of the cosmic living space.

Thus, our planet should be considered as a cosmic living formation possessing intellect, which is a universal and necessary feature of cosmic forms. The intellect, being a reflection of the above said fundamental Thermodynamic Laws, may be represented in one or the other flows.

The planetary intellect is the united conscious, intellectual and spiritual activity of the Earth's mankind during a complex interaction aimed at technological, geological, astrophysical transformations of our planet. Nowadays we bear responsibility for the survival of our spacecraft. Therefore, the decision on sustainable development approved at the Rio-de-Janeiro Congress in 1992, variation in the trophic mass, ecological disasters, climate change, everything is only isolated fragments of a more general, key problem of human survival, understanding the planetary intellect of the 21st century.

## 2 Hierarchy of Intellectual Formations

If one looks at our Planet from the Space, as K.E. Tsiolkovsky and V.I. Vernadsky, L. Gumboldt, and others did, he can see that isolated small groups of intellectual concentrations are first formed, then they associate into organisms in the form of tribe flows which transform the environment. The flows unite and generate mutually dependent organizations of social-demographic or geopolitical nature; L.N. Gumilev [15] referred to thus defined trophic migrations as passionary phases of Ethnos. These are attempts to understand man's origin and to affiliate him to unknown Earth's or Heaven's forces; these are theosophy, theological, monotheistic, heathen,

and other kinds of religion that united the tribe formations. Ethnoses merged into superethnoses and, upon appearance of appropriate productive forces, the society disintegrates to give rise to states. States on Earth are certain consolidated intellectual and social-demographic, geopolitical organisms [16,17]. The planet is 'occupied', a living flow of conscious, intellectual and creative organization propagates gradually through it. States can unite to give rise to superstate formations (for example European Community, Near-Eastern Unions), they may stipulate about common concerns in certain economic, trade horizons (armament, drugs, sex business, power structures). Oversuperstate intellectual structures distinguished not in their nationality but their selfish market program start their horizontal propagation over the planetary state and superstate organisms. All of them are serious intellectual organisms.

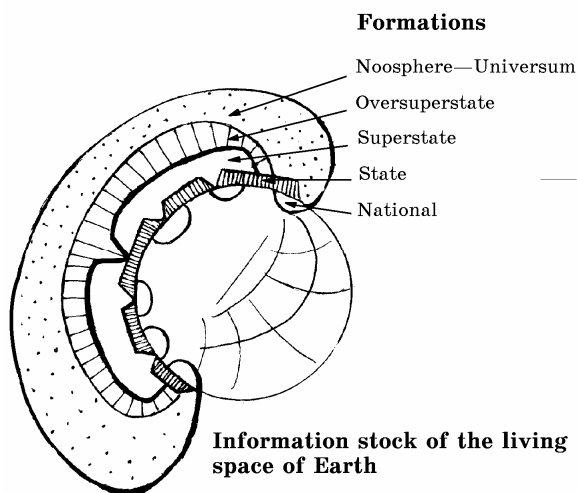

**Figure 1** Hierarchical structure of the planet's intellect

Thus, our today's planet is inhabited by living intellectual organisms of various kinds, hierarchical levels, structures, and organizations. These are ethical, national, clan and tribe formations united into administrative structures which are subdivided into consortiums and convections [15]. They are involved in specific state processes and structures with geopolitic frontiers. There appear superstate and oversuperstate formations. If speculate about the planetary intellect and look at its 'flows' (Fig.1), where occur the national (first flow), state (second flow), superstate (third flow), and oversuperstate (fourth flow) formations, we will see that this is, fundamentally, a postindustrial society by Tofler. We classify an extra, fifth flow. The fifth horizon brings us to the V.I. Vernadsky's noosphere, turns back to the Teilhard de Chardin's Universum. This is just the planet's united intellect. If, being at this level, mankind cannot muster strength for uniting and understanding the integrity of cosmic Earth formation, all the horizons underneath and oversuperstate systems will cancel a possibility of

biospheric supply, that will result spontaneously in the planet self-destruction.

### 3 Scientific Image of the World

If speak about the planetary intellect and the general image of the world, which is under revision by many scientists who try to treat it as an integral unity of knowledge flow, an extremely non-uniform sharing of the knowledge, as taken to be 100%, should be pointed out. The knowledge on inert matter of macro- and microcosmos approximates 95%. And no more than 5% of our knowledge deals with the understanding of the essence of planet's living matter. As to man and his intellects, we are likely to know less than 1%.

The planetary intellect, while meeting demands of the world market, providing preservation of biosphere resources (both atmospheric, hydrospheric, etc.), is now underlain by the information it has to draw from those 95% of knowledge of non-living matter. Meeting the demands at the expense of the inert matter will inevitably result in leaving mankind behind its own evolution [18]. We refer to this phenomenon as 'intellectual black hole' and recall once again that this 'hole' is a phenomenon of the 21st century. The trend of knowledge towards the only inert world will lead inevitably, in spite of the most advanced philosophic humanistic tendencies, to a crisis which is currently of common knowledge. Let us remind that the political frontiers become ever more transparent. The planet's resources, its expanse of water and information, migration, transport, and geophysical flows related to electromagnetic radiation promote the overcoming of the geopolitical frontiers.

On the eve of the 21st century our world, which is as yet confined within the 'seams' of political frontiers being the reason for so many great social conflicts, has long been an indivisible cosmic formation.

### 4 Nature of Living Matter

The studies of the nature of living matter are now mostly concentrated on that of protein-nucleic formations. Meantime, the protein-nucleic essence of cells involves a number of contradictions indicating an insufficiency of the knowledge only on chemical and genetic interactions. We are eye-witnesses for the 'chemical epidemic' of medical preparations which have turned to be a very dangerous 'scalpel' inculcating in extremely fine physicochemical processes due to inadequately exerted chemical influence that induces changes in metabolism, breath, and structure of cells.

Of vital importance is that a child, whose body consists of  $10^{12}$  cells, appears from a single inseminated ovule. A dozen of zeros is a vast, astronomic number! What is the way to control the

flow of these cells? From our calculations, it cannot be explained either through complementary immune or morphological mechanisms. This is a cosmic flow which is only arranged, and perhaps in a secondary manner, in the form of the known genetic and immune releasing processes. The primary program for the ovule insemination to control development of these cells involves soliton-holographic or spin-torsion flows of living matter. The protein-nucleic and field matters coexist within each cell.

From its birth through the declining and old years, a man passes through his organism the cell flow as high as  $10^{25-26}$ . This is, essentially, the Avogadro number, the cosmic number. Supposedly, this is a certain constant of the living cosmic transformation of field structures to macromolecular ones. It is not impossible that when the number of populations gone by the end of the 20th century approaches  $10^{25}$ , this will be the critical mass for that men flow which will be able to pass over the planet surface. As mankind approaches this number, it will age and, very probably, pass away from Earth (Fig.2).





Time Period	Number of generations	Population
B. C.	2,5 thousands	55 000 000 000
A. C.	65	30 000 000 000
by 2050	3	10 000 000 000
by 2100	3	10 000 000 000
		100 000 000 000
R. L. Bartini's Cosmic constant	 $10^{12}$	 $10^{12}$ inhabitants
	Embryo period	
$10^{24-25}$	 $10^{25}$ cells of organism	 $10^{25}$ inhabitants
	Adeing and death	

Figure 2 Information stock in the living space of Earth

These are serious calculations, they were mentioned by a famous Russian engineer and naturalist R. Bartini [19]. Again, V.I. Vernadsky said about the living matter constant. This is in line with Teilhard de Chardin's idea on the Universum's trend to omega, the point where the evolutionary process is terminated by withering and life disappearance.

## 5 Cell Civilizations and Man in the Intellectual Flow

The nature of living matter cannot be examined at the scale of the existing protein-nucleic cell formations and man's organism but where they are the models of the planet's intellectual flow.

Our research on cells shows that the cell cultures are, in essence, cell civilizations [20,21]. Each cell possesses its own cell intellect. When the cell intellect constituted by field soliton-holographic

formations is in conflict with the ecological organism mechanisms, the cell starts becoming beyond control by the integral organism, becomes more sovereign and achieves its 'declaration of rights'. These 'rights' make the cell possible to go away the system of seniority of the body tissue mechanisms, to interact with bacterial-viral and other structures of the endoecological nature. This is the conflict that allows for ever more powerful process of sovereignty, gives rise to the evolution of the past and new diseases, when the organism comes into the exo-endoecological conflict, and the cell sovereignty is contradictory to the evolution in its own right. The cell civilizations are shown to behave in different manner depending on the geographical latitude: cell cultures grow rapidly but age rapidly in the North latitudes; fast ageing is observed at the moments of solar eclipses, of 'planets parade', during comet passing (Shumeikerov-Levi, Haily-Bopp), during underground nuclear tests several at the distance of thousands kilometers away from the place of testing. An explosion inside the planet body shakes the entire biosphere at the scale of still unknown field processes.

Cell civilizations are in close interaction with the surrounding near and far cosmic space.

Changes in stable isotopes of carbon and sulfur atoms, which were unknown before, were found in cell structures. As a man ages, the quantity of heavy carbon ( $C^{13}$ ) decreases, and  $C^{12}$  isotope fraction alone remains. This phenomenon cannot be explained only in term of thermodynamic propensity to the choice of isotopes, as is done by some authors [22]. This is most likely to be related to transmutation, transformation of heavy isotopic forms of one element into another (for example, potassium into calcium) [23]. A living cell is not only a protein macromolecular process (burning, oxidation) but also an unknown phenomenon of a cold biothermonuclear reaction, where energetic processes are in connection with the flows of soliton-holographic information and with the cosmic space [21] (Fig.3).

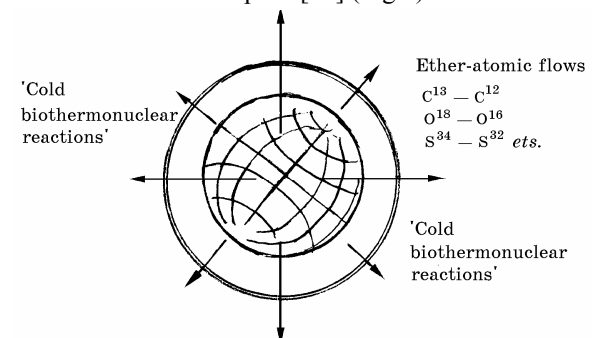
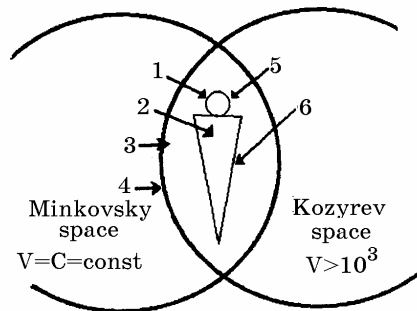

Figure 3 Geocosmic flows of living matter

These ideas were set forth in the world literature by L.G. Gurvich, E. Bauer, R. Targ, R. Jahn, F. Popp [24-30]. An idea of field genome is also under discussion [31,32]. The works by astrophysicist N.A. Kozyrev [5] are of exceptional importance, he coined

the notion of tachion space when he recorded for the first time a signal of a star body using a resistor mounted into a radiotelescope. In these experiments the signal was found to pass at the speed of  $10^9$  km/sec unlike the normal light speed of 300,000 km/sec. N.A. Kozyrev stated a hypothesis on energy-time that ties phenomena in the cosmic space. In this case slow processes we register in our mind within the Minkovsky-Einstein four-dimensional space are ignored, while they are just the basis of the living matter (Fig.4).



**Figure 4** Minkovsky space and Kozyrev space (1 – Consciousness level (Aristotle logic); 2 – Subconsciousness level (Boyes logic); 3 – ‘Basements’ of consciousness; 4 – Man’s corporality supporting the consciousness; 5 – Metalevel (cosmic consciousness); and 6 – ‘Basements’ of cosmic consciousness)

In our studies on transpersonal communications, while not forgetting about the works by R. Targ, R. Jahn, R. Monroe [26,27,33] and by many others [34-37], we show [38,39] the human brain to be capable of communicating with another brain through the planetary space over a distance of thousands of kilometers, show the manner for transliteration of image-bearing notions originated in the ‘Kozyrev’s space’. From our data, as little as 30% of information is real-astronomic-time received, 30% lags behind, and 30% is received ahead (up to several hours) with respect to the moment of transmission [40]. This ability appears to be in many respects determined by a fine combination of embryogenesis processes during pregnancy with geocosmic space [41-43]. Solar activity phases, geomagnetic influence, Moon position are as if they are stored in memory of cell structures of the embryo which, like a ‘fish’, inhales a combination of electromagnetic, quantum, gravity processes and excited ether. This is the living space where man utilizes a huge flow of his cells of  $10^{24-26}$ .

When the quantity of cells of a person attains this magnitude, he does not die, he goes away in such a fashion that his protein-nucleic carriers cease their living activity but the field forms remain. I.L. Mechnikov, a famous Russian naturalist, was the first to substantiate the ideas of such a way of going away [44]. L.S. Berg, an eminent Russian biologist, upheld the same ideas [45].

## 6 Human Intellect in Multidimensional Space and Torsion Fields

The problems of spatial-temporal interactions are the subject of wide speculations in the world literature [46].

According to N.A. Kozyrev’s hypothesis, time possesses a peculiar property, *i.e.* course, that makes differences between cause and effect, past and future [5]. The Russian astrophysicist believes that the influence of ‘energy-time’ is not propagated but emerges instantly everywhere. For this reason a change in the time density created in the laboratory must be perceived at the same moment in the most remote galaxies. He persists in the existence of a biological connection through time, and this may be the key to understanding many of mysterious phenomena of mentality [5,47,48].

The works by N.A. Kozyrev allowed development of new technologies employing reflectors of specific geometry which make it possible to focus soliton-holographic field processes of human intellectual activity and to record the concomitant changes at the encephalograms, cardiograms, Kirlian-photographs. Alternative techniques are available which reveal intimate psychophysiological properties of a man being inside the ‘Kozyrev mirrors’, where capability of distant transpersonal connections is crucially enhanced. Technologies have been developed which use hypogeomagnetic chambers where the Earth magnetic field is 600 or more times decreased. Cell civilizations placed inside such chambers are shown to live their specific life with another threshold sensitivity to influence. The relationship between interactions of the left and right cerebral hemispheres, emotional and break processes vary for a man inside the hypogeomagnetic chambers. The stay of men, including children with mental retardation, in the hypogeomagnetic chambers is shown to stimulate their intellect and creative ability. This is helpful for healing child epilepsy and a number of other psychosomatic diseases. The ‘Kozyrev mirrors’ may be used to concentrate the fields reflected by a man and, using a laser beam directed through the reflection focus, to ‘clean’ the organism from the accumulated distortions of field forms. Our recent studies demonstrate a possibility of the torsion processes to be used for transmitting chemical information or the information of another nature over a distance to a biological structure. This resembles the information exchange in homeopathic practice, when a molecular or macromolecular structure, if diluted by 12-16 orders of magnitude, ‘enters’ the spin-torsion fields of hydrogen atoms and may be ‘transmitted’ to a man in such a manner without mediation of the chemical molecule. We recorded changes in cell civilizations and a potentialities of torsion fields to the remote transfer of the information from the pertinent molecular and hormone fractions to man’s organism.

Eventually, a combination of hypogeomagnetic chambers with 'Kozyrev mirrors', laser 'cleaning' and torsion fields may result in a remarkably higher efficiency of prevention and treatment of a number of diseases. It is important at this point for a man to discover specific features of his heliogeophysical imprinting and to choose exact periods for therapeutic, preventive, or rehabilitative treatments in 'Kozyrev mirrors' or hypogeomagnetic chambers.

'Kozyrev mirrors', taken alone or in combination with torsion sources, may be used to construct the centers where such processes as ageing, tumors, allergic immunodeficiency, dystrophic cell changes, and many of psychosomatic diseases can be canceled by means of the torsion-informative flow. It seems realistic to vary intellectual potentiality, emotionality, and trends. Thus, biology and medicine look through and examine new concepts of the planetary intellect to develop innovative approaches. Such centers, which would be arranged at special geophysical regions of Earth, need to be substituted for clinics, individual medical, resort, tourist institutions. These centers can have considerable health improving and stabilizing impact upon both biospheric complexes, including the entire hierarchy of biogeocoenoses, and human health, including all the levels of his posterity (global psychoecology).

Thus, understanding of the planetary intellect of the 21st century gives rise to formation of cosmoanthrobiology and medicine with a complex of still unknown interdisciplinary areas. These areas may be called geocosmic valeology of our planet. 'Valeum' means to be healthy. The cosmoanthrobiological centers will be able to make the whole planet healthy in both psychological and somatic aspects. To launch these works and to provide strict control over their accomplishment is of vital importance. Humankind has been unable so far to separate the scientific progress with respect to his planetary intellect with humanistic trends from negative aggressive utilization of the results of the progress. The case in point is the social power, control over society, those planetary and cosmic moral philosophy and ethics K.E. Tsiolkovsky wrote about as long ago as in 1930's [1].

The planetary intellect must take a new insight into the problem of today's ecological and technogenic disasters. Ideas of catastrophism prove the necessity of destruction of space bodies which, supposedly, bear danger to our planet. However, these all are problems related to the interaction of humankind with the living cosmos. Our Appeals and Reasons on the necessity of the proper interaction between man and the living Cosmos were distributed during the past Congress "Medicine of 3<sup>rd</sup> Millenium" in Martinique. At this point it is important for man to consider himself as a part of the living cosmic space and not to manifest aggressive intentions which tend to progress rapidly. A realistic way to destruction of synthesized arms uranium

accumulated on the Earth planet was defined; new technologies employed at atomic power stations are useful here, the stored uranium is converted during the thorium cycle to non-radioactive short half-life wastes. Sound environment may be returned to Earth, so that the global disaster will be prevented.

Ideas formulated by V.I. Vernadsky are, undoubtedly, an apotheosis of this philosophy. He presented a lecture entitled 'Autotrophicity of Humankind' [2] in Paris in 1930's. The lecture was published in France in 1925. In the lecture V.I. Vernadsky emphasized that mankind utilizes now green mass and animals in a trophical sense, as well as water and energy in the form of gas, coal, oil, minerals the biosphere stored for us. However mankind would be able to use his knowledge and intellectual processes, based on better understanding of the interaction of field form and protein-nucleic form of the living matter, in order to replenish the trophic stocks and restore the ecological equilibrium of the planet and near Cosmos. This is a challenge for the planetary intellect of the 21st century.

## 7 Conclusions

Recall our concept on the evolution of the planet's intellect. 3.5 to 4 million year ago the brain of protohominids accumulated 13-14 billions of neurons; those were computers of the conductor type. The protohominids were in essence animals whose behavior in the form of instinctive reactions was controlled by the neuron computer [49]. But a cosmic phase comes giving rise to new man and intellect. An extraordinary process happens within isolated regions of the planet [50]: these 14 billions of neurons, with soliton-holographic forms of living matter already existing in each of them, were united in a burst-like manner into a giant single soliton in man's head. These tribe formations are caused by soliton fields. In this way the cosmic intellect, cosmic consciousness arose [51,52]. The bearers were, substantially, aliens not as protein-nucleic phenomenon but fundamentally new formations of protohominids united by a common intellectual-field flow.

Now these are humans, they have to live in a new ecological environment and to survive. Overcoding of the soliton-holographic intellect to a signal system proceeds gradually, semantics and speech appear in this way [53,54]. The verbal functions allowed men to unite into materialized structures, although the semantic fields caused disintegration and partition of social structures and geopolitic forms, *viz.* the history described in the morphological series by O. Spengler [55]. At present state and superstate formations are linked in different manners in their soliton-holographic field structures, within the Kozyrev space; that is why the generalization can only be achieved via language, semantic fields. As to their spiritual, religious, inherent, subconscious forms

[56], we seem to come to necessity of identification of several 'geocosmic', now historical, civilizations on Earth. They coexist, are made equalized with respect to their language transition, although they are different within their cosmic spaces. The contradictions in the semantic space, economy, human consumption and production seem to result from the fact that Earth is inhabited with different, with respect to each other, cosmic civilizations which are united in the transition signal forms (semantic fields) due to certain similarity between ecological structures, inherent in Earth (Fig.5). This is like the technological process of introduction of man into a certain virtual space by means of sophisticated computed transformations. If the knowledge on the nature of our own intellect goes back, then, in essence, the whole planet in its informative interactions is limited by our sensor, semantic, and other processes is introduced by humankind into a computer world, and we immerse in a virtual planetary space. All the disasters, population explosions, ecological deficiencies, disputes on our survival in the 21st century, ideas of the stabilization and progress are not meaningful but with respect to the planetary intellect. They may already reflect not historical truth and the matter of cognition but that the humankind joins the substantially changed planetary virtual world.

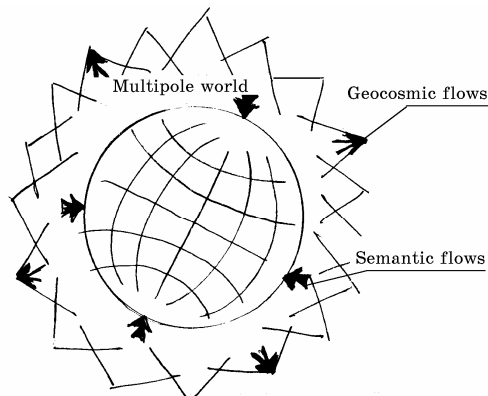

**Figure 5** Geocosmic civilization and their relationship withing the semantic space.

Thus, we have to ask ourselves: Where do we move our planetary intellect? Do we really make it equipped with space satellite communication systems against a potential 'menace'? Do we understand our own spacecraft and our own crew? Is mankind so unambiguous and uniform in its planetary-cosmic origin? Aren't we a planetary-cosmic community of different civilizations on Earth?

Our history, our concord, our coexistence depend on those planetary intellectual formations which were referred to from the outset; they are represented as a multipole world. We do like to have the Centers of the new kind based on ideas of N.A. Kozyrev and other scientists at our place in Siberia and in other regions of Earth. They are to be a skeleton of the prospective planetary valeological system which

would not only promote the formation of the information system but also use the processes of human productivity and human consumption per gross product unit as the basis for its activity. At present the money supply, market and competition accumulated at certain poles make the ever greater increase in the human consumption. More human lives are expended, and various civilizations contribute unequally to these expenditures.

Thus, the planet's intellect of the 21st century, humankind as a whole approach the point of setting and solving these problems. It is of vital importance that these problems would not be buried in the pragmatic activity, in disintegration thriving today, that we would enter the 21st century with the program of further progress in the united intellect of the planet and cosmic space.

## References

- [1] Циолковский К.Э. Очерки о Вселенной. - М.: Паимс, 1992 - 256 с.
- [2] Вернадский В.И. Проблемы биогеохимии. - Труды биогеохимической лаборатории. Т.ХVI. М.: Наука. - 1980
- [3] Флоренский П.А. Сочинения в 4 т. - М.: Мысль. - 1994.
- [4] Чижевский А.Л. Эпидемическая катастрофы и периодическая деятельность Солнца. М.: Изд-во всероссийских врачей гомеопатов. - 1930.
- [5] Козырев Н.А. Избранные труды - Л.: Изд-во ЛГУ. 1991. - 445 с.
- [6] Тейяр де Шарден П. Феномен человека - М.: Наука. 1987. - 240 с.
- [7] Капица С.П. Феноменологическая теория роста населения Земли // Успехи физических наук. - 1966. - №1. - С.63-79
- [8] Акимов А.Е., Шипов Г.П. Торсионные поля и их экспериментальные проявления. препринт МТПФ АЕН. - М. - 1995.
- [9] Акимов А.Е. Эвристическое обсуждение проблемы поиска новых взаимодействий. EYS'-концепции // Сознание и физический мир. Вып. 1. М. - 1995. - С.36-85
- [10] Акимов А.Е., Бинги В.Н. О физике и психофизике. - там же, - С. 104-126.
- [11] Шипов. Г.И. Явления психофизики и теория физического вакуума - там же, - С.85-104.
- [12] Московский Л.В., Мирзалис Н.В. Сознание и физический мир, - там же. -С 6-36
- [13] Девис П. Суперсила: поиски единой теории природы. - М.: Мир. 1989. - 272 с.
- [14] Лесков Л.В. На пути к новой картине мира // Сознание и фзическая реальность. Т.1. - 1996. - № 1-2. - С.42-54
- [15] Гумилев Л.Н. География этноса в исторический период. - Л.: Наука. 1990. - 279 с.
- [16] Казначеев В.П. Космогонические проблемы биологии и медицины: проблемы, поиски // Будущее России: доктрины возрождения и устойчивого развития страны. - Материалы

- II съезда Петровской Академии Наук и Искусства - С.П. - 1997 - С.73-106.
- [17] Казначеев В.П. Сохранить народы России - там же. С.119-123.
- [18] Казначеев В.П., Спиринов Е.А. Космопланетарный феномен человека. - Новосибирск. - 1991
- [19] Бартини Р.Л. Некоторые соотношения между физическими константами // ДАН СССР, 1965. - Т.163. - № 4 - С. 861 - 864.
- [20] Казначеев В.П., Михайлова Л.П. Сверхслабые излучения в межклеточных взаимодействиях. - Новосибирск: Наука. Сиб. отд-ние 1981. - 144с.
- [21] Kaznacheev V.P. Cosmological, Informational-Energetic Aspects of Organization of Living Matter: Prospects of the Natural Sciences // NCGR? National Council for Geocosmic Research - Spring 1991 - P. 11-14
- [22] Галимов Э.М. Природа биологического фракционирования изотопов - М.: Наука, 1981 -246 с.
- [23] Kervran L. Transformations l'energie du fibres. - Paris: Malou. 1975 - 150 p.
- [24] Гурвич А.Г. Теория биологического поля - М.: Госиздат. 1944 - 155 с.
- [25] Бауэр Э. Теоретическая биология. -М.: ВИЭМ - 1935
- [26] Targ R., Narary K. The mind race // N.Y. Villard Books. - 1985. - 250 p.
- [27] Джан Р.Г. Нестареющий парадокс психофизических явлений: инженерный подход // ТИИЭР. 1982. - т. 70. - №3 - С. 90.
- [28] Jahn R. The Role of Consciousness in the Physical world // Boulder, CO: Westvier Press. - 1981
- [29] Jahn R., Dunne B. Margins of reality: the role of conscionsmess in the physical world // San-Diego, etc: Harcourt Brace Jovanovich, - 1987 - 415 p.
- [30] Popp F. A. et al. Electromagnetic BioInformation - Urban Schwarzenberg. - Munchen - Wien - Baltimore - 1989 - 259 S
- [31] Казначеев В.П., Горяев П.П., Васильев А.А., Березин А.А. Солиноно-голографический геном с коллективно симметричным генетическим кодом: Препринт. - Новосибирск: СО РАМН. - 1990.
- [32] Горяев П.П. Волновой геном. - М.: общественная польза. 1994 - 280 с.
- [33] Монро Р.А. Путешествие вне тела. - Новосибирск: ВО Наука, 1993.
- [34] Laszlo E. Cosmology and the Psi Field. - The Whispering Pond. - Element Books. - 1996 - 238 p.
- [35] Дубров А.П. Роль парапсихологии в смене парадигмы современного естествознания // Парапсихология и психофизика. Журнал фонда парапсихологии имени Л.П. Васильева. - 1997. - № 1(23) - С.11
- [36] Ли А.Г. Парапсихология - наука и социальнокультурный феномен - там же с. 12-14
- [37] Винокуров И., Гуртовой Г. Психотронная война: от мифов - к реалиям. - М.:Мистерия. - 1993ю - 365 с.
- [38] Kaznatcheev V.P., Trofimov A.V. Cosmic consciousness of Humanity // Published by Elendis - Progress. - Russia, Tomsk - 192 p.
- [39] Казначеев В.П., Трофимов А.В. Проблемы новой космогонии ИОПиЭЧ СО РАМН Новосибирск, 1994 -124 с.
- [40] Trofimov A. Paradoxes vivants dans l'espace de la Terre // Enefgie Sante 1995 30 p. 58-64.
- [41] Marzullo G. Month of Birth Creativity and the two classes of men. Per Aspera Books. 1996. 287 p.
- [42] Казначеев В.П., Деряпа Н.Р., Хаснулин В.И., Трофимов А.В. О феномене гелиогеофизического импринтирования и его значении в формировании типов адаптивных реакций человека // Бюллетень СО АМН СССР. 0-1985.5. С.3-7
- [43] Трофимов А.В., Гадалов А.А. Гелиогеофизический баланс пренатального периода развития и его роль в стратегии здоровья человека // Вестник МИКА 1997. 4. с. 27-36
- [44] Мечников И.И. Этюды оптимизма. М.: Наука. 1987. 327 с.
- [45] Берг Л.С. Труды по теории эволюции. 1922-1930. Л.: Наука, 214 с.
- [46] Fridjung M. Time: a Challenge to Physics? // Network № 63 April 1997 p.17
- [47] Васильев Л.Л. Таинственные явления человеческой психики М.: Госполитиздат. 1963. 168 с.
- [48] Бехтерев В.М. Об опытах над мысленным воздействием на поведение животных // Вопросы изучения и воспитания личности. 1920. № 2
- [49] Бехтерева Н.П. О мозге человека. Нотабене, С.П. 1994.
- [50] Мочанов Ю.А. Древнейший палеолит Диринга и проблема внетропической прародины человечества // Археология Якутии. Якутск: Изд-во ЯГУ. 1988. С. 15-53
- [51] Фром Э.Ф. Что такое. Львов, Киев: Инициатива. 1984
- [52] Bucke R.R.. Cosmic Consciousness. A Study in the Evolution of the Human Mind. Innes and Sons. 1901 N J Dutton 1920, 17th ed. 1954.
- [53] Налимов В.В. Спонтанность сознания. М.: Прометей. 1989. 287 с.
- [54] Налимов В.В., Дрогалина Ж.А. Реальность нереального. Вероятностная модель бессознательного. М.: Изд-во "Мир идей" АО АКРОН, 1995. 432 с.
- [55] Шпенглер О. Закат Европы. - Новосибирск: ВО "Наука". 1993 - 592 с.
- [56] Гроф С. За пределами мозга. М.: Соцветис. - 1992.





## SEXUALITY VERSUS SPIRITUALITY

Ljiljana Klisić

Psychiatric Clinic, KBC Dr. Mišović, Joce Jovanovića 7, Belgrade, Yugoslavia

**Abstract.** In our Judeo-Christian culture for over twenty centuries there has been a deep split between sexuality and spirituality. That split is aborting a harmonious psychological growth and development of consciousness in general, because human beings are forced to choose between sexuality and spirituality. There is a prejudice that sexuality is something contrary to spirituality. No matter what we choose, we always remain unfulfilled and split as a result of this choice. The possibility of integration of these two realities I see in theoretical concept of *orgasm development*, which implies that orgasm is possible to develop from the most primitive forms through immature and blocked toward mature and extended, to ecstasy and bliss, and beyond - to non-dual forms. This concept can be measured and experimentally tested with modern devices like EEG, MEG, PET, etc.). It is important to understand that the function of a developed orgasm is not only procreation in space, like in lower forms of orgasm, but in higher forms it is reinforcement in consciousness development. Knowing the psychological definition of consciousness we will see how much the concept of orgasm development can help us to investigate it. Is orgasm something that develops, or it is constant? Can we while studying orgasm learn more about the general psychic development and the process of psychotherapy? Are all orgasms alike? While engaged in the psychotherapeutic process I noticed that the descriptions of my clients and the descriptions in relevant literature differ so dramatically that it requires a classification of orgasms, which roughly goes as follows: Primitive, Immature, Perverse, Neurotic, Blocked, Mature, Extended, Ecstasy, Bliss, Non-dual. The nature of orgasms is always the same, our experiences differ. How long and with what distortions the essence of orgasm can be tolerated depends on the level of our consciousness. This is where the differences in the classification come from.

**Key words:** *sexuality, spirituality, consciousness, orgasm classification, development.*

### 1 Introduction

As Reich, Marcuse, Laing, and others have emphasized, we are living in an extremely alienated and frustrated civilization. On an individual level psychotherapists witness that people are not in contact with their real feelings and needs. Instead, they are building a false calling it normal state. What is the ground for such a sad state of affairs? We are not aware that there is a taboo on the most positive and most intense psychological experiences. It sounds very logical to state that we have a need for the most positive psychological experiences, but the problem is that we have repressed this need to the subconscious realm, because of the taboo and then we are trying to

fulfill it in a partial and distorted way. This is the source of many "unsolvable evils" of civilization, like drug addiction, cults, purposelessness, etc. It is high time we became aware of the taboos on bliss, creativity, ecstasy, and joy, which generate envy, jealousy, gossip, hatred, psychological and somatic illnesses. As many psychologists have explained the repression of sexuality has the key role in this, but we are now going to ask a question on the repression of bliss and the very repression of sexuality gives people a moral alibi, with a consequence that real morality is not developed thereby, while a healthy sexuality is repressed.

We must have in mind that sexuality can be used for development of consciousness.

After Reich's explanation of the function of orgasm, the time has come to ask the question about the function of bliss.

### 2 Historical Background

Many millennia ago the ancient traditions had strongly connected sexuality and orgasm with consciousness, but within the context of the culture of that time, which is rather incomprehensible to us. We are now coming to our modern way of doing it.

One century ago, sexuality development was Freud's and Reich's strategy in studying human psychic development. S. Freud proposed the concept of libido and psychosexual stages of development and W. Reich proposed characterology, orgasm potency and orgasm reflex. Both were concerned with genital development and genital character. Later investigations (Lowen, Kelley) have showed that some neurotic tendencies always remained in already formed persons, so that genital character doesn't exist. They hold the opinion that it is only a fiction, an ideal.

What a sad state compared to the brave hopes that Reich described in his books! Still, are such hopes unattainable fictions? Studying ancient spiritual traditions and modern transpersonal psychology maybe we can point out a way that seems to lead on from this point where Reichian and general psychoanalytic theory stops. In that sense we can point out that a way maybe exist, but it is much longer, harder and more difficult than the simple scheme defined by Freud and Reich. In their theory of sexuality, Freud and Reich detailed only one part of the sexuality and the orgasm development. Annie Besant and Ken Wilber defined a spectrum of

consciousness like a general basis on which we can connect with.

But is it possible really and practically to go further? To come closer to the genital character? Psychoanalysis has developed a good way to work with Ego mechanisms of defense and vegetotherapy has developed a good way of integrating the body and the psyche but we now need to explore other levels of consciousness. To become really free from blockages, a true "genital character", it is now necessary to deal with more levels of consciousness and to integrate them - much more than Freud and Reich thought. To the well-known characters (oral, anal, phallic, genital), we can maybe add "heart" character and "divine" non-character. I will connect genital character with maturity and ability to surrender to "orgasm reflex" but not to a perfection. Real and total freedom from blockages I will connect only to "divine non-character".

I think that investigations of orgasms can give us a good model to start with.

### 3 Orgasm Classification

Is orgasm something that develops, or it is constant? Can we while studying orgasm learn more about the general psychic development and the process of psychotherapy? Are all orgasms alike?

In discussing comprehension of sexuality in different theoretical systems, we come to the crucial but not clearly defined term of orgasm as the supreme sexual experience. Reading literature we often ask ourselves whether all described orgasms are the same? It seems that differences between them are so drastic as to demand the introduction of new terms. As a matter of fact, the word orgasm describes a very wide range of experiences with very refined and nuance differences. Even in one person's experience of orgasm there are usually great differences. Personal descriptions of many people just increase such diversity. Following K. Wilber's theory of the consciousness spectrum and Reich's study of phases of orgasm along with previous distinction of different potencies (ejaculatory and orgasmic potency) as well as drastic differences between statements about orgasm from the people I worked with, my opinion is that it would be necessary to introduce new terms for different orgasms. I will try to roughly classify a satisfactory peak of sexual experience into: primitive, immature, mature, ecstatic and non-dual orgasm.

The nature of orgasms is always the same, our experiences differ. How long and with what distortions the essence of orgasm can be tolerated depends on the level of our consciousness. This is where the differences in the classification come from.

**(1) Primitive orgasm** characterizes early phase of human development in phylogenesis and the level of consciousness which is closer to the animal level. The consciousness is focused on brutal discharging, or as Reich would put it, urinating into a woman. The feeling of love toward the partner is not necessary. The

pleasure is pretty small and looks like reducing, relief, emptying, unloading, or shaking out. It is fucking, not making the partner happy. Primitive orgasm characterizes non-selective acceptance of any partner, the lust directed only to the satisfaction of the sexual instinct and consciousness directed only to the sex organs. For woman, it is a hole that needs a plug. The scope of consciousness remains narrow. Psychodynamic is undeveloped and poor.

Discharge is convulsive and subjectively it feels like relief. Orgasm may last from three to seven seconds. Contractions are superficial, vaginal-squeeze, clenching type - for women. For men three- to five-second bursts of pleasurable internal contractions (emission phase orgasm), which is followed by ejaculation phase: six to ten strong propulsive orgasmic contractions. In the next orgasm levels this primitive basis should be developed and refined, but contact with it should not be lost.

#### ORGASM DEVELOPMENT

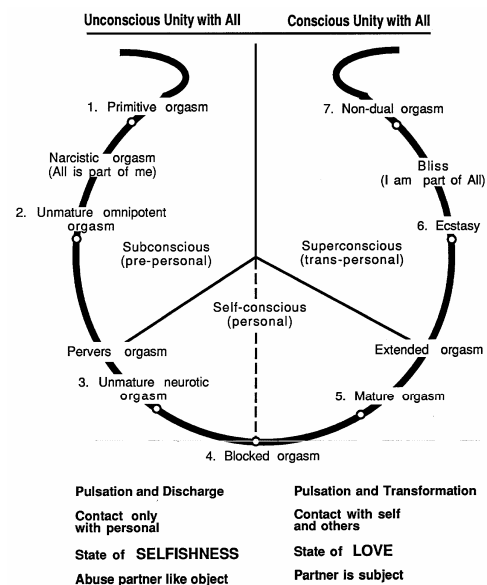

**(2) Immature orgasm** includes perverse, narcissistic, neurotic and blocked forms. Immature orgasm subjectively is experienced like something incomplete. Pleasure and joy are usually small.

Immature orgasm is characterized by strong non-coordination of impulses. Libido and reactive impulses are not fused. For example in a case of *perversion* one form of an impulse prevails over another, which is isolated and dominates in separate parts of life. In the case of perverse orgasm discharge it is more like destruction. It is strong impulsiveness without control and channeling. *Narcissistic* orgasm is experienced like state of omnipotence. The person feels like the center of Universe: all is part of me. But shortly after it, there comes reality which negates that feeling. Often it leads to the destruction or isolation or another primitive mechanism of defense. It is a pseudo ecstatic experience with narcissistic dynamic without flexibility. No attachment is missing. I would say it is "remembering of the future", just this immature structure is not able to stand it.

In *neurotic* orgasm discharge is limited to one part of the body and is not leaving the feeling of full satisfaction. The partner is abused like an object. In the case of impotence and frigidity we have a *blocked* orgasm. The ways of discharge are temporarily closed by fear, anger, pain blocks and by channeling energy into the release of inner conflicts. This often results in lack of orgasm. Only by spreading consciousness through greater self-acceptance and acceptance of others the channel can be opened again for discharge.

Immature orgasm lasts for around seven to zero seconds. Contractions are usually superficial and brief. Contractions in this category are limited only to the genital part - not the whole body, like Reich suggested. In the blocked orgasm there are no contractions.

In a mature social environment, those immature forms of orgasm should be acted out in adolescence through play. With support of understanding adults the young should channel their energy toward more mature forms of orgasms and of their total behavior.

**(3) Mature orgasm** is a desirable fusion of love and destructive impulse in man. It can be reached only if there exists some kind of love and acceptance between partners, besides physical attraction. Such orgasm is much fuller and brings much more happiness and pleasure than the previous forms. Besides opening to the other person, orgasmic convulsive discharge enables accumulated stress reduction, engulfing the whole body and attaining the state of deep relaxation. It seems that humanity in general is now reaching this level of consciousness and it is logical to expect that the evolution will continue.

But in mature orgasm not only discharge is present, there is also the beginning of transformation. That means that subjectively mature orgasm is experienced not only like relief but as fulfillment and deeper contact with the partner. Rough energy is starting to refine into more subtle. Maybe we can define it starting with Reich's words: "Orgastic potency is the capacity to surrender to the flow of biological energy, free of any inhibitions; the capacity of discharge completely the dammed up sexual excitation through involuntary, pleasurable convulsions of the body". Maybe we can continue with: "...this leaves us with a feeling of total fulfillment and with more openness and love toward the partner". Contractions in this level start slowly to change. Beginning with four to twelve seconds, to much longer as we will see later. Contractions are now in the beginning only superficial but later much deeper musculature is involved. Both partners have convulsive orgasm reflex in the whole body (not only in the genital part like immature orgasm).

In advanced stages of mature orgasm we have multiple and extended orgasm. *Multiple* orgasm is identical with brief orgasm except that arousal does not immediately decline to baseline. It repeats several times.

*Extended sexual orgasm (ESO)* is advanced level of mature orgasm and link toward higher forms. Subjective experience and consciousness level is in

most cases like mature orgasm but it lasts much longer - a few minutes or more.

"At its ultimate level, for women, ESO is deep, continuous orgasm of ever-increasing arousal lasting 30 minutes to an hour or more".

"For man, ESO at its ultimate level is first-stage orgasm, that momentary peak of intense pleasure just before a man feels he is going to ejaculate, extended in time for 30 minutes to an hour or more" (Brauer, 1980).

Contractions are on this level drastically changed: for women there are intense, measurable continuous muscular contractions of two types - superficial, clenching, but without pause in beginning, and deep long push-out later, but in this phase still mixed with previous. Toward ecstasy, contractions becomes slower, longer and deeper. For men, the emission phase is extended - to a few minutes or an hour followed by intense and sometimes extended ejaculation phase. Men experience it as sustained orgasmic pleasure. Automatic contractions of pubococcygeus muscle are alternating with relaxation (with a sense of opening-up and pushing out at the same time). Now are starting deeper contractions from the prostate and other glands that contribute to semen production. Ejaculation is under control but close, he stays in the emission phase, where is hard erection, obvious arousal, and sometimes an intermittent secretion of clear fluid from the penis.

Towards ecstasy, this state of longer and deeper contractions gets stabilized, man finds himself in a continuous state of orgasmic emission, continuously climbing, where he no longer needs to concentrate on holding back his ejaculation. When he decides to ejaculate it is followed by more intense contractions.

What will further development look like? As models we can use experiences of people who had the courage to explore those unknown levels. Usually, those people have developed further their whole personality not only this specific function. In those people dynamic ego is ceasing to be the center of personality and is replaced with more authentic Self. Borders are becoming flexible but integrity of personality and consciousness are stable. It is really hard to describe those metaphysical states. We can do it in three ways: with analogies, or with negations but only experience can give us complete answers.

**(4) Ecstatic orgasm.** Probably the next level will be the ecstatic orgasm characterized by expansion of awareness, powerful exchange of energy with the partner and enormous pleasure. Ecstasy is the most intense positive psychological experience possible. During the orgasm one doesn't experience spasmodic convulsions like in lower forms, convulsions are then drastically changed, deeper, slower or ceasing. The whole body is relaxed and filled with free flow of energy. The genital zone gives just the starting impulse. Partners feel great love and devotion for each other but also they are filled with total surrounding reality. Ecstasy is considerably more intense and lasts much longer than the previous categories of orgasm. This means not just a few seconds but minutes or hours.

There are different kinds of ecstasy. "Valley" orgasm is a long exchange of love between partners with control of orgasm. In valley orgasm convulsions do not take place. In other forms of ecstasy orgasm happens with changed and prolonged convulsions. More intense is the awakening of Kundalini, then comes the ecstasy of Brahma (belly region), deeper is the ecstasy of Vishnu (heart region) and at the end the Shiva ecstasy (head region) which means transcendence to non-dual reality. On every subsequent ecstasy level energy is more powerful, dangerous (depending on the amount of unconsciousness materials) and more blissful. However, on these ecstasy levels there is still some dualism and self separation from the environment, while dualism is abolished only in the last level (according to yoga tradition these ecstasy levels would be savikalpa samadhi because dualism still exists, while on the next stage we can talk about nirvikalpa samadhi - the non-dual state).

In ecstatic orgasm contractions are continuous, longer, slower, deeper. For women these are push-out but changed contractions. After climbing and leveling man is entering in ecstasy where P.C. muscles are relaxed, but deep contractions from the prostate continue. Men can be a few minutes or an hour in emission phase, experiencing extended pleasure just like women. This sexual high is similar to a deep meditative state, with electrical brain activity moving in more synchronous patterns (toward alpha and theta waves) with greater activity in the right side of the brain. During this level of orgasm and extended sexual arousal the level of endorphins (natural, morphine-like chemicals secreted by the brain) tends to rise inducing euphoria.

Subjectively such states induce feelings of peacefulness, harmony, altered sense of time, and oceanic state. After these experiences the partners feel so intense emotional closeness like never before. This connection and closeness makes them convinced that they love and are loved. It creates a sense of wholeness without an accompanying loss of individuality or control. Mutual ecstasy is strengthening relationships and enhancing personal sense of well-being. According to M. Laski ecstasy is characterized by transcendence, mystical experiences, timelessness, unity, satisfaction, joy, salvation, glory, sense of new life, etc. Of course, there are other triggers for ecstasy besides sexual love like: art, religion, childbirth, beauty, creative work, scientific knowledge, etc. We can say that ecstasy in sexual intercourse is common trigger and a kind of guide into the world of Spirit. Men then experience broader and richer reality than everyday reality. This is something beyond the most courageous dreams. New ways of existence are opening to him. It is inside in our true Self or God. We see God also in the partner and therefore we devote and adore the partner.

## PRIMITIVISM vs. ECSTASY

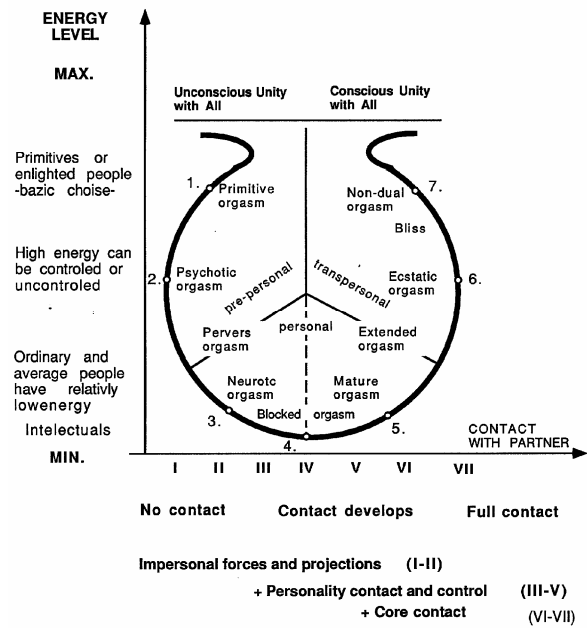

(5) **Non-dual orgasm** has little similarity with the orgasms on the previous levels. It is more a state of awareness than an experience. It is characterized by consciousness of Unity with the whole nature, tranquillity and a state of bliss. An enlightened person makes love with the whole Universe and at the same time he is the Universe. According to Maslow, that would be reaching a state of total self-actualization. According to Reich it is the state of freedom from blockades, character and muscular armor. According to Kelly it is the result of the integration of sexual impulses with value system of the ultimate unity of feeling and purpose. Also William James wrote about intuitive thinking and higher consciousness levels. Ultimate oneness Wilber calls Universal or Mind level of consciousness. According to Tantra traditions, this level can be reached with transformation of sexual energy. According to K.G. Jung man is becoming aware of anima and animus. It is meeting with inner man or woman. Human being is becoming whole - at the same time male and female.

It is hard to measure this level because time is altered - we enter into timelessness. Maybe we can say that there are individual differences - seconds, hours, days, years... As far as I know, contractions are not measured on this level, but in the last levels it seems there are none.

Duality ceases to exist and we enter into eternal Oneness. Sexuality like attraction of two separate polarities is abolished and we enter into non-dual existence. This is the state where there are no splittings, hate or misunderstanding. Wise men who have been in this state say that it feels like bliss, tranquillity and peace. This is unity of Bliss and Wholeness. Harmony with everything that exists. We can say that sexuality is replaced by JOY. According to psychology perennis and transpersonal psychology this is the only reality there is. All other levels of reality and orgasms are

illusions, but we have forgotten it. This is the essence with all orgasms - direct contact with the whole of reality. Unprepared and blocked, we can not stand it more than a few seconds.

#### 4 The Orgasm Concept

In the beginning we have said that the essence of all orgasms is the same, only experience and behavior differ. We can measure behavior, as we have seen.

Our level of consciousness enables us to stay a longer or shorter time in contact with this essence. How long and with what distortions the essence of orgasm can be tolerated depends on the level of our energy, object relations, feeling and purpose development, their integration and similar concrete parameters (see diagrams). This is where the differences in the classification came from. Also, it is the difference in behavior before or after this intense contact with essence. With some people the scope of consciousness narrows, and with some gets wider, as I have described in classification.

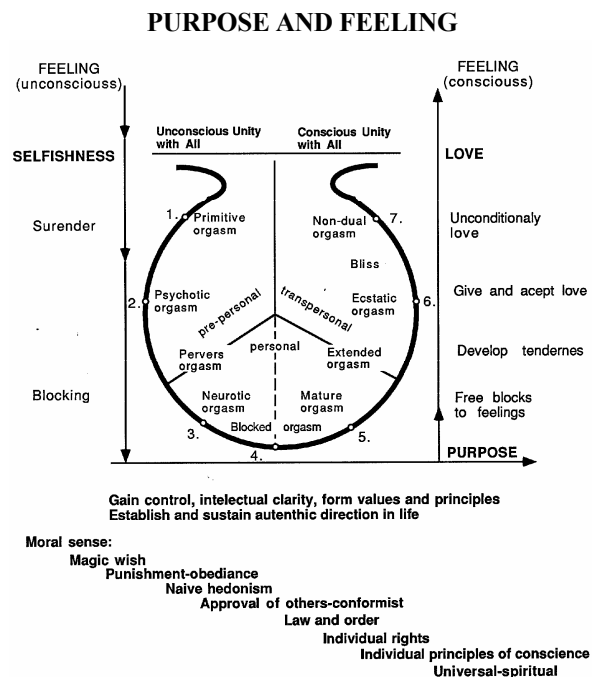

#### 5 What is the Essence or the Nature of Orgasm?

For me, the very nature of orgasm is contact with Core, True Self, Universal Consciousness, God, Cosmic Wisdom, Unity with All, the Holy Secret, the only reality that exists, or whatever you like to call it. But our experience of orgasm is very different because we are not able to tolerate the paradoxical nature of orgasm. As I have shown in diagrams, it depends on the form of our feeling and purpose development and integration. Also the level of free energy is important in relation to contact with the partner. With orgasm

development, we are learning to open more and more (from a few seconds, minutes, hours, etc.) toward Universal Consciousness, unlimited Joy and Love.

In my practice with clients, I have noticed so much ignorance, prejudice, and misconceptions about sexuality and orgasm (which is specially evident in the Judeo-Christian civilization) that ruins life and makes people unhappy and joyless. They must choose between sexuality and spirituality.

Maybe, introducing developmental concept of orgasm will help to reduce rambling and wandering and help to grow in joy as well as in general aliveness and help us to really understand the paradoxical nature of orgasm. Joy of Life is missing in today's world.

Measurements of orgasm was actual topic for a long time. Remember Reich's laboratory in Maine and his measurements of orgasm, then Masters and Johnson and many others. Among last the Brauers who have found a way to measure extended sexual orgasms.

*How can we experimentally prove the hypothesis of "orgasm development"? Right now we can measure:*

- (1) Types of contractions: superficial, deep, squeezing, push-out, mixed type etc; also we can measure pause between contractions;
- (2) Duration of the whole orgasm (seconds, minutes, hours), duration of one contraction, duration of emission phase, ejaculation, etc;
- (3) Type of electrical brain activity (EEG). In extended orgasm and ecstasy electrical brain activity is moving in more synchronous patterns and is shifted toward alpha and theta waves with greater activity in the right side of the brain;
- (4) Another physiological parameter like: respiration, heart activity, muscular tensions, etc;
- (5) Hormone level: the level of endorphins during ecstasy tends to rise, inducing euphoria;
- (6) Interpersonal accordance in their introspective reports; and
- (7) MEG, PET, etc.

Maybe new devices will be discovered to measure the flow of energy and other parameters more precisely.

Probably we can connect our investigation with one branch of experimental psychology - called cognitive information processing. Cognition is understood as an act of communication between the environment and personality. Professor P. Ognjenovic in his Laboratory for Experimental Psychology is exploring consciousness - this most difficult subject in psychology - by doing research on the effect of hypoxia on cognitive processes and by research on the composition of dreams. From the perspective of this research, consciousness is a composition of distinct cognitive processes of different phylogenetic age. It consists of several levels of decision making.

Surface processing levels enable fast reactivity, but as the decision level becomes deeper it allows higher degree of freedom - enables choice. Out of all his findings a conclusion can be drawn: consciousness is a composition of cognitive functions.

The meaning of this arrangement of spaces (functions) of various depths is this: our early ancestors were primarily reactive creatures, and the development of our species was directed towards the more and more mediated (re)acting, which made prediction possible. "Consciousness has thus developed from the need to postpone reactions, and its main purpose is to increase the degrees of freedom in decision making", (P. Ognjenović, 1995).

I think that investigation and the measuring development of orgasm will help in investigation and measurement of consciousness. For example, the process of orgasm development has a few parallels in previous research if assumed that it is possible to replace "discharge" with "transformation" through orgasm development; succession in opening towards deeper internal space of information processing; the importance of motor representations; the shift from experiencing the objects to experiencing the stimulating points on the body - different orgasms along the spine; during orgasm development the shift from contractions in more superficial tissues toward contractions in deeper tissues, etc.

As well as in previous definitions of conciseness, our goal through orgasm development is also to increase the degrees of freedom in decision making. Step by step it is happening in every next level of orgasm development. In order to go further in orgasm development a person must learn to increase the degrees of freedom in decision making. If he succeeds, it is followed by a beautiful reward - ecstasy. If deeper and more complex degree is reached - it is followed by divine reward - bliss.

Does it not help to grow and to develop consciousness?

Therefore, the taboo on bliss keeps this consumer and alienated civilization running, and we do not dare look the truth in the face. The function of bliss is to lead us toward a more humane civilization on the social level and on the individual level to reinforce consciousness development.

## References

- [1] Brauer, A. & D., *Extended Sexual Orgasm*, (Warner Books, New York, 1983).
- [2] Brauer, A. & D., *ESO - Ecstasy Program* (Warner Books, New York, 1990).
- [3] Dychwald, K. *Bodymind* (Pantheon Books, New York, 1977).
- [4] Douglas, N., and Slinger, P. *Sexual Secrets*, (Arrow Books, 1979).
- [5] Kelley, C. Education in Feeling and purpose, *Santa Monica, Radix Institute*, 1974.
- [6] Kelley, C. Opening the Feelings: The Functional Approach, *The Radix Journal*, Vol. 1, Nos. 2, 3 (1979).
- [7] Klisić, Lj. Psychological growth, in *New Directions in Group Psychotherapy* (Avala, Belgrade, 1980), in Serbian.
- [8] Klisić, Lj. The Orgasm concept, Body-psychotherapy or the Art of contact, *Proc. EABP*, Berlin, 1992.
- [9] Klisić, Lj. Reichian understanding of sexuality toward Tantric understanding of sexuality, *Radix Review*, Vol. 3, No. 1 (1993).
- [10] Klisić, Lj. *An Evaluation of Successfulness of Psychotherapeutic Education in the Application of Radix-oriented Psychotherapeutical Methods*, Ph.D. Thesis, Belgrade University, 1989.
- [11] Klisić, Lj. *Body Psychotherapy - To Orgasm and Beyond* (Eko-primat, Belgrade, 1995).
- [12] Klisić, Lj. Orgasm Development, *Energy and Character*, Vol. 28, No.1, May 1997.
- [13] Laski, M., *Ecstasy* (Jeremy P, Tarcher, Inc., Los Angeles, 1961).
- [14] Milićević, F. *Theosophical Society - Yoga of Love* (Zagreb, 1979).
- [15] Ognjenović, P. Consciousness as a (psychological) function, in D. Raković and Đ. Koruga, eds., *Consciousness: Scientific Challenge of the 21st Century*, (ECPD, Belgrade, 1995), pp. 34-44.
- [16] Reich, W. *The Function of the Orgasm* (Farrar, Straus and Giroux, New York, 1972).
- [17] Reich, W. *Cosmic Superimposition* (Orgone Inst., Press, Rangeley/Main, 1951).
- [18] Wilber, K. *The Spectrum of Consciousness* (Quest Book, Wheaton, Ill., 1977).

## THE GOLDEN FLEECE II UNIVERSE - CONSCIOUSNESS - CIVILISATION

Ljubomir Kljakić

A.R.K.A. - Akademia Nova, Bulevar Nikole Tesle 3, Belgrade 47, Yugoslavia,  
 E-mail: ljubaark@EUnet.yu

**Abstract.** The relation Universe-Consciousness-Civilisation is discussed in this work. My standpoint is that the Universe is One, which is All, and the All, which is One. That is why consciousness, i.e. life and civilisation - as a form of evolution, in this particular case, cultural evolution - are some of the fundamental attributes of the Universe. The phenomenon of light plays the main role inside that structure of transfinite space-time complexity. A discussed problem is defined on the basis of various philosophical and scientific approaches unified into a concept of a new enlightenment. There is a full correspondence and equivalence overall universal transfinite scale, "vertically" and "horizontally". One can see that phenomenon on each level of complexity.

**Key words:** universe, consciousness, civilisation, energy, information, matter, set theory, cardinal number, aleph space, transfinite sets and spaces, life, mtDNA, universal symbolic field, interactive communication network, cosmic background radiation, primordial water of creation, invisible universe, dark matter, implicit order, explicit order, universal consciousness, subject-object relation, space of self-consciousness, light, captured light, field of light, light labyrinth, symbolic of flying.

### I

The Universe exists and pulsates rhythmically in harmony with its own laws. Three of its basic attributes are information, energy and matter. A full complementarity and convertibility of these attributes exists: information is transformed into energy, which is transformed into matter, which is transformed into information, etc. That is the principle of the universal change and motion. This motion is manifested as a wave pattern. Consequently, it can be said that the  $Universe = Information \Leftrightarrow Energy \Leftrightarrow Matter$ . Each of these universal attributes is also self-organized as an integrated package with the same structural characteristics: Information / Energy / Matter is self-assembly as  $Information \Leftrightarrow Energy \Leftrightarrow Matter$ . (Fig. 1)

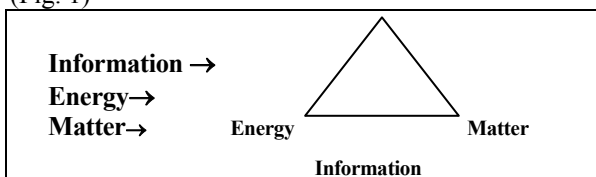

Figure 1

The interactive space  $Information \Leftrightarrow Energy \Leftrightarrow Matter$  is structured as a pattern of rhythmical motion

and as that motion itself (Fig. 2). Although science recognises a difference between the initial state of the Universe and the laws of its latter evolution, there are no strong boundaries between events of different levels of complexity composing space-time.

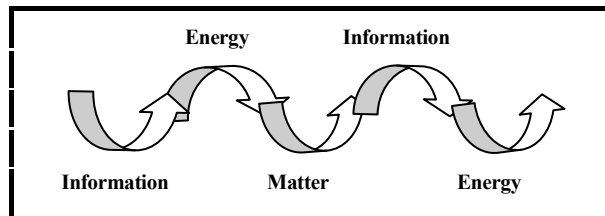

Figure 2

Universe is self-organized as extremely complex, synergically interactive, infinite and endless structure. All forces, forms, states or motions are manifestations of this universal principle of change. That is why the Universe is a unique space of (its own) possibilities: *One that is All and All that is One*. Each of the manifestations - motion, form, and state - represents the wholeness reproduced into a self-assembly order by the laws of symmetry. Of course, there is the reverse relation also. Every manifested possibility is transcript into entirety by the same laws of synergy. The One and the All are equivalents. This principle applies universally, in every point on the scale of complexity from  $-\infty$  to  $+\infty$ .

### II

*The set theory*, theory of reciprocal and unambiguous correspondence of two sets sections - *theory of equivalency* - especially *the concept of power and cardinal number* (Cantor, Russell, Whitehead) helps us to understand better this image. These instruments of modern mathematics indicate natural and ordinal numbers as *transfinite sets*. In the field of a transfinite set, a section can be correspondent and equivalent to the whole. Transfinite, infinite numbers reflect this eccentric and paradoxical phenomenon. Each number, which may be equal to its own parts, is a member of a transfinite number class. They are the principal attributes of the field of transfinite sets. The phenomenon is possible when a set and all its members have the same cardinal number. Transfinite cardinal number of a set, for example set **A**, is a class of all equivalent sets. It

means that every such set can mutually and unambiguously be copied onto set **A**. The principle of unambiguous correspondence makes the reverse process possible, so that set **A** can be symmetrically transcribed on each of its equivalent subsets.

The smallest transfinite cardinal is *aleph-null* or  $\aleph_0$ . Cantor showed that the first strictly bigger cardinal number is *aleph-one* or  $\aleph_1$ , that is  $\aleph_1 = 2^{\aleph_0} = C$ . Follows *aleph - two* or  $\aleph_2$ , that is  $\aleph_2 = 2^{\aleph_1}$ . In other words,  $\aleph_2$  results from  $\aleph_1$ , which follows from  $\aleph_0$ . Therefore, one can see that transfinite continuum  $\aleph_0$  produces transfinite continuum  $\aleph_1$ , that produces transfinite continuum  $\aleph_2$ , or  $\aleph_0 \rightarrow \aleph_1 \rightarrow \aleph_2$ . In harmony with the principle of unambiguous correspondence and equivalence of sets, this means that a transfinite space produces another infinitive continuum as a space of a higher level. The process is then repeated on a higher level of complexity. At the same time, each member of the sets  $\aleph_0$ ,  $\aleph_1$  and  $\aleph_2$  is equivalent to these sets, which means that it can be mutually and unambiguously reproduced. Naturally, the reversed correspondence is valid, and the sets  $\aleph_0$ ,  $\aleph_1$  and  $\aleph_2$  transcribe themselves mutually and unambiguously in each collection of their own subsets. Of course, the process does not finish here. *There is the infinitive continuum of higher-level aleph spaces that follows.* However, the high abstraction we are faced with immediately after *aleph-two* -  $\aleph_3$ ,  $\aleph_4$ ,  $\aleph_5$ , etc. - can be identified only by the law of iteration.

Finally, this suggests full mutual correspondence and equivalence between all collections of subsets constituting aleph spaces  $\aleph_0$ ,  $\aleph_1$ ,  $\aleph_2$  and so forth. They all have the same cardinal number *aleph-null* or  $\aleph_0$ . That is why a subset **A0** in space  $\aleph_0$  is in correspondence with subset **A1** in space  $\aleph_1$ . At the same time, **A1** is also in accordance with subset **A2** in continuum  $\aleph_2$ . Subset **A2** is, in the same way, in correspondence with subset **A3** in space  $\aleph_3$  etc. So, there is a full correspondence - which means symmetry, harmony, and synergy - between these subsets. They intercourse as entities of different levels of complexity in symmetrical accordance:  $A_0 \Leftrightarrow A_1 \Leftrightarrow A_2 \Leftrightarrow A_3 \Leftrightarrow \dots \Leftrightarrow A_n$ , where  $n \in \mathbb{Z}^+$ .

### III

We recognize *the Universe as the set of all sets* containing all the transfinite aleph spaces and all their mutual relations. Therefore, the principles of full correspondence, equivalence, symmetry and synergy are instruments of its self-regulation. Each particular subset is reproduced in this set of all sets. In the same way, the Universe itself is reproduced in each of its parts. Finally, there is a relation of full correspondence and symmetry between each of the particular entities from the class of an infinite number of relatively autonomous subsets - they are forces, states, and forms - that represent the "content" of the Universe. Those are the three basic relations of universal equivalence.

I named this attribute *the universal symbolic field*. Because of its extreme communicability, the universal symbolic field is also manifested as an *interactive communication network* of optimal possibilities. Without an exceptions, the universal correspondence is affirmed on the whole of the transfinite space-time scale from  $-\infty$  to  $+\infty$ . That is the meaning of Pythagoras' "*Αριθμῶ δε τε πανι επειοηεν*" - "*Numbers are the essence of things.*" The principle of universal correspondence is philosophical meaning of Pythagora's definition of the principle of analogy, as well. Plato published the formula in his Seventh letter: "*Γνωση δ' η θεμιζ εσει, φυσιν περι παντοζ ομοιην*" - "*You will realize, as much as possible for a mortal, that the Nature in all is similar to itself.*"

### IV

There are numerous empirical, exact arguments that can be used to prove this philosophical standpoint. Arguments were provided by science, especially science of the 20th century. A good example are the results of the detection and measuring of the cosmic background radiation, the program on which a great number of researchers worked in COBE (Cosmic Background Explorer) program from 1976 to 1991. Those research results of the Universe origin and evolution were publicly presented for the first time on 23rd April 1992, during the annual convention of the American Physical Society. Stephen Hawking considers the work of COBE team as "the scientific discovery of the century, if not of all time." The results of this research have made the articulation of the following image of the creation and evolution of the Universe possible.

- (1) *"The Moment" of the creation of the Universe; a pregeometry of foamlike space-time whose laws are unknown.*
- (2) *The Grand Unification Epoch (GUT) or the Epoch of Cosmic Inflation; space-time at  $10^{-43}$  second after the "beginning" with temperature of  $10^{32}$  ° Kelvin; the strong, weak and electromagnetic forces are unified; probably accelerated expansion of the Universe called cosmic inflation; very large and flat Universe was created; its form was wavy, and the shape of its movement is described as ripples.*
- (3) *Space-time of  $10^{-34}$  second after the "beginning" with temperature of  $10^{27}$  ° Kelvin; the strong force becomes distinct from the weak and electromagnetic forces, the united field decomposes; the Universe was a plasma of quarks, electrons and other particles; the cosmic inflation ends under the pull of gravity.*
- (4) *Space-time of  $10^{-10}$  second after the "beginning" with temperature of  $10^{15}$  ° Kelvin; the electromagnetic and weak forces separate; an surplus of +1 part of a matter over antimatter in a billion (1,000,000,000 + 1) was developed at that "moment"; quarks can produce positrons and neutrinos; particles gain substance; the Universe as a primordial water of creation started to be formed.*



- (5) *Space-time of 1 second after the "beginning" with temperature of  $10^{10}$  ° Kelvin; neutrinos decouple, positrons and neutrinos annihilate; the remaining electrons stay with dominating background radiation as the main active constituent of the Universe.*
- (6) *Space-time of 3 seconds after the "beginning" with temperature of  $10^9$  ° Kelvin; protons and neutrons are able to bind and form nuclei; their fusion energy is greater than radiation energy of cosmic background radiation; rapid forming of light nuclei: first deuterium (heavy hydrogen - one proton and one neutron), and then nuclei of the heavier elements, from helium to lithium (three protons and four neutrons). Round 75% of all nuclei of the Universe are *hydrogen* nuclei (one proton), and 25% are *helium* (two protons and two neutrons); the presence of other elements is minor; all heavier elements will later form in the stars nuclear reactions; *the Universe as the primordial water of creation - a primordial soup of matter and radiation with density of water; it will be freezing for the next 300,000 years; the fact that the photons could travel only short relations between reactions, made it possible for the primordial water to be dark, non-transparent, hidden and invisible Universe for the next 300,000 years.**
- (7) *Space-time at 300,000 years after the "beginning" with a temperature of  $3000$  ° Kelvin; the end of the Universe as *primordial water epoch*; decouple of matter and cosmic background radiation; the electrons bond with nuclei and form neutral atoms; photons are no longer in interaction with electrons, they break free and become able to travel great distances; then, after 300,000 years of practical invisibility, non-transparency and hiding, *the Universe became transparent and visible producing the light waves - more precisely, these are the light oceans - in all directions*; thanks to the modern science and technology COBE team managed to detect, measure, and map this situation in November 1991.*
- (8) *Space-time at 1 billion years after the "beginning" with a temperature of  $18$  ° Kelvin; from the primordial ripples clusters of matter form that transform into *quazars, stars and protogalaxies*; in the stars interior nuclear reactions transform the nuclei of primordial hydrogen and helium to heavier elements: *carbon, nitrogen, oxygen and iron*; stellar winds and supernovas explosions make dispersion of these elements in space-time possible; *new stars, planets and life* are created.*
- (9) *Space-time at (approximately) 15 billion years from the "beginning" with temperature of  $3$  ° Kelvin - present epoch; our solar system condensed 5 billion years ago from the remainings of dead stars; complex chemical processes linked the atoms into molecules, and then into complicated solid and liquid forms; appearance of *the Sun energy, liquid water* and other *cosmic radiation*, full-fills the basic*

conditions for the emergence of the *life* and starting the local *evolution* cycle in our solar system; finally, *"from the ashes of the stars came man to think about the universe around him"*; the *civilisation wave* was initiated.

## V

Thinking about the Universe is an act of reproduction and recovery of the entire process of its creation and existence. In that way, one of the fundamental potencies of the Universe itself is manifested. It is the potency of *universal consciousness*.

Universal consciousness is manifested as a transfinite space of complexity. Our present knowledge allows us to imagine that space as a space of possibilities established between two "points" of extremely distant capacities. On the one hand, there is a space of archetypes, abstract patterns, and images of all forms, states and motions - *transfinite space  $\aleph_0$* . David Bohm calls this field *implicit order*. Ilya Prigogin named it *the space of dissipative structures*. He finds that the field of dissipative structures can be considered as a *"primitive state of consciousness"*. Burkhard Heim thinks that the field of prestructures is "hid" in a *gravity field*, which, as basic information space, contains certain *imaginative or intuitive energy*.

Opposite to that space of archetypes, primitive consciousness, imaginative and intuitive energy, there is a space of its transfinitely complex manifestations. That is the Universe itself - *transfinite space  $\aleph_{n+1}$* , where  $n \in \mathbf{Z}$ . Erwin Schrödinger found that this transfinitely complex structure, this One that is All, consequently must correspond with attribute of the *universal consciousness*, that is the *universal spirit*. Faced with the same phenomenon, Freeman Dyson formulated his comprehension in a different way. Once he said: "The more I examine the Universe and the details of its architecture, the more evidence I find that the Universe in some sense must have known we were coming." There are many more concepts, theories and hypotheses in context to which the same standpoint is varied. In the work, which is a contribution to the discussion to these problems, I supported the concept of *the selfconsciousness of the Universe*.

A paradox of our concept is that these two spaces can be separated only conditionally. Considering the principle of universal complementarity and equivalency, they - as it was already said - transcribe onto one another as spaces of different levels of a unique world complexity. It is a complex system of close packed spheres on transfinite scale. The other arguments to the non-existence of clear and solid boundaries between different states, processes and forms in the Universe, were mentioned above: *Universe = Information  $\Leftrightarrow$  Energy  $\Leftrightarrow$  Matter*.

The same relation is reproducing and renewing in each manifestation of the Universe on the scale from  $\infty$  to  $+\infty$ . There is a full correspondence between the Universe and all its states, forms and processes. *The*

*Universe is equivalent to itself in its every point.* This attribute appears as *extreme communicability* of the Universe, as *the interactive communication space*. The impossibility of setting a clear, solid and impenetrable boundary in relation between the subject and the object of observations is a consequence of this state of facts. "The world shows as one, and not as a world that exists and a world that is perceived"- says Schrödinger. The human experience of thinking, observing, measuring, researching, memorizing, creativity - that is, the field of our imagination and knowledge, of our cultures and civilizations - is possible considering the universal validity of this attribute. *That is why every subject-object relation represents a field of self-consciousness, correspondence and equivalence, and not a field of disagreement and divergence.* There is no exception to this rule. We equally participate in establishing field of self-conscious correspondence and equivalence, when we think of the Universe and its fundamental attributes, and when we explore each of its particular manifestations.

## VI

The field of self-conscious correspondence is possible because the *object* of observation itself - here it is the Universe - is *held in the subject* as its own attribute. On the other hand, every subject - and here it can be just any observer of the Universe, including this author - represents the *attribute* of the *object* of observation. A representative example clarifying this is the phenomenon of *life*.

If we follow the logic of universal evolution, we clearly see that *life is one of the basic attributes of Universe*. Contemporary science on Earth knows *tens of billions* of organic molecules in approachable Universe. However, only *about fifty* of these molecules mean anything in creation and function of life itself. In the coordinates of the Earth's biosphere, these molecules are fundamentally the same in all living beings. The scale of one billion nucleotides represents the contents of human DNA. Most of their combinations make no sense. Those combinations produce a synthesis of proteins that have no functions useful for life. Anyway, it is not known to us that they have, or could have such functions. Just a limited number of molecules of nucleic acid possess the information capacity that we can thank for our present shape and attributes. On the other hand, the total number of possible useful combinations of this limited number of nucleotides, is amazingly great. It is probably much greater than the total number of electrons and protons in the known Universe. It means that the possible number of different human being is unthinkably greater than the total number of people that have lived on Earth. "Yet unused human potentials in this way are really enormous"- says Carl Sagan. And adds: "It is certain that there are ways of combining nucleic acids, whose outcome would function much better - by any standard we choose - than any human being that has ever lived."

At the same time, and in full accordance with the principle of universal complementarity and equivalence, humans possess *the same "code book"* for translating the information from nucleic acids into proteins, as virtually all other living beings on our planet. Both the simplest - on Earth those are viroids and pleuropneumonia organisms - and the most complex living systems - on Earth this is man - are manifestations of *the same and unique information package*. And it is one of the transfinite spaces of the Universe.

Therefore, it is clear that while discovering the attributes of the Universe as our object of observation we become conscious of ourselves. By becoming conscious of ourselves we transcribe and renew the whole cycle of our (local) evolution. In addition, since our (local) evolution is an attribute of the Universe, that is the object we observe, explore and think about, then in this operation we reproduce and renew the whole process of creation and existence of the Universe.

## VII

*Light plays a central role in this space of selfconscious correspondence.* It plays a decisive role in the creation and evolution of the Universe itself. Therefore, it is one of the basic conditions for the appearance of life. (Life is hardly imaginable without water and light. Anyway, it stands for all terrestrial life forms. A certain number of recently discovered exceptions do not make the fact invalid.) *Light is a special form of that integrated structure: Information  $\Leftrightarrow$  Energy  $\Leftrightarrow$  Matter.*

For the first 300,000 years from its hypothetical moment of birth, the Universe was structured as dark, invisible, non-transparent and hidden space-time. That is the implicit order of David Bohm. This invisible space density of water could have only been transformed into visible time-space, i.e. into an explicit order, by releasing photons and light waves. *Light is the main intermediary in transforming the implicit into explicit order.* At the same time it carries the information matrix of motions, forms and states, the "code book" for decoding the matrix, and also the materials needed to structure its content explicitly. As a universal attribute of the world we know, this stands in all its aleph spaces, for each of transfinite number of subsets of those spaces and for each of infinite number of their mutual relations.

The phenomenon that *approximately 90% of matter* of the known Universe is so called *dark matter* - invisible, non-transparent and hidden clusters of unknown matter - is also detected thanks to the identified and known attributes of light. Inside clusters of the dark matter light is not absorbed, it is not reflected nor emitted. Those are spaces of *captured light*. For now, we can only speculate about the conditions that brought to the confiscation of light in 90% of matter of the known Universe. Nevertheless, on the basis of known universal attributes of the space-time, we can *suppose* with good reasons that

under adequate conditions *light will be released* from the prisons of dark matter. With consequences analogous and corresponding to consequences of its release in the year 300,000 from the "moment" of hypothetical birth of our Universe.

*Consciousness* is the only particular attribute of the Universe that can create *cognitive space*, that is the *space of selfconscious correspondence*. In that way *consciousness revives and reproduces the whole cycle of universal creation and evolution*. The role of light is decisive in the process. That is why the space of selfconscious correspondence, that is the subject-object relation, i.e. our cognitive space is structured as a *field of light*.

*About one hundred billion neurons of human brain correspond to the number of stars in the Milky Way*. Thousands of connections a neuron can have with its neighbours show that in our brain there exist around  $10^{14}$  - a hundred trillion - of such connections. Electromagnetic impulses that help these connections activate are emissions of *light packages*. Therefore, it is said that a cortex activity in the moment of awaking is similar to a start of spectacle at the very beginning of Milky Way cosmic game.

Light possesses this attribute because of its property to transfer the optimal quantity of information by extreme speed to extremely long distances. As one of the basic space-time qualities, light cannot be defined in any other way except by itself, that is by concepts that are its own attributes. In addition, this stands both for the Universe, and for the consciousness. This means that there is an optimal level of correspondence and equivalence between the Universe, the Light and the Consciousness. Those are the three transfinite aleph spaces in ideal symmetry relations. Their relation can be presented by a simple universal formula:  $Universe = Light \Leftrightarrow World \Leftrightarrow Consciousness$  (Fig. 3).

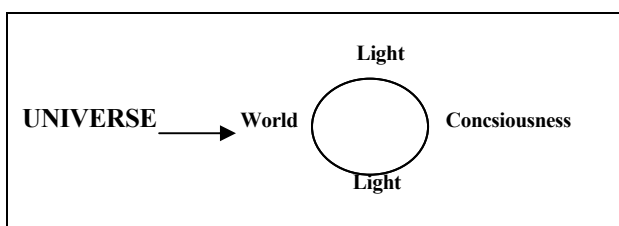

**Figure 3**

It is understandable that there is no general agreement on this matter. Numerous questions about nature, structure and other characteristics of light, consciousness and world have not been given satisfactory answers. There is also no general agreement about the answers that have been proposed. And it is very probable that all the right questions have not yet been asked.

### VIII

We can reconstruct the philosophical and scientific debate about the nature, structure and attributes of light from 6th century BC, which is for the last 2.500 years. At the beginning of debate, in 6 century BC, on

different points of geographical space, we can see a group - some kind of intellectual and spiritual brotherhood - of contemporaries that have left a deep trace to our time. They were Thales, Anaximandros, Pythagoras and other Ionian thinkers; Etruscan kings in Rome; pharaoh Necho who organised a naval expedition around Africa; Zarathushtra on the Iranian plateau; old Jewish prophets in the Middle East, Confucius and Lao Tzû in China; Siddhârtha Gautama, called Buddha or Awakened, in India. "It is hard to believe that all those phenomena were not linked"- says Carl Sagan.

From 16th and 17th century - Leonardo da Vinci, Johannes Kepler, Christiaan Huygens, Isaac Newton - history of modern theories of light standing on more or less identical or very related concepts, can be followed and reconstructed. For example, during the last 200 years there has been a debate on life energy, bioelectricity, electromagnetic force and its influence on biological phenomena, ether, aura and similar problems.

In recent times, Thomas Bearden has explained the fundamental role of light by *scalar wave fields theory*. Nikola Tesla perfected the concept with his *theory of ether*. Vladimir Vernadsky emphasised *the ability of all living organisms to accumulate, store, transform and reemit Sun's light energy as their universal attribute*. Today not well known Russian medical researcher Gurvich showed in 1922 that *every living cell emits light*. This theory was later perfected by Fritz-Albert Popp, and named *biophoton field theory*. Every cell, through the mechanism of DNA, possesses a potential for storing biophoton energy, as well as the potential for its reemitting in a *coherent form*, as a *laser*. Biophoton field, as a special kind of an electromagnetic field, is on the very top of the hierarchy of regulatory levels of reality. The other levels of electromagnetic field are much closer to the field of manifested material reality.

John Wheeler finds that the relation between manifested phenomena and the field of their abstract patterns (motion, state and form of being) can be explained by *elusive quantum foam theory*. This theory is based on the idea of quantum fluctuation, that is a play between particles and the fields proceeding as wave motion under the quantum foam. On the quantum foam level dimensions of space-time become irrelevant. The link between space and time is possible because of a "thorn" phenomenon. Through that "thorn" an instant connection between the manifested being and a phenomenon - otherwise they are set afar - is possible and can be established. The channels of immediate communication Wheeler call *wormholes*. These communication channels are structured through the quantum foam as forms of transdimensional reality. It is a mathematical probability of *space-time tunnels*, known as *the Einstein-Rosen tunnels* as well. Sagan also used the term *wormholes* for that possibility. After the Advanced Quantum and Reality workshop held in

1994 - on that occasion technological exploitation of the space-time tunnels was discussed - NASA adopted a new strategy based on research and development of propulsive technologies and their exploitation. Research of the attributes of the wormholes as space-time shortcuts, has in this concept one of the central roles. In David Bohm's theory of implicit order, photons are a means of dialogue between implicit and explicit world. Here, of course, we must be reminded of the theory of dispersed structures of Ilya Prigogin, but also of Paul M. Dirac's *neutrino ocean*, of De Broglia's *subquantum medium*, of Dubrow's *biogravity* or Wilhelm Reich's *orgon theory*.

These theories are based on the knowledge of *light's dual nature*. It is at the same time *measurable* and *invisible*. For that, light is an ideal transmitter between implicit and explicit order, or between spiritual and material worlds.

## IX

Numerous questions on the human evolution during several million of years are still open. In the same measure as numerous fundamental questions on the Universe, its birth and evolution are still open. After 1974, the method of comparative analysis of DNA in mitochondria (mtDNA) gave solid and convincing arguments for the theory of common human kind origin. Our common ancestors are recognized and identified in Africa. At the same time, the application of this method strengthened some old controversies and opened some new.

Several works published in the *Science* magazine in February 1992, show that creating a common family tree of the human kind is possible, but that it is not so simple to choose the most probable of all possible solutions. For example, Alan Templeton found out in his work that a collection of *189 different mtDNA* - used in a previous research published in the *Science* on September 1991 - produces nothing less than a  $10^{250}$  of *mathematically possible family trees!* In such an impressive forest, it is really hard to find the most probable tree, as well as the place of its origin. Not only because of the vast space of equally probable possibilities, but also because of the shortage of accessible material artifacts that confirms the validity of our choice with certainty. During the conference of the Royal Society and CIBA Foundation - held in February 1992 in London - these questions were discussed from the grounds of (at least) two confronted research programs. The readiness shown to mutually approach views did not solve the questions asked about the problem discussed. On July 1997, journal *The Cell* published the results of a parallel analysis of DNA of a neanderthal (one of the skeletons found 1856 in Neander valley near Düsseldorf) and a modern man. This research has shown their similarity. Nevertheless, big enough differences were noticed to confirm that the Neanderthal is probably not modern man's ancestor. Of course, the discussion about the relation of the modern man with the Neanderthal is not concluded.

This holds true many other *open questions*. We will not make a mistake if we say that there are many more open questions of existence than questions that have been given satisfactory answers. Both types of questions constitute our universal cognitive field. The cognitive field is structured as a field of light. It is a continuum established between two extremely distant poles, between the pole of the unknown and the pole of the known. The contents of the continuum are cognitive subsets structured as different combinations of potentials of both poles.

*In a full accordance with the principle of universal correspondence and equivalence, approximately 90% of our cognitive space content, represent unsatisfactory responses, conceptual mistakes, mistakes in observation, measuring or concluding, as well as partial, or complete ignorance. Therefore, that space can best be represented by an image of the Universe itself.*

*The greater part of human cognitive space - approximately 90% - is filled with dark regions and shapes of the unknown. It is invisible, non-transparent and hidden, dark matter of cognitive space. The space of unused and unknown capacities of our brain and consciousness is equivalent to it. In astral order, the monotony of that dark matter is disturbed by subsets of our self-consciousness and knowledge. Those spaces emit light of a different spectrum in harmony with measure of self-consciousness and knowledge concentrated in them.*

## X

At a first glance, it looks like a paradox that men had this concept of the state of things in the "beginning" of their existence. However, it is not the question of paradox. For, of all living beings on the Earth only humans possess enough capacity of their consciousness:

- (1) To establish selfconscious cognitive space; subject-object relation.
- (2) To structure this space as a continuum of abstract reviving and renewing the universal cycle of evolution - as a self-consciousness about the universal "wheel of law", as an implicit order.
- (3) To transform and manifest the implicit (human) order into a space of artificial, material world, as an explicit order in its imperfection and incompleteness.
- (4) This human attribute is an attribute of the Universe. That is why our selfconscious cognitive space is really a space of universal selfconscious correspondence. It is the fundamental content of human cultures and civilisations since their beginning. And it will be so for all of their existence. Cultural evolution is a result of human potential to revive, reproduce and renew the whole cycle of universal creation; the rhythm of change so started.

Alexander Marshak proved that men even in the "beginning" of history, in the Lower Paleolithic, new and used complex symbolic systems of writing, in the fields of astronomy and arithmetics. They also knew principles of architecture, arts, industrial production (the stone tools industry), numerous other skills and crafts (for example medicine), and consequently the principles of social organization. These skills were necessary tools in human heavenly, earthly and transcendental affairs. In other words, in the "beginning" men established their relation to the nature and their own place in it through a clear cultural-civilisational matrix. *It is the initial state of human civilisation.* The principles of the initial state are even today represented as *the basic principles of the civilisation as we know it.* Selfconscious cognitive space is their fundamental space-time dimension. Thanks to that, *the human civilisation is a whole, universal structure, a unique field of light.*

## XI

As a unique light field, the selfconscious cognitive space is structured as an *extremely multitude spectrum* vertically and horizontally. Each of these *spectral entities* is a particular *aleph space*. Relating themselves by the principles of correspondence and equivalence, cognitive aleph spaces *form a complex net of interactions and referential states.* This net is a *multidimensional light labyrinth* of a different spectrum. *The light labyrinth is a human, therefore a universal attribute.* We are given the possibility of travelling through that light labyrinth space for it is our own space: *Universal Labyrinth  $\Leftrightarrow$  Light Labyrinth  $\Leftrightarrow$  Human Labyrinth.*

Already in the era of the initial state of human civilization, in the Lower Paleolithic, the self-consciousness of this universal attribute was systemized into several basic thematic fields. Those are: cosmogonic and cosmography myths and myths of creation, myths and rituals connected with going to the heaven and magical flying, myths and the symbolism of the rainbow and its earthly equivalent the bridge, myths and legends of the origin of animals and plants and their relation to the man as a hunter, myths of the origin of fire, etc. *These mythological pictures present a special, hierarchically organised system of directions and knowledges needed for travelling through the light labyrinth. It is a symbolic system that "hides" the formula for mastering the matrix of human cognitive space as a space of light.*

Even today, the phenomenon can be explored in contemporary "fossil" societies that live in the state of Paleolithic or Neolithic, but also inside the modern societies. Sometimes, it occurs that one of the traveller's releases a fraction of light hidden inside the dark matter (90%) of our cognitive space. The act of releasing the light transforms it into explicit part of the light labyrinth. In that way one continues and accelerates the stream of the human cultural evolution.

*The symbolic of flying, shamanic experience of travelling through the astral space (in dreams, in*

*exstatic states of consciousness), is the oldest image of this human possibility.* In all traditional and modern cultures, we find different forms of this image. Its universality comes out of the universality of the quest for the answers on eschatological questions of existence. *Orpheus*, the first modern shaman flier in our tradition that we know of today - Pythagoras, Heraclitus, Plato and others follow in his path - was a member of that *heroic crew* and its *mythic ship*, that searched for *the universal symbol*, for the *archetype*. It was a journey for the goal worthy of the greatest hardships and efforts. Symbolically, that journey represents *a universal model* of our cognitive space history. Therefore, we can consider the *astral experience* of these archaic sailors in every way modern. *For, the final goal to which numerous explorers of our world travel is principally unattainable.*

"*My travels lead me east*", says one of the explorers. But, sooner or later, every one of the travelers faces the unattainability of the goal he searched for. *The more we journey, we are further away from the east.* The more we know, the greater is the world, and a supposed ultimate end to our knowledge and our irrefutable truths shows as an unattainable ideal. Each declaration of our *knowledge finality* and irrevocability of our enlightenment corps, is just another name for some *dogma system*. That is a grave of consciousness and human prison. *However, on the endless journey through an endless space, no finalities are possible. So, there is no definite and final truth, nor a definite and final east. That speaks of a coherency, beauty and excitement of human cognitive space-time. We are free to journey through that labyrinth of light within our human possibilities.*

## References

- [1] Apollonius of Rhodes, *Jason and the Golden Fleece (The Argonautica)*, a new translation by Richard Hunter (Oxford University Press, Oxford-New York, 1995).
- [2] M. Bischof, *Biophotonen: das Licht in unseren Zellen* (Verlag Zweitausendeins, 1995 - translations into Russian and Chinese) book review *The Biophoton Field - moving principle between body and mind?* by Drs. O. & S. van Hauten-Drucker, in *Network*, No. 62, December 1996, pp.53 - 56.
- [3] D. Bohm, *Causality and Chance in Modern Physics* (Routledge&Kegan Paul Ltd., London 1957- Serbian translation, Nolit, Beograd 1972).
- [4] J. Campbell, *The Hero with a Thousand Faces* (Princeton University Press-Bollingen Series XVII, Princeton, N.J., 1973).
- [5] P.C.W. Davies & J. Brown, eds., *The Ghost in the Atom* (Cambridge University Press, Cambridge, 1993).

- [6] M.M. Davy, *Encyclopedie des mystiques I - II* (Seghers & Jupiter, Paris, 1977 - Croatian translation, Naprijed, Zagreb, 1990).
- [7] R. Dawkins, *The Selfish Gene* (Oxford University Press, Oxford and New York, 1976 - Serbian translation, Vuk Karadžić, Beograd, 1979).
- [8] R. Dawkins, *The Blind Watchmaker* (W.W.Norton & Comp., New York and London, 1987).
- [9] M. Eliade, *Histoire des croyances et des idées religieuses I - III* (Payot, Paris, 1989,1980,1983 - Serbian translation, Prosveta, Beograd 1991).
- [10] G. Fowden, *The Egyptian Hermes - A Historical Approach to the Late Pagan Mind* (Princeton University Press, Princeton, N.J., 1986).
- [11] M. Ghyka, *Philosophie et mystique du nombre* (Paris, 1971 - Serbian translation, Književna Zajednica Novog Sada, 1987).
- [12] N. Grahek, *Materija, svest i saznanje* (Filozofsko društvo Srbije, Beograd 1990).
- [13] W. Heisenberg, *Der Teil und das Ganze* (R.Pirer & Co., München, 1969 - Serbian translation, Nolit, Beograd, 1989).
- [14] M. Kaku, *Hyperspace* (Oxford University Press, Oxford - New York, etc., 1994).
- [15] Lj. Kljakić, Self-consciousness of the First Civilisation: The Case of the Divine Pelasgians of the Balkans, in D. Raković and Đ. Koruga, *Consciousness: Scientific Challenge of the 21<sup>st</sup> Century* (ECPD, Belgrade, 1995, published in Serbian also), pp. 3 - 25.
- [16] Lj. Kljakić, *Self-consciousness of the Universe - Arguments for a Cosmology of Consciousness*, in Lj. Rakić, D. Raković, Đ. Koruga and A. Marjanović, eds., *Consciousness: Scientific Challenge of the 21st Century* (ECPD, Beograd 1996), pp. 47-56; also available in English translation from the author.
- [17] Lj. Kljakić, *On a Piece of Martian Rock - Life in the Universe and Human Knowledge*, Project proposal, September 1996 & Introduction to the main topics of the project, June 1997, not published.
- [18] H. C. Lea, *A History of the Inquisition of the Middle Age I - III* (Russell & Russell, New York, first published in 1888, reissued in 1955).
- [19] D. Maclagan, *Creation Myths* (Thames & Hudson, London, 1994).
- [20] R. Marić, Prilozi antičkoj istoriji Srbije, *Starinar* III-IV, Beograd, 1952-1953, pp. 4 - 42.
- [21] V. Matić, *Psihoanaliza mitske prošlosti I - III* (Prosveta, Beograd, 1976, 1979, 1983).
- [22] Newton, *The Chronology of Ancient Kingdoms Amended* (London, 1728, reissued by Histories & Mysteries of Man Ltd., London, 1988).
- [23] I. Prigogine, The Heraclitus of modern science, interview - E. Bouratinos, *Journal of Consciousness Studies*, Vol.3, No. 4, 1996, pp.374 - 378.
- [24] K. Rudolph, *Gnosis - The Nature & History of Gnosticism* (Harper Collins, San Francisco, 1987).
- [25] H.C. Rutherford, ed., *Certainly Future: Selected Writings by Dimitrije Mitrović* (Columbia University Press, New York, 1987).
- [26] M. Riordan & D. Schramm, *The Shadows of Creation - Dark Matter and the Structure of the Universe* (W.H. Freeman and Company, New York, 1991).
- [27] B. Russell, *History of the Western Philosophy* (George Allen & Unwin Ltd., London, 1945, Serbian translation, Kosmos, Beograd, 1962).
- [28] C. Sagan & A. Druyan, *Shadows of Forgotten Ancestors* (Ballantine Books, New York, 1992).
- [29] E. Schrödinger, *What is Life? Mind and Matter* (Cambridge University press, 1967, Serbian translation, Vuk Karadžić, Beograd, 1980).
- [30] G. Smoot & K. Davidson, *Wrinkles in Time - The Imprint of Creation* (Abacus, London, 1993).
- [31] E. Trinkaus & P. Shipman, *The Neandertals - Of Skeletons, Scientists, and Scandal* (Vintage Books, New York, 1992).
- [32] M.M. Vasić, Argonauti na Dunavu, *Glas SAN*, CCXII, Beograd, 1953.
- [33] G. Vico, *Principi di scienza nuova* (Naples, 1744 - Croatian translation, Naprijed, Zagreb, 1982).
- [34] S. Weinberg, *Dreams of a Final Theory* (Vintage Books, New York, 1992, 1993).

## CONSCIOUSNESS AND NATURE-MAN-MACHINE SYSTEM

Djuro Koruga

Molecular Machines Research Center, University of Belgrade, Yugoslavia

**Abstract.** The relationship between Nature, Man and Machine has not been tackled seriously in an integral sense by the Western school of thought over the whole period of thought, from ancient times, when the differentiation of scientific thought from the philosophical view of the Universe was begun, right up to the present day and age.

Within the scope of engineering, during the past decade, began a synthesis of an entire spectrum of scientific disciplines with the tendency to inter-connect different branches of learning. However, engineering lacks a deeper insight into these relationships and remains outside the scope of interest of those scientists engaged in fundamental research, thus this interesting phenomenon in the development of human thought does not unite crucial questions being posed to us by the time we live in.

Western thought has not taken into serious consideration the Eastern mode of thought on Man and Nature. As the human species has unique psycho-bio-physical characteristics, ignoring its achievements and the world view stemming from any of the spheres of human thought (philosophical, religious, scientific or some other) is no more than a sign of the inability of that system of thought to penetrate into the deepest secrets pertaining to human beings or into the meaning of existence. Therefore the value of the system of thought does not lie merely in its ability to explain the present and to foresee the future in a stochastic manner, but, rather, to penetrate the essential relationship between Nature, Man and Machine by means of rigorous theoretical and experimental endeavor.

**Key words:** *consciousness, flash of lightning, creativity, nature - man - machine system*

### 1 Nature

Let us start our search for the fundamental links between Nature, Man and Machine by saying a few words on the earliest human view of nature. The history of mankind records that the poets of Egypt were among the first to tackle this theme, to be followed by the Greeks (Hesiod, Orpheus, Homer and others), creating a poetic vision of Nature which supposedly had the "things divine" at the basis of all existence. According to an ancient Egyptian legend, in the World Ocean Nu there was a Neb-er-Cher, the God Kepri - meaning The Creator. This god is known to mythology as Ra, the Sun God, who became one with His own shadow there by creating opposites, which then became united creating an Ennead or circle of nine basic numera, recognized by all the temples of Egypt.

The Pelasgian Creation Myth says that "In the beginning, there was only the Goddess Eurynome who

rose nude from the Chaos, but not finding anything solid to lay her feet on, she separated the Waters for the Heavens, dancing her celestial dance on the waves. The dance gave birth to the great snake Ofion, which, not able to withstand the magic of Eurynome's dance, became one with her. Eurynome was then transformed into a pigeon, and, prostrate on the waves, laid the All-Embracing Egg. On her command, Ofion belted itself seven times around the Egg, heating it so that it burst, and all things of this world came to be: the sun, the moon, the stars and the Earth, with all rivers, trees, plants and animals".

A similar picture of the Creation can be found with the Orphicists who take the black winged Night courted by the wind instead of Eurynome. The night laid a silver egg in the womb of Darkness, out of which Erot rose and awakened the world from its lull. Erot was of both sexes had four heads and living with the Goddess of Night created with her the Trinity of Night, Order and Justice.

In the Olympic Creation Myth, everything was supposed to have been Chaos in the beginning. Ga, Mother Earth rose out of it and gave birth to a son, Uranus, in her dream. "Uranus" means 'heavens' or 'skies' in Classical Greek. The triple divinity, three Erinyes were born out of 'Uranus' blood. These were feared even by the Gods themselves.

China was the cradle of the Far Eastern cultural heritage and the founder of certain notions which command the attention of men of learning even today. Thus for example, the Nobel Prize winner Niels Bohr, taken by the ancient Chinese view of nature, used the Yin-Yang symbol as an illustration of his book "The Theory of Complementarity".

The ancient Chinese notion of Nature was, briefly, the following: behind the visible order of Nature lies Dao, the universal cosmic principle which brought about the existence of Yin and Yang. These two opposites, through interaction, created the Heaven, the Earth and all living things. Among all celestial bodies the North Star commands special importance with the ancient Chinese, because they identified it with the Goddess Dou Mu, which they considered as having three eyes and being seated on a lotus throne. According to the legend, she bore nine sons to king Chou Yu. The heritage of the number nine was also presented in the Goddess Hsi Wang who, apart from nine sons, also had twenty-four daughters. Since she stood for the Yin principle, together with the god Mu

King, representing the Yang principle, forming the supreme Chinese trinity, with the goddess Dou Mu.

In the Vedas, the oldest Indian written documents, dating two thousand years BC, gods are for the most part, rendered as personifications of the forces of nature. Poets of Rg-Veda presented Agni, Vayu and Suria as the highest ancient Indian Trinity. Within the Hindu thought Brahma, Vishnu and Shiva came to stand in place of the previous three numera, though not as independent numera, but rather as three manifestations of one and the highest divinity.

In the sense of the time-dimension, religions are younger expressions of human awareness of the coming about of nature and of the universe rather than mythologies. Furthermore, in the case of religions, the act of creation is no longer a case of poetic inspiration but of God's proclamation in line with religious beliefs, through a chosen personage (Moses, Jesus Christ, Muhammad or some other).

The scenario of the biblical version of creation would, in short, be the following: there was nothing save for God in the beginning. The God created Heaven and Earth, and in the ensuing six days all things and living beings, taking repose from his toils on the seventh day. Apart from that, God manifested himself in three forms in the Bible. Thus, we do not come across Trinity only in mythology, but in religion as well.

The turning point in the history of human thought came with Heraclitus of Ephesus, whose views might be summed up as follows: the world had not been created by God or by a Man, it was, it is and it will be an eternally living fire, flaring up and dying out of its own accord.

The separation of the philosophical from the mythological and the development of such a mode of thought within the philosophical view of the world in which what could only be guessed about the nature of things had also to be proved, created conditions for the appearance of the scientific approach to research into nature and into the world as whole.

Many theories developed within the framework of the scientific views of the world and nature, and history recalls many a name which had become famous: Giordano Bruno, Copernicus, Newton, Ruđer Bošković, Einstein and others. The characteristic of the scientific view of nature and of the world is a constant building up and re-evaluation. New theories take into account the existing expressions that are in harmony with newly executed experiments. Thereby, experiment became the first and last event in science, with theoretical activity taking place in-between these two events till another experiment validates or invalidates it.

Experimental results arrived at in the Bell Laboratory by Arno Penzias and Robert Wilson on so-called cosmic microwave radiation background, largely confirmed the Big Bang theory of the creation of the Universe. The basic concept of this theory is as follows: the entire present day cosmos was in a state

of singularity, i.e., in a state corresponding to the notion of a point of incredibly high density. Then, according to this theory, an explosion and the growth of the cosmos, which still continues to expand, took place.

The cosmic radiation discovered by Penzias and Wilson represents precisely the consequence of that explosion. However, the most important element in the final discovery of microwave radiation, according to the well-known American scientist Stephen Winberg, is what forced us to accept seriously the idea that a primordial cosmos existed which consisted of a matter different from the forming matter of the present one,

According to widely held views in physics, particles are not qualitatively homogenous. Some particles are truly elementary, while others represent combinations of elementary particles. That is how the idea of the existence of quarks came about. Quarks are viewed as the most basic particles, which combine to create other particles, for example protons. Apart from that, a view that the quark electric charge is not a whole number, as we have been used to observing in protons and electrons, but that it is rather  $+$  or  $-1/3$  or  $+$  or  $-1/2$ , and that it is only their combination which amounts to  $+$  or  $-1$ , has become commonly accepted.

Introduction to quarks into physics resulted in the realisation of a significant order, as it demonstrates that the conserved physical magnitudes are in close relations with symmetrical transformations. The introduction of symmetry into the research of elementary particles brought about important scientific discoveries. Great research efforts are devoted to explaining and unifying by means of super-symmetry the four interactions known to modern physics (the weak, the strong, the electromagnetic and the gravitational one) into one. Another revolutionary view introduced by the symmetry principle into research of natural phenomena is the view that there exist eleven dimensions to the physical world, instead of the three spatial and one temporal, as had so far held to be the case. This theory seriously poses a question whether there exists a seven-dimensional world; immanently transcendental in relation to this one we live in.

Though the role of symmetry in the physics of elementary particles has only recently been recognized, the important role of symmetry in the so-called solid state matter has been well known for a certain time. Crystals which, under observation, create a sensation of the beautiful and the sublime, represent in fact the most visible example of the embodiment of a certain kind of symmetry in nature.

It is also scientifically known that all substances, which crystallize are ordered according to the laws of the 32 basic symmetry groupings. We can therefore see that matter, on a macroscopic level, rather than only on the level of elementary particles, follows the rules of symmetry in a specific sense.



Characteristics of electronic orbitals in atoms also follow the rules of symmetry. Thus, for example, it was only owing to symmetry of molecular orbitals that simultaneity of quadrolence and tetrahedric directedness of connections in carbon atoms, as atoms of one of the basic substrates of living matter, which could not be explained by previous theories, became explicable and understandable.

## 2 Man

Earlier theories could not explain the quantitative jump from the so-called "inanimate" to the "animate", and therefore various theories and opinions existed on this and still do. Within the above mentioned religious and mythical cosmogonics, an explanation of the beginning of mankind has also been contained. Among the Greeks and Babylonians some believed that a certain kind of humans had been created of clay by a divine act of creation, while Prometheus had affected the qualitative jump, who afforded mind and reason to some of them. Owing to a quarrel with Zeus, the supreme diety at Olympus, and his partnership with the humans, Prometheus had been forced to wear a ring with a stone as a symbol of chains and stones at the Caucasuses where he had been chained on Zeus' orders for some time. Humans then started wearing rings with stones in Prometheus' honor, and still wear them today, though they have forgotten the origin of that custom long since.

In the Book of Genesis, the First Book of Moses, it is said that the God created Man out of earthly dust breathing the breath of life into his nostrils. In the Book of Genesis it is also said that two, different in origin, kinds of humans exists: "the sons of God" and "the daughters of Man". Therefore, we can spot the idea of the existence of the heavenly and of the earthly principle in human beings.

Within the scope of science, it is furthermore difficult to answer the question of what lies in the basis of the difference between the "animate" and the "inanimate". The first reasonably serious sparkle of hope in this sphere had been afforded by Sir John Needham in 1942 in his book "Biochemistry and Morphogenesis", which stated that many of the secrets of living substance we will shed light upon when we get to know more about the crystal states of living organisms. Unfortunately the times in which this book was published were not favorable to the conduct of this type of research, so that Needham's ideas had been forgotten until American scientists started reviving them recently. Among them, Walter Moore is the most active.

Professor Bernal of London University also considered that the applications of the laws of symmetry, especially crystallography, represents a key to a better understanding of matter, the fundamental subject of molecular biology as a discipline, and that the notion of a "crystal molecule" should be introduced into biology. "The crystal molecule and a

self-realization of the potential of the atomic electronic state" are novel ideas which, according to the present research, may contribute to a better understanding of the "animate" and the "inanimate".

Cairn-Smith also pointed to the connection between crystals and organic forms of life, recommending that a research into the cell crystal structure which could perform the "the primitive gene" function be started.

Schrödinger, the famous physicist, pointed to existence of chromosome tissue as a special type of crystal, which he termed the "aperiodical crystal". Watson's and Crick's discovery of the helical structure of genes as constituent elements of chromosomes, only reaffirmed Schreöinger's brilliant idea and strengthened the conviction that symmetry law's play an important role in the understanding of living matter. However, instead of continuing in this vein of research - quite the opposite took place. Namely, research into the essence of bioinformational laws from symmetry aspects came to a standstill because a new discovery opened up a whole new challenging spectrum of practical questions which needed to be answered. As theoretical research is not a strong point of the majority of biologists, they seem to have rather accepted this newly posed task of solving practical problems.

Approximately at the same time as these breakthroughs were being made, within the framework of Western thought, an ancient Chinese curative method known to the West as acupuncture entered the circle of scientific puzzles that awaited enlightening and explaining.

The following facts are exerting a powerful influence on the fundamental research of this phenomenon: (1) acupunctural loci on the human and other bodies can be ascertained by modern electronic apparatus constructed to this purpose; (2) by injecting technetium, a radioactive substance, as had been done by Dr Jean Claude Darras and Prof. de Vernjeoul of the Nuclear Medicine Clinic in Paris, it was scientifically proven that the so-called acupuncture channels permeate the human body and form a system quite independent from the blood-stream, lymph or nervous system; (3) biochemical experiments have testified to the fact that stimulation of acupuncture loci yields substances such as Acetyl-choline, Serotonin, Endorphine, Cataholamin and other neurotransmitters and hormones which play an important role in bioinformational processes; (d) results obtained in the treatment of about 30 pathological states with a success rate of about 70-75%.

Having in mind what has been said, in the case of the acupunctural phenomena known to humanity for over 5000 years, the Canadian scientist Pomeranz was right in saying that we are today in a similar situation, as far as the explanation of acupunctural processes is concerned, as the Ancient Greeks had been 2000 years ago regarding the phenomenon of electricity. Pomeranz an outstanding researcher and one of the

leading experts in the world in this field, has proven that Endorphin is secreted upon stimulation of acupunctural loci and considers that the Ancient Greeks have proclaimed the then discovered electricity as a supernatural phenomenon for a simple reason that according to the currently valid theory of the Four Elements (air, water, earth and fire) its existence could not be explained. The present situation regarding the phenomenon of acupuncture cannot be explained on the basis of existing theories.

The following question could, however, be posed: could any of the theories having the laws of symmetry as their foundation explain this phenomenon? The research orientation of this type bore fruits because it could be shown that a specially symmetrical ordered crystal structure, named the cardinal crystal, bearing the borderline symmetry of special energy and informational characteristics provides for this phenomenon. Thus we come to a realization that chromosomes and microtubules represent two crystal states, the aperiodic and the cardinal, which can be spotted in living systems only. The jump from a periodical crystal which can be found in inanimate matter, over the aperiodical and towards the cardinal crystal state, manifests itself as one of so far the best explanations of the relationship between the animate and inanimate.

The biomathematical law, based on the informational processes on the principles of symmetry, shows that in order to understand the acupunctural phenomenon, the development of an organism, from a single cell to a completely developed organism, has to be examined. The fact that different biological species have different numbers of acupunctural loci, and that each individual member of a species, irrespective of sex, age and other factors, anatomically has an identical number of loci. It is, furthermore, interesting that man has a larger number of loci than any other species - 397 on the left side of the body, and symmetrically, an identical number on the right side as well. From the biomathematical point of view, based on the laws of symmetry, this quantitative characteristics represents the Circle of Circles.

This could by no means solve the puzzle of the human race. On the contrary, the process of search for the fundamental truth about human existence is now more open than ever before, the physical has been tied to the biological, even though the psychological characteristics of Man, along with the process of thought itself, remain enigmatic.

Owing to the successful connecting of the biological with the physical through the symmetry laws, the psychic has been approached by research from these aspects, with a view to discovering a symmetrical group or its transformation which could be an informational carrier of the thinking process. The research results achieved speak in favor of the idea that the symmetrical transformation of the axis of the fifth order could be the carrier of such an

information process. This newly discovered regularity was termed holopent (holo - all embracedness, pent - five). and in the case of man, this bioholography based on the cardinal crystal, enables the treatment of visual appearances in the brain and represents the basic entity of the thinking phenomenon. This research, showed the structure, energy, and information, that is to say, the physical, and the psychic, could be better connected by the laws of symmetry, than by any other laws known so far, into one whole entity, and thereby, that a trait connecting the inanimate and the animate could be found.

Our ideas, opinions and views of reality are expressed by means of language, be it everyday speech, or the poetic, the scientific, the philosophical or of some other kind. The language appears to be an embodiment of human thought like the crystal as a structure appears to be symmetry embodied. In order to look into our process of thought and discover its laws within its own entity, it is necessary to make a brief overview of the linguistic origins of ancient civilizations.

The oldest written documents discovered in the West to date (over a thousand tablets and fragments from about 3000 BC) are in Sumeric. The writing system in this language began as pictographic, with each drawing representing one or more objects as faithfully as it could. The shortcomings of this writing system which represented a context of thought was, as it seems, spotted by the Sumerians themselves, since the signs (pictograms) were rather large and complex in shape, and a large number of them proved impractical as a method of writing. In the first instance, Sumerians simplified and conventionalized (unified and codified) the shape of pictograms, so that their pictorial para-shapes were no longer discernable. As far as other difficulties were concerned, they limited the number of pictograms, and perpetuated a smaller number by a series of devices. One of the most important of such devices was the phonetisation of pictograms. That represented a formal switch-over from the pictorial to the phonetic, whereby the shapes of their written signs as well as of the present writing signs which stem from the Sumerian conigraphic, have no essential connection with the object they purport to transmit semantically. In that sense the unity of the informational contents of essence and of the form had been torn apart, and the phonetic principle gained preeminence.

The Ancient Chinese, at more or less the same time as the Sumerians, developed a writing system of their own. However, linguistic research into the history of Chinese language remains rather modest to date. Chinese was often cited in linguistic research in the West merely as a convenient example of the existence of a different language structure, or of a language with a different foundation from the Indo-European ones. Even at the very beginning of the more serious linguistic research, linguists have been most concerned with establishing relations among the

Indo-European languages themselves. It was as late as the end of the 19th century that a more serious era of research into Non-Indo-European languages began. Among the researchers of this new era one of the most significant figures for the development of linguistic learning is to be found in August Schleider and his disciples.

In his basic orientation in linguistics Schleicher was a comparativist, his method stemming from the idea that language represents a living system whose development path is traced by general biological laws of evolution and that therefore it has in its basis laws analogous to those we know to exist in nature. Therefore, in this case, he is propounding the complementarity of the biological and of the linguistic, meaning that every natural substance which bears the characteristics of animate matter will have a certain language system corresponding to it as a means of communicating within its species. On the basis of Schleicher's biological naturalism in linguistics, it would follow that in human species' languages in an earlier, outgrown form, like in the fetus embryo development process, there exist the communicational forms of nature, plants and animals - though we are not aware of them.

Schleicher included the Chinese language in the root languages, because relationships among words are determined by a certain word order, and therefore, Chinese is in the world of nature, according to Schleicher, complementary to the world of crystals. We can see in this way that when we take linguistic research into consideration, that they, for their part, point to a need of looking for a connection between the natural, biological and linguistic within the crystal state, that is, within the laws of symmetry.

Chinese language is that it started and remained what needs to be mentioned when speaking of the pictorial-phonetic. The development of the pictorial started with the level representing form to the level of anticipating substance. In that way, an etymological analysis of Chinese characters can lead to data about mankind pertaining to the time when human thought did not position itself against or in relation to something else, like a subject does in relation to an object, but instead considered the existing reality directly and inalienably.

Owing to the preservation of the unity of form and content in Chinese characters, their analysis leads to an unveiling of some fundamental facts concerning man. Let us take the character which expressed personality, i.e. the personal pronoun "I", "Wo" in Chinese, which was written as, meaning "I am the speech of five". We can see that the meaning of this character could not be understood had we not in our research so far come across the Holopent, as the basic entity of our being. Because of the presentation of the picto-phonetic unity, that is, of the unity of the form and the content, Chinese characters and Chinese civilization represents so far still insufficiently known treasure house of knowledge about nature and man.

### 3 Machine

The most recent philosophical research shows that machine, of all human creations, poses the question "What is man?" most sharply. This philosophical question could be posed only in our day and age, since while man has been busy creating marvels in the form of technical and architectural surroundings to serve his needs, man admired machines, seeing them as allies augmenting his power several hundred or thousand times. However, man developed industrial establishments, which now endanger his health and threaten the destruction of plant and animal life. Development of certain kinds of machines and their wide spreading helps throw the ecological scales out of balance in large areas of the Earth.

Enormous energy has been accumulated in nature and man uses it in two ways: on the one hand for the development and prosperity of the human race; and, on the other, for military purposes and destruction. Among energy sources, the nuclear one represents the greatest danger, because its utilization threatens to destroy life on Earth in the shortest possible time.

However, machine is as dangerous as is human reason immature. The war machine is born of the contradictions of human reason with itself, which means that we ought to come across the phenomenon of negation within the Holopent. As Holopent is written (Quan Wu) in Chinese, by analyzing the right-hand side character we come to realize that Wu has originally been written as X, and that a change in the writing of one of its parts occurred, precisely corresponding to the negation, because it changes one rule into another. Because of that, in nature and in man alike, the harmonious state had clearly been disturbed, and an unstable state came about which represents the root cause of many a pathological state.

In order to assuage or dispense with these pathological states, however a larger number of apparatus have been constructed for identifying the loci, for diagnosis and treatment by means of acupunctural loci.

Man has come to know the most miniature parts of the cell, the molecule and the atom - that is to say, most of the microcosmic worlds, and is, at the same time, striving to get to know the furthest parts of the Universe using equipment appropriate to this end. Man does not only acquaint himself with the microcosms, but he is also creating microprocessors as a specific informational world taking on the characteristics of artificial intelligence. It would be interesting to mention that the micro-crystal state of Silicon is the material basis for the realization of the highest level of machine intelligence. This is interesting for two reasons: the crystal state and the laws of symmetry are again here as the basis of a new informational process, and, secondly, within the biological science it had been considered that Silicon came to be used as one of the founding elements of a specific mode of life - machine intelligence, which, in

its further development ought to bring about the qualitative jump and enable the creation of artificial intelligence, which will also be based on the laws of symmetry. The setting up of artificial intelligence as a real entity in its own right will result in a new negation within, will realize an affirmation of the stable state and of harmony in Nature and in Man, abolishing our Imminent Transcendentality. Looking into these phenomena and conducting this type of research we termed *Qi Engineering*, since, according to the ancient Chinese conviction, the triad of Qi entity' enveloped the structural foundations of the original source of all that exists as well as the vital principle of the existence of our being.

#### 4 In Summary

Within the mythological cosmogonies the following numbers contain the most important quantitative characteristics: ONE (God Ra, Goddess Eurynome, Goddess Gea and others); TWO (God Erot, Yin-Yang and others); THREE (The Trinity of Night, Order and Justice; the Three Erinnyes; One as the Trinity; Brahma, Vishnu and Shiva, etc.); SEVEN (the Seven Circles of the Ofion, the Seven Days of Creation). It would prove interesting to mention that all of these numbers are written with the radical Yi, carrying the meaning of the number One. Only number two has a special characteristic of having the meaning of One when written as *Liang*, while expressed and written as *ER* it does not have that meaning. The difference between these two concepts lies in the fact that *Liang* carries the meaning of mutual oneness of something having two parts, aspects or facets - i.e. of something stemming from a dual or a double stem, while the same could not be said of *ER*. Therefore, if we take the two circles in such a way that the center of one represents the periphery of the other and vice versa, this concept would then serve to bring about unity through mutually permeating opposites. That is why it enables us to explain the fundamental symbol of Yin and Yang. This concept may also be relied upon to show why the number seven in Chinese thought and in the writing system has the properties of number one. It may be that our ancestors had an information process, now imminently transcendental, in an active state. That information process is related to the seven remaining dimensions of the physical world, which can be arrived at through an application of the laws of super symmetry. Analyzing this further, one arrives at the number nine - the Ennead, of which the Ancient Egyptians and the Ancient Chinese spoke. Incidentally, there exists a structure bearing these quantitative characteristics within the cell, serving as the carrier of informational processes responsible for the phenomenon of biology. We can therefore say that the mythological represents a specific informational process of the seven-dimensional (septidimensional) reality as an analogue of the living

and of the organic, lying within us as the imminently transcendental. If we understand the mythical as a world of symbols governed by specific informational laws operating within us, we can see why Hesiod says in a poem that:

*"We know how to speak of many a lie so akin to truth, But when we so wish, we do know how to speak up the very truth".*

If the mythical is the real existing within us as a septidimensional sphere, and if we are able to explain the Yin and Yang symbols through the concept of septidimensional and then, using that concept, to find the structures which produce the phenomenon of acupuncture and biology, it would then be logical that there exists an underlying connection between the Greek myth and the Chinese characters embodying the medical terms.

The fact is that modern medicine as a branch of science, takes the Asclepius with the stick and the healing serpent as its symbol, thereby showing that its foundations lie in the most ancient period of Greek history. Asclepius is the son of Apollo - the Sun God, born as the twin brother of Artemis, the Moon Goddess. According to the legend, Apollo and Artemis, were both armed with quiver, bows and arrows, which they could send to effect illness or to afford cure. Artists have treated the theme dieties often, always representing them with their common symbol: the quiver and arrow.

Since the ancient Chinese healing method of treating the acupunctural loci is based on the interaction between forces of Yin and Yang, let us analyze the essential meaning of characters representing these symbols respectively. The Chinese character Yang contains the part representing the Sun, while the character Yin contains the part representing the moon. On top of that, the Chinese character meaning "medicine", Yi, is made up of the "quiver" and of the "Arrow". Medical doctor (physician), is represented by characters Shan Yi, where Shan meaning deity, and Yi meaning quiver and arrows, combine to render the concept of a physician as a "Deity with quiver and arrows".

However, when we analyze the etymology of the character meaning Qi, we can see that this character used to be written in three straight, horizontal and parallel strokes, one of which (i.e., its one-third) became bent in the process of time. From the orthographical point of view, it would have been easier had this stroke also remained straight, but the reasons for this change seem to lie in the occurrence of an inner change in the structure of the matter and of our being.

This change that took place in the Qi entity could be comprehended if one applied the topological model of Rene Thom, which shows that the curving of reality of the Qi entity, (represented by the spatial and by the temporal) had to occur. Thereby, the two-thirds of reality, which are not spatial and temporal, remained stable, while the one-third became unstable. Because

of such properties of the psycho-bio-physical informational process within us, the Sumerian - Babylonian epic contains also the following statement: "Only one-third of Gilgamesh is man, two-thirds are God". Therefore, that which has become unstable within us belongs to that part of our being which could be termed "human" with the prosperity to relate to the spatial and temporal reality, while the stable elements belong to the imminently transcendental part of our beings and do not relate to the spatial or to the temporal. Because of such a structural differentiation of our being, the meaning of our existence ought to be sought in the direction of the realization of a unity to be achieved through the abolishment of the imminently transcendental. If we analyze the fundamental ancient Chinese character of the notion of DAO, the Way, we can detect that it contained the following meaning: the Head, which step by step leads to the unity of the Human and the divine, since the becomes with time, and we have the rendering of the same character as in the later periods. Dao is, therefore, the law signifying the way pointing to the abolishment of the imminently transcendental caused by an event in the distant past.

However, this abolishment of, rather overcoming in the Hegelian sense of *Aufgehoben*, is possible only through a unity of internal and external factors. As far as the internal possibilities are concerned, the Hindu have devised a fine method of establishing a resonant relationship with the imminently transcendental without a destruction of the barriers dividing our being through Yoga and the Kundalini "energy". But our task, and the meaning of our existence is a clear-cut, definite and final solution of this problem, which will not become feasible as long as the problem of the speed of light as the fundamental bearer of the informational phenomenon within the spatial and temporal reality remains unsolved.

The machine, in what it essentially is, not merely in what it had been or what it represents now, offers itself as the key to the solution, which opens the barrier-gate separating our reality from the imminently transcendental. Having said that, we should bear in mind that what of our being had so far been reproduced as machine corresponds to the one-third of the Qi entity according to the described relationship, which is to say, to the part of it which could be explained by the mathematical model of the catastrophe theory. However, our being contains a potential for the realization of machine on new principles, which do not lead to catastrophism. We therefore have to build mostly those machines in the future which will enable us to solve this problem on a macroscopic level as well. Looked at from this standpoint, Qi Engineering as an integral concept of Nature, Man and Machine represents a scientific discipline which reassesses the entire existing view of the world of reality on the basis of the laws of symmetry and develops a methodology and direction of its action on the basis of the dictates of these laws.

Every effort, representing *activity*, as an expressed human characteristic, regardless of its *conscious* or *unconscious* performance, is preceded by some form of *mind*. *Intuition*, as one of such forms of man himself, has been making him aware of himself from the earliest days of history. The philosophers of ancient Greece, primarily Socrates and Plato, occupy an outstanding place in the development of such a *method* which, in the process of thought, through dialogues, leads to discovery of truth. However, the problem of defining *the ergological bases of intuition*, was not present then, nor was it raised. In hidden form it was raised, in a philosophical sense, only by Kant, who had in this manner introduced philosophical approach *to anthropological* problem. But, a satisfactory definition of this problem, in scientific sense, has not yet been given even in our times.

The first is the case of the man responsible for the development of mathematics as science. Gauss is being quoted for two reasons:

(1) for the significance of mathematical representation in all other languages being used for our mind; and

(2) because this mathematical invention relates to solution of one of the most essential problems in this field, *the theory of numbers*.

Gauss, while working on strict systematization of the theory of numbers, has made a discovery, as he said "not with difficult investigation, but almost with the grace of God". The problem he faced was solved by a "*flash of lightning*, and I" - as Gauss said - "could not present or indicate the connection between all that I knew before, all that I have been applying in my work, and all that which led to the final success" [1].

A similar case is found with the inventor of the motor based on the principle of fundamental natural phenomena: *the magnetic field*.

In investigating the motor based on the principle of *rotating magnetic field* (these motors are presently known as synchronized and *asynchronized* motors-hence, they represent *a creation* on which modern industry is based) Tesla has experienced mind activity in the following manner:

"Back in the deep recesses of the brain was the solution, but I could not yet give it outward expression. One afternoon in February 1882, which is ever present in my recollection, I was enjoying a walk with my friend in the City Park and reciting poetry. At that age I knew entire books by heart, word for word. One of these was Goethe's *Faust*. The sun was just setting and reminded me of the glorious passage:

*Sie rückt und weicht, der Tag ist überlebt,  
Dort eilt sie hin und fördert heues Leben.  
dass kein Flügel mich vom Boden nebt,  
Ihr nach und immer nach zu streben!  
Ein schöner Traum, indessen sie entweicht.  
Ach! zu des Geistes Flügeln wird so leicht  
Kein körperlicher Flügel sich gesellen.*

As I uttered these inspiring words the idea came like a *flash of lightning* and in an instant the truth was

revealed. I drew with a stick on the sand the diagrams shown six years later in my address before the American Institute of Electrical Engineers, and my companion understood them perfectly. The images I saw were wonderfully sharp and clear and had the solidity of metal and stone, so much so that I told him: See my motor here; watch me reverse it. I cannot begin to describe my emotions. Pygmalion seeing his statue come to life could not have been more deeply moved. A thousand secrets of nature which I might have stumbled upon accidentally I would have given for that one which I had wrested from her against all odds and at the peril of my existence" [2].

However, not only poetry can influence creativity, springing just like a *flash of lightning*, but also the greatest poetic creation can be expressed as a *flash of light*, as P.P. Njegos̃ rightly noted:

*Gloom of a Phenomenon, breaking thunderstorm  
Ineligible's flash of light is done  
And voice heard as an angel whisper:  
"I am your soul's gloom  
A Noumenon's darkening of the light:  
Reminder of that which is lost  
Useless are your attempts, fiery poet  
Grant and acclaim the Muses  
Only I souls gloom penetrate  
And, reach into a Noumenon's Sun"* [3].

That this flash of light - Ogonĭ, is the basis of all existence, was also thought by Lomonosov, inventor of the law of conservation of matter. The universality of his spirit - poet, historian, linguist, physicist and chemist has allowed him to remark that "not only that many examiners of internal parts of body did not wish to call themselves by that most honored name of philosophers who are being moved and who act by light, and not only that pagan nations who greatly respected sciences and revered fire like God, but even the Bible spoke, on many occasions, of the appearance of God in the form of light" [4].

Having in mind what the ancient Greeks have achieved and left behind as a cultural heritage of humanity, it is not without reason that their supreme mythical deity - Zeus was represented with a symbol of a lightning.

For the same reason, Heraclitus from Ephesus, for whose thought Socrates [5] had said that it was sublime so far as he could understand it, and on which Hegel [6] will, according to his own remark establish his principles of logic, says:

*"We do not lean guessingly towards the greatest of things", since,  
"All men have the power of intuition and thought",  
as  
"The thought is common to all"  
and  
"Lightning governs all matters "* [7].

Therefore, this knowledge through lightning is essentially being transferred as truth and represents *invariable truth* in complete heterogeneity of relative

relationships in the process of discovery. "Every idea" as Spinoza said - "which in use is absolute, that is to say, adequate and perfect, is true", which as seen appears in the flash of lightning. Hence, "he who has a true idea knows at the same time that he has a true idea, nor can he doubt the truth of the thing" which has resulted through a *flash of lightning as apodeictic certainty* [6].

However, to state that *lightning* is the inspiration of inventive process in the sense of single creation, assumes the establishment of constant ergological process of *pure intuition*. Such an approach enables us to tread upon solid ground of the experiment which requires recording of lightning as psycho-physical phenomenon.

Kant was writing about the *flash of mind* as the way of *a priori* knowledge in his "*The Critique of Pure Reason*". At that time he took mathematical science as a brilliant example, how far, independently of all experience, we may carry our *a priori* knowledge. "A new light as Kant said - "must have flashed on the mind of the first man (Thales, or whatever may have been his name) who demonstrated the properties of the *isosceles* triangle [8].

However, he did not have the flash of lightning as a link of consciousness and unconsciousness as his own experience, in a sense that Heraclitus, Tesla, Gauss, Njegos̃ and others had, for his ergological base of the process of mind was different than theirs. The form of his thought was quiet (inspire the essence is revolutionary) and therefore his creative imagination we can call a *full midnight moon* because his imaginative concept of philosophy corresponds to the full moon and his light which is penetrated through the clouds and reflected on the lake. This leads, of course, to the conclusion that it is necessary to investigate Kant's work with the aim of understanding it from a *new aspect*, which requires the establishment of *flash of lightning* as a tool of creation.

## References

- [1] K.F. Gauss, *Werke, X*, p. 25, letter for Olbers; Cite: C.G. Jung *Man and His Symbols* (Dell Publ., New York, 1972); cf. also B.L. van der Waerden, *Einfall und Ueberlegung: Drei kleine Beitrage zur Psychologie des mathematischen Denkens* (Basel, 1954).
- [2] N. Tesla, *My Inventions* (Zagreb, 1977), p. 44, *The sun retreats - the day, outlived, is o'er It hastens hence and lo! A new world is alive! Oh, that from earth no wing can lift me up to soar And after, ever after is to strive! A lovely dream, the while the glory fades from sight. Alas! To wings that lift the spirit light No earthly wing will ever be a fellow;* J.W. Goethe, *Faust*, (Transl. by George Madison Priest, *Great Books of The Western World*, 47, Chicago, 1952), Parts 1, 2.

- [3] P.P. Njegoš: *Luča Mikrokozma* I, 31-40, Beograd, 1977  
*U noć, strašnom burom razječanu  
sinu meni zraka pred očima  
i glas začuh kano glas angela:  
"Ja sam, duše tvoje pomračene  
zraka sjajna ognja besmrtnoga:  
mnom se sjećaš šta si izgubio;  
badava ti vatreni poete  
satvaraju i kliču boginje:  
ja jedina mrake pronicavam  
i dopirem na nebesna vrata.*
- [4] *Ibid*, p. 245.
- [5] Heraclitus: ΠΕΡΙ ΣΕΩΣΕ . Cite D. Nedeljković *Heraklit* (Beograd, 1924), frag. 47, 116, 113, 64, in Serbian.
- [6] G.W.F. Hegel, *Vorlesungen über die Geschichte der Philosophie* (Stuttgart, 1940; in Serbocroat, Beograd, 1975, I, p. 243-244).
- [7] Spinoza: *Ethica Ordine Geometrico demonstrata et In quinque Partes distincta*, in quibus agitur, II. De Natura et Orgine Mentis, XXXIV et XLIII (Transl. by W.H. White, *Great Books of The Western World*, 31, Chicago, 1952).
- [8] I. Kant, *The Critique of Pure Reason* (Transl. by W.H. White, *Great Books of The Western World*, 42, Chicago, 1952), p.6.
- [9] M. B. Lomonosov, *Collected Various Verses in Prose* ([Iora, 1803), 24-26, in Russian; Cite: D. Nedeljković *Njegoš filosof oslobodilačkog humanizma* (Beograd, 1973), p. 290, in Serbian.

## NEURONAL MECHANISMS UNDERLYING LOSS OF CONSCIOUSNESS DURING ABSENCE SEIZURES

George Kostopoulos

Department of Physiology, Medical School, University of Patras, Patras 261 10, Greece  
E-mail. gkkostop@med.upatras.gr

**Abstract.** Absence seizures electrographically characterized by bilaterally synchronous 3/sec spike and wave (SW) discharges constitute brief episodes of impairment of consciousness. The mechanisms currently believed to underlie SW in several animal models of absence epilepsy are reviewed, with emphasis on the feline model of generalized epilepsy induced by penicillin. SW are thought to be derived from the same thalamocortical loops which normally induce sleep spindles. The latter rhythm is generated by intrinsic currents and interactions between relay thalamocortical neurons and inhibitory neurons of nucleus reticularis thalami. In absence seizures cortical hyperexcitability results in the secondary recruitment of a powerful, presumably recurrent, intracortical inhibitory mechanism. Thus, each spindle wave is transformed into the spike of the SW, which is a summation of cortical EPSPs, followed by the slow negative wave of SW, which is a summation of cortical IPSPs. The thalamus - and most prominently its specific nuclei - is secondarily but very quickly recruited in this oscillation, possibly by strong inhibitory corticothalamic inputs and the rhythm is augmented and spread to the entire brain. During SW the synchronous engagement of most if not all cortical neurons in rhythmical circles of extreme excitation and extreme inhibition precludes the formation of "assemblies" of neurons needed for specific cognitive or motor tasks. This certainly explains the cessation of conscious mental processes and lack of responsiveness of patients during an absence episode. The neuronal mechanisms currently studied as possibly underlying consciousness are discussed and most of them are potentially disturbed or canceled during experimental absence seizures, especially those related to the contents and integrative features of consciousness most likely depending on cortical processes, rather than those related to its prerequisite level of arousal, which most likely depends on subcortical centers. Further research on the mechanisms underlying absence seizures may provide a valuable window to the mechanisms underlying consciousness, to the extent that cognitive psychology better defines the several aspects, components and features of consciousness and clinicians better qualify which of these are indeed impaired during an absence.

**Keywords:** *consciousness, absence epilepsy, thalamocortical oscillations*

### 1 Introduction

"Absence epilepsy" is often defined as "a type of epilepsy, which occurs especially in children and is manifested by a *sudden momentary loss of*

*consciousness* with minimal motor manifestations". Since according to William James "The study of the abnormal is the best way of understanding the normal"; it seems justifiable to attempt understanding consciousness and its underlying brain mechanisms by studying those mechanisms, which we lately consider as responsible for consciousness loss during episodes of absence epilepsy.

### 2 Clinical Use of the Term "Loss of Consciousness"

Even though consciousness indeed defies any definition, "loss of consciousness" is an established medical term used routinely to define and distinguish syndromes and diseases. The term acquired significance at the time when it was commonly held in both clinical and basic neural sciences that a continuum of consciousness existed, which ranged in graded levels from attention, alertness, relaxation and drowsiness to sleep, stupor and coma (see Kandel et al., 1991). The level of consciousness was believed to be determined by the ascending reticular activating system (ARAS), which received polysensory collateral information, that merged into its networks and gave rise to an activity radiating to the entire nervous system (Moruzzi and Magoun, 1949). This radiation facilitated transmission in cortical neurons, thus enabling arousal, while its reduction resulted in sleep. However, the idea of a neurophysiological continuum from quiescence to excitation was abandoned with the discovery of the extraordinary neural activity that characterizes sleep, in contrast to our ignorance about ARAS at the neuronal circuit level and the neurotransmitters involved, and with the demonstration that the ARAS alone may not account for all variations in the level of consciousness (Kandel et al., 1991).

We have been learning more about ARAS circuits lately (see Steriade et al., 1993) and lesion studies (see Bogen, 1997; Steriade, 1996), positron emission tomography studies (Kinomura et al., 1996) as well as elegant electrophysiological studies (see Steriade, 1996) have certainly reinstated ARAS as a qualified brain entity. However, modern cognitive neuroscience



with its brain imaging techniques (see Crick and Koch, 1992; Delacour, 1997; Gazzaniga, 1993) as well as modern medicine (Andreasen, 1997; Gloor, 1986; Porter, 1991; Zappulla, 1997; Zeman et al., 1997) are becoming too much aware of the many “pillars” (level, focus, states etc.), aspects, contents and complexity of consciousness to simply equate it with mere states of arousal.

Never the less, the term “loss of consciousness” still persists as an indispensable medical term because ARAS plays an unqualified but very significant role in many clinical disorders of consciousness. These disorders may result from decreased cerebral blood flow presenting in several transient or longer lasting variants. Stupor and coma may have several causes, but require that the brain stem is acutely or very extensively affected bilaterally and between the lower third of pons and posterior diencephalon (Walton, 1989). Symptomatic psychoses may present with “clouding of consciousness”, as in delirium or confusion, while alterations of consciousness are recognized in major psychoses (Andreasen, 1997). Consciousness is said to be lost or impaired in the course of several types of epilepsy (Gloor, 1986; Zappulla, 1997). Most people will recognize a major convulsive tonic-clonic seizure, previously known as 'grand mal', in which the child loses consciousness and then convulses, but there are many other types of attack, which are due to epilepsy. The International Classification of Seizures has made consciousness the touchstone by which the main categories of partial seizures, simple and complex, are distinguished.

Absence seizures, previously known as 'petit mal', actually take their name from the fact that they represent “very brief - 5 to 15 seconds - interruptions of consciousness”. During such typical episodes the patient has a blank stare, stops all activities except, perhaps, some fluttering of the eyelids and loses all ability to interact or respond to external events, of which he/she retains no recollection. Absences are not preceded by an aura and activity can be resumed immediately afterwards. They usually occur in children and disappear by adolescence. In infantile absence epilepsy, which is the prototype of generalized idiopathic epilepsy (Roger et al., 1985) the repeatedly occurring behavior arrest is typically accompanied by regular and highly rhythmic bilaterally synchronous EEG spike and wave discharges (SW) at 3/second, which start and cease abruptly in concomitance to the suspension of consciousness. The frequency of the absence attacks varies during the day, occurring most often during periods of decreased alertness and drowsiness and especially during the transition phases from and to sleep periods. The ability to generate SW is familial and is observed in kindred of even symptomatic epilepsy patients and in the absence of seizure symptomatology, thus suggesting SW as the hallmark

of some genetic predisposition towards all kinds of epilepsy (Berkovic et al., 1987; Metrakos and Metrakos, 1961).

In essence, the term “loss of consciousness” is too valuable in clinical practice to be avoided, just because scientists have not yet managed to understand, what consciousness really consists off. However, we do start to accept that consciousness (a) as a behavioral state, it has several levels, (b) as a neurophysiological phenomenon, it has certain prerequisites and (c) as most complex brain states, it may not be one single entity but be composed of or emerge from several concomitantly occurring events. Some of the later may define the level or state of consciousness and others may be related to its contents. For example, alertness is obviously one important prerequisite of consciousness and the two are wrongly equated in some clinical practices. Other mental activities are much harder to distinguish into those helping consciousness arise and manifest itself and those constituting contents of consciousness. Consciousness may appear as “lost” in the absence of either ones. However, there are components or aspects of conscious experience such as perception, cognition, memory, affect and voluntary motility (as well as the way these are integrated, timed etc.), which are both increasingly open to neurobiological research and quantitatively testable on a patient. Careful observations of epileptic seizures with “loss of consciousness” often reveal that only some components of consciousness are impaired. Peter Gloor’s (1986) plea to neurologists “to observe accurately and interact with the patient during an epileptic attack in order to distinguish between various behavioral disturbances masquerading as “loss of consciousness.” is therefor extremely justified. Medicine will be able to help us understand what consciousness is only after it has carefully isolated and characterized clinical syndromes, which are accompanied by as pure a “loss of consciousness” as possible according to what basic neuroscience is ready to accept at the time.

### **3 Classical Research on Mechanisms of Absence Seizures**

Absence seizures appear to come as close, as we can get, to such a clinical paradigm (at least some of the longest lasting episodes and after the above considerations made by Gloor have been observed). They furthermore merit our examination in our effort to understand consciousness, because their underlying mechanism has been extensively worked out to a greater extend than other similar clinical states and because the half century long history of this research has been linked to consciousness right from the start. As early as 1936, Wilder Penfield re-examines the “highest level seizures” of Hughlings Jackson and on the basis of neurosurgical evidence proposes the brain

stem and the diencephalon as the “indispensable substratum of consciousness” (see Jasper, 1990). Later (1947), he and Herbert Jasper, based this time on electroencephalographic evidence, proceeded to propose the term “Centrencephalic Integrating System” and the term “Centrencephalic epilepsy” for those primary epileptic attacks, which present an initial loss of consciousness and particularly absence seizures. The centrencephalic theory was supported by experiments in cats (Jasper and Droogleever-Fortuyn, 1947; Hunter and Jasper, 1949), which produced behavioral arrests with EEG SW discharges with 3/second stimulation in the intralaminar thalamus, the mid-line recruiting system of Morison and Dempsey (1942). These absence-like evoked episodes could be blocked by stimulation of brain stem reticular formation, i.e. the ARAS which Moruzzi and Magoun (1949) had already established. Photosensitive generalized epilepsy in a strain of Senegalese baboons, however, appeared not to depend on subcortical structures (Naquet, 1969). Also topical application of convulsants on the isolated cortex produced absence-like attacks and SW in cats and monkeys, without an apparent need of a subcortical pacemaker (Marcus and Watson, 1966). The centrencephalic epilepsy hypothesis was thus criticized, Gastaut (see Jasper, 1990) proposed a “holencephalic” hypothesis and Gloor (Gloor et al., 1973) advanced the view of “corticoreticular epilepsy”.

These often heated debates between advocates of mutually exclusive cortical and subcortical mechanisms (only apparently exclusive according to Jasper, 1990) underlying primary generalized or absence seizures were gradually resolved in a classical dialectic synthesis of the opposing views : a dynamic interdependence between cortical and subcortical neuronal systems. Like all genuine scientific debates however, they offered valuable concepts and data, which along with the progress in neurochemistry of aminergic and other global neurotransmitter systems (Jouvet, 1969) and the intense modern electrophysiological studies in both thalamus and cortex (see Avoli et al., 1983; Gloor et al., 1990; Kostopoulos and Gloor, 1982) they prepared the framework for a possible modern understanding of the relevant neuronal mechanisms. The later benefited most importantly from parallel advances in the understanding of sleep and arousal mechanisms (Steriade 1996), *in vitro* studies revealing thalamic mechanisms of oscillation at both the intrinsic membrane as well as circuit level (Jahnsen and Llinas 1984; Tsakiridou et al., 1995), the use of several animal models of inherited absence epilepsy (Fisher, 1989; Hosforth, 1995); as well as the use of mathematical models of the respective mechanisms (Antoniadis and Kostopoulos, 1995; Huguenard and McCormick, 1992; Mukherjee and Kaplan 1995; Lytton et al., 1997)

#### **4 Mechanisms Underlying Absence in the Feline Model of Generalized Epilepsy Induced by Penicillin (FGPE)**

Intramuscular injection of a small dose of penicillin in the cat produces a model of generalized epilepsy with sticking electrographic, behavioral and pharmacological similarities to human absence epilepsy (Prince and Farrell, 1969; Gloor et al., 1990). A series of EEG as well as single unit electrophysiological experiments in both thalamus and cortex of animals with FGPE were instrumental in demonstrating that thalamus and cortex represented essential compartments of a re-entrant oscillatory thalamo-cortico-thalamic loop required to express and sustain SW (see Gloor et al, 1990). They helped define a complex picture in which the fine tuning of the intrinsic and synaptic properties of the thalamic and cortical neurons controls the output of the whole thalamocortical (TC) system. Whether this system will express or will not express synchronized activity depends on intrinsic properties of thalamic neurons, their input from lower centers and upon cortical excitability. In that respect, three important observations were made with respect to the prerequisites for the appearance of SW : (a) SW arise at a similar arousal state as EEG spindles, (b) cortical excitability must be diffusely but mildly increased and (c) cortical inhibition must be intact (Kostopoulos et al., 1983). During SW neurons responded normally to neurotransmitters (Kostopoulos, 1986) and besides hyperexcitability and hypersynchrony (all neurons recorded in thalamus and cortex fired during the spike and all paused during the wave components of SW), no other signs of abnormal depolarization, as in other types of epilepsy, were observed. The emphasis arising from these studies was in cortical mechanisms rather than brain stem or thalamic ones, i.e. the disturbance appeared to be at the cortical end of the TC input primarily and its feedback on the corresponding thalamic sector secondarily (see Gloor et al., 1990; Naquet et al., 1986).

In a computer model simulating a cortical circuit of five representative types of neurons we were able to show the feasibility of the hypothesized (see Kostopoulos and Gloor, 1982) development of SW out of spindles as a result of only an increased cortical excitability and examine its theoretical consequences (Antoniadis and Kostopoulos, 1995). The need for cortical hyperexcitability was demonstrated in FGPE (Kostopoulos et al., 1981a; Kostopoulos, 1982) and later in an epileptic mutant animal, which presents absence seizures (Kostopoulos and Psarropoulou, 1990). In both cases hyperexcitability was a sufficient condition without the need for a reduction of inhibition (Kostopoulos et al., 1983; Kostopoulos and Antoniadis, 1991).

It is known that bilateral damage to the thalamus abolishes waking consciousness, the most critical site

of the damage being the intralaminar nuclei (see Bogen 1997; Steriade, 1996). It is very interesting that this site was found as the most effective stimulation site for inducing recruiting responses, spindles (see Jasper, 1990; Kostopoulos, 1982; 1984) and the transition from spindles to SW (Kostopoulos et al., 1981b) in FGPE. Paradoxically, in the combined records from cortical and thalamic neurons during the development of SW, the cortical neurons were most often leading in time the thalamic ones during each spike and among the thalamic neurons of the specific nuclei were definitely leading those in the midline and intralaminar (non-specific) nuclei, while many of the later did not participate in the oscillatory activity (see Gloor et al., 1990).

An other important finding of the studies with the FGPE is that the power frequency spectrum of EEG was transformed from spindles (9 Hz) to SW (4.5 Hz or 3 Hz, when cats had a midcollicular lesion) not gradually but in discrete steps (Kostopoulos et al., 1981b). This led us to propose the following mechanism (Gloor, 1979; Kostopoulos et al., 1991a; Kostopoulos and Gloor, 1992; Gloor et al., 1990) : SW may develop from the increased responses of cortical neurons to those TC volleys, which normally pace spindles. The increased output of principal neurons in cortex engages then the local recurrent inhibitory feedback, which annuls every second spindle afferent input, thus transforming the spindle rhythm to SW rhythm with every second spindle made into a spike, which is followed by a slow negative wave (spikes and waves of SW reflecting intracellular EPSPs and IPSPs respectively). The recruitment of cortical inhibitory interneurons, which are excited by the principal neurons and then inhibit them, suggests the emergence of a limit cycle attractor (see Freeman, 1987) for oscillations at slow frequencies, which reduces brain complexity to the extent that this attractor engages many and vast TC sectors in a globally hypersynchronous oscillatory state incompatible with information processing.

Llinas and Pare (1997) hypothesize that conscious experience depends heavily on concurrent summation of specific and non-specific 40-Hz activity along the radial dendritic axis. Such a mechanism would require that the inputs to be summated in space and time would be subthreshold, as they usually are. However in the FGPE we have observed that both specific and non-specific TC responses are tremendously increased above firing threshold prior to the appearance of SW and while the absence state lasts (Kostopoulos, 1982; 1984; Kostopoulos and Avoli, 1983). This may be an other way by which SW disrupt conscious processing, i.e. disallowing the comparison and/or synergy of specific and non-specific TC afferent inputs.

The idea of SW developing as a “perversion” of spindles was fortunate to find both some clinical confirmation (Kelaway et al., 1990) and most importantly some explanatory evidence and further elaboration based on recent studies in cat experiments

in vivo (Steriade and Contreras, 1995) and in thalamic slices in vitro (Bal et al., 1995; McCormick and Bal, 1997).

## 5 Neuronal Mechanisms of Spindle and SW Rhythmogenesis

The spindle rhythm is a typical thalamic activity characterized by waxing and waning bursts of 7-14 Hz. The pacing of this rhythm is generated in the thalamus during the early stages of sleep and is projected diffusely to the cortex. The rhythmical depolarizations (usually subthreshold for firing) of cortical neurons in response to these projections create the electrical sources of EEG spindles. The pivotal advancement was made by the direct demonstration of the importance in the generation of EEG spindles of the reticular nucleus of thalamus (Steriade et al., 1985), as had been suggested earlier (see Jasper, 1990; Newman, 1995). This is a collection of GABAergic neurons that form a shell surrounding the dorsal and lateral aspects of the rest of the thalamus (Jones, 1985; Ohara and Lieberman 1985). Like TC neurons, the neurons of nucleus reticularis thalami (RT) are excited by sensory afferents (de Curtis and Avanzini, 1994). The axons of TC and corticothalamic cells pass through the thalamic reticular nucleus and excite the RT cells through axon collaterals, thus enabling them to exert onto TC cells both a feedforward inhibition in the communication from cerebral cortex to thalamus and a feedback inhibition for communication between the thalamus and the cerebral cortex. Beyond their own interrelationships, which are most likely mediated by glutamate, the thalamus and the cerebral cortex are innervated by a number of different modulatory neurotransmitter systems : cholinergic from the pedunclopontine and lateral dorsal tegmental nuclei in the brainstem; noradrenergic from the locus coeruleus; serotonergic from the raphe nuclei; and histaminergic from the hypothalamus. Together, these modulatory transmitter systems control the state of activity in the thalamus and cerebral cortex (McCormick et al., 1993)

Experiments in vivo (Steriade and Llinas, 1988) as well as in vitro (Jahnsen and Llinas, 1984; Crunelli and Lereshe, 1991; McCormick and Bal, 1997) have demonstrated that single thalamic neurons (both TC and RT) exhibit two distinct states of activity: an oscillatory state of rhythmic burst firing (as during slow wave sleep) and a relay state of tonic single spike firing (as during waking). These oscillations were shown to be generated through the interaction of mainly two distinct ionic currents: the low threshold  $Ca^{++}$  current, or T-current, and a hyperpolarization-activated cation current, known as the H-current. The biophysical properties of the low threshold  $Ca^{++}$  current in TC and RT neurons have been well characterized and modeled along with the rhythmic burst firing in single TC neurons (McCormick and Huguenard, 1992; Huguenard, 1996). The interactions

of these intrinsic membrane properties of thalamic neurons with other thalamic and cortical cells results in the generation of complex patterns of synchronized oscillations such as spindle waves. The normal generation of spindle waves involves a cyclical interaction between TC relay cells and the GABAergic RT neurons. RT neurons burst and inhibit TC cells. Some of these generate rebound burst due to their T- and H- currents and re-excite RT cells. The generalization of this activity throughout the network results in propagation of the oscillation and the "waxing" of the spindle wave in the EEG. Normally, RT cells inhibit one and another and therefore regulate the amplitude of each burst of action potentials during spindle wave generation (McCormick and Bal, 1997).

Since hyperpolarization is necessary for the oscillatory activity, depolarization of RT and/or relay TC cells abolishes spindles and moves the forebrain into a state that is conducive to the processing of sensory information. This depolarization may be accomplished by any of the subcortical (releasing mostly amines) or cortical (releasing glutamate) afferents mentioned earlier. Activation of muscarinic, alpha-1 adrenergic, H1-histaminergic, or glutamate metabotropic receptors results in the reduction of a leak potassium current and the depolarization of the cell. In addition, the activation of beta-adrenergic, serotonergic, and H2-histaminergic receptors results in the abolition of spindle waves through the enhancement of the H-current (McCormick et al., 1993; McCormick and Bal, 1997).

On the contrary, excessive inhibition of TC cells (which may be caused by the release of RT cells from their reciprocal inhibition and subsequent strong activation by them of GABA<sub>B</sub> receptors-mediated slow, long duration IPSPs on the TC cells, which is particularly effective in activating large rebound low threshold Ca<sup>2+</sup> spikes, Crunelli and Lereshe, 1991), creates large bursts of action potentials in TC cells, which excite RT neurons even more, resulting in a positive feedback loop and the generation of lower frequency oscillations involving larger TC sectors in much greater synchrony, like those prevailing in SW of absence seizures. Thus, like in the previously mentioned experiments in FGPE, the group of David McCormick was able to obtain a transition from spindle to SW rhythm *in vitro* after increasing neuronal excitability (von Krosigk et al., 1993). These SW were blocked by GABA<sub>B</sub> antagonists. According to these experiments absence seizures, appear to result from a perversion of normal synchronized oscillations normally giving rise to spindles. Further evidence about such a mechanism of generating SW was collected in a genetic model of absence epilepsy, the Strasbourg rats (GAERS, see Avanzini et al., 1996). Application of GABA<sub>B</sub> agonists in nucleus reticularis thalami of GAERS increases SW (Liu et al., 1992). GABA<sub>B</sub> agonists can actually induce SW in normal animals (Banerjee et al 1993), while GABA<sub>B</sub> receptor density is found increased in rodent strains with

genetic absence epilepsy (Snead et al., 1990). An other possible mechanism to potently induce K<sup>+</sup> current-mediated long lasting inhibition in thalamus is through the release of adenosine (Kostopoulos, 1988). Interestingly, adenosine A1 receptors are specifically disturbed in nucleus reticularis thalami of the GAERS model of absence (Economou et al., 1996), while the A1 antagonist caffeine blocks SW in the absence model of tottering mouse (Kostopoulos et al., 1987)

Finally, it appears very important with respect to the above hypothesis that the activity of the transient calcium channels needed for the oscillatory behavior is relatively higher in nucleus reticularis of the genetic animal model of absence in GAERS (Tsakiridou et al., 1995) and is blocked by ethosuximide, which is effective in absence seizures (Coulter et al., 1990).

Steriade and Contreras (1995) have recently observed *in vivo* the interrelationship between thalamic and cortical cells in anesthetized cats during the progressive development from EEG-synchronized sleep patterns to paroxysmal activities, most of them consisting of epileptic-like seizures with spike-wave (SW) complexes at 2-4 Hz. They emphasize the inhibition of TC cells by corticothalamic afferents presumably mediated by GABAergic RT neurons. They propose that such inhibitory processes during cortical SW seizures may contribute to the loss of consciousness, due to obliteration of synaptic transmission through the thalamus.

## 6 Discussion

From all said above (see also reviews by Avoli et al., 1990; Niedermeyer, 1996; Myslobodsky, 1988; Snead 1995), it appears most likely that the defect underlying absence seizures is not structural (see Sabers et al., 1996), but functional and quantitative rather than qualitative. We cannot know yet whether indeed SW and absence seizures develop as a consequence to a fault in GABA receptors or a calcium current that is able to transform a TC circuit able to induce spindles into one that induces SW. It is however conceivable that, if present from birth, such changes may promote oscillatory TC activity which may influence plastic mechanisms affecting cortical synapses and induce a diffuse cortical hyperexcitability (Avanzini et al., 1996). We have already shown (Kostopoulos et al., 1981a; Kostopoulos and Gloor, 1992, Gloor et al., 1990) that the latter may indeed make the difference between a state of normal sleepiness expressed on the EEG as spindles and an epileptic seizure characterized by "loss of consciousness".

The observation that SW develop under conditions of arousal similar to those producing spindles (Kellaway et al., 1990; Kostopoulos and Gloor, 1982) may not mean that the ARAS is defective at that time like at the first stages of sleep. Actually, in contrast to sleep induction, the descending influences of the

reticular formation (on heart rate, muscle tone etc.) are not changed during an absence. Therefore, the defect may lie not with ARAS itself, but with the way the thalamus is receiving the messages from ARAS or is acting upon them in association to an hyperexcitable cortex. The leading role of cortex in starting SW is evident in FGPE (Gloor et al., 1990), while in GAERS and other rodent models of absence the oscillations may be more readily initiated from the thalamus than from the cortex (Avanzini et al., 1996). However, this difference may be trivial compared with the importance of the role, which oscillations reentrant thalamo-cortico-thalamic loops play in the elaboration, maintenance and global synchronization of generalized SW.

Absence has been viewed above as the availability of a very strong EEG attractor for 3/sec hypersynchronous activity - and the basic mechanisms for such attractor have been hypothesized. Involvement into such an attractor is a situation apparently incompatible with the binding of neurons into assemblies specific for different experiences (Singer and Gray, 1995) either at cortical or at thalamic level. The extent however of the prevalence of such an attractor may possibly vary considerably in time and between different TC sectors. Thus the symptoms of absence may vary too, and present as complete "loss of consciousness", if the activity of the attractor has involved most of the thalamus (and especially its intralaminar nuclei) and thus interferes with the elaboration of brain stem afferents signaling the states of consciousness (sleep/wake, orienting, attention) or as partial defects of some mental activities variously related to the contents of consciousness and not the person's capacity for it. The latter however are still hard to distinguish from each other.

It is now certain that in absence epilepsy and during SW discharges a large number of neurons oscillate between short periods of excitation, corresponding to the spike, and longer periods of inhibition, corresponding to the slow wave component of the spike and wave complex. This disrupts the normal transactional processes of cortical neurons which are presumably responsible for mental activity, particularly for the close integration of perception, cognition and voluntary motor responsiveness. Gloor (1986) reported that careful clinical examination reveals that the degree of this interference may vary and he emphasized that in mild absence seizure it is not justified to speak of "loss of consciousness", but rather of a "clouding of the mind". Certainly, the fact that certain cognitive functions may be preserved during some mild absence seizures makes it unlikely that absences are a mere loss of consciousness in the old medical framework of a continuum (see above) dictated by brain stem ARAS activity. It is the contents (and their integration, timing etc.) of consciousness or the actual conscious processing that

is disturbed in absence rather than the person's ability for it. However, the distinction between them is extremely difficult since their expression is by definition interactive. Even more difficult of course (and to some even impossible) is to understand how this interactive integration of multiple cognitive functions yields a unified representation of the world, our bodies and ourselves.

## 7 Conclusion

The extraordinary amount of inter-connectivity between thalamus and cortex allows the latter to regulate the flow of information to itself. Thanks to this huge, self regulatory feedback circuit, which apparently binds those processes of the brain, which are important to consciousness, we are able to focus on what is needed to from moment to moment and be aware of this fact. This ability of proper functioning of the TC loops may be lost in two ways: either by disallowing the proper TC connections (lesions, anoxia, prolonged synaptic inhibition etc), or by long term (seconds) engaging of large numbers of TC loops in much stronger and lower frequency oscillations (like in the rhythm of sleep spindles or the SW of absence epilepsy), than those physiologically useful for conscious experience. Spread of these slow rhythms at the thalamic level (spindles) or additionally and more massively at the cortical level (SW) results in a global hypersynchronous state, which precludes the selective participation of neurons in short-lived (msec), minute assemblies, specific for elementary perceptive, motor or other tasks. Recently, the mechanisms underlying these hypersynchronous oscillations at the level of intrinsic membrane currents, neurotransmitters and neuronal circuits have started to become elucidated. The presented view of neuronal mechanisms possibly underlying loss of consciousness in absence epilepsy is compatible with emerging hypotheses about mechanisms underlying consciousness and reinforce our optimism for the feasibility of neurobiological investigation of this tremendously complex phenomenon. They further emphasize the importance of deciphering between mechanisms underlying states as opposed to contents and processes of consciousness, as absence may result from interference with the second rather than the first.

## Abbreviations:

ARAS - ascending reticular activating system  
EEG - electroencephalogram  
EPSP - excitatory postsynaptic potential  
GABA -  $\gamma$ -aminobutyric acid  
IPSP - inhibitory postsynaptic potential  
TC - thalamocortical  
SW - spike and wave

## References

- [1] Andreasen NC 1997 Linking Mind and Brain in the Study of Mental Illnesses: A Project for a Scientific Psychopathology *Science* 275 (5306): 1586 -1593.
- [2] Antoniadis G and Kostopoulos G 1995 A simulation study for the transition from spindles to spike and wave epileptogenesis. *Medical and Biological Engineering and Computing* 33:241-246.
- [3] Avanzini G, de Curtis M, Franceschetti S, Sancini G, and Spreafico R 1996 Cortical versus thalamic mechanisms underlying spike and wave discharges in GAERS. *Epilepsy Res* 26:37-44.
- [4] Avoli M, Gloor P, Kostopoulos G and Naquet R, Eds. 1990 *Generalized epilepsy: Neurobiological Approaches*, Birkhauser, Boston, pp.480.
- [5] Avoli M, Gloor P, Kostopoulos G and Gotman J, 1983 An analysis of penicillin-induced spike and wave discharges using simultaneous recording of cortical and thalamic single neurons, *J. Neurophysiol.* 4:819-837.
- [6] Bal T, von Krosigk M, and McCormick DA 1995 Synaptic and membrane mechanisms underlying synchronized oscillations in the lateral geniculate nucleus in vitro. *J. Physiology* 483(3):641-663.
- [7] Banerjee PK, Hirsch E, and Snead OC 1993 Gamma-hydroxybutyric acid induced spike and wave discharges in rats: relation to high-affinity [3H]gamma-hydroxybutyric acid binding sites in the thalamus and cortex. *Neuroscience* 56:11-21.
- [8] Berkovic SF, Andermann F, Andermann E, and Gloor P 1987 Concepts of absence epilepsies : discrete syndromes or biological continuum? *Neurology* 37:993-1000.
- [9] Bogen JE 1997 Some neurophysiologic aspects of consciousness. *Semin. Neurol.* 17(2):95-103.
- [10] Coulter DA, Huguenard J, and Prince DA 1990 Differential effect of petit mal anticonvulsants and convulsants on thalamic neurons: calcium current reduction. *Br. J. Pharmacol.* 100:800-806
- [11] Crick F and Koch C 1992 The problem of consciousness. *Scientific American*, Sept., p.111-117.
- [12] Crunelli V, and Lereshe N 1991 A role for GABA<sub>B</sub> receptors in inhibition of thalamocortical cells. *TINS* 14:16-21
- [13] De Curtis M and Avanzini G 1994 *Functional Neurology* 4(6):307-326.
- [14] Delacour J 1997 Neurobiology of consciousness: An overview. *Behav. Brain Res.* 85(2):127-141.
- [15] Economou A, Angelatou F, Vergnes M, and Kostopoulos G. 1996 Lower density of A1 adenosine receptors in nucleus reticularis thalami of the genetic absence epilepsy rats from Strasbourg (GAERS): An autoradiographic study. *The 2<sup>nd</sup> meeting of European Neuroscience*, 24-28 Sept., Strasbourg, France, abstract 113.11
- [16] Fisher R 1989 Animal models of epilepsy. *Brain Research Reviews* 14:245-278.
- [17] Freeman WJ 1987 Simulation of chaotic EEG patterns with a dynamic model of the olfactory system. *Biol. Cybern.* 56(2-3):139-150.
- [18] Gazzaniga MS 1993 Brain mechanisms and conscious experience. *Ciba Found. Symp.* 174, 247-257
- [19] Gloor P 1979 Generalized epilepsy with spike-and-wave discharge: a reinterpretation of its electrographic and clinical manifestations. The 1977 William G. Lennox Lecture, *American Epilepsy Society Epilepsia* 20(5):571-588
- [20] Gloor P 1986 Consciousness as a neurological concept in epileptology: A critical review. *Epilepsia* 27 Suppl 2:S14-26
- [21] Gloor P, Avoli M, and Kostopoulos G 1990 Thalamocortical relationships in generalized epilepsy with bilaterally synchronous spike-and-wave discharge. In M. Avoli, P. Gloor, G. Kostopoulos and R. Naquet (Eds.), *Generalized Epilepsy: Neurobiological Approaches*, Birkhauser, Boston, pp. 190-212.
- [22] Gloor P, Testa G, and Guberman A 1973 Brainstem and cortical mechanisms in an animal model of generalized corticoreticular epilepsy. *Trans. Am. Neurol. Assoc.* 98:203-5.
- [23] Hosforth DA 1995 Models of primary generalized epilepsy. *Current Opinion in neurology*, 8: 121-125.
- [24] Huguenard JR 1996 Low-threshold calcium currents in central nervous system neurons. *Annu. Rev. Physiol.* 58:329-348.
- [25] Jahnsen H and Llinas R 1984 Ionic basis for the electroresponsiveness and oscillatory properties of guinea pig thalamic neurons in vitro. *J. Physiol. (L)* 349:227-247.
- [26] Jasper HH 1990 Historical introduction In M. Avoli, P. Gloor, G. Kostopoulos, and R. Naquet (Eds.), *Generalized Epilepsy: Neurobiological Approaches*, Birkhauser, Boston, pp 1-15.
- [27] Jasper H and Droogleever-Fortuyn J 1947 Experimental studies of the functional anatomy of petit mal epilepsy. *Assoc. Res. Nerv. Ment. Dis. Proc.* 26:272-298.
- [28] Jones EG (Ed.) 1985 *The Thalamus*. Plenum, New York.
- [29] Jouvet M 1969 Biogenic amines and the states of sleep. *Science* 163(862):32-41
- [30] Kandel ER, Schwartz JH, and Jessel TM 1991 *Principles of Neural Science*, Elsevier, Amsterdam.
- [31] Kellaway P, Frost JD, and Crawley JW 1990 The relationship between sleep spindles and spike-and-wave bursts in human epilepsy. In M. Avoli, P. Gloor, G. Kostopoulos, and R. Naquet (Eds.), *Generalized Epilepsy: Neurobiological Approaches*, Birkhauser, Boston, pp 36-48.
- [32] Kinomura S, Larsson J, Gulyas B, and Roland PE 1996 Activation by attention of the human

- reticular formation and thalamic intralaminar nuclei. *Science* 271(5248):512-515
- [33] Kostopoulos G and Psarropoulou C 1990 Increased postsynaptic excitability in hippocampal slices from the tottering epileptic mutant mouse. *Epilepsy Res.* 6:49-55.
- [34] Kostopoulos GK and Gloor P 1982 A possible neurophysiological mechanism for generation of spike and wave discharges in feline generalized penicillin epilepsy and its relationship to spindle generation. In *Sleep and Epilepsy.*, MB Sterman Passouant and MN Shouse (Eds.), Academic Press, New York, pp. 11-27.
- [35] Kostopoulos G 1982 Potentiation and modification of recruiting responses precedes the appearance of spike and wave discharges in feline generalized penicillin epilepsy, *EEG Clinical Neurophysiol.* 53: 467-478.
- [36] Kostopoulos G 1984 The mechanisms underlying potentiation of recruiting responses may include GABA-disinhibition, *EEG Clinical Neurophysiol.*, 58 378-381.
- [37] Kostopoulos G, 1986 Neuronal sensitivity to GABA and glutamate in generalized epilepsy with spike and wave discharges, *Exp Neurol.*, 92(1): 20-36.
- [38] Kostopoulos G, 1988 Adenosine: A molecule for synaptic homeostasis? Evolution of current concepts on the physiological and pathophysiological roles of adenosine. In M. Avoli, R. Dykes, P. Gloor and T. Reader (Eds.), *Neurotransmitters and cortical function: from molecules to mind*, Plenum Press, New York, pp. 415-435.
- [39] Kostopoulos G and Antoniadis G, 1991 A comparison of recurrent inhibition and of paired-pulse facilitation in hippocampal slices from normal and genetically epileptic mice, *Epilepsy Res.*, 9(3) 184-194.
- [40] Kostopoulos G and Avoli M, 1983 Enhanced response of cortical neurons to thalamic stimuli precedes the appearance of spike and wave discharges in feline generalized penicillin epilepsy, *Brain Research*, 278 207-217.
- [41] Kostopoulos G, Avoli M and Gloor P, 1983 Participation of cortical resurgent inhibition in the genesis of spike and wave discharges in feline generalized penicillin epilepsy, *Brain Res*, 267 101-112.
- [42] Kostopoulos GK, Gloor P, Pelegrini A and Gotman J, 1981 A study of the transition from spindles to spike and wave discharges in feline generalized penicillin epilepsy. II. Microphysiological features, *Experimental Neurology*, 73 55-77.
- [43] Kostopoulos GK, Gloor P, Pellegrini A and Siatitsas I, 1981 A study of the transition from spindles to spike and wave discharges in feline generalized penicillin epilepsy. I. EEG features, *Experimental Neurology*, 73 43-54.
- [44] Kostopoulos G, Veronikis DK and Efthimiou R, 1987 Caffeine blocks absence seizures in the tottering mouse, *Epilepsia*, 28(4): 415-420.
- [45] Liu Z, Vergnes M, Depaulis A, and Marescaux C 1992 Involvement of intrathalamic GABA<sub>B</sub> neurotransmission in the control of absence seizures in the rat. *Neuroscience* 48: 87-93
- [46] Llinas R and Pare D 1997 "Coherent oscillations in specific and nonspecific thalamocortical networks and their role in cognition" in *Thalamus*, M Steriade, EG Jones, and DA McCormick (Eds).
- [47] Lytton WW, Contreras D, Destexhe A, and Steriade M, 1997 Dynamic interactions determine partial thalamic quiescence in a computer network model of spike-and-wave seizures. *J Neurophysiol* 77(4):1679-1696
- [48] McCormick DA and Bal T 1997 Sleep and arousal: Thalamocortical mechanisms *Annu. Rev. Neurosci.* 20:185-215.
- [49] McCormick DA and Huguenard J 1992 A model of the electrophysiological properties of thalamocortical relay neurons. *J. Neurophysiol.* 68:1384-1400.
- [50] McCormick DA, Wang Z, and Huguenard JR 1993 Neurotransmitter control of neocortical neuronal activity and excitability. *Cerebral Cortex* 3: 387-398.
- [51] Metrakos K and Metrakos J 1961 Genetics of convulsive disorders. II. Genetic and EEG studies in centrencephalic epilepsy. *Neurology* 11:474-483.
- [52] Morison R and Dempsey E 1942 A study of thalamocortical relations. *Am. J. Physiol.* 135:281-292.
- [53] Moruzzi G and Magoun HW 1949 Brain stem reticular formation and activation of the EEG. *EEG Clin. Neurophysiol.* 1: 455-473.
- [54] Mukherjee P and Kaplan E 1995 Dynamics of neurons in the cat lateral geniculate nucleus: in vivo electrophysiology and computational modeling. *J. Neurophysiol.* 74(3): 1222-43
- [55] Myslobodsky MS and Mirsky AF (Eds.) 1988 *Elements of petit-mal epilepsy*. Peter Lang, New York.
- [56] Naquet R, Silva-Barrat C, and Menini C 1986 Role of the thalamus in the physiopathology of epilepsy. *Rev. Neurol. (Paris)*;142(4):384-390.
- [57] Naquet R, Silva-Barrat C, and Menini C 1995 Reflex epilepsy in the Papio-papio baboon, particularly photosensitive epilepsy. *Ital. J. Neurol. Sci* 16(1-2):119-125.
- [58] Newman J 1995 Thalamic contributions to attention and consciousness. *Conscious Cogn* 4(2):172-193
- [59] Niedermeyer E 1996 Primary (idiopathic) generalized epilepsy and underlying mechanisms. *Clin. Electroencephalogr.* 27(1):1-21.

- [60] Ohara PT and Lieberman AR 1985 The thalamic reticular nucleus in the rat: experimental anatomical studies. *J. Neurocytol.* 14:365-411.
- [61] Penfield W 1936 The cerebral cortex in man. I. The cerebral cortex and consciousness (Harvey lecture) *Arch. Neurol. Psychiatr.* 40:417-442.
- [62] Penfield W and Jasper H 1947 Highest level seizures. *Assoc. Res. Nerv. Ment. Dis. Proc.* 26:252-271.
- [63] Porter RJ, 1991 Disorders of consciousness and associated complex behaviors. *Seminars in Neurology* 11(2): 110-117.
- [64] Prince D and Farrell D 1969 Centrencephalic spike and wave discharges following parenteral penicillin injection in the cat. *Neurology* 19:309-310.
- [65] Roger J, Dravet C, and Bureau M (Eds.) 1985 *Epileptic syndromes in infancy, childhood and adolescence.* John Libbey, London.
- [66] Sabers A, Moller A, Scheel-Kruger J, and Mouritzen Dam A 1996 No loss in total neuron number in the thalamic reticular nucleus and neocortex in the genetic absence epilepsy rats from Strasbourg. *Epilepsy Res.* 26(1):45-48.
- [67] Singer W and Gray CM 1995 Visual feature integration and the temporal correlation hypothesis. *Annu. Rev. Neurosci.* 18:555-586.
- [68] Snead OC 3rd, 1995 Basic mechanisms of generalized absence seizures. *Ann. Neurol.* 37(2): 146-157.
- [69] Snead, Hechler, Vergnes, Marescaux, and Maitre 1990 Increased gamma-hydroxybutyric acid receptors in thalamus of a genetic animal model of petit mal epilepsy. *Epilepsy Research* 7:121-128.
- [70] Steriade M and Llinas R 1988 Functional states of the thalamus and the associated neuronal interplay. *Physiol. Rev.* 68:649-742.
- [71] Steriade M 1996 Arousal: Revisiting the Reticular Activating System. *Science* 272(5259): 225.
- [72] Steriade M and Contreras D 1995 Relations between cortical and thalamic cellular events during transition from sleep patterns to paroxysmal activity. *J Neurosci.* 15(1 Pt 2):623-642.
- [73] Steriade M, Deschenes M, Domich L, and Mulle C 1985 Abolition of spindle oscillations in thalamic neurons disconnected from the nucleus RT. *J. Neurophysiol.* 54: 1473-1497.
- [74] Steriade M, McCormick DA, and Sejnowski TJ 1993 Thalamocortical oscillations in the sleeping and aroused brain. *Science* 262(5134):679-685.
- [75] Tsakiridou E, Bertollini L, De Curtis M, Avanzini G, and Pape H-C, 1995 Selective Increase in T-Type Calcium Conductance of Reticular Thalamic Neurons in a Rat Model of Absence Epilepsy. *J. Neurosci.* 15(4):3110-3117.
- [76] Von Krosigk M, Bal T, and McCormick DA 1993 Cellular mechanisms of a synchronized oscillation in the thalamus. *Science* 261: 361-364
- [77] Walton L 1989 *Essentials of Neurology,* Churchill Livingstone, New York.
- [78] Zappulla RA 1997 *Epilepsy and Consciousness* 17(2): 113-119.
- [79] Zeman AZ, Grayling AC, and Cowey A 1997 Contemporary theories of consciousness. *J. Neurol. Neurosurg. Psychiatry.* 62(6):549-552.



## PROSPECTS OF COMPUTER ACCESS USING VOLUNTARY MODULATED EEG SIGNAL

Aleksandar Kostov<sup>1,3</sup> and Mark Polak<sup>2</sup>

<sup>1</sup>Faculty of Rehabilitation Medicine, University of Alberta, Canada

<sup>2</sup>Department of Computing Science, University of Alberta, Canada

<sup>3</sup>Glenrose Rehabilitation Hospital, Edmonton, AB, Canada

E-mail: Aleks.Kostov@Ualberta.CA

**Abstract.** In this paper we report on the development of an experimental setup and the initial results for evaluation of the use of electroencephalogram (EEG) signal for computer access. In our experiments, we recorded and analyzed surface EEG signals above sensory-motor areas, while the subjects were attempting to use only mental activities to modulate consciously their EEG signals resulting in desired simple movements of animated objects on the feedback computer screen. To discover possible communication and control channels based on EEG signals, we asked our subjects to determine which mental activity produced most reproducible control actions. We calculated the power spectral density (PSD) and the amplitude frequency distribution of recorded EEG signals in the sensory-motor rhythm (SMR) and used them as the feedback generating variables, i.e. the object's movement direction and speed were dependent on the integrated PSD or EEG amplitude in the SMR range. We used three subjects in our initial experiments. During the first session all three demonstrated the capability to determine which mental activity resulted in the desired movements. Off-line analysis showed that classification accuracy of more than 70% can be achieved using adaptive logic networks (ALNs) classifier on data recorded from a subject with only 2 training sessions. These results are very encouraging and provide a good basis for development of a brain-computer interface using cognitively modulated EEG signals.

**Key words:** *electroencephalogram, sensory-motor rhythm, assistive devices, computer access*

### 1 Introduction

Assistive devices are essential in enhancing the quality of life for individuals who have severe disabilities, such as quadriplegia and amyotrophic lateral sclerosis, or who have had massive brainstem strokes. However, the effectiveness of these systems is dependent on preserved residual movements or speech. In the absence of means to repair the damaged nervous system, three options exist for restoring a function: (1) augmenting the capabilities of remaining pathways, (2) detouring around points of damage, or (3) providing the brain with new channels for communication and control. With today's state-of-the-art technology, the only recordable physical action generated by the brain is its electrochemical activity producing signals such as EEG and MEG

(magnetoencephalogram). The concept of using brain's electrical activity for communication and control has a long history, however, its materialization and implementation for computer access has recently become much more promising, due to advances in computing, signal processing and pattern recognition technology. It has been demonstrated that subjects can be trained to control consciously the amplitude of specific frequency components of their EEGs as recorded over the sensorimotor cortex [1].

One EEG component susceptible to conditioning is the  $\mu$ -rhythm, 8-12 Hz activity over primary motor and sensory cortices, that is attenuated by movement but not by eye opening and is detectable in nearly all adults [2]. Using power spectrum analysis, Wolpaw and McFarland [1] found that humans could learn to increase and decrease the  $\mu$ -rhythm amplitude over one hemisphere and could use this control to move a cursor on a computer screen up or down quickly and accurately. This provides a basis for the assumption that EEG signals can be voluntarily modulated by different thoughts giving severely disabled persons a chance to express some simple intentions using their EEG signals. The most difficult problem still remains unsolved: precise positioning of the cursor on the computer screen. Our efforts are directed toward development of such an EEG recording and processing setup and training method that will maximize efficiency of extraction of user's intentions in a shortest possible time.

### 2 Methods

In our initial experiments we recorded and analyzed surface EEG signals above sensory-motor areas. During the recording the subjects were attempting to use various mental activities to modulate their EEG signals resulting in the desired movement of an animated object on the feedback computer screen.

#### 2.1 Experimental setup

The subject is comfortably seated in front of the *Subject's screen* (see Fig. 1). EEG signals are recorded

using an electrode cap with 28 gel-filled electrodes distributed according to the 10-20 international electrode system [3], one ground electrode and the linked-ears reference. The electrode cap and EEG-preamplifiers are optically isolated from the rest of the equipment. This provides safety for both the subject and the operator. For signal amplification and filtering we use the Brain Imager (Neuroscience Inc.). Analog EEG signals are then digitized at 200 samples/s by a data acquisition card (DAQ) inserted in an IBM PC compatible computer. The same computer has a special video card splitting the video output into two high resolution monitors, one for the subject and one for the operator. During the experiment the computer is supervised by the operator who played significant role in the feedback loop.

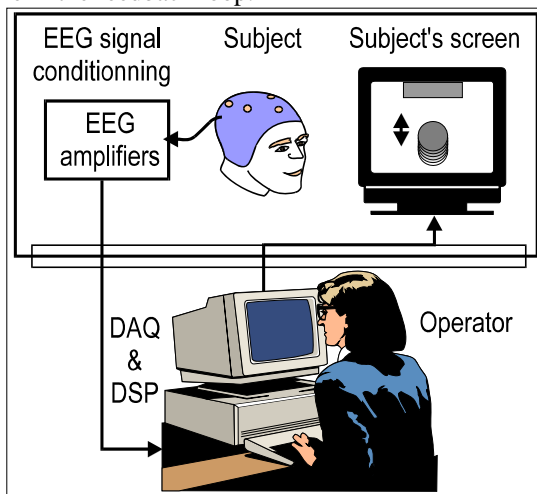

**Figure 1** Experimental setup for on-line subject's training.

We use two manual switches to distinguish periods of focused mental activity from spontaneous EEG. The subject marks intervals of conscious attempts to control the object's movement on the screen by pressing on the left hand switch for the beginning, and the right hand switch for the end of the interval. Since mental concentration is required to produce desired EEG signals, these switches allow the subject to rest during the experiment and avoid fatigue. As can be seen in Fig. 1, the circle on the subject's screen represents the moving object and the rectangle represents the target. The subject's goal is to move the circle to the target whose position is controlled either randomly by the program or by the operator. Special software was developed to integrate all functions of the system.

## 2.2 Experimental Task

The goal of this study was to achieve simple control actions, such as one-dimensional (up - down) object movement on the computer screen using only mental activities. Each recording session is divided into three parts:

- (1) Static training;
- (2) Dynamic training; and

- (3) Performance evaluation.

During static training, a one minute EEG recording is acquired for the UP thought pattern and one minute for the DOWN pattern without the subject receiving any feedback. The purpose of this step is to acquire calibration data for initialization of feedback parameters. In dynamic training, a target is selected as either DOWN or UP and the subject is asked to move the object which appears in the middle of the screen to this target. The operator adjusts the feedback parameters to optimize the performance. Discrete thresholds on EEG signal amplitude or power are used to distinguish between two different speeds for each up and down movement and for a "no-action" interval. Performance evaluation is done at the end of each session to assess the performance of the subject and the system. In this step, the operator only controls target location but does not adjust the feedback parameters.

During the first experiments with naive subject, two parallel learning processes occur simultaneously:

- (4) Subject is asked to try to determine and report which thoughts produce desired actions on the moving object; and
- (5) Investigators try to integrate and compare their knowledge with the information received from the subject and their observation of the subject's performance.

## 2.3 Signal Processing and on-line Feedback

We calculated the power spectrum density (PSD) for selected electrodes above the sensory-motor and parietal areas in both hemispheres (C3, C4, P3 and P4). Power spectrum density was calculated using fast Fourier transform (FFT) and Hanning cosine window for selected EEG-signals. To be able to test our setup and compare our results to those from the literature, we focused our attention on sensory-motor rhythm (SMR), which is also known as  $\mu$ -rhythm. We integrated PSD components between 8 and 12 Hz over one-second periods, and used thresholds to decide on real-time control actions. To make the control operation smoother, a moving average over the last 5 second was used. An example of a PSD for the two thought patterns can be seen in Fig. 2.

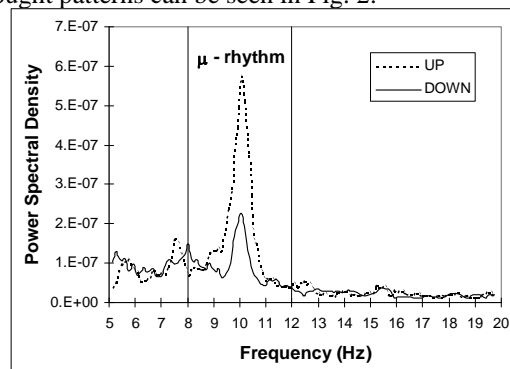

**Figure 2** Averaged power spectrum density for UP and DOWN thought patterns in lead C4.

We also used EEG amplitude of the  $\mu$ -rhythm to distinguish between UP and DOWN thought patterns. A graph showing the difference between one-second average EEG amplitude distributions produced by UP and DOWN thoughts can be seen in Fig. 3. As expected, the concentration of EEGs associated with DOWN thoughts is at low amplitudes, while the concentration of EEGs associated with UP thoughts is at high amplitudes. It is evident that SMR desynchronization can be seen on both central and parietal leads, suggesting that voluntary control in this case affects widespread potentials in the 8 - 12 Hz frequency range.

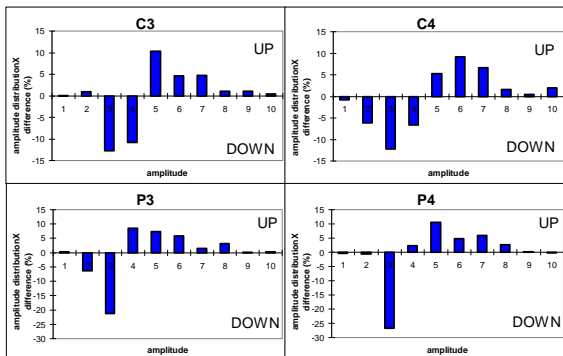
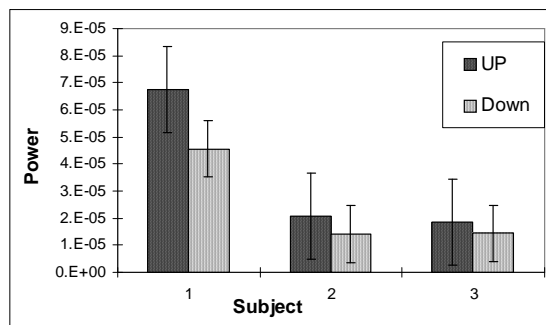

**Figure 3** Difference between UP and DOWN  $\mu$ -rhythm power averages.

### 3 Results

#### 3.1 Subject Training

Three volunteers participated in the testing of our experimental setup. Initially, they did not have any previous biofeedback training, however their initial knowledge about this experiment was based on similar reports from literature. SMR power for three subjects demonstrating EEG control is presented in Fig. 4. This bar graph shows the averaged EEG power in  $\mu$ -rhythm when the subject is focusing on moving an object on the screen to a target positioned either at the bottom or at the top of the screen. A significant difference in  $\mu$ -rhythm power can be seen in all three subjects.

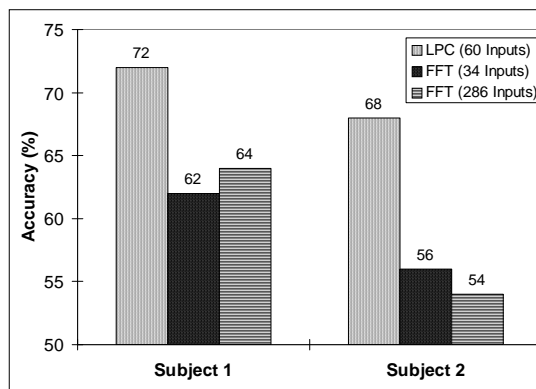

**Figure 4** An  $\mu$ -rhythm Mean Power Spectral Density for three subjects thinking UP and DOWN.

#### 3.2 Off-line Analysis

Using thresholds set by the operator in the feedback loop, limits the consistency of the system, since it depends on the ability of the operator to detect patterns in the EEG power, and correctly adjust the feedback parameters. In our initial attempt to optimize real-time classification of two patterns, Linear Predictive Coding (LPC) and Fast Fourier Transform (FFT) were evaluated as feature extraction methods. The features extracted from the data recorded in the calibration process (static training) were classified by Adaptive Logic Network (ALN) [4]. We used one second intervals of EEG signal from leads C3 and C4 and 95% overlap to generate the training and test sets. Subject 1, who had two EEG recordings during our equipment testing phase, was recorded for 150 seconds for each class. Subject 2, who had no previous EEG recordings, was recorded for 200 seconds for each class. The first 80% of the recorded data for each class was selected for training, while the rest was reserved for evaluation.

#### 3.3 FFT Method



**Figure 5** Classification comparison between LPC and FFT generated inputs for two subjects.

Each one-second window sampled at 200 Hz was multiplied by a Hanning window and padded with zeroes to the appropriate size in order to get the desired frequency resolution, before the spectrum was calculated. Seventeen sub-bands between 6 and 14.5 Hz were generated for each lead resulting in frequency resolution of approximately 0.5 Hz per point. For the two leads, this resulted in a total of 34 parameters as inputs to the classifier. We also explored finer frequency resolution and wider frequency range by taking 143 sub-bands, for each lead, between 5 and 40 Hz resulting in frequency resolution of approximately 0.25 Hz per point. We investigated different frequency ranges and resolutions, however the best test results obtained were 64% and 58 % for subject 1 and 2 respectively.

#### 3.4 LPC Method

Each one-second window of unprocessed EEG signal was used to calculate the LPC coefficients using the Burg's method for covariance estimation.

These coefficients were then used as inputs to the ALN classifier to discriminate between the two classes. We found that taking 30 linear coefficients for each lead gave consistent results in both subjects. We obtained 72% accuracy for subject 1 and 68% for subject 2, which is an increase of almost 10% in performance for both subjects as compared to the FFT method.

#### 4 Discussion and Conclusions

The analysis performed on the initial recordings verified our experimental setup, and showed that our subjects can learn how to modulate consciously their EEG signals without any prior training. Fig. 2 displays a noticeable difference in averaged  $\mu$ -rhythm power for two different mental tasks. In Fig. 3, the same difference is displayed for four central and parietal leads in a different way showing the concentration of higher amplitudes for the UP task, and a concentration of low amplitudes for the DOWN task. The operator-assisted feedback was based on setting the thresholds, using data similar to those in Fig. 3. We discovered that the method implementing operator-controlled thresholds has two important limitations. The first limitation is that expertise necessary to set the thresholds may not be available due to lack of adequate training, and inconsistency in human performance. The second limitation is that even if the required expertise was available, the use of thresholds constrains the control function to its discrete form.

We have also demonstrated that a noticeable difference in task-related averaged power of  $\mu$ -rhythm can be detected in multiple subjects. As it is shown in Fig. 4, all three subjects were able to determine mental tasks which gave a noticeable contrast in  $\mu$ -rhythm power during the first two training sessions. However, it can also be seen that the standard error for two out of three subjects is comparable in size with corresponding mean values. As a result, the classification of the two tasks has relatively low performance. We expect that high standard error of the mean power can be reduced through training. With training, subjects can learn to stay better focused throughout the experiment, to act faster and to reduce the variation in their  $\mu$ -rhythm power.

Off-line, we used an adaptive classifier (ALN) to discriminate between UP and DOWN EEG instances. FFT and LPC methods for feature extraction were compared for two subjects. As shown in Fig. 5, we got 72% accuracy with LPC and 64% accuracy with FFT, in our more experienced subject. LPC seems to be the better alternative for extracting features characteristic for UP-DOWN pattern discrimination, however more tests should be done to make any definite conclusions.

There are still many problems in this field that have to be solved in order to be able to design a reliable and flexible brain-computer interface. Training of new subjects is still too long, two-dimensional cursor control is in its initial phase and precise positioning of the cursor has yet to be

achieved. In addition, controlling the cursor movements and position while performing other mental tasks is of crucial importance for practical application in order to ensure that a subject can use his or her EEG control interface for functional tasks. Data reported qualitatively by Wolpaw and McFarland [5] about well-trained users, who can control the cursor while carrying on casual conversation or while performing mental arithmetic problems and giving the answers, are very promising. It also remains unclear whether persons with severe disabilities will be able to generate EEG signals that can be discriminated in the same way as for control subjects.

We foresee several possible ways of improving the accuracy in our experiments:

- (6) Training our subjects to modulate their EEG signals more consistently;
- (7) Exploring other feature extraction methods other than FFT and LPC,
- (8) Exploring other classifiers such as Learning Vector Quantizer,
- (9) Exploring EEG signals from other electrode locations.

In our future work we will research various methods of configuring spatio-temporal and frequency characteristics into feature vectors, and evaluate various machine learning techniques for automatic pattern recognition and classification of EEG signals. We will also test this technique on a larger number of non-disabled and disabled subjects.

**Acknowledgments.** This study was supported by the Canadian NSERC and Research Grants Program of the Glenrose Rehabilitation Hospital. The authors also wish to thank Dr. Zoltan Koles of the University of Alberta for contributing EEG-monitoring equipment for this experiment. The authors wish to thank Dendronic Decisions Ltd. for ALN software and support.

#### References

- [1] J.R. Wolpaw, D. McFarland, G.W. Neat, and C.A. Forneris, An EEG-based brain-computer interface for cursor control, *EEG Clin. Neurophysiol.* 78 (1991), pp. 252-259.
- [2] W.N. Kuhlman, Functional topography of the human  $\mu$ -rhythm, *EEG Clin. Neurophysiol.* 44 (1978), pp. 83-93.
- [3] H.H. Jasper, The Ten-Twenty Electrode System of the International Federation in Electroencephalography and Clinical Neurophysiology, *EEG Clin. Neurophysiol.* 10 (1958), pp. 371-375.
- [4] W. W. Armstrong and M. Thomas, Adaptive logic networks, in *Handbook of Neural Computation*, (Oxford University Press, New York 1996).
- [5] J.R. Wolpaw and D.J. McFarland, Development of an EEG-based brain-computer interface (BCI), in *Proc. RESNA 95 Annual Conference* (1995), pp. 645-648.



## THE SCIENTIFIC MODEL OF THE MYSTICAL FOUR WORLDS

Joyce A. Kovelman

10451-1 Larwin Ave, Chatsworth, CA 91311, USA

"An evolution of consciousness is the central motive of terrestrial existence... A change of consciousness is the major fact of the next evolutionary transformation"  
(Aurobindo)

"Evolution is an ascent towards consciousness"  
(Teilhard de Chardin)

**Abstract.** New Paradigm physicists have proposed a strikingly similar model of infinite, invisible levels, strata and parallel worlds beneath and alongside our planet. This paper presents a composite model based on the ideas of Bohm, Dyson, Everett, Herbert, Hiley, Peat, Sarfatti, Sheldrake, Wheeler, Wolf and others on the cutting edge of physics. Like Bohm, I call it "Holomovement". Notice its amazing resemblance to the composite Four Worlds of the Mystic (Jewish, Hindu, Buddhist, Sufi).

**Key words:** *mysticism vs. science, composite model, four worlds.*

### 1 Introduction

Ideas and concepts in Science, Psychology and Spirituality are beginning to complement and reaffirm one another, allowing a new perception of reality to unfold. In this regard, scientists and mystics reveal strikingly parallel ideas about hidden, unseen, dimensions that lie above, below, and beneath our physical world. This paper invites all who recognize that there is more than the readily visible, and who yearn to explore the deeper mysteries of life to integrate these ideas into a more satisfying and life-sustaining worldview.

### 2 Two Modes of Perception

There are two principle modes of perception; each bestows a different view of reality. One is rational and analytic, the other intuitive and receptive. The first allows us to survive in the physical world; the second reveals non-ordinary states of Consciousness and the world of the mystic. Rational, objective reality is understood through measurement, analysis, reasoning, and logic. It is the composite view of the left brain and the physical senses, as well as the microscopic and sub-quantum worlds uncovered through human technology. Rational Self, living and acting in the world of space-time and matter, perceives itself as separate and distinct from the rest of existence. Everything appears causally related and

predetermined. Time progressively flows from past to future, and we follow only one sequence of events from beginning to end.

The second perceptual mode is receptive and intuitive. It honors relationship, interdependence, and the unity of existence. The processes of contemplation, introspection and renunciation guide Consciousness to invisible, hidden realms and non-ordinary states of consciousness. A merging and blurring of boundaries occurs; and everything is perceived as interconnected and interrelated within the web of life. There is no separation; only wholes and relationships. Receptive-intuitive Self explores the hidden dimensions of existence, which support and give rise to our world of physicality.

### 3 Definition of Consciousness

One's definition and interpretation of "Consciousness" determines the complementarity and fit of these two models. Newtonian-Cartesian, old paradigm science insists "Consciousness is a consequence of neurophysiological processes occurring in the brain and nervous system" [1]. *Matter, not consciousness, is deemed primary.* A new "Science of Consciousness" is emerging, wherein Consciousness is described as "awake, aware, alert and attentive." This more encompassing definition invites Science's revolutionary study of inner, subjective processes and altered states of consciousness. Yet the mystic asserts that Consciousness exists necessarily: "*Consciousness, not matter, is primary* since it precedes as well as creates all matter" [1]. This paper supports the view of the mystic.

### 4 The Mystical Four Worlds

The mystic asserts that everything is mutually interconnected and interpenetrated by Spirit, and that every level feeds back to influence all other levels and realms. Hence, the Four Worlds are part of an

undivided, coordinated whole, called "Source." This concept is beautifully expressed by Wilber, "...The infinite is present in its entirety at every point of space, all of the infinite is fully present HERE" [2].

#### 4.1 World of Origination

This world emerges from a state of Non-Being; the mystical VOID, the realm of No-Thing, Non-Self and Emptiness. There is no beginning nor ending; only an eternal, timeless state occurring within each present moment. It exists always. From this dimensionless domain, time, space and matter mysteriously emerge. Non-Being is the dwelling place of an aware-ized, benevolent ENERGY which lovingly creates infinite worlds, universes of the Mind, and levels of reality for Spirit to experience and explore. Some refer to this dimension as the World of Origination and Emanation. Within this domain dwells what we understand as "God, Source, Creator, The Divine, Spirit, Shiva, Brahman, and All That Is." With unbounded trust and love, Source endlessly seeds its creativity into infinite psychic realms and universes and A Soul awakens.

#### 4.2 World of Creation

Whereas Spirit dwells in the World of Origination, Soul resides in the World of Creation. The many events and experiences that fill our lives and our everyday worlds are developed within this level. This realm hums with imagination and creativity. Soul, like Source, also creates off-spring, endowing all portions of Itself with free will and Consciousness. Soul provides us with unlimited possibilities, choices and probable events granting each personal Self opportunities to freely choose circumstances with the greatest potential for growth and fulfillment.

#### 4.3 World of Formation

Soul designs and generates multitudinous psychic blueprints, forms, archetypes, and probable events in the realm of Creation. Its messenger, Psyche, deposits and stores these forms in the World of Formation. Soul has an in-built propensity and yearning to translate its ideas and desires into an infinity of forms and patterns. Each Self freely chooses and selects only those events (s)he wishes to experience in the physical world. Soul directs, produces and orchestrates our earthly experience, and allows each Self to freely choose among an endless array of probable choices and opportunities. Soul continually encourages each of us to awaken and to become co-creators with Universe.

#### 4.4 World of Manifestation

This is the phenomenal world and realm of earthly existence. It is a dimension in which the beliefs and dreams of Consciousness are translated into events, experiences, objects and practice. Within this world, each individual consciousness freely chooses from infinite possibilities as it creates the events,

circumstances and happenings of daily life. This is the world of matter, particles, objects, and situations. The World of Manifestation is the realm of doing and thinking, of learning and applying the skills of our trade.

Upon this fourth level of Consciousness, each Self encounters the totality of thoughts, beliefs, and choices (s)he has projected and impressed upon the world of physicality. Each Self needs only to look out there, into the phenomenal world of space and time, in order to know Self. The manifest world is an outward reflection of the inner psychic levels and ground that collectively informs, enfolds and sustains each and every aspect of Self and personhood.

Essentially the Four Worlds span and form a spectrum of awareness and understanding from most subtle to most dense. Levels enfold within levels ensuring that All of Existence is a boundless unity within the sacred ground of All That Is.

#### 4.5 Variations of the Model

Most mystical traditions have their own map of these hidden, invisible and mysterious realms. For example, the Jewish mystic reveals that the ten sefirot and the Tree of Life exist in each of the Four Worlds (see Fig. 1). The Sufis speak of seven inner gardens known as the "Alam-al-mithal." Buddhists speak of the six bardos and, along with the Hindus, describe five koshas or sheaths (Fig. 2) as well as the eight vijnanas (or levels of awareness) and three states of awareness. The "Great Chain of Being" of Eastern philosophy reveals from three to an infinite number of levels of consciousness (see Fig. 3). Indeed, there is a multiplicity of Four World paradigms, each with their own language, symbols, states, structures, grades, levels, and domains of awareness.

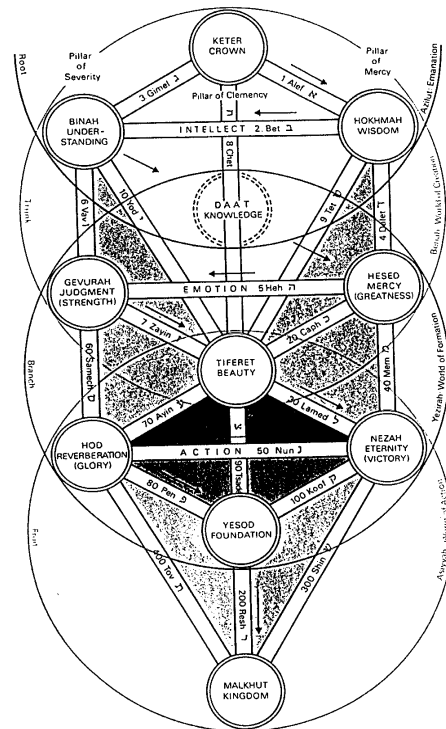

Figure 1 Tree of Life in Kabbalah [3]

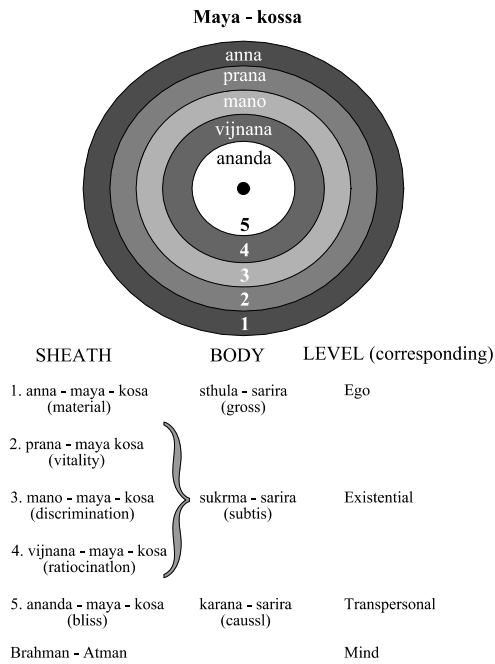

Figure 2 Five sheaths in Buddhism [4]

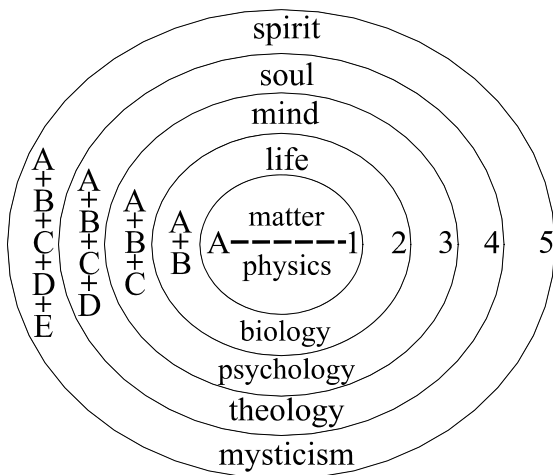

Figure 3 "Great Chain of Being" of Eastern philosophy [5]

## 5 The Scientific Version of the Four Worlds

Having explored the Four Worlds of the mystic, let us turn our attentions to the strikingly parallel model emerging from Science. Scientists seek nothing less than the quintessence of matter: the fundamental, basic unit underlying all other forms and substances. Science, like spiritual disciplines, seeks the Unity that gives rise to all life and Consciousness. Through its successful reduction of matter into increasingly smaller and finer components, Science has uncovered the intriguing world of sub-atomic particles as well as the invisible realms of "virtual" matter. Science has arrived at the portal between inner and outer worlds.

Below is my understanding of Science's emerging paradigm of the Four Worlds. It is based upon the collective ideas of Bohm, Dyson, Everett, Herbert,

Hiley, Peat, Sarfatti, Sheldrake, Wheeler, Wolf and others. Bohm described the Universe as a holomovement or single, unbroken entity in flowing motion [1].

### 5.1 Holomovement

This is a vast ocean of energy filled with Intelligence and Awareness. It creates and informs All. Holomovement resembles the mystical Void and the World of Origination. It, too, exists necessarily. Holomovement is genesis; it forms an undivided, unbroken, seamless whole in which all existence dwells and is sustained (See Tables 1 and 2).

Before the beginning, and before time, space and matter, there was but a vast sea of light, an Aware-ized, Intelligent energy. For some unknown reason, a small ripple appears upon this ground of existence. Suddenly and tumultuously, this ripple explodes into a wave pulse that brings the physical universe and all that exists into being. An infinite spectrum of orders and levels of Intelligence become manifest. All levels, orders and grades emerge from the Holomovement; It is the Originator of everything. Through the processes of involution and projection, information and meaning are enfolded into limitless levels of the Holomovement to form Super Implicate orders.

Table 1 Mystical Four Worlds

Mystical	Consciousness	Attribute
<i>Origination/</i> Emanation Non-Being Genesis	All That IS/SPIRIT	Will
<i>Creation</i> Life Themes Ideas Birth Creativity	SOUL/SELF	Intellect
<i>Formation</i> Forms, Molds Shapes, options Potential, choices Possibilities	PSYCHE	Emotion
<i>Manifestation</i> Action-events Experiences Situations objects	Self	Action

Table 2 Four Worlds of Mystic and Scientist

MYSTICAL	SCIENCE	ROLE
Origination	Holomovement	Non-Being, VOID, Ocean of Energy, Intelligence, Awareness, SOURCE
Creation	Super-Implicate	creativity, ideas, themes, information
Formation	Implicate	Patterns, forms, shapes, choices, M-fields, options, possibilities, orders of space-time
Manifestation	Explicate	Action, experiences, situations, events, objects, matter



## 5.2 Super Implicate Order

This is also an invisible realm of undivided wholeness and awareness. In this timeless dimension, multiple worlds and realities are conceived and born. Super-Implicate is a dynamic realm of formative cause. All causation takes place outside space and time, through the processes of enfoldment and unfoldment. Super Implicate designs and generates morphogenetic fields, the quantum potential, archetypes, blueprints, life-scripts, guiding principles, and the patternings of our everyday world.

## 5.3 Implicate Order

The Implicate Order is a storehouse of infinite, probable events. Here, all orders of space and time exist at once, in "potentia." An earthly observer must participate and interact with the passive Implicate order before events and objects can materialize in our physical world. In this domain, Consciousness and form interact to create all that occurs in the world of daily life.

## 5.4 Explicate Order

This is the world of time, space and materialized objects. An earthly observer invites the unfolding of a universe and allows our physical world to materialize. We, the actors, choose and initiate a particular sequence of events and actions in the Implicate, so that "we" may engage and experience it in the explicated world of space-time. The actor is both creator and participant; explication infers an audience. Hence, the phenomenal world arises from choices designed in the Super Implicate region, stored in the Implicate level, and chosen from the Explicate.

## 6 Conclusion

Presently, a more inclusive and expansive science is unfolding, one willing to study both subjective and objective views of reality. Science is discovering the interconnectivity and interdependence of all existence, and reclaiming the sacred ground of life. We are developing a compassionate science enfolding both conscious awareness and conscience. Neither Consciousness without conscience, nor conscience without consciousness works. To realize its full potential, Science must wed the two together, understanding each as part of the same unity. Without a more compassionate science, humankind will not long survive. Humanity is called forth to explore still higher levels of awareness, to know itself as a reflection of a sacred Universe, and to acknowledge its connection to the ground of all Being.

## References

- [1] J.A. Kovelman, *Once Upon ASOUL: The Story Continues... Science, Psychology and the Realms of Spirit* (Jalmar Press, Carson, CA, 1997).
- [2] K. Wilber, *Eye to Eye: The Quest for a New Paradigm* (Anchor/Doubleday, Garden City, 1983), p. 298.
- [3] Z'ev Ben Shimon Halevi, *Kabbalah: Tradition of hidden knowledge* (Thames and Hudson, New York, 1991), p. 40.
- [4] K. Wilber, *The Spectrum of Consciousness*, 20th Anniversary Edition (Quest Books, Wheaton, Ill., 1993), p. 164.
- [5] K. Wilber, ed., *Quantum Question* (Shambhala, Boston, MA, 1985), p. 15.

## A ROBOT'S "PHILOSOPHY OF MIND": THE MONISM VERSUS THE DUALISM IN A ROBOT'S "WORLD-VIEW"

### (A Boolean Algebra of Existing Phenomena as a Simulation of the Classical Philosophical Ontology)

Vladimir O. Lobovikov

The Liberal Arts University of Ekaterinburg, Studencheskaya St. 19, Ekaterinburg, 620049, Russia

**Abstract.** The paper is devoted to investigating a possibility of simulating a person's philosophy of mind by means of a robot's «one». The «autonomous» robots with elements of «Artificial Intelligence» are implied. The indispensability of developing such a simulation is discussed. The abstract talk is supported by the systematic analysis of a concrete example: a specific variant of a «materialist-minded» robot. Creating the relevant software for such a robot could be realized only on the basis of an appropriate mathematical simulation of the philosophical ontology. Therefore, the author presents a Boolean algebra of existing phenomena as a simulation of the classical (i.e. two-valued) philosophical ontology. Unary and binary ontological operations are defined by a table. A set of relevant definitions is attached. The author presents arguments supporting his guess that by means of this algebraic simulation of ontological forms of existing phenomena, it is possible to construct not a dualistic but a monistic «philosophical world-view» for «autonomous» robots with «AI». Shortcomings of this algebraic simulation of the system of properly ontological concepts (of consciousness, matter, nature, practice, cognition, speech act, the World as a whole, etc.) are discussed and possibilities of overcoming these shortcomings in future (by inventing non-classical ontology systems for «more sophisticated» robots) are indicated.

**Key words:** *ontology, phenomenon, form, existence, consciousness, real world, dualism, monism, robot, simulation.*

It is an empirical fact that the formal logic does exist and does have an important value for the development of human culture. According to the tradition, (formal) logic, as the theory of truth, is a specific kind of philosophy. There are other specific kinds of philosophy as well: ontology, ethics, aesthetics, etc. By an analogy with the *formal* logic, there could be also a *formal* ontology [1], a *formal* ethics [2], a *formal* aesthetics [3], etc. What for could they emerge and grow? If their existence is actually justified, then their fundamental generalization, namely, a formal philosophy (the unspecified one) could be justified as well. Why does the formal philosophy (abstracted from the specific kinds of it) make sense? What can be a potential practical use of it?

I guess that constructing robots with "Artificial Intelligence" could be one of the most impressive fields of applying the formal philosophy in general and its specific kinds in particular. According to dominant doctrines of modern philosophy, science and technology, robots (even the "clever" ones) *can not* have *content* thinking, *content* behaving, *content* apprising or joking and, in general, *content* philosophizing (content world-attituding). Hence, developing formal logic of thinking, formal ethics of behaving, and, in general, formal philosophy of world-attituding is *indispensable* for making "clever" robots able to *simulate* the appropriate *forms* of logical thought, socially acceptable conduct, etc. of human beings. The formal philosophy is a *necessary* means for "humanizing" robot activities. Mankind *have* either to develop the formal philosophy and apply it to "intellectual" robots, or to quit with making robots more and more "intellectual" and mighty. Otherwise Mankind can encounter very bad consequences in future.

The above presents a general argument. If it is accepted, then constructors of "intellectual" robots have to supply their creatures with a kind of "philosophy of mind". Does that or this phenomenon exist only in the "robot's mind", but not in the real world? The ability to generate adequate answers for such questions is *essential* for a robot's effective and safe operations in the "outer world" and in the "inner world" of the robot's "mind". Constructors of robots must supply their creatures with *formal* criteria for existence of phenomena. By means of these *formal* criteria robots are to be able to detect phenomena really existing in the material world, on the one hand, and phenomena existing only in one's mind, on the other hand. Unsufficiently separating these two kinds of phenomena could result in a robot's illusion of real existence (in the outer material world) of a phenomena, which, in fact, exist exclusively in the robot's "mind". This illusion of a robot could cause bad consequences. Hence, a robot should be supplied with some system, which protects from such illusions. The *applied* research, aimed at creating this system of protection, has to be based upon the *formal* ontology

research as a specific kind of *abstract theoretic* investigations in sphere of philosophy.

The formal ontology is such an aspect (branch) of ontology, in which: (1) ontological *forms* of existing phenomena; (2) ontological relations among these *forms*; (3) ontological properties of these *forms* are studied. “Ontological” means “belonging to the ontology”. The ontology is a philosophical theory of *being (existence) in general*, i.e. the theory about *everything that exists*. Nowadays, in contrast to the early stages of development of science, *specific contents* of existing phenomena make up the subject-matter of a *concrete* scientific knowledge, i.e. *special* scientific disciplines, but not of a philosophy. During the long history of science, the well-known ambition of the philosophical ontology to be the theory of *concrete contents* of physical, chemical, biological and other specific phenomena, exposed its inadequateness convincingly. This resulted in the popular opinion that the progress of specialized scientific knowledge made the philosophical ontology *absolutely needless, subjectless*, i.e. having no subject-matter of *its own* investigation. According to the above mentioned opinion, the philosophical ontology is not able to survive in competition with special scientific disciplines and, hence, philosophy has to leave completely the realm of ontology to be occupied totally by concrete sciences. Consequently, according to that opinion, rational contents of philosophy are reduced to logic and epistemology: everything, what falls out from this reduced domain, is considered as a “speculative philosophy of nature” in the *negative* meaning.

However, this too quick conclusion of the common-sense people is not correct theoretically. Obviously, existing phenomena do have concrete contents, which make up the subject-matter of corresponding special scientific disciplines, but not of a philosophy. However, in addition to this, the existing phenomena have also *forms*. Forms of their being are different (not homogeneous). The form of existence of phenomena has many aspects and levels. The *ontological form* is one of important aspects of the form of existence of phenomena. The proper philosopher-ontologist must reduce his research to an investigation (1) of properties of *ontological forms* of existing phenomena and (2) of relations among *ontological forms* of existing phenomena. The research of the proper philosopher-ontologist must be *intentionally abstracted from specific contents* of existing phenomena. Thus, the philosophical ontology is not absolutely subjectless. *Its own* subject-matter is made up by *ontological forms* of existing phenomena. Its fundamental method is the *method of deliberate abstraction from specific contents* of phenomena under investigation. In this meaning, any rational philosophical ontology is a *formal ontology*. Just *formal* ! A content(ual) ontology, i.e. an ontology of specific contents of existing phenomena, could be rationally understood only as the whole system of

concrete scientific disciplines. The main goal of the philosophical (= formal) ontology is to give a *criterion of existence* (or non-existence) *of the relation of formal-ontological entailment* (i.e. of formal-ontological implication) among existing phenomena. This could be understood properly only if some explication of the concept “an ontological form of existing phenomena” is given. To make this concept more clear, a Boolean algebra of existing phenomena is considered below as a simulation of the classical (i.e. two-valued) philosophical ontology.

Let  $E$  be the set of existing phenomena, i.e., for every  $a$ ,  $a$  belongs to  $E$ , if and only if  $a$  exists. According to the *classical* (i.e. *two-valued*) philosophical ontology, every  $a$  from  $E$  has one and only one of the two ontological values: (1) “...exists in the world of *consciousness*”; (2) “...exists in the *material world*”. Let  $m$  and  $c$  stand for “...belongs to the *material world*” and “...belongs to the world of *consciousness*”, respectively. There are classical philosophical ontology views, according to which, for every  $a$  and  $b$  from  $E$ , the following philosophical ontology functions are adequately defined by the below table.

	a	b	Na	Cab	Kab	Aab
1	m	m	c	m	m	m
2	m	c	c	c	c	m
3	c	m	m	m	c	m
4	c	c	m	m	c	c

The unary ontological operation  $Na$  is nothing but the representation of  $a$  in the ontologically opposite world. In particular, if  $a$  is a material object, then  $Na$  is the reflection (perception or understanding, etc.) of  $a$ . The epistemological distinction between the truth and the falsity does not matter here and, hence, deliberately, it is not taken into account at all: the abstraction from this distinction is accepted. According to the table,  $Na$  is such that: if  $a$  is a material phenomenon, then  $Na$  is an image of  $a$  in a consciousness; if  $a$  is an image, belonging to a consciousness, then  $Na$  is just that material phenomenon, which is reflected by  $a$ .

The symbol  $Cab$  stands for the “ontological implication” (or “transformation”): the existence of  $a$  ontologically entails the existence of  $b$ . In the row #1 of the table,  $Cab$  is a process of *nature* and, hence, it exists in the material world. In the row #2,  $Cab$  is a process of *cognition*, which, obviously, exists in a consciousness. In the row #3,  $Cab$  is a process of *practice*. The practical realization of ideas takes place in the material world. In the row #4,  $Cab$  is a *speech* act. Speech acts exist in the material world as they are material operations with material signs of ideas.

It is obvious, that the above table is debatable from viewpoints of many philosophical doctrines and paradigms. It is not acceptable, for example, from the point of view of the *idealistic* theories of *practice* and

from the viewpoint of the *idealistic* (for instance, *intuitivistic*) theories of *language*, speech and thought. In this relation, it is important to emphasize that the Boolean algebra of philosophical ontology under discussion in the present paper is not a simulation of philosophical ontology in general (as a whole), but a simulation of *one* of the ontological world-view systems created by Mankind during its long history. Namely, the algebraic simulation under review is a simulation of materialistic ontology. Moreover, this simulation represents not the materialistic ontology in general (as a whole), but only a specific variant (kind) of it (as the materialism is not absolutely homogeneous, but is compounded of different views). Evidently, the specific variant (kind) of formal materialistic ontology under investigation may be criticized by representatives of opposite philosophical doctrines and paradigms. Nevertheless, this specific variant has the right to exist (and to undergo development) in the history (and theory) of philosophy. Therefore, the algebraic simulation of this specific kind of materialism is interesting *at least theoretically*. From my personal viewpoint, it is truth-like that theoretically developing and practically using this algebraic simulation of formal ontology could make it possible in future to construct a *simulation* of a *not dualistic, but monistic* variant of “philosophical (ontological) world-attitude” for relatively “autonomous and intellectual” robots.

The scientific (theoretic) value of the above constructed simulation of formal philosophical ontology is not reduced to the problems discussed above. The algebra of the classical (i.e. two-valued) ontology presented in this paper, gives a possibility of a *new* vision of the old philosophical problem of *universalia*. Let  $D$  be a set of existing phenomena  $\{a_1, a_2, \dots, a_N\}$ , i.e. a subset of the above mentioned set  $E$ . Let  $Px$  is a property, defined on the set  $D$ . Let the symbolic expression  $UxPx$  stand for such a phenomenon (called a *universalis*), which is a *universal* (i.e. existing for *all* elements from  $D$ ) property  $Px$ . Medieval philosophers were substantially engaged in discussing the question “Do universalia exist in the real world, or they exist only in a person’s consciousness?” During the long discussion about this important ontological question (which was alleged by some thinkers as a “purely scholastic” one, possessing no practical value at all), some philosophers proclaimed that *all* universalia are *real* (i.e., for *every* set  $D$ , and for *every* property  $Px$ , any phenomenon, possessing the ontological form  $UxPx$ , acquires the ontological value  $m$ ). Another group of philosophers affirmed that all universalia are *not real* (i.e. for every  $D$  and  $Px$ , any phenomenon, possessing the ontological form  $UxPx$ , acquires the ontological value  $c$ ). From the viewpoint of the algebra of classical ontology, both above described metaphysical concepts of universalia are metaphysical extremes, which are not concrete and, therefore, not adequate. According to the Boolean algebra of ontology, *some* universalia

are real, and *some* (other) universalia are not real. An answer to the question “Are universalia real?” should be *concrete*, as *it depends* upon the concrete situation *essentially*. The formal criterion of reality of universalia is defined in the algebra of classical ontology as follows. Any universalia, possessing the ontological form  $UxPx$ , are real (in relation to the set  $D$ ), if and only if the corresponding phenomena, possessing the ontological form  $KPa_1KPa_2 \dots KPa_N$ , acquire the ontological value  $m$ . Otherwise, any universalia, possessing the ontological form  $UxPx$ , do not exist in the real world (in relation to the set  $D$ ). Thus, *some* universalia (i.e. universal properties) do exist in reality. However, *some* (other) universalia exist only in one’s mind.

Let the symbolic expression  $ExPx$  stand for such a phenomenon [to be called “*ex(s)istentia*” or “*existence*”], which is nothing but the existence (among the elements of  $D$ ) of some (at least one) phenomenon  $a$  such that it (the phenomenon  $a$ ) possesses the property  $Px$ . Does the existentia  $ExPx$  belong to the real external world or to one’s consciousness? From the viewpoint of Boolean algebra of ontology, both (1) the philosophy of the *absolute identity* of being and consciousness, and (2) the philosophy of the *absolute opposition* (mutual exclusion) of existence and consciousness, are metaphysical extremes, which are not concrete and, therefore, not adequate. In the light of the algebra of ontology under consideration, it is easy to see that *some* existences are real and *some* (other) ones are not real. An answer to the question “Is the existence of a phenomenon  $a$ , which (phenomenon  $a$ ) has the property  $Px$ , real?” should be *concrete*, as *it depends* upon the concrete situation *substantially*. The formal criterion of reality of existence is defined in the algebra of classical ontology as follows. Any existentia, possessing the ontological form  $ExPx$ , is real (in relation to the set  $D$ ), if and only if the corresponding phenomenon, possessing the ontological form  $APa_1APa_2 \dots APa_N$ , acquires the ontological value  $m$ . Otherwise, the existentia  $ExPx$  belongs only to the sphere of consciousness.

From the *abstract theoretical* viewpoint, a proper philosopher is not absolutely (but only partly) determined to confine his creative activity completely within the scope of the *two-valued* ontology. By virtue of a «purely» theoretical fantasy, he could construct and investigate various *non-classical* ontological systems (*three-valued*, *many-valued*, *constructive*, «fuzzy», etc.). At the *properly theoretical* level of philosophizing, the process of speculative invention of different unusual ontological world-views is relatively free, not substantially bounded. Therefore, the «pure» theoretical imagination can produce «monsters», «empty» concepts, «useless» constructions as well as «strange», *but perspective* systems (promising to be fruitful under some «strange» conditions, which can take place in future). What is an *applied* value of these hypothetical non-classical formal-ontological systems

(for constructing «autonomous» robots with elements of «Artificial Intelligence», for instance)? Probably, a well-grounded and sufficiently concrete answer to this question will be given in future. Nevertheless, in my opinion, even now it seems truth-like that the *specific* ontological status of cognition of cognition («reflection of reflection») is *not precisely, but roughly* (approximately) represented in the two-valued ontology. For the sake of *simplicity* of the ontological world-view, the classical (i.e. two-valued) ontology deliberately accepts the *abstraction* from the specificity of the ontological status of self-reflection of cognition. Aspiring to have more precise definition of the specific ontological status of the cognitive self-reflection leads to constructing *many-valued* formal-ontological systems. On the one hand, they will be significantly *more complicated* but, on the other hand, they will represent much *more precisely* fine differences among ontological qualities of phenomena existing in the World, in which cognition of cognition is not an exotic, but a usual event. The *formal-ontological law of the excluded third* (either the matter, or its «reflection», i.e. the consciousness, -- any third ontological value is excluded) and also the *formal-ontological equivalence*  $[(N(Na))=a]$  will continue to be valid only in the particular (namely, in the classical) cases, but not in general definitions of future non-classical ontological systems. I guess that some of these non-classical systems could be applied for making ontological world-views of «intellectual» robots more and more sophisticated and adequate.

The above presented Boolean algebra of existing phenomena gives a possibility of a new attitude to the old philosophical problem of the conflict between the monism and the dualism in a world-view of a person. One may object that robots are not persons and, hence, they do not have a world-view. Consequently, as to the robots, there is no problem at all. However, in response to this objection, it is possible to object that «autonomous» robots with «Artificial Intelligence» are *simulations* of persons and, hence, it is truth-like that a really «autonomous and intellectual» robot have to have a *simulation* of a world-view. Consequently, the robot has to meet with the monism-dualism problem and simulate its solution in some way.

Within the framework of the above defined algebra of the classical philosophical ontology, it is evident that, if a robot is a simulation of a materialist, then the robot could be a monist, if «the whole World» is defined as the phenomenon possessing the following ontological form:  $KAa_1Na_1KAa_2Na_2\dots$  where  $a_i$  stands for an existing phenomenon. In this simulation, it is obvious, that the World, as a whole, is material, though it contains phenomena, which are not material. However, within the framework of the Boolean algebra of existing phenomena, it is also evident that, if a robot is a simulation of an idealist, then the robot could be a monist as well, if the whole World is defined as the phenomenon possessing the following

ontological form:  $AKa_1Na_1AKa_2Na_2\dots$  where  $a_i$  stands for an existing phenomenon. If this definition of the World is accepted, then, in the simulation under review, it is obvious, that the world, as a whole, is immaterial though it contains phenomena, which are material.

Thus, the conjunction of the following two sentences: «Existing phenomena possess *one and only one of the two* opposite ontological values (either *m* or *c*).»; «There are phenomena, which have *different* ontological values.» presents *not necessarily* a dualism, but possibly a monism. Recognizing, that this conjunction is true, is not logically equivalent to affirming that the World is absolutely split into the two absolutely separated Sub-Worlds. As, according to the above given table and definitions of the World, the split of the World is not absolute, the above mentioned conjunction could be consistently combined with a philosophical monism. Which monism (idealistic or materialistic) takes place? Answering this question depends essentially upon choosing the definition of the notion «the World as a whole».

The simulation under discussion does not mean that the basis for the dualism is crashed absolutely. The dualism could survive either by rejecting both definitions (given above) of the World as a whole, or by rejecting some (may be all) aspects of the above presented table, or in some other way. Thus, the algebraic simulation does not «close forever» the «eternal» philosophical theme «the monism versus the dualism», but elevates this problem to the substantially new level of development. This new level may be interesting for both the abstract theoretical philosophy of mind and the applied investigation of «autonomous» robots with elements of «Artificial Intelligence».

## References

- [1] V.O. Lobovikov, About a usage of formalization methods for an explication of fragments of philosophic knowledge, in P.P.Chupin, ed., *Dialectics, Logic and Methodology of Science* (The Urals Univ. Press, Sverdlovsk, 1977), pp. 100-112.
- [2] V.O. Lobovikov, *Artificial Intelligence, Formal Ethics and Moral-Legal Choice* (The Urals Univ. Press, Sverdlovsk, 1988).
- [3] V.O. Lobovikov, Could computers and logic software be used in philosophy of art?, *Philosophy Today* (The Newsletter of the society for applied philosophy) 21 (1996), pp. 3-4. See also V.O. Lobovikov, *An Unknown Formal Aesthetics of the Well-known Classicism in the Fine Arts: A Substantially New Approach to Simulation of Properly Aesthetic Structures* (The Institute of Philosophy and Law of the Academy of Sciences, Sverdlovsk, 1991).

## PUNCTUM SALIENS: TORUS AS A MODEL OF BIOLOGICAL CONSCIOUSNESS

Lidija Matija

IHS Fullerenes Science and Technology Center, Batajnički put 23, 11080 Belgrade, Yugoslavia

*The Universe is a built on a plan the profound symmetry of which is somehow present in the inner structure of our intellect*  
(Paul Valery)

**Abstract:** In this paper the link between information physics, which represents synthesis of classical physics, quantum physics and deterministic chaos, and “Qi” entity through catastrophe theory is given. A model of consciousness, based on vibrational-rotational modes of torus, is proposed. Through bioinformation processes and the new material, fullerene  $C_{60}$ , the significance of golden mean properties of this model is shown. A possible application and realization of proposed model in a spirit of artificial intelligence is pointed out.

**Key words:** consciousness, deterministic chaos, catastrophe theory, “Qi” entity,  $\aleph_0$ -transfinite numbers, control, dimensions, golden mean,  $C_{60}$  molecule.

### 1 Introduction

From ancient times, consciousness was intriguing concept for all human civilizations. This fact is a consequence of human aspiring to explain his way of thinking, visions, dreams, some “paranormal” events, fears of death and life. Searching for an explanation started from the old legends through the East and the West religions, probably because of fact that the phenomenon of consciousness was too mystical for science for a long time. In the very recent time consciousness has become one of the fundamental subjects of serious scientific research, because of the new technological development demanding a new approach in biological information processing and better understanding of a higher mental functions of the human brain. One of the new disciplines which has arisen in the last five years is information physics [1]. This new discipline can satisfy serious requests in the understanding of consciousness. Information physics is based on the concept of physical point (punctum saliens) which generates the golden mean as a fundamental law of the Nature.

### 2 Catastrophe Theory and “Qi”

In the very beginning of human existence on the Earth, the Nature and the people were in absolute harmony. An ancient Chinese would said that all was

“Qi” entity (consciousness as triad set), and George Cantor probably would have said that it was the third set of  $\aleph_0$  ( $\aleph_0$ -the transfinite cardinal number). In one moment something happened in the Universe and this harmony ( $3^{\aleph_0} = c$ ) was disordered and “Qi” ideogram becomes distorted (triad set become 1+2) while  $\aleph_0$  shared up into ordinal (1, 2, 3, 4, ...,  $n$ ) and transfinite cardinal numbers ( $2^{\aleph_0} = c$ ). If we discuss about consciousness as a dynamic system we can conclude that a large change in a such system happened. The theory, which has been successful in describing such phenomena is catastrophe theory [2]. A catastrophe is a large change in a dynamic system caused by small changes in the parameter space that the system depends on. What really happened nobody knows yet, but according to information physics the problem is caused by dimension  $N=1$ , which has no corresponding pair (Table 1 in [1]) and can be solved through unification dimensions  $N=0$  and  $N=1$  [1,3]. Bearing in the mind that ordinary reality ( $N=3$ ), objectified by the methods of measuring space, time and matter, is a subrealm of a larger reality ( $N=0$ , absolute reality), and if we take in account Table 1a in [1] we can see that this larger reality is hyperdimensional. The proof for that opinion is physicists attempting to unify all the physical forces in to a unified theory [4].

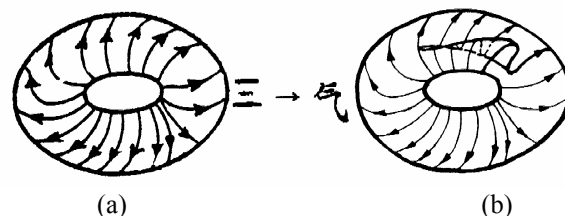

**Figure 1** (a) A Torus as a model of the first biological consciousness (Qi entity before distortion) [3], and (b) Reorganization of the first biological consciousness on the torus surface (Qi entity today) [3]

We should not be surprised to see that this unification of all the forces is the strong correspondence to consciousness and that the unified

theory provides a basis for a “spectrum” of states of consciousness [4]. According to this assumptions we can observe dimension  $N = 0$  as a unique field of all the forces, which represent the deep emptiness similar to the Chinese Tao, but at the same time  $N = 0$  generate the physical point (unit sphere  $V_0=C_0=0!=1$  [1]) from which can be created everything similar to the Chinese Qi. Indeed, a long time ago, God, the Nature and the living beings (continuum) lived in harmony, and biological consciousness (and “Qi” entity) was represented as in Fig. 1(a) [3], but something initiate splitting and ruined this harmony. We can explain this splitting as an appearance of the catastrophe cusp, and the first biological consciousness reorganized (Fig. 1(b)) and from the entirety with the parts directly connected, it becomes the entirety consisting of the parts with indirect connections [3]. That is the reason for “Qi” ( $N=0$ ) distortions from  $3^{N_0} = c$ , which is God, into one distorted line which represents humans (dimension  $N = 3$ ) and two parallel lines, which is still God, but is fuzzy for the humans (dimension  $N = [(-2)_5]$ , mental world), while  $3^{N_0}$  becomes  $2^{N_0} = c$  (the set of transfinite cardinal numbers) and  $1, 2, 3, \dots, n$  (the set of ordinal numbers). With the aim of understanding consciousness, we proposed earlier [3] the tours as a model which can be used either for explaining bioinformation processes or artificial intelligence and satisfy all our assumptions.

### 3 Deterministic Chaos and Golden Mean

We can also explain this model of consciousness from the deterministic chaos point of view. A torus derived from stable physical point ( $N = 0$ ) into unstable point, which can rotate and generate dimension  $N = 1$ . Because of dissipation, this rotational system creates orthogonal vibrational system which represents 1D torus as a quasi 3D object, so we can conclude that whole rotational-vibrational (dynamical) system has two independent frequencies [3]. Ruelle, Takens and Newhouse show [5] that appearing of oscillations on two independent frequencies (quasi-periodic system) is enough to cause system transitions to chaos in following order: fixed-point  $\rightarrow$  limit circle  $\rightarrow$  2 - torus  $\rightarrow$  strange attractor. Described transition into the chaos is known as the Ruelle-Takens transition based on Hopff bifurcations. This concept of Chaos is easiest to observe in quasi-periodic windows, which are the biggest near golden mean. This fact is important because Hausdorff dimension of the Cantor triad set (strange attractor for  $N = 0$ ) has the same value (0.6180339...) [1], so we can see that dimension  $N = 1$  and  $N = 0$  are in indirect way, through the resonance phenomena connected. It is noteworthy to say that the golden mean hides self-similarities itself, and contains the seeds of chaos [6]. From the other side our model of consciousness, a

torus with catastrophe named cusp on its surface, could be explained as a system with the Ruelle-Takens (the quasi-periodic) transition to the deterministic chaos which includes 2/3 of the torus surface, and Feigenbaum [5] transition to the chaos, which includes 1/3 of the torus surface (a catastrophe cusp). This means that on the one third (1/3) of surface we have Ikeda mapping (Fig. 2) which is caused by fork bifurcation.

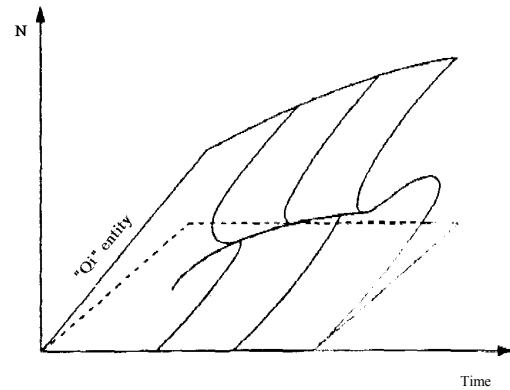

**Figure 2** The fixed-point surface (mode  $N$  in this case) of Ikeda mapping in function of control parameters (time and “Qi” in our case).

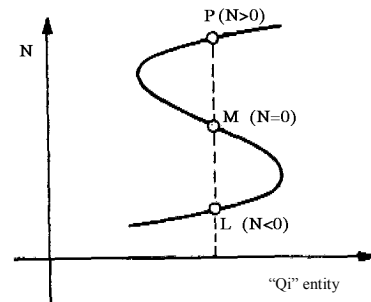

**Figure 3** The hysteresis clue of Ikeda mapping. In our case  $M$  is dimension  $N = 0$  (the unstable branch), while  $P$  and  $L$  represents dimensions  $N > 0$  and  $N < 0$  (stable branches).

This mapping occurred when the system after one input, gave two (or more) outputs (Fig. 3), therefore, we have a variety of results. It is noteworthy to notice that in our case, dimension  $N = 0$  has its corresponding pairs in Table 1 in [1], or more exactly it induces a variety of dimensions (similar to the states of consciousness). Based on all these facts we can say that our model of consciousness represents a nonlinear self-oscillating system.

### 4 Control

From the control point of view biological information processes can be represented as follows: (1) molecular level (DNA, proteins, microtubules, water) can be described by Boolean spaces and logic (Figs. 4a and 4b), because they are quasi  $N=1$  entities with information realization through  $N = 0$ ; (2) organization of neurons and their synergy

biochemical-biophysical interaction on synapses can be represented by fuzzy logic and neural networks; and (3) brain as a compacted system with all its processes can be explained by aleph ( $\aleph_0$ ) logic which is connected with higher multi-dimensional fuzzy spaces. This is a consequence of creative-physical features of object (brain), so we should establish in the near future a new concept of the automatic control, which might be named as aleph control.

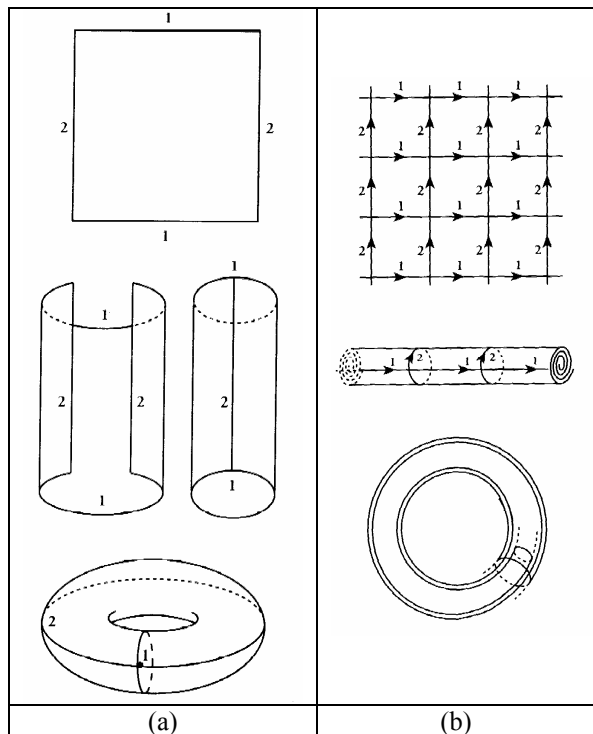

**Figure 4** (a) A torus can be derived from a square by connecting up the sides labeled 2, and then the sides labeled 1. Note that all corners of the square become a single point of the torus [4]; (b) A torus can be derived from lattice on a plane by rolling the plane an infinity of times in one direction so that an infinite tube (of circumference equal to the lattice spacing 2) is produced. Then wrap the tube an infinity of times around a circle of circumference equal to the lattice spacing 1 [4].

To develop an aleph control technical system is a promising approach. The appearance of molecule  $C_{60}$  encourages us in such assumptions. Fullerene  $C_{60}$  has the same shape and symmetry properties as clathrin in brain and crystallizes around the physical point ( $N=0$ ), with pure vacuum (emptiness) inside the cage.

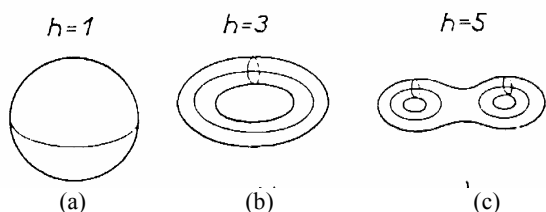

**Figure 5** Euler's surfaces and models of consciousness: (a) The Universe, (b) The Biological and (c) The Machines.

The phenomena of crystallization around the point is explained by Euler theorem of connected surfaces and random Cantor triad set [7]. Euler's theorem of connected surfaces is given by  $T+S+I=3-h$  relation, where  $T$  represents the number of tops,  $S$  is the number of sides, and  $I$  is the number of edges, while  $h$  represents ordinal number and coordinate to every class of polyhedrons. The connection between proposed model and process of molecule  $C_{60}$  formation is shown in Fig. 5. Based on this molecule, with Golden Mean structure and energy properties, and by the physics and chemistry of Fullerenes, it will be possible to build self-assembly systems. Thereby it will be also possible to test the biological models of consciousness, such as proposed model of torus, and use them as sub-systems of "artificial brain" - by adopting the information physics principles from living matter.

## 5 Discussion

To propose a realistic model of consciousness, we find that it is necessary to include catastrophe theory, deterministic chaos, Cantor's triad set and transfinite numbers, ancient eastern science, besides information physics that is established earlier [1]. The model of torus together with entity "Qi", can explain genesis information brake down genesis, from  $N=0$  (godly) to  $N=3$  (human). It is obvious, that the ancient people had some knowledge about these facts, bearing in the mind that in Sumerian epos, Gilgamesh is 1/3 human and 2/3 God. From the other side according to Egyptian legend, when Isis collected the separate pieces of Osiris (who was killed and separated into 14 pieces) into one part, she "fanned the cold clay with her wings" with golden mean properties, and Osiris in inverse, invisible world [8]. Through this link between mythology and the modern science, the human society might find out a way to connect its godly (bioinformation processes-sub-consciousness) with consciousness. It is well known, that difference and similarity between all living beings depend primarily on order and activity of four bases of DNA. This system of four bases (genetic code) determinate order of amino acids which create proteins, while these twenty amino acids can be classified as system of three and two, which can be written as 3/2 [9]. This ratio represents golden mean, because the limit of the all golden numbers (Fibonacci polynomials) is 3/2 [10]. However, as we know, dimensionality of dimension  $N=0$  is 3/2. Because of the central role that symmetry plays in the unified field theory, and the biological information processes (DNA, microtubules, clathrin, water), it is necessary to emphasize, that all this research is based on the Golden mean symmetry law which means that the proposed model could be realized by new material (fullerene  $C_{60}$ ) and using feedback amplifiers with a specific feedback network (they have similar functions to this of Ikeda mapping) [11].



## 6 Conclusion

Bearing in the mind what is presented in [1,3], and in this paper, we can conclude that “Qi” entity is a structural-energetic-information entity. The unit sphere (the physical point with  $N = 0$  dimension), whose value is  $3/2$ , represents self-consciousness, while positive dimensions represent consciousness, and “negative” are sub-consciousness, and they are in correspondence through dimension  $N = 0$ . Dimension  $N = 1$  which is unpaired in dimension system (Table 1 [1]), destabilizes the physical point (unit sphere with dimension  $N = 0$ ) through rotational-vibrational oscillations, and induces interruption of information flow (the catastrophe of the “cusp” type) between the positive and the negative dimensions (consciousness and sub-consciousness), however, the “ghost” of dimension  $N = 0$  remains present. The torus model could be considered as the structural-time entity, while “Qi” represents space-time entity on the torus surface. According to the model described and results given in [6], one can say that the mass and the time are the consequence of  $N = 1$  dimension “artifice” [3]. In this manner  $N = 1$  dimension emerged itself and took control of the areas that have their sources in dimension  $N = 0$  [3]. According to our research there are three main possible types of consciousness: Universe (sphere;  $h = 1$ ), biological (torus;  $h = 3$ ), and technical (“pretzel”-double torus;  $h = 5$ ).

**Acknowledgments:** This research is dedicated to the memory on my father Rudolf Matija, who always supported and understood me.

## References

- [1] D. Koruga, Information physics: In Search of a Scientific Basis of Consciousness, in D. Raković and D. Koruga, eds., *Consciousness: Scientific Challenge of the 21<sup>st</sup> Century* (ECPD, Belgrade, 1995).
- [2] R. Thom, *Structural Stability and Morphogenesis: An Outline a General Theory of Models* (W. A. Benjamin, 1975).
- [3] L. Matija, Punctum saliens: A model of consciousness based on vibrational-rotational modes of a torus, in Lj. Rakić, D. Raković, Dj. Koruga, and A. Marjanović, eds., *Consciousness: Scientific Challenge of the 21<sup>st</sup> Century*, (Proc. ECPD Seminar, Belgrade, 1996), in Serbian.
- [4] J. Mishlove, *The Roots of Consciousness* (Council Oak Books, Tulsa, Oklahoma, 1993), Appendix.
- [5] M.R. Belić, *The Deterministic Chaos* (The Physic Science Volumes, No. 3, Belgrade, 1990), in Serbian.
- [6] M. Schroeder, *Fractals, Chaos, Power Laws: Minutes from an Infinite Paradise* (W.H. Freeman and Company, New York, 1990), Ch. 1.
- [7] L. Matija, *Contribution to Development of the Control System of Fullerenes Syntheses*, M. Sc. Thesis, University of Belgrade, Belgrade, 1995, in Serbian.
- [8] Dj. Koruga, S. Hameroff, J. Withers, R. Loutfy, and M. Sundareshan, *Fullerene C<sub>60</sub>: History, Physics, Nanobiology, Nanotechnology* (Elsevier Science Publishers B. V., Amsterdam, 1993), Ch. 2.
- [9] D. Koruga et. al., New classification of protein amino acids by  $3/2$  mode, *Archive of Oncology* 5(3) (1997), pp. 30-32.
- [10] G.A. Moore, *The Limit of the Golden Numbers is  $3/2$* , The Fibonacci Quarterly, USA, June-July (1994), pp. 211-217.
- [11] V. Biró, *Nonlinear Oscillations in Feedback Systems* (Akadémiai Kiadó, Budapest, 1985), Ch. 3.

**FORM, LIGHT AND CONSCIOUSNESS:  
EACH GENESIS STARTS FROM A STRUCTURE  
AND REACHES A STRUCTURE  
- EACH STRUCTURE HAS ITS GENESIS**

Lidija Mišić

Faculty of Applied Arts, Belgrade, Yugoslavia

**Abstract.** The paper "Form, Light and Consciousness" deals with the interpretation of meaning and messages of forms in stone at the archeological find Lepenski Vir, discovered in 1967. The Lepenski Vir culture belongs to the Neolithic between 7,000 and 6,000 BC. Our perception of sculptures in stone and their forms touches upon our deepest layers of consciousness. By analysing analogous representations from the history of art associated with the regions of the Mediterranean civilizations, the relation of ideas and of spiritual traditions of these civilizations are unveiled. The source and nucleus of these ideas is found at Lepenski Vir. Also, Lepenski Vir is the peak of a long experience, where knowledge, sign, letter, number, and the word that nominates knowledge are simultaneously structured. Architecture, which is the matrix of knowledge, is reflected in the spiritual evolution of succeeding civilizations. Knowledge structured at Lepenski Vir originates from pure cosmic consciousness. It is the basis of the development that engendered a whole series of great civilizations. The secret of knowledge, which the Orpheans kept, is in direct relation with knowledge established at Lepenski Vir.

**Key words:** *Form, Light, Consciousness, Lepenski Vir, Stone, Cosmos, Eye-Oklo, Omfalos, Eye-mirrorstone-Ocilo, Stone-mortar-Ocilo, Fire-keeper stone-Pretnik, Ancestor-Predak, Hor-Oro-Falkon, As-Ja, Structured, Cosmic Laws.*

These are Jean Piaget's two essential statements, in the *Origin of Knowledge*.

At the present level of knowledge man verifies and explores consciousness through a accumulated knowledge from different fields, which are separated from one another within their closed systems. The cognitive approach, either philosophical or scientifically pragmatic, includes consciousness implying someone who keeps vigil over the cognitive process - who calculates, measures, compares, concludes. The more man progresses in the cognition of the world, the more distant he is from the state of consciousness which in itself preserves the memory of itself - he preserves the unity of both the observer and the world in the germ of his own phenomenon. Today we accept the knowledge of several states of consciousness: the state of being awake, of sleeping, of the dream and of cosmic consciousness as the fourth state.

This means that consciousness is a wide field like the whole human experience.

The most elementary *Forms of consciousness* accepted by man as his possibility to communicate (to present knowledge) are symbols, signs, numbers and words, mathematical forms, which for a long time have been the property of all and by means of which we exchange knowledge, compare and attempt to establish communication, to understand.

Explaining consciousness we use forms which we do not disassemble, which are widely accepted. In search of deeper layers of consciousness we necessarily, unavoidably end up with understanding the interconnection of knowledge both as regards duration in time and its spacial expansion. Whenever history, which mainly records the conqueror's campaigns, evades us, we witness spiritual migrations, migrations of knowledge. These fruitful migrations can be followed up in artistic forms, myths, beliefs.

The aim of consciousness is to understand, to look and to see.

On account of this understanding originate forms such as the word, sign - letter, form in stone, drawing on the rock, city, voice and music.

In order to understand these creations of spirit we use our own experience, which is more or less acquired by education.

The more we know the more we can compare, can understand better. Forms in stone are accessible to everybody's understanding. Therefore stone forms from older, more ancient cultures lead us into the transcending state of consciousness. Secret knowledge of spiritual transfer was usually linked with stone. The transaction of consciousness, the exit from one's individual ego, the resurrection into the cosmic consciousness was also linked with stone. In Greek culture in Apollo's temples the consecrated could see the *Egg-shaped* stone. Apollo's priestesses among whom Pythias, by means of such a stone, established communication with the Divine Powers. Also the egg-shaped stone, which at both ends was reduced to a sickle, was carried in the processions of Samothracian mysteries. In the 11th century the consecrated family of the keeper of the Holy Grail gathered around the stone on which omens and messages appeared.

The Merovingians thus read the names of their kings.

In front of this silent witness, consciousness is in transcending state, leaving its usual way of functioning, the small shell of consciousness of one's ego and is in contact with its primeval source. At this level of consciousness deeper understanding is established. As each level of consciousness has its structure, and each structure its genesis, we shall attempt to understand the fascination of Apollo's consecrated priests as well as the Merovingians, since the same knowledge is involved. Where is its source?

For this period of knowledge one needs surprise at the unknown and initiation. The culture of Lepenski Vir, the beginning of which is dated to 6,000. B.C. after the post glacial period, represented a great shock for all of us in 1968. The shock in front of the unknown. "The initial stone for me was the stone from House No 37 and House No 24 of unknown purpose" as archeologist Dr. Srejović said in his opening words in the catalogue of the exhibition in 1968.

The stone is of ellipsoidal shape with two channels at the two opposite endings. The rim is emphasized with an engrossment whereas on the inner side it is grooved, so that in the middle it might evenly circularly go up. In the middle there is a recess in the shape of the pupil of the eye. The surface is smoothly finished and forms a complete cone. The stone is harder and of a better quality than others, as if it were chiselled out of a large flint. The surface finish seems to be almost completely preserved. This stone possesses a special beauty. The reduction to an ellipsoid, the even finish as well as the groove in the pure circle make it exceptional. Very soon it will start spinning its story. The first impression is *that it is an eye* and you are surprised at the power of pure geometry. It is similar to the motion of Earth around the Sun in the middle; it resembles *the watching eye into whose pupil the seen is impressed*.

In the history of art it resembles the representation of *Osiris's Eye*. The side channels indicate that its aim was practical, usable. The lower part of the stone is well-rounded and in this part *Urezi*, snake-like signs are incised, (incisions, ophis). It had no fixed base, so that it was possible to move it from a place.

In Vuk Karadžić's *Dictionary* we read that the entry *eye* in addition to *sight* means the *inflow* of a lake, on grafts of cut vine the *eye* is the place where the shoot will sprout, so that it is also called the *navel*. If we suppose that this eye is the inflow of light, then we can conclude that it served to determine the noon of the star, the projection of the star, not only of the day star, but also of the night one. If filled with water, the "Midnight Sun" could be caught.

The second meaning of the word *eye* in the Serbian language is the navel (the place where the vine-shoot will sprout). *It means that in the very word eye there is also the navel*.

The key places on the Earth in Egyptian civilization were marked with *Omphaloi* (omphalos -

the navel of the Earth). These are places where the cosmic powers are expressed. Apollo's stone was also called Omphalos.

It was an introduction into another level of consciousness. This stone named in the Serbian language possessed all the intricacy necessary for penetrating into another concept of the world.

Further search for the lights of stars which were being assessed led me into recognizing Lepenski Vir House as *the projection of the Constellation Swan - Sigunis*. It is a constellation of the north hemisphere, it is in the Milky Way - one of its stars is Sigini 11,000 light years remote from the Earth. The constellation in its middle has a regular arrangement of stars in the form of the Cross made up of five stars, while the center of the cross observed from our regions has the shape of an *Arch*.

On account of the firm arrangement of stars visible with a naked eye from the Earth, its arrangement of stars serves, to these days, for the measurement of sky maps, as a measure.

It appears in the East and travels westward.

The fifth star, which forms a cross towards the western side, is best visible when in the focus of the eye, when the *phenomenon of doubling* takes place, which is the best sign that it is in our eye focus.

On July 7, 1991 the Swan was most southern in its orbit. At 11:30 p.m. above Belgrade the Fifth Star was in the focus of the eye, the best sign that it was above our heads. Its trapezoid shape as regards the arch was identical to the base of the Lepenski Vir House, namely to House No 37.

The eastern star of the cross has remained outside the base of the house. If we make a semi-circle form the arch to this star, we shall obtain the representation of a ship with sails that are the base of the house.

In the epic about Gilgamesh there is the Heaven's house and the Maagnam ship sailing the current waters. In Indian philosophy the Ganges is equalized with the Milky way. The Istar is also called the Paradise River in our medieval texts.

Our first conclusion is that the oldest building undertaking of man was the building of the Heaven's house on Earth.

It originated as every first class planimetric assignment. Thus for us every discussion about the *origin of architecture* becomes ignorance of the origin of knowledge. In the Serbian language there is also the word *Ocilo* (eye-mirror stone) a derivative meaning the mirror in which the eye is reflected. There is no doubt that the stone is the mirror of the All seeing Eye, the inflow, ophis, eye-mirror.

Ocilo - the eye-mirror stone - is linked to fire, fire is made with the eye-mirror stone, its synonym is ognjilo, fire-maker flint.

The grooves on its side have their function.

In the middle of the Lepenski Vir House is the hearth, which is its central part and at first sight the only aim of the house seems to be to enclose the hearth. The hearth *has the shape of man*. The head is

towards northwest, beside it is the stone we named ocilo, eye-mirror stone, while the upper part, the torso with the abdomen, is the fireplace. In front of the fireplace is the well-rounded stone with a recess in the middle.

In this country there are still hearths in the mountainous areas of Hercegovina, Crna Gora, on Mount Tara in highlanders' houses, in the mountainous regions of Serbia. In front of the hearth is the *stone-mortar* called *Pretnik, fire-keeper*. We say even today: "They deserted their century-old hearths."

On the fire-keeper stone during the Christmas holiday "Badnjak" the oak-trunk with the leaves is placed on the hearth. The embers that remain for Christmas from the oak-leaved trunk (sacrificial tree) are kept up throughout the year - not to let the fire go out.

*Zapreti* the fire means to put out the fire. The word *Preti* means to keep, preserve. *Preti* looks like *Pretci - Preci*, which means ancestors. *Preti* means to preserve in a sheltered place. We still pronounce "poštanski pretinac" – post office box. Although the logic of our language says that the word *Predak* is the nominative, and in the plural, due to palatalisation, it is *Preci*, we may conclude that the plural form is the return to the source pronunciation, as well as to the source meaning.

Every return preserves its source meaning.

Beside the hearth is buried the Ancestor, who around himself has a diminished trapeze-like base of the house. He is in the cross-legged position (yoga position) while his pelvis is wide open to the sky. On the other side are grave-yards in which the dead were buried in the haunched position with knees gathered, known as the fetus position. Whoever knows the position of the newly-born baby knows of the position of the widened hips and crossed lower legs. The initial position of the contented newly-born. This means that there is a distinction between the born and the unborn. What sort of birth is in question if dealing with the bones of the deceased? The conclusion is inevitable, namely that it involves the people who during their life-time either deserved or did not deserve *cosmic birth*. Those who during their life-time were fortunate enough to reach cosmic consciousness - knowledge accessible only to the enlightened - *the illuminated*, which they passed down to their offspring. The first dish where this knowledge was preserved was the pelvis of such an ancestor. Here we are at the very source of the two words *Pretmik* (fire-keeper stone) and *Predak* (ancestor). This source of the words reaches the very transcendental point leading to cosmic spaces and knowledge which is proof enough that the Lepenski Vir man was both knowledgeable and our original ancestor, because to these days we are heirs to and users of the word which springs directly from the thigh of this enlightened ancestor, to whom was revealed knowledge that is the source of human life and of the divine in the human.

Rishi - devata - chandas is the trinity of knowledge in the Vedas.

Rishi is the knowledgeable - devata is the process and necessary actions - chandas is the realization of rishi, pure knowledge, enlightenment and dedication.

The stone - pretnik - the fire-keeper is the symbol which the stone takes over, standing for the ancestor's thighs. Here we are at the source of *symbolic representation and formation of the symbolic representation*.

The stone in all myths stands for cosmos, the stars.

Once again we are faced with knowledge of the equality of the material, phenomenal form of the universe.

The offspring of ancestors, who performs the ritual of rekindling and keeping up the fire is the knowledgeable. Originating from the thigh of his ancestor, he is equal to him, and possessing his knowledge he passes it down to his offsprings.

The Ritual and Knowledge of the Act lead him into the *religious take-over* received by his offsprings.

At the same place the *knowledgeable* turns into the *craftsman*, who shapes and impresses knowledge into the form that he creates.

We still know the name of this form. Naming the form is by itself a privileged act.

The discovery of the search for the source of words once again leads us to the oldest source - the Vedas.

Here is a citation from the hymn of the consecrated word (Voja Đurić, translation published in 1979):

"I am the one that gives birth to Father at the top of the world.

My origin is in the waters of the ocean. From there I spread over all beings and touch the sky itself with the nape of my skull."

*Oko - Oci* is reflected in the eye - *Ocilo - ot oci - Otac*.

If there were no rhyme "I touch the heaven with the nape of my skull", we would leave out the knowledgeable who names the word, who is in the ocean, in the boundless silence - the united field "from where he spreads over all beings".

Devata is the act of performing the inter-action of the performer of rishi, who looks at the appearance from the ocean, expects it. He knows its phases, he tries to catch the moment of its appearance - action from silence. He knows its rhythm, catches it into the net of causality. And then in the eye is reflected the light of naming *Ot Otc* names *Oca* (our *Father*) at the top of the world.

*The pattern is established*, order knowledge, Chandras.

Rishi enters Samhuta, the residence of all things. "With the nape of his skull he touches Heaven itself".

The unified field is the eternal ocean - *Live Water* - the field of all possibilities. In it are contained all times.

From the hymn "I am the one that blows like the wind taking all existences - beyond the other side of

the heaven - beyond the other side of the Earth - such is my greatness".

To enter the maelstrom of words is equal to joining the abyss for the one who has no faith in the Teacher, Ravi, Guru.

"Thanks to my mercy he eats the food of the one who recognizes, who breathes, who hears the uttered word."

The position of the "ancestor" in his small heavenly house is a known position to these days of "the one that breathes", who practices yoga-banding, or of the ascetic monk who with yoke and prayer reaches asceticism. Enlightenment.

Round the hearth in House No 24 the signs, triangles are tidily arranged. They are made from stone red tiles. They are built vertically up the hearth forming a frieze. Some are with a longer side of a closed equal-sided triangle, open and closed at two thirds of the sides. It looks like counting. What? Time?

In this way the Dogons in their anthropologically petrified knowledge recorded Sirius' phases, a triangle for every 20 years. Every sixty years the big cycle ended. The Sudanese tribe, the Dogons, have preserved the primeval knowledge of the constellation of Sirius. The French anthropologists recorded them in their study carried out from 1946 to 1954. They recorded all their rituals as well as their knowledge. Also the knowledge of the White Dwarf, a star of great weight, photographed by the astronomers only in 1970. Marcel Griaule and Germaine Dieterlen published this knowledge with a series of their studies. One of their summaries is in Robert Temple's book "Sirius's Mystery" (1976).

If the Lepenski Vir House was built as the projected Heaven's house of the constellation Swan, and the hearth was for the fire to be used, the fire-keeper stone for the fire to be kept, then the purpose of the Stone, which I recognized as Ocilo - the eye-mirror stone, which served to measure Ocista - the projected points, is not exhausted. The outlets at the end of the ellipse lead us to believe that Fire can be kindled in it.

The kindling of Heaven's fire is not only a useful act, but enables knowledge to be *redefined*.

Between the constellation of Canis Major the Greater Dog with the central star Sirius and the constellation Cygnus - Swan, there is a perpetual mystic intertwining.

In the constellation Swan there is Horus, Isis's son. Isis is the star Sirius itself. Osiris identifies himself as the smallest star of great weight, with an ellipsoidal route around Sirius.

The smallest star of great weight is the *Axis* of the world, it keeps the Solar system in rhythm and accord with the Sirius system.

For the first time we introduce the constellation Swan into this family thanks to the Lepenski Vir House. So far the mythological matrix did not recognize itself in it.

When we leave out the place where the sacrificial-fire-keeper stone is situated there is still the Falcon in the sky, always above our heads, the *Falcon or ORO*.

If we draw the cross, at the top is the Falcon's head, the *Allseeing Eye*.

In Egyptian mythology Horus, Isis's son was born after Osiris's death. He was born on water. Horus is the soul-measurer and is connected with the Maagnum boat on board of which the souls of the dead (ancestors) travel. In the earliest Egyptian mythology, Horus determined the four points of the World.

Sirius as the largest sun measures the time of our Solar system. Sixty years are needed for the Solar system to complete together with our Earth one Cosmic Day. The smallest star of Sirius's constellation, the White Dwarf, Sirius B (in the Dogons - Digiteria -Sirak) completes its rotation along the elliptical orbit in the course of fifty years. Wallis Budge in his *Egyptian Religion* concludes: "Osiris is a star of great weight" - Shonu means great weight like Chant. Chentery, chenty is weight, but it is also a long beam that links two sides.

Shenit is the circle, Osiris's divine palace, while Chens are two circles.

Chenti is the weight, but also the beam that links two sides.

*Osiris's orbit would denote a field of great weight.* The united field of these two constellations and the solar system.

"And on the roof the fire is burning." Osiris is also designated as great hardness, marrow, adamant, which would approximately designate the hardness of a diamond. The fire burning on the roof of Osiris's palace could explain why the orbit of the invisible dwarf was visible and measured even in the primeval past of man's history.

The stone at Lepenski Vir that we called oko (eye), ocilo (eye-mirror stone) had a definite function. It was used to mark the night position of stars in order to find out the days. Sveti Vid (Holy Sight) in Slav mythology is the god of light, reality, knowledge.

Osiris is the source of wisdom. Or the field of all possibilities as the Vedic and contemporary scholar Maha-Rishi explains, the united field, a concept from contemporary physics.

During burning heats when Sirius is at noon and the White Dwarf is also in its zenith Holy Fires set in. The Holy Bush of yellow heath can set fire to itself.

Ocilo (the eye-mirror stone) served to wait for the Day when the cycle is over in order to take Heaven's fire to be kept in the fire-keeper stone.

In the sky there is the *cross*, in the house *ocilo* (eye-mirror stone) and *pretmik* (the fire-keeper stone).

This would also help explain the two strange channels in the corners of the stone.

The Holy Fire was taken to all houses as God's gift.

The ancient religion of the Serbs is the religion of the Three Sun God, the confirmation of the Heaven's fire.

We still carry our cross, our eye-mirror stones are our fire-keeper stones, while the holy circle is the pupil of the Holy Sight, the Allseeing God. Our heavenly Father.

We spring from Oci. The word pretnik contains predak, the words oko and ocilo - Otac. In House No 24 beside the signs in the form of triangle, a lower jaw is inserted. It is placed upside down, with the triangle form and a red plate built in the middle.

The jaw in the neutral position produces a sound, the phoneme /a/. *We have the sign* and the phoneme.

These signs beside the hearth, which we proved to measure time, were used by Radivoje Pešić, palaeolinguist, in his study "The Vinča Writing" to reconstruct all 48 signs of the Proto-writing of the Lepenski Vir culture. From this writing the linear writing and the Vinča alphabet originated.

*Ast* is the name of Isis in the Egyptian hieroglyphic writing.

*As* or *Az* is both the first letter of the Serbian alphabet and personal pronoun of the 1st person.

In the Vedas it denotes the creative divine principle.

Everything is at the same place. *I, Who Know* of you, *Light*, am equal to you and belong to you and exist with you. All in one word *As*.

In Sanskrit the personal pronoun of the first person is *he*, whereas *I* is the third person.

*As* or *Ast* does not belong to the Egyptian language. This is what the Egyptologists say, not knowing where it came from. Plutarch also claims that Isis's name is older than the texts in which it was recorded (4,000-3,000 B.C.). Isis represents the star Sirius, its cosmic sign is the *Triangle* with a star and a semi-ball.

*At Lepenski Vir knowledge is structure but*

*What is up is also down.*

*Life on earth is given as a gift from heaven, consciousness is structured under cosmic laws.*

*The remote cosmic dwarf has the same intervals as my consciousness.*

*Our relation is eternal: it keeps flowing undisturbed like the soma, but only in the deep layer of consciousness.*

In the monumental round pebbles - sculptures from Lepenski Vir, which sometimes have the appearance of man or woman, knowledge is recorded as well. Knowledge of birth and life. On the sculpture called the "Water Fairy", knowledge of genetics was recorded. The first rule of the development of the embryo begins with the doubling of the cell, then the chain of four is developed and when the chain of eight cells is set up, life begins. This very statement was recorded on the sculpture. On the left-hand side of the central chain of two cells is the sign three, namely three incisions downwards, on the right-hand side, two ones upwards. Three is the masculine number, two the feminine. As early as the Sumerians there was the mythical story of *Oanes*, whereas the Dogons called the watery being *Nomoa*. Obviously the myth was

spreading quickly and so was knowledge with it. It should be noted that the Dogons claimed that before migrating to Ghana and Guinea they used to live in the Mediterranean and that they used to be guides to the *Argonauts*.

It is easy to suppose that the inhabitants of Lepenski Vir knew that the smallest grain of millet (*Sirak* - a word we still use, while our folk literature possesses ample material on *Sirak*) will give a nutritious seed. By exposing the seeds in dishes to the rays from Sirius B when they are the most efficient reaching the Values of Strings - *Ark* or *Ars* is the word used by Egyptians to explain how Osiris binds. *Ark* means both banding and rope.

The dish in the shape of the big belly of a pregnant woman is with a modelled hand served not only as a storage for wheat, but also for the germination of wheat soaked in the shallow mud of the Istar. To be a fisherman means knowledge of the Moon, its phases and of its influence on the behavior of the fish. The observation of the behavior of fish by moonlight is a complete experimental institute. The round pebbles were taken from the near-by river. In such clean and clear rivers wool used to be washed. Such places were called *Sere* (from Vuk Karadzic's *Dictionary*). The water fairy was called *Sierene* by the Greeks, and Sirius was *Sieros*. From the fleece various seeds were gathered. It took a long time to be selected - the favorable climatic conditions of the post-glacial period suited them. At Lepenski Vir the fauna changed, the *Oak* arrived.

The region of the Sumerians, Babylon, receives knowledge, but the myth excels and covers the unrepeatable and original relationship of the Lepenski Vir man with the *Source* of knowledge. This relationship is the subject of all secret learning.

*Omphalos* served in orphic rituals for the restructuring of the origin of knowledge.

At *Seras* the myth of the *Golden Fleece* was born.

In Herodotus there is a piece of information given to him by the Thracians that "on the other side of Istria lives a large tribe - *Sigini* covering the area as far as Veneto in the north of the Adriatic". The Thracians told him that they were great bee-raisers.

On account of this datum we can be convinced that the Lepenski Vir House, projected as the *Sigini Constellation*, had initiated many others covering the whole region of the central part of the Balkans, even toward the north.

Led by the idea that the eye-mirror stone and the primeval *omphalos*, by means of which geodetic centers and sanctuaries lasting for centuries even under changeable conditions of living were determined, I connected all the known sanctuaries on the map. But I began with one unknown to Herodotus.

The place is Crveni Otok called *Sera* in antiquity, in the vicinity of which is the submerged town *Rusa-Rusino*, the river was also submerged, although now it is an undercurrent river with subterranean confluence at Zlatni Rt. As early as the 2nd century in the island lived the *Eremites*, an Early Christian order. In the

island there is a relief which in its triangle has the Sun's disc with birds. It is supposed to have been above the entrance to the small church and it looks like Early Romanic style. If this is an omphalos, then it will be the 10th part of the Egyptian Behdet. Greece only confirmed Dodona as a sanctuary. In the 6th century the sarcophagus with Saint Euphemia born in Chalcedony was brought to it under strange circumstances. In Constantinople she had her church. Faced with threatened dominance, Byzantium fortified its western sanctuaries. On an old map of Greek seafarers in the vicinity is the port *Orhophalos*. In Herodotus (2nd book 111) there is mention of the destruction of both the town and the sanctuary of the goddess Hathor after the pharaoh Sesustris. The town *Eritrebol* (red soil) is designated as an unknown place. Saint Euphemia was carried to a hill by the small white cows. The myth is established.

*Sera* is a cult place where wool was washed, God's gift received. Dyeing with red color in red clay was natural. The oldest Balkan cult is the dyeing of wool with red color. It meant devotion to Sun's Divinity.

It means that *Sera*, the Red Island near Rovinj, is an ancient geodetic point where oracles were being held. *St. Euphemia's red-letter day* is September 16 at the time of the equinox. St. Simeon, the ascetic monk whose hermit well was in the Sinai desert is celebrated on September 14. This is when the Eastern counting of years begins. The Orthodox counting of red-letter days. Farther geodetic points are Dodona, Eja (Fazita) (at its confluence Isis was born), Behdet (the central part of the confluence of the Nile is the nil Egyptian fraction). The trapezium at the bank of the Black Sea, linked to Eja, forms the tip of the trapeze. In order to obtain the drawing of the projected constellation, Dodona and Belgrade had to be on the route. Thera took up the place of the 7th star. Thera is the strongpoint of Sirius. In this way the picture of the Constellation beginning its next cycle was obtained. The drawing on the map was identical to the drawing in Robert Temple's book. When Belgrade is linked with Eja and Igumenica with Eja, in the middle of the line of the triangle *Tep Ulaz* "entrance to the big house" is formed. This happens in Kosovo field. *Kos* in Serbian means marrow.

The middle of the triangle of the longer line is Mljet. It is the island Circe, in Serbian *Jejina*. Ija is the white cow that according to the Greek myth was expelled to Egypt. *Jejina* and *Seja* were the initial names for Nephtis and Sostis, Isis's and Eja's companions. The area IJE is the area Hathor. The project of Sirius's house was drawn in 1977.

In *The Egyptian religion* W. Budge (p. 90) writes: "In the old days there was also the God called *Horus* whose symbol was the falcon, the only living creature adored by the Egyptians. *Horus* like *Ra* was the god Sun... Initially with one of Horus's features four gods of the principal points were linked, or "four Horus's spirits", which carried Heaven on four of his angles, representing North, East, South and West. And further, the Goddess Hathor, namely "*Horus's house*" was the part of Heaven where the Sun came out and

went down. The manuscripts are from the 4th and 3rd millennium."

The above-mentioned citation from Budge's book was a great incentive for me in the same way as Horus sets the Sun into motion, as Plutarch says. The enigma became knowledge when on the already drawn map with the constellation of Sirius, I added the house of *Horus*. Horus's four points. When it is known that the triangle Rovinj, Igumenica, Belgrade is the house Hater, the two others appeared by themselves, namely Zakopane in the north and Rusa on the Danube (the border of Thrace and the Skythians). In the vicinity of Zakopane in Poland there is a black and wooden church (devoted to the Virgin) from where the future was prophesied. Above the church on the highest peak of the Western Carpathians, the Poles raised a cross, as a memento to the Poles' sufferings and holocaust in World War II. In the west of the inner geometry of the Lepenski Vir House the border would be on the *Orko* river near the place *Casale*, which means a passage between the houses, then Savona and the confluence of the two Rhines and of the three rivers near *Hur*, or at the very top of St. Gothard. The ordering of the names is strange: Savona, *Orko*, *Hur*, Supreme God.

"In this way we obtained the confirmation of Herodotus' statement according to Siginj which the *Big* tribe lives on the Adriatic Coast." The cross at the top of the Western Carpathians and the Blue Crypt near Igumenica is the confirmation of the permanent vertical of the suffering. To bear one's cross, "And to be surviving in a terrible place" (Njegoš), are the two paradigms of the Serbian people.

The old Serbian religion knows the Three-Sun God

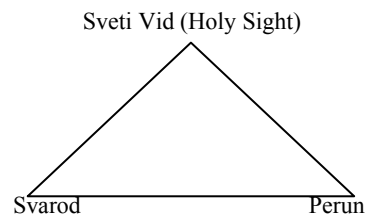

They are the manifestation of the Only God, of the Heavenly Father, the Supreme God.

The bearers of knowledge constitute three castes:

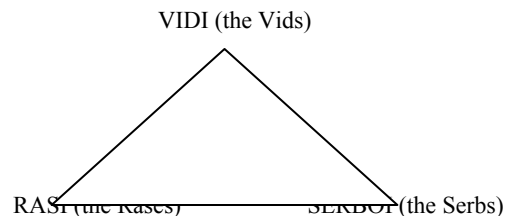

The people to whom these three castes belong are the Sers.

The *Vids* are priests, the Vidars-doctors, the Vids are those that confirm God, the keepers of holy places; also singers who with song carry the confirmation of God of justice; prophets; those that See, know.

The *Rases* are the keepers of origin and descent, of the calendar, keepers of the knowledge of past and

future times, of knowledge of sowing and harvesting. They are robed in *ras*, a cloak in the shape of a trapeze like the base of the Lepenski Vir House or the Heaven's cover, *black* is the oath of silence, *white* the oath of light measure *Pali*, they know everything about God's Mountains, because they ask, investigate the Heaven's mountains - the constellations. The first consequence of their knowledge is the square base of the Vinča House, order and introduction of system in the writing *Oro* - two cosmic circles and the Sun in the middle of *Oro-Pei*, the hymn to the Sun, in front of *Oro* goes *Dawn*.

The Vinča alphabet is coded, all the signs are incised, the language and the writing have the same sense, they are filled with meaning and radiate with knowledge.

The *Serbois* are the keepers of the *Seras* - the cult places, they always fight a battle, know everything about dyeing, feel fear and tension, that is why they are always on horseback. The Greeks called them centaurs, they were bound to the Moon's radiation with silver threads, no route was unknown to them; they firmly kept the soil and the crops with interwoven threads. In Emperor Dušan's Legal Code the *Srebrians* are said not to meet independently.

As the triangle cannot be without the circle, so the golden red color of the Sun belongs to the *Rösi* (*Ruscans*) in the same way as the cult of the Golden Fleece, the symbol of the Sun and the whole alchemy of gold and bronze, belong to the Sun's Sons (*Urias*).

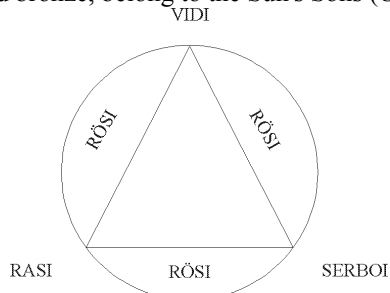

Rusa (Rubino) on the Adriatic coast and the island Sera possess a remote, archeological past. In the vicinity of Pula is the find of *Royal graves* (of unknown civilization). The size of these graves is 10 X 10 meters. Around them is a frieze on which are represented double-circled voluted vines. An *Ornament* of this kind was unknown till then. It belonged to the spirals from the Balkans, whether they were cut in clay or were curls made from bronze. Beginning with both the Starčevo and Vinča culture, this motif had its course of development. Istria is also rich in finds of this kind of spirals made from bronze material.

In the island Sera there is a women's sanctuary, similar to the place by the hearth on the matrix of the Lepenski Vir House. It is dedicated to the knowledge of woman's duties, wool washing, dyeing with red color, growing nursery holy plants, for every period a definite color and species. This is the *Holy garden on red sod*, where priestesses kept and knew the *Holy alphabet*. In the version of the Greek myth these were

the terrible Gorgons. Robert Graves, the great investigator of myth, overlooked Istria, but not Mljet. He looked for the Holy Garden among the Celts in Ireland. The Ruscans knew of the keepers of fire in circular buildings, the shepherds' *Katoons*.

A whole series of incredible coincidences:

First of all the town *Eritrebol* is an unknown place, red soil as well (Istria is a big mine of boxite clay). Then Ulysses set out from Ithaca, and in search of the Golden Fleece via Kolhidey, entered and sailed along Istria, to return, via the Sava river, to Mljet, where he spent 30 years, because of Circe - *Jejina*. He returned to Ithaca with difficulty. Ithaca is opposite Mljet. Obviously it was a plundering expedition. The *Serbois* are very militant: access to large riches, gold, silver, numerous cattle is inaccessible. On the other hand, wool was transported along the Danube and from Pula, which as early as the 3rd millennium had textile workshops. Then the origin of the *Et-Ruscans* is not known. Their writing is the greatest enigma. It is most likely that the editing of history wanted it this way. The true state of affairs was completely different.

On a silver mirror found at Etruscan Pirgos, which today is in the Hermitage, there is still the inscription: "The *Ruscans* give powerful wool to the *Sers* with love - giving *Red* colored and *Tasselled* (decorated with tassels *Re Se* - dedicated to the *Sun*) wool is presented as a gift."

*The core of the clan of ruscans is the strongest* (the most vigorous) wing of the *Sers*, *The serovinians*. "As the Sun burns and the wing is spelled *Kivo* (original meaning - energy of rising), it is implied that they are the brightest rebels and leaders of the *Ser people*."

The *Rashans* as the *Et-Ruscans* called themselves, left their writing on numerous golden plaques. All datings tend to show that these texts originated after the Greek writing.

We see that such approach cannot be maintained. These golden plaques shed new light on the Vinča, Banjica and Starčevo cultures. Radivoje Pešić informs us about it in his book *The Vinča Writing*.

*The large ship of heaven* has sailed into its port. Our ancestors keep watch on us, warn us to respect God's order and Heaven's law. Whatever we do wrongly, will come back as the stroke of Perun's lightning. Tesla entrusted to silence his greatest knowledge of cosmic energies and cosmic communications as a consistent Pythagorean, one who knows how to ask (*Pita Goru*). It was a time of the wicked and it still is.

Pythagoras from Samos brought knowledge to light, thinking that it was time to come out of the darkness. The Serbs had two crosses: The Spiritual one where the eye-mirror stones were Heaven's and The Spatial one by means of which the globe was measured. The latter is preserved on the *Seal of Saint Sava*. Projected on the map, they enable us to see where they were and what happened to them. Herodotus was right: "Scythia has the form of a square." V.101



Now we are at the spiritual cross. One should pose the question to one's inner supervisor, pure consciousness. In it everything is perfectly arranged and as clear as crystal. Long ago it obtained its *Structure*, pure knowledge was defined.

Everything else from Lepenski Vir has been inserted into knowledge which is called Historic Civilization: writing, figure, word, faith and everything about the seed.

Nemanja (Nom-an-ja) - Nominated by Heaven, dedicated the monastery Studenica to the Virgin of Digitria, of the smallest seed Sirak - Millet.

We were told this yarn by the pebble from Lepenski Vir.

## References

- [1] D. Srežović, *Lepenski Vir - A New Prehistoric Culture in Danube Area* (Beograd, 1969), in Serbian.
- [2] R. Temple, *The Sirius Mystery* (Sidgwick and Jackson, London, 1976).
- [3] Sir E.A. Wallis Budge, *Egyptian Religion* (izd. Borislav Stanic, Beograd, 1985), Serbian transl.
- [4] Herodot, *History* (Matica srpska, Novi Sad, 1968), Serbian transl.
- [5] M. Ghyka, ed., *Philosophie et mystique du nombre* (Payot, Paris, 1971).
- [6] M. Vasic, *Prehistoric Vinca* (Beograd, 1932), in Serbian.
- [7] R. Pešić, *The Vinca Writing* (Beograd, 1995), in Serbian.
- [8] G. S. Grenevich, *Etrurian Epitafs* (Moskva, 1993), in Russian.
- [9] N. Nodilo, *Old Serbian and Croat Mythology* (Split, Logos, 1981).
- [10] G. Thausing and T. Kerszt-Kratschmann eds., *Das Agyptische Totenbuch*, papyrus reinisch (Kairo, 1969).

## CONCIOUSNESS AND THE CENTER OF THE WORLD

Dragan Mojović<sup>a</sup>

Balkanska 10/II, Belgrade, Yugoslavia

*"The progress of my steps divine is space".*  
(Creator words in "The Ray of the Microcosm",  
Conto III, P.P. Njegoš)



Evolution of space: From point to 4-D space-time. (Causal structure, Light cone and consciousness)

Let the static point in the cross-section of the main world octagonals N-S and E-W be given and let the horizon of the field of vision be determined by the scope of the meditative range of environment. Then the comprehensible space is related to the point of view as a field of consciousness to its own center, so that the following equation is valid:

$$\text{world} = \text{consciousness}$$

We notice that in this way the exterior within the interior space is differentiated, from which follows the simple definition of the center of the world as *the smallest common denominator of subjective and objective space*. In fact, the center of the world (i.e. consciousness) is a unique point of totality from which by means of radiation both physical and psychic reality originates. Therefore the center of the world

(i.e. consciousness) can be transposed without a change of sense from special into symbolic, and vice versa.

First let us examine the transposition

$$\text{consciousness} \rightarrow \text{world}$$

From this direction the whole geometrical space is revealed as a field of possible projection of one's own center of consciousness. Every object, or its part, without exception, is the potential screen for the projection of the symbolic center of the subject's consciousness, so that the visible totality can be determined as a geometrical place of points equally potential in relation to the unique current point of the center of consciousness. Above the inscribed center consciousness vaults the climate of one's own newly born reality beyond which the concept of the real

<sup>a</sup> The author is a renowned Yugoslav painter of international reputation (eds: note).

disappears towards the periphery of the inscribed field of vision.

In the case of the opposite transposition

*consciousness ← world*

the center of the world actually appears by itself, in the physical sense, as the current source of the visible from which inarticulately the spring of the great gravitational space radiates. The center of the world emerges here with the strength of natural forms, which by itself possesses the power of direct suggesting the symbolic essence of centering. The élan of the evergreen vertical of the cedar, for instance, which by its serene power fills up the gushing space towards the sun, by its manifold suggestions opens up consciousness to the introjection of the center of the world into its own center.

Finally, by the simultaneous transposition

*world ⇔ consciousness*

it is revealed that the center of the world is (not) both (either) the made up construct of the mind and (or) the inevitable physical suggestion, but first of all, a reality of the highest order, the divine principle which in every point of the world resounds with the depth of eternity which is everything simultaneously in everything. With the surface of the visible it simultaneously emerges from within itself and towards itself; outside as the holy place of life-giving movement, inside as the climate of balance and harmony. Both principle and aim, alpha and omega namely embodied Logos. The logical metaphor of the center of the world and the logos-like anaphora of the center of consciousness: simultaneous descriptions of the movement of the great mind that settles in the heart of the world.

Anisotropic effect of the  $C_{60}$  (fullerene) rotation ( $3 \times 10^{10} \text{ s}^{-1}$ ) and the center of consciousness are given as a link between concepts of the four elements and the five elements.

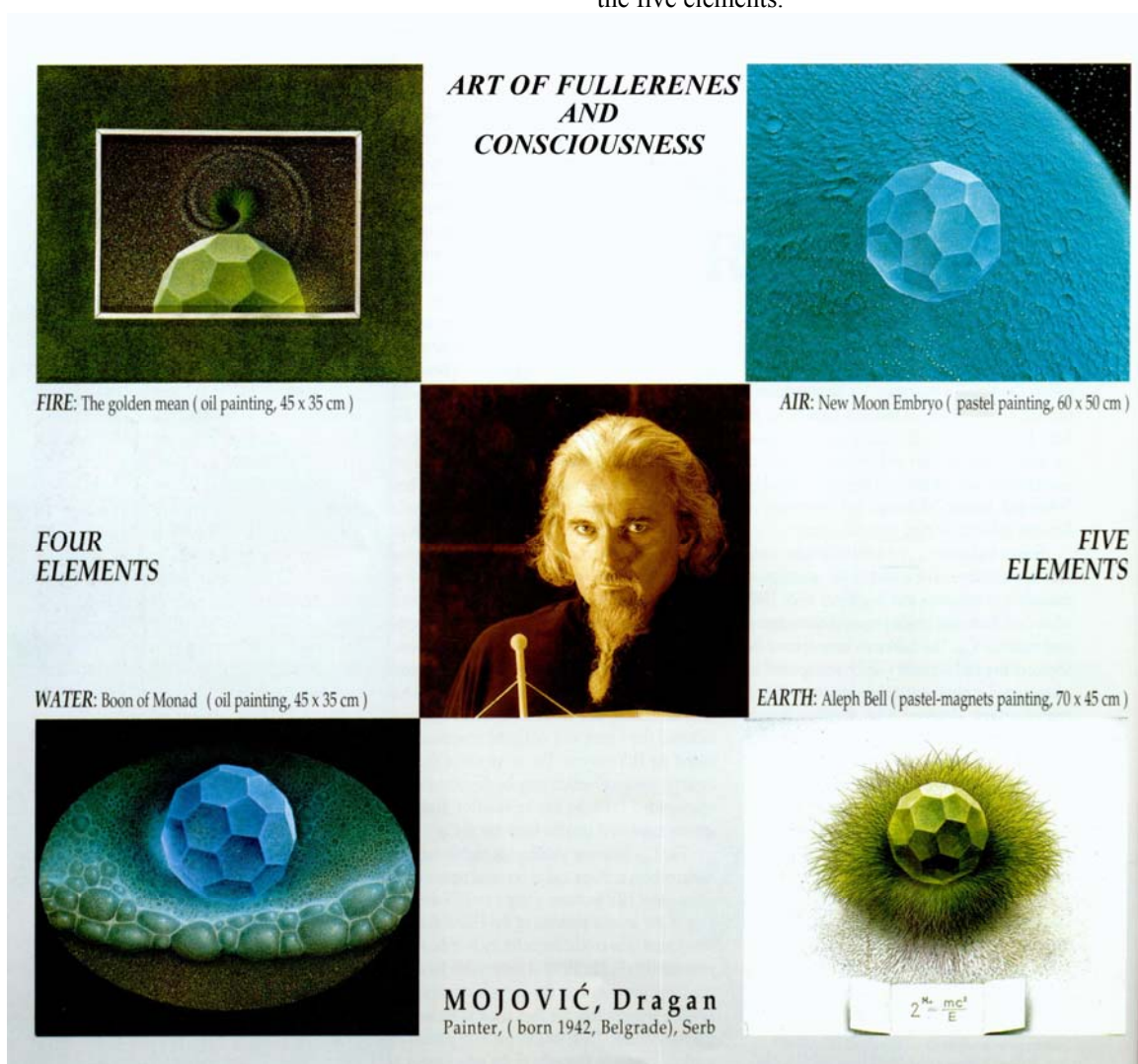

Fullerenes (molecule  $C_{60}$ ) are the third known pure crystal form of carbon in addition to diamond and graphite. According to organization of  $sp$  atomic orbitals and  $\pi$  electrons of carbon atoms in space, diamond is three dimensional (3D) carbon structure with semiconducting properties, graphite is two dimensional (2D) carbon structure with semimetallic properties, carbon nanotubes are one (1D) carbon structure with conducting and semiconducting properties, and molecule  $C_{60}$  is zero dimensional (0D) carbon structure with many interesting properties, including anisotropic effect of  $3 \times 10^{10} \text{ (s}^{-1}\text{)}$  rotation in crystal state (eds. note).

## DOLPHINS AS COTHERAPISTS FOR INDUCING CONTACT WITH CHILDREN WHO HAVE ELEMENTS OF AUTISTIC BEHAVIOR

Marija Momirov

Milentija Popovića 52, Belgrade, Yugoslavia

**Abstract.** Dolphins' abilities to follow autistic children communication system make them ideal companion therapists which was affirmed by Dolphin Program in Budva 1992 with seventeen autistic children

**Key words:** dolphins, autistic children, communication, therapeutic effects.

Seven years ago I learned about Dr. Betsy Smith and her pioneering pilot project in which dolphins facilitated therapy with autistic children and that was an idea I had had for a long period of time. Her conclusion was that the dolphins are extremely helpful in stimulating spontaneous behavior in an autistic person. During my visit to Dolphin Plus Center (Key Largo, Florida) where the project was conducted, I got a lot of advice and support from Professor Smith which was of great value for my work with dolphins.

\* \* \*

- ◆ Dolphins are sensitive to the needs of human beings with problems of a physical or psychological nature;
- ◆ Their rounded morphology, the line of their jaw associated with a smile, their smooth, warm skin, highly controlled and easy movements, tender touch, and special sounds which they produce make them ideal companion therapists;
- ◆ Their high intelligence is the key to their wide spontaneous play repertoire; and
- ◆ They initiate playful contact and produce a state of joy which is important for two reasons:
  - The joy produces an endofinergic state in which the level on endorphins increases and enables healing processes; and
  - The endofinergic state is the strongest motivation power which can produce change.

All of these four aspects lead to our general hypothesis: *Dolphins have a positive influence on the appearance and development of communications skills in autistic children who have been in direct contact with them.*

The Dolphin Program has been introduced into a more comprehensive project: *research in communication with children who have elements of autistic behavior* (1991-1992, Belgrade).

We investigated our hypothesis in Budva (Montenegro, Adriatic Coast) from June 31 – July 14, 1992. This part of the project included 17 children, 35 members of their families and a team of professionals:

two psychologists, a neurologist, a speech therapist and a pediatrician. Seven dolphins were in contact with all the members of the group in the dolphinarium Dolphins' World, owned by the Ilic family. The dolphins swam in the olympic-size swimming pool which was part of the sea just fenced with wire. Two dolphin trainers collaborated with the group whenever they were needed. The whole program was recorded on video. All members of the project had brief preparation in Belgrade (swimming lessons and basic information about dolphins).

The very important factor was that parents and professionals completed a one-year educational program about communication and autism which reinforced the effects of the Dolphin Program.

The education included:

- ◆ Developing observation abilities, and how to control our expectations of the child, observing without the influence of expectation. This helps the observation become more precise;
- ◆ How to give support to the child, at what moment and in which way;
- ◆ How to be aware of our own rhythm;
- ◆ How to be in tune with the child and to develop a common rhythm with the child.
- ◆ How to encode the specific autistic mode of communication, to translate the "autistic language";
- ◆ How to see the child's joy and contentment as the main criterion of change. Joy in communication doesn't exist in the value system of our culture and that is why it is so often neglected in therapeutic work, but joy is the main engine for producing change;
- ◆ How to focus attention on minimal changes and to value them, reinforce attention to minimal changes builds the foundation for the appearance of a big change;
- ◆ How to make goals which follow the principle of minimal changes, and how to make them clear, simple and concrete;
- ◆ How to see the world from the children's points of view, by the exercises of guided fantasizes; and
- ◆ How to make positive self-evaluations which is a condition sine qua non for the positive evaluation of the child.

\* \* \*

We worked very intensely about 12 hours per day. Twice a day we had a swimming program with the dolphins, twice a day a meeting in small groups, a large whole group meeting, analyzing the video shots, and twice a day a professionals' team meeting. This intense work and strong group cohesion helped us to maintain the high consciousness level during the two weeks.

The program was organized into two parts:

- Period of adaptation; and
- Direct contact with dolphins.

The children were not forced to make any step forward. They followed their own rhythm in moving along the continuum from the edge of the swimming pool, stepping on the platform and observing the dolphins from there, touching them sitting on the edge of the platform with their feet in the water, swimming in the water, to finally touch the dolphins in the water. The time the children spent in the water varied, they stayed in the water as long as they needed (usually from ten minutes up to half an hour).

The dolphins usually organized themselves as a group, and they communicated with children, either the whole group at once, or they took turns one by one. Among the dolphins there were five females, and two males. The older male kept the territory around the big platform, and the younger one the territory around the smaller platform. They would swim in front of humans to prevent them from leaving their territory. They showed possessive behavior, and they treated the swimmers as their possessions.

\* \* \*

There are specific rules for communication with autistic children and our experience in Dolphin Program assured us that dolphins can follow all of them perfectly.

- (1) For the beginning contact with autistic child, we should start with whatever the child offers us, and it is usually stereotypical behavior. Dolphins follow this rule spontaneously.

When a boy who had a big fear of water was standing on the edge of the swimming pool and rocking, the dolphins, usually two or three of them, used to jump in front of him in the same rhythm as his rocking. After consolidating the intoning with the boy, the dolphins would change their rhythm and the boy would stop rocking and his full attention was directed to them. After a few days the boy started to go into the water, swam with them and touched them.

- (2) Following the rhythm which the child produces is the base for contact.

A little girl, who didn't even want to look at the water, produced very strong screams from time to time. The dolphins splashed near her whenever she screamed. She started to focus her attention on them and to watch them directly.

Whenever the dolphins approach the communication zone, which is around a two-meters radius, they start to imitate the swimming pattern of the swimmer, which is their non aggressive way of saying: "Hi, I am here, I want contact with you".

- (3) The model for helping the child to develop new forms of behavior is to slowly add new elements and leave out old elements of the basic stereotypical pattern.

In our group there was a boy who, when he entered the water, immediately started to turn around himself. The dolphin would follow his pattern of movement, and then gently change the pattern into a left - right movement. The boy first stopped, then followed the dolphin's movements with his eyes, head and hands, and at the end with his whole body. The dolphin succeeded in entering the boy's stereotypical pattern and changing it without terrifying him (for an autistic child, being left without stereotypical behavior is being left with out security).

- (4) The balance between new and old elements should be kept very carefully. If old elements are kept too long, the child will shut off its contact because of boredom. Also, the child will discontinue contact if it is introduced to a large number of new elements which are frightening for it.

One boy used to go up and down of the swimming pool steps, and when his feet reached the water, the dolphin touched him. After some time the dolphin started to jump and to touch the boy's legs and back gently, like encouraging him to go deeper into the water. Whenever the dolphin touched higher points on the boy's body first the dolphin would wait for the boy's signal that everything was O.K. (the boy would turn around and look at the dolphin). Only after that signal would the dolphin continue the play.

- (5) The balance between a pause and an action is also very important for autistic children. Usually the pause they need is longer because their reactive time is prolonged.

Dolphins never remain in contact too long. They would move out of the two-meter radius, and turn back after a certain amount of time. For each child that period of pause was different.

- (6) Anything that a child offers in a situation is good enough to start a play, if we are focused on what the child does and can do.

One of girls in the group couldn't use her legs. She was sitting on the platform in her mother's lap or in the professional's lap. One particular female dolphin would come and gently mouth her legs. The girl obviously was delighted with the contact. Ten days later, we were organizing floating for the girl in the

swimming pool, and she started to move her legs very slowly. Whenever she was in the water the female dolphin would approach, mouth her legs, and start to introduce new elements of contact (for example: swimming under the girl's hand and stimulating her to use her hands and to touch the dolphin).

- (7) With autistic children there exists a stronger need to follow the play steps precisely (which dolphins do spontaneously among themselves as well).

Intoning, going into common rhythm, which is the dolphins' spontaneous reaction when they are within the two meter radius:

- Developing the game, which dolphins do by introducing new elements and new rhythm.
- Precisely define the point up to which the game is developing. Dolphins clearly signal the culmination of the game by jumping, diving, and turning sharply or by producing sounds.
- Finishing the game cycles, dolphins swim away within a diameter of 20 meters, then come back slowly into the communication zone, but do not approach the child too closely.
- Clearly define the end of the game. Dolphins go away out of the communication zone.

After the end of the game new cycles could be started.

By repeating those steps precisely, dolphins provide the children with the game through which they can learn the basic elements of communication (intoning, taking turns, communication timing, dialogue pattern...).

The dolphins are very patient, they do not give up easily, they stay and try to initiate contact for an amazing amount of time, and by doing that, they help the children overcome the motivational conflict between curiosity and fear of the unknown.

\* \* \*

Change was defined as a difference in position on the scale of contact before and after the Dolphin Program. Using this scale, every one of the adults marked every child, and we took those results where intersubjective agreement occurred..

The changes which were registered were as follows:

- The facial expression was more contented and relaxed;
- More vocalisation;
- More prolonged eye contact;
- Positive response to touch contact;
- More initiating contact;
- More interest in children of the same age;
- Less hyperactivity;
- Less stereotypical behavior;
- Wider repertoire of spontaneous expression;
- More aim-focused activities;
- Increase in the ability to imitate;
- More contact with dialogue pattern; and
- More smiling and laughter.

Four years later, according to parents and professionals' assessment, a significant amount of change is still visible.

During the Dolphin Program parents and professionals experienced a different state of consciousness. Their attention covered a much wider radius, and their observation was much more precise. They were able to register everything without being focused on anything. They showed high concentration without tiredness. They were relaxed simultaneously with vigilance, speed and high coordination. They also experienced the possibility of interspecies communication. They saw that communication between different worlds is possible if there exists willingness to step out of their own system and willingness to renounce the expectation: "Everybody has to be the same as I am." The ability to communicate is the ability to accept and understand *the difference*.

\* \* \*

The continuation of the Dolphin Program was planned to include measurement with underwater equipment. The idea of collaboration with Dr. Betsy Smith, (Florida International University), Teach Center (University of North Carolina) and with Professor Marijke Rutten Saris (Academia For Creative Therapy, Nijmegen, Holland) was interrupted up to now because of the political and economic situation.

Positive experiences in the Dolpfin Programme were significant encouragement to start a programme with horses. There is warrantable supposition that those two programmes united together would give us great therapeutic effects.

## THE CONCEPT OF THE UNCONSCIOUS / CONSCIOUS IN THE THEORIES OF CONTEMPORARY PSYCHOLOGY

Mila A. Nikolić

Institute of Psychology, University of Belgrade, Yugoslavia

**Abstract.** The aim of this work is the study of the different semantics and application of the concept of unconsciousness through the various theories of contemporary psychology and various hypotheses based on this concept. The classification of the main concept of unconsciousness begins (1) with the most important difference made between the cause and the *raison* (the level of signification and the epistemological level). This difference is seen as an empirical (neurological) or non empirical (mentalistic) hypothesis in the sense of K. Popper's distinction. (2) The second its section tries to explain a type of unconsciousness which is constitutive to a psychoanalysis and its language of description of the mental phenomena. The famous problem of "akrazia" is seen as a crucial one. (3) The following sections examine the unconsciousness in the field of the mentalistic linguistics, with the "language of thought" of Jerry Fodor and the Chomsky's and Lacan's theory. (4) An interesting group of problems understand the unconsciousness as a member of a family of the specific physiological troubled states (like dream states). (5) Then the main concept is verified as a constitutive part of the cognitive psychology and the theory of information, with the great number of good and bad (refutable and irrefutable) hypotheses to be identified. Finally, the last section tries to explain a type of unconsciousness which is crucial to the anthropological point of view and its various applications. The end of the work presents the concept of unconsciousness in its totality: in the large fields of ethics and esthetics.

**Key words:** *unconsciousness, consciousness, hypothesis, epistemological, raison, cause, neurological, akrazia.*

At the end of the 20th century, in very diverse disciplines which still in total consider themselves as Psychology, concepts that have been known a long time ago were attributed with some completely new meanings, or have totally become independent names of independent areas within the arts and sciences. What does the concept *the unconscious/conscious* actually mean today, what is its real epistemological signification and what is its use? Why has this concept survived at all until these days?

One of the most frequently intervening hypothetical constructs in almost all directions of the psychological movements, this central concept

brought in just as much confusion to the history of science and arts as it brought in the new ideas of empirical and non-empirical research.

Research that has been done throughout long-lasting work tried to categorize the aforementioned meanings and give them an evaluated place, making first of all a cross section of linguistical, epistemological and methodological analysis, and thereafter perceiving them as specific scientific hypotheses of unequal ponds, that is, completely different values. The most important theoretical benefit from this is a clear a priori picture about what the "better than" scientific hypothesis should look like, and the most important practical benefit is the simplified choice for researching among the hypotheses of different empirical contents, different darings, different simplifications and savings, and finally, different originalities. In the old domicile of creative induction, scientific invention, or Popper's originality in the establishing of a hypothesis, "the artistic contribution to science" is included with a totally new interpretation.

It seems that the following fields of application of the central concept *the unconscious/conscious*, that is, its following domains, can be defined as stated below.

(1) The field of *causal hypothesis*, in the empirical experience most often classified as a neurological concept which is concealed in the meaning of the term *unconscious/conscious* with characteristics of mystery in the process, but with characteristics of clear empirical causality.

Here, many already verified hypotheses which could be classified as *empirical verifiable hypotheses* were searched through. In this sense, the basic conditions of the empirical of our ideas in the form in which Karl Popper, impressed by the natural sciences, states, have to be critically developed. The consequence of this was the revealing of a number of psychological "empirical" researches which actually did not have any empirical contents at all. This however, does not mean that such hypotheses (before the researches) did not have a certain consequence and coherence, and above all sense. However, this clearly separated them from the hypotheses which include a certain type of risk (Popper's concept). In the examples one can discover that, on the other side of tautological hypotheses, there exists one entire



additional hierarchy of "the better" and "the worse", and that it is not at all coincidental that we choose exactly those, and not some other hypotheses (here we do not mean the Freudian determination) in the research.

(2) The field of *psychoanalytical coherence* and the concept *the unconscious/conscious* within it.

The basics of psychoanalytical theory are analyzed in the aim to clearly show the internal coherence of the theory on one hand and, its mythological (in Wittgenstein's sense of the word) and aesthetical attractiveness on the other. What is the power of the hypothesis that incorporates as well as explains the whole empiricism, but is not empirical in itself, becomes clear when one understands the value of the "aesthetical or mythological type of explanation", which does not require empirical verification, but the *acceptance* to think relatively coherently within it. Also, the meaning of these constructions in science as a concept should be emphasized, as well as their indirect epistemological meaning (even though there is no hope that certain theories will become "more empirical" through time or their elaboration). The basic attributes of the "aesthetical explanation", which appear individually or together, can be analyzed as:

- (a) conscious or "unconscious" mixing up of the *reason* and *cause* in the explanation;
- (b) an obligatory element of attraction or therapeutical effect which (chosen on basis of empirical experience) exists in the explanation (in the case of the psychoanalytical attitude, the explanation of the patient's irrational behavior itself is impossible to test independently from the fact that we accept, or that the patient accepts, the same explanation). But, as Wittgenstein rightly emphasizes, the aspect of attraction and repulsion, i.e., some kind of ambivalence toward the explanation, is also present: "if the explanation is such, that a majority of people is not willing to accept it, at the same time it is highly credible that there would be ambivalence when it comes to the type of explanation that people are willing to accept";
- (c) the explanation of the patient's behavior (at least in the psychological clinical domain) is always on the same level as the explanation of the patient's refusal to accept the interpretation;
- (d) the meaning is consciously or "unconsciously" confused with the law, and the law is confused with the meaning. The question whether we can interpret phenomena because they contain certain concealed meanings, or whether they obtain these meanings after we successfully interpret them, is asked again;
- (e) the mythological type of explanation always and exclusively searches for a reductionistic base-point, that is, one meaning only, one principal sense, one only origin of the problem, one only justification, one only reason. It is clear that the

concept of the unconscious was here often only in the function of a new name;

- (f) in this type of explanation, the aspect of animism, in one or another form, is also possible; and
- (g) conscious or "unconscious" confusion of "constitutive" and "regulative" rules in the explanation of human actions, which is very frequent.

However, the fact that we have identified signs of aesthetical explanations (not explanations of aesthetics as well!), or mythological explanations (not explanations of mythology as well), still does not mean that the same, containing one of these characteristics, do not have a form of internal coherence, and it especially does not mean that they do not make any sense, and they even have certain roles in science. A special moment should be devoted to the specific part of psychological research which is put in the middle between exclusive coherence of the system and exclusive empiricism; the research that is in a way a bridge between the rational and empirical in the microworld of psychological themes. Taking into account that their biggest problem is the operationalization of concepts, this research also includes an entire hierarchy of good and bad hypotheses, and one part of these hypotheses are included in the structure of the so called Ego psychology.

The concept of the unconscious/conscious in the aspect of *coherency* accepts very different ideas and systems. Within them, the ancient Greek problem of *akrazia*, the antique root and inspiration of Freud's concept of irrationality, inevitably gets a special evaluation. Here one should develop all forms of Freud's understanding of the irrational act, in an analogous echo of the, in the first place, antique conflict condensed in the "principle of Medea". The cogitations of modern language by Donald Davidson follow, that is, of the interpretations of the irrational as a conceptual, and as a real happening as well. Thereafter, an original analogy was made taking into consideration the Freudian form of irrationality and the new research on the lateralizations of the brain. The goal of this analogy was an attempt to think in the direction of neurological reductionism, but without any possibilities of creating conclusive attitudes. The analyzing of the appearance of the irrational act in its seemingly different appearances, can be understood as, basically, the central point of the whole problem. The one, through which the most interesting angle of the unconscious/conscious principle is interpreted.

(3) The field of physiologically different, i.e., *altered states of consciousness* and *the unconscious* in this specific meaning, with for us the closest and most paradigmatical example - the dream.

Even though also here, in the psychological process itself, the causal hypothesis is most often in use, in this meaning of the concept *the unconscious*, the emphasis is moved to another and a different phenomenological quality of the experienced. That is



at the same time the only difference between this one and the principal meaning of *the unconscious*, which is defined as a neurological hypothesis that excludes both what is experienced and what is lived through, registering in the consciousness the consequence of the neurological state only. The diverse quality or, in other words, kind of cerebral waves, is accepted as a basic physiological criterion for "different" states that we often (but not always) consider as the unconscious.

(4) The field of *linguistical hypotheses of the mental* with the concept of *the unconscious/conscious* that is used within it.

Here we have in mind the comparison of the platonistic Fodor's thesis "language of thought" (Jerry Fodor) with the basic idea of the mentalistic linguistics of Chomsky, and with the theory of Sosirovski's principles which more or less discovers the psychological meaning of the phenomenon *the unconscious* structured as language. This completely specific meaning of the phenomenon *the unconscious*, which is not developed as usual, but as a linguistic system of symbols, and maybe clearer than its other meanings, points out the question of the epistemological significance (or, insignificance) of hypothesis based on it as a central concept.

Through Lacan's (Jacques Lacan) fairly complicated and formalistic hypothesis, which contrary to Freud's frequent and inconsequent moving of the meaning's center from one field to another, strictly sticks to language, the principal problem of the *unconscious* is set forth, and it touches the mere edge of the logical problem "truth without antithesis".

(5) The field of *psychological or anthropological* interpretations of the concept.

This is an analysis of the hypothetical construct "*the collective unconscious/conscious*" which models a completely specific scientific hypothesis which is very difficult for operationalization in all of its meanings, except for the one which the author of this text comprehends as "Lysenkoism in a novel view", that is, the problem of what is inherited and acquired. The explanation put forward with this signification is even more complicated when the dimension of time is present in its interpretation, that is, diachrony. Will a psychological inheritance acquired throughout generations produce "savings" in view of a form of inheritance in the n-generation? What is exactly the essence of the *collective unconscious* if it is not just a descriptive concept and construct which Jung (after Danilevski) uses to describe an aspect of the human mind more credibly?

(6) Finally, we now separate the field of psychological theories which were developed in the 1960's, and the phenomenon of *the unconscious/conscious* seen from the point of view of the *theory of information*.

The completely new logic of meaning is with this research brought into action and it is based on the premises that, in the interpretation of the mental world, mental processes are not primary anymore

(even though they are not denied in the physiological field), but the different defined tasks are primary. Alertness, consciousness, attention, memory, all of this is interpreted as diversely directed steps in the performing of a task, but the concept of *the unconscious* can be principally found in every one of them, without special bonds to certain "processes". In some way, as the author of this text sees it, this completely new use of this old concept, summarized the thesis on the mobility of meaning in the field of Psychology which in whole sees itself as a *method* for discovering the functioning of "consciousness".

In this way, all intertwinings of old and new meanings, can in an original way be extracted. The author's six categories of meaning, sometimes or systematically mix a certain number of hypotheses, which are also identified. At the end of the study, in the final analysis of the central concept of the *unconscious*, we conclude that this concept is not analogous "to the same object in every possible world", but rather to a kind of epistemological emptied element in the role of "the unknown". The element that closes or completes a group of sufficient conditions for expected cognition.

We will end this brief presentation of the study of the phenomenon of the *unconscious* and different hypotheses based on it, with a few totalities of categorization behind us, with a mentioning of the epistemological and existential meaning of the principal concept, but all of this in the spirit of synthetical thinking, which has already completed its duty toward analysis.

## References

- [1] Bouveresse, J.: "*La rime et la raison, science, ethique et esthetique*", 1973; Bouveresse, J.: "*Le philosophie chez les autophages*", ed de Minuit, 1984; Bouveresse, J.: "*Philosophie, mythologie et pseudo-science*", ed de l'Eclat, 1991; Carnap, R.: "Psychology in Physical Language", in *A. J. Ayer (ed) Logical Positivism*, pp 165-98, The Free Press, 1959; Carnap, R. "*The methodological Character of Theoretical Concepts in Minnesota Studies in the Philosophy of Science*", Univ. of Minnesota; Comski, N.: "*Gramatika i um*", Nolit, 1979.
- [2] Davidson, D.: "Paradoxes de l'irationalite", ed l'Eclat, 1992; Freedom to act, Essays on Actions and Events; "Actions, Reasons and Causes", in *Essays on Actions and Events*, Clarendon Press, Oxford, 1980; Descombes, V.: "L'inconscient malgre lui-le meme et l'autre", *Quarante cinq ans de philosophie francaise (1933-1978)*; Dennet, C.D.: "*Brainstorms*", Harvester Press, Sussex, 1981; Descombes V.: *L Inconscient malgre lui, rev. Critique* 1986.
- [3] Dreyfus, H.: "*What computers can't do*".
- [4] Eysenk, H.J.: "*Sense and Nonsense in Psychology*", London Penguin Book, 1957; Federn, P.:

- "Ego Feeling in Dreams", *Psychoanalytic Quarterly I*, 1939.
- [5] Federn, P.: "The Awakening of the Ego in Dreams", *International Journal of Psychoanalysis*, XV, 1934; Freud, S.: "Interpretation des rêves", P.U.F. nouvelle ed, 1967; Freud, S.: "Introduction à la psychanalyse", Payot.
- [6] Freud, S.: "Remarques psychanalytiques sur l'autobiographie d'un cas de paranoïa", in Cinq psychanalyses, P.U.F., 1954; Freud, S.: "Die Traumdeutung, (I & II)" Imago Publishing Co. Ltd., London, 1942; Freud, S.: "Der Witz und seine Beziehung zum Unbewussten", C by Imago Publishing Co. Ltd., London, 1960; Feigl, H.: "The Mental and the Physical" in "Concepts, Theories and the Mind-Body Problem", University of Minnesota, M. Press, 1958; Feigl, H.: "Critique of intuition from the point of view of scientific empiricism", *philosophy East and West*; Feigl, H.: "Physicalism, Unity of Science and the Foundations of Psychology", in P.A. Schilpp (ed), *The Philosophy of Rudolf Carnap*, New York; Green, Ikonen, Laplanche: "La pulsion de mort" (Symposium), Presses Universitaires de France, P.U.F., 1984.
- [7] Grunbaum, A.: "The Foundations of Psychoanalysis, a Philosophical Critique", University of California Press, Berkeley-Los Angeles-Londres; 1984.
- [8] Harrison, H., and Minsky, M.: "Le problème de Turing", Collection Ailleurs et Demain.
- [9] Hall, S. Calvin and Gardner, L.: "Theories of Personality", New York, 1978.
- [10] Isakower, O.: "A Contribution to the Pathopsychology of Phenomena Associated with Falling Asleep", *Cahiers Med.*, 1963.
- [11] Jouvet, M.: "La phase paradoxale du sommeil", *Cah. Med.*, 1963.
- [12] Jung, C.G.: "Modern Man in Search of a Soul", Routledge and Kegan Paul, London and Henley, 1961; Kun, Tomas: "Struktura naučnih revolucija", Nolit, 1974.
- [13] Lakatos, I.: "Falsification and the Methodology of Scientific Research Programmes", in Criticism and the Growth of Knowledge, I. Lakatos and A. Musgrave, eds. Cambridge, 1970.
- [14] Laplanche J. et Pontalis, J.B.: "Vocabulaire de la psychanalyse", P.U.F., 1967.
- [15] Lakan Z.: *Spisi*, Gallimard; Levy-Strauss, C.: "La pensée sauvage", Plon, 1964; Lock, G.: "Wittgenstein: philosophie, logique, thérapeutique", P.U.F., 1992.
- [16] Luria, A.R.: "The Working Brain, an Introduction to Neuropsychology", Penguin Press, 1973; Novaković, S.: "Teorijsko procenjivanje rivalskih hipoteza", *Filozofske Studije*, Bgd. 1972; Novaković, S.: "Teorija naučnih revolucija", *Fil. Stud. Bgd.*, 1972.
- [17] Marković, M.: "Apodictic Universality of Scientific Laws" (script)
- [18] Piaget, J.: "Logique et connaissance scientifique", Gallimard, 1967.
- [19] Pears, D.: "Motivated Irrationality in Philosophical Essays on Freud"
- [20] Popper, K.R.: "The Logic of Scientific Discovery", London, 1959; Popper, K.R.: "Conjectures and Refutations", London, 1963; Popper, K.R.: "Objective Knowledge", Oxford, 1972; Veličkovski, B.M.: "Savremena kognitivna psihologija", Izdanje Moskovskog Univerziteta, 1982.
- [21] Wittgenstein, L.: "Lectures and Conversations on Aesthetics", *Psychology and Religions Belief*, ed by C. Barrett, B. Blackwell, Oxford, 1996.
- [22] Von Wright, G. H., "Objašnjenje i razumevanje", Nolit, 1975.

# CONSCIOUSNESS AS A COMPOSITION OF COGNITIVE FUNCTIONS

Predrag Ognjenović and Bojana Škorc

Laboratory for Experimental Psychology, Faculty of Philosophy, Belgrade, Yugoslavia

**Abstract.** Consciousness is understood as composition of cognitive functions of different phylogenetic status. This approach is based on: (a) investigation of effect of hypoxia (oxygen deprivation) on cognitive functions on the one hand and, (b) cognitive analysis of dreams on the other hand. Several "internal screens" (memory) on which the picture of external world is organised, and which appear in certain order, are described in detail. In principle, if the "screen" is deeper, its picture will be less veridical and more abstract. This allows for greater number of degrees of freedom which, in turn, enables system to be more efficient in manipulating information. It is assumed that this tendency could also be applied to the construction of some deeper internal (symbolic) realms like, for example, art and other kinds of human spirituality. Position of an object is investigated in a 3-D space of consciousness (defined through cognitive, conative and emotional co-ordinate). Subsequent analyses indicated the existence of five categories into which objects could be classified. Broader look at those categories indicates dimension of instrumentalization.

**Key words:** *consciousness, hypoxia, objects, sleep, instrumentalization, reification.*

General system theory (GST), primarily mathematical discipline, applied on the biological systems [1,2], more specifically, on the functioning of nervous system [3-6], offered the possibility of getting new view to the chaotic findings of the brain science. It gave molar insight based on the investigation of organisational principles of the multilevel, alternative functioning systems.

Namely, existing global brain theories, theory of localization of brain functions and holistic theory are not satisfactory, because they are not able to include both experimental and clinical findings. Present researches indicate *high dynamics* of brain processes, much higher than it can be explained by relatively simplified theories. First, particular brain regions are not strictly specialized for a single, unique action. In addition, few regions are often alternatively engaged in the same task having specific role in it. There are also exchanges of competencies and conducts of actions between different brain regions. Finally, same task based on identical stimulation, arousing identical response could be executed by different brain regions, the functioning of which varies in time [7]. In addition, we must not forget that brain is divided into larger sections in three dimensions: *up - down* direction shows many "brains" originating from the evolution of the human species [8]; *left - right* direction shows two complementary hemispheres

organized by different operational principles; *forward - backward* direction shows large blocks - cognitive, conative and emotional. In each ME there are, as we see, few of us. That's the reason why brain researchers often use term "sociology of the mind" [9].

General system theory goes in the opposite direction - from upward to downward. Namely, the fact is that certain system exists not only because it consists of certain components, but also because of its *specific organization* which gives a good reason to science to concentrate on that topic. Bertalanffy developed basic terms of GST [1]: *hierarchy, open system and equifinality*. All three are directly connected with neurologically based understanding of the phenomena of the consciousness.

Hierarchy, naturally, implies multi-leveled organization of the system, for example brain. Few alternative actions at one level are controlled by strictly one region at the higher level. The more such levels we have in one system, the more "power" will be concentrated in the smaller region of the system. How far can that go? Evidently - not till the very end, in which case we would face *reductio ad infinitum*. Here we are dealing with partial model, appropriate for the lower, executive, subsystems. The main deficiency of the model is lack of flexibility - such an organization makes system being rigid.

That's why hierarchical model explains well lower neural functions with less degrees of freedom and smaller number of alternative solutions. But, higher human brain functions must be organized in different, less rigid way - mainly because of the need for acquiring new types of actions, that is to say, to allow learning and thinking. In Bertalanffy's words, such a system has to be capable of acquiring of new operations, in order to be an open system.

Heterarchical model is alternation and opposition to hierarchical. There is no supreme command instance assumed. The various components of the system are "in charge of" or "competent for" certain type of action, those components being relatively autonomous. If we take into consideration an open system dealing with unpredictable situations, consensus between subsystems which gives temporary competence to certain instance, i.e. subsystem, is obligatory. However, if permission for action from all of the subsystems is required, such a system would be slow and uneconomical. That's why heterarchical model fails to explain organization of higher neural functions.

On the other hand, the main problem of the open bio-systems is how to learn and not become the servant of the learnt? Neuroscience has proved that establishing the new neural pathway gives an advantage to this pathway in future actions. A simple task, once solved, would lead to fixation, durable competence of neural elements of the same pathway, toward stronger and stronger confirmation of that solution. At the same time, all alternative solutions would be suppressed and, finally, will disappear. That would lead, as we see, toward closing of the system and toward robotisation. Luckily, this doesn't always happen. There are, evidently, mechanisms responsible for eliminating the rigidity.

Our assumption is that among such mechanisms sleep is the most important one. Namely, for a long time sleep was subject of mystification and prejudices. One of them is the belief that the only task of sleeping is to provide physical recovery. But, as science shows, we are physically recovered after an hour or two of sleep. What do we need 6 - 8 hours (or more) of sleep for? Why do we lose consciousness if we need physical rest? Why, then, do we need the dreams?

As indicated by the analysis of the types of motor response and the total scope of human activities, freedom to correct actions and to select alternatives increases, going afferently through neural stem [10]. Even the simplest neural actions are functioning as a conflict of competencies, as a dynamic synergy of few potential actors, they do not emerge from the steady state. This is the general phenomenon in neural organization. We can see the conflict of competencies almost everywhere - the peripheral neuron could become important in decision making only as a result of complex process of inhibition of other neurons; neural nucleuses are in opposition to each other; there is rivalry between brain hemispheres.

The dynamics of competencies among neural units is much lower at the lower levels. The number of degrees of freedom is smaller, as well as number of potential alternatives. Also, the level of the "programmed" behavior is lower at higher neural levels. The degrees of freedom increase rapidly, so for the highest functions we have an unrestricted number of alternatives. Of course, lower functions are organized hierarchically. This does not imply for higher functions which have to stay more autonomous. The higher functions are probably forming a special type of hierarchical organization with *subsequent consensus*, this consensus being the main purpose of sleep [5,6].

Subsequent consensus is mechanism which cleans the system and removes the rigidity, thus preserving the flexibility of the system. During normal daily activities in heterarchical system with dynamic competencies there is no time to achieve direct consensus. Action has to be executed rapidly. The establishing of consensus would slow down the action, therefore consensus has to be delayed. Brain regions which are alternative conductors of the behavior and

are characterized by the highest degree of freedom, take temporary competence for direct actions according to the constellation of the input. This causes the unbalance in the system which has to be annihilated, in order to prevent permanent advantage of once effectively activated brain instance. This is what sleep and dreams do. While body rests there are no direct actions, and the brain has time to achieve subsequent consensus. The competencies of certain subsystems from immediate past are "discussed" or tested for the future. Temporarily established competencies are going to be annihilated. This brings back probability for selecting other alternatives in the future - freedom is regained!

Naturally, not all the competencies are annihilated. Some of them are confirmed and preserved as permanent mode of behavior. But this process has its price - those functions have to back down, toward the "programmed" behavior, and leave higher position, the area of free decision making.

Thus the brain constantly balances between two unpleasant extremes which could be ludicrously phrased as *Idiot savant* (too ordered system) and *Intelligent Tabula Rasa* (too chaotic).

In conclusion, we can say that the purpose of the sleep and dream is to remove the rigidity of the system and regain flexibility, i.e. to return freedom in making original and adequate decisions in the future.

Sleeping is not the only way to remove rigidity of the system. There are few others as well that are related to the level (lower or higher) which needs to be liberated. As psychological studies of problem solving indicate, sometimes it is sufficient to make simple pause, to rest, or change the current activity. Sleeping is one, the most complex among those mechanisms. As we see, the model of liberation is structured according to the type of freedom disturbance.

Therefore, there are two principles of human brain organization: (a) the algorithm acquiring principle that is related to quick and adequate action as a response to recognized stimulus, and (b) construction of action related to unexpected situation as a response to stimulus combination we never encountered before. Neural system is prepared for two types of actions by forming: (1) *hard* (rigid) brain functions, and (2) *soft* (flexible) brain functions [7].

This principle of division is further transposed into two types of psychological activities: (a) *reproductive* and (b) *productive*. The first type is related to "hard" brain functioning organization, while the second type refers to "soft" organization. Thus, for example, genetically inherited programs of actions and operations of memory during information processing could be classified into the first category. Specific operations of "coders" by which established forms of (re)actions are overcome and new algorithms for previously non-existing set of action is formed, could be classified into the second category. The work of the latter cognitive operations depends on occasional elimination of rigidity, since the nervous system in

global tends to simplify and automatize actions already acquired. The sleep is the principal "cleaner" who removes or decreases rigidity of the nervous system. It is clear, therefore, why the man is smarter in the morning as many proverbs say, or less flexible if the dreaming is disturbed, as many researchers claim [11-13].

In the scope of these organizational principles of brain work we can also discuss the phenomena of human consciousness. Naturally, consciousness is the traditional topic in psychology, but it is also indirectly discussed from the position of many other scientific disciplines. We believe that understanding of consciousness and some other traditional topics in psychology could be advanced by applying this molar views of neuroscience on the function of the brain on the one hand, and by "weaving in" the results of experiments on the molecular level, on the other hand.

Before we start this discussion, let's mention briefly how psychology treated the traditional topic of human consciousness. In the course of the last hundred years, psychologists were interested in consciousness indirectly through investigation of conscious processes. It started with the *psychophysics* and so called psychology of the consciousness in the 19th century and was continued with the *Gestalt theory*. In the second half of this century it was experimentally investigated within *Information processing* approach. This approach treats the cognition as an act of communication between environment and individual consciousness. In addition, it also applies the communication theory model to processes inside us! The experimenters are scanning the order of cognitive operations, the properties of inputs and outputs, the capacities of particular sub-operations, the structuring of sub-operations into unique cognitive process. They conduct simple but rigorously controlled experiments in which the speed and accuracy of response to cognitive task is recorded. The models of communication are constructed, and cognition is treated as a whole not being divided into distinct processes of perception, thinking, remembering, etc., as it was the case with traditional psychology. At the end of 20-th century, the Information processing approach appears to be the major breakthrough in experimental psychology. It gave new impulse to experimental psychology - the rats, favorite experimental subjects of behaviorists are abandoned, while the human being is entering psychological laboratory as a main subject, the events in his mind are again the most important issue of scientific exploration.

It should be emphasized that Information processing approach doesn't offer coherent theoretical view for the phenomena of consciousness. It implicitly involves new variant of structuralism. Unlike the structuralists from the end of last century, here we do not deal with elements of psychological processes but with composition, i.e. structure of cognition. Instead

of some psychological elements, here we have discrete sub-operations in order. It should be noted that consciousness is an issue that is not favorable in contemporary experimental psychology. However, its composition is a matter of debate.

\*

In the course of the last three decades, in our Laboratory for Experimental Psychology, a great amount of researchs was conducted that indirectly enabled us to say something about consciousness which is, no doubt, one of the most challenging topics in contemporary psychology. Our approach to the phenomenon of consciousness is primarily based on two empirical sources: (a) the effect of hypoxia on cognitive processes, and (b) researchs related to the composition of dreams.

**Ad (a).** Hypoxia is the lack of oxygen in tissues. It is well established fact that different tissues are not uniformly sensitive to this deprivation - nerve tissue, for example, is more sensitive than other tissues. The brain is most sensitive to the lack of oxygen, but within brain there are differences in sensitivity as well. Thus, for example, cortex requires more oxygen than the gray mass, while the gray mass on the other hand requires more oxygen than the white mass. Furthermore, in gray mass there are cortical neurons which are not equally sensitive. Of special interest is the fact that nerve functions exhibit different sensitivity due to their phylogenetic status. Phylogenetically younger functions are more sensitive than older functions and in the case of oxygen deprivation tend to break down earlier than older functions [14]. This enables special kind of experimentation where oxygen deprivation level is varied in order to decompose complex functions and stratify them according to their phylogenetic status.

Experiments conducted on human subjects were done in baro-comora which allows simulation of different levels of height. As a consequence, the reduced amount of consumed oxygen causes variable hypoxic effects. In principle, more complex functions are more sensitive to oxygen deprivation. Reasoning appears to be the most fragile function, subjects become uncritical, their visual field span becomes reduced, selective attention decreases, while emotions are harder to control. In addition, it was demonstrated that hypoxia has some global consequences as well - it causes regression of consciousness. Test batteries indicate this even in mild hypoxia (2500 - 3000 meters). The increase of oxygen deprivation is followed by significant change in organization of functions - the organism is reacting to stressful situation not only by reducing the less important functions, but with some global change of system solution [15]. In such situations our subjects exhibit behavior that seemingly resembles the one of prehistoric man. However, one general principle becomes transparent in all these situations: the reduction of functions is aimed at preservation of few

basic functions at expense of those of that are less relevant. Finally, the order of functions that are lost includes consciousness as well! The loss of consciousness as a consequence of oxygen deprivation takes place before the loss of vital biological functions. In other words, consciousness has its own place in a hierarchy of brain functions.

**Ad (b).** In the last few decades, the investigation of dreams has made substantial progress, since the influence of psychoanalysis and its dynamic derivatives became negligible. The techniques of analyzing the composition and content of dreams were developed, the emphasis being put on language of dreams, semiotics and syntax of dreams [16-19]. This approach is known as *the cognitive analysis of dreams*, although it includes emotional and conative aspects of dreams as well. The gist of this approach is an attempt to apply the language of communication and model construction (which proved to be successful in information processing research) to investigation of dream organization.

The research conducted primarily on students in our laboratory in the course of the last two decades was two-folded. On the one hand it was aimed at better understanding of the language of dreams, i.e. cognitive material the dreams are made of [20], while on the other hand it was aimed at gaining some insights about the composition of dreams, i.e. ways in which the “dream story” is made [21]. On the basis of such studies it is possible to make few ad hoc claims about the phenomenon of consciousness as well.

There is, of course, “consciousness of dream”, i. e. some specific consciousness in the course of dreaming that differs from “ordinary” consciousness when we are awake. It could be assumed that the two phenomena are so different that findings about one could not be extrapolated into the other. To our opinion the analysis of consciousness of dream and language used in dreams can tell us a lot about consciousness as such. As the matter of fact, the consciousness of dream allows for some analyses that are not available to the consciousness when we are awake.

The idea that dream resembles regression of consciousness derives from Greek philosophy. Likewise, K. G. Jung claimed that dreams are an archaic language which expresses the subconscious contents. On the other hand, phylogenetic aspect of dream was explicitly elaborated by S. Freud who believed that some day we will be able to distinguish the individual aspect of dream from the one that has phylogenetic origin [22]. Such considerations are also related to the ideas of E. Fromm exposed in his “Forgotten Language”. They are also in accordance with our earlier exposed ideas of dream being a subsequent consensus between brain’s subsystems, where some subsystems are clearly phylogenetically distinct [5,6]. The general aspect offered by our cognitive analysis of dreams, which could also say

something about consciousness, turned to be (unexpectedly) compatible with findings of seemingly remote investigations, like those on the effect of hypoxia. They seemed to complement the same picture.

From our cognitive analysis of dreams the following could be incorporated in our understanding of consciousness. First, it is finding about the dominance of motor representations in dreams. Commonly, descriptions of dreams are dominated by visual and to a lesser extent, auditory contents. With some practice in introspection, the descriptions of dreams are substantially altered; the number of motor representations is increased and they are put at the very core of the story as *relations* or *primary space of meaning*. Corroborating evidence comes from the description of dreams when subjects are suddenly (purposefully) awakened. In this type of studies (as well as in some others) somewhat modified introspective report regained credibility and became a significant source of reliable scientific evidence [23,24].

The second area of interest is the phenomenon of “access” into a sleep. Using its specific terminology, physiology provided us with detailed description of phases that constitute entering into sleep. However, here we are not referring to those phases. In our investigation we used introspective descriptions of entering into a sleep which were spontaneous, as well as those which were obtained during awakening of a subject by interrupting him while entering into a sleep. It was demonstrated that during entering into a sleep a place of contact with reality gets shifted towards inside, or, as often described by our subjects, the shift of “screens with projected events” takes place so that events are “pushed” deeper inside the person. This process starts with the 3-D space being eliminated and the contact with reality being organized in terms of a 2-D surface (the analogy with screen seems to be derived from this impression) which is settled somewhere at body’s periphery. This seems to parallel the distinction between epicritic and protopathic sensitivity described at the beginning of this century, i.e. the shift from awareness about objects to awareness about the stimulated place of the body [25]. This, however, is not yet the characteristic of sleep, it is a mere condition for entering into a sleep. It looks like a prelude to a sleep - the elimination of rich and provocative external surrounding and reduction of an imminent experience to more simple frame. Couldn’t this be treated as some kind of reduction of conscious as well?

It seems that for some period of time representations take place independently within one sensory space only, and then get merged into a common story. There are number of hypotheses about this mechanism - from ideas developed at Pavlov’s school that this is due to remaining excitation within dominant inhibition in cortex, to the ideas that phase brain excitation (in REM) activates hippocampal-

neocortical memory system which produces sensory images - i.e. representations. The dreamer merges those images (the law of associations?) and from their succession creates a dream story [26]. No matter what mechanism might be responsible for that, the fact is that images are merged into some inner cognitive space ("screen", as referred by our subjects), which is not equivalent to the one when we are awake. It looks like a cognitive space for representations in "conscious consciousness". In contrast, the cognitive space in dream seems to be characterized with somewhat more stable images and possibility of simultaneous influx of information of different modalities. Obviously, shift to this level appears to be a step towards some deeper inner space of information processing.

These findings support the following conclusion which is relevant for our topic - *consciousness is composition of cognitive functions*. The experiments with hypoxia clearly support the idea that consciousness is characterized by number of levels. In addition, they indicate that this composition is made of functions that differ with respect to their phylogenetic status. Information processed could either be from the outside (the effects of imminent stimulation) or from the inside (memory, emotions, conative aspect). One of its most prominent characteristics is the reduction of parallel processing to linear information processing. Here consciousness tends to prolong and enhance the tendency to create unbalance (if necessary) among information - i.e. to enhance processing of one part of stimulation from the vast number of information that emerge in parallel. It should be noted that this principle was observed in perception, i.e. at the very surface of cognition, as was demonstrated by Gestalt psychologists and formulated in their laws of perception. However, this tendency is even more pronounced in deeper levels of cognition. The logic of information selection is rooted in obligatory distinction of critical and relevant information from those that are irrelevant. Consciousness could be focused on itself as well. This, in turn, is the basis for emergence of self-consciousness. In principle, this inside look does not allow for immediate experiencing of cognitive complexity - consciousness observed from "inside" appears to be unified.

Let's turn back to the discussion about principles of organization of brain functions. It was demonstrated that one of the fundamental problems of brain functioning appears to be exclusion of (temporary) competencies, this being in accordance with the view proposed by Crick and Mitchinson [27,28]. In their permanent struggle against rigidity, nerve organizations adopt new and complex operations which are not part of inherited inventory, as is the case with dream. This is related to the requirement for the system to be opened, as emphasized by Bertalanffy [1]. We assume that in this context we could also discuss the acquisition and development of the so called spiritual nature of man.

The important aspect of "the need" for spirituality (which we think is essential) could be treated as requirement of the neuro-psychological system for freedom, for overcoming the routine solutions in exchange with both social and physical environment. Thus, in creation and usage of spiritual values we face the separation from immediate physical and social reality, we experience the leap into meta-reality, reality of a different level, or metacode with new system of meaning - counter-reality as referred to by semioticians [29].

In those newly opened realms of meaning, according to the described mechanisms, subsystems could be formed with their specific operational characteristics. They, in turn, appear to be more or less autonomous and/or formalized, not unlike numerical, aesthetic or linguistic systems [30].

Consciousness, previously described as a system of cognitive operations aimed at selection of adequate mode of behavior [31] develops spiritual subsystems, providing them new (semantic) realms. The empirical studies of object transition in consciousness clearly support this claim.

Position of an object in consciousness is, of course, dynamic. However, from more general perspective, it was demonstrated that objects are distributed only in five categories (or groups) in a (hypothetical) space of consciousness [32]. This space is characterized by three coordinates: cognitive, conative and emotional, where each object is represented by a point derived from judgments on scales of cognitive distance, conative frequency and emotional value. The principal parameter of change, i.e. transition from one category into another, is the object instrumentalization, which could be seen in categorization of individual spiritual values as well [33].

In the following paragraphs the empirical evidence related to position and transition of an object in consciousness will be elaborated in detail. It should be emphasized, however, that the domain of meaning is one of the most complex areas of cognitive psychology. Only empirically grounded issues could constitute reliable material for epistemological and gnoseological theories. As a consequence, studies in this field always had broader influence, primarily in philosophy, but also in some technical disciplines like, for example, communication theory.

Experiments aimed to investigate meaning of an object were conducted from 1982 to 1991. Subjects were mainly students and upper grade high school pupils. Some research required re-testing of semantic space for the same subjects after few years in order to capture the dynamics of change of object position. This research had several phases: (1) Subjects were asked to produce the list of objects they encounter every day, or they often think about (abstract nouns were also included); (2) From the obtained list of few thousands "objects" hundred items were randomly selected; (3) The list of selected items was given to

different subjects who were asked to evaluate each item on three distinct scales; the scales were: (a) scale of physical remoteness (cognitive dimension), (b) scale of emotional value (emotional dimension) and (c) scale of object presence in the focus of consciousness; each scale was divided into seven grades (from 1 to 7); thus, each object was represented by a single point in a hypothetical 3-D space defined by three coordinates which referred to cognitive, emotional and conative (i.e. motivational) dimension. (4) Subjects' answers were then analyzed by statistical tests of homogeneity; the analysis indicated that the obtained points group into five categories; (5) These categories were submitted to a qualitative analysis and each category was labeled accordingly; and (6) Several dozens of subjects were subsequently interviewed in order to verify the qualitative analysis.

The obtained five categories in the space of consciousness had the following properties:

A. *Object per se*. This category represents group of objects located at the periphery of consciousness. Both emotional dimension and presence in the focus of consciousness are negligible, in spite of the fact that objects are physically close. Selection of those objects is rare - usually they stay at the margins of our attention. Vast number of objects fall in this category like, for example, people on the street, remote houses, tree on the road side etc. This category could also be treated as some kind of storage from which objects in transition are selected, of which we'll talk in the forthcoming paragraphs.

B. *Object for me*. This category includes objects whose position in consciousness implies strong emotional ties, but the object is remote (objectively and subjectively) - i.e. it is unreachable. Consciousness is often actively engaged with such an object which could be subject of longing or hatred, but it always implies strong emotions. Here we see some kind of object mystification - object is ascribed enormous effectivity. The stronger the emotion, the unrealistic expectation gets higher, as is often the case with emotions.

C. *I in the service of an object*. Objects from this category are also characterized with strong emotional ties. However, in contrast to the previous category, object is objectively close to the subject. Emotionally shaded object is now #possessed# by subject, but this is an illusion. Instead of being a master of an object, subject becomes its slave and puts himself in the position of serving the object. Take, for example, objects from the previous category that were highly estimated. Here such an object is in possession of a subject but, instead of being a source of benefit and satisfaction, its usage becomes of secondary importance, subject is too cautious about it, invests enormous efforts in its maintenance. Thus, through

contact with such an object subject becomes object's slave.

D. *Object in my service*. Objects from this category, although being in close vicinity, are seldom in the focus of subject's consciousness. The object is pushed at the periphery of subject's attention, but subject is not (ravnodu{an) as is the case with objects from category A. This category includes objects that are used as instruments. Object is physically close, but being an instrument it does not require attention because it is an intermediary for some other field of action where attention is focused at. Object is thus incorporated and treated as an expansion of oneself. Sometimes it becomes part of a more complex chain of automated operations that require minimum cognitive investment. Object thus remains at the perceptual periphery, with no attention being present nor deeper cognitive elaboration being required. Only in the case of malfunction of the automatic action subject brings such an object into the focus of attention. Not unlike surgical instrument or stick of a blind man that provide mediated contact with reality - this contact being at the end of an instrument, in the case of more complex instruments like, for example, language, piano or computer - action is located in the outlet of an instrument, while instrument itself gets incorporated.

E. *Object and I per se*. In this category we have an exceptional state of "separation" of both object and subject from immediate reality in some other, nonstandard space of consciousness. This separation is followed by strong emotion, but the maximum effect is realized not at emotional, but rather at conative level on the scale of focus of consciousness. This category is much more rare than the previous ones and has no "permanent status" - objects from this category are temporary classified. It is an exceptional state in which both subject and object are distinct. Subjects describe this state as "the state of exaggerated awareness of object's existence and its uniqueness". Such status is achieved through cognitive operation of perceiving object from a different perspective. Object is removed from its primary (standard) context and it is ascribed some other meaning (or meanings). Examples of such states are "experiences" under hypnosis or some drugs, religious ecstasy, dreams, "jamais vu" and, finally - in reception of art.

It was noted earlier that subsequent investigation conducted on the same subjects after few years show specific transition of an object from one category into another. In principle, this transition goes from category A (*Object per se*), into category B (*Object for me*), then into category C (*Me in the service of an object*), and finally into category D (*Object in my service*). Some deviation from this order was observed for category E (*Object and I per se*). Any object from any category could (temporary) become part of this category. It was observed, however, that this is true



mostly for objects from category A. It should be emphasized that object transition through all categories is not obligatory - some categories could be omitted. Thus, for example, category C (*I in the service of an object*) need not precede well established instrumental position of an object that is common for category D (*Object in the service of I*). Fortunately enough, we are not enslaved by all objects. This is the privilege of a few object only, but many of us get enslaved.

Object transition through categories B, C and D has its specific psychological relevancy. This transition could be conceived as a dimension whose extremes are *reification of personality* on the one hand, and *humanization of objects* on the other hand. It should be noted that these individual-psychological measurements offer some basis for generalizations on global social and historical domains as well. The observed transitions, we assume, take place in collective consciousness as well. Take, for example, case from the remote past - our attitude towards fire. It is probable that at the beginning people were afraid of fire, cherishing it from distance, ascribing it divine and mythical value (category B, *Object for me*). Later on, when they get into possession of fire they had to maintain it, take care of it. They started to cherish it, build temples and perform rituals in order to please it (category C, *I in the service of an object*). Much later we learned to make fire and use it routinely, without emotions moving it at the periphery of our consciousness. mercy

The ideas have the same fate as well. Utopian socialists, for example, for centuries were dreaming about society of social justice (B). Finally, when the "First country of socialism" was established, with enormous amount of human suffering, all social energy was focused on its preservation and caution towards inner and outer enemies (real and hymeric). Army, police, system of control and spying was exaggerated beyond reasonable proportions, which was in painful contrast to the basic ideas of social justice. Individual, for which these ideas was supposedly tailored, was suppressed, deprived of its basic civil rights and shadowed by the importance of the idea (C). Unfortunately, such transitions are not rare. Many bright revolutions ended up as obscure dogmas.

We think that on the basis of these experimental studies in neuro-psychology it is possible to make some predictions as well. Development of new humanistic relations we see in domination of category E in social consciousness. It was noted that transition and order of object categories could be placed in dimension *reification- humanization* in our consciousness. Category D includes expansion of human self with number of instrumentalized objects (it should be noted that that this includes not only material objects, but also ideas and our own actions). The next step in further humanization we envisage in increasing richness of category E (*Object and I per*

*se*). In contrast to category D, here we see the abandoning of instrumentalization in its primary sense and face the creation of a new space in which concept of usage and usefulness gains new meaning like, for example, in the case of good art. Development of individual and collective consciousness would thus lead to creation of novel spiritual realms within each individual which would incorporate new objects from category E (*Object and I per se*). This will enable creation of new micro-cosmoses.

From what we exposed here, a consequent action of the same principle could be observed, the principle being observed in organization of brain function and titled Theory of dynamic brain competencies. The main rout in development of human consciousness we see in acquisition and instrumentalization of operations that genuinely expand human self on broader and broader part of our immediate surroundings.

## References

- [1] L. von Bertalanffy, *General System Theory* (Braziller, New York, 1968).
- [2] M. D. Mesarović, D. Macko, and Y. Takahara, *Theory of Hierarchical Multilevel Systems* (Academic press, New York, 1970).
- [3] A. Brodal, *Neurological Anatomy in Relation to Clinical Medicine* (Oxford University Press, New York, 1981).
- [4] M. LeGare, The use of general system theory as a metatheory for developing and evaluating theories in neuroscience, *Behavioral Science* 32, (1987), pp. 106-120.
- [5] P. Ognjenović, In support of the theory of dynamic competence's, or about the meaning of dream. *Psihologija*, 15, (1982), pp. 3-16, in Serbian.
- [6] P. Ognjenović, Meaning of sleep and of dreams in theory of dynamic competences, *Harvest* 37 (1991), pp. 43-48.
- [7] Н. П. Бехтерева, *Healthy and Ill Human Brain* (Медицина, Ленинград, 1980), in Russian.
- [8] P. D. McLean, Man and his animal brains, *Modern Medicine* 32 (1964), pp. 95-106.
- [9] M. S. Gazzaniga and J. E. C. LeDoux, *The Integrated Mind* (Plenum Press, New York, 1978).
- [10] Н. А. Бернштейн, *On Generation of Motion* (Медгиз, Москва, 1947), in Russian.
- [11] H. L. Wilkinson, A. Lubin & J. J. Goodnow, Impaired performance with acute sleep loss, *Psychological Monographs* 73 (1959).
- [12] G. R. J. Hockney, Changes in attention allocation in a multicomponent task under loss of sleep. *British Journal of Psychology* 61 (1970), pp. 473-480.
- [13] F. Dinges, Are you awake? In: J. Kihlstrom, R. Bootyin & D. Schacter (eds.) *Sleep and*

- Cognition* (American Psychological Association Press, New York, 1990).
- [14] E. J. Van Liere and J. C. Stickney, *Hypoxia* (Academic Press, Chicago, 1963)
- [15] P. Ognjenović, J. Davidović, and A. Bukvić, A parallel between some cardiovascular functions and perceptive-visual abilities in the normoxia and hypoxia conditions, *5<sup>th</sup> Cong. Yug. Psych., Proc. Book. 2* (1995), pp.233-238, in Serbian.
- [16] D. Foulkes, *A Grammar of Dreams* (Basic Books, New York, 1978)
- [17] D. Foulkes, *Dreaming: a Cognitive - Psychological Analysis* (Erlbaum, Hillsdale, 1985).
- [18] J. S. Antrobus, Dreaming: Cortical activation and perceptual thresholds. *Journal of Mind and Behavior* **7** (1986), pp. 193-211.
- [19] J. Montangero, Dream production mechanisms and cognition. *New Ideas in Psychology* **1** (1991).
- [20] P. Ognjenović, Languages of arts and dreams, *Psihologija* **27** (1994), pp. 221-248, in Serbian.
- [21] B. Škorc, Importance of a dream, its remembrance, and objectiveness of the dream report, *LEP Commun.* **12** (1994), pp. 1-28, in Serbian.
- [22] S. Freud, *An Outline of Psychoanalysis* (Norton, New York, 1949).
- [23] R. E. Nisbett and T. Wilson, Telling more than we can know: Verbal reports on mental processes. *Psychological Review* **8** (1977), pp. 231-259.
- [24] N. Block, On a confusion about a function of consciousness *Behavioral and Brain Sciences* **18** (1995), pp. 227-247.
- [25] H. Haed, *Studies in neurology* (Oxford Press, London, 1920).
- [26] T. Okuma, On the psychophysiology of dreaming: a sensory image-free association hypothesis of the dream process. *Japanese Journal of Psychology and Neurology* (1992).
- [27] F. Crick and G. Mitchison, The function of REM sleep, *Nature* **304** (1983), pp. 111-114.
- [28] F. Crick and G. Mitchison, REM sleep and neural nets, *Journal of Mind and Behavior* **7** (1986), pp. 229-249.
- [29] M. Benze, Concise foundations of modern aesthetics, in U. Eko, Ed., *Aesthetics and Information Theory* (Prosveta, Beograd, 1977) Serbian transl.
- [30] N. Goodman, *Languages of Art* (Hackett Publ. Co., Indianapolis, 1976).
- [31] P. Ognjenović, Consciousness as a (psychological) function, in D. Raković and D. Koruga, eds., *Consciousness: - Scientific Challenge of the 21st Century* (ECPD, Belgrade, 1996).
- [32] P. Ognjenović, Position of an object in consciousness, (*Proc. 8th Cong. Yug. Psychol.*, Herceg Novi, 1984), in Serbian.
- [33] P. Ognjenović, Objects and what consciousness do with them, *Psihologija* **20** (1987), pp. 3-12.

## FROM SOUND TO LANGUAGE - ESCAPE FROM DEAF HABITUS

Slavica Pantelić and Mirjana Sovilj

The Institute for Experimental Phonetics and Speech Pathology,  
Gospodar Jovanova 35, Belgrade, Yugoslavia

**Abstract.** This work is the result of monitoring speech-language development of hearing impaired children with the aim of showing in what way sound and speech, under the conditions of impaired hearing as a distant sense, influence the development of consciousness, "break" the created barrier and become the base for the development of speech and language and communication on the whole. Under the conditions of normal development, sound performs the "first awakening" of the consciousness while the baby is still in mother's womb. In hearing impaired children, in the process of methodologically precise habilitation, this should also perform the same influence (delayed in time) on discovering the sound, reacting to it, development of impressive speech and the language system on the whole.

**Key words:** *sound, hearing, impairment, speech, consciousness, meaning, speech communication, Kostic's classification, grammar.*

### 1 Introduction

The research is the result of monitoring speech and language development in children with different hearing remnants, 2.8 - 7 years old. Our aim was to show in what way, under the conditions of hearing impairment, the sound influences the development of consciousness about:

- itself (the sound)
- the sound in the context of meaning
- the meaning (sound) transferred onto the impressive level.
- the speech communication which will be observed through the development of distinctive characteristics of semiotic-symbolical in the language (categorization and grammar). "As it is known, language serves the social being to communicate with other beings of the same language community. But at the same time, language is the means of getting to know the world we live in. Firstly, it obeys the social necessities, communication among people, but it also obeys the degree of realizing the objective reality, which, through this realizing, become subjective and changed to suit us. The powers of language development start form these two sources" [1].

If we have in mind "that hearing is the earliest developed human function and that all other human senses stimulate only 10% of brain energy, that "the first awakening of consciousness" is performed by the means of sound, thus creating the first information about the outer surrounding world" [2], then an

unavoidable question is in what way the process of discovering the sound goes on, reacting to it, its interiorization in the process of speech and language development in children with different hearing remnants, which mechanisms enable these children to develop the maximum of meaning, hearing the minimum of information.

Examinee sample was classified into three groups according to the first results of the hearing state:

- Group 0 - children with no answer of AEPMS;
- Group I - children with biological treshold 90 dB and higher;
- Group II - children with biological treshold of 60 - 90 dB.

### 2 Development of the Consciousness of the Sound

All children belonged to group O according to the time of the onset of hearing impairment (after Kostic's classification

- congenital impairments and those up to 2.5 months after birth) without distinct time localization (embryonically, fetally and perinatally), so we can assume that one part of children had intrauterine development in the surroundings of different sounds: murmur of the umbilical cord, breathing, functioning of internal organs, mother's speech which is transmitted not only through outer environment, but through bone system as well, murmur of its own movements, while one part of the children with impairment in the embryo development did not. Under such conditions, it is most important to enable the child to have an early contact with the sound which will react as a remedy so that the child can bring sound to consciousness and start developing auto feedback and feedback in relation to the environment, which represents the base for starting the vocal game, "pouring" of vocalization into "babbling" and "babbling" into the first word. A child has to receive the speech signal with all its fullness in order to gradually, with hearing remnants as they are and selective amplification which it gets, start to, from the physics of speech (which is murmur in the beginning), crystalize its certain elements and turn them into acoustic nation of speech.

After coming to the treatment at different age phases (from 2.8 to 4 years) all the children have already undergone the phase of vocalization.

### **3 The Level of Speech-Language Development at the Beginning of the Treatment**

Group 0 (average age of habilitation onset 3-4 years) in the phase of using the first words and onomatopoeias with the meaning, has discovered the sound as a denominator and the speech appeared having "basic (minimal) distinctive characteristics of the symbolic" [3]. In these onsets of speech development the developed language system still does not exist, nor a more complex symbolic use of speech.

Group I (average age 2.8 years) in the babbling phase has discovered the sound which still does not have the meaning, but the very discovering of the sound enables these children to start with more intensive assimilation of the outer world through imitation.

Group II (average age of habilitation onset 3-4 years) uses "two-part statements which represent real combinations and reveal certain special characteristics of the language system, through which clear semantic intentions can be discovered; some of these statements, when separated from the context, are unintelligible and ambiguous and, sometimes, the same two-part statement has two different meanings" [3]. This group of children was in the phase of moving from the "situation language" to the real language: when they were supposed to move from the situation understanding to its symbolic reconstruction.

### **4 Development of Consciousness of Sound in the Service of Meaning**

For the reasons of balance known to nature only, it creates disorders, and boundaries, and closes the roads. With the reality we are facing, which is elimination of quality and quantity, or just quantity of auditive perception - even in such cases we are able to lead the sound into a child's ear and through it vibrate the meaning that a child discovers and starts using it actively.

With the help of a word, a child directs attention towards certain properties of the object and uses the word to synthesize them, to symbolize the abstract notion and use it as the highest sign created by human mind. "In the process of language development nouns are created before the other parts of speech, they are the denominators of the object and objectivity and therefore they could have the value of the sign. But one noun is never just a denominator, it also has the whole range of grammatical meanings, so the unity of form and its grammatical content shows that the same form hides more contents which, basically, make the content of the denominator" [4].

The process of knowledge acquisition through bringing into consciousness the realization that every object has its denominator - sound picture, is the key point in the process of speech development, for it is obvious that the development of such word is not connected only with the development of thought, but with the development of the complete consciousness. This moment is delayed in calendar age of hearing impaired children, but it is attainable and in order to realize it, it is necessary to achieve the critical level of the development of hearing attention (at least if it is developed on the minimal hearing remnants) and the critical level of auditory notions which the child created going through the phases of vocalization and babbling.

The research connected with the monitoring of vocabulary development in hearing impaired children of 4-7 years of age [5] shows that the basic factor which determines the dynamics of the acquisition of nouns is movement of objects and appearance (in the "street" test, they are better than their hearing peers). These children showed the inverse order in vocabulary acquisition compared to hearing children. While hearing children move from the notions connected with the body scheme, through the family surroundings towards objects and situations (wider social environment), hearing impaired children show the inverse strategy of vocabulary development - much higher percentage of their vocabulary is connected with wider social environment, than with family surroundings and, in the end, with the body.

### **5 Development of the Consciousness of the Sound and its Interiorization**

"The connection between language and speech is not realized only through its sound feature, but it also exists through the language organizing by inner speech, without which language does not exist. Inner speech is the link between the starting thought and the outer (speech statement). If a child is deprived of inner speech, language development is brought into question, it cannot be performed in the usual way" [1].

Already at the beginning of the second year, a hearing child begins to understand simple commands, it recognizes named objects, it points to them. The process of early habitation of speech and language in hearing impaired children must create conditions for the child to bring to the consciousness the existence of:

- the sound connected with the objects and phenomena in the surrounding world;
- speech communication out of many surrounding sounds;
- to develop motivation for the highest level of human communication called speech, to bring the need for communication into the focus of child's attention, so that it really takes active part in communication, to listen and understand. It is insufficient if a child develops only one level - to

repeat, name or shortly describe the happening; asking several questions about the given situation can show that a child does not understand what is being asked, so the developed speech elements lose their functionality, thus narrowing speech - language scopes, bringing them down to a "poor level" which is absolutely insufficient for normal psychophysiological development of a child. This can be successfully avoided by harmonious methodological approach which has to be in accordance with the natural speech development in normally hearing children thus creating conditions for positive prognosis of speech-language development regardless of the degree of hearing impairment - such child (although later in relation to calendar age) starts developing its inner speech, to understand and by these happenings at the impressive level, creates a new flywheel for the full expressive speech development which starts *vicious circle* which actually represents the base for the communication development.

## 6 Development of Consciousness of Speech Communication

Developed language system appears as the basic semiotic means for acquiring and stating one's complete experience: when it is formed as a system with all the complex, multi-level organization, language is the most complete semiotic substratum of reality enabling the performance of the most complete and most effective semiotic activities. It is not possible to separate the process of speech development in a child from the general realizing development, not only because it depends on that development, but because it retroactively influences it. We would like to especially emphasise some specific features of the development of categorization and grammar in hearing impaired children.

When overwieving categorization, Leneberg's opinion should be underlined: "Categorization of what is specific (named) seems to be completely unimportant for perceiving how speech functions - so, the specific characteristic of semiotic behaviour would not be the ability to connect the name with the separate physical object, but the existence of principles or rules on the basis of which it is decided whether the separate specimen falls into the defined class" [3]. It is from the aspect of connection between thinking and speech that the question arises - of realizing the relationship between the notions and their vertical movement [6] in hearing impaired children. Research performed at in Institute show that children form groups 0 and I of hearing impairment (on the basis of AEPMS findings) do not manage to acheive the norm on both passive and active speech-language level, although they follow the laws of categorization development - progressive increase with age and impressive speech richer than expressive one [7].

If language system "is presented by concentric circles which widen and spring one out of the other in

the end creating the circumference, the central part, nucleus of that huge circumference is the *phonetic* level with sounds and their articulatory-acoustic characteristics and distinctive features. The second circle is the *grammar level* and the constituents of the grammar level are: morphology as a "younger" ring and syntax. Semantics in this model, as the part of language system, extends through infiltration at all levels" [8].

The research performed at the Institute with the objective in elements of grammar level (by surface analysis and comparison of the generated statements of normally hearing children and children with different degrees of hearing impairment) showed that early habilitation of speech and language after KSAFA system enables hearing impaired children (in the number of used sentences and their grammatical correctness) to level with their hearing peers before they start going to school and to follow the same laws in generating sentences with a different number of words [6].

Monitoring of development and acquisition of adverbs and prepositions at the ages of 5-6 show that at the age of 5 hearing impaired children use adverbs (above, down, forward, back) more than prepositions (above, under, in front of, behind) just like their hearing peers, while between the age of 5 and 6 there is the increase of prepositions which can be interpreted as the specificity of realization and speech-language development in this period [9,10].

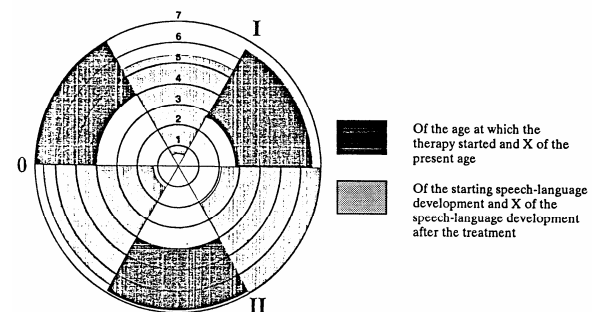

**Graph 1:** Results of chronological age, starting level of the speech-language status and the level of the speech-language development after the habilitation classified in three groups according to the starting results on AEPMS.

Of the age at which the therapy started and X of the present age

Of the starting speech-language development and X of the speech-language development after the treatment

Final considerations of speech-language development in hearing impaired children show that 80% of hearing impaired children with successfully finished habilitation, manage to achieve age standards and to compensate for the lost time in a shorter period, when guided by methodological approach provided by KSAFA method.

## 7 Conclusion

On the basis of the above presented, we can say that even under the conditions of hearing impairment, or existing hearing remnants (at least minimal ones) we can develop speech and language, we can effectively influence and thus help the child to open its consciousness, let the sound world through it, create the link sound-speech-language and achieve the highest point and conditions of knowledge realisation development with the feedback influence on the whole cycle.

## References

- [1] Đ. Kostić, *Speech and Hearing Impediment Child* (Kulturni centar-Privredna knjiga, Gornji Milanovac, 1980).
- [2] M. Sovilj, *Sound, hearing, and consciousness*, in Lj. Rakić, D. Raković, Đ. Koruga, and A. Marjanović, eds., *Consciousness: Scientific Challenge of the 21<sup>st</sup> Century*, Proc. ECPD Seminar (Belgrade, 1996).
- [3] Ivić, *Man as Animal Symbolicum* (Nolit Beograd, 1987), in Serbian.
- [4] Đ. Kostić, *Operative Grammar of Sebcroat Language* (Prosveta, Beograd, 1987), in Sebian.
- [5] M. Sovilj, The efficiency of Kostic' s method in the vocabulary development with hearing impaired children, *18th International Congr. Educ. Deaf* (Tel-Aviv, 1995).
- [6] L.S. Vygotskii, *Thought and Speech* (IPS, Moscow, 1956), in Russian.
- [7] S. Pantelić, M.Sovilj, S. Milenković, and D. Mrdalj, Efficiency of Kostic' s method in the acquisition of the nouns of level I abstraction with the hearing impaired children, *Proc. 18th Int. Congr. Educ. Deaf* (Tel-Aviv, 1995).
- [8] D. Mrdalj, M. Sovilj, and S. Pantelić, The efficiency of Kostic' s method in development of statement in hearing of the impaired children, *Proc. 18th Int. Congr. Educ. Deaf* (Tel-Aviv, 1995).
- [9] V. Kovačević, M. Sovilj, S. Stojanović, and S. Pantelić, The efficiency of Kostic' s method in the development of prepositions with hearing impaired children, *Proc. 18th Int. Congr. Educ. Deaf* (Tel-Aviv, 1995).
- [10] S. Stojanović, M. Sovilj, and V. Kovačević, For speech and hearing rehabilitation, *Proc. 18th Int. Congr. Educ. Deaf* (Tel-Aviv, 1995).

## TOTAL VALUE AND CONSCIOUSNESS

Dušan Pavlović

Bankom Business School, Borska 92, Belgrade, Yugoslavia

**Abstract.** Theories of value are fundamental to economic science. Their purpose is to explain the source of value and its manifestations. With this paper, we would like to introduce a new theory of value which integrates all the previous theories in one – Total Theory of Value. We consider totality of value to be a multidimensional phenomenon with its absolute and relative (objective and subjective) dimensions. Its ultimate source is the pure consciousness as the basic field of nature. Such an observation is not based on the Modern scientific paradigm. Instead, its foundation is the holistic approach of the Science of Creative Intelligence (SCI) founded by the Indian physicist Maharishi Mahesh Yogi considered by many to be the world's leading authority in the field of consciousness. Maharishi defines the SCI as the *complete knowledge about the origin, nature, development and the scope of the basic field of intelligence out of which the whole life emerges and is purified to perfection*. As Maharishi explains, the origin of SCI is the ancient Vedic Science, the oldest systemized knowledge of mankind. The practical application of this new theory is through the new management concept – the Total Value Management which is based on understanding the totality of value and Maharishi's Absolute Theory of Management. The new programs for developing management capabilities on all levels integrate the most developed methodologies of both – Maharishi's Vedic and Modern Science.

**Key words:** total value, consciousness, creative power, creative intelligence, wealth, system of value, love

Value is generally understood as “the worth, desirability, or utility of a thing, or the qualities on which these depend. In economics it is related to the worth of a commodity or service measured against other commodities or services” [1]. Theories of value are fundamental to economic science. Their purpose is to explain the source of value and its manifestations.

### 1 Value in History

The evolution of the economic thought has brought two opposite concepts of value: some of the authors like David Ricardo, Adam Smith and Karl Marx looked upon value as an objective category and have founded so called *objective theories of value*. They thought that the sources of value were the costs of production or labour. For example, a car would be more valuable if the necessary costs for its manufacturing were larger or if it needed more labour to produce it. Their opponents, like A. Marshall, V.S. Javons, K. Menger, L. Valrace and others have argued that value is not an objective but a subjective category,

and that its source lies in human psychology. These authors looked upon value of an object in terms of its utility. From this perspective, an object will be more valuable if its utility for the consumer was larger. Such theories are known as the *subjective theories of value*.

In our opinion, the above mentioned theories are both correct, but only give us a partial explanation of the phenomenon of value. We consider totality of value to be a multidimensional phenomenon with its absolute and relative (objective and subjective) dimensions. Such an observation is not based on the Modern scientific paradigm. Instead, its foundation is the holistic approach of the Science of Creative Intelligence (SCI) founded by the Indian physicist Maharishi Mahesh Yogi considered by many to be the world's leading authority in the field of consciousness. Maharishi defines the SCI as the *complete knowledge about the origin, nature, development and the scope of the basic field of intelligence out of which the whole life emerges and is purified to perfection*. [2] As Maharishi explains, the origin of SCI is the ancient Vedic Science, the oldest systemized knowledge of mankind.

Before proceeding with the explanations on total value, we shall make a brief review of the above mentioned scientific approaches – objective and subjective.

### 2 Modern Science

The basic orientation and characteristics of the Modern Science are:

- It is oriented towards outward, objective world;
- It postulates that reality is only relative and knowledge about it may be determined just in previously defined time and space coordinates;
- True knowledge may be gained on intellectual level only, and that is by the application of the scientific methodology which derives from rational and logical thinking;
- Subjectivity of the researcher must be excluded from the process of research because it is changeable and therefore not reliable;

The main achievements of the Modern Science may be considered to be the development of the powerful technologies and know-how which enabled the human race to reach such productivity in all areas

of human activity which has never been recorded in the known history.

### 3 Vedic Science

The *Veda* is a Sanskrit<sup>a</sup> term and is used to denote *pure knowledge*. Pure knowledge is *absolute knowledge* or the *knowledge of the absolute*.

How can we understand the term absolute knowledge? As it is clearly shown in the Vedic literature, the absolute knowledge or the knowledge of absolute may never be understood in relative terms. Instead of explaining what it is, the experts on the subject rather explain it in terms of what it is not. Semantically, the term relative always refers to something else. Instead, absolute is not referral to anything but itself. It is self - referral. Therefore, the meaning of the term absolute knowledge may be understood as the knowledge of the Self. This explains the inward, subjective direction of the Vedic Science. The knowledge of the Self can not be gained just by observing the outer world. Such knowledge needs insights into our very being. This may be done by using the basic technique of the Vedic science, the transcendental meditation technique, by which we experience the Self as the state of transcendental or pure consciousness. The term transcendental meditation is of Latin origin. To meditate means to contemplate and to transcend means to go beyond. Therefore, the term transcendental meditation refers to going beyond the contemplation or the experience of thoughts and getting the awareness to their source, to the consciousness itself.

With the knowledge of the Self, the absolute or the pure consciousness, the complete perception of reality changes. The borders between the inner and the outer world disappear and the whole Universe is experienced as the continuum of the Self and its expressions. With such an explanation, it is obvious that the concern of the Vedic Science is not just the knowledge of the absolute but its relative expressions as well. Its scope is holistic and enables the perceiver of the reality to approach the entire relative phenomenon with the simultaneous perception of the wholeness.

### 4 The Relationship between the Modern and the Vedic Science

With the above explanations, it is evident that it would be quite beneficial to understand the Modern Science just being a part of the Vedic Science. Their relationship may be observed as the relationship between a part and the whole. From the practical side, this attitude could give the Modern Science a new meaning. In fact, such a concept could resolve the basic problem of the Modern Science – the problem of *know what!* Without clear ideas of know-what, know-

how has materialized in powerful technologies which more and more appear to be a dangerous weapon in immature hands. Being aware of that, Maharishi Mahesh Yogi has formulated his Science of Creative Intelligence, which gives the foundation for the integration of the Modern Science and the Vedic Science. This achievement opens new horizons and offers a firm basement for the prediction of numerous authors that the XXI century science will be based on a completely new paradigm. Such a prediction is supported by the scientific frontier – the theoretical physics. Many supporters of the so called *New Science*, such as John Hagelin, [3] Firtjof Capra, [4] Margaret Wheatley [5] etc. argue that the XX century physics with Einstein's theory of relativity, quantum theory, the theory of chaos and the measurement theory necessitate a restructuring of the present concepts in all the scientific fields. The most thrilling of them all are the theories of the unified field. "These theories afford, for the first time, a self-consistent and completely unified description of the elementary particles and forces in terms of a single, self-interacting field" [3].

The greatest importance of the unified field theories is that they offer a possibility to approach the Self or the absolute from an objective standpoint.

Maharishi's comment on the unified field theories was: "The knowledge of the unified field has been discovered by modern science during just the last few years, but complete knowledge of the unified field has always been available in the vedic literature" [3].

### 5 The Total Theory of Value

Being familiar with Maharishi's Science of Creative Intelligence, Gerald Swanson and Robert Oates [6] have postulated the *Consciousness* or *Absolute Theory of Value*. This theory identifies the consciousness as the source of value. They explain that consciousness materializes through creativity, organizing power and teamwork into marketable products and services. In our opinion, this theory gives a great contribution to our understanding of the phenomenon of value but still does not close the subject. This is because value is observed in two dimensions only – the absolute and the objective, while the subjective dimension is still missing. This way, the Swanson & Oates theory appears to be just an improved version of the above mentioned objective theories of value.

We believe that Maharishi's Science of Creative Intelligence offers further possibilities for the development of our understanding of value.

From our point of view, the totality of value should be understood as a multidimensional phenomenon that consists of absolute and relative (subjective and objective) dimensions. Therefore, we might make a difference between the absolute and the relative – subjective and objective value and their interaction. In Sanskrit transcription these

---

<sup>a</sup> The ancient language of the Hindus in India



manifestations of value are expressed as *Samhita, Rishi, Devata and Chhandas values*.

*The absolute value (Samhita)* is unchangeable and unlimited. Being self-referral, the subject of appreciation, the object of appreciation and their interaction are all in one.

*The relative value* is always dynamic, limited and ever changing. Being dynamic, it could be better explained as a process of creation, evaluation and appreciation. Creation gives value its objective dimension (Chhandas), evaluation forms its subjective dimension (Rishi), while appreciation results in direct interaction between the subject and the object of appreciation (Devata).

The most important point in understanding the totality of value is to recognize *the absolute value as the source of both –subjective and objective value*. In order to be able to do that, it is necessary to develop the higher states of consciousness. How can it be done? Modern Science doesn't have answer to this question. The complete knowledge of consciousness dynamics and the technology for developing the higher states of consciousness belong to Vedic Science.

Generally, we are used to experiencing three states of consciousness: waking, sleeping and dreaming. Each of these states of consciousness is mentally and physiologically unique. However, it has been noticed that practice of transcendental meditation results in experiencing a state of consciousness, which is different from those, three. This state of consciousness was named the transcendental or the fourth state of consciousness.

It does not mean that people who do not practice transcendental meditation ever experience transcendental consciousness. In fact, it is everyone's experience each time one steps from one state of consciousness to another. Experiencing the transcendental consciousness always appears in the transfers from waking to sleeping state and from sleeping to dreaming state of consciousness. This is why Maharishi calls it the basic state of consciousness. The problem is that although we all share the experience of transcendental consciousness, only those who practice transcendental meditation are aware of it.

To make it clearer, we shall briefly describe the basic characteristics and differences between each of these states of consciousness. In waking and dreaming state, the mind is occupied with sensations of thoughts and feelings. As Dr. Paul B. Levine [7] explains, the essential difference between those two states of consciousness is in the level of awareness of our own existence. In waking state, we are aware of our existence while in dreaming there is no such awareness. In the state of deep sleep there are no sensations of thoughts and feelings, but at the same time there is no awareness at all. In transcendental consciousness the awareness of our existence is unbounded because it is no more restricted to any

particular sensation. In Maharishi's words, *the knower, the known and the process of knowing are all one*. The consciousness is fully aware of itself.

Development of the higher states of consciousness means raising the awareness of the Self or the pure consciousness. By regular experience of transcendental or the basic state of consciousness, the awareness of our existence gradually rises and causes qualitative changes in our perception of reality. As the awareness of pure consciousness stabilizes, its value becomes the living reality even in the relative states of consciousness. The awareness of our existence is not lost in the sleeping and dreaming states of consciousness. In the waking state, we are aware of our existence anyway, but the quality of this awareness alters. Before the regular experience of the transcendental consciousness we tend to identify our existence to sensory and mental experiences. As these experiences are always limited, the awareness of our existence is also limited. We think of ourselves as the beings of limited existence. By extending our awareness beyond the limits of the sensory and mental perception we avoid the intermediaries and experience the reality as it is. In the highest state of consciousness, the unity consciousness, the whole reality is experienced as an everlasting, unbounded and omnipresent field of consciousness that is non-vibrating and vibrating at the same time. In its non-vibrating, absolute state, the consciousness enjoys its own absolute value. In the vibrating state it creates and enjoys the relative values as the interaction between the subject and the object of appreciation.

Development of consciousness is followed by the refinement of senses. Our perception becomes subtler. This allows the recognition of the more delicate qualities in the relative, vibrating mode of reality and enjoyment of the finest relative values. The refinement of perception gives us the ability to perceive the totality of characteristics of the objects of perception and thus to make a distinction between true and quasi-values.

## **6 The Implications of the Total Theory of Value**

The Total Theory of Value offers a new and complete insight regarding the phenomenon of value. It solves the problem of its source and its absolute and relative manifestations. On the practical side, the major implication of this theory is that it brings a completely new light to the phenomenon of *wealth*. Our present understanding of wealth is identified with possession of valuables. Wealth is treated as something purely objective and measurable. The Total Theory of Value sees wealth as *creative power understood as the capability to create, evaluate and appreciate valuables*.

The present strategies of increasing wealth are mostly oriented towards valuables only. Such an orientation has caused an immense increase of

productivity in all areas, but with the increasing competition, many find it hard to keep up the pace. This results in severe stress problems. With the accumulation of stress in our organisms, the creative power decreases. What are the consequences? Sara Zeff Geber, an expert on stress claims that the results are startling: “Stress has surpassed the common cold as the most prevalent health problem in the United States. Between 80 percent and 90 percent of industrial accidents have been related to emotional problems. Stress-related injuries account for more than 70 percent of all absenteeism, and the loss to the gross national product from this drop in productivity is estimated to be nearly 10 percent. The American Institute on Stress calculates that stress-related illness costs the American economy \$100 billion per year. Productivity losses are estimated at \$17 billion annually. The insurance industry has calculated that stress-related disability claims have more than doubled during the last decade. This is passed on to the consumer as increased costs for coverage. The combined financial impact (increased costs plus lost productivity) on corporate America is a staggering \$68 billion annually” [8].

These figures reflect the decrease in power to create valuables. Is there any evidence on the evaluation and appreciation capability? John C. Mowen [9] claims that the research carried out in the United States by the end of 80’s showed that more than three quarters of American consumers are dissatisfied with the value of the products and services they bought during the past decade.

We certainly don’t want to rush with the conclusions. To do that we would need much wider evidence. But this shouldn’t stop us from questioning the valuables oriented strategy.

Facing the stress problems, there are a growing number of people who are criticizing the concept of competition. We don’t share their criticism. Competition is natural and nothing can stop people and companies from competing. But, as Maharishi says - *the element of naturalness is there in competition for those who are competent.* [10] In order to increase the competence we need to develop our creative power. Instead of valuables oriented strategy, the total value concept *introduces the creative power development strategy.* The source of creative power is *creative intelligence.* The application of the creative power development strategy means the *development of theoretical and practical knowledge about the origin, nature, development and the scope of the basic field of intelligence out of which the whole life emerges and is purified to perfection.*

## 7 Total Value Management

Total Value Management concept is based on understanding the totality of value and Maharishi’s Absolute Theory of Management. The purpose of this concept is full development of creative potentials on

all levels - individual, team, corporate, national and international. Total Value Management is a two-direction management. It is the management of the inward and outward stroke. By the inward stroke we experience the field of pure consciousness as the field of infinite, absolute value and intelligence. In its pure state, being non-vibrating, this field is the field of absolute silence and peace. But at the same time, it is the source of the infinite dynamism of its relative, vibrating manifestations.

By the outward stroke we carry out the transformations of the unified, absolute value into diversified, relative values.

The practical application of Total Value Management concept is done through the realization of the programs specially designed to ensure that both of these management strokes are performed naturally and smoothly. The structure of these programs is based on the most developed methodology of both – Maharishi’s Vedic and Modern Science.

## 8 The System of Value

The system of value is fundamental to individual and organizational behaviour. It represents a set of ranked values that an individual or organization finds desirable to achieve. If the system of value is consistent then the whole of behaviour is well balanced and meaningful, but once its coherence is lost, the consequences of its inconsistency will disturb the functioning of the whole system. It will be the cause of its crisis. The crisis itself denote the necessity to evolve. The Chinese symbol for crisis is made up of two characters: danger and opportunity. When the system of value is in crisis, the danger is in inertness which causes stagnation or the loss of creative power. As stagnation is nothing but the confrontation with the forces of nature, the stagnant systems are facing the problem of survival.

On the other side, the opportunity lies in development of the new, more refined system of value. Gradual development of creative power through Total Value Management programs makes it possible to harmonize with the evolutionary forces and to spontaneously develop the capability of creating, recognizing and enjoying value on all levels - the surface, as well as the most subtle.

## 9 Value and Love

Finally, we would like to point out the essential dimension of value that is missing in all the previous theories of value. It is the relationship of value and love. However, although not appropriately recognized in theory their relationship is clear in our everyday life. For all people, things or phenomena that have value for us we say that we love, like or adore them. Having this in mind, we might understand *value as the expression of love.* In Vedic Science, there are three basic forces that rule the universe: the force of love

and creation - Sattva<sup>b</sup>, the force of fear and destruction - Tamas, and the force of inertia - Rajas, which is complementary to both of them.

This completes our understanding of value and wealth. Total value is nothing but the expression of total love and wealth is the capability to create, evaluate and appreciate it.

From this perspective, the Total Value Management programs are oriented towards disclosing our hidden desires and dreams and to develop our competence to achieve them. Only genuine desires may be the appropriate motivation factor. Only the competent action may be the guaranty for achieving the desired results. Finally, only the achievement of the desired results may be the guaranty for satisfaction and fulfillment. The present programs, based on the Modern Science only, no matter how sophisticated are, can not produce these effects because of the consciousness limits. The increased pressure and competition do not cause the stress and strain. Their cause is the lack of capability of achieving the desired and fulfilling results. By raising the level of competence and creative power, all of our activities become the source of joy instead of struggle. The stress problems spontaneously disappear. But, as Einstein said, no problem can be resolved at the same level of consciousness where it appeared. This new concept of value and the practical programs based on it provide the opportunity to everyone to transcend the present problems by breaking the consciousness limits. By doing that, he will join those who have personally experienced Maharishi's claim that **life is bliss!**

## References

- [1] Microsoft, *Encarta Encyclopedia 97, World English Edition*
- [2] M.M. Yogi, *Science of Creative Intelligence* (Maharishi Vedic University Tape Library, Fairfield, Iowa, 1972).
- [3] J.S. Hagelin, Restructuring physics from its foundation in light of Maharishi's Vedic science, *Modern Science and Vedic Science* 3 (1989), p.4, p.ii.
- [4] F. Capra, *The Tao of Physics* (Bantam Books, New York, 1976).
- [5] M.J. Wheatley, *Leadership and the New Science* (Berrett-Koehler Publishers Inc., San Francisco, 1994).
- [6] G.Swanson, and R. Oates, *Enlightened Management* (Maharishi International University Press, Fairfield, Iowa, 1989), p. 163.
- [7] As quoted in: J.B. Marcus, *Success from Within* (Maharishi International University Press, Fairfield, Iowa, 1990), pp.92-93.
- [8] S.Z. Gebber, *How to Manage Stress for Success* (AMACOM, New York, 1996), pp.1-2.
- [9] As quoted in: B.R. Maričić, *Behavior of Consumers* (Savremena administracija, Beograd, 1996), p.346, in Serbian.
- [10] M.M. Yogi, *Corporate Development Lectures* (Maharishi Vedic University Tape Library, Fairfield, Iowa).

---

<sup>b</sup> In Sanskrit



## QUEST FOR ABSOLUTE: MATTER AND SPACE AS ONTOLOGICAL CATEGORIES IN QUANTUM PHYSICS, ARTIFICIAL INTELLIGENCE AND EASTERN THOUGHT

Biljana Percinkova

Electrotechnical Faculty, Department for Automatics and System Engineering, Skopje, FYROM

**Abstract.** In the paper first a brief survey of the concepts of mind developed by philosophers through millennia is given: (1) materialism (mind is a product of the brain, more exactly a by-product of the survival functions the brain performs for the organism); (2) idealism (mind is the ultimate reality; matter is but an illusion created by the human mind); (3) dualism (mind and matter are both fundamental but entirely different ontological categories; in humans they are associated through the brain) (4) holism (matter and mind constitute a whole that cannot be taken apart, either in thought or in fact); and (5) matter and mind are both real but they are not fundamental: they evolved together out of a still deeper level of reality. Then the interpretation difficulties in quantum mechanics are given and quantum epistemological issues presented including consciousness-based interpretations, Einstein-Bohr conflicting ideas, the definition of the collapse of the Schrödinger's wave function etc. The alternatives presented correspond to naive realism (ensemble interpretation/many - worlds interpretation), hidden-variable theories (David Bohm) and Copenhagen/observer interpretations. A consciousness-based dual-observer theory is then offered, based on the idea of matter and consciousness as different ontological categories uniting transcendental monism, dualism and materialism by assuming the reality of one universal observer, many individual observers and matter. The problems in artificial intelligence (Gödel's theorem of incompleteness, Turing's test) are treated through the prism of this theory. Comparisons to Gaudiya Vaishnava Vedanta of Sri Chaitanya and Advaita Philosophy of Shankaracharya have been done.

**Key words:** *consciousness, consciousness-based interpretations, quantum physics, matter and consciousness as ontological categories, artificial intelligence, Gödel's theorem of incompleteness, Turing's test, Gaudiya Vaishnava Vedanta, eastern thought.*

### 1 Cogito Ergo Sum. Quantum Epistemological Issues

Three hundreds years ago René Descartes set the foundations of modern science by excluding "the Mind of God" out of it; today, however the quantum physics is faced to the possibility either to bring it back, or deny the very foundations on which it resides.

"I think therefore I exist" means simply "I exist". If I exist, goes further Descartes' argument, there has to be an intelligence that created me - therefore God exists. If God exist, He being a reasonable person, would by no means deceive me - therefore objective

reality He created *really* exists. Although, put in this way, it may sound naive, actually this is the way the founder of the modern science set its foundations.

The objective science of Descartes and Newton is, however facing today serious barriers in the form of quantum mechanics, Einstein's relativity, the theory of chaos of Lorenz, Feigenbaum, Crutchfield, Shaw and the others and artificial intelligence with Gödel's theorem of incompleteness.

Although Pierre Simon de Laplace, the marquis, in his famous "*Traité de mécanique céleste*" said something like "give me exact and perfect mathematical relation and precise and excellent instruments, and I will predict the behavior of the Universe hundreds years in advance and describe it years in the past" we know today this will not be easy even for a genius he, no doubt, was. Heisenberg's principle of uncertainty shows us that we could have either the position or the velocity of a given subatomic particle correct to a given degree, and measure for this is Planck constant ( $\Delta v * \Delta x = h$ ); we could not have them both no matter how precise and extraordinary our instruments are. Correct mathematical model is also not enough; the theory of chaos showed us that slight changes in the initial conditions could cause dramatic changes in the dynamics of the nonlinear system and unpredictable, chaotic behavior. To this we could add Gödel's theorem which shows that even logic is not enough - that the moment the formal logical system becomes so sophisticated that in it we could present even statements about itself (system about the system, proof for the proof, mathematics about the mathematics), that moment we come to unresolvable statements. No more determinism means predictability.

The formalism of quantum mechanics which leads to interpretational difficulties can be introduced briefly as follows: the possible results for measuring certain physical magnitudes (called observables) on quantum systems are confined to a set of possible values (real numbers); it is, in general, not possible to predict which value a certain observable will obtain on measurement - we have only the probability for any particular value from a set of possible variables (Redhead, 1987). In the formalism of Born, we have:

$$\text{prob}_\psi (A \in \Omega) = p \quad (1)$$

where  $p$  is a real between zero and one (including those limits),  $A$  is a quantum dynamical variable,  $\Omega$  is a (Borel) set of real numbers, and  $\psi$  is the mathematical representative of a instantaneous quantum state, normally referred to as the wave function of the state vector. We can read the equation as follows: "In quantum state  $\psi$ , the probability of finding that the value of  $A$  lies in  $\Omega$  is  $p$ ". The task of the interpretation is to identify the physical meaning of these probability statements: Do these specify probabilities that a quantity has a certain value, that a measuring apparatus will or would record a corresponding result if the quantity is measured, or that a quantity will or would acquire a certain value upon measurement. The alternatives would correspond respectively to naive realism (many-worlds interpretation), hidden-variable theories and Copenhagen/observer interpretations (Fig. 1).

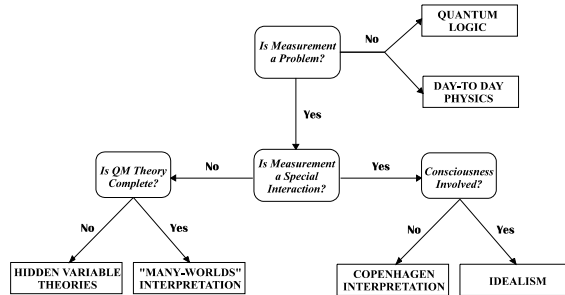

Figure 1 Interpretations in Quantum mechanics

It is visible in our chart that if we agree that measurement is not a problem, then one possible interpretation of Eq.(1) is the explanation given by the quantum physicists belonging to quantum logic; what they basically say is that actually everything is fine with QM - what is not all right is the fact that we have not yet developed quantum logic. Namely we are supposed to do what George Boole (born symbolically in 1815 - Waterloo and victory of England) did for computer science: build an appropriate logic. (Let us remember on this occasion that Boole was creating in England at the time when all the main discoveries in the science were on the Continent; isolated, he did something completely original - his logic.)

If we accept, however, that measurement IS a problem, then a possible question is whether it is an interaction between the observer and the observed. Again, we have two possibilities. If no, there are still chances for quantum mechanics to be complete. No, says David Bohm: it is not complete, and what is lacking are hidden variables. (It is interesting, that no other than Bohm himself, the heretic in quantum physics, who was communicating with Krishnamurti and developed the theory of the Universe as a giant hologram and holomovement, finally comes with a sound mathematical theory of hidden variables and implicate order behind the visible disorder.)

Yes, say Hew Everett and Paul Davies; QM is complete - what is not all right is our interpretation; our interpretation should be: all possible values of  $\Omega$  do exist, and every one of them creates a separate Universe.

But there are, indeed, indications that measurement IS a special interaction and that, perhaps, the consciousness of the observer (who, finally created the experiment) is involved; because, really if I throw away a stone and it breaks the window, I would not say that the stone (the instrument) broke the window, but myself. Bohr, however, in his famous Copenhagen interpretation and "no deep reality" statement did not agree. He had argued that physical instruments (silver bromide, Geiger counter) bring a measurement to a close with an "irreversible act of amplification" even without a conscious observer [Bohr, 1958, p.73 and 88]. (Bohr was convinced that physics is not even a science about things - it is simply way to look at them. Quantum physics is obviously correct, it produces results, the whole computer technology, the processors and laser technology is based on it - and what happens 'down there' we should not be interested at all. Many criticized Bohr that with this attitude he hold back the development of QM - maybe someone COULD found what happens 'down there' in subatomic world.)

Finally, we have the branch of pure consciousness-based interpretation and neo-idealistic view of everything that exist as a consciousness.

Here we could, briefly, remember the concepts of mind developed by philosophers through millennia: (1) materialism (mind is a product of the brain, more exactly a by-product of the survival functions the brain performs for the organism); (2) idealism (mind is the ultimate reality; matter is but an illusion created by the human mind); (3) dualism (mind and matter are both fundamental but entirely different ontological categories; in humans they are associated through the brain); (4) holism (matter and mind constitute a whole that cannot be taken apart, either in thought or in fact); and (5) matter and mind are both real but they are not fundamental: they evolved together out of a still deeper level of reality [called by some contemporary quantum physicists *the zero point field* (Erwin Laszlo, 1996)].

## 2 Difficulties with Consciousness - Based Interpretations

Physicists have seen several reasons for not introducing conscious observers within the theory. Quantum theory is thought to permit only one observer if the observer collapses the wave-function. A version of the argument (Everett, 1977) goes as follows: Consider the case of the observer A, who is performing measurements upon a system S, the totality (A+S) in turn forming the observed-system for another observer B. Let A make an observation on the system S (thus collapsing its wave function) and make a private "permanent" record of it. According to the

conscious-observer interpretation, S must evolve according to Schrödinger's wave equation until A makes her/his first measurement, at which point S would undergo a collapse. However, if B does not yet make a measurement on (A+S), then, according to B, the system S [which is part of B's observed system (A+S)] must still be causally evolving according to Schrödinger's wave equations, *even though A may be performing measurements on it and hence collapsing its wave function!*

As a result, we have either to postulate that only one and single observer is possible, or admit the incorrectness of QM. [And what is one and a single observer if not God? The gnostics had long ago defined God as a *observer observing Himself!* So, the QM has come to a point when it had proved the existence of God scientifically - or should eat itself.]

### 3 Proposal. Ontological Elements of a Gaudiya Vaishnava Vedanta in Eastern Thought

The idea of transcendental monism (single universal observer) has been consistently invoked in dealing with QM problem, since the basis for physics is materialistic monism [the notion that matter is the only reality]. However, considering many individual observers OR a single universal observer are not the only options available. We could consider a third option: many individual localized observers AND a single universal observer. Matter could be seen as the *context for exchanges between conscious observers!* (Ravi Gomatam, 1992). This proposal assumes extra inters when we note that it resonates with the ontological elements of a dualistic Vedanta school known as *Gaudiya Vaishnava Vedanta* called *achintya-bheda-abheda tatva* (the principle of inconceivable simultaneous oneness and difference); it was modern times most clearly propounded by Sri Caitanya of Bengal, five hundred years ago. Its chief distinguishing element is the conception of universal conscious observer (God), plurality of localized individual conscious observers (*jivas*) and the reality as a dynamic relation between these three ontological categories. Because it integrates the basic concepts of transcendental monism (universal observer), materialism (objective physical reality) and dualism (consciousness is nonphysical and different from matter), this pluralistic framework has potential to be relevant in a new way to quantum epistemological issues. While monistic Vedanta of Shankaracharya embraces the simple-minded notion that the physical world must be ultimately not real (*maya*), Gaudiya Vaishnava Vedanta provides a radically new definition of *maya*, *retaining physical reality as objectively existing!*

### 4 Information Exchange - A Paradigm for Measurement

*A Simple Example:*

How does this third option explain the measurement problem in quantum physics? Let us use the analogy with a book. The book has *primary properties* (its weight, length and so on, which exist independently from the observer), then *secondary* (its color) or *subjective* (it is my mother's present so it is valuable for me), *contextual* (I could use it as a paper weight, as a door stop or a little chair - I use different contexts for it, which had nothing to do with its real purpose: to convey a meaning) and finally *informational property* and this is the very purpose of its existence: the idea of the author. We have all three ontological properties: matter (the book physically), a set of individual observers (the readers) and one single universal observer (the author). In order to understand the very essence of the book we could perform different scientific experiments: to split it and burn it in order to understand its physical and chemical properties, measure it, analyze it with Geiger counter or a spectrometer and so on and so on. Seemingly the observer changes the observed object by the act of observation (and collapses the Schrödinger's wave function); still, its informational (designed) property - what the author (the universal observer) wanted to say - remains fully unchanged!! And this is the explanation.

Why are the results probabilistic and not deterministic? (Let us remind that Einstein never accepted this; he said: "God does not play dice" and "I am convinced there must a way to see things for what they are, and not only through their probability. Also about Heisenberg's Principle of Uncertainty: "I am sure the mouse could not change the Universe by simply watching it."). Let us use the same analogy, our book: I have a book written in Chinese and not knowing the language I want to determine if it is a drama; I see the paragraphs in it, and I say: "I am 60% sure this book is a drama." But I could not say exactly (deterministically), because I don't speak Chinese (information property).

*Wave-Particle Duality:*

We propose that wave and particle natures are, similarly, contextual properties which arise because we put light to 'uses' which are different from the ones originally intended for it. We perceive 'light' as a 'wave' or a 'particle' in different experimental interactions, but light remains *physically the same!* A unique physical configuration (light and the measuring apparatus) may accompany each contextual property (wave or particle), but *the two are not causally connected!* A measurement interaction does not physically change the light into a wave or particle. That is a contextual change.

## 5 Consciousness as Causal Element of Cognition

We could use the same philosophical view to resolve the dilemmas in artificial intelligence, by conceiving consciousness as a nonmaterial energy form to which the class of operators that effect changes in the states of matter can belong. This view corresponds accurately with the requirements of the issues of cognition (Gomatam, 1995). How can we understand matter and consciousness as two different energies? Energy, by definition, is the “capacity to perform work.” Matter is a form of energy which can not actualize its capacity for work *unless acted upon by an external causation!* When we conceive consciousness as the energy form different from matter [this belonging actually to body-mind distinction as a direct consequence of the understanding, explained above, for the universal observer, set of individual observers and matter as different ontological categories and to the philosophical understanding denoted as (5)], we immediately see what can be the difference between them: since consciousness by nature has to be sentient, as an energy, it will not only have the capacity to perform work but also to *actualize such work on its own*; and naturally, it can also *cause* matter to perform work!

## 6 Turing’s test Explained

If to this we add the understanding of GVV and Eastern philosophy of consciousness as different from matter by the characteristics of *self-consciousness, intentionality and causality*, the Turing’s test is no more an open problem! Since the interrogator has only the answers from both, a computer or a human, he by no means could determine where the answer came from. Namely, the computer is an acausal system (belonging to matter as ontological category and having the ‘cause’ for its existence in time previous to its own; not having therefore the characteristics mentioned above), and the human is a causal system (*with* the characteristics of self-consciousness, intentionality and causality); if we want to distinguish between them we must have not just the answers, but rather the fact whether these answers are produced by a causal or an acausal system. The test, as it is, *is not capable of providing this key information.*

These considerations could help us have deep insights also into the Gödel’s theorem of incompleteness (See: Percinkova: “Relativity, Chaos, Gödel”, 1994).

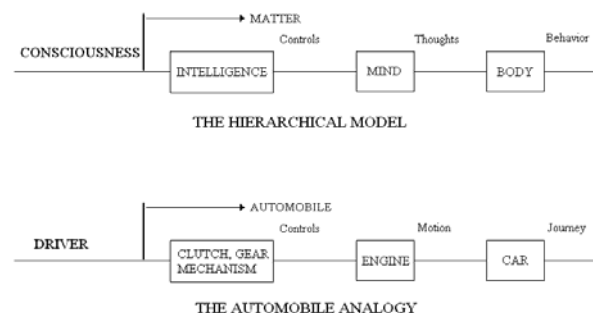

**Figure 2** Illustration of the basic elements of a hierarchical model proposed here compared with the analogy of an automobile.)

## 7 Conclusion

Can machines think? The hierarchical model which separates consciousness from matter (intelligence, mind and body) suggests that we should rather ask: “Can *we* think through machines?” The “we” of course refers to us as conscious entities. The model holds consciousness as the *only necessary and sufficient condition for causal cognitive functioning.*

The above considerations also help us understand the ancient Gnostic search for direct experience of Truth and realization of Self as the ultimate goal of the perennial philosophy. This justifies the “Who am I” quest as central endeavor of human search for Absolute.

## References

- [1] R.V. Gomatam, *Real and Artificial Intelligence: Can machines Think?* lecture held at University of Berkeley, CA, USA, September 1995.
- [2] B.R. Percinkova, *Relativity, Chaos, Gödel* (Sojuz na TIL, Macedonia, 1994).
- [3] D.M. Armstrong, *The Nature of Mind and Other Essays* (Cornell University Press, Ithaca, NY 1981).
- [4] M. Minsky, *A Framework for Representing Knowledge* (Hagueland, 1981).
- [5] A.C. Bhaktivedanta Swami *Teachings of Lord Chaitanya* (Bhaktivedanta Book Trust, Los Angeles, CA, 1976).



## PLANES OF CONSCIOUSNESS IN ESOTERIC PRACTICE: A COMPERATIVE APPROACH

Petar Vujičin

Božidara Adžije 22a, Belgrade, Yugoslavia

*Nothing whatever is hidden;  
From of old, all is clear as daylight.  
(Zenrin Kushu)*

**Abstract.** This paper argues that the study of the phenomenon of consciousness, and specifically of human states of consciousness, unlike the very recent preoccupation of the Western science with this problem, can be traced back to almost three millennia ago when it was investigated and personally explored by the sages of ancient India, who left behind written documents of their findings, which we know today as the Upanishads. The esoteric lines of other world's major religions have also pursued the investigation of consciousness in their own spiritual traditions as the most important subject-matter of all, arriving at virtually identical experiences and conclusions as the Upanishadic seers as to the nature of consciousness. The paper is focused on a comparative presentation of two esoteric practices which have been most articulate in the description of the results of their research: Upanishads, known under the collective term Vedanta (Hinduism) and esoteric Christianity as taught by a contemporary, venerable Cypriot mystic, simply called Daskalos (teacher). The striking correspondences between these two traditions have been found in all of their aspects, from the macrocosm, the structure of the Universe, to the microcosm, the structure of human selfhood.

**Key words:** *Hinduism, esoteric Christianity, mysticism, Brahman, Atman, Absolute, states of consciousness, consciousness, self-consciousness, superconsciousness, superconscious self-awareness, subconscious, selfhood.*

### 1 Introduction

Although scientific involvement with this problem is fairly recent (a *Foundation for the Study of the Consciousness* was established in 1952, publication of the *Journal for the Study of the Consciousness*), the origins of this interest probably go as far back in the past as the Upper Paleolithic<sup>a</sup> with the emergence of the shaman, the "technician of the sacred" and "the master of ecstasy" according to the classical definition of shamanism by M. Eliade. (Ecstasy in this context is used in the original Greek sense of "being outside of one's self", and not in the current use of ecstasy as being a state of rapturous delight or overpowering emotion.) Although shamanism is predominantly a religious phenomenon of Siberia and Central Asia, it

is also found in all archaic societies, with the same role and practices on all other continents.

In the context of this paper, it is more appropriate to define the shaman, this universal proto-religious figure and at the same time the proto-scientist, primarily as *the technician of the states of consciousness*. Because, in addition to his other characteristics such as mastery over spirits, power of healing the sick, telepathic communication with other shamans, mastery over fire, magical flight, etc., the ability to leave his body and journey to the sky or to the underworld, which means that his is possessing a mobile centre of consciousness, and that makes him a master of the states of consciousness.

In some magico-religious traditions shamanism has been transformed into a fully fledged religion, like Hinduism, while in others has fused with it, like the Bön practice with Buddhism in Tibet, or has continued to exist like an underground current side by side with the organized religion (Macumba, Candomble in Brazil, Voodoo in Haiti), borrowing certain elements from it (Roman Catholicism).

Along the way of shamanism's transformation into an organized religion with canonized sacred books, the former shaman has turned into a priest with his sacerdotal office, and gradually from a practician hierophant with paranormal powers, he became a ceremonial official and interpreter of the dead letter of religious texts, while all of his shamanic powers eventually atrophied<sup>b</sup>. An exception to this turn of the events is found in Hinduism, where the shamanism's former principal figure, the shaman, has retained this pivotal position in the religious life under the name of guru and together with it all the supranormal powers. What makes him a guru is not only his authoritative and knowledgeable interpretation of the Vedas, Upanishads and other sacred texts, but before all his disciplined practice in attaining higher states of consciousness.

<sup>a</sup> I see no reason why mankind should have waited until recent times to produce minds of the caliber of a Plato or an Einstein. Already over two or three hundred thousand years ago, there were probably men of similar capacity, who were of course not applying their intelligence to the solution of the same problems as these more recent thinkers (C. Levi-Strauss, [1]).

<sup>b</sup> For all history is in some measure a fall of the sacred, a limitation and diminution. But the sacred does not cease to manifest itself, and with each new manifestation it resumes the original tendency to reveal itself wholly. ...this history does not paralyze the spontaneity of hierophanies; at every moment a fuller revelation of the sacred remains possible.

So, the shamans, medicine men, ancient hierophants, prophets, seers, messengers, etc. - as they were named in various religious traditions worldwide, covering periods that are much earlier than the recorded history, were practitioners of techniques which made them masters of altered (not necessarily higher - as in the case of sorcerers, witch doctors and magicians) states of consciousness. While their successors in organized religions merely profess belief in their respective religion's dogmas, discouraging their congregations from independent research and empirical validation of these tenets, esoteric currents of world's major religions in an unbroken tradition have preserved the practice and resulting mastery of shamanic powers.

The cosmological aspect of shamanism includes the passage from one cosmic region (plane of reality) to another. This communication among the cosmic zones is made possible by the very structure of the universe, which is in general conceived as having three levels - sky, earth and underworld - connected by a central axis. This axis passes through an "opening", a "hole"; it is through this hole that the gods descend to earth and the dead to the subterranean regions; it is through the same hole that the soul of the shaman in ecstasy can fly up or down in the course of his celestial or infernal journeys.

The intradimensional communication is the exclusive prerogative of the shaman who translates this cosmological ideogram of three worlds into concrete personal mystical experience. The central experience as to the nature of reality is generally shared by shamans from diverse cultures and period of times, yet it is possible to find some extreme views, such as the position taken by the Jivaro Indians of South America, who maintain that the only reality is that accessible in the altered states of consciousness and that our everyday ordinary state of consciousness is just an illusion, or "lies". They say that any significant event in this world is the result of hidden events in that other dimension.

## 2 Consciousness in Esoteric Tradition

There are two different modes of scientific inquiry which certainly do not result from different stadia in the development of human knowledge, but from two strategic levels on which nature yields its secrets to scientific effort.

The great French anthropologist Claude Levi-Strauss refers to these two approaches as the worlds of the shaman and the scientist, which are two parallel modes of acquiring knowledge about the universe that have given rise independently to two distinctive though equally positive sciences. In these two fundamentally different modes of thought, one is roughly adapted to that of perception and the imagination: the other at a remove from it [1].

Ultimately, unlike institutional religions which are centered around a set of dogmas, what makes shamanism a science in its own right is that it is a

*method of cognition*, based on personal experience. However, with the establishment of major religions, shamanism was either suppressed by force or has been integrated into them, retaining its essence and thus giving rise to a hidden undercurrent, which is generally labelled as esotericism.

Orthodox science is looking outside, exploring the nature through the five senses, or through an extension of these senses in the form of technical instruments (microscopes, telescopes, etc.) and making conclusions about the world through mathematical abstractions and conceptual formulations.

Esotericism, on the other hand, is looking within, attaining a direct nonconceptual experience of indivisible nature of reality, which can never be limited to the dualistic nature of language, and where the answer is a higher level of perception, rather than words.

The choice and the fate of man now depend upon fusing these two artificially separated approaches to reality into a single discipline and upon his knowing himself through an exploration of states of consciousness other than his egoic consciousness.

The object of esoteric religions is to speed up human evolution and raise the mankind to a higher level of consciousness. As already stated, all major religions of the world possess this esoteric knowledge codified cryptically in their respective sacred books of Hinduism (India), Buddhism (South - East Asia), Taoism (China), Zen (Japan, Korea), Judaism/Kabala (Israel, Jewish diaspora), Christianity (Western World), and Islam/Sufism (Middle East, North Africa). Also, all religions are founded on revelation. Revealed knowledge is proceeding immediately by higher powers from the higher levels of consciousness or from human beings who have attained to these higher levels.

All world's religions can be traced back to their respective single founder, except Hinduism. These historical personages (Confucius, Lao Tzu, Buddha, Moses, Jesus Christ, Mohammed), having attained the highest levels of *superconscious self-awareness*, and tasting the experience of ultimate Reality and knowing their true nature beyond the identity with their body-ego consciousness, have left behind them maps of their journeys and described the disciplines and preparations needed to be practiced by anyone wishing to reach the same goal.

Acknowledging equal cognitive value of all of the above religious paths, for the sake of brevity and conciseness this paper will limit itself to a comparative presentation of two esoteric traditions, one Eastern and one Western: that of Hinduism (after the Upanishadic yogist [2]) and that of Christianity (after the venerable Cypriot Daskalos (teacher) [3]). Tables 1' and 1", and 2' and 2" give comparative presentations of the Cosmogony and structure of Individuated Selfhood in these two great traditions, implying (un)expectedly their striking correspondences [4].

**Table 1'. Upanishadic Cosmogony**

<b>BRAHMAN (ABSOLUTE REALITY)</b>	
The highest God, in Its unmanifested state and undifferentiated unity, containing all possibilities before the divine creativity. Absolute self-aware intelligence in spaceless and timeless potentiality. Inaccessible to human cognition and comprehension while we are grounded in the lowest three worlds of manifestation.	
<b>PRAJNANA-GHANA (CREATIVE CONSCIOUSNESS)</b>	
Between the Absolute and the World-Soul is prajnana-ghana, creative consciousness, when the Absolute has moved out of Its primal poise and become knowledge-will. This is a logical succession and not a temporal one, because the World-Soul must be there before there can be the world.	
<b>ATMAN (WORLD-SOUL)</b>	<b>ISHVARA (CREATOR-DESTROYER)</b>
Brahman manifested as the World-Soul, universal self existing in all beings, inanimate as well as animate, rocks and stones, trees, animals and men, although not realized in the same degree.	The creative aspect of Brahman. In its three functions taken separately Ishvara becomes Brahma (the creator), Vishnu (the sustainer) and Shiva (the destroyer).
<b>PRAKRITI (UNDIFFERENTIATED SUBSTANCE)</b>	
The seven worlds (lokas) are made by Ishvara of Prakriti, elementary, undifferentiated substance contained both in the mind and in matter. Prakriti is an effect of Brahman, so that Prakriti cannot exist without Brahman. These two are eternally inseparable. Prakriti has been defined as the effect or power of Brahman, the Reality. In other words, this illusion ( <i>maya</i> , in Sanskrit) of an objective spatio-temporal universe is projected by the Reality itself. Therefore, it follows that Prakriti and Brahman must be co-existent, and that Prakriti, like Brahman, had no beginning and will have no end.	
<b>SEVEN LOKAS (WORLDS):</b>	
The lokas, planes, interpenetrate. Each plane has its own matter of an appropriate degree of density, which interpenetrates the matter of the plane next below it. In each world the soul develops a new and higher sense of power. When we pass from one dimension to another we do not move in space, but simply change the focus of our consciousness. We have different vehicles (bodies) within ourselves which correspond to and which can function in different worlds. The worlds occupy the same position in space.	
<b>(7) BRAHMALOKA, (6) TAPOLOKA, (5) JANALOKA, (4) MAHARLOKA (SUPRAMENTAL WORLDS)</b>	
The original Vedic description of the world contains three regions or three spheres: bhurloka (earth), bhuvarloka (astral world) and svargaloka (heaven or mental world). Having attained the highest states of consciousness, the Upanishadic seers have explored and named additional four higher worlds which can be visited and experienced only by self-realized beings. The four supramental worlds are of very rapid and high frequency vibrations, and as such are beyond the reach of ordinary human beings and of their power of conceiving them.	
<b>(3) SVARGALOKA (HEAVEN OR MENTAL WORLD)</b>	
The mental plane interpenetrates the astral plane, but also extends further into space. This heaven is a thought world, a realm of intense ideation. Whatever one wishes, one gets it at one by immediate materialization of thoughts. Every man builds up his own heaven according to his own desires and imaginations. A life in heaven is very much the same sort of life we lead on the earth level, only much more intense. This heaven is also not permanent. Once we exhaust the fruits of good karma accumulated in the previous life, we have to come down back to the earth world, to start a new incarnation.	
<b>(2) BHUVARLOKA (ASTRAL WORLD)</b>	
The astral world interpenetrates the earth plane and extends some distance beyond it. The vibrations of the astral world are more rapid than those of the physical plane. The lowest planes of the seven sub-planes of the astral world are called narakas (hells) or asurya lokas (sunless planes) peopled by departed humans with beastly natures and with no good in their hearts. One of such low planes is occupied by the persons with uncontrolled passions and strong sense-cravings, and thus is often called Preta Loka, plane of hungry ghosts (hungry for sensuous experiences of the earth world).	
<b>(1) BHURLOKA (THE EARTH OR "PHYSICAL" WORLD)</b>	
The "physical" world where we get knowledge of objects through the five jnana-indriyas or organs of knowledge, i.e. the senses of seeing, hearing, touching, smelling and tasting.	

**Table 1''. Daskalos' Esoteric Christian Cosmogony**

<b>A. THE STATE OF BEINGNESS</b>	
<b>ABSOLUTE INFINITE BE-NESS (ABSOLUTE INFINITE REALITY)</b>	
That aspect of Absolute lying beyond the reach of human and archangelic comprehension. The Ultimate Source, fathomless, and inarticulate depths of the Divine, beyond expression ("... for no man hath seen God at any time" 1 John, 4:12).	
<b>ABSOLUTE INFINITE BEINGNESS (GOD THE FATHER)</b>	
What we can know of God we see in reflection as witnessed both externally and internally. Absolute Beingness is above all the Divine Common Selfhood, consisting of Absolute Beings within the One Being. Absolute Beingness manifests Itself as the Logos and the Holy Spirit, "and these three are one" (1 John, 5:7). These Absolute Beings are Holy Monads, eternal entities, Logoic and Holyspiritual Archangelic Orders, whose self-consciousness gives this One Reality an appearance of multiplicity.	
<b>WILL-PLEASURE (EUARESKEIA)</b>	
Absolute Beingness expressing Itself in Itself as Creation. The Will-Pleasure, in Greek euareskeia, carries a sense of pleasure derived from bountiful giving, as practiced by a warmly generous and wealthy source. God's pleasure in creativeness.	
<b>CHRIST LOGOS</b>	<b>HOLY SPIRIT</b>
The Logos, the Divine Common Selfhood, is Absolute Beingness manifested as Self-superconsciousness.	Impersonal Superconsciousness that expresses the Omnipotence of Absolute Beingness and makes possible the creation and preservation of the Universes. The dynamic aspect of Absolute Beingness as Omniscience and Omnipotence (closest to the concept of Nature used by scientists).
<b>MIND</b>	
Mind is bearer of all life. Everything that exists is made of Mind at varying frequencies of vibration, from super-substance to solid matter. Mind is an emanation of Absolute Beingness imbued with the Total Wisdom, Love, Power and Purity of its Creator. Mind is not an immortal Being, but substance eternally used in all Creation. Mind is divine at its source, and holy in its expression.	
The purpose of Mind is the creation of the universes. Although it is only a medium, it also has some form of consciousness, which is expressed as the laws of the material plane.	
<b>B. WORLDS OF EXISTENCE:</b>	
<b>a) WORLDS OF ONENESS:</b>	
<b>SEVENTH, SIXTH AND FIFTH HEAVENS: CAUSAL WORLDS</b>	
Above the noetic worlds, less tangible heavens called the causal worlds give definition and order to grosser material universes. The non-dual conditions of pure Love, Causes, Principles, Laws, and Ideas of Creation, cared for by the highest echelons of the Archangelic Orders, exist here in their archetypal state.	
These heavens can be investigated only by higher aspects of human consciousness.	
The causal planes give rise to the higher noetic planes.	
<b>FOURTH HEAVEN: HIGHER NOETIC WORLD</b>	
Higher mental world. Here there are discernible forms in juxtaposition to one another, as yet unexpressed, in perfect harmony and order. A state of ideas in the Eternal Now. From the noetic world the Archangels derive the forms for creating and sustaining the phenomena of life. This is the state where we may come to rest in between incarnations.	
<b>b) WORLDS OF SEPARATENESS</b>	
<b>THIRD HEAVEN: LOWER NOETIC WORLD</b>	
Lower mental world. The most rarefied of the three Worlds of Separation. In the noetical world - the world of thought and home of the noetic body - Total Wisdom of Absolute Beingness first finds expression as thought-forms, ranging from galaxies to unicellular organisms. This is a world of seven planes, each with seven sub-planes.	
<b>SECOND HEAVEN: PSYCHIC WORLD</b>	
The world of emotions. This super-sensuous world is also composed of seven planes, each having seven sub-planes. The lowest three of these seven planes are the so-called "hells", the fourth corresponds to the idea of "purgatory", and the highest three are the so-called "paradises". When we leave our gross material body, undergoing the sudden change we call "death", we first go to one of these planes using there our psychic body.	
<b>FIRST HEAVEN: GROSS MATERIAL WORLD</b>	
The lowest vibration of Mind. Mind made solid to compose the three-dimensional gross material world and body. Earth's gross material body is the planetary sphere.	

**Table 2'.** Upanishadic Structure of Individuated Selfhood

<b>BRAHMAN</b>
Absolute Being whose essential nature is defined as <i>sat</i> (self-being), <i>chit</i> (self-consciousness), and <i>ananda</i> (self-delight). The super-personal transcendental being anterior to any concrete reality. Our true, absolute Self.
<b>ATMAN</b>
The innermost Self of any living creature or object and divine essence of individuality.
Between the Atman and Brahman there is no duality: it is one and the same Reality, the same God, viewed in its two relations toward the Universe. It is both inside and outside, present here this moment and infinitely far away at some other place, in the heart of atom and in all things.
<b>JIVATMAN</b>
The living individual's higher self, the individual as embodied soul in the universes.
<b>JIVA</b>
The individual as a human being incarnated in the worlds of separateness (the lowest three worlds) expressing a space-time personality. This personality consists of three characteristic elements. <i>Manas</i> is the recording faculty which receives impressions gathered by the senses from the outside world. <i>Buddhi</i> is the discriminative faculty which classifies these impressions and reacts to them. <i>Ahankar</i> is the ego-sense which claims these impressions for its own and reacts to them - it is what we create our personality or our egoism. ("To identify consciousness with that which merely reflects consciousness - this is egoism" Patanjali, II.6). If the thought-wave is pleasant the ego-sense feels, "I am happy"; if the thought-wave is unpleasant, "I am unhappy". It follows then that as long as there is this false identification of our body-self with these thought-waves, with our egoism, man can never know his real Self, the Atman.

## References

- [1] C. Levi-Strauss, *The Concept of Primitiveness, in Man the Hunter* (Aldine Publishing Co., New York, 1968), p.351.
- [2] E.Easwaran, *The Upanishads* (Arkana, Penguin Books, London, 1987).
- [3] K.C.Markides, *The Magus of Strovolos* (Arkana Paperbacks, New York and London, 1985); K.C.Markides, *Homage to the Sun* (Arkana Paperbacks, New York and London, 1987); K.C.Markides, *Fire in the Heart* (Paragon House, New York, 1990).
- [4] P. Vujićin, States of consciousness in esoteric practice, in D. Raković and Dj. Koruga, eds., *Consciousness: Scientific Challenge of the 21st Century* (ECPD, Belgrade, 1995), pp. 87-134.

**Table 2''.** Daskalos' Esoteric Christian Structure of Individuated Selfhood

The Individuated Selfhood, in all of its various manifestations, is in the image and likeness ° of Absolute Beingness (Genesis, 1:26). (In the Hebrew original <i>Elohim</i> , which means 'many gods', said "Na'aseh Adam betzalmenu" - "Let us make a man in our image, after our likeness".
<b>HOLY MONAD, SPIRIT-EGO-BEING</b>
This is our real Self, in at-one-ment with the multiplicity and self-sufficiency of Absolute Beingness. The Spirit-Ego-Being projects a ray of Itself into Creation. The Will/Pleasure of Absolute Beingness to express Itself in Itself, is identical to the Will/Pleasure of the Spirit-Ego-Being to express Itself in Itself. The Spirit-Ego-Being is not really an expression of the Selfhood, rather it is a creator of the Selfhood.
<b>SOUL-EGO-BEING, SELF-AWARE SOUL</b>
We become a Soul-Ego-Being or Self-Aware Soul the moment a ray of the Spirit-Ego-Being passes through the Human Idea, at which point our Self is understood as something complete, yet seemingly separate from the whole. The Self-Aware Soul with its projections is both Beingness and Existence.
Self-Aware Soul, which is formed of Spirit, then begins to express Itself. As the Soul is of incorruptible Spirit, it is self-sufficient and omniscient. All Souls are equally luminous. The Soul can never be harmed or weakened in any way, so "Fear not them that kill the body, but are not able to kill the soul" (Matt., 10:28). It is the Soul which distinguishes humans from other Beings, for archangels have no need of a Soul as they each belong to a communal order. It is the Soul that harbours the divine individuation of each human Spirit-Soul-Ego when we return to Absolute Beingness. The Soul is the womb of self superconsciousness.
<b>PERMANENT PERSONALITY</b>
Our higher or inner self. Described as "the feet of the soul", this self is an expression of, and in union with, the Self-Aware Soul in the worlds of time and place. The Permanent Personality contains the Divine Laws, Total Wisdom, Total Power and Total Love. The task of the Permanent Personality is to select and supervise the lives and experiences of the present-day personalities through its various incarnations. That part of ourselves upon which the incarnational experiences are recorded and are transferred from one life to next.
<b>PRESENT-DAY (TEMPORARY) PERSONALITY</b>
This is the personality we express in each individual incarnation. It is the projection of the Permanent Personality into the Worlds of Separation and their subplanes. It is that aspect of the Self which experiences emotions, desires, and thoughts, of which a character is formed. With time, this personality learns to interpret the impressions and correct its reactions, so that a refined personality develops. It is this expression of the Selfhood that Jesus asked us to "deny" (Matt., 16:24) so that we may better understand our Real Self.

°a) We have *self-sufficiency*. As Absolute Beingness is without any needs, we contain within us everything. "The Kingdom of Heavens is within you." We lack nothing and need nothing that we do not already possess.

b) As Holy Monads, we can express ourselves *self-consciously* within our own universe and within our own selfhood. In a similar way, the Logos expresses Its Self within Its universes as the Common Selfhood.

c) We have the power of shaping the Mind substance into thought and emotion, and of expressing ourselves as love. And when deemed worthy we are awarded the gift of *emanating*, not merely *shaping*, the Mind super-substance, the bearer of life.

d) We have been blessed with the gift and the *responsibility of procreation* for other incarnated Souls. In this way we are co-creators within the Divine Plan, with the Holy Spirit, the Holy Archangels, and the Christ Logos.



## PSYCHOPORTRAIT

Petar Perović

85300 Petrovac, P.O. Box 63, Montenegro, Yugoslavia

*I discover the law in its many-sidedness  
with regard to the inclinations and leanings of the creation.  
I use various means to incite everyone  
in line with their own character  
(Bhagavad Gita)*

**Abstract.** Psychoportrait is an artistic novelty whose importance and influence will be verified and detected progressively. As a piece of art it originates in artist's impulsing in the meditative states, which belongs to the sphere of religion. The interpretation of Psychoportrait belongs to the area of philosophy, and verification of correctness of its guidance belongs to science. The Psychoportrait can be approximately described as artistic, symbolical expression of momentary phase in evolution of person's determination and leading pattern.

**Key words:** psychoportrait, abstract art, meditation, transpersonal communication/expression.

Psychoportrait has originated as a response to the question: "How should I know what suits whom best?" It is an artistic, abstract idea of the current affinities of the person and his or her capacities - time aspects of the pattern of the law governing the totality of existence (cf. Fig. 1).

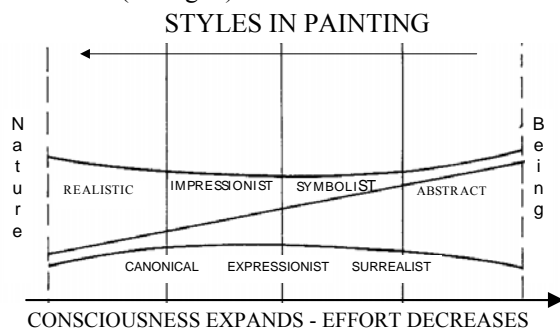

**Figure 1.** A Schematic process of abstraction from nature to being, expressed in different styles of painting, in relation to expansion of consciousness. Psychoportrait belongs to abstract styles in painting.

The artist expresses through his work the quality of consciousness from which the work has emanated. With an original, artist style is precise indicator of his level of evolution. Any creation from an inadequate level of consciousness is deficient and harmful as it disrupts the main purpose of art: to elevate life on Earth, through a work of art, by emitting subtle vibrations and an inexhaustible meaning produced by higher states of coherence.

Creative process of a highly spiritual art like psychoportrait is only possible by a "sidhi samjama" technique. This means that it cannot be learnt or transmitted to others, but it can only be an automatic product of evolution.

Programming of an artist is different for different levels of consciousness. The intention is preceded by a state of pure consciousness, by silence in the artist's being. The more profound the silence, the easier, the more spontaneous and more powerful is the creation, and the outcome - a more truthful form.

Artistic creation is peace in movement or dynamics of peace. Abstract art at its best means that the artist no longer expresses his personal, class, ethnic, or racial peculiarities, but universal human characteristics. That is why such works are everywhere and in all times equally young/old, always valuable.

*"When dancing be a dance and not a dancer  
at the moment when you are just movement  
the unseparated awareness is meditation"  
(Osho)*

The current of directing impulses in state of pure consciousness for any programme - intention follows the "principle of internal necessity". Psychoportrait can be expressed in any artistic form as a pure intuition, a spontaneously occurred energy "registration". This will be of particular importance in holistic architecture, where an adequately viewed psychoportrait appears as an ambient nucleus, as a basic architectural pattern.

The dynamism of psychoportrait is implied, which means that it is necessary that entire life structure be dynamized (including those areas which traditionally were inert, static).

Psychoportrait can, if necessary, have unlimited aspects. The aspects range from a level of greatest universality, to the level of fragmentariness.

Colour determines the level, and the form - the content (cf. Fig. 2).



**Figure 2** Psychoportrait of the four persons, differing in colors and degrees of lateralization.

The interpretation of a psychoportrait is contextual (according to I Ching). This is possible since the forms of psychoportrait originate from a level of consciousness where polarities have been transcended, therefore, rather than being bearers of information, they are bearers of a sense (unseparated meanings). The impulse course during creation of a psychoportrait

is manifested as a pure line-drawing. This indicates the possibility that psychoportrait may be performed as a techno-spiritual art.

Freed from the routine, craftsmanship part of work, the artist would be dedicated to creative innovation.

It should be emphasized that the imitative, repetitive work is within the competence of the left

cerebral hemisphere and that it can be transferred on to technology (as an extension of the left cerebral hemisphere). The capacity of spontaneous, unrepeatable activity is within the competence of the right cerebral hemisphere and it cannot be replaced by technology. This is just an indication of the increasingly difficult distinctions between artistic and other activity.

The objective of the cultivation of consciousness is reaching the level of evolution which will make it possible that every moment will bring one discovery of one's true inclinations in order that one should, with a minimum of effort, achieve maximum of the most favourable effects for all.

Orderliness of the composition of the psychoportrait indicates the level of development of the person. In accordance with this, the appropriate manner of education, treatment, communication, conduct and action can be chosen, as well as the appropriate recreation, diet, clothing, ambience, etc.

People with similar affinity have similar psychoportraits. It has been noted that relatively harmonized groups of people (friends, families, teams) are composed of persons with largely similar psychoportraits.

By comparing psychoportraits of the same person over time one can get an insight into his or her evolutive headways, changes of affinities, the range and types of creative potential.

Psychoportrait can be utilized as a means for entering meditation, for relaxation...

We can only guess for what purposes it will be possible to use psychoportraits in future. These powerful pictures generate an atmosphere of peace, ease, harmony, joy, which proves that they considerably affect the expansion of consciousness. This is only to be expected, as here we have highly organized, spontaneously created perfectly pure forms and pure colours.

Psychoportrait teaches us that one of the main human rights is the right to individuality, which, freely, fully and sincerely expressed, is always spontaneously harmonized with the individualities of the others. The fact that the society is ridden with so many conflicts shows that the distinctive qualities are not given an opportunity to manifest.

This is why in the periods to come the art will have a growing influence, since the main objective of the artist is to spur the evolution of the people and their environment.

## References

- [1] Patanjali, *Sayings on Yoga*
- [2] Swami Vivekananda, *Raja Yoga*
- [3] Osho, *Eternal Pilgrimage*
- [4] P. Russel, *TM for Sceptics*
- [5] V. Kandinsky, *On the Spiritual in the Art*
- [6] *Bhagavad Gita*
- [7] *Natural Law*, No. 10



## TRANSPERSONAL PSYCHOLOGY IN THE LIGHT OF THE LATEST NEUROPHYSIOLOGICAL RESEARCHES

Stevan P. Petrović

Gospodar Jovanova 19, Belgrade, Yugoslavia

**Abstract.** From time immemorial, man has undergone, spontaneously or in an induced way, experiences of non-ordinary reality, which differ fully, by its content, from the view of the world originating from the description, given to us at the moment of our birth. Many paranormal phenomena and spiritual experiences of prophets, saints and shamans obviously demonstrate that the human soul sometimes can function in ways which are "impossible" from the aspect of our modern physical view of the world. With the appearance of transpersonal psychology on the scientific stage not only that such experiences have not been rejected, but they have moreover been affirmed through claims that our conceptual schemes, officially accepted by the orthodox psychology, are inadequate to explain altered states of consciousness, because it excludes *a priori* the possibility of transcendence of the consensual reality. In this work, we have tried to provide support, in the light of the latest discoveries in molecular biology and biological psychiatry, to the basic assumptions about the transpersonal experience through the newly discovered normative structures, functions and subsystems of the soul, acting on the information by transforming it in various ways, but where the foundations are always the events at the level of a nervous cell. We expect that this research will finally demystify the transpersonal experience and transfer it, finally, into the competence of official science.

**Key words:** *Transpersonal Psychology, Neurophysiology, nervous cell level.*

In spite of the fact that the idea about the phenomenon of transpersonal psychology, as a serious science, could be surmised in the concepts of William James only at the beginning of this century, it took fifty years until numerous transcendent states, experienced by man through thousands of years, about which the orthodox science at best does not like to speak, got both a clearer articulation and a place within the framework of "trans-humanistic psychology", described by Abraham Maslow [1] as the "Fourth Force" of psychology. Transpersonal psychology is grounded upon the basic assumption that the Ego, and the so-called, consensus reality are an illusion only and that, therefore, our image of the world is distorted. For centuries the Sufis have been quite aware of the effects of our constrained categorial system upon the consciousness and perception. Thus, according to transpersonal psychology, our consciousness is basically a selective and constructed consciousness, a projected model, whose basic determinants are automatism and a limited categorial system [2].

However, Maslow thinks that the illusion of the external world could be transcended in special states of consciousness, that is to say that breakthroughs of the mind are possible toward other tempo-spacial coordinates, as well as identifications with other forms of consciousness, phenomena or states [3].

Although until recently, the transpersonal experience was a subject of mainly empirical research and verification, it is not at all disputable as a form of non-ordinary reality and as a private experience of many people throughout history, but also as a potential given to anybody, which however not everybody has been able to utilize during his lifetime [4].

Transpersonal experience (before all trance and also mystical and religious ecstasy) as a personal experience of man, spontaneous or provoked, has its long prehistory, which origins get lost in the darkness of forgotten times. Due to its dominantly spiritual component and noneveryday appearance, sudden and by nothing announced sprouting in the flash form, enlightened allpermeating or puzzling of occurrences in the subjective experiencing space, all of what is aheading the every day experience, so that it couldn't be always described by words nor invoked again wishing it whenever somebody wants it, such form of human experience remained for many years out of the interest of official psychology - psychology engaged for a long time and still engaged only in the aspects of soul which can be studied and researched in laboratory conditions, measured or observed through the attached physiological parameters or forms of defoliated behaviour, consistent to the greatest extent.

With the appearance of A. Maslow, the transpersonal psychology enters finally, even though through a small door, into the psychological science as the "Fourth Power", although still mentioned in a shy manner, or being read as a noncompulsory reading selection. Not before the latest discoveries in the field of molecular biology and the relatively new field of biological psychiatry, as the somatic foundation for the understanding of the soulful and spiritual life of a man, also his spiritual dimension enters the sphere of the science official interest. Finally, it becomes clear to everybody, even to the greatest skeptics, that everything what is happening in the sphere of soul and spirit has its unavoidable assumption in the happenings at the level

of the activity of neurons. For the beginning, it will be quite enough for many paranormal phenomena (out of body experience, telepathy, clear observation, precognition, or, let me say, journeys through space and time) to start to be understood and investigated in laboratory or clinical conditions in a more serious manner.

It was contributed also, to a great extent, by the study and discovery of the neuropeptides role (endorphin and enkephalin) which take an important place in the transfer of information as the impulse transmitters and neuromodulators with a codified message from a neuron to a neuron in their original meaning, but those neuropeptides can alter them or, under certain conditions, transfer them to a completely new receptor complex, provoking in such manner, the experience of a newborn, or of a different aspect, of the, so called, consensus reality, by a consciousness quantum jump to a new level. Its consequence is a transpersonal experience - therefore an experience which flee away from the entries of former experiences of given time and space. In new time and space, everything is different than usually.

Therefore, in the light of the latest discoveries, cease all dilemmas regarding previous suspicions whether the psychopathological conditions and processes, like also the *consciousness advanced conditions* to preexistentially subjective experience, begin and then develop at a level of a neuron, both inside a very cell structure, and within the frame of a process of transmission and neuromodulation inside a synapse, because in both cases, in a different way, it comes to important qualitative and quantitative changes of integrative functions in certain brain areals. In that manner, really begins a new function of the molecular organization of the transfer of information, and, consequently, the disturbances which damage the development of biologically learned and established integration processes, creating a foundation for the extraordinary occurred happenings which could be, under certain circumstances, phenomenologically expressed through *advanced conditions of consciousness* or *transpersonal experience* (but equally also the psychopathological experiences of the transformed reality). Such discoveries leave, to a great extent, a door ajar to new adventuring spaces, but they also helped the redefinition of some transpersonal experiences and the making of some indispensable distinctions among the conditions which have been found synonymous up to the recent time. Here, I mean, first of all, the *trance* and *ecstasy*- states, being regarded as identical by many scientists in all their aspects, but which are not identical anyway.

Among the conditions of altered consciousness, *trance* takes a special place, both regarding its special characteristics and the very free interpretation of that concept, by physicians, psychologists, anthropologists, people from the world of literature, etc., what unnecessary produces conceptual mess and the utilization of some other conditions of altered

consciousness (exaltation, ecstasy, mystical experience, religious experiences) in a synonymous meaning. By this reason, and particularly in the light of the latest discoveries at the level of the cell activity of neurons [5,6], a need appears for a closer *trance* definition, as a concept and special condition of an altered consciousness and of a creation of necessary delicate distinctions with some *trance* related or similar conditions, starting from, at least, two assumptions:

(a) *Trance* and *ecstasy*, as the dominant appearing forms of the condition of altered consciousness, or of the transpersonal experience, have always their unavoidable neurophysiological foundation and get developed at the level of intracellular and transsynaptic changes of information from the external reality or from the opening of new possibilities for the decoding of up to then hidden messages, being stocked in the region of the unconsciousness, which could not be recognized under the usual circumstances, and, therefore, not be brought back to consciousness in the form of recognizable or symbolic forms. If we take into consideration the total number of neurons in CNS, and the huge number of synaptic contacts of one nervous cell postsynaptic membrane (20,000-200,000), then we could make an insight into the practically unlimited number of contacts and ways of the information spreading, what, for a consequence has the possibility of the beginning of various conditions of consciousness, and many of them could deviate from the condition of a, so called, conscious awareness [7]; and

(b) Regarding the conspicuously different EEG record (first, in the form of the extinguishing or the discontinuity of *alpha* activities, in the time of the incipient happenings at the level of purely corporal happenings, and, after that, the reappearances of regular *alpha* activities at the moment of the beginning of an ecstatic experience, which means a purely mental act) and the attaching physiological parameters, which could be recorded, the *trance* and *ecstasy* are related, but not also the identical conditions.

*Trance* thanks to the modulation of original impulses, which in their altered form cannot be identified by their receptors on the postsynaptic membrane, look for other receptors and, when they find them, if it happens at all, diverge the observation of the consensus reality [7] or become able, by some other information system, to observe alternative realities, for which just the other receptors are responsible, creating in that manner a new sensibility, or a transpersonal experience. Conscious awareness [7] gets suspended and the body acquire all properties of a nonliving body (breathing and the heart activity are very slow, limbs are rigid and motionless, eyelids are closed and the surface and deep sensibility are in a state of anesthesia. Such state of corporal functions means *trance* in the narrower sense of word. Conditions for the beginning of the so called process of *somato - psychical dissociation* and, conditionally said, the separation of soul from the body, get realised gradually in the field of altered observation. The soul, free of corporal limits,

begin a, by nothing disturbed, journey through new and up to then unknown coordinates of some other time and space. Not before the realization of the separation and partial liberation of soul from the body, we can speak about the *ecstasy*. So, *trance* only is the neurophysiological assumption for the experiencing of a new reality. *Trance* is a pure physical state without experiences, and *ecstasy* is the very experience, state of liberation of spiritual from corporal *me*. However, it is important to point out that, although the soul during ecstatic experience becomes a sort of freedom, such freedom does not mean also the acquisition of an absolute autonomy. Links between soul and body are not broken definitely. To be clear, soul and body, as the aspects of the same *one*, make mutual subsystems [8] at any time.

The best proof for such claim is the fact that if happenings on the foreground of corporal get stopped or modulated by an act of violation, *ecstasy* will be broken brutally, and the conscious psychosomatic balance, typical for the condition of conscious awareness, will be established again.

Triggers for the beginning both of *trance* and of *ecstasy*, as well as of other conditions of altered consciousness, could be of internal (disturbance of metabolism and endocrinal functions, CNS intoxication, sudden brain hypoxia, organism dehydration, febrile states, long hunger, fasting, etc.) or of external (strong emotional adventure, experience of a direct vital endanger, sensory deprivation, sudden alteration of environmental situation, mental induction, caused by other persons) origin. Both states can begin spontaneously or they could be provoked. When we say *spontaneously*, we do not think about the beginning of something what begins by itself, without any real internal motive. There is always a motive even at spontaneously started happenings, we just do not know its trigger. In such case, spontaneity should be understood as an optimal condition between the excessive inhibition and the excessive excitation, established below the consciousness threshold, not announced by any recognizable signal. It couldn't be even felt as a premonition. For that reason, when all conditions appear for the quantum jump of consciousness to some new energetic level, it will happen suddenly, in the form of a flash and fascination. The induced conditions of altered consciousness could be acquired through yoga, Zen and other forms of meditation: prayer, ritual dance (dervishes, for example), monotonous singing, self-torturing, sensual deprivation, forced postponing of dream, fatigue, hungering, influence of physical and spiritual traumas, psychotic episodes or by the intoxication with certain psychotropic substances (LSD-25, mescaline, etc.), psychopharmatics, or under the influence of certain biological substances (endorphins, enkephalins serotonin, dopamine, etc.).

Anyway, regardless the cause of the altered consciousness origin, whether it arrived from the organism or from a certain external surrounding,

whether experienced as internal state or an external projection, it unavoidably has its organic basis at the level of the brain neuron constellation. Every adventure, everyday and usual, unusual, alternative, abnormal or pathological it is always a cause of synchronic functions, where every cognitive, emotional or behaviour complexity represents a form of defoliated reflection of dynamic relationships of numerous transmission and modulation systems.

The character and the sort of adventure depend always upon the topographic distribution of receptors within the substance of the brain, that is to say upon the regions where appears the synthesis of appropriate transmitter, as of the carrier of some message. Therefore, the functional specialization of certain brain region is the fact upon which depends the manner in which will react a transmitter or a neuromodulator, and, therefore, also the adventure character.

The disturbance of integrative processes in strictly defined anatomo-physiological functional entity, which determines, at a biochemical level, certain characteristics ("Features Markings") and conditions ("Condition Markings") of individuals according to which it gets defined, brings to the outflow of the behaviour single modalities, to the change of how the external reality gets experienced, or to the inclusion of some completely new sequences, organized in some, up to then, quite unknown way.

The American Nobel Prize winner, Linus Carl Pauling (1901-1994), chemist and physicist by vocation, was quite right when he said, four decades ago, in an almost prophetic way, the thought "There is no altered mind without previously altered molecule" The last researches of neurotransmitters and neuromodulators and experiences on patients on which *transmodulation blockade of brain opioid receptors*, as it is called, has been applied with resultant transpersonal experience, in the procedure of the healing of opiate addiction, of various content (cognitive, mystical, enlightening experience - enlightenment [9]), strengthen even more the belief in the correctness of the claim of Linus Pauling, whose thought is now much more than a metaphor.

## References

- [1] J.F.T. Bugental, *The Third Force in Psychology, J. of Humanistic Psychology* 4 No 1 (1964).
- [2] St. Grof, *Beyond the Brain: Birth, Death and Transcendence in Psychotherapy* (Albany, NY, 1964).
- [3] E.G. Guley *Encyclopedia of Mystical and Paranormal Experience* (Castle Books, New York, 1991).
- [4] A. Maslow *Toward a Psychology of Being*, (Van Nostrand, 1962).
- [5] G.W. Pasternak *Opioid Receptors, Psychopharmacology* (Raven Press, New York, 1987).

- [6] I. Strelau et al. *The Biological Bases of Personality and Behavior* (J. Hemisphere Publ. Comp., Washington, 1985).
- [7] T.Ch. Tart, *Altered States of Consciousness* (E.P. Dutton and Co., Inc., New York, 1987).
- [8] S. Petrovic, *Altered Consciousness* (Decje Novine, Gornji Milanovac, 1990), in Serbian.
- [9] J.F. Bruno, *Human Adjustment and Personal Growth: Seven Pathways* (John Wiley and Sons, Canada, 1977).

## RELAXATION INDUCED BY MICROWAVE RESONANCE THERAPY: EEG CORRELATES

Dejan Radenović<sup>1</sup>, Dejan Raković<sup>1,2</sup>, Zlata Jovanović-Ignjatić<sup>3</sup>, Milorad Tomašević<sup>4</sup>,  
Vlada Radivojević<sup>5</sup>, and Emil Jovanov<sup>1,6</sup>

<sup>1</sup>Faculty of Electrical Engineering, PO Box 35-54, 11120 Belgrade, Yugoslavia

<sup>2</sup>European Centre for Peace and Development (ECPD) of the United Nations University for Peace,  
Terazije 41, Belgrade, Yugoslavia

<sup>3</sup>Private Medical Practice "Lav", Vlade Zečevića 14, Belgrade, Yugoslavia

<sup>4</sup>"Vinča" Institute of Nuclear Sciences, Belgrade, Yugoslavia

<sup>5</sup>Institute for Mental Health, Department of Clinical Neurophysiology,  
Palmoćeva 37, Belgrade, Yugoslavia

<sup>6</sup>Institute "M. Pupin", Computer Systems Department, Volgina 15, Belgrade, Yugoslavia

**Abstract.** Microwave Resonance Therapy (MRT) as a novel medical treatment represents a synthesis of the ancient Chinese traditional knowledge in medicine (acupuncture) and recent breakthroughs in biophysics. Affecting the appropriate acupuncture points by the generator of high frequency microwaves (52-78 GHz), significant clinical results of the treatment are being achieved. In this paper the EEG correlates of the MRT effects on psychophysical relaxation are evaluated within a group of 28 adults. Upon the MRT application, a few-percentage decrease in the EEG power is observed in most subjects – suggesting some relaxation MRT effect. Such a tendency is particularly significant in the theta frequency band (4-8 Hz), which might be related to the resonance sensitivity of the acupuncture system in this ultralowfrequency (ULF) region.

**Key words:** *acupuncture, microwave resonance therapy (MRT), psychophysical relaxation, EEG correlates*

### 1 Introduction

The *yin-yang* concept of acupuncture, affecting the network of energy-information processes of an organism, represents one of the most specific and most useful segments of the renowned Chinese traditional medicine [1]. Indian traditional medicine, and especially one of its most prominent representatives, *swara yoga*, is also acquainted with an energy system analogous to the Chinese acupuncture system: in Indian terminology the *qi* entity is known as *prana*, and *meridians* as *nadis* (14 of them being basic, like in acupuncture, although 3 of them are of special medical and spiritual significance) [2]. In the definition of contemporary scientific acupuncture it can be said that acupuncture deals with somatotrophic representation of organs and tissues on the surface of the body, on the extra-bioactive acupuncture (*trigger*) skin points. Biophysical activation of acupuncture points (by sticking metallic needles, but also by heat, pressure, magnets, weak laser beam, ultralowfrequency currents, microwave resonance, aeroionic, and

biotherapeutic stimulation [1]), produces effects which are manifestation of the nervous (peripheral, autonomous, and central) and endocrine systems, owing to interaction and integration of sensitive stimuli.

Besides its practical medical aspects, Chinese traditional medicine is deeply colored with mystical connotations, which was one of the reasons why Western science has been hardly accepting experiences of Eastern tradition. The second reason was that within the 12 visceral organs corresponding to the 12 paired meridians, Chinese tradition has not included the brain and endocrine glands: however, in the past few decades it was found that the acupuncture system was in close functional interaction with both central nervous system and endocrine system, as well as with peripheral and autonomous nervous systems [1]. The final reason was a lack of clear anatomical basis of the Chinese acupuncture system. However, new investigations of gap junctions (specific intercell channels, whose ionic conductivity between excitable cells can be modulated by intracellular pH-factor, Ca<sup>2+</sup>-ions, neurotransmitters and second messengers, and even by voltage) have shown significant increase of concentration inside the acupuncture points and meridians [3].

A better organization of cell structures and an ionic basis of the *qi* entity of the acupuncture system is also suggested by approximately 10 times lower skin electrical conductivity of the acupuncture points in respect to the surrounding tissue, as well as much higher reabsorption of aeroions in these points [1]. Theoretical predictions of the biophysical model of altered states of consciousness also imply an ionic nature of the *qi* entity of the acupuncture system, with possibility of its partial displacements from the skin surface in these states [4]. Ionic acupuncture currents, and accompanying electromagnetic fields, have ultralowfrequency (ULF) and microwave (MW)

components, i.e. the MW component is modulated by the ULF component: in support to the ULF nature of ionic currents in acupuncture channels, one can cite the resonance ULF (~ 4 Hz) stimulation of the acupuncture analgesia endorphin mechanism [5]: on the other hand, the evidence for the MW component of ionic acupuncture currents is provided by resonance MW (~ 52-78 GHz) therapy, efficient even in very serious diseases [6,7].

The inventors of the microwave resonance therapy (MRT), former Soviet scientist Sit'ko and his coworkers [6], proposed in early 1980's that acupuncture system represents a dynamic structure, differentiated at the locations of maximums of three-dimensional standing waves, formed as a result of the reflection of coherent microwave (~ 100 GHz [8] Fröhlich excitations) of molecular subunits in the cell membranes and proteins - supported also by other investigations which have demonstrated that differentiation of gap junctions (of higher density at acupuncture points and meridians) is slightly sensitive to voltage [5]. In the above context an explanation of MRT efficiency, as noninvasive nonmedicamentous medical treatment, should be sought [7]: some disorders in the organism give rise to deformation in the three-dimensional standing wave structure of electrical field of the organism in MW region, which influences corresponding changes in spatial structure of the acupuncture system, and consequently its resonance frequency, resulting in some disease. During the therapy, applying the MW sound at corresponding acupuncture point the excited acupuncture system of the patient is relaxing to the previous healthy condition, while reaching its normal resonance frequency response upon the wide spectrum MW source - and following to physiological mechanisms of the acupuncture regulation [1] the organism biochemically overcomes the disease.

It is experimentally demonstrated that the organism is resonantly sensitive to the 1% frequency changes in MW range of 52-78 GHz, as observed in the EEG, ECG, pulse normalizing, change in tension and respiratory rhythm [6]. At the moment of establishing resonance frequency, the patient's sensory response can be manifested as local (feeling of warmth, pricking, weight, goosflesh, bites, or cold at the contact point), systemic (related to organ or system), and general (in the form of comfortable and uncomfortable reactions).

The recommended MRT treatment at an acupuncture point is at last 10 minutes, while the duration of the whole treatment is maximum 20 minutes, applied daily or bidaily. 10 treatments in a course are applied, with a minimum pause of 21 days and optimally one month, in the case a repeated course is necessary. The courses of prophylaxis are advised every 6 months, concerning psychophysiological relaxation too. This motivated us to start investigation of the MRT-induced relaxation effects on EEG changes [9].

## 2 Method

*SUBJECTS* - The study was carried out on 28 healthy adult volunteers (13 males and 15 females).

*APPARATUS* - Electroencephalographs were recording by a MEDELEC 1A97 EEG machine, with lower and upper band-pass filter limits set at 0.5 Hz and 30 Hz, respectively. Silver chloride electrodes were placed at 16 locations (F7, F8, T3, T4, T5, T6, Fp1, Fp2, F3, F4, C3, C4, P3, P4, O1, O2) according to the International 10-20 system, with average reference. The EEG outputs were digitized with 12 bit precision at a sampling rate of 128 Hz per channel using A/D converter Data Translation 2801.

*PROCEDURE* - The experiment was conducted in a sound-proof room, dimly lit for observation. Subjects were laid comfortably. Each recording session was divided into three sequential periods:

1. relaxing 5 min with eyes closed;
2. MRT 20 min;
3. relaxing 5 min with eyes closed.

During those periods two random samples, one minute each, were recorded for every subjects. The EEG record was stored on a hard-disc.

The MRT was applied by the wide spectrum apparatus POROG-3, and the measurement of frequency was achieved by the narrow spectrum apparatus AMRT-01, adjusted manually. The frequency range of the POROG-3 is 52-78 GHz. Up to 10 mW low-power microwave generators, of the output power density of 0.2-5  $\mu\text{W}/\text{cm}^2$  - much lower than biologically limited 10 mW/cm<sup>2</sup> during 8 hours, as prescribed by USA National Standards, or 10  $\mu\text{W}/\text{cm}^2$  during 8 hours, as prescribed by Russian and Ukrainian National Standards [6] - are power supplied by the 220±22V/50Hz a.c. or the autonomous 4.5V d.c. The output power density as well as the seance duration significantly influence the MW absorbed dose and corresponding MRT bioeffects, which can be biostimulative for low-level therapeutically recommended doses of typical 20-minute daily MRT treatments (causing local temperature increases up to 38°C, with maximally fast bioeffect), and biodepressive and even biodestructive for much higher doses (causing much higher and harmful local temperature increases) [6]. MRT generator was applied on acupuncture points in the following order: Du 20, and the left-side points Li 4, Pc 6, H 7 and Ap 55, which resulted in relaxation, similarly to the parasympathicus effect [1]. The choice of the acupuncture points for the relaxation seance was achieved on the basis of well known principles of acupuncture stimulation, characteristics of the chosen points, and the therapist experience.

*DATA ANALYSIS* - Time-varying EEG spectra (spectrograms) with 0.5 Hz resolution were calculated by the MATLAB program using a 256-point FFT algorithm performed on 2 sec Hamming-windowed half-overlapping epochs. An array of EEG partial power spectra for each subject and each derivation

was computed by integration by the trapezoidal rule of the spectrogram over the five frequency bands.

The coherence spectral arrays was estimated using Welch's averaged periodogram method at 512-point (4 sec) epochs of EEG data divided into 256-point (2 sec) detrended Hamming-windowed subjects with 240-point overlap. Total coherence for the each frequency band was calculated using the same methods as those described by Levine et al. [10]. Within every frequency band, at any moment, the maximal value of the coherence was taken.

**Table 1.** Adopted frequency intervals for the EEG power and coherence analyses

FREQUENCY	FREQUENCY INTERVAL	
BAND	POWER	COHERENCE
DELTA	1 - 4 Hz	1 - 3.5 Hz
THETA	4 - 8 Hz	4 - 7.5 Hz
ALPHA	8 - 13 Hz	8 - 12.5 Hz
BETA1	13 - 18 Hz	13 - 17.5 Hz
BETA2	18 - 30 Hz	18 - 29.5 Hz

**Table 2.** The number of subjects with significant changes of the EEG power over the whole head, for the two groups (group 1, having not ever been previously MRT treated; group 2, previously MRT treated) in all frequency bands; the frequency bands with corresponding changes observed in more than 50% subjects are shaded.

GROUP	TYPE OF CHANGE	FREQUENCY BANDS									
		delta		theta		alpha		beta1		beta2	
1	significant increase	2	18%	0	0%	3	27%	5	45%	2	18%
	significant decrease	0	0%	2	18%	6	55%	5	45%	3	27%
	not significant	9	82%	9	82%	2	18%	1	10%	6	55%
2	significant increase	4	24%	3	17%	4	24%	2	12%	5	29%
	significant decrease	5	29%	4	24%	5	29%	7	41%	2	12%
	not significant	8	47%	10	59%	8	47%	8	47%	10	59%
1 & 2	significant increase	6	21%	3	11%	7	25%	7	25%	7	25%
	significant decrease	5	18%	6	21%	11	39%	12	43%	5	18%
	not significant	17	61%	19	68%	10	36%	9	32%	16	57%

**Table 3.** The number of subjects with significant changes of the EEG power for all channels of the group 1 (11 subjects); the channels with the band power changes in more than 50% subjects are shaded.

CHANNELS	FREQUENCY BANDS														
	delta			theta			alpha			beta1			beta2		
	+	-	Σ	+	-	Σ	+	-	Σ	+	-	Σ	+	-	Σ
1 - F7	1	3	4	1	1	2	2	5	7	2	3	5	2	2	4
2 - F8	1	5	6	0	2	2	2	3	5	2	3	5	1	4	5
3 - T3	5	4	9	2	2	4	3	4	7	5	3	8	4	3	7
4 - T4	4	1	5	3	0	3	5	2	7	4	2	6	5	1	6
5 - T5	3	2	5	5	2	7	4	3	7	2	2	4	3	3	6
6 - T6	3	3	6	0	4	4	2	2	4	3	4	7	2	2	4
9 - F3	1	5	6	0	3	3	3	3	6	3	3	6	4	1	5
10 - F4	4	3	7	2	1	3	3	3	6	5	2	7	5	0	5
11 - C3	2	5	7	2	3	5	3	3	6	4	2	6	3	3	6
12 - C4	4	1	5	2	2	4	4	2	6	4	2	6	7	3	10
13 - P3	2	2	4	2	2	4	5	4	9	1	4	5	2	4	6
14 - P4	3	3	6	0	2	2	3	4	7	3	2	5	3	2	5
15 - O1	3	3	6	2	4	6	3	3	6	1	5	6	2	3	5
16 - O2	1	3	4	0	4	4	3	5	8	1	7	8	2	3	5

We have adopted as significant changes only those observed in more than 50% subjects. In Table 1 the adopted frequency intervals for every frequency band used in the power and coherence analyses are presented.

Since those arrays are not distributed in a Gaussian manner, the Mann-Whitney U-test and Wilcoxon matched pairs test were used to determine significant differences between the spectral arrays of the pre-therapy period and the spectral arrays of the after therapy period.

### 3 Results

#### 3.1 Power analysis

The subjects were classified in to two groups: group 1 (11 subjects) not previously subjected to the MRT treatment, and group 2 (17 subjects) being subjected to the MRT in the past two years. In Table 2 a survey of significant changes ( $p < 0.05$ , obtained by the Wilcoxon test for corresponding pairs of channels) of the EEG power in all frequency bands over a whole head is given, while in Tables 3 and 4 such surveys for all EEG channels are presented.

**Table 4.** The number of subjects with significant changes of the EEG power for all channels of the group 2 (17 subjects); the channels with the band power changes in more than 50% subjects are shaded.

CHANNELS	FREQUENCY BANDS														
	delta			theta			alpha			beta1			beta2		
	+	-	Σ	+	-	Σ	+	-	Σ	+	-	Σ	+	-	Σ
1 - F7	5	3	8	2	2	4	3	5	8	3	2	5	9	3	12
2 - F8	6	1	7	1	3	4	3	5	8	2	3	5	6	4	10
3 - T3	2	4	6	4	4	8	4	4	8	4	3	7	7	1	8
4 - T4	3	5	8	1	3	4	4	6	10	0	4	4	5	3	8
5 - T5	3	5	8	0	5	5	5	4	9	0	6	6	5	4	9
6 - T6	8	4	12	5	4	9	3	7	10	1	7	8	4	5	9
9 - F3	6	6	12	2	3	5	2	3	5	1	9	10	7	3	10
10 - F4	4	3	7	4	4	8	3	4	7	2	4	6	7	3	10
11 - C3	4	6	10	4	7	11	4	5	9	1	6	7	6	5	11
12 - C4	3	4	7	3	5	8	3	4	7	3	6	9	5	3	8
13 - P3	4	3	7	3	6	9	5	5	10	2	6	8	3	3	6
14 - P4	2	4	6	0	6	6	3	4	7	0	5	5	3	5	8
15 - O1	0	7	7	1	5	6	3	6	9	0	8	8	3	6	9
16 - O2	1	5	6	0	3	3	3	5	8	0	7	7	1	4	5

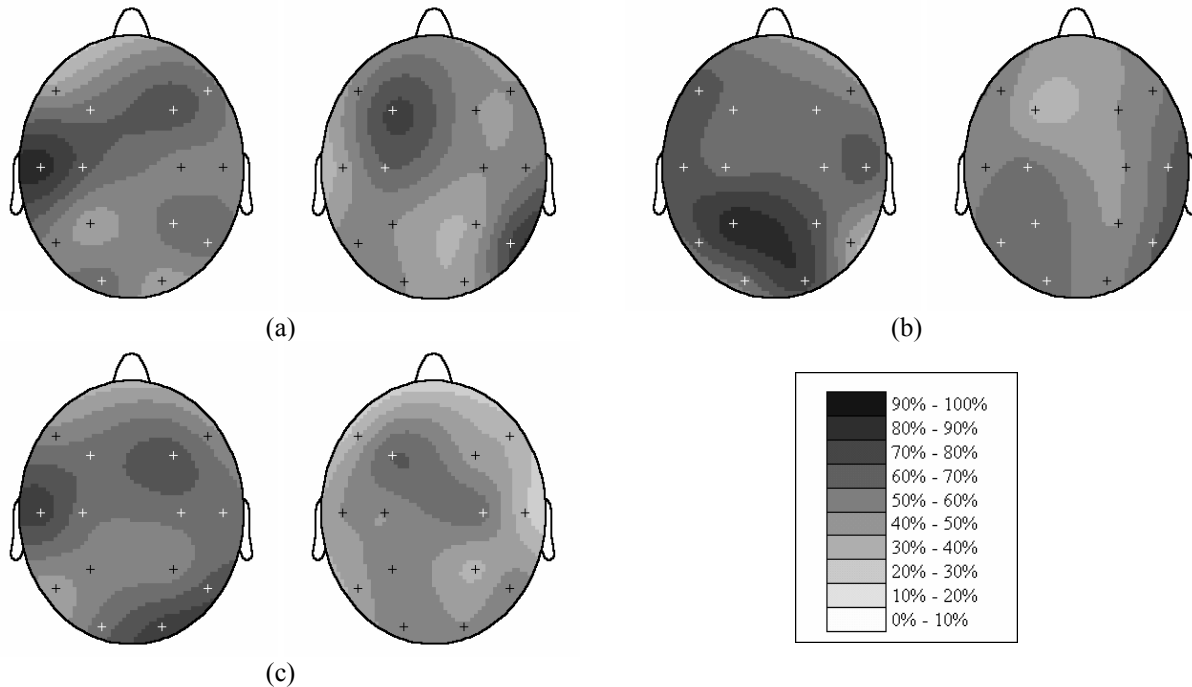

**Figure 1.** The topographic mappings of the number of subjects (in %) of the group 1 (left) and the group 2 (right), having the significant EEG power changes in the: (a) delta, (b) alpha, and (c) beta1 frequency bands. The gradual percentage changes are presented in various degrees of shading, as designated in the insert.

Both groups of subjects have significant changes in the EEG power over the whole head in the alpha and beta1 frequency bands, with observation that the percentage of subjects with minor reactions is much lower in the group 1. The group 2 subjects have also significant EEG power changes over the whole head in the delta frequency range.

Within the whole frequency range (1-30 Hz), 37 channels in the first group and 22 channels in the second group with the power changes in more than 50% subjects are notified. The changes are evident in delta, alpha, and beta1 frequency bands. The most prominent power changes in all frequency bands are

observed in the channels 3 (T3), 11 (C3), and 12 (C4) of the group 1, and in the channels 6 (T6), 9 (F3), 11 (C3), and 13 (P3) of the group 2. The channels 3 (T3), 11 (C3), and 15 (O1) of the group 1, and the channels 6 (T6) and 11 (C3) of the group 2 have power changes in more than 50% subjects in 4 out of 5 frequency bands. In both groups of subjects a decrease in the EEG power is more frequently observed than an increase. As an illustration, in Fig.1 (a-c) the topographic mappings of the number of subjects (in %) having the significant EEG power changes in the delta, alpha and beta1 frequency band, for the two groups of subjects are presented.



### 3.2 Coherence analysis

Generally speaking, the changes in coherency are not too significant. Regarding the complete group of subjects, in delta frequency range the changes are observed in the backward temporal (T5 and T6), parietal (P3 and P4), and occipital (O1 and O2) regions in 25%, 25%, and 42 % of subjects, respectively. The changes in frontal region (F3 and F4) within alpha frequency band are observed in 29% of subjects, and in occipital region (O1 and O2) within beta1 frequency band in 25% of subjects. Most prominent changes, over the whole frequency interval (1-30 Hz), are registered in occipital region (O1 and O2). A decrease in the coherency is generally observed.

## 4 Conclusion

Upon the MRT application, a few-percentage decrease in the EEG power is observed in most subjects of both groups - the first group not previously subjected to the MRT treatment (11 subjects), and the second group of 17 subjects being subjected to the MRT in the past two years-suggesting some relaxation MRT effect. The EEG power over the whole head is particularly changed in alpha and beta1 frequency bands in both groups of subjects. The subjects of the group 1 had about 70% more MRT responding channels (reacting to MRT in over 50% subjects in all frequency bands) than the subjects of the group 2, especially in the alpha and beta1 frequency bands, which might be ascribed to the energetically more dysbalanced acupuncture system of subjects in group not previously under the MRT treatment, therefore revealing more relative changes towards the energetically normal acupuncture state.

The left parietal channel (P3) reveals the most prominent EEG power changes in both groups of subjects in the alpha band (cf. Fig.1b). The most prominent EEG power changes over the whole head are registered in the left central region (C3) of both groups of subjects, in the whole frequency interval (1-30 Hz), and this channel revealed the changes in 4 out of 5 frequency bands. It should be added that in both groups of subjects the dominant power changes within the EEG channels in all frequency bands (with the exception of beta1 band in the group 2) are registered in the left hemisphere, which might be ascribed to higher activation of the left circulatory part of the acupuncture system, as a consequence of the systematic MRT stimulation of the left-side acupuncture points Li 4, Pc 6, H 7, and Ap 55. Such a tendency is particularly significant in the theta band, in both groups of subjects, implying the higher sensitivity of the theta frequency band (4-8 Hz), which might be related to the resonance sensitivity of the acupuncture system in this ULF region, as demonstrated by the ~ 4 Hz resonance stimulation of acupuncture analgesia endorfin mechanism [5].

According to the results obtained, in further investigations attention should be paid to MRT/EEG experiments with carefully defined initial states of subjects' ultradian rhythmic activity (observable by the left/right brain's hemispheric domination and/or corresponding contralateral domination of the right/left body side). This could provide additional information on acupuncture mechanisms and the relationship between acupuncture system and nervous system. Such relation is apparent, having in mind the therapeutic acupuncture suggestions to affect the acupuncture points on the opposite side in respect to the dysfunctional part of the body - which cannot be achieved by purely acupuncture interconnecting channels (meridians), as the two acupuncture circulatory parts (left and right) are circulatory independent [1].<sup>a</sup>

## References

- [1] Y. Omura, *Acupuncture Medicine* (Japan Publ. Inc., Tokyo, 1982); F.G. Portnov, *Electropuncture Reflexotherapeutics* (Zinatne, Riga, 1982), in Russian; A. I. Škokljčev, *Acupuncturology* (ICS, Belgrade, 1976), in Serbian.
- [2] H.Johari, *Breath, Mind, and Consciousness* (Destiny Books, Rochester, Vermont, 1989).
- [3] E. R. Kandel, S. A. Siegelbaum, and J. H. Schwartz, Synaptic transmission, in *Principles of Neural Science*, E. R. Kandel, J.H. Schwartz, and T. M. Jessell, eds. (Elsevier, New York, 1991), Ch.9.
- [4] D. Raković, Neural networks, brainwaves, and ionic structures: Acupuncture vs. altered states of consciousness, *Acup. & Electro-Therap. Res., Int. J.* 16 (1991), pp. 88-99; D. Raković, Brainwaves, neural networks, and ionic structures: Biophysical model for altered states of consciousness, in *Consciousness: Scientific Challenge of the 21st Century*, D. Raković and D. Koruga, eds. (ECPD, Belgrade, 1995), pp. 291-316.
- [5] B. Pomeranz, Acupuncture research related to pain, drug addiction and nerve regeneration, in *Scientific Bases of Acupuncture*, B. Pomeranz and G. Stux, eds. (Springer, Berlin, 1989), pp. 35-52.

<sup>a</sup> The praxis of Indian swara yoga [2] suggests that a higher activity of one out of the two main lateral nadis (the left ida and the right pingala) is accompanied by a higher activity of contralateral brain hemisphere, in accordance with the physiologically established relationship of the contralateral brain/body dominant activity. Then, the MRT activation of the currently energetically deprived circulatory part of acupuncture system affects its global activation, including ipsilateral brain hemisphere - at least as a transient phenomenon (~ 5-10 min, according to the swara yoga evidence based on the transience of nasal rhythm, having otherwise steady-state ultradian rhythm of periodicity ~ 90-120 minute [2]). Although this will be followed by successive activation of the contralateral brain hemisphere (affected by the MRT activated pacemaker of ultradian rhythm), it should have beneficial functional influence on the contralateral body side further on, through the physiological mechanisms of contralateral functional brain/body relationship. This is in agreement with the previously mentioned therapeutic suggestions in acupuncture to affect the acupuncture points on the opposite side in respect to the dysfunctional part of the body - presumably via functional chain: ipsilateral acupuncture circulatory system/ipsilateral brain hemisphere/contralateral (dysfunctional) body side. This also implies that the cause of the acupuncture dysfunction should be sought at the level of contralateral brain hemisphere and even primarily at the energetic level of contralateral acupuncture circulatory part of (still) not dysfunctional body side. If not treated, this part would successively evolve the same dysfunction.

- [6] S.P.Sit'ko, Ye.A. Andreyev, and I.S. Dobronravova, The whole as a result of self-organization, *J. Biol. Physics* 16 (1988) 71-73; S.P. Sit'ko and V.V. Gizhko, Towards a quantum physics of the living state, *J. Biol. Physics* 18 (1991) 1-10; see also S.P. Sit'ko, Quntum physics of the alive: medical aspects, this *Proc. ECPD Workshop*, 1997, and references therein.
- [7] Z. Jovanović-Ignjatić and D. Raković, Microwave resonance therapy: Novel opportunities in medical treatment, submitted; D. Raković, *Fundamentals of Biophysics* (Grosknjiga, Belgrade, 1995), Chs. 3, 5, 6, in Serbian.
- [8] H. Fröhlich, Long-range coherence and energy storage in biological systems, *Int. J. Quantum Chem.* 2 (1968), pp. 641-649.
- [9] D. Radenović, *EEG correlates of relaxation induced by microwave resonance therapy*, B. Sc. thesis (Faculty of Electrical Engineering, Belgrade, 1997), in Serbian.
- [10] H. Levine, J. R. Hebert, C. T. Haynes, and U. Strobel, EEG coherence during the Transcendental Meditation technique, in D. W. Orme-Johnson and J. T. Farrow, eds., *Scientific Research of the Transcendental Meditation Program - Collected Papers*, Vol. 1 (MERU Press, Seelisberg, Switzerland, 1977), pp. 187-207.

# UNUSUAL CONSCIOUS COMMUNICATION AND THE ELECTRICAL ACTIVITY OF THE BRAIN

Vera Radičević and Zoran Radičević

Institute for Experimental Phonetics and Speech Pathology, Belgrade, Yugoslavia

**Abstract.** We carried out the pilot study of quantitative brain electrical activity analysis during the conscious communication function through the extrasensory perception. The finding indicates the special distribution of spatial and temporal changes, that is different from those reported in EEG analysis of the working memory during the objective perception.

**Key words:** *communication, extrasensory, EEG.*

## 1 Introduction

If love is the supreme form of communication, it is obvious why there is so much interest and researches in the field of communication, for "if you get through to the heart of the matter, you will come across the trail of happiness" [1].

It is especially challenging to get to know those forms of communication which are not average, where it is difficult to use standards of material world, i.e. objective indexes. Measurement of the electrical activity of the brain in relation to certain human functions is one of the relatively accessible methods of objectivization.

Our research, which started almost unintentionally, was one step closer towards objectivization of the abilities of the above-average, special communication which was consciously realized through the linguistic code.

## 2 Aim

The aim of this work is to show in what way this form of perception of space-time continuum and communication has its rules of activation of the electrical activity of the brain.

## 3 Method

Presentation of the case: N.N, girl, aged 17, with normal psychophysiological development. Approximately a year ago, the subject noticed the strange appearance of information about some people with amazing correctness (confirmed by the people the information was about). Sometimes she did not mention anything, because she was scared of this phenomenon. She did not know what happening, she lost concentration, especially when studying and

sometimes headaches occurred. That was the reason to ask for expert help.

Instruments test of lateral preference and EEG techniques of registration: Ag/Ag Cl scalp electrode impedance < 5k $\Omega$  set at 10-20 International system, 16 channels (F7, F8, T3, T4, T5, T6, Fp1, Fp2, F3, F4, C3, C4, P3, P4, O1, O2, all according to av. reference), on Medelec 1A97, sensitivity 50  $\mu$ V/cm, bandpass 1-70 Hz, 50 Hz filter off, A/D conversion on 12-bit DT-1801 card, 128 Hz sampling rate, software for activation of signals Rhythm V 8.0 Stellate Systems, off-line elimination of artifacts.

Experimental conditions: all recordings were performed in the electromagnetically isolated room. The experimenter is in the same room opposite the subject. After the standard EEG recording, we had the experimental part of recording with 3 experimental tasks, each consisting of two parts.

All the questions were related to future happenings of experimenter, which the experimenter has planned. After the subject hears the question coming from the experimenter, comes type I of the task, when subject uses her extra abilities; there is 30 sec EEG recording during this time. Then comes type II of the task, when we start the recording again: now the subject writes down obtained information regarding the question asked; recording is stopped after 30 sec or longer, if needed.

During these tasks, the subject does not speak and sits with her eyes open.

The tasks are marked as:

- Type I - 1, 2 and 3;
- Type II - 1a, 2a and 3a.

## 4 Results and Discussion

The test of lateral preference for senses of sight and hearing as well as upper and lower extremities showed right preference for all.

Neurological finding and standard EEG without particularities (Fig. 1).

EEG changes during the performance of the tasks are only within alpha and beta range, in relation to spontaneous EEG in the state of rest.

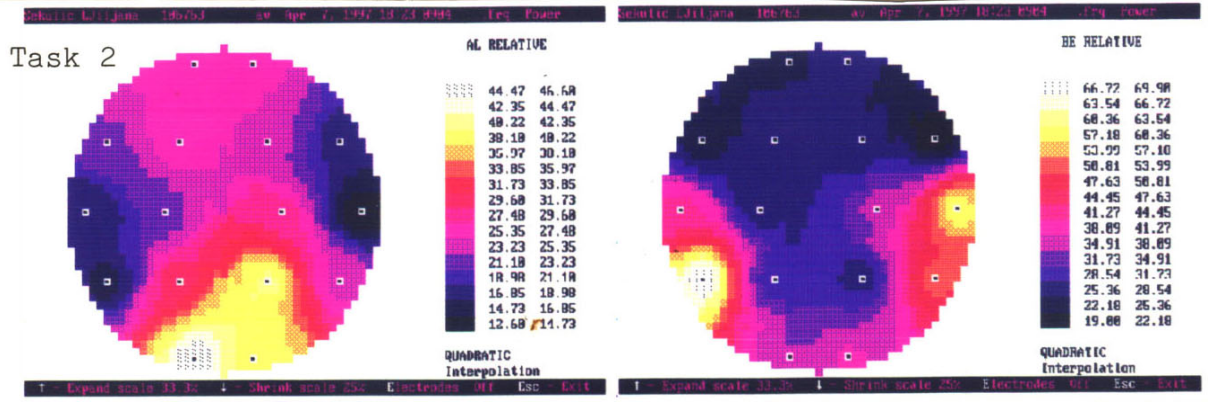
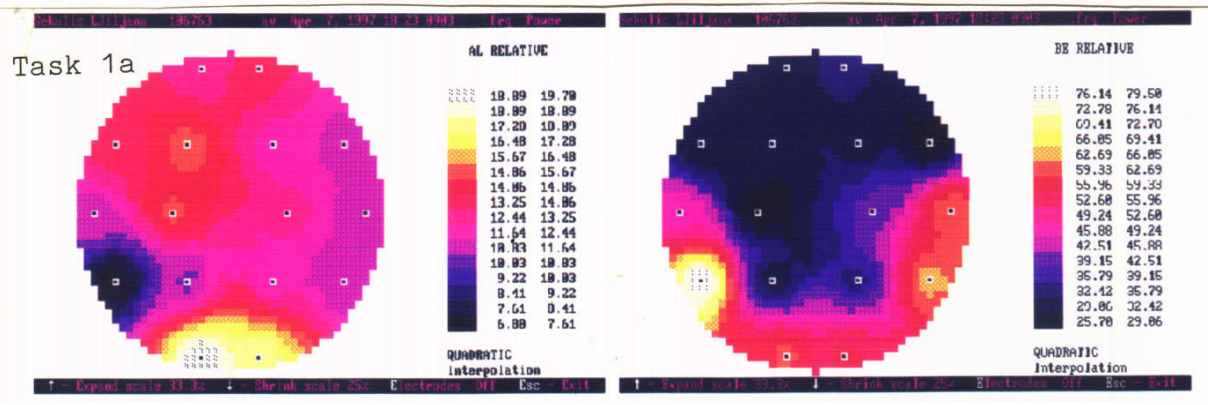
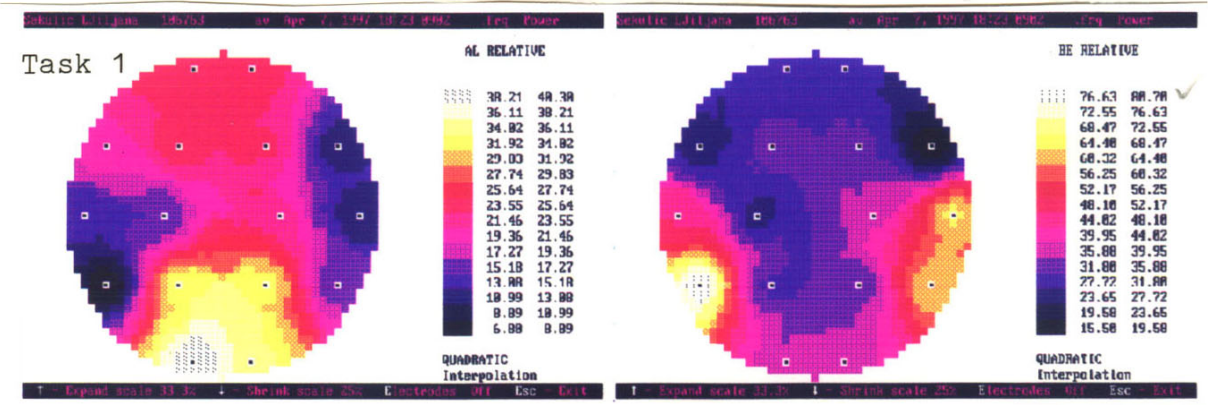
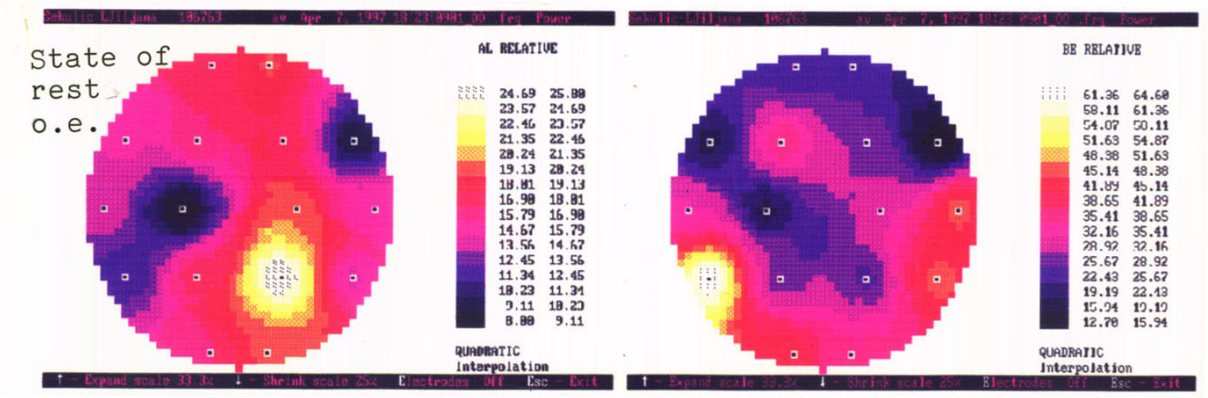



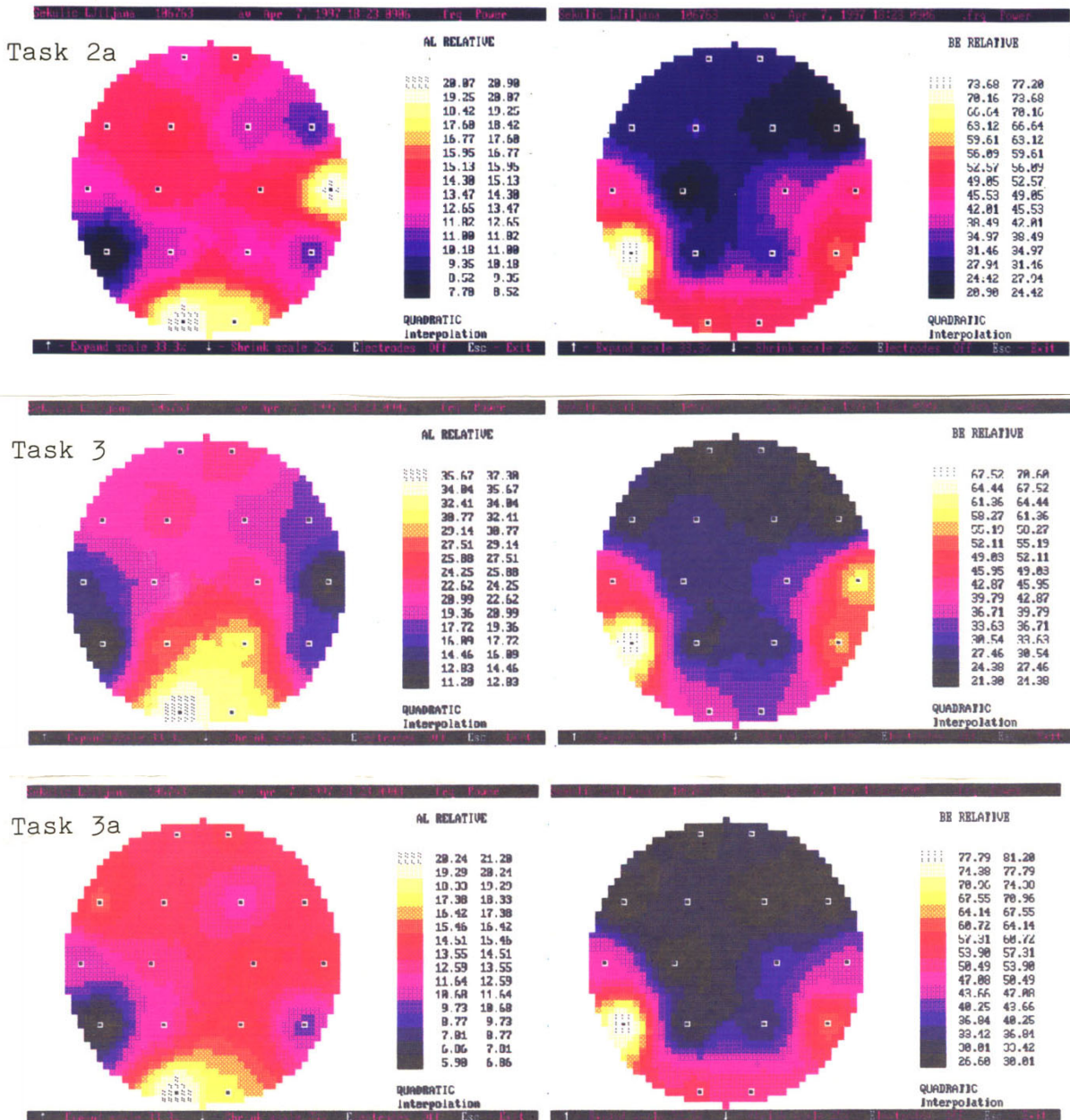

**Figure 1** EEG mapping in  $\alpha$  (left) and  $\beta$  (right) frequency regions for the state of rest, and Tasks 1, 1a, 2, 2a, 3, and 3a (from top to bottom).

The EEG difference in  $\alpha$  and  $\beta$  regions between the Tasks 1 and 1a is firstly in the dominant activation of the back regions of the left hemisphere (Task 1) and right hemisphere (Task 1a); activation of the temporal region is mutual (cf. Figs. 1 and Table 1).

The  $\alpha$  and  $\beta$  difference between the Tasks 2 and 2a is firstly in activation of different regions of both hemispheres: in Task 2 symmetrical activation of the back regions, and in Task 2a asymmetrical activation of the left motor zone and the right parietal region (cf. Figs. 1 and Table 1).

The  $\alpha$  and  $\beta$  difference between Tasks 3 and 3a is significantly greater activation of both hemispheres in Task 3, and deactivation of right parietal region in Task 3a (cf. Figs. 1 and Table 1).

The obtained EEG activation/deactivation changes in  $\alpha$  and  $\beta$  frequency regions, in the Tasks 1-3 of the types I and II, are summarized in Table 1.

Regarding  $\theta$  activity (Figs. 2 (right) and Table 2) it is concluded:

- there are no significant changes in the intensity of activation (except in Task 1a, where the significant fall of the total intensity was registered);

- significant appearance is expressed in the dynamism of the direction of grouping above the right hemisphere i.e. its front part in Task 3a, while at the end of the investigation there was a return to the original state of rest.

**Table 1** EEG activation deactivation scheme in the Tasks 1-3 of the types I and II; the channels with changed activities in  $\alpha$  and  $\beta$  frequency bands are shaded

		TASKS: TYPE I									TYPE II						
		Reg.									Reg.						
Actv.	Type.	Task No.	P3	P4	O1	O2	C3	T4	T6	T6	T4	C3	O2	O1	P4	P3	
Increase	$\alpha$	1															
		2															
		3															
	$\beta$	1															
		2															
		3															
Decrease	$\alpha$	1															
		2															
		3															
	$\beta$	1															
		2															
		3															

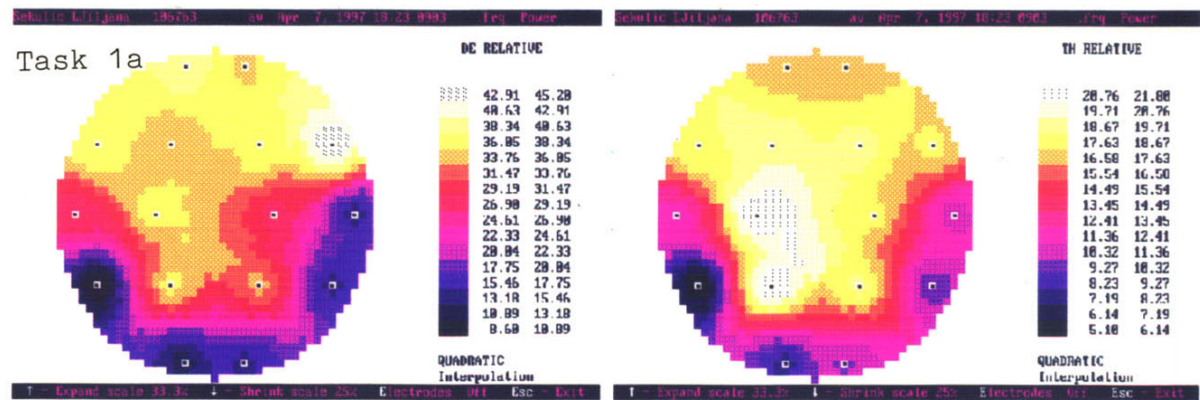
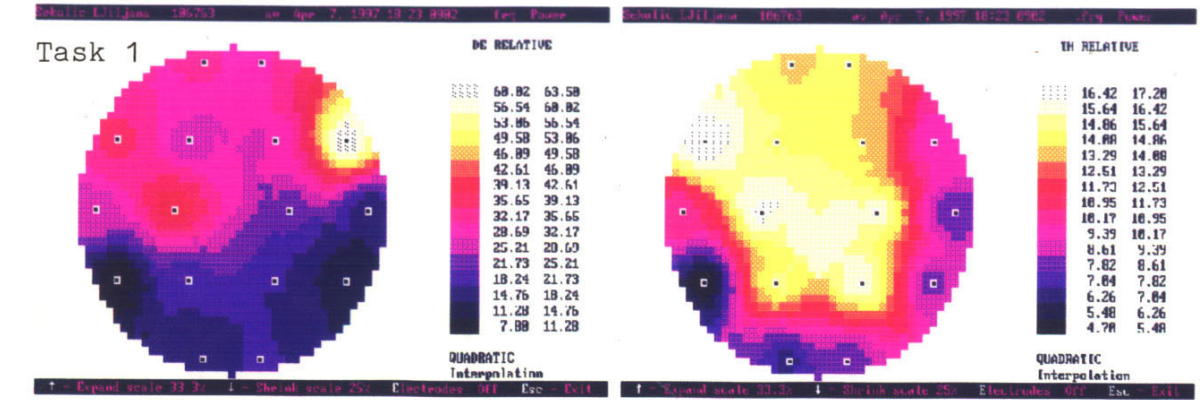
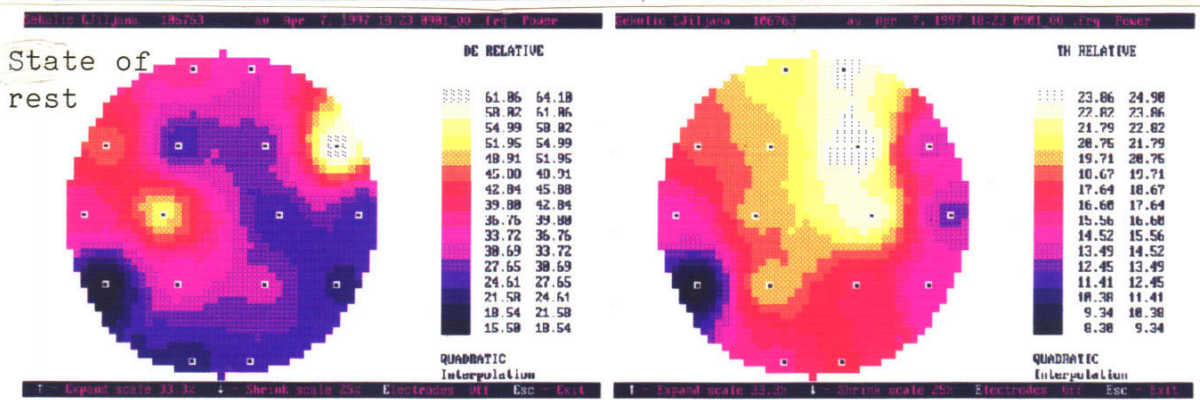



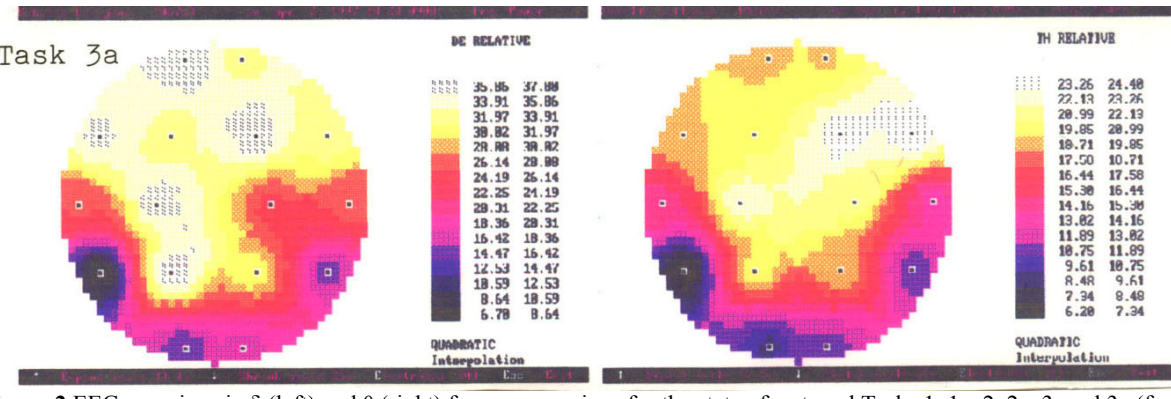
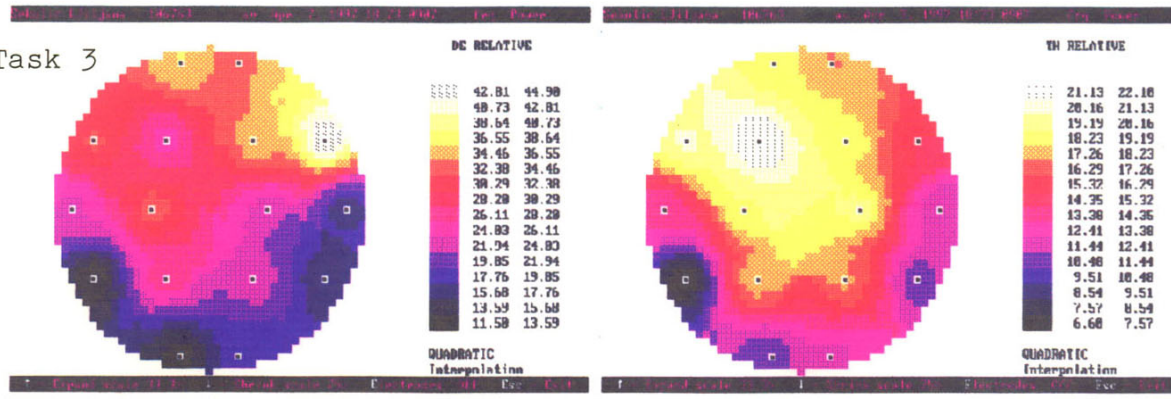
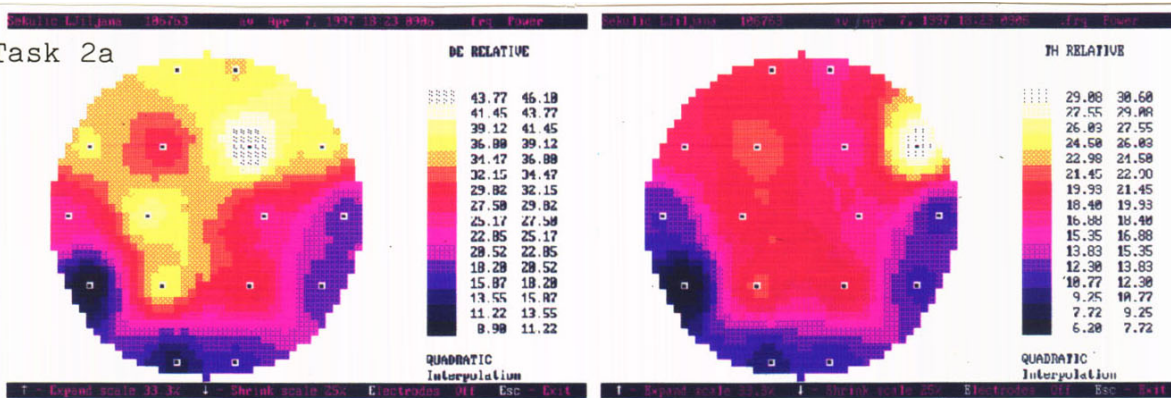
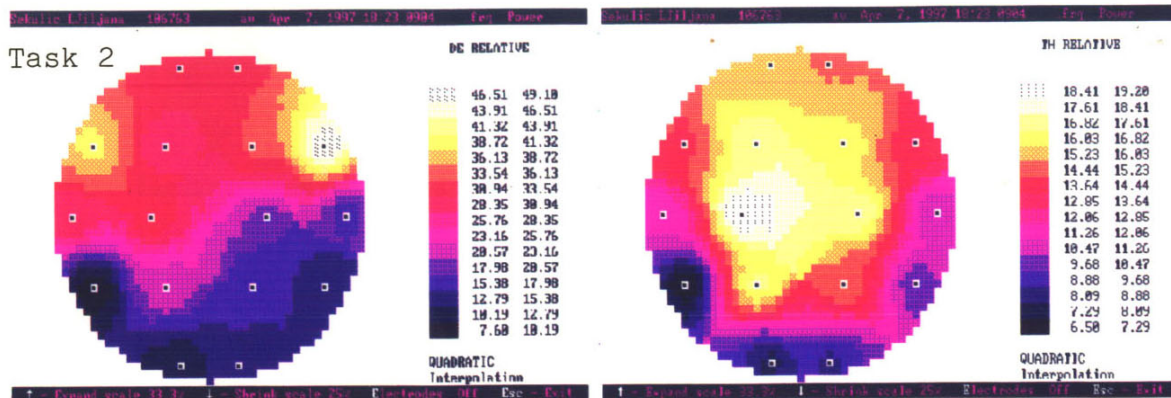

Figure 2 EEG mappings in  $\delta$  (left) and  $\theta$  (right) frequency regions for the state of rest, and Tasks 1, 1a, 2, 2a, 3, and 3a (from top to bottom).

It should be added that previous findings [2] showed that during processing of visio-spatial and verbal tasks in adults,  $\theta$  activity was mostly decreased compared to the intensity increase of  $\alpha$  and  $\beta$  activities.

Finally, regarding  $\delta$  activity (Figs. 2 (left) and Table 2) it is concluded:

- there are no changes in the intensity of  $\delta$  region;
- there is concentration of the dynamism (direction) of the activity towards the right hemisphere which can mean the specific change in relation to the performance of the single task;
- the exception is Task 3a, where, as in the state of rest, there was the disconnection (2 centers).

Researches of so far available findings regarding imaging of visio-spatial processing by PET and MRI [3-5], demonstrated locations of processing in the form of working memory in pre-frontal cortex with or without different time appearance of performance and subordinated locations in relation to the exposure of material and locations of perceptual processing in parieto-occipital regions bilaterally. On the other hand the first type of our Tasks 1, 2 and 3 is characterized by  $\alpha$  power increase in parieto-occipital region bilaterally, in agreement with the PET finding (Fig. 3) in the visual perception area. Regarding the fact that the information brought to consciousness has the linguistic form, the question raises regarding the activation of the occipital regions!?

**Table 2.** EEG channels with dominant changes in  $\theta$  and  $\delta$  frequency bands.

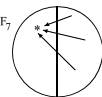
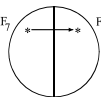
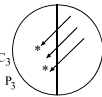
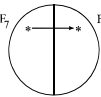
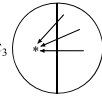
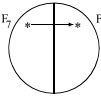
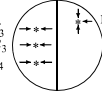
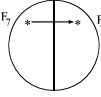
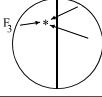
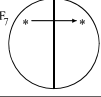
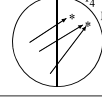
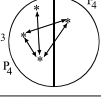
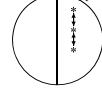
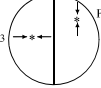
Task	$\theta$	$\delta$
1	L  R	L  R
1a	 C <sub>3</sub> P <sub>3</sub>	 F <sub>7</sub> F <sub>8</sub>
2	 C <sub>3</sub>	 F <sub>7</sub> F <sub>8</sub>
2a	DISCONNECTION  F <sub>7</sub> F <sub>8</sub> C <sub>3</sub> P <sub>4</sub>	 F <sub>7</sub> F <sub>8</sub>
3	 F <sub>7</sub>	 F <sub>7</sub> F <sub>8</sub>
3a	 F <sub>4</sub> F <sub>8</sub>	DISCONNECTION  F <sub>p1</sub> F <sub>4</sub> C <sub>3</sub> P <sub>4</sub>
state of rest	 F <sub>p1</sub> F <sub>4</sub> C <sub>4</sub>	DISCONNECTION  C <sub>3</sub> F <sub>8</sub> P <sub>4</sub>

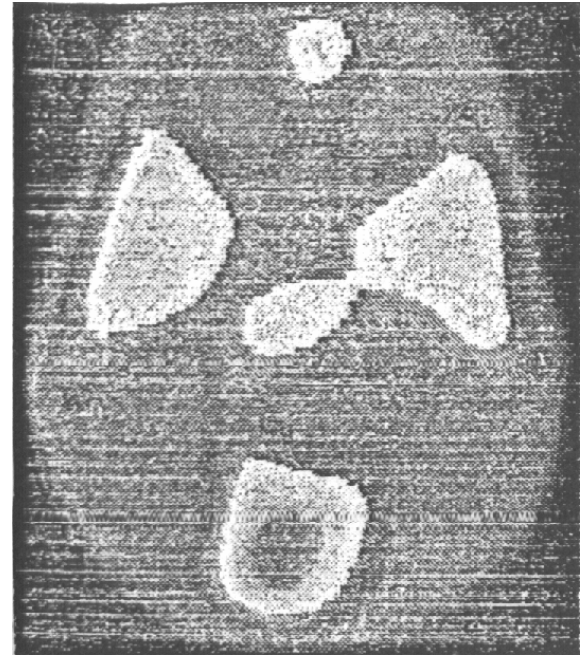

**Figure 3.** PET scan during face memory task shows activity “hot spots” in working memory areas (upper group) at front of the brain and the perceptual area at back of the brain (bottom) [3]. "Working memory" is the capacity to keep information consciously "in mind" while carrying out task using that information.

We do not know enough about neurophysiology of formation of space-time universals in language and speech. Anyway, we can discuss the facts from our researches: in one case of Alalia (complete absence of speech-language development) on MRI we had the finding of retroinfracerebral arachnoidal cyst (fight presered) [6].

Language abilities of phonemic segmentation and synthesis of words in children with poor vision and blind children (with normal intellectual abilities) were even slightly better compared to the children with normal psychophysiological development [7].

$\beta$  power increase of the right temporal region in charge of the non-verbal perception, memory and melody (music), directs us towards thinking about linguistic and paralinguistic indications and the share in imaginative abilities. (In our experiment there was no speech production by our subject, but only writing, i.e. transcription of impressive speech into writing.)

Retaining of this activity in the second part of Task 1a, directs us towards the completely new situation for the subject, where the degree of CNS readiness to perform was higher than when the situation is repeated (in Tasks 2a and 3a it disappears).

Increase of the  $\alpha$  power in C3 in the central motor zone in Task 3, can be the result of a detailed question, i.e. the third question consisted of two connected questions, so the retaining in working memory was activated.

The same happens in C3 in Task 2a where we got two connected answers with 22 words (to one question), while in Task 1a there were 11 words, so it



was again retaining of information in working memory with the aim of correct questioning.

Why is not such an occurrence in Task 3a, when we already have it in Task 3 and the number of words in the answer is the same as in Task 2a. We take liberty to suppose that (regarding the fact that the subject knew it was last task) it was energy economizing in CNS activity, which can be observed through pronunciation of the word or sentence when we mark the fall with the full stop, which is seen in  $\beta$  and  $\delta$  activities in Task 3a, as in the state of rest again.

According to our result, the absence of frontal asymmetry of the alpha activity in our subject shows absence of the emotional provocation to the presented questions.

Significant difference in the distribution of electrical activity of the brain between the two types of tasks and the absolute assertion of the subject that the information was obtained as a word or a sentence ("it comes to my mind") even if it is a description of somebody's face, than the questions raises: what is older - word or light? "And God said....and there was light" [8].

## 5 Conclusion

Our pilot study suggests the assumption that extrasensory form of communication - getting into higher spheres of consciousness - has its reflection in the EEG electrical activity of the brain.

If our subject receives the information through linguistic form into her consciousness, it would be important to explore further how the electrical brain activity behaves when the information connected to higher spheres of consciousness appears as images which are then expressed through linguistic form.

## References

- [1] Tu Fu, *The Word in a Dew Drop* (Rad, Beograd), p. 142, in Serbian transl.
- [2] V.N. Dubrovinskaja et al., Verbal activity and functional integration of cortical regions: developmental aspects, *8th World Cong. of IOP*, Tampere, 1996, abs. p. 100.
- [3] J.S. Ackerman, In pursuit of memory, *The Neuroscience, Newsletter* 6 (1996), p.3.
- [4] M.S. Courtney et al., Transient and sustained activity in a disturbed neural system for human working memory, *Nature* 386 (1997), pp.608-611.
- [5] P. Goldman-Rakic, Space and time in the mental universe, *Nature* 386 (1997), pp. 559.
- [6] V. Radičević, *Habillities of Sound Analysis and Word Synthesis in the Pupils of the First Class Of Primary School*, M.A. Thesis (CMS University of Belgrade, 1988).
- [7] V. Radičević et al., Impairment of expressive development and finding on MRI, *The 7th Int. Cong. ISBET*, Brasil, 1996, p. 61.
- [8] *The Bible*, Genesis and 3.

## A METHOD OF EPILEPTIC SEIZURES RECOGNITION

Nenad Rajšić<sup>1</sup>, Sreten Šuljagić<sup>2</sup>, Julijus Ivanuš<sup>3</sup>, Zoran Božović<sup>3</sup>, Aleksandar Kalauzi<sup>3</sup>,  
Dragan Rapajić<sup>2</sup>, Goran Nedović<sup>2</sup>, and Miloš Rajšić<sup>4</sup>

<sup>1</sup>Institute for Mental Health, Palmotićeveva 37, Belgrade, Yugoslavia

<sup>2</sup>Faculty of Defectology, Visokog Stevana 2, Belgrade, Yugoslavia

<sup>3</sup>Center for Multidisciplinary Studies, Kneza Višeslava 1, Belgrade, Yugoslavia

<sup>4</sup>Faculty of Mechanical Engineering Belgrade University, Yugoslavia

**Abstract.** The purpose of this study is to analyze preictal and ictal/postictal EEG patterns, and to find out parameters evaluation of such activities. Methods: 13 epileptic patients (>12 years old, 5 male and 9 female) suffering from 4 various epileptic seizures who underwent scalp EEG and video monitoring without preictal epileptiform discharges. A total of 45 seizures were analyzed. Ictal video was performed on 6 patients and valid witnessed ictal observation on other 7 patients. All seizures were interpreted as: 9 generalized tonic clonic (7 patients), 10 generalized tonic (3 patients), 1 complex partial (1 patient) and 25 simple partial (2 patients). According to clinical, EEG and CT/MRI data the most convenient channel was selected as the most informative on seizures origin. Off-line analysis of 20 seconds of preictal and 20 seconds of ictal/postictal EEG was performed using Discrete Fast Fourier Transform. Absolute and relative power spectra were calculated for 4 seconds epochs. Results suggest high increase of ictal/postictal absolute power values. Relative powers show decrease of ictal/postictal values in slow frequencies bands (delta and theta) and increase of relative alpha and beta activity. These suggest EEG correlates of consciousness changes due to epileptic seizures and also a model of seizures recognition.

**Key words:** EEG, epileptic seizures, recognition, relative power, consciousness

### 1 Introduction

Some patients, suffering from epilepsy related to local dysfunction of cortical or subcortical cerebral region, sometimes might be aware of seizure developing. A well known phenomena, called aura, denotes in fact that epileptic seizure is going to give more evidence of its effects. Unfortunately, some auras are very short or very unreliable to be used as method to change the behavior before the loss of consciousness.

Long term EEG recording together with Video recording has been introduced in Epilepsy department in Institute for Mental Health since 1991. We developed a tool for EEG signal analysis of human EEG [1]. Apart from this, the particular statistical methods of EEG data analysis had been applied on experimental model of penicillin induced cat epilepsy [2]. The Relative Delta Index RDI ( $RDI=D/(T-D)$ );  $D$  means absolute power of delta and  $T$  means absolute

power from 1 to 32 Hz), showed high level of RDI several seconds before EEG abnormalities occur [3].

Early detection of some data closely connected to the beginning of the seizures, would have meant that some technical devices could recognize future event. After identifying signs of possible seizure and if these were recognized early enough, some kind of alarm, electrical or magnetic stimulation and even biochemical intervention might prevent an event [4-7].

### 2 The Aim of Study

The main goal of study is to investigate the course of absolute and relative power spectra before, during and after onset of epileptic seizures obtained from scalp EEG and to find out signs of future epileptic seizures.

### 3 Material and Methods

A patients group consists from 9 females and 5 male, aged 12 to 63, average 27 years. Almost all except one had his/hers first seizure between ages 0.5 to 21, average 13.8 years, median 10.6. Neonatal injury was proven by 3 patients, and genetically predisposition by 2. All patients underwent long term EEG in Epilepsy department of Institute for mental health. The recordings were made using 8-channel Medilog<sup>®</sup> 9000-II recorder (Oxford Medical Ltd, Oxford). Scalp electrodes position was determined according to standard 10-20 system [8].

**Table 1** The demographic and some clinical data of a patients group.

No	Case No	Gender	Age at time of investigation	Age at the first seizure occurred	Possible or confirmed etiology
1	428	F	41	7	neonatal (unbil.str)
2	50	F	17	13;3	rheuma.feb.(11y)
3	105	F	63	56	genetic
4	199	M	22	10	neonatal (VE)
5	388	F	39	8	demielin./parasites
6	97	M	39	10	neonatal/AVV
7	1	M	12	0;6	West Sy
8	63	F	16	12	?
9	110	F	21	21	?
10	118	F	23	2;6	genetic
11	354	M	18	15	?
12	38	F	33	21	?
13	372	F	17	10	?
Total 13		F=9, M=4	mean: 27 (12-63)	mean: 13.8 (.5-56)	

**Diagnosis:** During EEG recording simultaneous Video recording was performed on 6 patients. All ictal Video records were analyzed and correlated with ictal EEG. Four different possibilities were found in preictal EEG: (a) no epileptiform focal abnormalities (4 patients), (b) slow wave activity at the very onset of seizure (1 patient), (c) "early" specific focal abnormalities during long term EEG unrelated to investigated preictal EEG (8 patients), and (d) epileptiform SSWA (spike and slow wave activities) before seizure onset (1 Pat.). No preictal attenuation of EEG activity was found in our group. Ictal EEG was investigated after digital filtering as well as postictal EEG in order to find any lateralization in EEG signal total or slow waves absolute power. All seizures were interpreted as: 9 generalized tonic clonic (by 8 patients), 10 generalized tonic (by 3 patients), 1 complex partial (1 patient) and 25 simple partial (by 2 patients). Seizures duration ranged between 4 and 216 seconds.

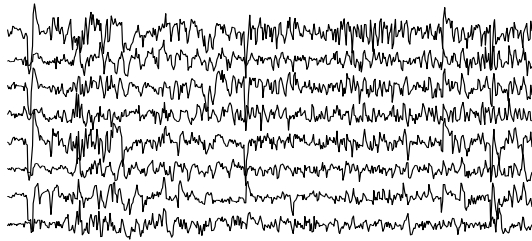

**Figure 1** Pat. No. 354 (18 y., male, first seizure with 15y.). Montage: (1) Fp2-F4, (2) C4-P4, (3) F8-T4, (4) T6-O2, (5) Fp1-F3, (6) C3-P3, (7) F7-T3, (8) T5-O1. Seizure onset. There is visible more pronounced spiking over right side, especially frontal. After that seizure (not shown) slow intermittent delta activity right frontal, suggested possible epileptogenic area.

In the following figures there are examples of two seizures. First seizure (Fig.1) arose during morning simultaneous video and EEG session. According to video and clinical signs, he was looking in front of him without any movement. Shortly after 30 seconds version of head and trunk observed as well as tonic-clonic seizure (the EEG during generalized convulsive episode not shown).

The second seizure arose from light sleep or drowsiness, but more rapidly than the first one. According to the video recording he pouted his lips, turned his head and trunk in flexion direction, extended his legs, made several desynchronized ballistic movements with limbs. At the end of motor signs of seizure he was almost at once responsive but dysphasic about 1 minute. After the seizure (not shown) slow delta activity above frontal left region was observed (Fig. 2):

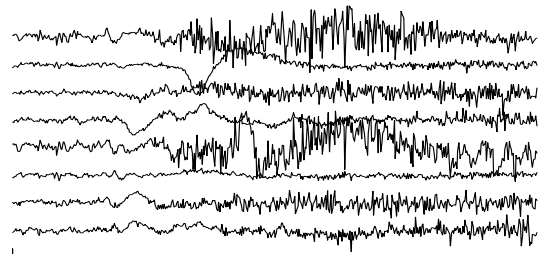

**Figure 2** Pat. No.. 199 (male, 25 y., first seizure at 10 y., presumed etiology perinatal trauma, possible left frontal epileptogenic area) Montage: (1) Fp2-F4, (2) C4-P4, (3) F8-T4, (4) T6-O2, (5) Fp1-F3, (6) C3-P3, (7) F7-T3, (8) T5-O1. Time base 32 seconds. Suddenly onset of generalized tonic seizure.

The clinical data of all patients are shown in Table 2.

**Table 2.** Clinical data significant for diagnosis

No	Case No	preictal EEG	>Ictal EEG	>postictal EEG	preictal EEG: a=0, b=nonsp c=specific, d=preictal sp.	Ictal Video /?=witnessed data	Seizures type	No szrs.	Seizures duration
1	428	slowWFront	>gener.Sp	>no lat.	b	Jacsonian clonic?	SP	12	25.6s(16-40)
2	50	Srev.ph.F4	>gener.SP	>depress.	c,d	Version/posturing/head turning	SP	8	10.2s(4-14)
3	105	slowWT3	>ryth.Theta	>no lat.	b	pseudoabsence ?	CP	1	34s
4	199	no lat	>spikes F	>slow act.F3	a	version/posturing	GT	2	19s
5	388	S/slW P3T3	>gen	>no lat..	c	posturing ?	GT	5	55.8s(42-60)
6	97	no lat.	>ryth.S	>no lat	a	posturing ?	GT	3	10s
7	1	SWK F7	>sec.gen.	>F7	c	vokal./vers>right	GTC	2	76s, 482
8	63	no lat	>gen	>slow act.F4	a	Jacsonian clonic?	GTC	1	53s
9	110	SWK T3	>gen	>slow act.T3	c	verbalisation/gen.	GTC	1	42s
10	118	SC3P3	>gen	>no lat.	c	Jacsonian clonic?	GTC	1	46s
11	354	SSWA	>GTC	>slow act. F8	c	abs.no focal/vers.L	GTC	1	108s
12	38	(Srev.ph.Fb2Sp2)	>gen	>no lat.	c	general motor agitation	GTC	2	187s, 216s
13	372	no lat/gen/no lat			a	Jacsonian clonic?	GTC	1	110s
Tot=13					Na=4; Nb=1; Nc=8; Nd=1.	Video=6, ?=7		Tot=45	

**Data selection:** All records were digitized to 8-bit accuracy using Medilog<sup>®</sup> 9200 replay system and a sampling rate of 128 Hz. No analogue filtering was employed prior to digitization since the recorder and replay system has a combined frequency response of 0.5 to 40 Hz with roll-offs at -40 dB/decade. Spectral analysis of EEG by a particular program FFT (MatLab version 4.2c.1) was applied. Absolute and relative powers were calculated for every 4 seconds epoch in 20 seconds of preictal and 20 seconds of ictal and postictal EEG. Limits of EEG bands were according to the power of 2: 1-3.75 Hz ('delta'), 4-7.75 Hz ('theta'), 8-15.75 Hz ('alpha+') and 16-31.75 Hz ('beta').

**Table 3** Clinical and CT/MRI data relevant for presumed region of seizures origin

N	Case No	Clinical data	CT	MRI	Syndrome (RCEES, 1989)	Presumed region of szr. origin for application of RDI
1	428	C3	left atr.	left subc. atr.	1.2	C3
2	50	F4	right atr.	-	1.2	F4
3	105	T3	left T. atr.	-	1.2	T3
4	199	(F3)>GTC	mild atr.	-	1.2	F3
5	388	(P3C3)>GTC	mild atr.	L&R 2 lesions	1.2	C3
6	97	C3 > GTC	left T lesion	-	1.1	C3
7	1	West>F7	normal	-	1.2	F7
8	63	sleep GM	normal	normal	3.2	F4
9	110	T3	normal	normal	1.2	T3
10	118	sleep GM	normal	normal	3.2	P3
11	354	F8	normal	normal	3.2	F8
12	38	sleep GM	right atr.	-	1.2	T4
13	372	sleep GM	normal	-	2.1	C4
14	505	F4>GTCS	right atr.	-	1.2	F4

## 4 Results

Mean values of absolute and relative powers obtained for 5 preictal and 5 ictal/postictal epochs (a total of 20 seconds preictal and 20 seconds ictal/postictal scalp EEG from selected region) were calculated. Preictal and ictal/postictal power values were subtracted.

As shown in Table 3 absolute power values in ictal/postictal period were much greater. The same increase of relative power values occurred in ictal/postictal period only to fast activities (alpha and beta bands) whereas slow activities show greater values before seizures.

**Table 4.** The difference between preictal and ictal/postictal mean absolute and relative

EEG band	delta	theta	alpha+	beta
frequency (Hz)	1-3.75	4-7.75	8-15.75	16-31.75
abs. differences preictal - ictal/postictal (microV <sup>2</sup> )	-2285.32	-808.29	-1610.10	-4790.19
rel. differences preictal - ictal/postictal (%)	25.6265	6.5693	-2.8535	-29.3423

**Region selection:** According to EEG, CT/MRI and clinical data seizures were classified in 9 various groups. Ictal Video and EEG, solid witnessed seizures description as well as clinical, interictal EEG, CT and MRI data were utilized to classify each case in the most relevant syndrome. According to EEG, CT/MRI and clinical data seizures were classified as frontal (8), temporal (5) or parietal origin (1). Absolute and

relative powers to 9 various regions was applied with suspected or confirmed source of epileptogenic activity in relation to 10-20 system [8]:

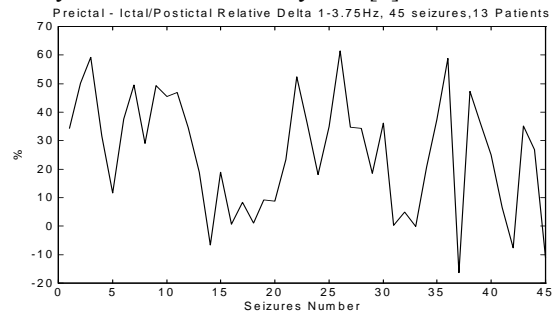

(a)

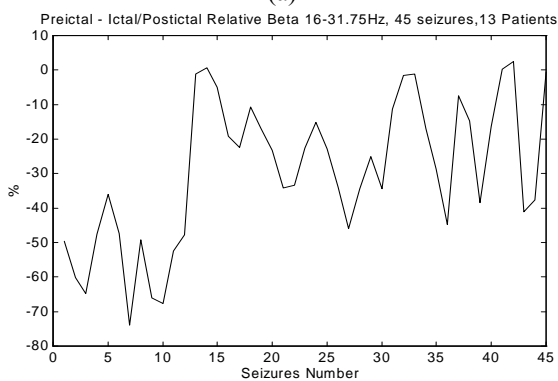

(b)

**Figure 3** Difference between Preictal and Ictal/postictal Means, Relative a) Delta and b) Beta

## 5 Conclusions

Scalp EEG offer considerably less data in comparison to some other methods, but, still remains a tool in investigation of brain function, especially in epilepsy. A set of 8 values in Table 4 (4 absolute and 4 relative differences) represent a possible model for seizure onset recognition as well as a consciousness changes.

These results are a step to on - line recognition of seizure activity.

## References

- [1] N. Rajšić, *Interictal Background Activity of EEG by Epilepsy*, Doctor Thesis (Medical Faculty, Belgrade, 1990).
- [2] S. Šuljagić, *Prediction of Manifested Electroconvulsive Episodes in Experimental Model*, Master Thesis (Center for multidisciplinary studies, Belgrade, 1990).
- [3] N. Rajšić, et al., Relative delta power can predict some epileptic seizures, *Epilepsia: 22nd International Epilepsy Congress*, Dublin, Book of abstract (1997), p. 246.
- [4] H. G. Wieser et al., Interplay of interictal discharges and seizures: some clinical and EEG findings, in P. Wolf, ed., *Epileptic Seizures and*

- Syndromes* (John Libbey & Company Ltd., 1994), pp. 563-578.
- [5] M. Manford et al., An analysis of clinical seizures patterns and their localizing value in frontal and temporal lobe epilepsies. *Brain* 119, (1996), pp.17-40.
- [6] H. Qu and J. Gotman, A Patient - Specific Algorithm for the Detection of the Seizures Onset in Long - Term EEG Monitoring: Possible Use as a Warning Device, *IEEE Trans. Biomed. Eng.* 44 (1997), pp.15-122.
- [7] J. Pardey et al., A new approach to the analysis of the human sleep/wakefulness continuum, *J.Sleep Res.* 5 (1996), pp.201-210.
- [8] H. H. Jasper, The Ten-Twenty System of the International Federation, *EEG Clin. Neurophysiol.* 10 (1958), pp.371-375.

# THE UNIVERSAL CONSCIOUSNESS AS A UNIVERSAL COMPREHENSION OF THE UNIVERSAL CODE

Miloje Rakočević

Department of Chemistry, Faculty of Science, University of Niš,  
Ćirila i Metodija 2, Niš, Yugoslavia

**Abstract.** There are many approaches to investigate the consciousness. In this paper we will show that it makes sense to speak about the consciousness as about the comprehension of something. Furthermore, to speak about the universal consciousness as about the universal comprehension of the universal code; the comprehension from different investigators, in different creativeness, through different epochs.

**Key words:** *universal consciousness, universal comprehension, universal code, logic, periodic system of chemical elements, genetic code, microtubules code, yin-yang code.*

## 1 Introduction

There are many approaches to investigate the consciousness. First of all, there are the physiological and psychological approaches. But, other approaches are also possible ... More in accordance with Russell's [1], and Vygotskii's [2] and less with Ashby's [3] and Arbib's [4] views, our *hypothesis* (in establishing our approach) is that the investigation of the consciousness must always consider the consciousness as a whole system, as a unity of physiological (including biochemical and biophysical) and psychological-logical characteristics. If so, if physiological characteristics must be in a relation to psychological, and these in a relation to logical characteristics, then the consciousness itself must also be *a relation to objects* (Russell, p. 168: "... we are said to be 'conscious of something'; in this sense, 'consciousness' is a relation"; p. 170: "The ... relation to an 'object', it could be said, is characteristic of every kind of consciousness"; p. 173: "Nevertheless we can distinguish 'mental' events from others..."; Vygotskii, first chapter: "... consciousness is a unity of all functions"; Arbib, p. 1: "... all the functioning of the nervous system relevant to our study is mediated solely by passage of electrical impulses by cells we call neurons"; Ashby, p. 11: "... the book deals with only one of the properties of the brain, and with property - learning - that has long been recognized to have no necessary dependence on consciousness"; p. 12: " And until such a method [exists] ... the facts of consciousness cannot be used in scientific method").

Considering our concept, together with Russell's idea about consciousness as a relation to objects in sense to be 'consciousness of something', with Sartre's

idea [5] that any consciousness is the consciousness about something, with Petronijević's idea [6] that the contents of the consciousness are the notions, and finally, with Einstein's idea [7] that all notions within 'natural laws' are from the space-time nature, we will show that it makes sense to speak about the consciousness as about the comprehension of something (to comprehend – to be in relation to something within the consciousness of someone!). By this, if we can speak about a universal concept of the organization of a *whole* from the *parts*, then it makes sense to speak about a universal comprehension of such an organization. On the other hand, if within such an organization a *universal code* must exist, then it makes sense to speak about the universal comprehension of the universal code.

In the light of the said, it makes sense to investigate how human consciousness, in form of a comprehension, has been expressed itself through different epochs: in some specific ways, or in one and the same - universal way? In this paper we will show that *that* was the case: in various works, by different creative investigators, within very different epochs, an exactly *universal code* has been expressed, in one and the same - universal way. In other words, we will show that human consciousness was always in relation to a universal code through a specific manner.

## 2 Universal Comprehension of the Universal Code

What is the universal code? That is any system organized as a *whole*, consisting of *parts*; the system organized through the unity of the best possible symmetry, best possible harmony and best possible proportion; the unity based on the *Logos* (*Logos* itself is more than *law*, *principle* and *scenario*, altogether). Because *the objects* within the reality are organized through three dimensions (coordinates), and because orthogonality principle is valid for reality, the universal model of the universal code must be that, which is presented in Fig. 1, and which must be based on the model (logical square) presented in Fig. 2. On the other hand, it must be so that there exist the best examples of the realization of the universal code, as we will show in further text.

First of all, the best possible example is the genetic code, represented by the model, presented in Fig. 3, in correspondence with the models, presented in Figs. 4-6, the best possible (*best plus best!*) is also the chemical code, represented by models, presented in Figs. 7-10; then can follow: the human masterpieces-code, represented by models, presented in Figs. 12, 13; the human language-code, represented by models, presented in Figs. 14, 15; and the human logic-syllogism-code, represented by model, presented in Fig. 16, etc.

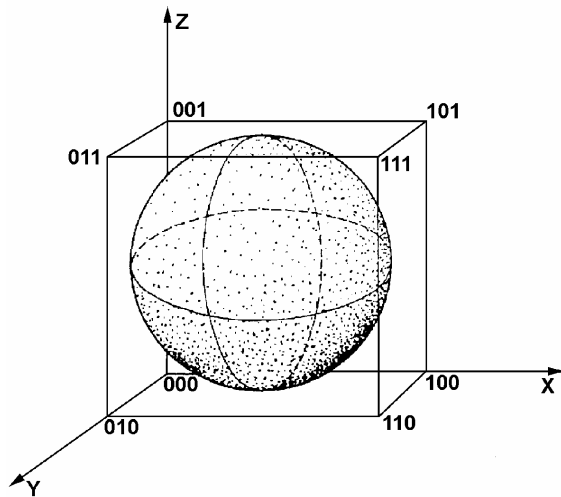

**Figure 1** The LIGHT (Logical-Information-Geometric-Homeomorphic-Topological) model of the genetic code. It is in full accordance with Mendeleev's cube-sphere model (Fig. 7) of the chemical code (for details see ref. [10], p.54).

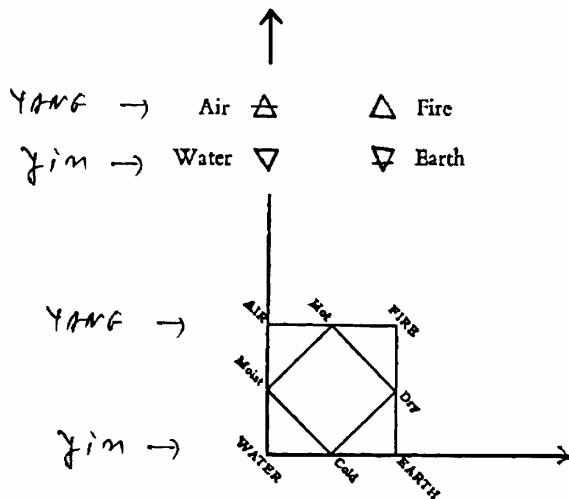
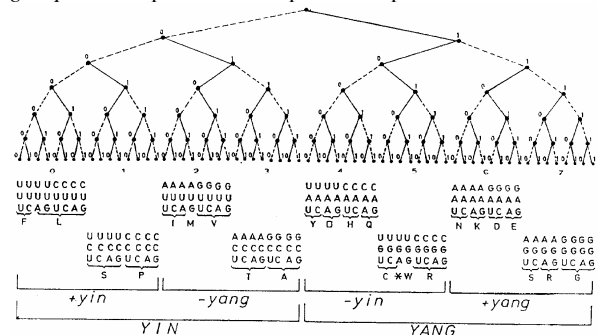

**Figure 2** The Alchemists' (as a Boolean) logical square. It follows from the Aristotelean square; both are in accordance with the yin-yang system and with the genetic code logical square (cf. Fig. 4). Further, they are in accordance with the fundamental particles square: neutrino (00), electron (01), quark down (10), quark up (11). For the (Boolean) logical square regarding the fundamental particles see ref. [10], p.283.

**Remark 1.** All the three elementary types of *symmetries* can be represented by the binary symmetry of the *segment line*

( $n$ ) (or  $A \leftrightarrow B$ ) with the middle point  $M$ , where  $AM = MB$ . The point  $M$  contains (in itself) the quantity  $m = 1/2 n$  which represents the arithmetic mean of  $AM$  and  $MB$ . This is the essence of binary symmetry as the "symmetry in the simplest case" [8,9]. Its simplicity is the reason why we can consider binary symmetry as the *best possible symmetry*. On the segment line  $n$  or  $A \leftrightarrow B$  there is also the point  $H$  which contains (in itself) the quantity  $h = 2/3 n$ , representing the *harmonic mean*, where lies the key for the triadic Cantor set, valid for the genetic code, not only in form of a binary tree, but in form of a fractal structure, as it is shown in [10,11]. The link of the harmonic mean and triadic Cantor set is the essence of *the binary harmony*, also valid for the genetic code, more exactly, for the classification of the genetic code constituents as it is shown in [12], p 137. The segment line  $n$  can be, in infinitely numerous ways, divided into two unequal parts; one of these is **the golden mean** as the *best possible proportion*. (About the validity of the **golden mean** for the genetic code, see in [11], p 68).

**Remark 2.** Since the genetic code can be reduced to the Gray code model (Fig.1 in [13], p 188) and to a binary tree (Fig. 2 in this paper), with a starting codon UUU 000000 and a final codon GGG 111111, it follows that as to question of symmetry in relation to the genetic code *the mathematical group theory* does not hold. This follows from the fact that set  $Q$  of rational numbers, including zero, does not form a *group* with respect to a multiplication operation.



**Figure 3** The genetic code binary tree. It is in full accordance with the yin-yang binary tree in the oldest book - I Ching. The relations between 64 codons and 64 hexagrams: to each *zero* corresponds a dotted line; to each *one* corresponds a full line (see ref. [10], p. 274).

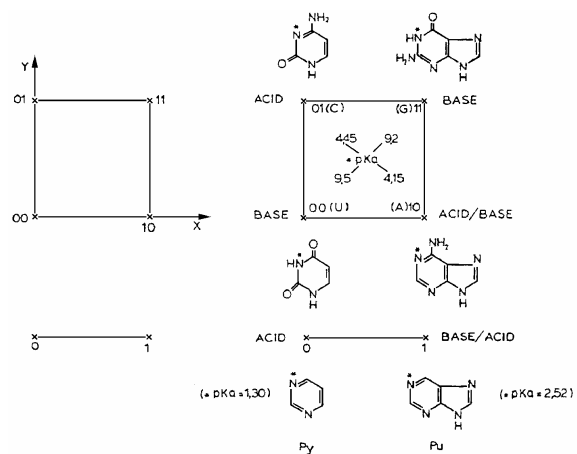
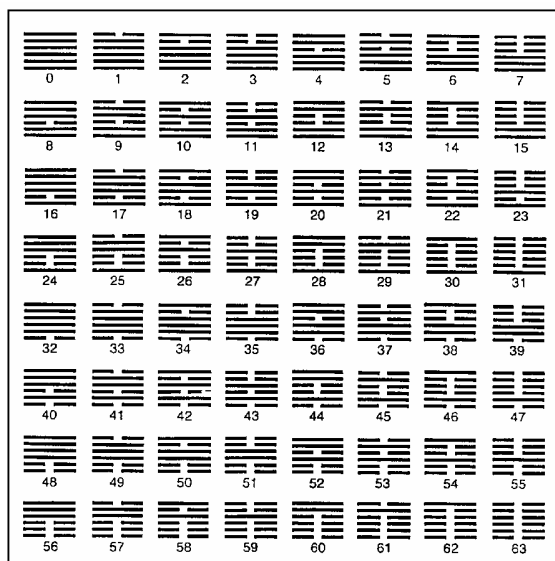

**Figure 4** The Boolean logical (LIGHT) square of the genetic code. It is in full accordance with the Aristotelean (Boolean) logical square of four entities (cf. Fig. 2) (For details see ref. [10], p. 8).

## 2.1 The Important Examples

1. A serious analysis could show that Crick and Einstein, more than any other scientists, are responsible for our understanding of the link between the molecular basis of life and consciousness, and between both these and the universal code of the Nature. Crick made first and important step, not only in the research of the genetic code (see *References* in [10,11]), but also first and important step in argumentation that consciousness is a property of molecular activities in neurons and networks of neurons in our brain [14]. On the other hand, Einstein was the first led to arrive at the conclusion of the continuum of the space-time of the Universe. But here we must understand that when he speaks about the four-dimensional continuum of space-time, he means in fact on the three-four-dimensionality; and when he speaks about the *space* he speaks also about a space, which is "the space of counting". This opens a possibility to speak about coding coordinates and coding spaces accordingly to universal code model as a union of cube-sphere (presented here in Fig. 1) and hypercube-hypersphere (not presented in this figure); the model, valid at the same time for Crick's macromolecular structures as well as for Einstein's three-four-dimensional space-time. By this, the word is not only about the real space, and not only about the Boolean *Logical space*, but about a **Logical-Information-Geometric-Homeomorphic-Topological space**, altogether and at the same time (about **LIGHT model and system** see in [10], pp 61-63). From the said it follows that any **LIGHT space**, characterized by three-four-dimensionality, must be taken as Boole-Einstein's **LIGHT space**.

2. The second example can be the *chemical code*, represented here by some Mendeleev's original works (Figs. 7-10). The Mendeleev's *System* of elements is different from our today's *Table* of elements. The 20th century science escapes Mendeleev "mysterious" form of his system of elements, saying that Mendeleev made some "arithmetical errors" (Fig. 10; cf. [15], p. 185). However, Mendeleev's "errors", or our inadequate *understanding* of his work, is the **LIGHT approach** to the *system* of chemical elements. That is a coding system of  $3^4 = 81$  and  $4^3 = 64$  entities and a **LIGHT approach** as a coding approach. The coding system of  $3^4 = 81$  entities, because within the set of first 84 chemical elements (from H = 1 to the Po = 84) there are exactly 81 stable elements. The coding system  $4^3 = 64$ , because 84 minus 20 "monoisotope" elements equals 64 (cf. [16], chapt. 27, sect. "Relations odd-even", where Gould says that all even elements to the polonium, Po = 84, have minimally two stable isotopes, except beryllium; cf. [17], where it is said that within *chemical code* there are exactly 84 elements; cf. 64 hexagrams in Fig. 5 and 81 tetragrams in Fig. 6). Thus, the conclusion that Mendeleev clearly and precisely gave the system of chemical elements as a three-dimensional Boolean **LIGHT cube**, as we can read from the Figs. 7, 8.



**Figure 5** The Yin-Yang system of ancient China based on hexagram arrangement: it consists of 64 hexagrams ( $2^6 = 64$ ), which display every possible combination of archetypal human situations – along with thousands of variations caused by changing lines. Notice that an inverse countdown is possible. In such a case the 63rd number is zeroth. If so, then  $2 \times 6$  and  $2^6$  are the numbers of lines and hexagrams respectively.

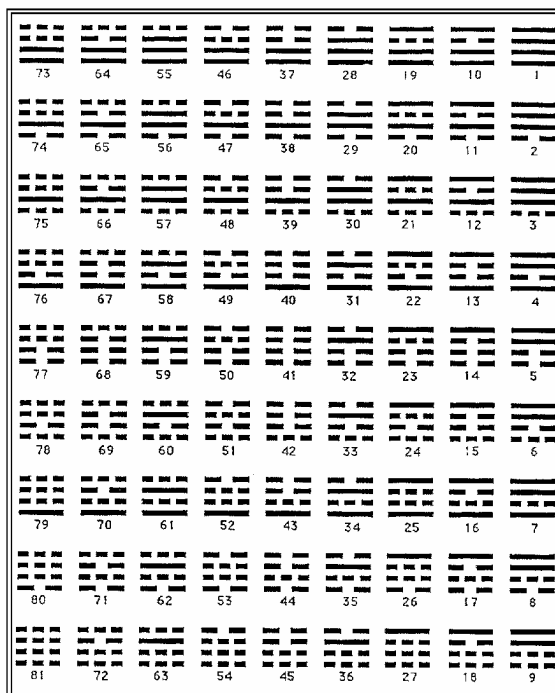

**Figure 6** The Yin-Yang system of ancient China based on tetragram arrangement: a tetragram is constructed from four stacked lines of three types (full, broken, and twice-broken). There are 81 possible combinations of these three types of lines ( $3^4=81$ ). It is no accident that ancient Chinese book *Tao Te Ching* has eighty-one chapters. Notice that an inverse countdown is possible. In such a case the 81st number is zeroth. If so, then  $3 \times 4$  and  $3^4$  are the numbers of lines and tetragrams, respectively.



The periodic system of the chemical elements is really three-dimensional, but not in the sense expressed through the Leland C. Allen's model [18,19], as here it is presented in Fig. 11, but in the sense expressed through the original Mendeleev's model as it is presented in Figs. 7,8, which model is in accordance to the model of universal code, presented in Fig. 1 (Cf. [18], p 9003: "It is argued that electronegativity is the third dimension of the Periodic Table"; and [19], p 1510: "It is clear that something is missing ... Configuration energy (CE), the average one-electron valence shell energy of a ground-state free atom, is the missing third dimension".) Accordingly to Mendeleev, the same groups of the elements are at all three coordinates (i.e. dimensions) at the same time, as it follows from the model presented in Fig. 7. Notice that within Fig. 7, in relation to Fig. 8, the noble gases are at the end in all three cases. That comes from the fact that the groups of elements must be at the vertices of the LIGHT cube, i.e. at the vertices of the model of the universal code, presented here in form as in Fig. 1.

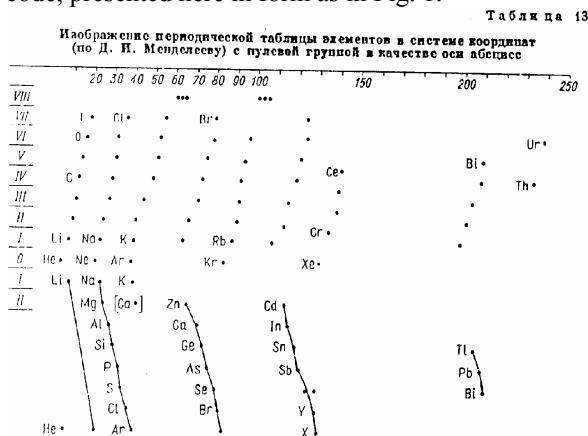
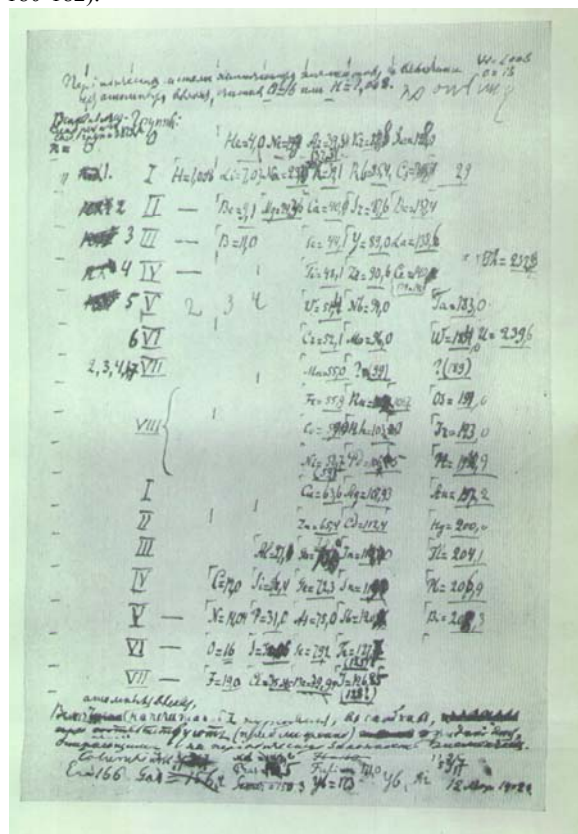

**Figure 7** The Mendeleev's three-dimensional periodic system as unity of cube-sphere; cube: through the three coordinates; sphere: through the noble elements, which are at the end of all three coordinates.

From these facts it follows that the third dimension of the periodic system as a "New dimension for Mendeleev" [20] is not necessary, because Mendeleev was *conscious* of this dimension 100 years ago. Also, Mendeleev was *conscious* of the problem of "rare earth", although there are different opinions ([20], p. 13: "The two versions differ simply in their arrangements to accommodate elements such as the rare earths, but the result must be to leave many with the impression that Mendeleev had not made up his mind about something of importance").

**Remark 3.** In his long periods Table ([15], p. 188), Mendeleev gave a specific position to the first element of "rare earth", i.e. lanthanides, Ce, not in the third but in fourth group; then still 13 groups for 13 lanthanides. If so, Mendeleev must have *conscious* by seen that the short periods Table with 8 groups of elements (Fig. 10) corresponds with cube, and long periods Table with a hypercube (for details see [10], pp. 197-200). ... Bearing in mind all the said Mendeleev's insights, it was possible to

determine the definitive real positions of elements within 3-4 dimensional periodic system ([10], pp 61-63 and [11], pp 180-182).



**Figure 8** The Mendeleev's project for the three-dimensional periodic system, presented in Fig. 7. A half volume of the cube is realized with the realizations of the line 2-3-4-5, and the whole volume with the line 2-3-4-6-7 (half : whole = 1 : 2). Notice that from the point 4 there are two possibilities. First: the realization of one step, 4-5, i.e. a half of the volume; second: the realization of two steps, 4-6 and 6-7, i.e. a whole of the volume (1:2 still once; cf. Remark 1).

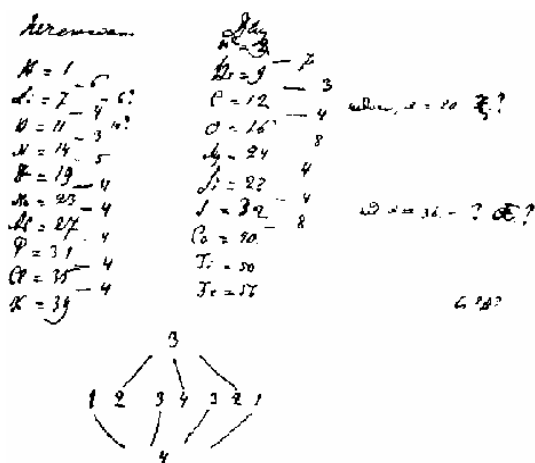

**Figure 9** The Mendeleev's system of chemical elements oddity-evenness principle; the valence trinity-quaternity system; the atomic mass distances integer system.

**Remark 4.** From figures presented it is clear why it is sensible to speak about the chemical code in connection with

the genetic code. There are certain aspects of correspondence and coherence of the two codes: (I) within the genetic code there are exactly 61 codon situations (stable aggregations) with amino acid corresponding meaning, plus 3 breaks in that meaning (3 "stop" codons), plus 20 non-codon situations (20 protein amino acids); (II) within the chemical code there are exactly 61 situations (in the form of stable aggregations) which have multi-isotope meaning, plus 3 breaks in stable isotopy (3 "stop" situations: Tc, Pm, Po), plus 20 non-stable isotope situations (20 "mono isotope" elements). Thus, altogether there are 84 entities within each: within the genetic, and within the chemical code too. This is the very topic: the chemical code, built on the very principles mentioned and in complete accordance with the genetic code.

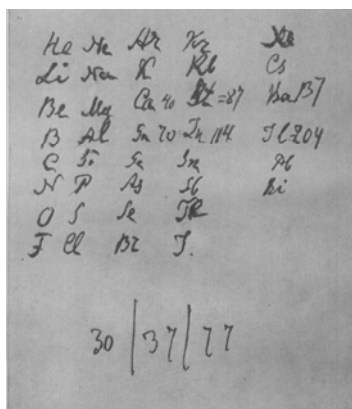

**Figure 10** Two Mendeleev's arithmetical "errors" (!) ([15], pp 128-129, photocopy X ). For details see [10], pp 197-200.

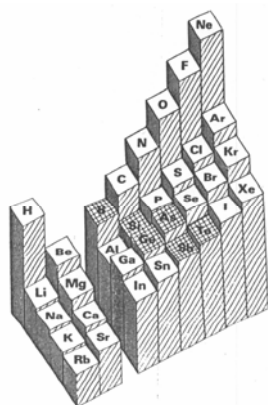

**Figure 11** Electronegativity as a "third dimension" of the periodic system [18].

3. The grandiose creative investigators as Charles Darwin and Gregor Mendel were also *conscious* that a universal harmonious *whole-parts* system-model (the universal code) must exist in the nature. So, the one and only Darwin's diagram (binary-code tree with 16 levels, exactly as Mendeleev's *Periodic system*, with 16 groups) in *Origin of Species* represents the first systematic information approach (LIGHT approach) to the analysis of the evolution relations between organisms [21]. (For details see in [10,11]; for Mendel's universal code in [10], pp. 14-19 and 21-25.)

## 2.2 The Significant Characteristics

The genetic code is an example of the Boolean logical (LIGHT) square-cube-hypercube realized through four nucleotide molecules: U(00), C(01), A(10), G(11) [10,11,13,22-26]; or, realized through the four rosettes (classes of the codons) on the binary-code tree, presented in Fig. 3, in a full accordance with the *Yin-Yang* code of the *I Ching* ([27], p 223). The microtubules system was identified also as a code [28]; more exactly as two codes:  $K_1[13,2^6,5]$  and  $K_2[24,3^4,13]$  (cf. these 64 and 81 codewords with analogous "codewords" within chemical code, mentioned above; also cf.  $2^6$  with 64 hexagrams in Fig. 5 and  $3^4$  tetragrams in Fig. 6).

d	c	b	a	e	f
				.	1
1	0	[1	00001	2	9
1	0	[1	00002		
1	1	0	00004	1	1
1	0	[1	00008		
1	0	[1	00016	2	12
1	1	0	00032		
1	1	0	00064	2	3
1	0	1	00128	1	M
1	1	0	00256		
0	1	0	00512	2	3
1	0	[1	01024		
1	0	[1	02048	2	12
0	1	0	04096	1	1
0	0	[1	08192		
0	0	[1	16384	2	9
				.	1

**Figure 12** The Homer's and Njegos's (Boolean) space sequence,  $N=2^n$ . (a) The binary sequence whose sum is  $2^{15}-1=32767$ ; (b) Homer's choice:  $27803_{10} = 66233_8 = 110110010011011_2$  (the number of verses for Iliad plus Odyssey); (c) Njegos's choice:  $4964_{10} = 11544_8 = 001001101100100_2$  (The Mountain Wreath: printed version 2819 verses plus 318 person-scenes, plus 116 pages for printing = 3253; manuscript version 1528 verses plus 150 person-scenes plus 033 pages = 1711; all together - the total spaces of The Wreath:  $3253 + 1711 = 4964$ ); Homer's plus Njegos's system:  $66233_8 + 11544_8 = 77777_8$ ; (d) Homer's choice:  $3583_{10} = 6777_8 = 000110111111111_2$ . The number 3583 represents the difference of Iliad and Odyssey:  $15693 - 12110 = 3583$ . The relation between two numbers  $77777_8$  and  $6777_8$  was given through a logic program: to exclude first position, and then - to write the result ( $7777_8$ ); after that: to exclude first unit in the first position, and, then to write the result ( $6777_8$ ). The choice of logic for the number  $3583_{10} = 6777_8$  is as follows. From the total sequence ( $2^{15} - 1$ ) to exclude all the situations that contain the whole third perfect number 496; (e) The number of Homer's yes-choice and non-choice situations; (f) The (in literary science) known composition sequence of Iliad: from the middle point (Mission to Achilles) 1 day full, 9 empty of events etc.

On the other hand, the comparison of the Boolean logical squares (more exactly: LIGHT squares), presented in Figs. 2,4 shows that both codes, genetic code and Yin-Yang code, correspond to the *logical square* of the four “elements” of the Universe, known to Aristotle and to Alchemists: *Fire* as +Yang (11), *Air* as -Yang (01), *Earth* as +Yin (00) and *Water* as -Yin (10).

As the third, the binary tree of the *I Ching* and the binary tree of the genetic code, both correspond to Farey's binary tree, which determines the quasiperiodical transition to deterministic chaos (cf. ref. [10], pp 182 and 280).

**Remark 5.** The binary-code tree presented in Fig. 3 corresponds *ipso facto* with the Farey tree ([11], pp 182 and 280), which represents the rational numbers relationships within the interval (0/1, 1/1), what means the relations of *parts* within *a whole*; all positions within the binary-code tree correspond to all fraction locations within the Farey tree - each to each [29]. In fact both trees are *the binary trees* because each generation within both is simply a power of 2. The essential characteristic of the Farey tree is the *Golden mean route* realized through the binary digit notation 101010 within the first full *zigzag* line on the right at the model, presented in Fig. 3 (the best possible symmetry – the binary symmetry).

ODISSEY	(0)	12110				
			1393			
EVEN	(1&0)-1=	13503		1095		
			298		998	
FIRST	(1&0)-0=	13801		97		998
			201		0	0
SECOND	(1&0)+0=	14002		97		998
			298		998	
ODD	(1&0)+1=	14300		1095		
			1393			
ILIAD	(1	15693				
		83409			9959	
		x 21			x 01	
		1751589			9959	
						1741630

**Figure 13.** The two Homer's epics. The both have 24 cantos each: 12 the first, 12 the second; 12 even and 12 odd. The final result 1741630 is the same as within the genetic code: “The number of all distributions in the set of 64 codons is 1741630” [22, p 191]; cf. Fig. 12. Notice that 1751589 = 63 x 27803 (*Iliad* plus *Odyssey*); the 63 is the last point on the binary tree of the genetic code in Fig. 3; the 21 is the last point on the Floor-table of genetic code (Table 4.1 in [10], p.56).

### 3 Final Comments

Finally, a surprise: human *consciousness*, in the form of a *comprehension*, expresses itself, in some specific way, through the human masterpieces-code, the human language-code, and the human logic-syllogism-code. Masterpieces such as those written by Homer, Dante, Shakespeare, Goethe, Pushkin, Njegos, Tolstoy. We find their compositions were written according to the same Law as possessed by the chemical and genetic codes - *the Golden Mean*. Figure 4.1 shows how Homer and Njegos generated the *verse number* for their works from the binary sequence  $2^n$ . On the other hand, Fig. 14 shows De Saussure's sound

system within the human natural language-code [30]. But that what is very interesting is the fact that the model in Fig. 14 (*logical square*) can be also valid for the language-accent. For example, in Serbian (for the words) there are *two and two* and still once *two and two* (first law of the logical square) types of the accent: two *long* and two *short*; then two *falling* and two *rising*. At the same time there are *one and three* (the second law of the logical square) types of the accent: one fast (*short-falling*) and other three (*short-rising*, *long-rising* and *long-falling*) are slow. In French (for sounds) there is **one** *e* without accent (to relation *e* mute) and **three** *e* with the accents: *é*, *ê* and *è*. In English (for sentences) the intonation (cf.[31], pp 8-24) realizes itself through a logical square as it is shown in Fig. 15 (*start* 00, *end* 11 and two intermediate situations: *rising* 01 and *falling* 10). At the end we show that human *consciousness* in the form of a logical reason (syllogism etc.) must also be determined by Boolean logical square, more exactly by LIGHT square as it is presented in Fig. 16 [32].

#### PRINCIPES DE PHONOLOGIE

On obtient ainsi le schéma des variations possibles :

	I	II	III	IV
a	Expiration	Expiration	Expiration	Expiration
b	Art. bucc.	Art. bucc.	Art. bucc.	Art. bucc.
c		~		~
d			.....	.....

La colonne I désigne les sons *sourds*. II les sons *sonores*, III les sons sourds nasalisés, IV les sons sonores nasalisés. Mais une inconnue subsiste : la nature de l'articulation buccale ; il importe donc d'en déterminer les variétés possibles.

**Figure 14** De Saussure's sound system of natural language. It can be seen as a specific Boolean logical square: I(00), III(01), II(10), IV(11) ... (cf. two very similar designation systems: De Saussure's natural language designation system, ref. [30], p.70, and R. Swanson's genetic code designation system, ref. [13], p. 188).

This is Dick ['ðisiz \*dik].

This is Betty ['ðisiz \*beti].

I'm Dick Knight ['aim 'dik \*nait].

Hullo, Dick [\*hʌləu, \*dik] Fine, thanks. [\*fain, \*θæŋks]

Is this your camera?

**Figure 15** The sentence intonation within English language. A “hidden” logical square seems to be self-evident: (00) *starting*, (01) *rising*, (10) *falling*, (11) *ending*.

In conclusion we can say that our concept of the universal consciousness as a universal comprehension must be tested by further investigations from different aspects and in relations to the other different approaches. For example in relation to the quantum physics concept [33] and information physics concept [34,35]. By this, our two previous papers related to consciousness [36,37] also must be included in the testing.

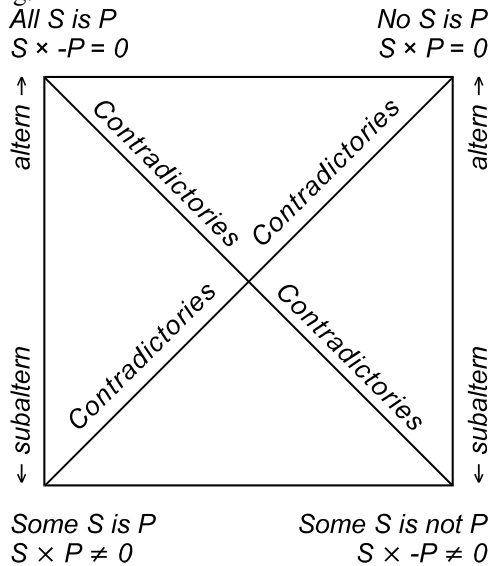

**Figure 16** The Aristotle's syllogism "square of opposition" can be seen as specific Boolean logical square: No S is P (00), Some S is not P (01), Some S is P (10), All S is P (11) ... (cf. ref. [32], p. 341).

**Acknowledgments:** This research is dedicated to the soul of Petar Petrović Njegoš (1813-1851), who wrote the poem "Mountain Wreath" in accordance with the Harmonic mean and Golden mean laws, 150 years ago.

## References

- [1] B. Russell, *An Outline of Philosophy* (Unwin, London, 1979).
- [2] L.S. Vygotskii, *Thought and Speech* (Moscow, 1956), in Russian.
- [3] W.R. Ashby, *Design for a Brain* (Chapman & Hall, 1960).
- [4] M.A. Arbib, *Brains, Machines and Mathematics* (McGraw-Hill, New York, 1964).
- [5] J.-P. Sartre, *L'imaginaire* (Galimard, Paris, 1940).
- [6] B. Petronijević, *Principien der Metaphysik* (Carl Winter, Heidelberg, 1904).
- [7] A. Einstein, *Collected Papers I-IV* (Nauka, Moscow, 1965-1967), in Russian.
- [8] S. Marcus, Symmetry in the simplest case: The real line, *Computers Math. Applic.* 17 (1989), pp. 103-115.
- [9] P. Hilton, and J. Pedersen, Duality and the Descartes Deficiency, *Computers Math. Applic.* 17 (1989), pp. 73-88.
- [10] M.M. Rakočević, *Logic of the Genetic Code* (Naučna knjiga, Belgrade, 1994).
- [11] M.M. Rakočević, *Genetic Code as a Unique System* (SKC, Niš, 1997).
- [12] Dj. Koruga, M. Rakočević, N. Mišić, L. Matija, and S. Janković, A new classification of protein amino acids by module 3/2, *Archive of Oncology* 5 (1997), pp 137-138.
- [13] R. Swanson, A unifying concept for the amino acid code, *Bull. Math. Biol.* 46 (1984), pp. 187-203.
- [14] F. Crick, *The Astonishing Hypothesis: The Scientific Search for the Soul* (Charles Scribner's Sons, New York, 1994).
- [15] B.M. Kedrov, *Predictions in D.I. Mendeleevs Atomistics: Unknown Elements* (Atomizdat, Moscow, 1977), in Russian.
- [16] E.S. Gould, *Inorganic Reactions and Structure* (Holt, New York, 1962).
- [17] M.M. Rakočević, The coherence of the chemical and genetic code, *Zbornik radova (Compendium) of the Faculty of Science Niš* 2 (1991), pp. 1-29.
- [18] L.C. Allen, Electronegativity is the average one-electron energy of valence-shell electrons in ground-state free atoms. *J. Am. Chem. Soc.* 111 (1989), pp. 9003-9014.
- [19] L.C. Allen, Extension and completion of the periodic table. *J. Am. Chem. Soc.* 114 (1992), pp. 1510-1511.
- [20] J. Maddox, New dimension for Mendeleev, *Nature* 356 (1992), p. 13
- [21] C. Darwin, *The Origin of Species* (John Murray, London, 1859).
- [22] T. Alvager, G. Graham, R. Hilleke, D. Hutchison, and J. Westgard, On the information content of the genetic code, *Bio Systems* 22 (1989), pp 189-196.
- [23] S.G. Stent, *The Coming of the Golden Age* (Freeman, New York, 1969).
- [24] M. Schonberger, *The I Ching and Genetic Code*. (ASI, New York, 1980).
- [25] M. Rakočević, Information-topological concept of the amino acid code, *Zbornik radova (Compendium) of the Faculty of Science Niš* 1 (1990), pp. 3-23.
- [26] V.I. Shcherbak, Sixty-four triplets and twenty canonical amino acids of the genetic code: The arithmetical regularities. Part II, *J. Theor. Biol.* 166 (1994), pp. 475-477.
- [27] J. Blofeld, *I Ching – the book of change* (E.P. Dutton & Co., New York, 1963).
- [28] D.L. Koruga, Microtubular screw symmetry: Packing of spheres a latent bioinformation code, *Ann. NY Acad. Sci.* 466 (1986), pp. 953- 955.
- [29] M. Schroeder, *Fractals, Chaos, Power Laws* (W.H. Freeman and Comp., New York, 1991).
- [30] F. Saussure de, *Cours de linguistique generale* (Payot, Paris, 1985).
- [31] Lj. Mihajlović, *English in 100 Lessons* (Prosveta, Belgrade, 1972), in Serbian.

- [32] S.K. Langer, *An Introduction to Symbolic Logic* (Dover, New York, 1953).
- [33] E.J. Squires, Quantum theory and the relation between the conscious mind and the physical world, *Synthese* 97 (1993), pp. 109-123.
- [34] D.L. Koruga, Neurocomputing and consciousness, *Neural Networks World* 1 (1991), pp. 32-38.
- [35] D.L. Koruga, Information physics: In search of scientific basis of consciousness, in Hameroff, Kaszniak, Scott, eds., *Toward a Scientific Basis for Consciousness* (MIT Press, Cambridge, 1995).
- [36] M.M. Rakočević, The universal consciousness and the universal code, in D. Raković and Dj. Koruga, eds., *Consciousness: Scientific challenge of the 21st century* (ECPD, Belgrade 1995), pp.262-280.
- [37] M.M. Rakočević, One aspect of the universality of consciousness, in Lj. Rakić, D. Raković, Dj. Koruga, and A. Marjanović, eds., *Consciousness: Scientific challenge of the 21st century*, Proc. ECPD Seminar, September 1996, Belgrade, pp.184-188, in Serbian.

## TOWARDS A NEW/OLD HUMANISM: TRANSITIONAL STATES OF CONSCIOUSNESS AS A CLUE?

Dejan Raković

Faculty of Electrical Engineering, Belgrade University, P.O.Box 35-54, 11120 Belgrade, Yugoslavia,  
E-mail: rakovic@buef31.etf.bg.ac.yu

&

European Centre for Peace and Development (ECPD) of the United Nations University for Peace,  
Terazije 41, 11000 Belgrade, Yugoslavia

**Abstract.** It is pointed out (in the framework of the author's biophysical relativistic model of altered states of consciousness) that *transitional states of consciousness* represent an excellent framework for understanding and mental control of transpersonal *mystical states of consciousness* described in various religious and esoteric traditions of East and West during the history of civilization, implying their real biophysical nature. Transitional character of these states also demonstrates why these phenomena are *short-lasting* and poorly reproducible, and also why they are most easily mentally controlled shortly before a waking/sleeping transitional state. This might be also an explanation for extraordinary efficiency of prayer accomplished shortly before sleeping, which is recommended by all religious traditions, and its significance in *mutual reprogramming of psychic conflicts* (as a germ of the future interpersonal fights, as well as of potential psychosomatic and psychological disorders of the persons in conflict) during transpersonal interactions of the persons in conflict in transitional states of the praying person (with direct mental addressing to the person conflicted with, or *energetically more efficient* indirect mental addressing via ionically abundant disembodied archetype structures from religious traditions). All this suggests that deeper biophysical understanding of the nature of consciousness and transpersonal phenomena might soon give rise to scientific understanding and empirical verification of even fundamental philosophical/religious questions (like practical/spiritual significance of *imperative moral behavior* of every individual, extremely important for accelerated integration and spiritual evolution of personality) - and appearance of a *new humanism*, without meaningless and painful interpersonal, interethnic, and interreligious conflicts.

**Key words:** *theoretical mechanisms, biophysics, relativistic & quantum physics, brainwaves, neural networks, ionic structures, mystical states of consciousness, transitional states of consciousness, altered states of consciousness, acupuncture system, healing, religion/esoteric transpersonal conflict reprogramming, prayer, morals.*

### 1 Introduction

It is currently estimated that the problem of consciousness belongs to ten most significant scientific problems, owing to its potential scientific

implications, including a possibility for deeper understanding of some ultimate philosophical/religious questions, traditionally remaining outside the domain of theoretical and experimental methods of natural sciences, being therefore a subject of deep and painful irrational divisions throughout the whole history of human civilization.

The prevailing scientific paradigm considers information processing inside the central nervous system as occurring through hierarchically organized and interconnected neural networks. Along with development of experimental techniques enabling physiological investigation of interactions of hierarchically interconnected neighboring levels of biological neural networks, significant contribution in establishing the neural network paradigm was given by theoretical breakthroughs in this field during the past decade [1]. Apart from the brain's hierarchy of neural networks, a significant role in global distribution and memorizing (over the whole cortex) of hierarchically processed information is played by brainwaves [2]. Of particular interest in this process is also extended reticular-thalamic activating system (ERTAS) [3], as a hierarchical system of neural networks which compares currently processed information with the one memorized in the cortex, giving priority and amplifying one piece of information to the conscious level; the remaining pieces of information rest nonamplified at unconscious levels. This is basically also the mechanism of "emotional coloring" of some information.

A particularly significant role of brainwaves involves modeling states of consciousness - and especially altered states of consciousness, characterized by extraordinary acceleration in psychological information processing, which cannot be explained by purely electrochemical intersynaptic processes in biological neural networks, because these mechanisms of the ERTAS are not accelerated up to several orders of magnitude, as the subjective time sense is dilated in altered states of consciousness [4-6] - in respect to the normal awake state.

According to the author's biophysical model for altered states of consciousness [7-9], the electromagnetic (EM) component of ultralow-frequency (ULF) "brainwaves", related to "subjective" reference frame of consciousness, enables perfect fitting with narrowed-down limits of conscious capacity in normal awake states and very extended limits in altered states of consciousness - due to the biophysical relativistic mechanism of dilated subjective time base. In this model, *consciousness* is subtle internal display in the form of EM component of ULF brainwave ionic currents, in which a complete information (both conscious and unconscious) is permanently coded from brain's neural networks, as a spatio-temporal pattern resulting from changes of the electrosynaptic interconnections in the neural networks of the brain. Then, according to this model, *altered states of consciousness* (REM sleep, meditation, hypnosis, psychedelic drug influence, some psychopathological states, and near-death experiences) are a consequence of partial displacement of the ionic acupuncture system outside the body (when the embedded EM component of ULF brainwaves is propagating through this weakly ionized structured gaseous medium of low-dielectric relative permittivity,  $\epsilon_r \approx 1$ ), while *normal states of consciousness* (alert state, non-REM sleep, ...) are achieved when there are no such displacements (when brainwaves are propagating only through the structured brain tissue of high-dielectric relative permittivity,  $\epsilon_r \gg 1$ )!

According to the model, *dreams* and dream-like hallucinogenic states are characteristics of altered states of consciousness ( $\epsilon_r \approx 1$ ), when the relativistic Doppler mapping of EM component of the "objective" ULF brainwaves power spectrum on the zero-degenerate frequency "subjective" spectrum - enables dream-like mixing of normally conscious and unconscious contents. This could be the biophysical mechanism of dreams, which particularly implies their psychological significance: in dreams one has continuous access and more efficient "subjective" integration of normally conscious and unconscious contents, giving rise to integration and growth of human personality (otherwise divided into conscious and unconscious associative "ego" states), which results in alleviation of emotional conflicts [7-10]! Then *meditation*, as a prolonged altered state of consciousness, enables more efficient "subjective" integration of human personality, but it is inevitably accompanied by a decay of ultradian rhythm, governing alterations of normal and altered states of consciousness (of periodicity  $\sim 1.5 - 2$  hours, in both waking and sleeping [11]). However, if a person bears strong internal psychic conflicts i.e. "ego states", the result of such a prolonged meditation will be integration of human personality around foregoing several "ego-states", with undesirable result of multiply divided (instead of well integrated) personality; competent teachers of meditation are fully

aware of these perils, and do not recommend its accelerated practice to psychically weak persons (for whom the main priority being a *reprogramming* of psychic conflicts, we shall consider further on in the context of controlled transpersonal interactions in transitional states of consciousness).

The displaced ionic structure in this model must have a form of weakly ionized gaseous "optical" neural network, for continually inflowing information from the brain's neural networks to be "subjectively" recognized. Hence, such ionic neural network behaves also as an optical *sensor*, which can perceive an environment panoramically, as reported by reanimated persons [6].

## 2 Transitional States of Consciousness: Biophysical Basis of Mystical States

Even most peculiar spatio-temporal *transpersonal interactions* are predicted in *transitional* (nonstationary) states of interchange of normal and altered states of consciousness, when brainwaves traverse from high-dielectric ( $\epsilon_r \gg 1$ ) to low-dielectric ( $\epsilon_r \approx 1$ ) state or vice versa - the relative velocity  $v = c_0 / \sqrt{\epsilon_r}$  of "subjective" reference frame being therefore subjected to abrupt change in short transitional period  $\tau \sim 0,1$  s, with "subjective frame" acceleration  $\sim c_0/\tau \sim 10^9$  m/s<sup>2</sup>.

A deeper understanding of physical mechanisms of these processes obviously sinks into the General theory of relativity, as physical processes in highly accelerated reference frame outside gravitational field and in that one inside strong gravitational field with equal (gravitational) acceleration - are identical (so-called *Principle of equivalence*, being one of the fundamentals of both Newton's and Einstein's theories of gravitation). Theoretical analyses show [12] that in enormously strong gravitational fields so-called wormholes (or Einstein-Rosen space-time bridges) are created, whose entrance and exit could be in very distant space-time points. As in transitional states of consciousness the "subjective" reference frame, related to EM field of brainwaves, is subjected to quick change of velocity, with equivalent acceleration comparable with that one in enormously strong gravitational field of wormholes, according to the Principle of equivalence one could expect, in such brief states, the creation of the Einstein-Rosen bridge and tunneling of "subjective observer", i.e. consciousness, in previously "mentally addressed" exit in space-time<sup>a</sup> - reminiscences on passing through some tunnel being really reported by many patients

<sup>a</sup> To support this, one can cite the technique adopted by "psychics" when they want to exert some distant influence: they always intensely visualize the person or place, as mental targets! On the other hand, this could be deeply connected with the role of consciousness in quantum theory of measurement, where consciousness with its act of observation affects the final collapse of the initial wave function into one of possible probabilistic eigenstates - which implies that the collapse could be related with generation of local Einstein-Rosen bridge in highly noninertial processes of interactions of microparticles with measuring apparatus [8,9], equivalent to strong gravitational effects of crucial importance for this process [13].

reanimated from clinical death [6]. It should be pointed out that apart from the EM field, the displaced part of ionic acupuncture system (in the form of ionic neural network, having the "optical" sensory function), must also be tunneled in such (acausal) interactions of consciousness with distant events in space-time!

Hence, a space-time destination where a deceased ionic structure is tunneled at the moment of death, depends on the post-mortem mentally loaded addressing of the dying person. Therefore, it is quite reasonable that persons from different traditions, reanimated from clinical death, are reporting on bizarre spiritual contacts with the "light beings" identified as founders of their religious traditions (being mentally addressed as a target of prayer prior the near-death experience), or with a series of pleasant or unpleasant spiritual entities (contacts with them being induced by positively or negatively mentally loaded contents, successively activated in the deceased ionic structures), or with their close relatives (being a target of personal concern of the deceased) [6].

All these near-death experiences might be categorized into so called *astral projections* of consciousness, being described by rare practitioners as not subjected to spatio-temporal limitations [14,15] - quite in agreement with the transitional states of consciousness predicted by the model.

These astral projections are presumably also the basis of most *psychic phenomena* [16], providing also explanation for transitional nature and difficult reproducibility of these phenomena: they last only  $\sim 0,1$  s, and spontaneous conditions for them are achieved only every 1.5 - 2 hours, with periodicity of ultradian rhythms which govern the interchange of normal and altered states of consciousness [11]. However, it should be noted that the non-low-dielectric barriers in interaction with the low-dielectric barriers are helping in overcoming themselves in these astral projections - quite opposite to normal experience in usual mechanical interactions [14]!

The predicted transitional states of consciousness could also be the biophysical basis of *anticipation*<sup>b</sup> in

<sup>b</sup> According to the computer experiments with random number generators [17], only nonactualized possible futures can be anticipated (more accurately for a priori greater probabilities of their realization), in accordance with quantummechanical viewpoint. It should be added that physical interaction of the displaced gaseous ionic "optical" neural network with possible "objective" system (described by possible wave function  $\Psi_i$ ) or corresponding possible state of "collective consciousness" ( $\Phi_i$ ), in "astral projections" during transitional states of consciousness - opens also a question on the nature of wave functions - which should provide a picture of quantum-level physical reality (not only serving as a calculational device, useful merely for calculating probabilities, or as an expression of the experimenter's "state of knowledge" concerning physical system)! Then by changing initial state of "collective consciousness" ( $\Phi$ ) one can influence probabilities ( $|a_i|^2$ ) of realization of corresponding states  $\Phi_i$ , i.e. possible objective states  $\Psi_i$  (as the composite initial state of "objective" system and "collective" observer is a superposition of all possible composite states,  $\Psi\Phi = \sum_i a_i \Psi_i \Phi_i$ ). As the very state of "collective consciousness" ( $\Phi$ ) is a composite state constituted of (noninteracting) states of all "individual consciousness" ( $\phi_k$ ),  $\Phi \sim \prod_i \phi_k$ , it follows that the change of state  $\phi_k$  of "individual consciousness" can affect the state  $\Phi$  of "collective consciousness", and therefore the probabilities for realization of possible objective states  $\Psi_i$ . This is particularly true if the state  $\Phi$  is very sensitive on small changes of initial conditions, which is the case for physical systems described by deterministic chaos [18]. Having in mind that the brain and corresponding state  $\phi_k$  of "individual consciousness" is such kind of system, then the composite state  $\Phi$  of "collective consciousness" is also described by deterministic chaos - and therefore very sensitive on small changes in initial conditions! Such a conclusion

intuition, precognition and deep creative insights - which could be easily put under control by "mental addressing" on the problem chosen, shortly before a waking-sleep transitional state! On awaking, the brain would then amplify the dream concerning the solution of the problem addressed, giving to it the priority in respect to other processed information during the sleep phase. The information obtained in this way is usually mixed through associative coupling with other conscious and unconscious pieces of information during the following REM-sleep periods - having therefore some symbolic form, which has to be decoded through introspective analysis of the dream. Naturally, to solve some scientific, technical or artistic problem in this way, it is necessary for the person to be expert in the field, in order to articulate the solution obtained in corresponding scientific, technical or artistic "language".

The above mentioned astral projections of consciousness are presumably also the basis of *religious* experiences, with mental addressing on spatio-temporally displaced energetically abundant ionic disembodied archetype structures from religious traditions, being mentally addressed as a target of prayer in transitional states of consciousness. So, it seems that efficiency of *prayer* in self-healing of inner psychological conflicts (caused by some previous interpersonal fights) might be the consequence of similar biophysical transpersonal interactions of the persons in conflict in transitional states of the praying person, accompanied by *mutual*<sup>c</sup> reprogramming of interior conflicts (as a germ of the future interpersonal fights, as well as of potential psychosomatic and psychological disorders). That might provide an explanation for extraordinary efficiency of prayer accomplished shortly before sleeping which is recommended by all religious traditions (with direct mental addressing to the person in conflict, or energetically more efficient<sup>d</sup> indirect mental

implies extraordinary practical significance of contents of our "individual consciousness", as they directly determine the probability of realization of possible objective states  $\Psi_i$ , i.e. the future events, no matter how bizarre this conclusion looks like [8,9]! In that context, what is actually anticipated in transitional states of "individual consciousness" might be [8,9] the evolved state of "collective consciousness"  $\Phi(t)$  in some future moment  $t$  (to which "individual consciousness" has access, being the constitutional part of "collective consciousness"), which is quantummechanically described by deterministic unitary evolution governed by Schrodinger equation (or Dirac equation in relativistic case). However, the anticipated state  $\Phi(t)$  could be redefined by changing initial state  $\phi_i$  of "individual consciousness", leaving room for free will and the possibility for influence on the future. In this respect, it is quite possible that strong preferences in individual or collective futures exist, governed by karmical interpersonal loads, as it is claimed in Eastern tradition. Along the same line, it might also be possible that spiritual cleansing (by prayer or some other esoteric technic) is the efficient mechanism for changing initial state of several interrelated "individual consciousnesses", and hence "collective consciousness", thus changing anticipated preferences for both individual and collective futures [15,19].

<sup>c</sup> That could be possibly the reason for Christianity to insist on repenting and forgiving ("And forgive us our debts, as we forgive our debtors", Mt.6,12), which represents a level of spiritual maturity of a person: this implies an obligation of spiritually mature persons to help in reprogramming conflicts by praying, even when themselves being victims of the conflicts ("But I say unto you, love your enemies, bless them that curse you, do good to them that hate you, and pray for them which despitefully use you, and persecute you", Mt.5,44). It is not even allowed to see evil in fellow-men and condemn them (an old biblical commandment given to the man in paradise, forbidding to take food "of the tree of the knowledge of good and evil" - in fellow-men - "for in the day that you eat thereof you shall die" (Gen.2,17), whose violation has caused the Adam's fall), insisting only on personal repenting and forgiving, as the only way in reprogramming psychic conflicts; anything else enhances the existing mental/emotional personal loads and enlarges evil in the world, dismissing an individual and humankind from the final spiritual ideal of sinless state of consciousness.

<sup>d</sup> The displaced (outside the body) part of the ionic acupuncture system of the estimated initial ionic concentration  $n_j \sim 10^{15} \text{ cm}^{-3}$  (supporting the ULF brainwave ionic currents  $\sim 10^{-7} \text{ A}$ ) has a significant tendency of deterioration during a period of  $\sim 1$  hour



addressing via ionically abundant disembodied archetype structures), when it is easiest to control the addressed mental contents prior the waking/sleeping transitional state!

### 3 Conclusion: At the Threshold of New/Old Humanism?

It is hereby demonstrated that the author's model of altered and (particularly!) transitional states of consciousness is an excellent biophysical framework for various states of consciousness described in religious and esoteric traditions of East and West, implying their real biophysical nature - and significance for understanding mechanisms of transpersonal mystical and other transitional states of consciousness.

Transitional character of mystical states also demonstrates why these phenomena are short-lasting and poorly reproducible, and also why they are most easily mentally controlled shortly before a waking/sleeping transitional state. This might be also explanation for extraordinary efficiency of prayer accomplished shortly before sleeping, which is recommended by all religious traditions, and its significance in *mutual reprogramming of psychic conflicts* (as a germ of the future interpersonal fights, as well as of potential psychosomatic and psychological disorders of the persons in conflict) during transpersonal interactions of the persons in conflict in transitional states of the praying person (with direct mental addressing on the person

conflicted with, or *energetically more efficient* indirect mental addressing via ionically abundant disembodied archetype structures from religious traditions).

All this suggests that a deeper biophysical understanding of the nature of consciousness and transpersonal phenomena might soon give rise to scientific understanding and empirical verification of even fundamental philosophico/religious questions (like practical/spiritual significance of *imperative moral behavior* of every individual, extremely important for accelerated integration and spiritual evolution of personality) - and appearance of a *new/old humanism*, without meaningless and painful interpersonal, interethnic, and interreligious conflicts.

*Acknowledgments.:* This paper is devoted to my late brother George Janjić, with permanent gratitude for crucial intellectual and spiritual impulses in early youth. I am also deeply indebted to my colleagues and friends G. Stanojević-Vitaliano, P. Vujićin, M. Golubović, M. Trajković, D. Đaković, Đ. Kozic, Đ. Koruga, A. Škokljević, D. Đorđević, and Z. Jovanović-Ignjatić, for pointing at significant references on this broad subject.

### References

- [1] R.Hecht-Nielsen, *Neurocomputing* (Addison-Wesley, New York, NY, 1990).
- [2] E.R.John, Switchboard versus statistical theories of learning and memory, *Science* 177 (1972), pp. 850-864; E.R.John, T.Yang, A.B.Brill, R.Young, and K.Ono, Double-labeled metabolic maps of memory, *Science* 233 (1986), pp. 1167-1175; R.Eckhorn, R.Bauer, W.Jordan, M.Brosch, W.Kruse, M.Munk, and H.J.Reitboeck, Coherent oscillations: A mechanism of feature linking in the visual cortex?, *Biol. Cybern.* 60 (1988), pp. 121-130; C.M.Gray, P.Konig, A.K.Engel, and W.Singer, Oscillatory responses in visual cortex exhibit inter-columnar synchronization which reflects global stimulus properties, *Nature* 338 (1989), pp. 334-337; F.Crick and C.Koch, Towards a neurobiological theory of consciousness, *Seminars in the Neurosciences* 2 (1990), pp. 263-275; F.Crick, *The Astonishing Hypothesis. The Scientific Search for Soul* (Charles Scribner's Sons, New York, and Maxwell Macmillan International, 1994).
- [3] K.R.Poper and J.C.Eccles, *The Self and Its Brain* (Springer, Berlin, 1977), Chs. E2,8; B.J.Baars, *A Cognitive Theory of Consciousness* (Cambridge Univ. Press, Cambridge, MA, 1988).
- [4] In C.Tart, ed., *Altered States of Consciousness* (Academic, New York, 1972).
- [5] K.Jaspers, *Algemeine Psychopathologie* (Springer, Berlin, 1953).
- [6] R.A.Moody, jr., *Life after Life* (Bantam, New York, 1975); W.Evans Wentz, *The Tibetan Book of the Dead* (Oxford Univ., London, 1968); Fr. Seraphim Rouz, *The Soul After Death* (St.

---

[7,8], as the partial ionic pressure at room temperature is much more greater than magnetic pressure which pinches the ionic channel; however, the stability condition of disembodied ionic structures could be met under equilibrium of the two pressures, when  $n_j \sim 10^{24} \text{ cm}^{-3}$  [8]. It is obvious that this concentration exceeds by  $\sim 10^9$  times that one in the displaced deteriorating ionic structure, and that greater would be the current flowing through the ionic channels ( $I_0 \sim 100 \text{ A}$ ). That concentration is also  $\sim 10^4$  times greater than bodily ionic concentration, which is obviously nonadapted and risky for direct contact with biological species, but not with those biological ionic structures displaced in transitional states of consciousness far beyond the body - which might be subjected to appropriate corrections of their (disordered) ionic distributions and concentration, causing after transitional state of consciousness (and returning of these structures inside the body) the positive backward effect on acupuncture ionic system of the individuals, and hence on their psychosomatic healing [8]. So, it seems that the healing process can be related with the transfer of ions (qi, prana, pneuma, ether ...) and/or transfer of the EM information patterns, responsible for normal functioning of acupuncture system and overall health. In that context, it seems that other esoteric notions [15,20] such as subtle body (manomaya, lingasarira, manovijnana, ka, psyche, astral body, psychic body ...) and mental body (vijñanamaya, sukshmasarira, manas, ba, thymos, mind, noetic body ...) are biophysically inevitably associated with a partly displaced (from the body) ionic acupuncture system, and an EM component of ULF ionic currents embedded within it, respectively; on that line, the ionic condensations in the structured acupuncture system, with an EM component of ULF ionic currents embedded within it, behave like "distributed centers of consciousness" - this presumably being biophysical basis of yogic chakras [7,8]. It should be also added that ionic acupuncture currents, and accompanied EM fields, have both ultralowfrequency (ULF) and microwave (MW) components, i.e. the MW component is modulated by the ULF component: in support to the ULF nature of ionic currents in acupuncture channels, one can cite the resonance ULF ( $\sim 4 \text{ Hz}$ ) stimulation of the acupuncture analgesia endorfin mechanism [21]; on the other hand, the evidence for the MW component of ionic acupuncture currents is provided by resonance MW ( $\sim 50\text{-}80 \text{ GHz}$ ) therapy, efficient even in very serious diseases [22]. According to former Soviet inventors of the resonance MW therapy, Sit'ko and his collaborators, acupuncture system is a dynamic structure, differentiated at the locations of maximums of three-dimensional standing waves, formed as a result of the reflection of coherent microwave ( $\sim 100 \text{ GHz}$  [23]) Fröhlich excitations of molecular subunits in the cell membranes and proteins - supported also by other investigations which have demonstrated that differentiation of the intercell "gap junctions" (of higher density at acupuncture points and meridians) is slightly sensitive to voltage [24]. In that context the explanation for efficiency of this method should be sought: some disorders in the organism give rise to deformation in the structure of electrical field of the organism in MW region, which influences some changes in spatial structure of the acupuncture system, and consequently its resonance frequency, resulting in some disease; during the therapy, applying the MW sound at corresponding acupuncture point the excited acupuncture system of the patient is relaxing to the previous healthy condition, while reaching its normal frequency response upon the wide spectrum MW source - and following to physiological mechanisms of the acupuncture regulation [25] organism biochemically overcomes the disease.

- Herman of Alaska Brotherhood, Platina, CA, 1980).
- [7] D.Raković, Neural networks, brainwaves, and ionic structures: Acupuncture vs. altered states of consciousness, *Acup. & Electro-Therap. Res., Int. J.* 16 (1991), pp. 88-99.
- [8] D.Raković, Brainwaves, neural networks, and ionic structures: Biophysical model for altered states of consciousness, in D.Raković and Đ.Koruga, eds., *Consciousness: Scientific Challenge of the 21st Century* (ECPD, Belgrade, 1995), pp. 291-316; D.Raković, *Fundamentals of Biophysics* (Grosknjiga, Belgrade, 1994,1995), Chs. 5,6, in Serbian.
- [9] D.Raković, Prospects for conscious brain-like computers: Biophysical arguments, *Informatica* 21 (1997), No.3: *Special Issue on Consciousness as Informational Phenomenalism*, in press; D.Raković, Consciousness and quantum collapse: Biophysics versus relativity, *The Noetic J.* 1 (1997), No.1, in press.
- [10] D.Raković, Neural networks versus brainwaves: A model for dream-like states of consciousness, *Proc. 14<sup>th</sup> Ann. Int. Conf. IEEE/EMBS* (1992), pp. 2651-2652.
- [11] R.Broughton, Human consciousness and sleep/waking rhythms, in B.B.Wolman and M.Ullman, eds., *Handbook of States of Consciousness* (Van Nostrand Reinhold, New York, 1986).
- [12] K.S.Thorne, *Black Holes and Time Warps: Einstein's Outrageous Legacy* (Picador, London, 1994), Ch. 14, and references therein.
- [13] R.Penrose, *Shadows of the Mind, A Search for the Missing Science of Consciousness* (Oxford Univ. Press, Oxford, 1994), Part II, and references therein.
- [14] R.Monroe, *Journeys Out of the Body* (Doubleday & Co., Garden City, NY, 1971).
- [15] K.C.Markides, *Fire in the Heart. Healers, Sages and Mystics* (Paragon House, New York, 1990).
- [16] R.G.Jahn, The persistent paradox of psychic phenomena: An engineering perspective, *Proc. IEEE* 70 (1982), pp. 136-170.
- [17] D.I.Radin, Effects of a priori probability on PSI perception: Does precognition predict actual or probable futures, *J. Parapsych.* 52 (1988), pp. 187-212.
- [18] A.Babloyantz, Chaotic dynamics in brain activity, in E.Basar, ed., *Dynamics of Sensory and Cognitive Processing by the Brain* (Springer, Berlin, 1988), pp. 196-202.
- [19] Swami Rama, *Living with the Himalayan Masters* (Himalayan Int. Inst. of Yoga Sci. & Phil., Honesdale, PA, 1978).
- [20] K.Wilber, *The Atman Project* (Quest, Wheaton (IL), 1980); P.Vujićin, States of consciousness in esoteric practice, in D.Raković and Đ.Koruga, eds., *Consciousness: Scientific Challenge of the 21st Century* (ECPD, Belgrade, 1995), pp. 87-134, and references therein.
- [21] B.Pomeranz, Acupuncture research related to pain, drug addiction and nerve regeneration, in B.Pomeranz and G.Stux, eds., *Scientific Bases of Acupuncture* (Springer, Berlin, 1989), pp. 35-52.
- [22] S.P.Sit'ko, Ye.A. Andreyev, and I.S. Dobronravova, The whole as a result of self-organization, *J. Biol. Physics* 16 (1988) 71-73; S.P. Sit'ko and V.V. Gizhko, Towards a quantum physics of the living state, *J. Biol. Physics* 18 (1991) 1-10; see also S.P. Sit'ko, Quantum physics of the alive: medical aspects, this *Proc. ECPD Workshop*, 1997, and references therein.
- [23] H. Fröhlich, Long-range coherence and energy storage in biological systems, *Int. J. Quantum Chem.* 2 (1968), pp. 641-649.
- [24] E.R.Kandel, J.H.Schwartz, and T.M.Jessell, eds., *Principles of Neural Science* (Elsevier, New York, 1991), Ch.9.
- [25] Y.Omura, *Acupuncture Medicine* (Japan Publ. Inc., Tokyo, 1982).

## EPILEPTIC DISTURBANCES OF CONSCIOUSNESS – AN ARGUMENT FOR CONTEMPLATION

Ivan Ribaric

Institute for Neurosurgery, Clinical Center of Serbia, Belgrade, Yugoslavia

**Abstract.** The term consciousness (Cs) is used in the sense of the highest level of brain functions that form an experience of oneself, of environment, of the past, of the presence and of the potential future...It is not identical with the term "vigilance" (primitive Cs), which denotes the ability of an animal to be aware of and respond to the environmental changes...Some of the ictal manifestations of "affective psychic complex partial seizures" (related to the highest level of Cs) are suggestive of consciousness being the multitude of brain functions. The same are facts accepted in the contemporary psychology, psychiatry, neuroscience and cognitive science. It seems to us reasonable to reconcile the obvious functional integrity of consciousness with the scientific facts on its functional dividedness by the assumption that consciousness ("awareness" and "experience") constitute a multitude of mutually interacting and imbued brain functions.

The numerous efforts in exploring "neural correlate of consciousness" (NCC) failed to find neural correlate of self feeling, global control, imagination, abstraction, exploratory drive, creation. We tried to look for some answers in morphological and functional phylogenesis of nervous system. This "evolutionary approach" is suggestive that functioning of the highest level of consciousness depends on the functional integrity of many brain structures.

It seems to me that the answers to the question on the "neural correlate of consciousness" should be looked for at the cellular level. My impression is that the consciousness is result of the continuous intercellular recruiting flow of information with short-term "engrams" (this function is simultaneously "performance" and "dynamic state of matters"). Some of the neurons, pathways and structures are phylogenetically and ontogenetically settled to be more crucial for this process. For this continuous flow of information crucial would be continuous bodily-stimulation and body-state information (which provides a scaffolding for self-representation), and time and space registration.

On the bases of the data presented we can presume that the individual consciousness is, in a particular sense, limited by the level of phylogenetic development and the levels of the created world and of the common consciousness.

However, the human consciousness represents the imagination and creativity, whereby it makes penetration from the limitation. Therefore, creativity is the most important property of consciousness. The principal mechanism of development of human consciousness (including neural correlate of consciousness) is through development of the "created world" and its reversible influence on the human consciousness. (Creativity means that consciousness, instead of straightforward reactions to environmental and internal influences, represents capability to explore and penetrate into the unknown, driven by

existential and non-existential motives). The creativity is the end point of the pathway: exploration, penetration into the unknown, forming hypotheses, checking hypotheses, discovering mistakes, correcting and learning through experience. The ultimate truth does not exist, it depends on the level of knowledge. The creative function of human consciousness can penetrate environmental (and biological) limits (and contribute to the development of the created world), if the living circumstances do not interfere with individual creative drives. These circumstances are encountered in the open society with appropriate welfare, individual freedom, and developed communications.

**Key words:** *consciousness, vigilance, epileptic disturbances, neural correlate of consciousness, phylogenesis, ontogenesis, cellular level, limitation, penetration of limitation, created world, creativity, open society.*

### 1 The Term Consciousness

In this presentation we are referring to the term *consciousness* as the highest level of brain's functions that form an experience of oneself, of environment, of the past, of the presence and of the potential future, or let us paraphrase the definition of consciousness given by John Hughlings Jackson, 1923 [1,2]: one's capability to be simultaneously aware of the constellation of the circumstances in the environment and of the experience within oneself, so that one is able to integrate the whole perception in one moment intellectually, aesthetically and emotionally into the concept substantialized by oneself into the particular internal perception and within the boundaries of the previous experience.

Jackson believed that the interruption of consciousness during epileptic seizure is the consequence of functional disturbances of prefrontal cortex, the morphological substrate that is particularly developed in humans.

This "highest level of consciousness" Penfield and Jasper [3] localized in "centrencephalon", their expression for intralaminar thalamic system and reticular formation of brain stem which are diffusely and symmetrically interconnected with cortex of cerebral hemispheres. They inferred this opinion from the assumption that centrencephalon is the onset site of a generalized epileptic seizure accompanied with sudden interruption of consciousness.

However, we are not referring here to the "primitive" consciousness which Henry Head called

“vigilance” [4], which exists also in animals phylogenetically at the lower stage of development than human beings are, and it is manifested by animal’s awareness of and reaction to the environmental changes.

The distinction between those two ideas of consciousness can be illustrated by observing the disturbances of brain functions in humans induced by brain trauma: the lightest brain injury called “brain concussion” (*commotio cerebri*) is associated with confused state of consciousness (the patient is disoriented in time, space and towards persons, unable to memorize new events, and subsequently he is more or less amnesic for that period) which represents the disturbance of the highest level of consciousness. The grave brain injuries (brain contusion) may be associated with disturbances of vigilance (primitive consciousness) which are graded at various ways but still useful gradation is at *somnolentio*, *sopor* (stupor), *subcoma* and *coma* [5].

## 2 The Consciousness as the Multitude of Mutually Interacting and Imbued Brain Functions

It is helpful for our further presentation to direct attention to various epileptic disturbances of consciousness that are part of ictal manifestations of “affective psychic complex partial seizures” (AP-CPS) [6,7]. There are a few groups of symptoms that can be noticed (and related to the aforementioned definition of consciousness): psychosensory symptoms, affective symptoms, cognitive symptoms, dysmnesic symptoms, automatism, isolated confusional state.

*Psychosensory symptoms* include: hallucinations (i.e. perception in the absence of the appropriate stimulus) and illusions (i.e. disturbed perceptions of ongoing stimuli). Hallucinations and illusions can be visual, auditory, vertiginous, olfactory, gustatory, somatosensory, multimodal and experiential hallucination (“flashback”, i.e. recollection of a previous experience).

*Affective symptoms* include: the most common is fear; occasionally, depressive feelings or exhilaration, elation, pleasure, anger, inappropriate laughing or crying.

*Cognitive symptoms* include: “dreamy state”, i.e. the experience involves a disruption of time perception and of memory processes; “double consciousness”, i.e. the ictal state interferes with ongoing cognition; depersonalization, derealization.

*Dysmnesic symptoms* (distortions of memory) include: “*déjà vu*” feeling (already seen), “*jamais vu*” feeling (never seen, strange).

*Forced thinking*, i.e. undefined thought that imposes itself on the patient’s mind.

*Automatisms* (more or less coordinated involuntary motor activities, most often associated with impairment of consciousness): may be reactive, i.e. there is some interaction between the patient’s activity

and the outside world; or unreactive, i.e. without the aforementioned interaction.

*Isolated confusional state*, i.e. brief episode of confusion for which the patient is subsequently partially or entirely amnesic.

The ictal manifestations of AP-CPS (related to impairment of consciousness) are suggestive of existence of many constituent functions composing consciousness. It is well known that the ictal manifestations of epileptic fits are the consequence of the brain function disturbances due to sudden excessive events in the brain tissue some of which can be presented in the form of epileptic electrical discharges, metabolic changes, blood flow changes etc. (which can be demonstrated by EEG, PET, SPECT, MRS et c.) We can safely infer that the various ictal epileptic impairments of consciousness are result of the particular brain function disturbances, i.e. the consciousness is composed of many specific brain functions which are functioning, obviously, in an mutual harmony and integrity.

Functional dividedness of consciousness is well known in the contemporary psychology and psychiatry [8,9], neuroscience and cognitive science: *conceptual consciousness* with ideative and affective components; *unconscious* forces and motivations or processes, which under ordinary circumstances do not enter the conscious part of the personality (except under special conditions, such as psychoanalytic therapy or the psychoses); *preconscious* processes that are not conscious but possess the attribute of easy recall to consciousness; *biological intelligence*; *perception*; *memory*; *learning*; *planning*; *problem solving*; *abstract thinking*; *adaptation*; *complex of speech functions*; *visuo-constructive functions*; *arithmetical functions*; *the ability to discriminate, categorize and react to environment stimuli*; *the integration of information*; *the reportability of mental states*; *the ability to access its own internal states*; *the focus of attention*; *deliberate control of behavior*, et c.

Some scientists use term “*awareness*” for these functions and term “*consciousness*” reserve for the phenomena of *experience* (“*conscious experience*”, “*phenomenal consciousness*”, “*qualia*”) [10,11]. The essence of this new division of consciousness is that the phenomena of “*awareness*” belong to the “*easy*” problems of consciousness which seem directly susceptible to the standard methods of cognitive science, whereby a phenomenon is explained in terms of computational or neural mechanisms, and “*phenomenal consciousness*” belongs to the “*hard*” problems that seem to resist those methods. Also, there would be an explanatory gap between the functions and experience [12].

It seems to us reasonable to reconcile the obvious functional integrity of consciousness with the scientific facts on its functional dividedness by the assumption that consciousness (“*awareness*” and “*experience*”) constitute a multitude of mutually interacting and imbued brain functions.

### 3 The Question of Localization of Consciousness (“Neural Correlate of Consciousness” - NCC)

If we accept the consciousness as the (analytically dividable) brain function and have in mind that many functional systems with appropriate anatomical structures (cortical and sub-cortical areas working in concert through the action of fibre pathways) do exist in brain, we can put the question: in which structures of brain is the consciousness located? That is, how best to explain our subjective mental experience in terms of the behavior of large groups of nerve cells? What can knowledge on epileptic phenomena contribute to that subject?

It is indisputable that many facts on “functional topography” of brain we owe to the correlation of the ictal onsets of epileptic (electroencephalographic) discharges in cerebral cortex (and some of the limbic structures) with the first manifestations of habitual clinical epileptic fits, as well as to the observing clinical effects of electrical stimulation of brain cortex and limbic structures (during neuro-surgical procedures in alert patients). However, these methods of examination have plenty of pitfalls:

- at present, we know that there are at least six zones in brain related to the epileptic focus, which are not necessarily overlapped [13]: *irritative zone* (the zone of cortex that generates interictal EEG-epileptic abnormalities); *ictal onset zone* (the zone of cortex that generates the first ictal epileptic EEG abnormalities); *epileptogenic lesion* (structural abnormality in the brain or of the brain that is the direct cause of the epileptic seizure); *symptomatogenic zone* (the portion of brain that produces the initial ictal clinical symptomatology); *functional deficit zone* (the cortical area of nonepileptic dysfunction, detectable by neurological, neuro-psychological, SPECT, PET, EEG examinations); *epileptogenic zone* (area of cortex that is necessary and sufficient for initiating seizures and whose removal /or disconnection/ is necessary for complete abolition of seizures;

- brain electro-stimulation (and ictal epileptic discharge) may cause stimulation or inhibition of appropriate brain functions and apparent symptomatology is result of their combination;

- there is abundant of evidence verifying the postulation of Flechsig (1849-1929) [9] (based on myeloarchitectonics) that the neural bases of higher functions might lie in cortical-subcortical systems rather than being restricted largely or wholly to the cerebral cortex.

In spite of the aforementioned difficulties, on the basis of this methodology and many other clinical and experimental examinations, we know that there exists an inter-hemispheric functional difference and we can identify with great confidence cortical zones or limbic structures indispensable for the specific brain functions: auditory perception, audio-psychic functions, speech understanding, speech expression,

reading (visual speech), visual perception, visuo-psychic functions, gustatory and olfactory perception, recent memory, body awareness, space-time awareness, biological intelligence, emotional motivation, vigilance et c.

In this respect, Luria’s division of brain behind the central sulcus into three types of cortical zones is still useful [14]: the *primary zones* (primary projection areas), concerned with sensations, each particular area responds to highly differentiated properties of visual, auditory, or bodily sense information; the *secondary zones*, are the areas adjacent to the primary projection areas where the modality specific information becomes integrated into meaningful wholes (concerned with perception or gnosis); the *tertiary zones* serve to integrate information across sense modalities (they lie at the borders of the parietal (somato-sensory), temporal (auditory), and occipital (visual) secondary zones. The tertiary cortex is typified by a predominance of cells from the upper cortical layers and this type of cortex is seen only in man. These are the last portions of the brain to mature in ontogenic development, not reaching full development until around seven years of age.

In the last few years a long list of suggestions on “neural correlate of consciousness” (NCC) has been put forward. This phrase intended to refer to the neural system or systems primarily associated with conscious experience. Let us mention some of them: re-entrant loops in thalamocortical systems [15]; intralaminar nucleus in the thalamus [16]; nucleus reticularis [17]; anterior cingulate system [18]; backprojections to lower cortical areas [19]; neurons in extrastriate visual cortex projecting to prefrontal areas [20]; output of a comparator system in the hippocampus [21]; global workspace [22]; 40-hertz rhythmic activity in thalamocortical systems [23].

Although these scientific data enlighten many aspects of brain-function correlation relating to the highest level of consciousness, we are far from understanding what is the neural correlate of : conscious experience, self, perception, global control, imagination, abstraction, exploratory drive, planning, deciding, creation, etc.

Let us cast a glance at some facts of brain structural and functional evolution (*phylogenesis*) looking for some answers [24].

The highest level of consciousness is phylogenetically the youngest brain function. Therefore, it would be sensible to assume that phylogenetically youngest brain structures are responsible for its arising. However, phylogenetic brain development has been taking place simultaneously in “quantitative” and “qualitative” appearance. *Qualitative evolution* is term used (here) to indicate the emergence of qualitatively new functions in brain cells and structures which had been existent at the phylogenetically antecedent levels (at the same time, some of the functions existent in the same structures at the antecedent levels are

minimized). This is paralleled by the higher organization of neuronal cells and changes in their biochemical structure. *Quantitative evolution* of brain is manifested by the appearance of new structures and/or hypertrophy of some existing structures (at the same time, some of the old structures are minimized). We can infer that the emergence of the highest level of consciousness is the result of qualitative and quantitative phylogenetic brain changes at all structural levels, molecular, cellular and anatomical. Therefore, the phylogenetically youngest brain function, the “highest level of consciousness”, can not be localized exclusively in the phylogenetically youngest anatomical or histological structures. The obvious example are emotions, that are important motivational component of cognitive functions. (Modern conception of motivation include the pathway from motivating influences such as instinctive needs or selective attention, through plans, to action [25]). The principal brain structures responsible for emotions are structures of limbic system, that are phylogenetically old. There are abundant anatomical interconnections of limbic system with diencephalic and mesencephalic structures (phylogenetically old structures) on the one hand, and with prefrontal cortex (phylogenetically new structure) on the other hand. It is, also, comprehensible that undisturbed functioning of “primitive” consciousness (vigilance), (which is linked to cortico-reticular continuum - phylogenetically old structure) is mandatory for functioning of the highest level of consciousness.

This “evolutionary approach”, we can safely say is suggestive that functioning of the highest level of consciousness depends on the functional integrity of many brain structures.

It seems to me that the answers to the question on the “neural correlate of consciousness” should be looked for at the cellular level. My impression is that the consciousness is result of the continuous intercellular recruiting flow of information with short-term “engrams” (this function is simultaneously “performance” and “dynamic state of matters”). Some of the neurons, pathways and structures are phylogenetically and ontogenetically settled to be more crucial for this process. For this continuous flow of information crucial would be continuous bodily-stimulation and body-state information [26] (which provides a scaffolding for self-representation), and, I would say, time and space registration.

#### 4 The Consciousness Between Limitation and Penetration

The individual highest level of consciousness, which is a brain function, develops in humans by means of *ontogenic* brain development. It is well known that development of brain cells (for example synaptogenesis) is not genetically predetermined but is dependent on the influences of normal electrical fields

and appropriate environmental influences [27]. The dendritic sprouting and synaptogenesis are immensely impaired if the neurons are exposed to the ictal activity produced locally or at distance (instead of to the normal electrophysiological influences) [28]. Congruous with this are the following data: the observation on brain functional “*plasticity*”: complete functional brain recovery (with corresponding morphological changes) after a large brain damaging, for example after hemispherectomy in kittens [29]; *associative mechanisms* of neurons in the brain include phenomena such as activity-dependent presynaptic facilitation, which increases the efficiency of synaptic transmission, associative long-term potentiation, and the growth of new dendrites [30].

On the basis of these data we can presume that the internal and external influences are of paramount significance for the brain and consciousness development. Many pieces of information obtained from psychological and psychoanalytical work strongly support the indispensable significance of environmental influences for the individual psychic development, from the neonatal period afterwards [31].

One of the environmental factors, which has reversible influence on development of individual consciousness represents the “*created world*”, the term which designates the wholeness of materialistic and spiritual products of human consciousness (science, arts, tradition, historical memory, ethical and aesthetic values, technology, library, computers, etc.). (This term corresponds to the term “third world”, introduced by K.R.Popper [32]).

The human brain is formed as a result of phylogenetic and ontogenetic factors which determine the biological developmental level of this carrier of consciousness (the level of “biological intelligence”).

The humans are also the social beings (there is continuous mutual communication between human beings, starting with communication with mother or the substitution of mother in neonatal period). We can talk about *common consciousness* which is statistical average of individual consciousness.

On the basis of the aforementioned data we can presume that the individual consciousness is, in a particular sense, limited by the level of phylogenetic development and the levels of the created world and of the common consciousness. (It is difficult to imagine where are biological limits of human brain, particularly due to the fact that the rapid computerization could help in stretching these limits).

However, the human consciousness represents the imagination and creativity, whereby it makes *penetration from the limitation*.

The principal mechanism of development of human consciousness (including neural correlate of consciousness) is through development of the “created world” and its reversible influence on the human consciousness. Therefore, creativity is the most important property of consciousness. Creativity means

that consciousness, instead of straightforward reactions to environmental and internal influences, represents capability to explore and penetrate into the unknown, driven by existential and non-existential motives.

Creativity is the end point of the pathway: exploration, penetration into the unknown, forming hypotheses, checking hypotheses, discovering mistakes, correcting and learning on experience. The ultimate truth does not exist, it depends on the level of knowledge (There are innumerable known occasions in the history of science where an incorrect inference has been made on the basis of accurate observations through lack of sufficient information). Therefore, each dogma is incompatible with the nature of human consciousness. The creative function of human consciousness can penetrate environmental (and biological) limits (and contribute to the development of the created world), if the living circumstances do not interfere with individual creative drives. These circumstances are encountered in the open society with appropriate welfare, individual freedom, and developed communications.

## References

- [1] D. Williams, The Thalamus and epilepsy, *Brain* 88 (1965), pp. 539-556.
- [2] J.H. Jackson, *Selected Writings of John Hughlings Jackson*, J.Taylor, ed., (Basic Books, New York, 1958)
- [3] W. Penfield and H. Jasper, *Epilepsy and the Functional Anatomy of the Human Brain* (Little, Brown and Company, Boston, 1954)
- [4] H. Head, The conception of nervous and mental energy, *Brit. J. Psychol (Gen.Sect.)* 14 (1932), pp. 126-147.
- [5] N. Sekulovic and I. Ribaric, *Trauma of Central and Peripheral Nervous System*, (Medicinska knjiga, Beograd-Zagreb, 1985), in Serbian.
- [6] J. Aicardi, *Epilepsy in Children* (Raven Press, New York, 1986)
- [7] I. Ribaric, *Epilepsies - Diagnosis, Medicamentous and Surgical Treatment* (Zavod za udzbenike i nastavna sredstva, Beograd, 1996), in Serbian.
- [8] C.L. Kolb, *Modern Clinical Psychiatry* (Saunders Company, Philadelphia, London, Toronto, 1977)
- [9] W.K Walsh, *Neuropsychology. A Clinical Approach* (Churchil Livingstone, Edinburg, London, New York, 1978)
- [10] B. Newell, *Unified Theories of Cognition* (Harvard University Press, 1990)
- [11] D.J. Chalmers, *The Conscious Mind: In Search of a Fundamental Theory* (Oxford Univeristy Press, 1996)
- [12] J. Levine, Materialism and qualia: The explanatory gap, *Pacific Philosophical Quarterly* 64 (1983), pp. 354-361
- [13] O.H. Lüders, J.Jr. Engel, and C. Munari, *General Principles*, In: *Surgical Treatment of the Epilepsies*, Sec. ed. J.Engel, Jr, ed. (Raven Press, New York, 1993)
- [14] A.R. Luria, *The Working Brain* (The Penguin Press, London, 1973)
- [15] G.M. Edelman, *The Remembered Present: A Biological Theory of Consciousness* (Basic Books, New York, 1989)
- [16] J.E. Bogen, On the neurophysiology of consciousness, part I and II., *Consciousness and Cognition* 4 (1995), pp. 52-62;137-158.
- [17] J.G. Taylor and F.N. Alavi, *Mathematical analysis of a competitive network for attention*, In: *Mathematical Approaches to Neural Network*, G.J. Taylor, ed., (Elsevier, Amsterdam 1993)
- [18] R. Cotteril, On the unity of conscious experience, *Journal of Consciousness Studies* 2 (1994), pp. 290-311
- [19] L.J. Cauller and A.T. Kulics, The neural basis of the behaviorally relevant N1 component of the somatosensory evoked potential in awake monkeys: Evidence that backward cortical projections signal conscious touch sensation, *Experimental Brain Research* 84 (1991), pp. 607-619
- [20] F.Crick and C. Koch, Are we aware of neural activity in primary visual cortex?, *Nature* 375 (1995), pp. 121-123
- [21] J.A. Gray, The contents of consciousness: A neuropsychological conjecture, *Behavioral and Brain Sciences* 18 (1995), pp. 659-722
- [22] B.J. Baars, *A Cognitive Theory of Consciousness* (Cambridge University Press, Boston 1988.)
- [23] R.R. Llinas, U. Ribary, M. Joliot, and X.J. Wang, *Content and context in temporal thalamocortical binding*. In: *Temporal Coding in the Brain* G. Burzsaki, R.R. Llinas, and E. Singer, (Springer Verlag, Berlin, 1994)
- [24] I. Ribaric, *Epilepsy and Its Surgical Treatment* (Medicinska knjiga, Beograd-Zagreb), in Serbian.
- [25] H. Heckhausen, *Motivation and Action* (Springer Verlag, Berlin, 1991)
- [26] A.R. Damasio, *Descartes' Error* (Putnam, New York, 1994)
- [27] P. Kellaway, *Afferent nput: A Critical Factor in the Ontogenesis of Brain Electrical Activity*. In: *Behavior and brain Electrical Activity*, N. Burch, H.L. Altshuler, eds., (Plenum press, New York, 1975)
- [28] R.C. Collins, J.W. Olneg, and E.W. Lothman, *Metabolic and Pathological Consequence of Focal Seizures*. In: *Epilepsy*, A.A. Ward, J.K.

- Penry, and D.P. Purpura, eds., (Raven Press, New York, 1983)
- [29] J.R. Villablanca, J.W. Burges, and C.E. Olmstead, Recovery of function after neonatal or adult hemispherectomy in cats, I: Time course, movement, posture and sensorimotor tests, *Behav. Brain Res.* 19 (1986), pp. 205-226.
- [30] E.R. Kandel, J.H. Schwartz, and T.M. Jessel, *Essentials of Neural Science and Behavior* (Appleton and Lange, Norwalk, CT, 1995)
- [31] D. Winnicott, *Playing and Reality* (Penguin, London, 1974)
- [32] R.K. Popper and C.J. Eccles, *The Self and Its Brain* (Springer Berlin, 1978)



## AN ESSAY ON TRANSCENDENTAL MEDITATION: FROM PERSONAL TO SOCIAL OBSERVATIONS

Jara Ribnikar<sup>a</sup>

Generala Ždanova 32, Belgrade, Yugoslavia

It is a great honor for me to be here amongst the learned and respected participants at this symposium. When Professor Dejan Raković invited me I wondered if it were my place to be amongst scholars who would bring the results of their long research into human consciousness, their conclusions based on work in laboratories, on statistics and the synthesis of lengthy deliberation. I gratefully accepted the invitation to participate at this conference for one reason only. I want to present to you my personal experience of the method of Transcendental Meditation because I have become convinced that the discoveries made available through the practice of the Maharishi's Transcendental Meditation are of great benefit to each individual, and of great benefit to the whole world. My resolve to present here my personal experience has been reinforced by what has been asserted by the highest authorities in contemporary science and by the many testimonies of artists.

How did it begin? What happened to me?

I was at a literary evening and talking to one of the directors of the company, which had taken upon itself the responsibility for my visit. I asked him, "How do you manage to get everything done? And all so easily, without being nervous, no rush. You have a meeting with the management group, then lunch with some guests, you're seen everywhere, everything is wonderfully organised, you're not tired, are you? You're not at all tired." He looked at me calmly, some kind of new human tranquillity reached out to me from him, and he said, "Are you really interested?"

I said, "Yes, really."

"Then I'll tell you. I practice Transcendental Meditation."

"What's that," I asked.

"You meditate twice a day for twenty minutes."

"And that's all?"

"Yes, that's all."

"I would like that too, tell me, how do you achieve that sense of relaxation, that ease, that serenity at work?"

And so it began. The gentleman put me in touch with the Belgrade organization for Transcendental Meditation and then it began.

I had just got through the first steps in meditation from a professionally trained teacher when the police

broke into the organization's somewhat modest rooms, took the membership list with about ninety names and prohibited our activity. I lost touch with those people. I continued to practice meditation on my own on an irregular basis, but in a completely amateur way. Nevertheless, such as it was, that separation from day-to-day tribulations kept me going during the period of that arduous war of recent years, which came against all historical logic, and helped me to get on with my own work. In the meantime, mother history turned new searchlights in our direction and the organization for Transcendental Meditation began to recover. At the end of December 1996, an old acquaintance, remembering our association, invited me to a meeting of meditators in Obrenovac. Then my life took a new turn. I felt the influence of others who were meditating beside me for the first time in my life. I was sitting in a hotel conference hall together with about ninety other people and I sensed the powerful support of all those sweet young women and strong young men who were sending out waves through the whole room. A large proportion of the participants consisted of teachers of TM, siddhi, levitators, people who rise up from the floor, just as once, long ago, people would rise up from the floor, hover and fly. There are many written statements and stories about them. When my first collective meditation was over, I felt an indescribable contentment which those people who were until that day strangers to me had created. I had sensed something similar before. I used to say that people send out waves and that I can feel them. Submerged in the multiplicity of individual silences in that room, I felt a gentle certainty, as if I were hovering in a transparent jelly; I had to laugh at myself when I formulated it in those words. Then, the next thought came naturally: "If it affects me so much, how could it not affect those who are not meditating?" And really, all the hotel staff kept saying that they had never had such pleasant guests. In Obrenovac I established a continuous link with a teacher of Transcendental Meditation who instructed me even there in correct exercises for meditation and in the rhythm of exercises, and helped me to find out about the beginning and the current situation of the world TM movement. The first thing which I got from him was the book *The Maharishi Mahesh Yogi on the*

<sup>a</sup> The author is a renown Yugoslav writer, and the long-time TM practitioner (eds. note)

*Bhagavad-Gita*. That book has become an inexhaustible source of inspiration in my life.

After a short period of proper and regular meditation I stopped taking sleeping tablets and tranquilizers without which I could not live before. Also, in time, I reduced the medicine which I take for my heart by half I lost my old fear of lifts which had dogged me all my life, and was completely freed from that sense of unease which had followed my every entry into a room full of people. Friends and family noticed the change in my health and temperament.

Literature and all other arts are born and carried away by the desire to uncover the secrets of human consciousness. While practicing Transcendental Meditation I have become increasingly aware of the deficiency of verbal expression by which we are fettered. The question of the ineffable is ever more present. When studying the Maharishi's teaching on creative intelligence I could not help but notice the growth of my own perception, a new ability to register a series of simultaneous sensations which I had seen before only in children, a new freshness in my writing, and alongside all that a new liveliness of thought. This new spiritual activity, in fact the complete opposite to that deep silence into which I would fall or from which I would rise - it is difficult to describe where we are at that point in time - during meditation, especially after the course in creative intelligence which I regularly attended, was indeed something completely new to me. And it continues to surprise me ever more because it comes without any conscious effort, easily, as if my whole organism has been yearning for it I discovered in myself that the deep rest, a new state of consciousness, does not resemble either sleep or my musing, does not resemble sleep with dreams or sleep without dreaming; that sense of tranquillity can be described only as levitating in silence. On leaving that state you feel your whole body refreshed and your spirit awakened, such that they seek activity. A new dynamism is born. I felt a new strength.

The Maharishi describes the state of transcendental awareness in the following way:

"Human awareness can identify itself with this most basic, self referral value of consciousness in the state of Samadhi, or transcendental consciousness. This is easily gained and most naturally enjoyed through Transcendental Meditation. The functioning of transcendental pure consciousness is the functioning of natural law in its most settled state. The conscious human mind, identifying itself with this level of nature's functioning, gains the ability to perform in the style with which nature performs its activity at its most fundamental level. Completely identified in transcendental consciousness with the full potential of natural law, the human mind is a field of all possibilities."

Eugene Ionesco's written testimony can be an encouragement to us all. Without knowing about the state of transcendental awareness which practitioners

of TM experience, he expressed just such a state in these inspired words:

"Once, long ago, I was sometimes overcome by a sort of grace, a euphoria. It was as if, first of all, every notion, every reality was emptied of its content. After this emptiness. . . , it was as if found myself suddenly at the center of pure ineffable existence; it was as if things had freed themselves of all arbitrary labels, of a framework that didn't suit them, that limited them; social and logical constraint or the need to define them, to organize them, disappeared. It did not seem to me that I was the victim of a nominalist crisis; on the contrary, I think that *I became one with the one essential reality*, when, along with an immense, serene joy, I was overcome by what I might call the stupefaction of being, the certainty of being, . . .

I say that with words that can only disfigure, that cannot describe the light of this profound, total organic intuition which, surging up as it did *from my deepest self*, might well have inundated everything, covered everything, both *my other self* and others."

And the British essayist J. A. Symonds said the following on the experience of transcending:

"It consisted in a gradual but swiftly progressive obliteration of space, time, sensation, and the multitudinous factors of experience which seem to qualify what we are pleased to call our Self. In proportion as these conditions of ordinary consciousness were subtracted, the sense of an *underlying or essential consciousness* acquired intensity. At last nothing remained but a *pure, absolute, abstract Self*. The universe became without form and void of content. But Self persisted, formidable in its vivid keenness..."

I sensed here a great similarity between these two different personalities. Symonds differentiates the self of everyday experience from the "deep self", just as Ionesco differentiates his "deepest self" from his "other self". These great intellectuals are describing the purity and silence of the moment of transcending in meditation. Many sensitive people experience such states as a special form of inspiration.

The original Romantic idealism of Ralph Waldo Emerson is very interesting for us today. Intending to draw attention to man's inner being and to his intimate relationship with nature, he founded the "Transcendental Club" in 1836 in America. He maintained that nature nurtures man. "Self-reliance" is the essay in which his individualism manifests itself in association with the vital forces and moral laws of nature that Emerson calls the "Oversoul". Man accepts or rejects the forces of the "Oversoul" according to his own intuition and experience. "All that lies before us and all that lies behind us are tiny matter compared to what lies within us." "All we are is in the soul," are the words of the great Balzac. In a letter to a friend he put the question, "Are you certain that your soul has had its full development? Do you breathe in air

through every pore of it? Do your eyes see all they can see?" His obvious stress falls on the need to spread awareness and to deepen perception. In the famous novel *Louis Lambert* Balzac writes the following: "The limit which most brains attain was the point of departure from which he was one day to start in search of new regions of intelligence." Balzac's literary work has led many historians and critics to the proposition that he was a genius in possession of a higher state of consciousness which we would today call cosmic consciousness.

William James, the father of American psychology, called such unusual experiences which come on their own, spontaneously, not subject to our will, states of special "assurance". We pass into these states, he wrote:

"...from out of ordinary consciousness as from a less into a more, as from a smallness into a vastness, and at the same time as from an unrest to a rest. We feel them as reconciling, unifying states... In them the unlimited absorbs the limits and peacefully closes the account."

"The loss of all worry, the sense that all is ultimately well with one, the peace, the harmony," thus he describes those exceptional experiences, and also, here are those "states of insight into depths of truth unplumbed by the discursive intellect."

Abraham Maslow, working on James's propositions, took up the development of human potential and emphasized self actualized people who cultivate their full potential and function on the highest level of values and behaviour. Stressing their intuition Maslow pointed to moments of "revelation, of illumination, insight, understanding, ecstasy" which enable the subject and the world to create a single wholeness, to be integrated in a state evoking the feeling of happiness in mankind.

The practice of Transcendental Meditation leads us into the quiet center of our being where we find ourselves in close touch with the deep and deepest creative level of our consciousness. Meditation twice a day for twenty minutes, over days, weeks and months, and life is increasingly filled with peace, patience, joy, loyalty, tenderness and self control which emanates from the respect shown to yourself and to others. Transcendental Meditation has its roots in the wisdom of ancient philosophers. Therefore, I am not surprised to recognise in the Maharishi's teaching on the art of living the aims and goals of different world religions. Many priests are today recommending to their congregations to practice TM because it purifies everyone's soul, everyone's spirit of the sediment of life's blows and the unavoidable staining of life's dreams, just like a snow-plough on a road pushing the snow ahead and throwing it aside to make a clear path for people.

Following the Maharishi's course on the Science of Creative Intelligence I enriched my life with a new approach to fundamental problems, and the recognition of something which I have always carried

deep in myself. To my delight the Maharishi often mentions with obvious pleasure the word "play" and the word "dance". How my friend, the late poet Vasko Popa, would enjoy that. He was by his own intuition the Maharishi's spiritual brother except that he was unaware of it. The Maharishi speaks of the creative wisdom that plays shaping the magnificent diversity in the singularity of the Universe of which we are an indivisible part Vasko Popa, with his poetical talent, came to that too. In the Maharishi's formulation, just as if Vasko were talking, creative intelligence is happy in its quiet serenity and dances in the joy of freedom like waves which lull into the endless, deep ocean. Scholars from all over the world are examining now not only the improvement in man's mental and physical health and the blossoming of his capabilities as a result of practicing Transcendental Meditation, but also are conducting basic research on the effect of meditation on the environment. According to the estimates of some eminent university authorities there is a very high degree of reliable statistical and other evidence, which prove a reduction in the level of crime and social tensions, and the establishment of a more positive collective consciousness.

Professor Nikolai Lyubimov, chancellor of the Maharishi Vedic University in Moscow, has studied for a number of years with his colleagues at the Brain Research Institute of the Russian Academy of Medical Sciences the extension of life's potential under the influence of Transcendental Meditation. The main results of his research established a binary process: the development of deep relaxation accompanied by a lively wakefulness of the spirit. "Transcendental Meditation activates the hidden potential of the brain through a completely natural and spontaneous process," says Professor Lyubimov.

Professor John Hagelin conducts research on the collective practice of TM. His experimental observations of the extension of consciousness have become a part of his expertise as a physicist. In October 1990 in Belgrade he stated the fact, as he himself said, the most dramatic phenomenon for a physicist, of the influence which the collective practice of Transcendental Meditation exercises on society. On that occasion he emphasised large groups in meditation experience and stimulates a unified field of consciousness.

"If consciousness," said Professor Hagelin, "like everything else in the Universe possesses deeper, more universal levels - levels like the theory of fields - then one can expect that the phenomenon of EEG coherency will not be completely localized to the brain, but that it will give some components of that experience which will extend to the environment." The Maharishi Mahesh Yogi, physicist and researcher in the field of human awareness, put forward this same hypothesis in 1962, and today in 1997 scientists from all over the world are supplying evidence that the hypothesis has become an undeniable scientific fact.

I shall just give a few examples from the rich and multicolored mosaic of Transcendental Meditation around the world to serve as living illustrations of scientific research. At the Maharishi Vedic University in the town of Naberezhnyye Chelny in Russia there are now 600 students who have achieved the level of Siddhi - Yogic Flying. The city used to have the highest crime rate in the region, but from the moment when the students implemented the Siddhi-program the percentage fell dramatically. In Great Britain, in the district of Merseyside, a large coherence-creating group has been established to improve the quality of life. The district had the third highest crime rate in England and Wales, but the activity of the coherence-creating group decreased the rate to the lowest as reported in the journal *Psychology, Crime and Law*. One percent of the population in New Zealand has learnt the TM technique. As soon as that figure was achieved unemployment fell by 8%, inflation fell from 18% to 2%, crime and accidents were down and economic growth increased. General Tobias Dai represented Mozambique at the conference on national defense in Holland. Amongst other things he said:

“Scientific principles supporting the Maharishi Effect are found at the level of the Unified Field of Natural Law in the property of infinite correlation. The Maharishi Effect generates a more ordered and integrated state of national collective consciousness.

The effect generated in society by a group of people practicing Yogic Flying together everyday is like the effect of a drop of cold water on boiling milk - the milk stops boiling immediately (the

activity of the milk molecules is reduced). In the same way the practice of Yogic Flying has a ‘cooling’ influence in society and social disorder is reduced...

Most notable of these predictions in Mozambique were: the achievement of peace, the coming of rains before expected (they were only expected in July 1993), an unprecedented improvement in the economy, a decrease in the crime rate, and a decrease in the number of road accidents."

General Dai reported to the delegates that the TM and siddhi - Yogic Flying programs are being implemented in the police force, the army and other state institutions. Dr Katsuaki Ojama, the President of the Maharishi Research Institute in Japan, has noted, "The only means to achieve lasting peace in each nation is to transform hostility into friendship, into love. That is the art of utilising the living silence in man and animating those living silences in the collective consciousness of the nation."

Transcendental Meditation, based on the oldest traditions of human knowledge, the Vedic tradition of ancient India, represents today the expression of the most modern and ancient forms of human knowledge. The Vedic tradition describes the Unified field of all natural laws and offers us the TM technique. The application of the unified field of intelligence as the basis of the human mind, the unified field of science, as has been proven by physics for example, enables a holistic approach to different aspects of life and to the whole evolutionary process of mankind.

## EFFECT OF LOCUS COERULEUS STIMULATION ON ECoG POWER SPECTRA IN BRAIN DAMAGED RATS MODEL OF EPILEPSY

Jasna Šaponjić<sup>1</sup>, Milka Čulić<sup>1</sup>, Bogdan Janković<sup>2</sup>, and Milena Janković<sup>1</sup>

<sup>1</sup>Institute for Biological Research, University of Belgrade, Yugoslavia

<sup>2</sup>Center for Multidisciplinary Studies, University of Belgrade, Yugoslavia

E-mail: esaponji @ ubbg. etf. bg. ac. yu

**Abstract.** Many experimental proofs show that LC-noradrenergic neurotransmitter system plays an important regulatory role at the rate at which recovery of function occurs after brain lesion, and in epilepsy. The aim of our study was to investigate the effect of electrostimulation of LC on electrocorticogram (ECoG) in rats with traumatic brain lesion. Our experiments were performed on adult Wistar male rats. There were two experimental groups: control rats and rats with lesion of right sensorimotor cortex. The brain damaged rats were used for acute experiments 30 days following the lesion. The generalized epilepsy was induced by systemic administration of crystal penicillin (ICN Galenika, 1000000 I.U./kg i.p.). The ECoG of sensorimotor cortex was recorded every 15 min before and during penicillin epilepsy. Short lasting electrostimulation of LC was performed in both experimental groups of rats, before and after penicillin injection. The ECoG recorded before penicillin administration were characterized by low power spectra in both experimental groups of rats, especially in alpha and beta frequency domain. In all rats the spike-wave activity started to appear 20-40 min after penicillin administration. There was an increase of mean total ECoG power spectra, particularly in the lower frequency bands. Electrostimulation of LC produced significant decrease in the mean total ECoG power spectra, particularly in the lower-frequency ECoG bands, which is longer lasting in brain damaged than in control rats.

**Key words:** locus coeruleus, ECoG, power spectra, brain damage, electrostimulation

### 1 Introduction

The natural balance between the inhibitory and excitatory neurotransmitters influences play a key role in normal brain function. However, the distribution of the major inhibitory (GABA) and excitatory (glutamate and aspartate) neurotransmitter systems overlaps, the first is intrinsic and the second is responsible for cortical output. Although brain damage changes both inhibitory and excitatory neurotransmitters influences, many experimental proofs showed that it mainly reduces the intrinsic cortical inhibition, leading to disinhibition of cortical activity and destabilization of brain function [1]. The risk of spontaneous epileptic discharge is increased after brain injury in humans [2]. The increased influences of excitatory neurotransmitters in animals, caused by brain damage were masked by plastic brain processes,

which would be overcome on behavioral and electroencephalographic level only by some acute disturbance, like induction of focal [3] or generalized [4] penicillin epilepsy. Despite the prolongation of seizure activity in the model of generalized penicillin epilepsy of adult brain damaged rats [4], there was no prolongation of seizure activity when brain lesion was carried out in infancy [5].

Although the locus coeruleus (LC) is the major source of central nervous system noradrenergic innervation [6], the greatest density of its innervation occurs in the primary somatosensory and motor cortices, decreasing in rostral and caudal directions from these regions [7]. Inhibitory action of noradrenaline (NA) on the central nervous system neurons was reported [8] and catecholamines, specifically noradrenergic LC system, have been repeatedly implicated in the suppression of various hyperexcitable states such as in different models of epilepsy [9], spasticity [10], as well as in the acceleration of functional recovery following brain injury [11,12]. Studies examining the effects of manipulating NA metabolism on functional recovery from brain injury have often been conflicting. Most evidence points to beneficial effect of enhancement NA neurotransmission 24<sup>h</sup> or more after brain injury [13]. The results of altering NA metabolism immediately following the injury have been less clear [14].

The aim of this study was to examine the effect of electrostimulation of LC on electrocorticogram in the model of epilepsy in rats with traumatic brain lesion, as a test of inhibitory neurotransmitter influences.

### 2 Experimental Procedures

#### 2.1 Surgery

Experiments were performed on adult male Wistar albino rats 2-2.5 months old at the beginning of study. The animals were subjected to a 12-h light-dark cycle with free access of food and water. There were two experimental groups: control rats and rats with right sensorimotor cortex lesion. The surgical procedures

were performed under nembutal anesthesia (35-40 mg/kg i.p.). The right sensorimotor cortex was removed by suction ablation (gentle aspiration through a polypropylene tip) to the depth of the white matter, at the stereotaxic coordinates for craniotomy in mm with respect to bregma: P: 4.0; A: 2.0; Rt: 4.0 [15]. The removed sector of the skull was replaced in position with bone wax after cortical lesion. The brain damaged rats were housed individually and were used for acute experiments after 30 days of recovery. Histological examination at the end of the study revealed that the lesions were restricted to the cortex, neither the striatum nor hippocampus were injured. In the acute experiments the animals were stereotaxically fixed under nembutal anesthesia (35-40 mg/kg i.p.) and craniotomy for registration of sensorimotor cortex electrocorticogram by silver ball electrodes and craniotomy for LC bipolar twisting wire stimulating electrode (according to stereotaxic coordinates in mm with respect to bregma: P: 9.5; Lt: 1.2; H: 7.5) were done. Lidocaine (2%) infiltration of all wound edges was carefully performed also to prevent suffering of the animals. The generalized epilepsy was induced by systemic administration of crystal penicillin (ICN Galenika, 500 000 I.U. dissolved in 1 ml of saline, 1000 000 I.U./kg, i.p.). Short lasting electrostimulation of LC (10-20 s; 15V; 10-15 Hz; 0.2 ms), repeated every 15 min, was performed in both experimental groups of rats, before and during penicillin epilepsy.

## 2.2 Recording and Data Processing

The electrocorticogram (ECoG) of sensorimotor cortex was recorded every 15 min before and during penicillin epilepsy, specially before and immediately after LC electrostimulation. After conventional amplification and filtering, the analog data were analyzed by a PC computer. Analog ECoG signals were digitized at the sampling rate of 128/s, and power spectral analysis was provided by Fast Fourier Transformation (FFT). Sequential ECoG power spectra were obtained every 15 min and were derived from 6-12 consecutive 8 s epochs. Besides mean total ECoG power, the power densities in the delta (0.5-4.5 Hz), theta (4.5-8.5 Hz), alpha (8.5-12.5 Hz), and beta (12.5-32.5 Hz) frequency ranges were evaluated. Statistical evaluation of the data was performed by analysis of variance-single factor (ANOVA) using Excel 5.0 for Windows;  $p < 0.05$  was taken as the level of significance.

## 3 Results

There were no electrophysiological or behavioral signs of epilepsy in both experimental groups of rats before penicillin injection. The ECoG recorded before penicillin administration in both experimental groups of rats were characterized by low power spectra, especially in alpha and beta frequency domain, with dominance of delta and theta frequency range. In all

rats the spike-wave activity started to appear 20-40 min after penicillin administration, and led to an increase in the mean total ECoG power spectra, particularly in the lower frequency bands. This increase in the mean total ECoG power spectra was higher and longer in duration (still after 120 min) in brain damaged rats. Short lasting electrostimulation of LC during penicillin epilepsy of control rats produced significant decrease in the mean total ECoG power spectra, presented as percentages of the mean value immediately before LC stimulation, 10 s ( $p < 0.01$ ), and 3-5 min after LC stimulation ( $p < 0.04$ ). 10 min after LC stimulation there was no difference ( $p > 0.05$ ) between the mean percentage value of the ECoG power spectra and the mean percentage values before LC stimulation. The effect of LC stimulation on the percentage changes in the mean total ECoG power spectra in control group of rats at all times after LC stimulation is shown in Fig.1. The result of the ANOVA single factor for percentage changes of the mean total ECoG power spectra for the group of 6 control rats at all times after LC stimulation is  $F = 4.42$ ;  $p < 0.02$ ;  $F_{crit} = 3.24$ .

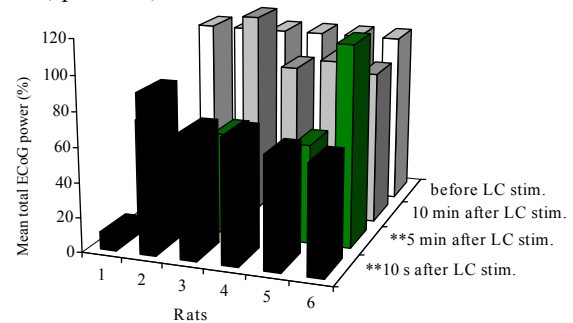

**Figure 1** The effect of LC stimulation on the percentage changes in the mean total ECoG power in the model of epilepsy in control group of 6 rats. (\*\* -  $p < 0.05$ ).

When stimulation of LC was not repeated, the mean total ECoG power spectra increase again to the level which was higher than the level before penicillin injection.

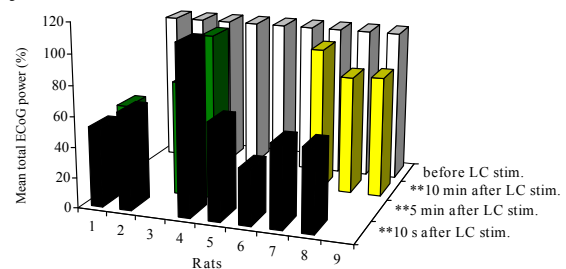

**Figure 2** The effect of LC stimulation on the percentage changes in the mean total ECoG power in the model of epilepsy in brain damaged group of 9 rats. (\*\* -  $p < 0.05$ ).

The effect of repetitive LC stimulation was the disappearance of spike-wave discharges or their rare occurrence, and as a consequence, the suppression of increase in the mean total ECoG power spectra due to penicillin administration. Short lasting LC electrostimulation during penicillin epilepsy in the brain damaged rats produced significant decrease in the

mean total ECoG power spectra (particularly in the lower frequency ECoG bands), presented as percentages of the mean value immediately before LC stimulation, as in control rats, but in all times after electrostimulation: 10 s ( $p < 0.001$ ); 3-5 min ( $p < 0.02$ ) and 10 min ( $p < 0.001$ ) after LC stimulation. The result of ANOVA single factor analysis for percentage changes of the mean total power spectra for the group of 9 brain damaged rats at all times after LC stimulation is  $F = 7.10$ ;  $p < 0.001$ ;  $F_{crit} = 3.16$ . The effect of LC stimulation, in different time after stimulation off, on percentage changes in the mean total power spectra in the brain damaged rats is shown in Fig. 2.

#### 4 Discussion and Conclusions

Many theories have been offered to explain recovery of function following permanent brain injury. Recent research has provided data that reveal several forms of brain plasticity, including changes in neurotransmitter sensitivity (neurotransmitter release, reuptake, receptor sensitivity), collateral sprouting mechanisms [16] and diaschisis [17]. Many experimental results of research using a well-characterized model of recovery from motor deficits, induced by sensorimotor cortex lesion in mature animals, point out the importance of simultaneous projections of LC neurons to ipsilateral sensorimotor cortex and mainly to contralateral cerebellum [18] and established the noradrenergic model of functional recovery [19]. On the other hand, brain damage induces destabilization of brain function mainly by reduction of intrinsic cortical inhibition, leading to disinhibition of cortical activity [1] and the decrease of neuronal interconnection stability, which have a protective role against hyperexcitation [20]. This destabilizing effect becomes pronounced under the condition of suppression of the GABAergic cortical component [3]. Since it has been shown that the injury of one axonal branch of neuron disrupts the neurotransmission of intact branches [21], damage of the terminal LC projection to ipsilateral sensorimotor cortex following sensorimotor cortex injury has an effect on the functioning of the intact axonal projection from LC to other brain structures such as cerebellum [22]. It was also suggested that when sensorimotor cortex is lesioned, not only the origins of the corticospinal pathway were lost, but direct changes in the inhibition of cerebellar Purkinje cells also occurred due to reduced amount of inhibition from intact LC axonal projections to cerebellum [19]. Our present results are in accordance with much experimental evidence about neuroprotective role of catecholamines and NA in recovery of brain functions after brain injury. Functional recovery following brain damage was accelerated by drugs which stimulate NA neurotransmitter system [23], by infusions of NA in lateral brain ventricle [11] or in cerebellum

contralateral to the damaged side [22,24]. Amphetamine induced marked decrease in the mean ECoG power spectra in the acute model of penicillin epilepsy [25], and brain lesioned rats not treated by amphetamine were characterized by longer seizure activity [26]. Microinfusions of NA into contralateral cerebellum following sensorimotor cortex injury mimicked the amphetamine-induced facilitation of motor recovery [24]. Unilateral LC lesion facilitate motor recovery from cortical injury through mechanism of the denervation supersensitivity and/or sprouting developed in the cerebellum [27]. Bilateral LC lesion suggested also that the role of the LC in functional motor recovery is to modulate the rate at which the recovery progresses, but not to the occurrence of recovery [28]. Our results showed that the effects of short lasting LC electrostimulation on the ECoG level, which was expressed as a decrease in the mean total ECoG power spectra, particularly in the low frequency bands, was longer lasting in the acute model of generalized epilepsy in brain damaged rats than in control rats. In the model of epilepsy in brain damaged rats beside the weakness of GABA inhibition, due to generalized epilepsy caused by penicillin, there is a weakness of NA inhibitory influences caused by brain lesion. The reduced amount of intrinsic inhibitory cortical inhibition in brain damaged rats was compensated by plastic brain processes which masked destabilized brain function out of some acute disturbance like epilepsy. Electrostimulation of LC in the acute model of epilepsy in brain damaged rats, which tested inhibitory neurotransmitter influences 30 days after brain damage, indicated that the brain was not completely recovered. Thus, we may conclude that the prolongation of the response to inhibitory influences indicates plastic brain processes.

#### References

- [1] D.A. Prince and R.W. Connors, Mechanisms of interictal epileptogenesis, *Adv. Neurol.* 44 (1986), pp. 275-299.
- [2] A.M. Salazar, B. Jabbari, S.C. Vance, L. Grafman, D. Amin, and J.D. Dillon, Epilepsy after penetrating head injury. I. Clinical Correlates: A report of the Vietnam Head Injury Study, *Neurology* 35 (1985), pp. 1406-1414.
- [3] E. Horn, K. Esseling, and H.H. Kornhuber, The influence of cortical lesions on penicillin induced convulsive activity in the awake rat. *Arch. Ital. Biol.*, 128 (1990), pp. 1-18.
- [4] M. Čulić, S. Peković, M. Stojiljković, J. Šaponjić, B. Janković, and Lj. Rakić, The effect of cortical lesion on systemic penicillin epilepsy in rat, *Neuroscience* 51 (1992), pp. 439-444.
- [5] M. Čulić, J. Šaponjić, B. Janković, S. Peković, M. Stojiljković, S. Udović, and Lj. Rakić, Effect of early cortical lesion on the acute model of

- epilepsy, *Int. J. Dev. Neurosci.* 13 (1995), pp. 655-658.
- [6] S.L. Foote, F.G. Bloom, and G. Aston-Jones, Nucleus locus coeruleus: New evidence of anatomical and physiological specificity, *Physiol. Rev.* 63 (1983), pp. 844-914.
- [7] J.H. Morrison, S.L. Foote, D. O'Connor, and F.E. Bloom, Laminar, tangential and regional organization of the noradrenergic innervation of the monkey cortex: Dopamine- $\beta$ -hydroxylase immunohistochemistry, *Brain Res. Bull.* 9 (1982), pp. 309-319.
- [8] M. Segal, Mechanisms of action of noradrenaline in the rat brain, *Physiol. Psychol.* 13 (1985), pp. 172-178.
- [9] G. Ferraro, P. Sardo, M. Sabatino, G. Caravagilios, and V. La Grutta, Anticonvulsant activity of the noradrenergic locus coeruleus system: role of beta mediation, *Neurosci. Lett.* 169 (1994), pp. 93-96.
- [10] B. Feinstein, C.A. Gleason, and B. Libet, Stimulation of locus coeruleus in man, *Stereotact. Funct. Neurosurg.* 52 (1989), pp. 26-41.
- [11] M.G. Boyeson and D.M. Feeney, Intra-ventricular norepinephrine facilitates motor recovery following sensorimotor cortex injury. *Pharmacol. Biochem. Behav.* 35 (1990), pp. 497-501.
- [12] R.M. Prasad, J.M. Dose, H.S. Dhillon, and P.J. Kraemer, Amphetamine affects the behavioral outcome of lateral fluid percussion brain injury in the rat, *Rest. Neurol. Neurosci.* 9 (1995), pp. 65-75.
- [13] R.L. Sutton and D.M. Feeney, Pharmacological approaches to rehabilitation: noradrenergic pharmacotherapy and functional recovery after cortical injury, in L.S. Illis, ed., *Neurological Rehabilitation*, 2nd ed. (Blackwell Scientific Publ., Oxford, 1994), pp. 469-481.
- [14] A.A. Dunn-Meyenell, Y. Yarlagadda, and B.E. Levin,  $\alpha_1$  - adrenoceptor blockade increases behavioral deficits in traumatic brain injury, *J. Neurotrauma.* 14 (1997), pp. 43-52.
- [15] G. Paxinos and C. Watson, *The Rat Brain in Stereotaxic Coordinates* (Academic Press, New York, 1982).
- [16] E.M. Stricker and M.J. Zigmond, Brain monoamines, homeostasis and adaptive behavior, in V.B. Mountcastle, F.E. Bloom, and S.R. Geiger, eds., *Handbook of Physiology - The Nervous system* (Waverly Press, Baltimore, MD, 1986), pp. 677-700.
- [17] D.M. Feeney, Pharmacologic modulation of recovery after brain injury: a reconsideration of diaschisis, *J. Neurol. Rehab.* 5 (1991), pp. 113-128.
- [18] S.E. Laughlin, S.L. Foote, and R. Grzanna, Efferent projections of nucleus locus coeruleus: Morphologic subpopulations have different efferent targets, *Neuroscience* 18 (1986), pp. 307-319.
- [19] M.G. Boyeson, J.L. Jones, and R.L. Harmon, Sparing of motor function after cortical injury, *Arch. Neurol.* 51 (1994), pp. 405-414.
- [20] K. Esseling and E. Horn, Evidence of counterregulation during locally induced hyperexcitation of the cortex, in N. Elsner and W. Singer, eds., *Dynamics and Plasticity in Neuronal Systems* (G. Thieme Verlag, New York, 1989), p. 438.
- [21] R.A. Ross, T.H. Joh, and D.J. Reis, Reversible changes in the accumulation and activities of tyrosine hydroxylase and dopamine-beta-hydroxylase in neurons of nucleus locus coeruleus during retrograde reaction, *Brain Res.* 92 (1975), pp. 57-72.
- [22] M.G. Boyeson, K.A. Krobert, P.J. Scherer, and C.M. Grade, Reinstatement of motor deficit in recovered brain-injured animals: the role of cerebellar norepinephrine, *Restor. Neurol. Neurosci.* 5 (1993), pp. 283-290.
- [23] M.G. Boyeson, R.L. Harmon, and J.L. Jones, Comparative effects of fluoxetine, amitriptyline and serotonin on functional motor recovery after sensorimotor cortex injury, *Am. J. Phys. Med. Rehabil.* 73 (1994), pp. 76-63.
- [24] M.G. Boyeson and K.A. Krobert, Cerebellar norepinephrine infusions facilitate recovery after sensorimotor injury, *Brain Res. Bull.* 29 (1992), pp. 435-439.
- [25] M. Čulić, J. Šaponjić, B. Janković, and Lj. Rakić, Amphetamine and haloperidol modulatory effects on Purkinje cell activity and on EEG power spectra in the acute rat model of epilepsy, *Neurosci. Lett.* 182 (1994), pp. 259-262.
- [26] J. Šaponjić, M. Čulić, B. Janković, and Lj. Rakić, Amphetamine effect on recovery following cortical lesion in the model of epilepsy, in D.G. Stuart, G.N. Gantchev, V.S. Gurfinkel, and M. Wiesendanger, eds., *Motor Control VII* (Motor Control Press, Tuscon, Az, 1996), pp. 263-264.
- [27] M.G. Boyeson, P.J. Scherer, C.M. Grade, and K.A. Krobert, Unilateral locus coeruleus lesions facilitate motor recovery from cortical injury through supersensitivity mechanisms. *Pharmacol. Biochem. Behav.* 44 (1993), pp. 297-305.
- [28] M.G. Boyeson, T.R. Callister, and J.E. Cavazos, Biochemical and behavioral effects of a sensorimotor cortex injury in rats pretreated with the noradrenergic neurotoxin DSP-4, *Behav. Neurosci.* 106 (1992), pp. 964-973.



## A QUANTUM PICTURE OF A MULTIDIMENSIONAL UNIVERSE ON THE BASIS OF CONSCIOUSNESS

Marcus Schmiede

Veda-Akademie, Schloß Weißenstein, 73111 Lauterstein, Germany

**Abstract.** Quantum physics can be derived from a small number of axioms which are preconditions of experience. Basically the flow of time has to be preassumed to construct quantum theory as the most general theory which makes predictions about future events. As such it offers a description of reality which includes the mental realm as well as the physical realm and describes a holistic universe in which the introduction of irreducible personalities is no metaphysical addition.

According to the ancient knowledge contained in the Vedas the human body as well as the whole universe consists of a multidimensionally structured hierarchy of processes. The discrete levels of this structure are connected through processes which may be described by quantum physics and which transfer information from one level to the other. We just perceive the lowest levels of these structures in which the separation of its parts is maximized. Therefore, in our conscious experience space as the order of this separation predominates. On higher levels of this hierarchy the separation becomes less manifest and the influence of consciousness increases accordingly.

According to these considerations consciousness and its relation to matter can be understood only to such an extent, as the more holistic aspects or levels of physical reality are understood.

**Key words:** *space, time, consciousness, quantum physics, Burkhard Heim, metrons, quantum gravity, multi-valued logic, unified field-theory, quality, Gotthard Günther, Vedanta, vedic metaphysics*

### 1 Time and Experience in Quantum mechanics

Carl Friedrich von Weizsäcker describes quantum mechanics as the most general theory which makes predictions about future events [1]. As such it fulfills the qualifications for a mechanistic theory of the physical reality. In his system of an axiomatic foundation of quantum physics the first premise is the distinction of past and future. The past consists of facts whereas the future consists of possibilities. This distinction corresponds to our experience and Weizsäcker considers it to be a precondition of experience. In the mathematical model of quantum mechanics it implies the term „probability“ related to the possibility of future events.

Events happen in the present. The events of the past are accessible as facts to us through our memory or other means. The past is already fixed. It is a fact.

The facts are the present form of the past (Gegenwartsform).

As opposed to the past the future is still open and offers different possibilities or alternatives. It represents a continuous spectrum of possible events, out of which some will be realized, whereas others will not. In the present one event takes place. In the present one event is chosen from the continuum of possibilities which then becomes a fact and belongs to the past. In the present the continuum of possibilities is transformed continuously into the discrete spectrum of the past. Time can therefore be defined as the process which continuously transforms the continuum of possibilities into the discrete spectrum of facts. This process is the present and increases the set of facts.

The present seems to be constituted by a multitude of events. Actually, present refers to awareness of the moment and as such it is one event. As the process of becoming conscious it is one conscious wholeness and is represented in quantum physics as the actualization of the wave function.

Classical physics postulates space as an order for all physical objects and considers time to be a passive parameter of order. Quantum physics reverses this picture. Classical physics understood the essence of the objects to be their extension in space and all physical transformations were theoretically reversible. The being of matter in its spacial extension was in the center of attention.

In quantum physics the three dimensional space of our experience can be derived from the logics of temporal propositions which accepts the asymmetry of time and the becoming of physical reality as a precondition of experience. According to this view the irreversibility of time is based in the conscious experience itself. This is not considered in the view of classical physics.

Quantum physics is based on the term „probability“ and introduces chance into physics. The crucial question is *what* chooses the fact from the continuum of possibilities. It cannot be done by the laws of physics or physical mechanisms, otherwise there would be no difference between past and future or the facts and the possibilities. This choice happens in the present through the process of time and is identified with chance by modern mechanistic science. In this way they identify time, chance and present

which is a consequence of incomplete knowledge about the underlying causes. This is exactly the original definition of chance: It is the result of incomplete knowledge about the exact causes.

## 2 The Observer Effect in Quantum mechanics

Eugen Wigner proposed that the actualization of the wave function is carried out by the consciousness of the observer, which finishes the observation or measurement. Others have argued that there is no theoretical or empirical evidence or necessity for such an assumption [2].

Actually there are a number of experiments which investigate the observer effect in quantum physics and which give evidence for Wigner's hypothesis.

One example is a series of experiments carried out by Robert Jahn et al. at Princeton University. These experiments turned out to show robust results which are repeatable in the usual range of psychological experiments [3].

More recent findings from Princeton even show a significant yet very small observer effect, if the observed signals caused by a real alpha-decay, had been saved on a computer disc for three months before they were displayed to the observer [4]. These astonishing results were considered seriously by some physicists like Henry Stapp from Berkeley, who suggested a slight modification of the mathematics of quantum physics to explain such observer effects which act backwards in time [5].

These results are perfectly in line with our considerations about time. As long as nobody observes the result of any physical process, it still belongs to the continuum of possible events which we call future. Even if the computer recognized the physical process by memorizing it on a disc, the wave function of the whole system seems to be in a state which is open to the observer effect. This seems to reject the thesis that the reduction of the wave function is already carried out by the contact of the quantum system with a macroscopic device.

From these results we can draw three conclusions:

(1) The understanding of the progression of time in quantum physics depends on the knowledge or content of consciousness of all potential observers.

(2) Physical events only take place, if a choice of the facts from the possibilities takes place. This choice corresponds to the event, that a person becomes aware of it. This does not answer the question who chooses.

(3) Time is the process which selects the facts from the possibilities, but it is also the process of conscious experience of an event by a person.

These conclusions point out the necessity to consider the knowledge of persons and the structure of their experience to construct a consistent picture of physical reality.

## 3 Personality and Knowledge

Personality can be defined as an expanding body of knowledge, connected with an inherent power or energy which is characteristic of this person and generates the continuous expansion. This individual, characteristic energy can be called „his personality“. In general a person is a knower of such a body of knowledge. This definition is much more abstract and much broader than our general idea of a conditioned personality.

According to Henry Stapp the introduction of irreducible personalities into physics does not introduce another inscrutable element into the theory, because this inscrutable aspect is already represented by the question „What chooses, what happens really in the individual quantum event?“.

He writes: „The basic point is that GVV<sup>1</sup> suggests *enlarging* the set of mathematically described elements of „physical“ theory to include the objective forms of the sensible and perceptual objects of direct knowing, together with those aspects of absolute knowledge that are represented by the wave function of quantum theory. The inscrutable aspects of nature then get concentrated in the „personalities“ of various entities, which can be separated to some extent from the associated bodies of knowledge. Since in quantum theory we have in any case, the inscrutable aspect represented by the unanswered question „What chooses what actually happens in the individual quantum events?“ no additional inscrutability needs to be introduced into the theory by introducing persons. Rather we have expanded the domain that is open to mathematical description by separating out the knowledge of these persons, which in principle can be described independent of their „personalities“, which remain outside the framework of our mathematical description. The uncontrolled stochastic elements in quantum mechanics are naturally to be assigned to the uncontrolled and undescribed „personality“ factors of the GVV ontology.“ [6]

## 4 Knowledge and Absolute Knowledge

In his analysis of the Vedic ontology in relationship to modern quantum theory Henry Stapp expresses his understanding of the ontological meaning of the wave function: „The wave function of quantum theory, to the extent that it represents not merely a tool of calculation for scientists, but also a theoretical representation of some objective (externally existing) counterpart, is probably most aptly thought of as a representation of some aspect of *absolute knowledge*. This wave function certainly does not represent *substance*, in the usual sense of the word. It represents only probabilities, or propensities, or objective tendencies, for certain observation-type events to occur. The probabilities for observation-type

<sup>1</sup> Gaudiya Vaisnava Vedanta: An 500 years old tradition which teaches the ancient knowledge of the Vedas (Vedanta).

events to occur are more mind-like than substance-like in character: they represent a quality of nature that is more akin to knowledge and expectations than to fixed concrete reality. Also, the way that the wave function suddenly jumps to a new form (Collapse of the wave packet) when an appropriate observation-type event occurs is a behaviour more characteristic of a change in knowledge than a change in substance. Finally, the underlying notion of an observation-type event itself suggests a change in knowledge. Quantum theory thus effectively converts the scientific image of the objective world from that of the *giant machine* of classical mechanics to that of an evolving body of absolute knowledge; quantum theory, insofar as it is constructed to be more than just a set of mysterious rules of computation, can quite reasonably be said to have brought the mind of God back into science, after its banishment by Descartes.“ [7]

In this interpretation of quantum mechanics physical reality is experienced in the exchange between the body of absolute knowledge or the „mind of god“ and the individual sets of knowledge or the individual souls. The actualization of the wavefunction corresponds to such a transfer of information or knowledge, which is a certain vibrational excitation and simultaneously a transfer of a unit of meaning in form of a quantum. This meaning can be experienced as the coordinated change of knowledge in the receiver and the sender and absorption of a particle, whereas the transmission takes place by a vibrating wave. For an atom this process takes place by the emission of a photon. Knowledge and consciousness may even be present in the microworld.

For a human being this process can be experienced by the reception of an *idea of an object* which changes the state of mind of this person or his knowledge of the world.

## 5 Matter, Life and Consciousness

In his book "Mind and Matter" Erwin Schrödinger points out that the basic problems of modern science arise due to the Cartesian dualism of matter and mind which is expressed in the attempt to describe the material properties of an objective world independent of any conscious subject. If this concept of objectifying all scientific statements is combined with the claim for completeness of the scientific worldview we arrive at the problem of finding our very conscious self to be part of the objective external world, which is actually a construction of our mind from what we experience through our senses. This has two important consequences:

- (1) The world of our scientific theory is colorless, silent, has no smell and no sensual qualities at all.
- (2) The search for the point where matter and consciousness interact has to remain unsuccessful.

Modern physics draws the picture of an unconscious, unanimated substance, called matter,

which might fit into a mechanistic mathematical model of reality.

In opposition to this understanding this paper will briefly deal with a few aspects of three theses concerning life, matter and consciousness.

- (i) matter and mind have a common conscious origin which is the ultimate reality
- (ii) matter is a life process (not life a material process)
- (iii) energy is life energy and thus always subject-related

To overcome the problems we have to consider matter and its perception as two aspects of one process in which the original conscious energy evolves in time to manifest the objects of our perception as well as their perception simultaneously. Different evolutionary steps of this process can be identified with the classical elements of the Vedas which are useful metaphors for even more complex processes in biology and medicine. Important philosophical, psychological and linguistic questions also arise in this connection but here I would like to focus on basic physical concepts.

## 6 Vedic Metaphysics

In Vedic metaphysics reality has a manifested and an unmanifested aspect which in modern terms can be related to an implicit and an explicit order. Order is due to intelligence which is considered to be a function of consciousness. The underlying implicit order of the physical as well as the mental reality is called *buddhi* and is conscious by nature. In this element *buddhi* polar vibrations inhere. If these vibrations refer to the conscious whole they appear as the objects of perception; if they refer to the individual conscious self they appear as the perception itself.

## 7 Foundations of Vedic Physics and Quantum Mechanics

According to Vedic Metaphysics the element ether consists of vibrations which carry information and its meaning as well, referring to the quality of its potential perception through the senses of a conscious observer. According to the structure of our five senses this meaning will appear in the categories of sound, touch, form, taste and smell.

The original polarity of an implicit and explicit order manifests again on the level of information which can be divided into actual and potential information. The information processing structure can be interpreted in terms of modern quantum physics. Other interpretations could be given on various different levels like electromagnetic fields of organisms (biophotons), neuralnet - pattern - reconstructions (Mitya Perus), Prigogines dissipative structures etc.

Actual information arises as the result of an actualization of the wave function and the potential information refers to the steadily evolving wave function of a physical system. To derive actual information from potential information an actualization has to be carried out which may be identified with the subtle quality of the element air or touch. Touch as the subtle quality of the element air may be simultaneously identified with the meaning of this actualization which can be analyzed in terms of the sensual qualities of the concerned elements - sound, touch, form, taste and smell.

Information and its meaning appear as the two qualities carried by the subtle vibration (sound) carried by the Vedic element ether. The potential information represented by the wave function corresponds to the element air which cannot be measured and consists of all the higher hierarchical influences on our perceived system. The potential information does not strongly determine the behaviour of a physical system, because each mechanistic description like that of the Schrödinger-equation or that which will be offered by Vedic physics (VP) must neglect nonmechanistic influences like free will as a non-causal conscious decision, the complexities of the law of karma and the will of God.

The actually measured quantum state fits into a classical description of the physical reality in three-dimensional space as a continuum of matter, fields and particles as described by FVP. In this continuum the element air acts as an interruptor controlled by the informational platform of the Vedic ether.

## 8 The Manifestation of Multidimensional Space

Starting with time and consciousness at its axiomatic basis quantum mechanics derives the form of space as the order of what can be simultaneously experienced by a mathematical analysis of the separated existence of the physical objects and their possible relationships [8]. Space manifests as a result of the separated appearance of different aspects of reality. According to our consciousness we perceive the different aspects of reality to be separated or to be interconnected. Therefore, the manifestation of space depends on the quality of consciousness through which it is perceived.

When trying to find a complete picture of reality the dependence of space on consciousness has to be taken into account. We will have to allow reality to be a multidimensional, dynamic structure of varieties of spaces which are different in quality.

Practically we experience such an interpenetration of spaces of different qualities in our everyday life. For practical purpose I normally identify the image of my body which is within my mind with my body and also the image of the world with the world itself. This identification is of course naive and has to be replaced by two kinds of space which are in touch with each

other through a dimensional interface. One is the external physical space, which we all commonly share in our experience and the other is my internal space of sensual perceptions, which is conscious by nature. These two qualitatively distinguished spaces are connected with each other through the process of sensual perception which again is reflected in the physical reality in the form of quantum processes. Everybody experiences the world through his own consciousness-space and all these different spaces are connected through spaces of different qualities again. One level is the three-dimensional physical space; another level is the space of information, on which communication is possible which does not depend on physical information carriers (radionics, technical remote viewing etc.); other kinds of spaces are related to the thinking process etc.

Bringing all these different kinds of spaces together within our common physical understanding of three-dimensional space is very problematic, because of their different qualities which refer to their different relationships to consciousness.

We can only integrate those spacial dimensions in one picture which are of the same quality, because our traditional mathematics is based on classical Aristotelian logic which exclusively allows monocontextual systems to be described. The picture which we have just drawn is polycontextual of course and requires a multi-valued logic and ontology. Otherwise, by focussing on the objective mechanistic aspect of space, one loses the subjective aspect of reality and by focussing on the subjective or consciousness-related aspect of reality, the physical reality becomes nothing.

A higher valued logical system as developed by Gotthard Günther is suggested to be a basis of a qualitative mathematics (as developed by Gerhard Thomas and others). This new kind of mathematics gives the formalism to describe a polycontextual system of qualitatively differentiated spaces which are related to a parallelly existing spiritual reality of consciousness.

In such a polycontextual system quantum process seem to serve as interfaces between different qualities of subject-related levels of reality as in the Vedic system of thought the element air and the principle of touch serve as a medium of information transfer between the etherical level and the four-dimensional space-time structure.

## 9 The Vortex as a Dimensional Interface

A cakra or vortex may serve as a dimensional interface. A vortex is a dynamical process which transfers its substance from outside to inside or vice versa. In the bioenergetic system the cakras connect the subtle body with the gross body and the subtle body with consciousness. In the last century the atoms were considered to be dynamic vortex-processes by

Lord Kelvin, Maxwell, Thompson and many others. This idea was later replaced by the quantum mechanical descriptions. We suggest a combination of both ideas. Many works have been done, explaining the properties of elementary-particles through vortex-dynamics [9] and also by the means of extrasensual perception the vortex-dynamics of quarks [10] and other elementary particles has been confirmed.

The interpretation of vedic texts offers a systematic classification of vortex-dynamics to form the various structures of chemical elements, elementary particles and other physical and biological structures. This classification follows the systematics of the five elements earth, water, fire, air and ether [11].

To understand the multidimensional structure of the universe, its spacial organization has to be understood as the result of a permanently ongoing dynamic process, in which a parallelly existing spiritual reality of conscious relationships manifests. The universal consciousness manifests in the multidimensionally structured physical space which is ordered by hierarchically structured vortex-shaped processes. Through dimensional interfaces (senses and cakras) this universe is in touch with unlimited individual spaces of consciousness.

## 10 Mathematical Realization of Higher Dimensional Space

The concepts of this article may be formalized by the field-theory of Burkhard Heim [12], a German physicist, who has been working on a mathematical description of the quantitative aspect of matter, life, the psyche and the mental realm since 50 years. He succeeded in finding a physical model which predicts the masses of the elementary particles and the most important natural constants very accurately in good agreement with the empirical values.

One main challenge in modern physics is to unite the theory of relativity with quantum physics and to construct a quantum theory of gravitation. Quantum theory focusses on the micro-level of reality and is dominated by time, whereas the theory of general relativity focusses on the large scales and is dominated by space. To bring these two theories together means to connect time and space, microcosm and macrocosm and most probably also mind and matter [13]. According to Burkhard Heim this can only be achieved by introducing the life-process as an irreducible reality into the description. Only the life-process unites all these polarities.

Heim shows that four-dimensional space-time is a subspace of a six-dimensional hyperspace, which in turn has a twelve-dimensional hyperspace. By deriving a law of dimensions he demonstrates that only this combination of four, six and twelve dimensions fulfills all the requirements of a unification of quantumphysics and gravity. He demonstrates that the six-dimensional space is

composed of two-dimensional metrons which are of the dimension of the square of Planck's lengths. These metrons are the quanta of space. An undisturbed lattice of these metrons is equivalent to empty three-dimensional space, whereas certain deformations of this lattice can be interpreted as physical structures. Of the twelve dimensions only three are real (our common space), and nine are imaginary. Dimension 5 and 6 are organizational coordinates which measure the degree of complexity and teleological value of the related physical structures. The fifth and sixth dimension can only influence physical space through time. These interactions appear as changes of quantum probabilities in microsystems. Four different kinds of condensations of the metronic structure can be distinguished. They correspond to different physical entities:

- (a) condensations of  $x_5$  and  $x_6$  create gravitational waves within  $R_4$ ;
- (b) condensations of  $x_4$ ,  $x_5$  and  $x_6$  create photons;
- (c) condensations of  $x_1$ ,  $x_2$ ,  $x_3$ ,  $x_5$  and  $x_6$  create uncharged particles; and
- (d) condensations of  $x_1$ ,  $x_2$ ,  $x_3$ ,  $x_4$ ,  $x_5$  and  $x_6$  create charged particles.

The higher dimensional hyperspace  $R_{12}$  has six additional dimensions:

- (i)  $x_7$  and  $x_8$  form a complementary information-space; and
- (ii)  $x_9$ ,  $x_{10}$ ,  $x_{11}$  and  $x_{12}$  form the space of life processes and networks of subtle energies which nourish the informational fields  $x_7$  and  $x_8$ .

The epistemological basis of Heim's theory is based on a multi-valued logical system, developed by Burkhard Heim as a basis of his field-theory so that the qualitative aspect of reality could be included.

Burkhard Heim's theory seems to offer a new formalism to describe the quantitative aspect of a multidimensional universe mathematically, which is much more characterized by quality than by quantity. It integrates matter, bios, psyche and pneuma and forms a transcendently open system.

## References

- [1] C. Friedrich von Weizsäcker, in E. Scheibe, ed., *The Role of Experience in Science* (de Gruyter, Berlin, 1988).
- [2] C.F. von Weizsäcker, *Der Mensch in seiner Geschichte* (DTV, München, 1993), p. 92.
- [3] W. von Lucadou, *Wigner's Friend Revitalized?*, (Springer Series in Synergetics, Vol. 63, Inside Versus Outside).
- [4] R.G. Jahn and B.J. Dunne, *An REG Experiment with Large Data Base Capability, III: Operated Related Anomalies* (School of Engineering / Applied Science, Princeton University, 1985).
- [5] R. Jahn, Y. Dobyns, and B. Dunne, *J. Sci. Expl.* 5 (1991), 205; B.J. Dunne and R.G. Jahn, *ibid.* 6 (1992), p. 311.
- [6] H.P. Stapp, *Phys. Rev. A* 50 (1994), pp. 18-21.

- [7] H.P. Stapp, *Report on the Gaudiya Vaisnava Vedanta form of Vedic Ontology* (Bhaktivedanta Institute, 1994), p. 45.
- [8] H.P. Stapp, *Report on the Gaudiya Vaisnava Vedanta form of Vedic Ontology* (Bhaktivedanta Institute, 1994), p. 40.
- [9] C.F. von Wiezsäcker, *Der Mensch in seiner Geschichte* (DTV München).
- [10] P. Tewari, K. Meyl, B. Heim, and S.M. Phillips, private communication.
- [11] S.M. Phillips, *Extrasensual Perception of Quarks*, Illinois, 1980.
- [12] W. Wiedergut, Moderne Physik und die Elementelehre des Altertums, in Marcus Schmiede, *Das letzte Geheimnis*, Frankfurt, 1995.
- [13] B. Heim, *Elementarstrukturen der Materie*, Band 1-3 (Resch-Verlag Innsbruck).
- [14] H. Beck and I. von Ludwiger, Basic ideas of Burkhard Heim's unified field theory; in *MUFON-CES-Report*, No. 11 (1993).
- [15] R. Penroses also proposes that consciousness and mind-matter interactions can only be understood by a quantum theory of gravity: *The Emperors New Mind*, and *Shadows of the Mind*.

## THE SEPARATION OF MESMERISM AND HYPNOSIS AS DIFFERENT STATES OF CONSCIOUSNESS

Michael Schubert

School of Natural and Complementary Medicine, Southern Cross University,  
P.O. Box 157, Lismore N.S.W. 2480, Australia,  
email: mschuber@scu.edu.au

**Abstract.** The literature of hypnosis and psychiatry treat the term's animal magnetism, mesmerism and hypnosis as synonyms. This paper argues that whilst it is reasonable to consider animal magnetism and mesmerism as synonymous, hypnosis is physiologically and psychologically different. Historical material indicates that early practitioner's of hypnosis understood the difference between hypnosis and mesmerism. Two contemporary studies and the work of the author demonstrate the qualitative and quantitative differences between the two states. Mesmerism, by contrast to hypnosis: is induced by non-contact passes of the hand (cf. verbal induction); results in an elevation of heart rate (cf. drop) and substantially greater *frontalis* muscular relaxation; is not able to be reproduced by subjects on their own (cf. self-hypnosis); and is considered by experienced hypnotic subjects to be a different and subjectively deeper trance state. The considerable documentation of clinical outcomes and the results of the studies provide a substantial case for the consideration mesmerism and hypnosis as different states of consciousness.

**Keywords:** *mesmerism, hypnosis, animal magnetism.*

There is a common misconception in the literature of hypnosis and psychiatry, which implies that the term's animal magnetism, mesmerism and hypnosis are synonyms, with the former two terms considered historical antecedents of hypnosis. This paper argues that the practitioners who developed mesmerism and hypnosis were aware of the differences. Further, there is qualitative and quantitative evidence that the psychological and physiological states following induction by mesmerism or hypnosis are different.

The expression "animal magnetism" is usually associated with Franz Anton Mesmer (1734-1815), but it is clear that Father Anthanasius Kuchir (1602-1680) first used the term in 1646 when he discussed the result of his animal experimentation [1,2,3]. Völgyesi [4] reports that "Kirchir describes how the mystical effects of cosmic magnetism, both of attraction and repulsion, were gaining credence not only in the sphere of metals (mineral magnetism) but also in relation to the various elements, plants and animals - animal magnetism, and beyond these in the worlds of music and love. "

Mesmer's use of the term animal magnetism appears to be an attempt to describe and offer an explanation for the phenomena he was observing as a

result of his practices. William Gilbert (1544-1603) had published his research [5] into electricity and magnetism in 1600, and Mesmer utilized this discovery as an analogy for his work. In Mesmer's time, there was some confusion as a result of his description. Mesmer remarked that "The repeated writings of Father Hell on this subject (mineral magnetism) inspired the public, which is always eager for a specific against nervous disorders, with the ill-founded opinion that the discovery in question consisted in the mere use of the magnet. I in my turn wrote to refute their error, by publishing the existence of *Animal Magnetism*, essentially distinct from the Magnet; however, the public, being predisposed to a man of high repute, remained in its error" [6].

The term "animal magnetism" was used by experimenters and practitioners inducing and investigating various behavioural phenomena in animals, plants and humans from the early part of the seventeenth century. I have found no evidence that Mesmer used the term "mesmerism" in any of his writings. The term mesmerism is most likely to have been constructed at the earliest in 1774, following the publicity surrounding the "cure" of Francisca Oesterlein (often referred to as Fräulein Franzl). Mesmer used magnets, then magnetic passes on his patient, who lived with Mesmer and his wife during the 1770s in Vienna [7].

Mesmer defined animal magnetism in 1779 - "I named the property of the animal body that renders it sensitive to the action of heavenly bodies and of the earth *Animal Magnetism* [6]. Mesmer's 1776 medical dissertation [8] had explored the concepts of gravitation, attraction and atmospheric tides. He utilized this vitalistic concept of the animal magnetic property of human bodies, and believed that he could influence the course of a person's health by the application of magnets, either *in situ* or by moving them over the body of the subject. In time, he dispensed with the magnets, requiring only the "passes of the hands" that became the fundamental method of mesmeric induction.

Two royal commissions in France are often credited with debunking the practice of mesmerism. The commissions never directly investigated Mesmer,

and the report [9] indicate that many of Mesmer's cures were valid. The commissions only called into question Mesmer's model of animal magnetism, because the "magnetic fluid" could not be detected. They considered that the various "crises" that patients experienced were explicable by suggestion alone. Whilst mesmerism was not well received by the French commissioners, the Prussian government's report of 1816 was favorable, resulting in the establishment of Chairs of Mesmerism in the Universities of Bonn and Berlin [10].

In Great Britain, two medical practitioners were closely associated with the practice and development of mesmerism, John Elliotson (1791-1868) and James Esdaile (1808-1859). Elliotson was clearly an innovative medical practitioner. He advocated auscultation, made early use of the stethoscope, translated a major text on physiology, maintained an interest in mesmerism, phrenology and acupuncture; synthesized the medical knowledge of his time in several volumes; lectured at the University College Hospital; and conducted a busy private practice [11]. He published many case histories in *The Lancet* and *The Zoist* in the years 1823-1838. From 1838, the editor of *The Lancet*, continually discredited the mesmeric work of Elliotson.

Elliotson's published works on mesmerism, including *The Lancet* articles exceed 200,000 words. Many paranormal phenomena were demonstrated by mesmerized subjects, notably that of clairvoyance. Elliotson claimed many cures of psychosomatic illness. The most prominent physiological effects were the achievement of partial and full states of anesthesia and the resolution of nervous system disorders. Mesmeric hospitals were established in Britain in the 1840s, for surgical and general mesmeric treatment, but were short-lived [12].

In 1846, James Esdaile (1808-1859), a Scottish surgeon working in India, published the details of several thousand minors, and over three hundred major operations performed using mesmeric anesthesia, as well as cures using mesmerism alone [13]. Esdaile encouraged the examination of mesmerism by his peers and a Committee of Investigation in 1846 resulted in the provision of a small hospital in Calcutta for the furtherance of his mesmeric work [14].

Both Elliotson's and Esdaile's works, published in England and promoting the successful use of mesmeric anesthesia in particular, were largely ignored, and Esdaile returned to Scotland in 1951, continuing to practice mesmerism until his death. Elliotson was awarded the honor of delivering the *Harveian Oration* to the Royal College of Physicians in 1846, which he concluded by encouraging the members to embrace the study and use of mesmerism [15].

In 1843, James Braid (1795-1861) published a work that defined the term hypnosis and distinguished it from animal magnetism [16]: "It will be observed,

for reasons I have adduced, I have now entirely separated Hypnotism from Animal Magnetism. I consider it (hypnosis) to be merely a simple, speedy, and certain mode of throwing the nervous system into a new condition, which may be rendered eminently available in the cure of certain disorders. I trust therefore, it may be investigated quite independently of any bias, either for or against the subject, as connected with mesmerism; and only by the facts adduced" [17]. The term hypnosis was used by Braid as an abbreviation of his preferred professional term "neurohypnotism" which he proscribed as meaning the "*rationale or doctrine of nervous sleep*" [15].

Contemporary authors [2,18] ignore the distinction made by the originator of the term hypnosis. Their opinions seem to be based on an *a priori* assumption that people using mesmerism (or animal magnetism) did not realize they were achieving their results through hypnotic phenomena. It is reasonable to use animal magnetism and mesmerism as synonyms, although I would argue that mesmerism is best considered as the activity, and animal magnetism the theory or explanation.

In distinguishing mesmerism from hypnosis there are several key points:

(1) The induction of hypnosis involves the use of verbal suggestion, with a varying component of non-verbal suggestion. One of the characteristics of mesmerism is that passes of the hand, or some similar physical action represent the entire induction process. No verbal component need be used [19].

(2) The resultant physiological status of the patient is different depending on whether a nonverbal mesmeric or verbal (and/or non-verbal) hypnotic induction is performed [20]. Additionally, subjects when asked to compare hypnosis and mesmerism, distinguish the two as different states.

(3) Self-hypnosis is possible and there is an argument that many instances of hypnosis are self hypnosis rather than hetero-hypnosis [21]. Self-mesmerism is not considered possible, although Mesmer described a procedure on one occasion [6].

(4) The subject, by an act of will, is able to resist hypnosis. In mesmerism it is considered possible to mesmerize a subject against their will [13].

The mesmeric induction techniques were at times glamorized, but essentially consist of passes of the hand. Initially, magnets were held in the hand of some operators, but feathers, herbs and other "props" particular to various cultures have been used. The Syrian culture (c. 890 BC) has reports of "sustained passes with their hands over the body and diseased parts of a patient to effect healing and cures" [19]. The sleep temples of Aesculapian priests in Greece and Rome "would stroke and brush away symptoms with their hands or a piece of cloth" [19]. Some Australian aboriginal nations utilized pass of the hand [22] and mesmeric passes are used in modern India, carried forward for potentially thousands of year's [23]. Esdaile's technique of longitudinal passes of the hand



were utilized in the contemporary studies of Pulos [19] and McGarry [20].

Pulos [19] used 102 subjects who exchanged 15 minutes of mesmeric passes, after which they interviewed the subject. The physical and mental experiences differed greatly: 15% experienced a dissociative and fragmented sensation of their bodies, while 9% lost total contact of sense of body completely. Twenty-two percent described the deepest state of relaxation ever, 26% were numb throughout their bodies, 15% were cataleptic; and 13% described floating, tingling and feelings of heat. All subjects had previous experience of hypnosis, 84% feeling that mesmerism produced a heavier stronger trance than hypnosis.

McGarry [20] used 45 subjects who were assigned to either hypnotic, mesmeric or control groups. The hypnotic group were played a 25 minute hypnotic relaxation tape, and the mesmeric group were played the tape and received mesmeric passes. The control group relaxed for 25 minutes. Heart rate and EMG recordings were taken one minute after instrumentation was fitted, and after 25 minutes. This work clearly demonstrated the difference between hypnosis and mesmerism (+ hypnosis). The results for the mesmerism group were significantly different ( $p < 0.05$ ) from both the control group and the hypnotic group. Heart rate for hypnosis decreased, and for the mesmerism (+ hypnosis) increased. The EMG results for mesmerism were significantly higher (more relaxed) than that of hypnosis or the control group.

All groups made subjective assessment after the procedures, and the responses were consistent with those of Pulos's [19] study. McGarry [20] speculated on the mechanism for the mesmeric results, including: visual cueing (as a result of the hand passes); telepathic communication; the presence of a low energy field; and the presence of individual magnetic fields. He conducted preliminary research into the existence of a field effect (Mesmer's "fluid"). This consisted of directing mesmeric passes at sterile glass slides coated with a polystyrene and benzol polymer. Tracks and tearing appear on all non-control slides. The outcomes, though interesting, were considered preliminary and inconclusive. Both Pulos [19] and McGarry [20] allude to the need for further work to be conducted in the area of mesmerism.

Having been trained by McGarry, I have informally repeated the work of Pulos [19] with over 200 patients, where I was the mesmeriser. The impressions of the subjects are consistent with the work of Pulos [19] and McGarry (20). For those subjects experienced with hypnosis, they determine that the trance state achieved with mesmeric induction is different and irreproducible with self hypnosis. The work of McGarry [20] with the group of naive subjects who received mesmerism and hypnosis lends support to this observation.

The variety of responses from individual subjects, and from the same subjects following different

sessions is diverse. This consistently diverse response is not found with hypnotic subjects. The elevated heart rate is unique to mesmerism. Other "relaxation" based therapeutic interventions including hypnosis and meditation techniques result in a decreased heart rate, as was evidenced in McGarry's [20] work. Mesmerism appears to be a unique and different physiological and psychological state, when compared to hypnosis. Further investigations are planned, with particular attention being focussed on physiological parameters. Once a more complete description of mesmerism can be provided both physiologically and psychologically, models to explain the observed phenomena will be investigated.

## References

- [1] R J. Chester, *Hypnotism in East and West: Twenty Hypnotic Methods* (Octagon Press, London, 1982).
- [2] D. Waxman, *Hypnosis A Guide for Patients and Practitioners* (George Allen and Unwin, London, 1981).
- [3] L. R Wolberg, *Hypnosis Is It For You?* (Harcourt Bruce Jovanovich, New York, 1972).
- [4] F.A. Völgyesi, *Hypnosis of Man and Animals* (Baillière, Tindall and Cassell, London, 1966).
- [5] W. Gilbert, *De Magnete, Magneticisque Corporibus, et de Magno magnete Tellure; Physiologia Nova, Pluribus Argumentis et Experimentis Demonstrata* (1600).
- [6] F.A. Mesmer, Mémoire sur la Découverte du Magnétisme animal, in G. Bloch, *Mesmerism: A Translation of the Original Scientific and Medical Writings of F.A. Mesmer* (William Kaufmann, Los Altos, California, 1980).
- [7] V. Buranelli, *The Wizard From Vienna* (Peter Owen, London, 1975).
- [8] F.A. Mesmer, *Dissertatio Physico-Medica de Planetarum Influxu* (1776).
- [9] C. D'Eslon, Observations on the two reports of the Commissioners named by the King to investigate animal magnetism, in R.E. Shor and M.T. Orne, eds., *The Nature of Hypnosis* (Holt, Rhinehart and Winston, New York, 1965).
- [10] J. Palfreman, Mesmerism and the English medical profession: a study of conflict, *Ethics in Science and Medicine* Vol. 4 (Pergamon Press, Great Britain, 1977), pp. 51-66.
- [11] M. Schubert, *Medical Mesmerism: Ephemeral Therapy, Ephemeral Metaphor Animal Magnetism in 19<sup>th</sup> Century England*, M.Sc. Thesis (University of NSW, Australia, 1993).
- [12] F.A. Pattie, A brief history of hypnosis, in J.E. Gordon, ed., *Handbook of Clinical and Experimental Hypnosis* (McMillan, New York, 1967).
- [13] J. Esdaile, *Mesmerism In India And Its Practical Applications In Surgery* (Arno Press, New York,

- 1976), facsimile of first edition (Longman, Brown, Green and Longman, London, 1846).
- [14] J.M. Bramwell, *Hypnotism, Its History, Practice and Theory*, Third Edition (William Rider and Son, London, 1913).
- [15] J. Elliotson, The Harveian Oration - English Version, (1846), in F. Kaplan, ed., *John Elliotson On Mesmerism* (Da Capo, 1982).
- [16] J. Braid, *Neurypnology or the Rationale of Nervous Sleep* (Churchill, London, 1843).
- [17] A.E. Waite, ed., *Braid on Hypnotism. The Beginnings of Modern Hypnosis* (Julian Press, New York, 1960).
- [18] W. S. Kroger, *Clinical and Experimental Hypnosis* (Lippincott, Philadelphia, 1973).
- [19] L. Pulos, Mesmerism revisited: The effectiveness of Esdaile's techniques in the production of deep hypnosis and total body hypnoanesthesia, *Am. J. Clin. Hyp.* 22 (1980), pp. 206- 211.
- [20] J. McGarry, Mesmerism vs hypnosis: A comparison of relaxation responses and evaluation of mental and psychophysical outcomes, *Aust. J. Clin. Hypnotherapy & Hypnosis* 8 (1987), pp. 7-36.
- [21] J.C. Ruch, Self hypnosis: the result of heterohypnosis or vice versa?, *Int. J. Clin. Exp. Hyp.* 23 (1975), p. 282.
- [22] R Rose, *The Realities Underlying the Psychiatric Practises and Beliefs of Australian Aborigines* (Rand McNally & Co, New York, 1956).
- [23] O. McGill, *The Mysticism and Magic of India* (A.S. Barnes & Co. Newark, NJ, 1977).

## A MYSTERY OF THE WORLD - WAVE AND PARTICLE AS THE BASIS OF CONSCIOUSNESS

Borislav Šesterikov

Radio Television of Serbia, Takovska 10, Belgrade, Yugoslavia

**Abstract.** Many authors cite Hamlet's words "To be or not to be..." as an existential question. Scott Peck has paraphrased them as "to think or not to think", while Dejan Rakovic and Djuro Koruga have paraphrased them as "biophysics or information physics?" in addition to some philosophers paraphrasing them through the question "Are we not, maybe, moving to a wrong direction, due to the fact that we are firmly convinced in our idea being right, or due to the fact that the local truth of this idea remains imperfect?" In any case, thinking is a process of certain direction and of the flow of time, which may take us to a chosen destination. Sciences, and especially those of theoretical physics: relativistic, quantum, information, biophysics, etc., are using the hypothesis that there is a strong tie between the image of the world realized through our five senses and the objective world. Consciousness is an evolutionary gift to man, realized through the functioning of the five senses and our brain, but, thanks to the local misconceptions, one has to open up to complete creative possibilities as much as possible. Almost undetected, theoretical physics, information physics and biophysics have occupied themselves with the phenomenon of consciousness and together with the two previous revolutionary theories-relativistic and quantum - they have served to the physicists as a reliable guide and a criterion in their building the physical picture of the world. Consciousness, along with the thinking about everything that this term implies, indicates that there is a correspondence between reality and the image of reality, that is, it indicates that although our scientific theories are the products of man's thoughts these ideas may comprise the reality of both outer and inner worlds. To these "yes or no coincidences" I add my contribution on the effect of colored light in forming human consciousness.

**Key words:** *hidden message of light, three-chromatic theory of color and consciousness, three-fold monad of red, green and blue lights and consciousness, psychological approach to consciousness, biological consciousness.*

### 1 A Look at the Past

Man's consciousness is an integral part of the overall terrestrial surroundings but also of the cosmic ones. Since the time when biological consciousness has become an integral part of the psyche, the man-researcher began, in various ways, explaining its origin and purpose.

Nowadays, the Big Bang model is used to explain the universe and many scientific researchers ponder, on its basis, about the question as to why the nature selects only those physical forces and elementary particles that are for some reason needed by it in

creating both the micro and macro universes. In the very first specks of microsecond of Big Bang began the overall creation of the universe, which is today characterized by an enormous abyss ( $10^{44}$ ) between the elementary particles and the clusters of galaxies, and which, after 15 billion years of self-creation in our part of the universe, led also to human consciousness. The primordial event of the time-space universe was characterized by the creation of virtual vacuum, physical vacuum, four natural forces (gravitational, electromagnetic, strong nuclear, weak nuclear), virtual and physical particles (six quarks and six leptons). Micro particles "live" on the whole, only several specks of the one-billionth part of the second, so that they convert and re-create many times over until the stable particles appear, which are the building blocks in the realization of physical matter, atoms and molecules, and, finally, of the entire world.

The expansion of the universe continued, from the moment of Big Bang, throughout 300,000 years in the primordial plasma in which the first atoms of hydrogen and of other heavier atomic structures had been created. In this way, the conditions for emitting electromagnetic radiation of light through the universe at the speed of 300,000 kilometers per second were created. In the meantime, the light-photons-transmitted, most likely, the disguised information needed for "color light display". Big Bang (an awkwardly chosen term) started, in an instant, an exponential expansion of the universe and the evolution continued through the creation of the solar system and the planet Earth, all the way up to the appearance of biological world and biological consciousness.

As the program of evolution of organic matter seem to have unfolded according to a pre-determined scenario, one may pose the question "What was the reason for the nature to convert the physical matter into the biological one; the later giving rise to consciousness?" Answers depend on the person who was asked the question. A theologian would say that it was God who by his thought had created our world in the seven Biblical days, and that excludes any possible experimental proof; a philosopher would say that the cause lies in the anthropological principle, despite the fact that no hidden message has been discovered; a physical chemist would maintain that the riddle of evolution of the matter in the universe should be

looked for in the physical laws; a molecular biologist would claim that the world is of genetic origin; etc., the list would be a long one. However, one of the great modern thinkers, K.G. Jung, asserted that consciousness was individual and that one may also talk about collective consciousness which he termed "archetype".

Man is conditioned through psychic phenomena of unconsciousness to observe the canon of collective regularities. The more the man is aware of his individuality the more the empiric freedom of will, proportional to the increase in consciousness, would be extended. That is to say, an act of will contains energy which is unconditionally necessary in consciousness. Consciousness is a rebuilders of the initial or primary drive picture and various psychic events "are sliding" along the "scale" of consciousness; once they are close to one end of the scale, where one finds drive events, once they are nearing the other end of the scale where human spirit and mind dominate. The will is unable to exercise power over the instinct, for pure instinct has no consciousness. Consciousness in itself must know its aim, that is different from the aim of the function; otherwise one would be able to reduce the will to the instinct. At the lower stage, consciousness resembles an archipelago and it may be imagined as the innumerable small quantities of light. Man's "sliding" consciousness, from a dark side to a bright one, provides a harmonious adaptability and inhibits the primary drive, and that is why it is necessary and it is one that makes the man. K.G. Jung contends, if one were to compare this scale to the scale of the visible light spectrum, that one could say that "the image-symbol of instinct is located at the violet end of the color scale, and that the dynamics of instincts touches the infra-red, and that, as expected, one could say that the mind goes better together with blue than with violet", while stressing that everything deemed to be conscious belongs to "the visible world".

## 2 Perception of Color

The light, comprised of photons with its features of wave and particle, incessantly radiates through the universe. It is almost without a mass and it transmits information through the universe. Quantum radiation-photon always selects the way which carries itself to the final destination at the highest possible speed, and, as such, it has a hidden purpose.

The light is not "seen" - it is done by the sense of sight. The visual system converts light waves of the visible part of the spectrum into corresponding colors, so that one "sees" colored light on the video screen. The living creatures "look at" light waves by using their eyes which are a peripheral part of the brain. The sense of sight is composed of the eyes (optic camera) and of the brain (computer), but the light is seen by the brain (light display). The three-chromatic theory of

color perception has explained the fact that each color may be represented as a mixture of red, green and blue colors. The brain does not accept the color of an object or of light by a simple detection of the wave length of light which it receives. Our visual system is able, in some way, to ignore, through a process of detailed computing, the changes in the wave lengths of light, so that the brain determines the color in a subjective way (part of the primary cerebral cortex - regions V1 and V4), while defining neurophysiological processes to fit human reactions. This has been a new insight in the processing of visual information through two neural currents: one responsible for the high resolution of perception, and other responsible for movement and depth perception. This "discovery" in the visual cortex refers to a fairly new evolutionary contrivance and since the time when the Land's three-color theory was proved in 1985, biologists restated the question "Why is it important for us to see the world in colors".

In the twentieth century, scientific research of the processes regarding consciousness began, so that man is increasingly able to decipher the secrets of operating centers of the living world. In the general cosmic chaos, the inorganic matter realized, in the course of natural physical evolution, a "structure" of self-sustaining living matter and imprinted in it the pattern of a system of self-survival and replication. The nature created human consciousness and it seems that man is on the way of creating some sort of technical consciousness which would enable computers to think. The brain and the psyche are the natural peak of evolution. The popular term of this "mountain in fog" - human psyche - fails to point to its two main features: expressed by computer terms they are hardware and software. The further expected development of computers implies the introduction of multi-meaning memories that satisfy the condition of compatibility termed color memories. Today computer utilized the digital black-white logical of "yes and no", while the evolutionary color processor also biological "maybe" states with "I don't know how much of 'yes' and how much of 'no' ". Since the time immemorial, in this world, man kept asking many questions to which he could not, at given times, find the answers, and precisely this constraint gave the wings to science to decode many natural secrets.

## 3 Possible Road Signs

Up to now, the phenomenon of consciousness has remained the most secretive phenomenon in nature. Man is a part of that nature and since he is endowed by mind and consciousness he proposes various ideas on consciousness. Let us cite some of them. Nobel Prize Laureate Francis Crick contends that perception should be seen as the first step towards consciousness and says: "What I want to know is what is really taking place in my brain when I see something".

Theoretical physicist Roger Penrose supposes that there are "three" interactive worlds: physical, mental and ideational, and the scientific groundwork for the phenomenon of biological consciousness should be found on the basis of electromagnetic and gravitational quantum phenomena in the biomolecular systems. The two scientific authorities concerning the consciousness question are Belgrade professors Dj. Koruga and D. Raković. Koruga's hypothesis, while acknowledging the problem of "what is taking place when I see something" adds the question as to "why do we see the physical world as a tree-dimensional one?" In addition, while accepting Penrose's idea about the tree interactive worlds and the 3D phenomena from the point of view of information physics, Koruga proposed a model of fractal mechanics of the  $N = 0$  dimension whose single-unit sphere is physical consciousness, that is, consciousness in itself. Raković's hypothesis concerns the modeling of consciousness; according to his model "consciousness is a subtle inner display in the form of EM component of ULF brainwaves characterized by an incessant coding of information coming from the brain's neural networks, through the physical mechanism of EM induction. Let us also mention the opinion of R. Linas that the brain has succeeded in simultaneous transmitting and processing sense information, which, similar to the coded time beam (like the primary radar), "overflow in waves the cortex and hypothalamus, realizing in that way the images (display) in the brain" and that the secret of consciousness lies in communication. Finally, M. Rakočević contends that the universal code of nature is the starting point of consciousness, and some authors believe that it is music that is the basis of consciousness, etc.

#### 4 Conclusion

Nowadays, there are many secrets that we do not understand, one of them being consciousness. Probably, the coming generations will find the answers that constantly elude us, and instead of black and white answers will offer compatible color answers.

The term "color" has a manifold importance. In quantum chromodynamics (three-quark colored configurations), the three "colors" red, green and blue - insure that electric charge is not a full - number one (u-quark +2/3 and d-quark -1/3, and not -1 as is the case in electrons). In quantum electromagnetism, in the structure of electric charge, the role is played by photons, and they participate in colored light (rainbow). In the color display (television), the three primary lights (red, green, blue) were the basis of inventing the color screen. As the three color nature monad of colored light - "holy" trinity - has in time evolved into the consciousness entity, I propose that

the question "what was the reason for the nature to make us see the world in color through the three primary lights: red, green and blue?" be added to the already mentioned various approaches to the origin of consciousness. This approach via colored lights, that are seen by the brain, is presumably an extension of Ariadne's thread, that is, it supposes that consciousness should be found in the very origin of the universe (when electromagnetic waves were created). The evolutionary process of creating the psyche of living being and its light display has enabled the first hominoids to start going along a path of the evolution of consciousness, leading to, as a result, the separation of biological consciousness from the unconscious part of the psyche.

#### References

- [1] F. Crick, *The Astonishing Hypothesis. The Scientific Search for Soul* (Charles Scribner's Sons, New York, and Maxwell Macmillan Interantional, 1994).
- [2] H. Fritzsich, *Quarks-Urstoff Unserer Welt* (R.Piper Co. Verlag, München, 1981).
- [3] E. Guillé, *L'Alchimie de la Vie* (Edition de Rocher, 1983).
- [4] C.G. Jung, *Gessammelte Werke* (Walter Verlag AG, Olten, 1971)
- [5] C.G. Jung, *Man and his Symbols* (Dell. Pub., New York, 1972).
- [6] Dj. Koruga, Information Physics: In Search of a Scientific Basis of Consciousness, in D. Raković and Dj. Koruga, eds., *Consciousness: Scientific Challenge of the 21<sup>st</sup> Century* (ECPD Belgrade, 1995), pp.243-261.
- [7] R. Penrose, *Shadows of the Mind, A Search for the Missing Science of Consciousness* (Oxford Univ., Oxford, 1994).
- [8] D. Raković, Brainwaves, Neural Networks and Ionic Structures: Biophysical Model for Altered States of Consciousness, in D. Raković and Đ. Koruga, eds., *Consciousness: Scientific Challenge of the 21<sup>st</sup> Century* (ECPD Belgrade, 1995) (ECPD, Belgrade, 1995), pp.291-316.
- [9] D. Raković, *Osnovi Biofizike* (Grosknjiga, Beograd, 1995), in Serbian.
- [10] M. Rakočević, The Universal Consciousness, and the Universal Code, in D. Raković and Dj. Koruga, eds., *Consciousness: Scientific Challenge of the 21<sup>st</sup> Century* (ECPD Belgrade, 1995) (ECPD, Belgrade, 1995), pp.262-280.
- [11] B. Šesterikov and Z. Manojlović, *Color Television* (Tehnička knjiga, Beograd, 1988), in Serbian.

## EEG CORRELATES OF MUSICOGENIC STATES OF CONSCIOUSNESS

Lazar Škarić<sup>1</sup>, Milorad Tomašević<sup>2</sup>, Dejan Raković<sup>1,3</sup>, Emil Jovanov<sup>1,4</sup>, Vlada Radivojević<sup>5</sup>,  
Predrag Šuković<sup>1</sup>, Marko Car<sup>6</sup>, and Dejan Radenović<sup>1</sup>

<sup>1</sup>Faculty of Electrical Engineering, PO Box 35-54, 11120 Belgrade, Yugoslavia

<sup>2</sup>"Vinča" Institute of Nuclear Sciences, Belgrade, Yugoslavia

<sup>3</sup>European Centre for Peace and Development (ECPD) of the United Nations University for Peace,  
Terazije 41, Belgrade, Yugoslavia

<sup>4</sup>Institute "M. Pupin", Computer Systems Department, Volgina 15, Belgrade, Yugoslavia

<sup>5</sup>Institute for Mental Health, Dept. of Clin. Neurophysiology, Palmotićeveva 37, Belgrade, Yugoslavia

<sup>6</sup>Institute for Biological Research, Center for Multidisciplinary Studies,  
29. Novembra 142, Belgrade, Yugoslavia

*Why do we like music? We all are reluctant, in music and art, to examine our sources of pleasure and strength. In part we fear success itself - that Understanding might spoil Enjoyment. And rightly so; Art often loses power when its psychological roots are exposed. No matter: when this happens we will go on, as always to seek more robust illusions!*

(Marvin Minsky)

**Abstract.** The study of the perception of music is a paramount example of multidisciplinary research. In spite of a lot of theoretical and experimental efforts to understand the musical processing, attempts to localize musical abilities in particular brain regions were largely unsuccessful, save for the difference between musicians and non musicians, especially in hemispheric specialization and in EEG correlational dimensions. Having in mind that human emotional response to music (and to art in general!) is limbic dependent, this motivated us to address our question to similar possible neurobiological origin of musicogenic altered states of consciousness and its possible EEG correlates, "resonantly" induced by deep spiritual music, like in sound-induced altered states of consciousness cultivated in some Eastern yogic practices. The musicogenic states of consciousness are evaluated within a group of 6 adults, upon the influence of 4 types of spiritual music. The most prominent changes in theta or alpha frequency bands were induced in two subjects, upon the influence of Indian spiritual music, Bhajan.

**Key words:** EEG, consciousness, musicogenic states of consciousness, altered states of consciousness, spectral analysis, coherence.

### 1 Introduction

The study of the perception of music is a paramount example of multidisciplinary research, in which musicians, psychologists, neurobiologists, physicists, and engineers must communicate and work together. This study comprises three broad problem areas [1]: (a) perception of musical tones; (b) interpretation of acoustical information relevant to

music; and (c) emotional response to musical messages. In the past two decades, a considerable mutual integration of these three problem areas has taken place, due to the progress in the understanding of general human brain functions, and the recognition that in the conscious state even the simplest perceptual events are bound to trigger operations that involve the brain as a whole.

The human brain does not appear to contain many new or drastically different processing centers when compared with the brains of any of our primate ancestors - save for cerebral hemisphere specialization, which is the basic evolutionary novelty of the human brain. This specialization is related to two quite different operational modes: one mode involves sequential analysis of single-channel information (such as required in language, speech, and thought processing, characteristic of the "dominant" hemisphere, the left one in about 97% of the subjects - the right-handed ones), and the other involves synthesis of many different parallel channels to accomplish the holistic determination of input stimuli (characteristic of the "minor" hemisphere).

Along these lines it has been proposed that music is a language-like form by which humans express themselves and communicate with each other [2]. This analogy would then suggest that processing of musical indicants (such as melody and harmony) are predominantly "minor" hemisphere related, and that processing of musical symbols (such as hierarchically

arranged phase structures) predominantly involves the "dominant" hemisphere; further, semantic processing of both musical indicants and symbols should be related to the posterior cortical convexity, pragmatic processing of user's musical experience and expression should be related to the frontolimbic cortical formations, while syntactic processing of arrangement of indicants and symbols should be related to the motor system of the brain, to which both posterior and frontal cortical formations project. However, it should be pointed out that syntactic structure of music might be more dependent on semantic processing. In spite of a lot of theoretical and experimental efforts to relate the music and language processing [2-5], attempts to localize musical abilities in particular brain regions were largely unsuccessful (both by electroencephalography [6] and positron emission tomography [7]), save for the difference between musicians (or musically talented subjects) and non-musicians: (a) the processing of single musical notes and melodic line is represented in "minor" hemisphere when presented to musically less sophisticated subjects, while being equally well represented in both hemispheres of more sophisticated subjects [8]; and (b) less sophisticated subjects responded with a drop in brainwave complexity to rhythmical weakly chaotic music, while more sophisticated subjects showed higher EEG correlational dimensions [9]. It should be also added that neuroendocrinological measurements revealed a specific pattern of sexual hormones (increased testosterone in females; decreased in males) in composers and highly talented adolescents [10].

It should be also pointed out that one of the most profound consequences of the evolution of human brain functions (and human consciousness itself!) has been the emergence of systematic postponing of behavioral goals and rearrangement of behavioral priorities. This led to conflicts between cortical functions and those of the limbic system: while in animals the limbic system is mostly activated by environmental and somatic input, in humans it can also respond to internally evoked images displayed on the cortex during the process of thinking. As motivation and emotion are integral manifestations of limbic function (assuring that all cortical processes are carried out so as to be of maximum benefit to the organism, through the extended reticular-thalamic activating system [11]), in humans they can be triggered with no relationship to the current state of the environment. It is along this line that we should seek a lead toward understanding the human emotional response to music (and to art in general!), when the messages therein seem to be of no obvious survival value [1].

This motivated us to address our question to similar possible neurobiological origin of musicogenic altered states of consciousness, induced by deep

spiritual music of different cultures [12], and its possible EEG correlates. The analogous more frequently used physical mechanism for sound-induced altered states of consciousness is an introspective repeating of a certain type of sound or "mantra", which is chosen so as to "resonate" with the structure of an individual nervous system [13]. The sound resonances within the human lobe would be then achieved through a formation of standing sound waves, with principal harmonic (of ~ 1000 Hz) having its maximal amplitude in the centre of the lobe cavity, i.e. around the region of limbic system - therefore inducing the local stimulation of thalamic formation through some mechano-chemical receptors (to be still specified therein).

## 2 Method

*SUBJECTS* - The study was carried out on 6 healthy adult volunteers. There were one male and five females, whose ages ranged from 18 to 29 years with a mean age of 25 years. All subjects were free of any medication. Prior to the experiment subjects were informed verbally about all aspects of the experimental procedure.

*MUSIC* - Four types of spiritual music were provided to the subjects during experiments: (1) Indian Bhajan in Sanskrit, (2) Byzantine Pasha Liturgy in Greek, (3) Maronite Song in Arabian, and (4) Mozart's Requiem in Latin.

*APPARATUS* - Electroencephalographs were recorded in an electromagnetically shielded room by a MEDELEC 1A97 EEG machine, with lower and upper band-pass filter limits set at 0.5 Hz and 30 Hz, respectively. Ag/AgCl electrodes with impedance less than 5 k $\Omega$  were placed at 16 locations (F7, F8, T3, T4, T5, T6, Fp1, Fp2, F3, F4, C3, C4, P3, P4, O1, O2) according to the International 10-20 system with average reference. The EEG outputs were digitized with 12-bit precision at a sampling rate of 128 Hz per channel using A/D converter Data Translation 2801.

*PROCEDURE* - The experiment was conducted in a sound-proof room, with only one music piece a day. Each recording session was divided into three sequential periods:

- (1) Relaxing 5 min with eyes closed;
- (2) Listening of the music 10 min; and
- (3) After listening, 5 min.

During those periods three samples, one minute each, were recorded for every subject. The EEG record was stored on a hard-disk.

*DATA ANALYSIS* - The length of each EEG-trace was 60 s (7680 points). Time-varying EEG spectra (spectrograms) with 0.5 Hz resolution were calculated by the MATLAB program using a 256-point FFT algorithm performed on 2 s Hamming-windowed, half-overlapped epochs. An array of EEG partial power spectra for each subject and each derivation

was computed by integration by the trapezoidal rule of the spectrogram over the three frequency bands:  $\theta$  (from 4 to 8 Hz),  $\alpha$  (from 8 to 13 Hz), and  $\beta_1$  (13 to 18 Hz). The Wilcoxon matched pairs test and Mann-Whitney U-test were used to determine significant differences between the spectral arrays of the relaxing period and the spectral arrays of the meditation period. The coherence of spectral arrays was estimated using Welch's averaged periodogram method at 512-point (4 s) epochs of EEG data divided into 256-point (2 s) detrended Hamming-windowed subsets with 240-point overlap. Total coherence for the each frequency band was calculated using the same methods as those described by Levine et al. [14].

### 3 Results

In Table 1 the results of the Wilcoxon matched pairs test for medians of EEG power of all 16 channels, prior and during the listening of music.

In most cases, during the listening of music, the EEG power decrease is observed in various frequency bands. In three cases (out of 20), a significant power increase in theta and alpha bands is registered, in accordance with an intense aesthetic experience in these cases; the two most prominent spectrograms and corresponding diagrams of the temporal changes of spectral power are shown in Figs. 1 and 2.

**Table 1.** The EEG power changes during the listening of music.

MUSIC	SUBJECT 1			SUBJECT 2			SUBJECT 3			SUBJECT 4			SUBJECT 5			SUBJECT 6		
	BAND			BAND			BAND			BAND			BAND			BAND		
	$\theta$	$\alpha$	$\beta_1$	$\theta$	$\alpha$	$\beta_1$	$\theta$	$\alpha$	$\beta_1$	$\theta$	$\alpha$	$\beta_1$	$\theta$	$\alpha$	$\beta_1$	$\theta$	$\alpha$	$\beta_1$
1	-	-	0	0	-	0	-	+	0	+	-	0	-	-	-	0	-	-
2	0	-	-	-	-	-	-	-	-	0	0	0	-	-	-	x	x	x
3	x	x	x	+	+	-	-	-	-	0	-	0	0	-	-	-	-	-
4	0	-	-	0	-	-	-	-	-	x	x	x	0	-	0	x	x	x

+ sign. increase, - sign. decrease, 0 no sign. changes, x not recorded

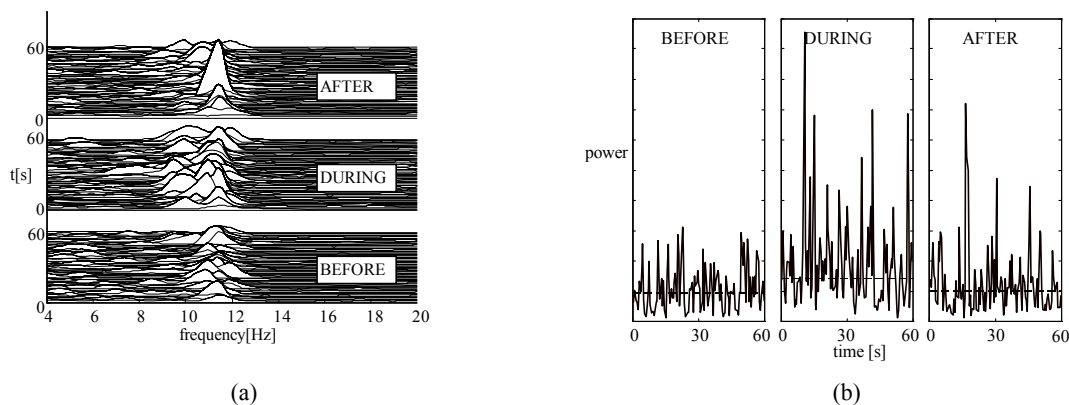

**Figure 1.** (a) The spectrogram with the observed EEG power increase in the alpha band and the appearance of slower alpha frequencies during the listening of music 1 in channel P3 of subject 3; (b) The corresponding temporal power changes in the alpha band.

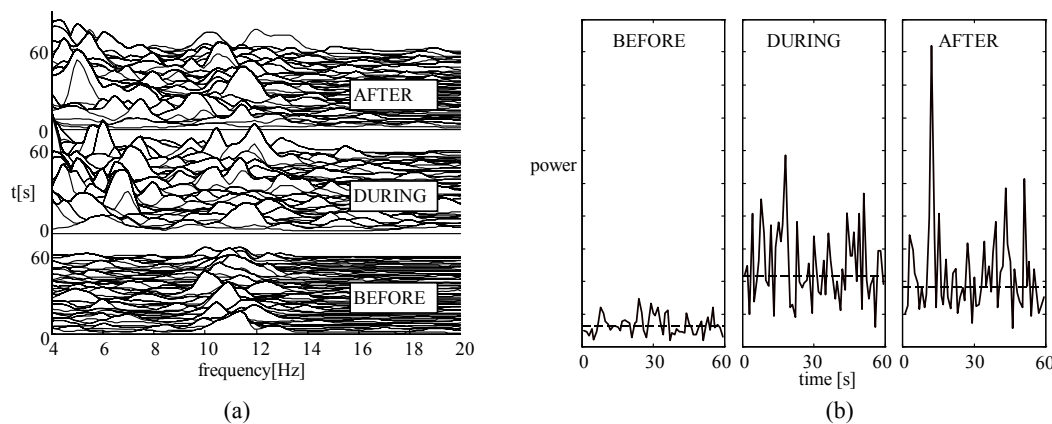

**Figure 2.** (a) The spectrogram with the observed high EEG power increase in the theta band during the listening of music 1 in channel T6 of subject 4; (b) The corresponding temporal power changes in the theta band



**Table 2.** The EEG coherence changes during the listening of music.

MUSIC CHANNEL S	SUBJECT 1			SUBJECT 2			SUBJECT 3			SUBJECT 4			SUBJECT 5			SUBJECT 6			
	BAND			BAND			BAND			BAND			BAND			BAND			
	$\theta$	$\alpha$	$\beta_1$	$\theta$	$\alpha$	$\beta_1$	$\theta$	$\alpha$	$\beta_1$	$\theta$	$\alpha$	$\beta_1$	$\theta$	$\alpha$	$\beta_1$	$\theta$	$\alpha$	$\beta_1$	
1	F3-C3	0	0	-	0	0	0	0	0	+	-	0	0	0	0	0	0	0	
	F4-C4	0	-	0	0	0	0	0	0	-	-	-	-	-	+	0	+	0	
	F3-F4	0	0	0	0	0	0	0	0	0	-	0	-	-	+	0	-	0	
	O1-O2	0	0	0	0	0	0	0	0	0	-	0	-	0	0	+	+	0	
2	F3-C3	0	0	0	-	0	0	0	0	+	0	0	0	0	0	0	x	x	x
	F4-C4	0	0	0	0	0	0	0	0	+	0	0	0	0	0	0	x	x	x
	F3-F4	0	0	0	+	0	0	0	0	+	0	0	+	0	0	0	x	x	x
	O1-O2	0	0	0	0	0	0	0	0	+	0	0	-	0	0	0	x	x	x
3	F3-C3	x	x	x	0	0	-	0	0	-	0	0	0	0	0	0	0	0	0
	F4-C4	x	x	x	0	0	-	0	0	0	0	-	0	0	+	0	+	0	
	F3-F4	x	x	x	0	0	0	0	0	0	0	0	-	0	0	0	+	0	
	O1-O2	x	x	x	0	0	0	0	+	0	0	0	+	0	0	0	0	0	
4	F3-C3	0	0	0	0	0	-	0	+	0	x	x	x	-	-	0	x	x	x
	F4-C4	0	0	0	0	-	0	0	+	0	x	x	x	0	0	0	x	x	x
	F3-F4	0	0	0	0	0	0	0	0	0	x	x	x	-	0	+	x	x	x
	O1-O2	0	+	0	0	0	0	0	+	0	x	x	x	+	0	0	x	x	x

+ sign. decrease, - sign. decrease, 0 no sign. changes, x not recorded

In Table 2 the results of Mann-Whitney U-test for temporal arrays of the mean coherences of corresponding pairs of EEG channels are presented. It seems that changes in the coherence during the listening of music are not correlated with the aesthetic experiences. This might be a consequence of the observed increase in the mean ratio of EEG power of the right and the left hemispheres, the corresponding medians for all channels, and all subjects being  $R/L=1.015$  prior the music, and  $R/L=1.082$  during the listening of music. This fact is indicative although the Wilcoxon matched pairs test did not give significant changes ( $p=0.09$ ).

#### 4 Conclusion

According to our pilot study with six subjects and four types of spiritual music, it might be concluded that the EEG power changes during their listening are quite individual. In the three cases where significant raise of power (i.e. relaxation) in theta and alpha bands is observed, the subjects have described their musical experiences as very pleasant - in contrast to the cases with drop in EEG power and unpleasant musical experiences. The most prominent changes were observed in subjects 3 and 4 upon the influence of the music 1 (Bhajan, Indian spiritual music, sung in Sanskrit); and somewhat less in subject 2 upon the influence of the music 3 (the Maronite spiritual music, sung in Arabian). Concerning the coherence increase, it seems not to be correlated with the aesthetic experience as, for instance, all subjects described their experience of music 2 as "slightly unpleasant", while their coherence was even increased.

In spite of the observed particular EEG changes upon some types of spiritual music, it might be that more conclusive results could be achieved only in the case of more careful choice of subjects, regarding their musical affinities and/or education.

#### 5 Prologue

OHM, this eternal presound is everything - that which ever was, is and shall always be, a world beyond end. Even before wine was created, we had been inebriated of it to nescience close an intoxication. Taste it again, for today you know neither whence you come nor whither you go. Infuse yourselves with that self-enlightened potion everlastingly present in everyone's heart. Together let us deeply drink of it in bowls unstained with gall.

Lazar<sup>a</sup> exclaims: "Where are such bowls to be found?"

#### References

- [1] J.G. Roederer, Physical and neuropsychological foundations of music: The basic questions, in M. Clynes, ed., *Music, Mind, and Brain: The Neuropsychology of Music* (Plenum, New York, 1982), and references therein.
- [2] K.H. Pribram, Brain mechanism in music: Prolegomena for a theory of the meaning of meaning, in M. Clynes, ed., *Music, Mind, and Brain: The Neuropsychology of Music* (Plenum, New York, 1982), and references therein.
- [3] L. Bernstein, *The Unanswered Question: Six Talks at Harvard* (Harvard Univ., Cambridge, MA, 1976).
- [4] R. Jackendoff and F. Lerdahl, Grammatical parallel between music and language, in M. Clynes, ed., *Music, Mind, and Brain: The Neuropsychology of Music* (Plenum, New York, 1982), and references therein.

<sup>a</sup> This work presents a part of B. Sc. Thesis of Mr. Lazar Škarić at the Faculty of Electrical Engineering in Belgrade, Yugoslavia, under supervision of Prof. Dejan Raković. Mr. Lazar Škarić has been mysteriously missing since 2 April 1997, and we would be grateful to anyone who can provide any useful information about him.

- [5] N. Chomsky, *Rules and Representations* (Columbia Univ., New York, 1980).
- [6] H. Petsche, K. Lindner, P. Rappelsberger, and G. Gruber, The EEG: an adequate method to concrete brain process elicited by music, *Music Perception* 6 (1988), pp. 133-160.
- [7] S. Sergent, Mapping the musician brain, *Human Brain Mapping* 1 (1993) pp. 20-39.
- [8] Deutsch & Deutsch, in Ref. [9].
- [9] N. Birbaumer, W. Lutzenberger, H. Tau, G. Mayer-Kress, and C. Braun, Perception of music and dimensional complexity of Brain activity, *Int. J. Bifurc. & Chaos*, in press, also <http://www.ccsr.uiuc.edu/~gmk/Papers/MusicEEG>.
- [10] M. Hassler and N. Birbaumer, Handedness, music abilities, and dichaptic and dichotic performance in adolescents: a longitudinal study, *Development Neuropsychology* 4 (1988) pp. 129-145.
- [11] B.J. Baars, *A Cognitive Theory of Consciousness* (Cambridge Univ., Cambridge, MA, 1988).
- [12] G. Rouget, *La Musique et la Transe*, (Gallimard, Paris, 1980).
- [13] T. Nader, *Human Physiology: Expression of Veda and the Vedic Literature* (Maharishi, Vedic Univ., Vlodrop, The Netherlands, 1995).
- [14] H. Levine, J. R. Hebert, C. T. Haynes, and U. Strobel, EEG coherence during the Transcendental Meditation technique, in D. W. Orme-Johnson and J. T. Farrow, eds., *Scientific Research of the Transcendental Meditation Program - Collected Papers*, Vol. 1 (MERU Press, Seelisberg, Switzerland, 1977), pp. 187-207.

## PALEOGLOSSOLOGY OF THE BALKANS: BECOMING CONSCIOUS OF NAMES

Antonije Škokljev<sup>1</sup> and Ivan Škokljev<sup>2</sup>

<sup>1</sup>European Centre for Peace and Development, Belgrade, Yugoslavia

<sup>2</sup>Faculty of Electrical Engineering, PO Box 35-54, Belgrade, Yugoslavia

e-mail: skokljev@buef31.etf.bg.ac.yu

**Abstract.** Linguistic investigations of onomastics of the middle Danube region in Serbia reported in this paper, discover the existence of certain linguistic substratum from paleoglossology. The findings are related to the whole of Balkan peninsula and therefore the name: paleoglossology of the Balkans (POB). The sources for the investigations are historical, mythological, religious and linguistic data hidden in hydronyms, oronyms and horonyms of the region, supported by some recent archeological findings (Lepenski Vir). The POB method is verified by parallel analyzing of geographical names with an insight into the ancient mythology of the Balkans. It is evident that onomastics as presented in this paper, symbolically personifies Olympic gods and their fights for power and leadership (cosmogony and theogony), as we know it from the works of Hesiod. The daring hypothesis of this paper that the middle Danube region is the cradle of ancient mythology and that ancient gods were born on this soil. This conclusion is supported by lists of names associated with myths, all of them pinpointing the middle Danube region as the stage of the aforementioned events. In the course of investigations concerning the activities of mind, the application of the POB method suggests that traces of the past live written in names which hold the pieces of information important for the research into the human archaic consciousness and subconscious.

**Key words:** *mind, language, archetype, collective subconscious, onomastics, theogony.*

### 1 Introduction

The founder of contemporary anthropological explorations of latent psychological contents Sigmund Freud (1856 - 1939) and the founder of the complex psychology and one of the most significant psychoanalysts of human mind Carl Gustav Jung (1875 - 1961) set the stage for the theory of psychoanalysis of dreams, revealed the contents of subconscious, and further on postulated the principles of the theory of archetypes and the mass-unconsciousness. Freud's methods of analysis and deciphering of unconscious in the fields of human culture, behavior, myths, religion and arts became the basis of psychoanalytical anthropology, philosophy and the theory of creativity. Jung's idea of the existence of collective unconsciousness, the deepest and the darkest prehistoric spaces of human psyche

makes the universal ground of the whole human personality. Jung finds that the collective unconsciousness contains the spiritual experience of immense number of preceding generations encrusted into the brain structure. The building blocks of unconsciousness are archetypes representing the inherited images. Archetypes are general and congenital frames of the whole human experience expressing themselves in the form of emotional, symbolic images and pictures in myths, legends, dreams, religious rites and so on.

In the course of the activities reported here, the theories of Freud and Jung are only taken as a direction and entities to postulate an original and different model of the archetype building unit. The purpose of this paper is to propose the paleobalcanic glossology of Serbia as a new and simple paradigm of collective unconscious. The paper initiates further multidisciplinary investigations of our heritage on the soil which is one of the oldest in Europe.

### 2 Hypothesis, Aim, and Method

Language and writing are the most significant tools of human mind retaining the traces of history and historical changes, known as well as unknown. Glossology (Webster Comprehensive Dictionary) is the science of language, the comparative philology. Paleoglossology connotes old, ancient languages, mostly extinct, leaving traces in the names of places and things in contemporary use. This paper advocates one daring hypothesis and to be brave to the end, names the field of research: paleoglossology of the Balkans. The hypothesis is based on premises that one common language was spoken in Neolithic Europe which lasted until the appearance of civilization in Europe or, until the historical era. Our aim is to attempt to decipher some names domesticated on the Balkan peninsula by using the language called the ancient Greek, one of the *dead languages*, the milestones of civilization. It is interesting to our findings that ancient Greek is present in modern Greek mainly by onomastics of the Balkan geography. But this onomastics is common to many of the Balkan

states, to Serbia, Montenegro, Hungary, Albania, Bosnia, Croatia, Romania, Bulgaria, Macedonia and Greece. This paper treats only the first two of the aforementioned countries. This fact pushes away all nationalisms as petty talk.

One of the major findings in genetics related to the origin of mankind (Cavalli-Sforza, 1991) is that the distribution of genes correlates surprisingly well with that of languages. Cavalli-Sforza notifies that "...we concluded that, in certain cases, a language or family of languages can serve to identify a genetic population". The purpose of this investigation is to allocate the language to the land without confabulating about that what has happened to the people. They have hardly vanished, the melting-pot theory has probably more chances to succeed.

The common denominator of a nation in modern sense is the common language. We do not have the nation here, but we do have the language. The elements of the presumed common language made the substance of languages derived, spoken by similar peoples or tribes mentioned in Herodotus, the Father of history: those were Pelasgs, Boreans, Hyperboreans, Misans, Ionians, Briggs and many others inhabiting of the Balkans.

The methodology used in this research is based on etymology of the ancient Greek. Ancient Greek has little if any similarity to modern Greek language. Greek is only the common name for these two languages. The question arises: could they be the same people?

The methodology makes use of the ancient Greek scientific etymology, i.e. the scientific translation of phonetic and symasiologic development of words, or onomastic approach (onomastics = the study of the origin and evolution of proper names). The tools to ease the endeavor are also the historical-parallel glossology and paronymology, i.e. the folk etymology of ancient language, used by Greek linguists.

Here are some examples:

-Anthroponym: *Athens* (Αθηνα / athena/, Αθανα /aθana/) the name of the goddess and town is made of Α-without and θανατος / thanatos / - death, i.e. the immortal one.

-Hydronym: *sea* (θαλασσα / thalasa /) is made of θα /θα /, θω /θο / - to run and αλας / alas / -salty.

-Oronym: Olympus (Ολυμπος / olimpos/) is made of ολοι /oloi/ - everybody and υμνος /imnos/ -hymn and ποιησω /poeso/ - to make, i.e. much sung about.

Graphical elements of research were different traditional symbols found in cultures of the middle Danube. Archeological findings in Djerdap (Iron Gate) and traditional and mythological tales from the world of gods and heroes and concerning Boreans and Hyperboreans are also included to form the additional building units made of archetypes.

### 3 Scanning through Evidence: Archeological Evidence in Serbia

Recent discoveries in the middle Danube valleys and gorges (Lepenski Vir, Starčevo, Vinča, Banjica) underwent the radioactive isotope C-14 treatment which proved them to be the oldest cultures in Europe. These dwellings (cca. 8000 to 5500 BC) shone out the civilisation to the whole of Balkans (Renfrew, 1978; Gimbutas, 1982; Srejić & Babović, 1983). The insight into the evidence of these discoveries enables the overcoming of historical limitations and prejudices and connote the descent to the Jung's cellar.

### 4 Onomastics in Serbia as a Source of Paleoglossology of Balkans

The rich and multilayered onomastics of Southern and Northern Balkans, reaching from the river Danube to the island of Crete was treated by the POB method (POB = Paleoglossology of the Balkans). The onomastics encompasses hydronyms, toponyms, oronyms, horonyms, anthroponyms, fytonyms, symbols, religion, myths, literature, art and so on.

### 5 Myth as a Source

Myth, i.e. a tale, contains a story about the origin of the universe (cosmogony), of the gods (theogony), of mankind and of all of the nature.

Hellenistic mythology as known to westerners (Graves) was a traditional mythology common to all of the peoples inhabiting the Balkan peninsula. These peoples were of indoeuropean origin.

Homer and Hesiod collected these myths in their works. The myths registered could well be named the models of archetypes, to associate them to the model of Jung.

The origin of myths, and this is a daring hypothesis of the paper, could be allocated to Djerdap region in Serbia. In the twilight of the Ice Age these lands were the battlefields and cradles of Gigantomachias and Titanomachias.

### 6 Historical Facts

The basic historical facts of peoples and their customs on the Balkans are found with many authors from antiquity, from Pindar (522 - 446 BC), Herodotus (484 - 425 BC), Pausania (2. c. AC) until the most recent ones like Thomson (1954), Vasić, (1958), Budimir (1969), Papastavrou (1972) and others.

### 7 Onomastics

The hypothesis of a unique and common paleoglossological substance of Balkan peoples and above all Hellens is not new. The hypothesis was

stated by Kretschmer, 1982, Schachermeyer, 1964, Mpampiniotis, 1986. Homer and Herodotus stated that the natives: Pelasgs, Ionians, Carans, Critians, Pelagonians, Boreans and Hyperboreans spoke a language incomprehensible for Hellens. In literature this language was pinpointed as the paleobalcanic or pelasgian language (Thomson, 1954; Škokljev & Škokljev, 1996).

## 8 Onomastics of Southern Balkans

Research encompassing Greece and Macedonia (Škokljev & Škokljev, 1996) revealed that Pelasgian substance of Greek make the suffices *-amos*, *-nthos*, *ssos*, *-ssa*, *-mnos*, *-mna*, *-ndos*, *-aki*, *-akos* (toponymes), *-evs* (anthroponyms, like Ahillevs, Atrivs, Nilevs). All horonyms of Aegean's, of continental Helada and Macedonia are of Pelasgian origin. The names of gods, like Zevs, Apollon, Artemis, Athena, Afroditi, Ermis, Ifestos, Promithevs, Demetra and others, came from Pelasgs. The names of mountains (oronyms), like Olympos, Pindos, Tomoros, Parnassos, Kifissos and many more came from ancient Pelasgs.

## 9 Onomastics of Serbia

Many words in Serbian which could not be derived from Slavic roots were considered of Celtic origin (hydronyms, oronyms, horonyms). However, these words could be explained by POB method. Here are some examples.

*Danube or Danoubius*. Composite word made of Dios or Zeus (Διος /dios/, Ζευς /zeus/) whose bucolic form is Dan or Zan (Δαν /dan/, Ζαν /zan/), all from the same root di, dios (διος) meaning "shining" or "heavenly shine". Zeus is a son of Cronos and Rhea, the king of gods and peoples, and the origin of all natural events. The genitive of Dan (Δαν) is Danou (Δανου) while "bivus" came from "vivos" (βίος), human life. According to Herodotus, the upper part of the river was called Danouvios (Δανουβίος) and the lower part Istros. Istros is also composed of "istia" or "estia", (ιστία, εστία) meaning hearth, to welcome and nurture somebody. Word "reo, ri" (in Latin, "rivus") is river (ρεω, ροος, ρους) with the suffix *-os*. Danoubius is the river of Zeus, the river of the creator.

## 10 Left Tributaries of the Middle Danube

*Tisa* (Θυσσος /thissos/) is one of the nymphs (fairies) that baby-sitted small Zeus for Rhea. Nymphs are immortal and closely related to water. In mythology, they are the daughters of the Ocean or the rivers.

*Tamiš or Temis* (Θεμις /themis/) is one of Titans, the second wife of Zeus, the mother of Moira (Μοίρα) and Hora (Ωραι) the godlike creatures that

conduct the destinies and change of seasons. In Romania, Tamiš is Temis with the city of Temisoara.

*Nera* (Νηρεϊς /nerevs/) is the sea god, son of Pont and Gea (Γαϊα). Dorida gave him fifty daughters, Nereids (Νηρηϊδες /nereides/). They live in the sea depths and caves.

*Sirina* (Σειρηνας /sirenes/). In mythology, Sirens were beautiful girls, later, demonic creatures, capable of simmering the wind and the sea down with their song and of enchanting the sailors.

*Iešelnita* (Ιησις /iesis/, Ιασις /iasis/ = to cure) is the river near the town Orsova.

## 11 Right Tributaries of the Middle Danube

Suffix *-ava* (αυ = again, while = to dry out, or αβια, ηβη = youth, strength, but also the name of goddess Heba, Ηβη, the daughter of Zeus and Here, the maid of gods and the goddess of youth) is common to these flows. Let us examine the names of the right tributaries of the middle Danube.

*Drava* is the first of the larger middle Danube tributaries (δρα, δραω = to serve).

*Sava* (σα, σως = strong, safe). Sabasius (Σαβαζιος) is Thracian-Frigian god like Dionis.

*Drina* (δρυς /drys/ = tree, oak tree) is a personification of a forest nymph Driad (Δρυας /drias/) who lived and died in the oak-tree. The oak-tree was devoted to Zeus. Δρυας was often used name for Thracian and tessalian mythological heroes. The tributary of Drina is *Piva* (πιδας /pidas/ = spring), Tara (ταρα = to disturb, disturbed, or θαρρος /tharos/, θαρρεω /thareo/ = daring, brave, reliable), *Čekotina* (κηκίς /kekis/ = spring, well) and *Lim* (λυ /li/, λυμα /lima/ = to rage, to destroy, to do evil).

*Morava* (*mor*, Indo-European root: *mori*, Serbian: *more*, Latin: *mare*, German: *Meer*; and *-ava*) is the next bigger Danube tributary. Another association with this name is the larger combat unit of Nereides. Its main tributaries are *Resava* (ρως /ros/, ρησσω /reso/ = to pierce, to rampage, to brake), *Ibar* (Υβρις /ibris/ = mad, furious, berserk) and *Nišava* (νυσσα /nissa/ = to push). In mythology, Nissa (Νυσσα) is the wholly forest hill in Thrace, where nymphs brought up god Dionis (Διονυσσος /dionissos/), the son of Zeus from Nissa (the town Niš on the Nišava in Serbia?).

Mlava is near Morava and with Danube make the triangle of the valley *Stig* with the city of Požarevac. *Stig* (Στυξ /stiks/ = hated, terrifying, disgusting) and Stiga, mythological nymph, one of the rivers of the underworld, lost river taking souls of dead to Had. She is the oldest of three thousand daughters of Ocean and Tetis (Τητις /tehis/). Stiga was first to help Zeus fighting Titans. Grateful, Zeus rewarded her with the honor to "baptize" other gods in her waters: gods

administered oaths to Zeus in her waters. Stiga, Zeus being the father, gave birth to Persephone, the queen of the underworld. The myth says that Stiga lives far away from gods, and that her castles in the underworld have silvery columns reaching for the sky. These castles are the caves of Homolje in Serbia, Ceremošnja, Zlotska (1070 m), Sokolica, Dubočka and many others.

*Ceremošnja* is a cave near the village *Mošna*, (Κηρ /ker/ = death, misfortune, while Κηραίνω /keraino/ means to endanger, to threaten to death). In mythology, Kere (Κηρες), the evil demonic creatures are black as night, goggle-eyed, with wild-beast teeth and bent nails. They stick these nails into brave warriors and drink their blood. Their cloaks are red with human blood (Homer, Iliad, 18, 535). How easy is to associate them with Dracula born centuries later in the same environment in the neighborhood (Romania).

When the gods quarrel then Zeus sends his daughter Irid (Ιρις /iris/ = rainbow) to Stiga to bring him her cold waters to simmer the gods down. Olympic competitors taking false oaths with Stiga were punished to be dumb for a year. For ordinary people, Stiga meant the life threat. Its underground waters broke ores into dust. The mountains of Homolje are full of ores. The story goes that Alexander the Great was poisoned with the waters of Stiga. On the other hand, this water was taken from the river Styx in Nonacrede, town in Arcadia, on Peloponese, Greece. To hold the water so cold, a donkey hoof was used as a dish, for no other could hold it. The story was told by some Hagnotemis (Αγνος /agnos/ = honorable, Θεμις /themis/ = from the valley of Tamiš, or Temiš, in Panonia). The donkey was a sacred animal of Hyperboreans, from the middle Danube.

*Vitovnica* (βια /via/ = strength, force) is the first of right Mlava river tributaries. Via (Βια) or Bia in mythology is a personification of force. She is the daughter of Titan Palantus and Oceanide Stiga. According to Hesiod, in Gigantomachia she was fighting on the Zeus side and for that she is next to the chief of gods. She was present when Prometheus was enchained.

*Čokordin* (κωκίω /kokio/ = cry, ορδίνω /ordino/ = vertigo). In mythology, Kokit (Κωκίτος /kokitos/) is a river of cries in the underworld and a river branch of the Styx. Both with the river Pirifleget (πυρ /pir/ = fire, φλεγώ /flego/ = flame, burn, to blaze up) she was stemming down to the underworld. In the Stig of today, in Serbia, there is the city Požarevac (požar = big flame).

*Busur* is the last of the larger Mlava river tributary. Busirid or Βουσιρις was Egyptian king, the son of Poseidon, known for his cruelty, and for his custom to sacrifice all foreign visitors to Zeus. Busiris also means “The place of Osisris” in Egypt, where Osisris

was praised as a protector of dead. Euripidus wrote a satire about Busiris.

*Pek* is another Danube tributary collecting waters from northern Homolje river basin. Homolje is very rich in ores of iron, copper, lead, zinc, gold, silver, wolfram and coal, as well as in hydropower. Etymology of *Pek* is πεκω /peko/ meaning to cut fleece, or to pan golden fleece. Its tributaries are *Komša* (κομψος /kompos/ = beautiful) and *Lipi* (λυπη /lipi/ = grief, worry).

*Timok* is the last of the bigger middle Danube tributaries (τιμαω /timao/, τιμη /time/ = to respect) and its main tributary is *Svrlijig* (σφαρα /svara/ = to rustle, hum and λιγα /liga/ = to echo, moan).

From the depression of *Panonia* (Παν /pan/ is the son of Zeus or Hermes, the god of shepherds, forests and fields, and ονια /onia/ = grief, sorrow) and after accepting the tributaries, Danube pierces through the masses of *Carpathian Mountains* (καρ /kar/ = stone mountain, παθος /paθος/ = evil) and flows through the gorges of *Djerdap* (γερας /geras/ = gift, δαπεδον /dapedon/ = soil, earth). The obvious translation is something like “The promised land”. The widest part of the gorge is on the right hand side near the village of *Boljetin* (βολη /vole/ = throwing, βολος /volos/ = to throw the fishnet) where *Lepenski Vir* was discovered. *Lepenski Vir* is one of the most important archeological findings of this century. The roots are λεπαιος /lepaio/ = rocky soil, λεπας /lepas/ = bare rock, λεπω /lepo/ = to peel. Under the name of *Lepen*, there are two rivers in Serbia, one in Macedonia and Bosnia and one region in Serbia and one in Bosnia.

Near the right curve of Danube there is a village *Mosna* (μοσσον /moson/ = wooden tower, wooden house). *Mosni* or *Mosinike* (οικος /oikos/ = the house) is the name of people that probably came from this part of *Djerdap*, and inhabited lands on the west of *Trapesunt* on the Black Sea. Six kilometers on the east lies *Miroč*, village and mountain. *Miroč* is from the word μυρον /miron/ = scent, aroma, smell, balsam. Near the northern curve of Danube near *Djerdap* is the city of *Tekija* (τεκ /tek/, τικω /tiko/ = to bear, to hatch, to spawn roe, τεκνον /tekon/ = child). It is a well known fact that during the springtime the white sturgeon fish comes here from the Black Sea to spawn the roe. Nearby, on the other side of Danube, lies the Rumanian city of *Orsova* (ορσεω /orseo/ = to jump, to confuse). *Karataš* is further in the east (καρα /kara/ = stone hill, θασσω /thaso/ = fast, sudden). *Katarakte* (κατα /kata/ = down and αρασσω /araso/ = fall) or Danubian falls start here. Not far from there is canal *Sipski* (σηπιον /sepion/ = European cuttlefish, but also the sea foam). The canal ends at *Kladovo* (κλαδος /klados/ = the twig). We know that the followers of the Dionisian cult wore wreaths of twigs and flowers, also the heralds and deserters from the enemy side.

## 12 Screening of Names and Their Readings

*Carpathian Mountains* make the northern side of the gorge of Djerdap while the Romanian name for one of their slopes near Danube is *Almaslui* (αλς/als/, αλμη/alme/ = salty, saulty mountain). *Carpathos* is also the name of the island and the sea (*Carpathio Pelagos*) at Dodecanese in Aegeans.

*Kučaj* (κυκαω /kikao/ = to stir, to mix, to confuse) is the mountain of the region. Northern part of the mountain is 727 m high and southern is 1243 m. Between them are the mountains of *Homolje* (ομος/omos/ = the same, similar, λαος/laos/ = people, the same as the word *homologue*). Between the northern *Kučaj* and the *Homolje* mountains, where river *Pek* flows, are the gorge of *Kučevo* and the town with the same name. The mixing and stirring that connote these names is also present in the Slav origin of the name of the *Zvižd* (= to whistle) region nearby,

where whistles are heard when warm and cold mountain winds mix.

To conclude this screening of names, let us just mention a few names of the regions, towns and cities in Serbia, with whom we are so familiarized: *Banat* (αναζ/anaks/ = the master, the leader, Apollo); *Apatin* (Απατη/apate/ = from mythology, personifies the fraud, in possession of a magic belt which helped Rhea to seduce Chronos); *Ljig* (λυγζ/likes/ = wildcat); *Paraćin* (παρακιω/parkio/ = to pass by); *Stalac* (σταλαω/stalao/ = to drip, leak); *Leskovac* (λεσχη/leshe/ = inn, tavern); *Niš* (νυσσα = the hill, the wholly mountain forest, devoted to the supreme god, i.e. Διονυσσα or Dionis); *Piroč* (πυρετος/piretos/ = the blaze, the crops); *Čačak*, *Kačanik* (κακ, κακια, κακος, κακανην, κατακαιω = evil, to kill, murder); *Đakovica* (διακον/diakon/ = the servant); *Prizren* (πριζω/prizo/ = to saw, ρεν/ren/ = to flow); *Dečani* (δεκα/deka/ = ten, ναος/naos/, ναοι/nai/ = sanctuaries).

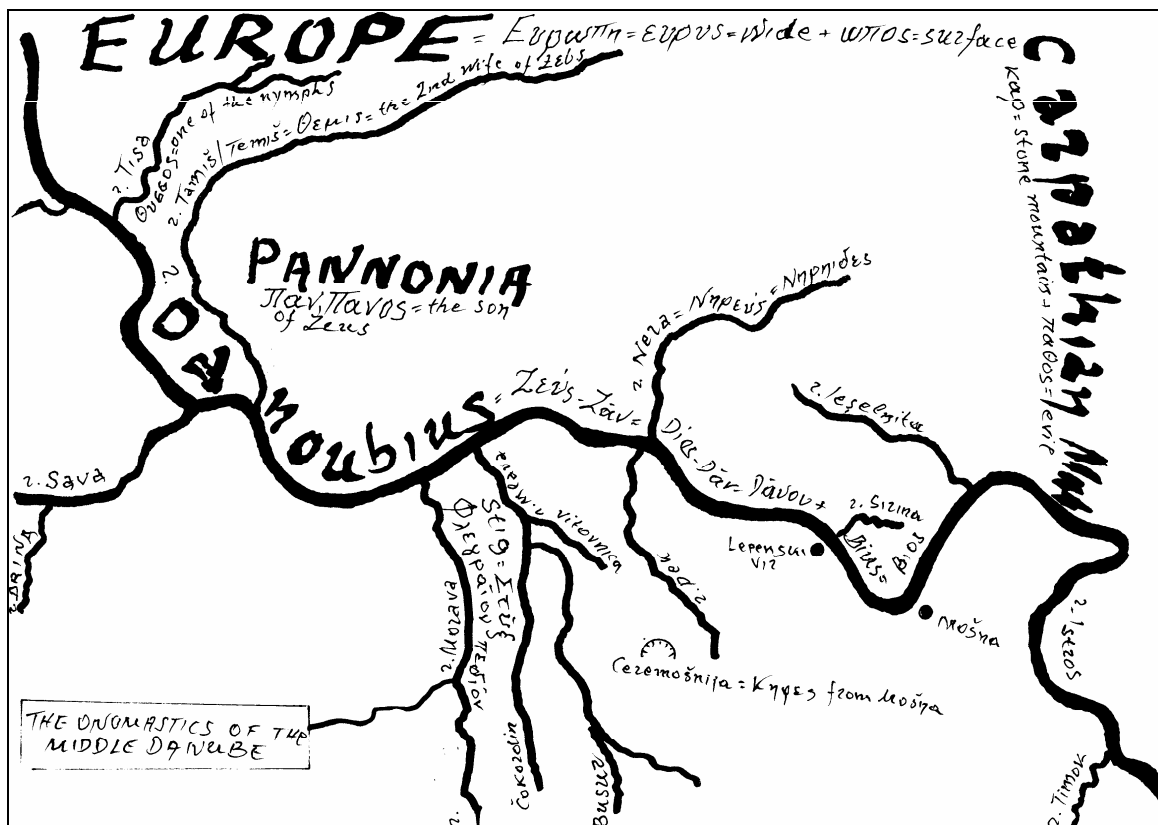

## 13 Discussion and Conclusion

Freud's psychoanalytical construction with the Oedipal complex theory and the whole Jung's theory of collective unconsciousness with archetypes are albeit mystified, rather hermetic and well understood only by professionals in the field.

The contemporary approach to the phenomenon of mind is multidisciplinary and yields new hypotheses,

definitions and paradigms. Revealing of unconscious contents and broadening of conscious necessitates information of linguistic (audio-verbal) and written (visual-sensor) nature. The general functions of mind are the information acquisition, their memorizing and their activation. These functions represent the process of interaction between the cortical and subcortical structures. This is the place where the memory is stored and coded information is made with the help of

biochemical molecular mechanisms and through the utilization of fine biophysical, hierarchical neural networks, with the ultra-low-frequency ionic activity of DNA, RNA and the cellular membranes (Schmidt, 1985; Koruga, 1996; Raković, 1996).

Paleoglossology of Balkans (POB) is suggested as a method to approach the archetype contents of conscious and the collective unconscious. The word “archetype” could also be analysed by POB method: αρχ, αρχω /arh, arho/ means to be the first to start, or αρχη /arhe/ which means the beginning, i.e. αρχαιος /arhaios/, from time immemorial, and the word τυπος /tipos/ which is the type, or impression, which give αρχετυπος /arhetipos/ meaning the first and very old original. Therefore, the glossological originals are not found to be the mystical dreams and stairs to prehistoric ages, but the living names suggesting the historical events and pinpointing to the multilayered history of the Balkans. POB method reaches for the rich onomastics found in toponyms, hydronyms, oronyms, horonyms and other names of the middle Danube river basin and other areas in Serbia and the Balkans. It shows by examples that these names often connote the hierarchy of Olympus and the ancient gods and their relations. The indices are that mysterious Greek mythology originates from the Balkan middle Danube regions. Recent archeological findings of the prehistoric village of Lepenski Vir in the Iron Gate supports the myth of the promised land emerging after the Ice Age on the slopes of the Danube, as the translated names of the places around are suggesting.

The aim of this paper was to attempt to decipher some names domesticated on the Balkan peninsula by using the ancient Greek, not in use today. It is interesting to our findings that the ancient Greek is present in the modern Greek mainly by onomastics of the Balkan geography. But this onomastics is common to many Balkan states, the fact that somehow ridicules all Balkan nationalisms and places the ethno-histories and ethno-rights where they belong.

## References

- [1] Budimir, M.: *Frm Balkans' Sources* (SKZ, Beograd, 1969), in Serbian.
- [2] Childe, V.G.: *The Dawn of European Civilization* (Routledge, 1925).
- [3] Gimbutas, M.: *The Goddesses and Gods of Old Europe*, (Univ. of California Press, L.A., 1982).
- [4] Grevs, R.: *The Greek Myths* (Penguin Books Ltd., Middlessex, 1972).
- [5] Herodotus, *The History* (Chicago, 1987).
- [6] Hesiodus, *Fragmenta & Theogonia*.
- [7] Jung, K.G.: *Dynamics of Unconscious* (Matica Srpska, Novi Sad, 1990), in Serbian.
- [8] Cavalli-Sforza, L.L.: Genes, peoples and languages, *Scientific American*, Nov. 1991, pp.72-78.
- [9] Kretschmer, P.: *Einleitung in die Geschichte der griechischen Sprache* (Gottingen, 1986).
- [10] Koruga, Đ.: Information Physics: A scenario of creation, in Lj. Rakić, D. Raković, Đ. Koruga, and A. Marjanović, eds., *Consciousness: Scientific Challenge of the 21<sup>st</sup> Century*, Proc. ECPD Seminar (Belgrade, 1996), pp.173-177, in Serbian
- [11] Mpampinioti, G.: *Synoptiki istoria tis ellenikis glossas* (Athina, 1986).
- [12] Papastavrou, I.: *Istoria tis arhais Ellados* (Hiotelli, Athina, 1972).
- [13] Raković, D.: Hierarchical neural networks and brainwaves: Towards theory of consciousness, in Lj. Rakić, D. Raković, Đ. Koruga, and A. Marjanović, eds., *Consciousness: Scientific Challenge of the 21<sup>st</sup> Century*, Proc. ECPD Seminar (Belgrade, 1996), pp.189-198, in Serbian.
- [14] Renfrew, C.: *Before Civilization* (Penguin Books, 1978).
- [15] Schachermeyer, F.: *Diealtesten Kulturen Griechenlands*, (Stuttgart, 1955).
- [16] Schmidt, R.: *Fundamentals of Neurophysiology* (Springer-Verlag, New York, 1994).
- [17] Senc, S.: *Greek-Croat Dictionary* (Kr. zemaljska tiskara, Zagreb, 1910).
- [18] Srejić D. and Babović, Lj.: *Art of Lepenski Vir* (Izdavački zavod Jugoslavije, Beograd, 1983), in Serbian.
- [19] Srejić, D. and Cermaković-Kuzmanović, A.: *Dictionary of Greek and Roman Mythology* (SKZ, Beograd, 1992).
- [20] Škokljević A., and Škokljević, I.: Pelasgian glossology: Towards archetype consciousness and collective unconscious, in Lj. Rakić, D. Raković, Đ. Koruga, and A. Marjanović, eds., *Consciousness: Scientific Challenge of the 21<sup>st</sup> Century*, Proc. ECPD Seminar (Belgrade, 1996), pp.38-46, in Serbian.
- [21] Thomson, G.: *I Arhaia Elliniki Koinoia, To proistoriko Aigai* (Ekvot. Inst. Athina, Athina, 1954).
- [22] Vasić, M.: *Archeology and Linguistics* (Zbornik SANU, Beograd, 1958), in Serbian.



## A FEW SIMPLE MIND-MATTER EXPERIMENTS

Cyril W. Smith

Department of Electronic and Electrical Engineering, University of Salford,  
Salford M5 4WT, England

**Abstract.** This paper describes a few simple experiments involving the imprinting of water with mentally visualised information.

**Key words:** water, mind-matter interaction, measurements.

### 1 Introduction

The writer has for many years been experimenting with the application of the techniques of dowsing and radiesthesia to scientific measurements [1]. In these, the human body becomes an indicating instrument much in the way that a galvanometer needle indicates. What appears to be being sensed is a change in muscle tremor resulting from an unbalance between the left and right hand when these are in a gradient of vector potential. It is possible to measure the frequencies imprinted into water and homoeopathic potencies and to detect alternating vector potential fields. These effects must be taking place at a quantum field level.

The details of the technique have already been described [2]. For the subjective detection of resonances in water, a toroidal coil and the tube containing the water need to be aligned on a North-South axis. The precision necessary depends on the strength of the vector potential field from the toroidal coil which is determined by the output of the oscillator to which it is connected. This is to avoid interference from the geomagnetic field vector potential. The hands/arms of the experimenter are also on this axis with one on either side of the tube of water to be measured. One hand is free to hold a pendulum, the other to tune the oscillator. The mechanical resonance of the pendulum should be about 2Hz to match a natural resonance in the autonomic nervous system. When the oscillator tunes through a resonance in the water, the pendulum makes a characteristic change in its swing; presumably this is due to a change in the pattern of muscle tremor.

Frequencies may be imprinted into water by succussion as in homoeopathic potentising. A tube of water is held in the hand near to the toroidal coil supplied with an alternating current at the required frequency. The base of the tube is given a single and hard bang on a wooden surface, but not so hard as to break the glass! The above technique will confirm that the imprinting has been successful.

Imprints may be erased from water (and also homoeopathic potencies) by briefly placing inside a

closed mumetal box so as to screen off the geomagnetic field. This appears to be essential for "water memory". This is also a good way to prepare chemically identical "control" specimens from previously used active homoeopathic specimens.

### 2 Experiments

#### *Experiment 1*

(a) Hold an erased tube of water in the hand and mentally concentrate on a particular frequency. Result: no imprint. Note that some healers can imprint water in this way.

(b) Hold an erased tube of water in the hand and mentally concentrate on a particular frequency and succuss the tube. Result: an imprint of the frequency held in mind. This works for both audio and radio frequencies and thus cannot be a musical or acoustic memory.

(c) Hold an erased tube of water in the hand and mentally concentrate on a particular frequency. Succuss the tube near a toroidal coil connected to an oscillator tuned to a different frequency. Result: Both the oscillator and the mind frequencies are imprinted.

#### *Experiment 2*

(a) Measure the frequencies of a chemical substance. Most chemicals have some intrinsic frequencies which are not erased by mumetal shielding. Chemical elements usually have one frequency and simple ionic crystals usually have three frequencies. They are probably arise from structured water associated with the chemical. They are absent in completely substituted chlorinated compounds and in very dry n-hexane.

Mentally concentrate on the chemical substance and succuss. Result: the measured frequencies are imprinted. For example, a sample of table salt (NaCl) contained the resonance frequencies 11.6 MHz, 22 MHz, 112 MHz; these were imprinted when the substance was held in mind during succussion.

(b) Hold an erased tube of water in the hand and mentally concentrate on a particular chemical known to be at a distance and succuss. Result: No imprinting resulted.

(c) Go to the chemical and hold in hands briefly and replace. Then, return and hold an erased tube of

water in the hand, mentally concentrate on this particular chemical and succuss. Result: three frequencies were imprinted. Subsequent measurement of the chemical's resonant frequencies agreed with those imprinted. For example, some cooking salt had frequencies of 12 kHz, 2.4 MHz, 150 MHz. This confirms that the frequencies do not have to be known numerically for imprinting to occur.

(d) In October 1994, the writer measured a set of potencies of thyroxine [3]. Mentally concentrating on thyroxin D10 while holding a tube of erased water resulted in no imprint. Its memory had not been retained this long. The writer is continually measuring frequencies from oscillators and these seem to be readily recalled.

(e) After briefly holding a bottle of thyroxin D12, the subsequent holding of an erased tube of water in the hand and mentally concentrating on thyroxine D12 resulted in the correct imprinting of the frequencies as previously measured [3] but which had not been referred to immediately prior to this experiment.

### 3 Conclusion

These simple experiments are suggested for use in work on mind-matter interactions. They show that some pattern of a chemical substance or potency is retained in the body at least for a time and that the

body can imprint water by succussion with its characteristic frequency pattern in response to the mental recall of either a substance or a frequency. It also shows how careful must be the precautions taken in the preparation of homoeopathic remedies if the desired information is to be correctly potentised.

### References

- [1] C.W. Smith Radiesthèsie: une technique scientifique. Presented at *The 1st. Congrès de la Radiesthésie*, Paris, 13-14 November, 1993, and *The 7th. GIRI Meeting*, Montpellier, 20-21 November, 1993.
- [2] C.W. Smith, Electromagnetic and magnetic vector potential bio-information and water, in: P.C. Endler and J. Schulte, eds., *Ultra High Dilution: Physiology and Physics* (Kluwer Academic, Dordrecht, 1994), pp. 187-201.
- [3] C.W. Smith and P.C. Endler, Resonance phenomena of an ultra high dilution - preliminary results, in P.C. Endler and J. Schulte, eds., *Ultra High Dilution: Physiology and Physics* (Kluwer Academic, Dordrecht, 1994), pp. 203-207.

## NEUROLINGUISTIC PROGRAMMING: A NEW INTEGRATIVE MODEL FOR STATES OF CONSCIOUSNESS

Gordana Stanojević-Vitaliano

Mindwaves Institute, PO Box 41, Boston, MA 02199, USA  
E-mail: mindwaves@vxm.com,

**Abstract.** The central task of our new integrative model of consciousness is understanding the biophysical structure of the multileveled nature of consciousness, which was empirically recognized and described by many ancient civilizations. Our model proposes that various levels of consciousness are products of evolutionary development. The psychological development and functional specialization of the neural structures are associated with the biological development and myelination of brain structures. Thus, the occurrence of different levels of consciousness is accompanied by development of specific structures in the central nervous system. Our comparative analysis of phylogenetic and ontogenetic development of the brain and its structures uncovers the multileveled manifestation of human consciousness.

Consciousness manifests dualistic properties that are paraconceptual by ordinary concepts of space and time. Thus, a traditional dichotomy exists between biological and psychological models of consciousness. Neuroscientists often describe the fast parallel mode of neural information processing; while psychologists mostly deal with a slow serial model of consciousness. Our relativistic biophysical model appears to bridge the gap between different properties of human consciousness. The model shows that a conscious neural network is able to process information 'dualistically'-biochemically in the brain, and biophysically via brainwaves-inside the ionic "optical" neural network of the ionic system with an electromagnetic field of extremely low frequency brainwaves. The result is Mixed Modal processing in altered states of consciousness, when a part of the ionic system is displaced from the body. This processing exhibits speeds that greatly exceed the brain's biochemical rate of execution, and is the basis for multileveled nature of human consciousness.

**Key words:** *behavioral models, states of consciousness, neurolinguistic programming (NLP), integrative model.*

### 1 Introduction

The central task of our new integrative NLP model (Stanojevic-Vitaliano, 1993), whether experimental or applied, is the understanding of the nature of human consciousness. In order to understand normal and altered states of consciousness, this model explores different, relatively separate areas of human behavior; for example, the areas of perception, of learning, of language, of cognitive processes, and of motor skills. Consciousness manifests properties that are paraconceptual by our ordinary concepts of space and

time, and so require understanding in their own terms. As our understanding of these different areas of study in psychology grow, we continue to uncover the structures of human consciousness.

In the past few decades the West has witnessed a growing interest among scientists, psychologists and philosophers in what Ken Wilber (1977) has called "perennial psychology" - a universal view as to the nature of human consciousness. The purpose of this psychology is to develop a universal model of consciousness which integrates western and eastern philosophical doctrines and experiential practices.

The core insight of the perennial psychology is that human consciousness is a multi leveled manifestation of a universal consciousness. Each level of the spectrum is characterized by different and easily recognized sense of individual identity. A man can identify himself with the universe and have a feeling of supreme identity of the cosmic consciousness; or can focus only on his egoic tendencies and have a extremely narrowed feeling of identity related to ego-consciousness. There are numerous levels or bands of consciousness, described by different authors. We are presenting eight major levels in our hierarchical integrative model of consciousness.

The perennial psychology proposes that the various levels of consciousness (except that of Mind itself) are the products of dualism (Deutch, 1969). The dualism is the act of severance, cutting (con-scire) of the world into seer and seen, knower and known. The threefold meaning of consciousness is coming from the Latin words 'con-scio' that is to cut or make a distinction, and 'con-scire' to know.

The original dualism is presented in mythology as the separation of heaven and earth, male and female, and sun and moon. In epistemology, it is the separation of subject and object, observer and observed; while in ontology it is presented as the separation of self and other, organism and environment. With the occurrence of the primary dualism, man's consciousness shifts from the nondual mind to his body.

## 2 The Eight Levels

### 2.1 Perceptual Level

Man first identifies himself with his body that exists in space and time. That is, the level where the line between self and others, organism and environment, is becoming established. Out of the oneness of Universal Mind, the perceptual level emerges. Man becomes aware of his body separated from the environment. This knowledge simultaneously creates awareness of space - the primary dualism. The primary dualism has been investigated by anthropologists concerned with the period in human evolution when man first learned to separate himself from his environment. Four million years ago the first known humanoid species *Australopithecines*, were capable of bipedal walking and stereoscopic vision which allowed them to better manipulate their environment.

Primary dualism has also been described by psychologists who have studied infant development as the period when the child learns to separate himself from his immediate surroundings. During the first 6 months of life, the self is identified with its environment and, especially, the mothering one (Mahler's "symbiotic phase", 1975). The new born infant cannot clearly differentiate himself as separate subject from his environment because the brain structures necessary for this process are still not developed. Most of the time, the infant is in the deep sleep. At the age of six months, the infant is becoming aware of his body and can recognize himself in the mirror. The self, basically as a sensorimotor and instinctual body, has differentiated itself from the environment.

The Perceptual Level includes the first set of filters called biological filters. Our nervous system with its sensory organs, initially determined genetically, constitutes the first set of biological filters which distinguishes external reality from our internal representation of the world; i.e., our experience of reality. Our genetically-given biological limitations allow us to perceive just a small portion of a broad range of continuous physical phenomenon.

Self development is followed by the development of the central nervous system. The functional specialization of the neural structures is associated with the process of myelination of the brain structures. In the first 6 months of life, there is a myelination of the Reticular Formation, which is responsible for the state of arousal; and the Primary Zones of the brain's cortex, which are responsible for the development of the perceptual skills. The neurons of the primary sensory system respond only to narrowly specialized properties of sensory stimuli (e.g., shades of color, the character of lines, the direction of movement, and the loudness of sound) and preserve their strict modal specificity (Stanojevic, 1990).

The Perceptual Level is the level of altered state of consciousness, which exhibits predominantly theta

(3.5 to 8 Hz) and delta (0.5 to 3.5 Hz) brain waves patterns. These brain waves usually correspond to normally unconscious informational content (Basar, 1980). At this level, the ionic acupuncture system is partly displaced from the body. Consciousness (i.e., subjective observer) is associated with an electromagnetic component of ELF (Extremely Low Frequencies) brainwaves that are embedded in the low dielectric gaseous weakly ionized medium (Rakovic et al., 1989). The ionic concentration in this diffusionally unstable medium after ~ 1 hour reaches the one in the atmospheric air outside the body, and the ELF brainwaves can flow through the surrounding weakly ionized atmosphere. The whole system is thus completely open for information exchange within the ELF domain, which can thus bring a sense of oneness with the surrounding world.

Subjectively, this state is experienced as a state of oceanic euphoria, unconditional omnipotence, and pleromatic paradise. Objectively, this level is characterized in our Integrative NLP (Stanojevic-Vitaliano, 1993) by deep muscle relaxation, very slow metabolism, and decreased heart and respiratory rates. This state of awareness can be achieved in Integrative NLP by focusing internally on body function (i.e. breathing or heart rate), or on simple sensations of light, sound, smell or taste. Prolonged focusing on one external object can also produce this state of consciousness.

### 2.2 Emotional Level

As soon as man identifies with his body, and becomes aware of space, the problem of life vs. death occurs. At this moment appears the existential fear of death. In separating birth from death, man differentiates past from the future, and becomes aware of historical time. At the Emotional Level of awareness man, identified solely with his organism as existing in space (primary dualism) and time (secondary dualism). This knowledge creates an existential need to survive, and the fear of death. This is the level where man's emotional and thought processes, as well as his personal will, first begin to develop. Two million years ago new species - *Homo Habilis* and *Homo Erectus* were capable to use visual clues and build first primitive tools in order to fight for their survival and master their environment. They also used primitive vocalization to communicate their feelings and needs.

In developmental psychology, this period has been described as a beginning of the emotional life, and language acquisition. Sensory motor functions are now becoming more complex. The child starts to walk and to talk. He/she becomes more independent from others, and aware of him/her self as a separate emotional/physical being (Freud, 1923). By 18 months of age, a relatively stable core gender identity (i.e., the sense of being a boy or girl) is established. At the end of the second year, the child begins to use word "I" when he/she refers to himself or herself. On the biological level, scientists also describe the further

development and the myelinization of the Limbic system (Cingulum) responsible for the emotional experience; and Secondary Zones of the brain cortex, which are responsible for the further development of perceptual and language functions. The Secondary Zones serve as an apparatus for the reception, analysis, and storage of modality specific information arriving from the outside world (Stanojevic, 1990).

The Emotional Level includes the second set of filters called sociogenetic filters. These filters are the internalized matrix of specific cultural premises, familial relationships, and social glosses; as well as social institutions of language, logic, ethics, and law. The sociogenetic filter represents those aspects of the environment that have been interjected during the developmental process. At the Emotional Level, the values of society are becoming mapped into the biological organism that exists in the space and time.

The Emotional Level is the level of altered states of consciousness, with predominantly alpha (8 to 13 Hz) and some theta (3.5 to 8 Hz) brain waves patterns that usually correspond to normally subconscious informational content. At this level, the ionic gaseous system is still partly displaced from the body. Consciousness associated with the electromagnetic component of ELF brainwaves is embedded in the low dielectric gaseous weakly ionized medium. The difference from the previously described state is that the periods of sleep are significantly reduced.

Subjectively, this state is experienced as a state of pleasant and unpleasant emotions, ranging from bliss and ecstatic release to fear and rage. It is also a state of impersonality, multivalent images, and archetypal forms (Jung, 1967), distance, and dissociation. Objectively, this is the level that is characterized in Integrative NLP by rapid eye movements or eye fixation, middle ear muscle activation, irregular heart rate and respiration, significantly reduced muscle tone with occasional muscle twitches, tremor, or cataplexy and catalepsy. This level can be entered in Integrative NLP by concentrating on different feelings, emotions, and visual imagines.

### 2.3 Symbolic Level

At the Emotional Level, a man fears death and fights for his life. In order to overcome the primordial fear of death, a man creates a permanent image of himself called "ego", which consists of fixed and stable symbols. On this level, man identifies with the seemingly undying idea of himself - his "ego". He becomes aware of himself as "I". His identity shifts from his total psychophysical organism to his mental representation of his organism. This is the tertiary dualism which creates the next major level - the Symbolic Level.

On the Symbolic Level, a man is not anymore directly identified with his total psychophysical organism as existing in space and time. He now identifies solely with a mental representation or picture of himself. In other words, he is aware of his ego, his self image. His consciousness is not anymore

bound by the emotional level, but shifts to the level of awareness where the intellectual and symbolic processes emerge. Five hundred thousand years ago first primitive Homo Sapiens and Neanderthals started to use language abilities, and to form more complex social communities. They skillfully shaped new tools that allowed them to better survive in harsh icy environment.

In developmental psychology, this period has been described as the beginning of cognitive development - preoperational thinking (Piaget, 1954). From two to seven years of age, the child is capable to form symbols and concepts, but can not yet operate or coordinate those representations. For example, a child can count objects but cannot easily multiply or divide them. He/she cannot comprehend more than one dimension or property of the object, and cannot understand volume and mass. For example, the child learns to group objects by color or shape, but not both. Also, if the object changes shape, the child does not understand that the object preserves its original mass or volume. The major characteristic of this period is egocentrism because the child is unable to put himself in the place of someone else.

The Symbolic Level includes the third set of filters called individual constraints, or personal filters. By individual constraints, we refer to all the representations of the world that a man creates during the course of his life, based upon his own unique personal experiences. These models or maps will constitute a set of interests, habits, likes, dislikes, and rules for behavior that are distinctly his own. Every person has a different set of experiences in life, and thus creates different models or maps of the world that govern his/her behavior.

At the same time, on the brain level, scientists describe the further development and the myelinization of the Tertiary Zones of the brain cortex. The Tertiary Zones are involved in sensory data integration, and the transition from the level of simple visual representations to the level of complex symbolic processes (e.g. operations with word meanings, with complex grammatical and logical structures and with systems of numbers). The tertiary zones play an essential role in the conversion of concrete perception into abstract thinking (Stanojevic, 1990).

The Symbolic level is the level with predominantly beta (13 to 30 Hz) and alpha waves (8 to 13 Hz) in the brain. On this level, man becomes aware of normally conscious and subconscious information only in altered states of consciousness related to REM sleep phases. Consciousness is still associated with electromagnetic component of ELF brainwaves embedded in the low dielectric gaseous weakly ionized medium that is partially displaced from the body (Stanojevic-Vitaliano & Rakovic, 1995).

Subjectively this state is experienced as a state of preoperational or mythic thinking, temporal desires, specific likes and dislikes, tension and relaxation, safety and belongingness. Objectively, this is the level

in Integrative NLP where consciousness shifts from the relaxed day-dream state to the normal awake state in which all the activities can be fully performed. On this level in Integrative NLP we apply different techniques that include anchoring or reframing of the specific experience; transforming a negative experience into positive via play or ritual, imaginative problem solving, age regression and metaphorical stories.

## 2.4 The Rational Level

Finally, a man identifies with only a fraction of his psychic processes that he considers to be himself. He becomes aware only of the ideal image of himself, and all other unwanted aspects of his ego become unconscious. In an attempt to make his self-image acceptable, he represses all the "bad" aspects of his egoic tendencies, thus creating the new level, called the Rational Level. On this Rational Level, man imposes a dualism or split upon his own ego, represses the underlying unity of all his egoic tendencies, and projects them as the persona vs. shadow. Such then is a generation of the quaternary dualism.

At the Rational Level, man identifies with mostly inaccurate and greatly limited aspects of his ego, his ideal image of himself - his persona. At the same time, all unacceptable aspects of himself are repressed and are projected as the 'shadow' (Jung, 1967). Man alienates and dis-identifies with psychic tendencies that he considers to be painful, miserable, or undesirable (e.g., unpleasant thoughts and emotions like fear or rage, sexual and aggressive instincts, and socially forbidden behavior) and finally projects them into the shadow. Hundred thousand years ago modern Homo Sapiens projected his god and his shadow on the walls of the caves around the world. That marks the beginning of the new civilization where science and technology, art and religion predominate. Man is not only mastering his natural environment but creating a completely new artificial surrounding.

At the Rational level, man has already lost direct contact with his body, and parts of his ego. Psychoanalytically, the unconscious contains wishes and ideas linked to the wishes that were banished from consciousness via the mechanism of repression. On the Rational Level, man dis-identifies himself with other levels that have become completely unconscious. Normal adult man usually spends most of his every day life within the Rational Level of consciousness. He is predominantly aware of his ideal self-image in relation to his environment.

In developmental psychology, this level has been described as the level of the concrete and formal operational thinking (Piaget, 1954). At approximately seven years of age, a child starts to comprehend multiple classification, as well as two or more classes occurring simultaneously (e.g. the child can order objects serially along a dimension, such as increasing size from smallest to largest). His thinking is not anymore egocentric and narcissistic. He/she is becoming capable to take the role of others; and to

perform rule operations such as multiplication, division, and class inclusion. Concrete operational thinking is still bound to the concrete and obvious world, and cannot grasp possible or hypothetical relationships.

At around eleven years of age, the adolescent attains the capacity for abstract and propositional thinking about multiple variables. He/she is capable of looking at a problem from multiple points of view. The adolescent can analyze each variable independently, or as a part of the whole. Abstract concepts such as truth or virtue are subject to discussion or analysis. Erickson (1959) referred to this process as the formation of ego identity. This is the final stage of development of the ego. The mature ego becomes capable of imagining possibilities not given to mere sensory evidence or sensory-concrete operation. On the biological level, there is a continuation of the brain myelination which occurs on the level of interhemispheric connections that coordinate functions of left and right brain hemispheres.

The Rational level is the level where consciousness, associated with the electromagnetic component of the ELF brainwaves, most of the day-time completely pervades the brain's neural network. At this level, there is a good separation of normally conscious and subconscious contents in the brain, while mixing of information that belongs to other levels of consciousness is only possible during the REM sleep phases (Stanojevic-Vitaliano & Rakovic, 1995). At this level, the brainwave spectrum is dominated by the upper two ELF channels: gamma (30 to 50 Hz), and beta (13 to 30 Hz), and information mostly corresponds to normally conscious content (Basar, 1980).

Subjectively this state is experienced as a state of concrete and formal operational thinking, inner dialogues, temporal goals and desires, self-esteem needs, self-control and will-power, different emotions (e.g., pride, guilt, love, and hatred). Objectively, this is the level where consciousness is completely associated with the normal awake state in which all the activities can be fully performed. This is the most superficial level in Integrative NLP (Stanojevic-Vitaliano, 1993). The techniques that belong to this level are: goal planning, time management, future visualization and self-affirmations.

## 2.5 The Creative Level

The Creative Level is the level where the formal mind integrates all the ideas and experiences into one, whole picture model of the world.

Man is now capable to envision how the truth or falsity of any one idea would affect the truth or falsity of the others. Man now comprehends a mass network of ideas, how they influence each other, and what their relationships are. This is the Arubindo's "higher mind" that can make connections, relate truths, coordinate ideas and integrate concepts. It is the highest integrative structure in the individual realm, "self-seen

in the integral whole". All the structures of the human psyche are completely integrated into the one whole.

This is the creative phase in the development of human consciousness. There exists no more separation; but rather, integration of the human psyche. The fully integrated rational and symbolic levels are preparing to become one with the emotional level. There is now a completion of brain development, and the final myelinization takes place of all possible inter and intra-hemispheric connections.

The Creative level is the level where consciousness, associated with the electromagnetic component of the ELF brainwaves, together with the ionic acupuncture system, is deliberately displaced from the highly developed neural network of the brain (Stanojevic-Vitaliano & Rakovic, 1995). At this level of prolonged altered states of consciousness, there is not only mixing, but also the efficient integration of normally conscious and subconscious contents. The brainwave spectrum is now exhibiting normal brain wave patterns that correspond to gamma, beta and alpha waves. In Buddhism this level is called "manovijnana", or the "intellect"; while in Hinduism it is referred as "stulasarira".

Subjectively, this state is experienced as a state of self-actualization, vision-logic, high fantasy, synthetic thinking, spontaneity, creativity, and supersensitivity. Objectively, this is the level where consciousness can easily shift from the rational to symbolic level, and finally back to the emotional level of awareness. All the information from these levels can be fully processed and integrated into the Creative Level of awareness. The techniques being used in Integrative NLP to enhance the development of the Creative Level of awareness are creative modeling, age progression, creative visualization, and moment to moment awareness.

## 2.6 Supra-Individual Level

This is the realm of high religious intuition and literal inspiration, of symbolic visions, of audible illuminations, of blue, gold and white light. This is the realm of higher presences, guides, angelic beings, deities - all of which are high archetypal forms of one's own being (Jung, 1967). The subject is identified with an object of faith. At its peak, the subject dissolves into the object. The worship, the worshipper and the worshipped are one.

On this level, man transcends his normal capacity of individual mind and body, and returns back to the higher realm of existence. He operates upon the world, and his body and mind, in ways that appear to ordinary people to be fantastic and extraordinary. He develops extrasensory perception, precognition, clairvoyance, psychokinesis, and so on. Man masters the level of psychic phenomena and paranormal powers by fully integrating his rational, symbolic, and emotional level. He originally came from this realm, and can occasionally go back, but the complete integration takes place only after the individual development and synthesis of mind and body. This

level appears to be the same as the emotional level of the infant. The difference, though, is that the infant is aware but cannot operate on this level because neither brain nor mind are still fully developed. The infant is the passive observer, the mystic, the active creator.

This is the level where the ionic gaseous system is deliberately completely displaced from the body. Consciousness associated with the electromagnetic component of ELF brainwaves is now completely embedded in the low dielectric unhomogeneous gaseous weakly ionized medium (Stanojevic-Vitaliano & Rakovic, 1995). There is an intense mixing and integration of normally conscious, subconscious, and unconscious information. The brain exhibits a normal spectrum of gamma, beta, alpha and delta waves. Hinduism calls this level "suksmasarira"; while Buddhism terms this level "manas", and defines it as the persistent source of existential, rational, and volitional awareness.

Subjectively, this state is experienced as a state of rapture, bliss, compassion, and gratefulness, extrasensory perception, developed intuition and inspiration, archetypal forms, audible illumination, and revelations of light and sound. Objectively, this is the level where consciousness can easily process all the information coming from completely integrated rational-symbolic-emotional levels in one Supra-individual level. The techniques being used in Integrative NLP to enhance development of this level are lucid dreaming, astral projection, astral travel, hypnotic reincarnation, and personal guides or spiritual teacher visualization.

## 2.7 Transindividual Level

The process of integration and transcendence continues even further by dissolving into the higher 'other' realm; leading finally to the Unity itself. This process has been described in both East and West mystical traditions (Wilber, 1977,1980, 1981, 1986).

At the supra-individual level, man becomes aware of his archetypal Deity (as ishtadeva, yidam, dyani-Buddha), and finally becomes one with his Archetype. At the trans-individual level, man-as-deity dissolves into the final-God, which has been described as an intensive subtle 'audible illumination', the ultimate source from which all Archetypal forms emerged. Man becomes one with God. In the final transcendence, all the previous levels become completely integrated, and dissolved into a formless, infinite, unbounded consciousness.

At this level, the displaced ionic gaseous system completely deteriorates, and becomes homogeneous. The ionic concentration in this medium reaches the one in the air, and ELF brainwaves can flow through the surrounding weakly ionized atmosphere. The whole system is now open for information exchange in the ELF domain, which brings the sense of oneness with the surrounding world. At the same time, there is a complete integration of all possible information (Stanojevic-Vitaliano & Rakovic, 1995). The brain shows the full range of brainwaves spectrum: gamma,

beta, alpha, delta and theta waves. In Mahayana Buddhism this level of consciousness is called "alayavijnana", or "supraindividual repository consciousness"; while in Hinduism, they are referred to as the "karanasarira" or "causal body".

Subjectively, this state is experienced as a state of final illumination, radiant bliss, formless radiance, transcendent love in oneness, formless realization, and boundless consciousness. Objectively, this level is characterized by the final integration of all the levels: rational/symbolic/emotional/perceptual into one Trans-individual level. This state of awareness can be achieved via Integrative NLP by the practice of prayers and meditation (Stanojevic-Vitaliano, 1993).

## 2.8 The Universal Level

Man's innermost consciousness is identical to the absolute and ultimate reality of the universe. On this level, man is identified with the universal mind, and his consciousness becomes spaceless and timeless, and therefore eternal and infinite. This is the state of nirvana, samadhi, satori, enlightenment, state of completely liberated consciousness and peaceful mind. In that moment, there is no distinction between subject and object, self and not self, seer and seen. Therefore, there is no more possibility for sending and receiving any information - man is what there is and all there is.

At this level, there are no differences between the organism and environment. This is the state where a homogenous dielectric medium completely dissolves, enabling the peaceful mind without stream of consciousness (Stanojevic-Vitaliano & Rakovic, 1995).

Subjectively, the entire world process then arises, moment to moment as one's own Being, outside of which and prior to which, nothing exists. This is the ultimate Unity, where all things and events, while remaining perfectly separate and discrete, are only One. This is the final differentiation of the Consciousness; the state of perfect transcendence; which is not a transcendence in the world but a final transcendence as the world itself. By interpreting and integrating all the levels, realms and planes, high or low, sacred or profane, consciousness operates as the entire world process itself. "Form is not other than Void, Void is not other than Form", says the most famous Buddhist Sutra ("The Heart Sutra"-see Wilber, 1981). At that point, the extraordinary and the ordinary, the supernatural and the mundane, are one and the same. This is the ultimate Unity toward which all evolution, human and cosmic, drives.

The ultimate goal of Integrative NLP is the same as in yoga and related esoteric disciplines - the continual prolongation of altered states of consciousness 24 hours a day; with a displaced ionic system continuously open. This also means that the ultradian rhythm responsible for changes in states of consciousness (Rossi, 1986) does not exist any more. The biological basis for this phenomenon is probably the enhancement and completion of all possible

connections between the left and right brain hemispheres, which then allows the displacement and complete deterioration of the ionic acupuncture system, accompanied by liberation of the "subjective observer"- i.e., the electromagnetic component of the ELF brainwaves.

## 3 Conclusions

It has been shown in our integrative model of states of consciousness that a conscious neural network is able to process information in any of the following execution modes:

**Brain:** Processing takes place biochemically in the brain neural networks.

**Brainwaves:** Processing is parallelly executed biophysically via brainwaves, inside the ionic "optical" neural network of the ionic acupuncture system with embedded electromagnetic field of extremely low frequency (ELF) brainwaves. In altered states of consciousness, when a part of the ionic acupuncture system is displaced from the body, the processing is executed outside the body, too.

**Mixed:** Processing takes place via the mixed modalities of Brain and Brainwaves.

As a result we have significant implications:

(1) **Supertemporal Processing:** Mixed Modal processing in altered states of consciousness exhibits processing speeds that greatly exceed the brain's biochemical rate of execution.

(2) **Proximity Leaning:** A conscious brain's neural network is able to impart its knowledge to another close brain's neural network via ELF electromagnetic induction, which is also the basis of healing in NLP hypnotherapy.

Experimental investigation of conscious neural networks is possible, and includes the following procedures:

Testing, via computer-based tests, of the information processing capacity found in normal and altered states of consciousness;

Monitoring of the brain activity in normal and altered states of consciousness by using EEG and SQUID brain mapping;

Detecting the low-dielectric ionic structure by monitoring the local change in the ionic concentration in the vicinity of the body with highly sensitive infrared image processing;

Measuring the correlation between information processing capacity and parameters of the theoretically predicted ionic structure (ionic concentration, ionic currents, magnetic fields) in normal and altered state of consciousness;

Testing of low-power ELF transmission between neural networks with embedded ELF waves: One neural network can transfer its learned information to neighboring neural networks via electromagnetic induction coupling (this might also be the basis for short-range transpersonal interactions, such as healing).



Further experimental testing of our NLP integrative model of states of consciousness will help to better differentiate existing levels of consciousness, and to completely uncover psychophysiological and biophysical mechanisms associated with these levels.

## References

- [1] Aurobindo. *The Life Divine*. Pondicherry: Centenary Library, XVIII-XXI.n.d.
- [2] Baars B.J. (1988). *A Cognitive Theory of Consciousness*. Cambridge University Press.
- [3] Basar E. (1980) *EEG - Brain Dynamics*. Amsterdam: Elsevier.
- [4] Basar E. (1988) EEG-dynamics and evoked potentials in sensory and cognitive processing by the brain, in Basar E., Ed. *Dynamics of Sensory and Cognitive Processing by the Brain*. Berlin:Springer.
- [5] Deutch E. (1969) *Advaita Vedanta: A Philosophical Reconstruction*. Honolulu: East-West Center Press.
- [6] Erickson E. (1959). *Identity and the Life Cycle*. Ed. Rapaport D. New York: International University Press.
- [7] Freud S. (1936). *The Ego and the Mechanisms of Defense*. New York: International University Press.
- [8] Freud S. (1923). *The Ego and the Id*. In Standard Edition, vol 14. London: Hogarth Press 1961.
- [9] Jung C.G. (1967) The Collected Works of C.G. Jung 2nd ed. trans. RFC. Hull et al. Princeton. Princeton University press. *Symbols of Transformation*, Collected Works 5. *Psychological Types*, Collected Works 6. *Two Essays on Analytical Psychology*, Collected Works 7. *The Structure and Dynamics of the Psyche*, Collected Works 8. *The Archetypes and the Collective Unconscious*, Collected Works 9.
- [10] Mahler M., Pine F. and Bergman A. (1975). *The Psychological Birth of the Human Infant*. New York: Basic Books.
- [11] Piaget J. (1954) *The Construction of Reality in the Child*. New York: Basic Books.
- [12] Rakovic, D., Koruga, D., Martinovic Z. and Stanojevic G.D. (1989) On biophysical structure of brain-like biocomputers, in Ed. Lazarev P.I., *Molecular Electronics*, Kluwer Publ. pp.211-217.
- [13] Rakovic,D, Koruga, D., Martinovic Z. and Stanojevic G.D. (1989) Molecular electronics and neural networks: significance of ionic structure, *Proc. 11th Ann.Int.Conf. IEEE/EMBS*, Part 4/6, pp.1366-1367.
- [14] Rakovic, D., Koruga, D. and Stanojevic, G. (1993) On the nature of molecular electronics' hardware for neural networks with consciousness - like internal displays, in Blank M. Ed. *Electricity and Magnetism in Biology and Medicine*. San Francisco Press, Inc.
- [15] Rossi E.L. (1986) Altered states of consciousness in every day life: Ultradian rhythms, In B.B. Wolman and Ulman M. eds. *Handbook of States of Consciousness*. New York: Van Nostrand Reinhold Comp.
- [16] Stanojevic, G.D. ed., transl., (1989), *Hypnosis in Medicine*, Vol.1 of Handbook of Hypnosis. Belgrade: Medical Book Public.
- [17] Stanojevic, G.D. (1987) Hypnosis in integrative psychotherapy. Proc. 5th Yugoslavian Congress of Psychotherapists, pp. 40-41.
- [18] Stanojevic, G.D. (1989) Neuro-linguistic programming: Meta model. Belgrade Avalske Sveske: *Psychotherapy - Dilemmas and Perspectives*, Vol.9, pp.197-199.
- [19] Stanojevic, G.D. (1990) Neuro-Linguistic Programming: Meta Model of Language, *Linguistic and Speech Recognition*, Belgrade School. pp.1-43.
- [20] Stanojevic, G.D. (1990) Neuropsychological model of consciousness Proc. ECPD International Summer School on Neurocomputing, pp. 23-59.
- [21] Stanojevic-Vitaliano, G. (1993) Spectrum of psychotherapies, NIH, *Proc. Shenandoah Healing Exploration Meeting*, Rappahanock, Virginia, pp.1-6.
- [22] Stanojevic-Vitaliano, G. & Rakovic, D. (1995) Neural networks versus brainwaves: A biophysical model for states of consciousness and energy medicine, *Proceedings of The First International Yan Xin Qigong Science Symposium*
- [23] Vitaliano-Stanojevic, G. (1995) Neurolinguistic Programming: An Integrative Model for States of Consciousness, in Rakovic D. & Koruga D, Eds. *Consciousness: Scientific Challenge of the 21st Century*, European Centre for Peace and Development, United Nations University for Peace.
- [24] Wilber K. (1977) *The Spectrum of Consciousness*. Wheaton, Ill: Theosophical publishing House.
- [25] Wilber K. (1980) *The Atman Project*. Wheaton, Ill: Theosophical publishing House.
- [26] Wilber K. (1981) *Eye to Eye*. New York: Doubleday/Anchor.
- [27] Wilber K., Enger J. and Brown D. (1986) *Transformations of Consciousness: Conventional and Contemplative Perspectives Development*. Boston: Shambhala.

## LEVELS OF CONSCIOUSNESS IN THE CHILDREN WITH GRAPHOMOTORIC DIFFICULTIES

Neda Subota and Vivien Đorđević

The Institute for Experimental Phonetics and Speech Pathology,  
Gospodar Jovanova 35, Belgrade, Yugoslavia

**Abstract.** In this paper, we prefer to define the consciousness as the state of to present the following: awareness as organised by the senses. The aims of this research are - standards and measures by which the child with graphomotoric difficulties projects its levels of awareness;- the efficiency of the neuropsychological and psycholinguistic treatment method, placed in educational program. We have the following conclusions: The levels of awareness, open the "critical insight", of how the child is performing, here and now; the levels of awareness, affect the motivation of the child to perform better; the levels of awareness have their neuropsychical and biological order of appearance due to the maturation processes; the social group plays the dominant role in levels and awareness accomplishment. Hence, its role has two polarities: one is positive, because of its motivating factors and the other is negative, which acts as blockade; neuropsychological and psycholinguistic treatment placed in educational program, plays a very important role because it helps the child to reveal its levels of awareness in accordance with its performance.

**Key words:** *consciousness, children, graphomotoric difficulties, awareness, sense, motivating factors*

### 1 Introduction

In this paper, we prefer to define the consciousness as the state of awareness as organised by the senses. Consciousness is also the condition of "knowing things". Its quality allows the mind to record information. Also, the mind can store and recall the same information.

The condition of knowing things, extends beyond the mental assimilation of information to include instruct of entirely biological organization. The capacity to identify the objective of a need, like "water to quench thirst", bespeaks certain consciousness [1].

Therefore, in line with distinctly biological prerogatives, there is a very real condition of awareness which is not a less lucid, or meaningful to the individual than these mental faculties might establish.

This frame of reference supposes the polarity within the theme of consciousness. Therefore, all that is stimulated by consciousness delineates the area of the Ego. Likely, where the dynamics of the subconsciousness is manifest, there is established the theater of the Id.

Intensity of awareness is a condition quite apart from the other processes commonly associated with Mind. They relate to intelligence and the faculty of learning, and has to do specifically with the individual's evaluation of those circumstances in his physical and material world, which can have a bearing on his own physical and mental well-being.

First and foremost, the consciousness presents to the mind an awareness of the individual's circumstances as a vulnerable and isolated being, especially when we are referring to the child.

The contact which is established between the child and his physical and material world of reality, should be the theme of this singular system in personality. This should be so, because of the concern for the condition of survival in the climate of social and interpersonal relationships.

Therefore, we can find consciousness in the body and in the Mind. Referring to the fingerlength morphological representation of psychic quantity in Mind, we might conclude that it determines intensity of awareness [2].

The land gives rich evidence of the machinery which engineers the child's response to others' adult directions; or by the child's mind self spontaneous order.

At the beginning of the child development, it quite provides the first building blocks of his brain maturity and its personality [3]. Therefore, consciousness of the child's mind, will manifest itself as the drive toward unity, or identification with social perimeters.

We should expect, that the end product would be functional identity alignments defined by social groupings where for example, language may be the basis of partnership [4].

### 2 Research Methodology

The aims of this research are to present the following:

- standards and measures by which the child with graphomotoric difficulties projects its levels of awareness;

- the efficiency of the neuropsychological and psycholinguistic treatment method, placed in educational program.

We had a sample of 30 children, aged from 4 to 7 years; there were 15 boys and 15 girls. All of them are the first born children in their families; have one sibling (brother or sister), and live with their parents, to whom it is the first marriage.

They were divided in 5 groups, each numbering by 6 children who had the same directions.

Directions of the professionals were the following:

- free drawing (using the pencil, eraser, and wooden colours);

- the drawing of the human being ( using the same material);

- the drawing of its family members (using the same material);

- Bender-Gestalt test;

- copy the Cyrillic letters;

- the verbal self - evaluation test, which consisted of the standardised questions, like: "Does your human figure (s) contain each part of the body? Did you omit something? Does your hand hurt after so many drawings? Did you copy everything from this picture? Is your line too much thick in comparison to the original?, etc.

### 3 Results and Discussion

We wanted to evaluate the functional character of functional identity alignments. That is, an identification with rigidly defined social groupings where language along with the pre-school education, may be the basis of partnerships in revealing the levels of consciousness. The measures of the child permitted by conscious evaluation, against his own evaluation or measurement of the social grouping, delivers him to a very real conception of his station, role and function within that grouping [5]. That is, the child will know who he is to those around him. Therefore, we made five groups each numbered with six children, of the same age and with similar graphomotoric difficulties.

In the test situation, all the children had a need to look and compare their own drawings with their peers.

So, 100% of the sample, achieved one level of awareness by comparing in the social group, no matter how they have performed the tasks.

The results on the Verbal Self-Evaluating Test, reveal that 78% of the sample have the level of awareness due to all categories of graphomotoric difficulties, and show the concern about it. The role of the functional character can be seen from the standpoint of adjustments within a given social group, because, there can be different social groupings. Each of them can be with its own order of things, so it can suggest that a child may not have the same station, role, and function within each perimeter.

When a child's needs and drives are made sensitive to the distinct character of the social

organization with which it identifies, its response is to regiment these needs and draw along lines which are allined to the character of that social organization. Certain functions in the child's body energy pattern, will recognize and know things, by exposure to consciousness, which they would otherwise not know. Those which have the capacity to be stimulated by consciousness establish the energy patterns within the Ego. Therefore, they separate what develops as Ego from the energy patterns, which do not respond to circumstances.

In the case of our research work with children, this energy pattern is due to the maturation processes. The levels of consciousness should be evaluated through these processes.

The psychical expressions, which are sublimations of raw biological material, are recognized in the Ego as the counterpart to the instincts, which stay rooted in the Id.

For this reason of a child or a person may be said to have behaved "instinctively", but without any awareness of possibilities, it could not have been the instincts proper which had organized its action. That would have led to have been the manufacture of those same specialized somatic quantities which had known what to expect the actions taken.

The conditioned somatic features, initiate actions with a mind to creating desired condition and circumstances. This corresponds with results obtained in 78% of children, with graphomotoric difficulties whose awareness of their Minds is equal with their performances.

Such awareness will motivate the child to take such adequate and ordered actions as will assure its continued survival in different sections of its mental capacities. Also they will assume its continued survival in as accomodating an enviroment as it can possibly design.

### 4 Conclusions

- (1) The levels of awareness, open the "critical insight", of how is the child performing , here and now;
- (2) The levels of awareness affect the motivation of the child to perform better;
- (3) The levels of awareness have their neuropsychical and biological order of appearance due to the maturation processes.
- (4) The social group play the dominant role in levels and awareness accomplishment. Hence , its role has two polarities: one is positive, because of its motivating factors and the other is negative, which acts as blockade.
- (5) Neuropsychological and psycholinguistic treatment placed in educational program, plays a very important role because it helps the child to reveal its levels of awareness in accordance with its performance.

## References

- [1] D.B. Fry, *The Physics of Speech* (Cambridge Textbooks in Linguistics, Cambridge, 1979.)
- [2] L.S. Vygotskii, *Thought and Speech* (IPS, Moscow, 1956), in Russian
- [3] A.R. Luria, *Fundamental Problems in Neuro-linguistics* (Moscow State University, Moscow, 1975), in Russian
- [4] H. Kohut, *Analisis of Self*, (Zagreb, 1990), in Serbocroat.
- [5] D. Kristal, *Kembridzka enciklopedija jezika* (Nolit, Beograd, 1996)

## A NOVEL NEURAL NETWORK APPROACH TO ESTIMATION OF VIGILANCE LEVEL FROM EEG POWER SPECTRUM

Predrag Šuković<sup>1</sup>, Vlada Radivojević<sup>2</sup>, Žarko Martinović<sup>2,3</sup>, Dejan Raković<sup>1,5</sup> and Emil Jovanov<sup>1,4</sup>

<sup>1</sup>Faculty of Electrical Engineering, Univ. of Belgrade, PO Box 35-54, 11120 Belgrade, Yugoslavia

<sup>2</sup>Inst. for Mental Health, Dept. of Clinical Neurophysiology, Palmotićevo 37, Belgrade, Yugoslavia

<sup>3</sup>Faculty of Medicine, University of Belgrade, Belgrade, Yugoslavia

<sup>4</sup>Institute "M. Pupin", Computer Systems Department, Volgina 15, Belgrade, Yugoslavia

<sup>5</sup>European Centre for Peace and Development (ECPD) of the United Nations University for Peace, Terazije 41, Belgrade, Yugoslavia

**Abstract.** In this paper a novel approach to estimating vigilance level solely from EEG recordings, by means of power spectrum analysis and neural network classifier, is proposed. The same standards for the visual classifying of sleep stages have been in use over the 30 years. Due to severe limitations of existing standards this problem is far from being solved till now. The situation is even more vague with assessing the vigilance level. There is no universally accepted standard for classifying vigilance level during the wakefulness. Existence of no standards is in contrast with the fact that the changes in EEG frequency bands, and occurrence of the patterns assigned to changes of vigilance level are assumed to be known. Different approaches to combination of these known characteristic changes, in order to form meaningful rules have been used by different authors. Therefore, it is not possible to achieve 100% interrater agreement. It suggests that efforts should be directed toward modeling of underlying biological processes. In this work there is an attempt to assess the correlations between power spectrum fluctuations related to changes of vigilance level, without making strong predetermined assumptions concerning their underlying distributions. This is evaluated by means of neural network classifier. The simplicity of implemented procedure allows very fast data processing. This is of particular interest in possible near real time applications in clinical practice.

**Key words:** EEG, vigilance, alertness/drowsiness, power spectrum, neural network, consciousness.

### 1 Introduction

Electroencephalography is a valuable clinical tool for monitoring spatio-temporal fluctuations of the electric fields generated by brain. Due to its noninvasive character, electroencephalography permits more frequent and more convenient monitoring of electrical activity of the brain than electrocortigraphy, which employs electrodes placed on the surface of cortex, and intracellular recordings of electrical activity of single cortical neurons. Epileptic discharges, brain tumors, mental retardation, head injuries, drug overdose, are some of the states whose evaluation is done by visual inspection of EEG recordings in everyday clinical practice [1]. Valuable

efforts have been undertaken, as well, towards monitoring more subtle changes in states of consciousness [2].

The increase in power efficiency of computers allowed development of methods for automatic detection of various states of consciousness based on EEG traces. The first efforts in the field were driven by the belief that there exist some EEG patterns not revealed by the visual inspection of EEG recordings. Now, one of the most important aims is to develop reliable techniques that will be used to replace visual inspection of EEG recordings in order to save time and costs.

Two interesting and to great extent related problems are automatic scoring of sleep stages, and detection of EEG segments of reduced vigilance level during awake stages. The same standards for the visual classifying of sleep stages have been in use over 30 years [3,4]. These standards suffer from severe limitations, and therefore automatic procedures that implement them can not give satisfying results. Hence, despite the advance of computer technology over the past decades, automatic scoring of sleep stages is far from being solved till now [5]. Man/machine agreement of even the best methods is limited by poor interscorer agreement, obtained by comparing results of visual inspection of different electroencephalographers.

The situation is even more vague with the detection of reduced vigilance level segments from EEG recordings. Different approaches have been used to classify the degree of alertness during the awake stages, from subjective ratings, performance tests and neurophysiological measures. Subjective ratings are unreliable because of the fact that feelings such as alertness or drowsiness are poorly defined. Methods based on monitoring performance level like measuring reaction time to some stimuli, cannot give satisfying results as such measurement itself influences the subject's vigilance. It is evident, therefore, that it is the

EEG on which the vigilance level estimation should be based.

However, there are no universally accepted standards for visual classification of vigilance level during the awake stages, based on EEG traces. This is in contrast to the fact that the changes in EEG frequency bands, and occurrence of patterns assigned to changes of vigilance level, are assumed to be known. Different authors have used different approaches to combine these known characteristic changes in order to form meaningful rules. This is obviously evidence of employing erroneous concepts and the efforts should be directed toward modeling underlying biological processes [5].

An effort in this work is done toward finding underlying functional relationship between power spectrum fluctuations related to changes of vigilance level (not using predetermined relationships) in order to estimate vigilance level. This is done by means of neural network classifier. Employing neural network classifier as a structure with modifiable parameters is of benefit for the following reasons: (a) underlying relationships which are assumed to exist, are not known, and are to be found; (b) by supplying the neural network with training sets obtained from recordings on single subject, the network 'learns' individual patterns characteristic for lower vigilance; and (c) the method can be adjusted to correspond to the results obtained by visual inspection of different experts. This allows interaction between electroencephalographers and machine, that will lead to better understanding of underlying principles and therefore to more efficient standards.

## 2 Methods

### 2.1 Subjects and Experimental Set-up

Electroencephalograms of 30 healthy young subjects were recorded. Subjects were aged 20-28 (median: 25), 22 males and 8 females, and have passed neurological screening. Uniformly aged subjects were chosen because EEG changes with age, and universal rules for automatic detection of vigilance level should require much bigger experimental group. Recordings were performed between 2-4 p.m. Subjects were not sleep deprived, nor had any deviations from their usual circadian cycle, and they took no drugs.

Recordings were performed in a quiet, dark, and electromagnetically shielded room. Subjects were placed in supine position on a bed. Recordings were performed on 16 channels of EEG and 2 polygraphy channels on machine MEDELEC 1A97. Electrode positions were according to International 10-20 System: F7, F8, T3, T4, T5, T6, Fp1, Fp2, F3, F4, C3, C4, P3, P4, O1, O2. One channel was used for ECG, and one for respiration. EEG channels were obtained with respect to common (average) reference. We used Ag/AgCl electrodes, with impedance less than 5K $\Omega$ .

Bandpass filter was set to 0.5-70 Hz, and power supply notch filter was used. For AD conversion we used PC AT with ADC board Data Translation 2801 (16 channels, 12 bits) with the sampling frequency of 256 Hz, and commercial software (RHYTHM V.8.0 from Stellate Systems Inc., Quebec, Canada). Simultaneous video recording of patient and his EEG and polygraphy signals was performed as well on VIDIGRAF system. Recordings lasted from 15 to 30 minutes, depending on subject's level of drowsiness i.e. frequency of occurrence of low vigilance segments on corresponding EEG traces. Subjects were not allowed to fall asleep (i.e. further from stage I of slow wave sleep - drowsiness) We required at least two minutes of low vigilance level in total EEG time

EEG signal was analyzed off-line, and epochs without artifacts, characteristic for full wakefulness and for lower vigilance were cut by experienced electroencephalographer and pasted to form two-minute long segments for further computerized analysis. Therefore, for each subject two-minute long segments were used, one as a representative of normal, fully awake state (alert wakefulness), and another one as a representative of drowsy wakefulness.

### 2.2 Numerical Procedures

Single layer perceptron neural network was used for vigilance level assessment. Training and test input vectors were made from one two-minute long segment of alert wakefulness and one of drowsy wakefulness. The state of alert wakefulness was assigned the value of 1, and the state of drowsy wakefulness was assigned the value of 0. These values were supplied to the network as desired output values during the training session.

Segments of 30 sec of both recording were used to construct training sets. The network was tested on the rest 90 sec of each recording. To achieve high processing speed it was necessary to make input vectors of low dimensionality. Also, it was necessary to make the components of input vectors to be easy to compute. Thus, the power spectrum characteristics were used to form the input vectors. Spectral analysis is the most important and most common technique in EEG time series analysis [6]. Due to great inter-individual variations in total power, the relative values were computed, i.e. the power in each frequency band was divided by the total power in all bands.

The slowing of dominant alpha frequency and widening of alpha peak are assumed to be the most important signs of drowsiness. However, it is not possible to see these events through changes of relative power in alpha band. Therefore, alpha band was divided into two bands *alpha1*: 7.5-9.5Hz, and *alpha2*: 9.75-12.5Hz. These boundaries are carefully chosen so that values of relative power in these bands carry the same amount of information as does the shift of the dominant alpha frequency, and widening of alpha peak.

Boundaries of frequency bands used were as follows: 0.5-3.25Hz (delta); 3.5-7.25Hz (theta); 7.5-9.5Hz (alpha1); 9.75-12.5Hz (alpha2); 12.75-18Hz (beta1); 18.25 -25.0Hz (beta2).

Since it is shown in earlier studies [7] that significant differences in EEG patterns between hemispheres during the drowsiness do not occur, power spectrum was computed from the one hemisphere (right).

**Table 1.** Combinations of power spectrum values and electrode positions used to form input vectors.

Frequency band	Electrode position
Alpha 2	O2
Alpha 1	O2
Theta	O2
Theta	F4
Beta 1	F4
Beta 1	C4
Beta 1	O2
Beta 2	F4
Beta 2	C4
Beta 2	T6
Theta/Alpha	O2+F4+F8+C4+T4

Slight vigilance fluctuations can occur in time periods as short as few seconds. Therefore short time epochs were used to compute power spectrum characteristics. The use of 4 sec long epochs provided a good compromise between time and frequency resolution. Frequency resolution was 0.25 Hz, which was good enough to successfully divide spectrum into bands. In order to improve time resolution, epoch overlapping of 2sec was used. Thus, 28 epochs were used for training, and 84 epochs were used for testing.

In order to find the power spectrum characteristics that best reflect the expert's knowledge used for visual classification results from previous studies were consulted as well [7-13]. Characteristics that in combination with perceptron neural net proved to give the most satisfactory results are shown in Table 1. These values were used to form input vectors for both training and testing. Input vectors during the training phase were supplied to the network along with the desired values of output. During training cycle, perceptron neural network assigned the weighting values to each component of the input vectors. These weights were used in testing phase, in order to estimate the level of vigilance. Training network on each subject enabled the network to 'learn' individual fluctuations in EEG spectrum.

Numerical results were computed on a standard PC. Procedures for data manipulation and neural network implementation were developed in Matlab 4.2 environment [14]. Training and testing of the network took a few seconds of CPU time on PC 486/100MHz.

### 3 Results

Results of the procedure applied for five subjects are summarized in **Error! Not a valid bookmark self-reference.**

**Table 2.** Results of perceptron classification of vigilance level, for five subjects.

Subject N°	Training phase			Testing phase		
	N° of vectors	N° of vectors successfully learned	Error rate(%)	N° of vectors	N° of vectors successfully classified	Error rate(%)
1	28	28	0	84	79	5.95
2	28	28	0	84	81	3.57
3	28	28	0	84	83	1.19
4	28	28	0	84	81	3.57
5	28	28	0	84	84	0

### 4 Discussion

This research has shown that automatic detection of fast fluctuations (order of few seconds) of the vigilance level is possible. Moreover, phase space created by variables listed in Table 1 has the property of linear separability of the states of 'alert wakefulness' and 'drowsy wakefulness'. Therefore, it is possible to construct hyperplane that separate these classes. In this work this separation is done by the perceptron neural network. Moreover, the simplicity of implemented procedure allows very fast data processing and near real-time processing, which is of great importance in clinical use. Potential application of the developed procedure is in the area of psychophysiology (cognitive testing during EEG recording, and similar procedures), long-term monitoring of vigilance in clinical medicine (epileptology), and automatic elimination of low vigilance epochs from EEG record when necessary.

### References

- [1] In A. Rémond, ed., *Handbook of EEG and Clinical Neurophysiology* (Elsevier, Amsterdam, 1972).
- [2] M. Tomašević, D. Raković, E. Jovanov, V. Radivojević, and M. Car, EEG correlates of Transcendental Meditation, in this issue; M. Tomašević, E. Jovanov, D. Raković, P. Šuković, S. Stanojlović, and M. Car, EEG correlates of healer/healee states of consciousness, in this issue; E. Jovanov, D. Raković, V. Radivojević, D. Kušić, P. Šuković, and M. Car, Evaluation of states of consciousness using software support for monitoring spatio-temporal EEG changes, ISCA Conf. Comp. Med., Lafayette, 1995.
- [3] A. Rechtschaffen and A. Kales, eds., *A Manual of Standardized Terminology, Techniques and Scoring System for Sleep Stages of Human Subjects* (U.S. Public Health Service, U.S. Government Printing Office, Washington DC 1968).

- [4] N. Ilanković, V. Ilanković, and M. Jašović-Gašić, *Sleep Disorders-Diagnostics and Curing* (Cibif, Belgrade, 1995), in Serbian.
- [5] J. Hasan, Past and future of computer-assisted sleep analysis and drowsiness assessment, *J. Clin. Neurophysiol.* 13 (1996), pp. 295-313.
- [6] E. Basar, *EEG Brain Dynamics* (Elsevier, Amsterdam, 1980).
- [7] K.P. Wright, P. Badio, and A. Wauquier, Topographical and temporal patterns of brain activity during the transition from wakefulness to sleep, *Sleep* 18 (1995), pp. 880-889.
- [8] T. Jung, S. Makeig, M. Stensmo, and T.J. Sejnowski, Estimating alertness from the EEG power Spectrum, *IEEE Trans. on BME* 44, No. 1, 1997.
- [9] M. Matoušek and I. Petersén, A method assessing alertness fluctuations from EEG spectra, *EEG Clin. Neurophysiol.* 55 (1983), pp. 108-113.
- [10] A. Belyavin and N. Wright, Changes in electrical activity of the brain with the vigilance, *EEG Clin. Neurophysiol.* 66 (1987), pp. 137-144.
- [11] M. Nakamura, T. Sugi, A. Ikeda, R. Kakigi, and H. Shibasaki, Clinical application of automatic integrative interpretation of awake background EEG: Quantitative interpretation, report making, and detection of artifacts and reduced vigilance level, *EEG Clin. Neurophysiol.* 98 (1996), pp. 103-112.
- [12] B. Streitberg, J. Röhmel, W.M. Herrmann, and S. Kubicki, COMSTAT rule for vigilance classification based on spontaneous EEG activity, *Neuropsychobiology* 17 (1987), pp. 105-117.
- [13] C. Cajochen, D. P. Brunner, K. Kräuchi, P. Graw, and A. Wirz-Justice, Power density in theta/alpha frequencies of the waking EEG progressively increases during sustained wakefulness, *Sleep* 18 (1995), pp. 890-894.
- [14] *MATLAB 4.0 User's guide* (The MathWorks, Inc., Natick, USA 1994).



## SPECIFIC AND NONSPECIFIC EEG PATTERNS IN PREDICTION OF ELECTROCONVULSIVE ACTIVITY

Sreten Šuljagić<sup>1</sup>, Nenad Rajšić<sup>2</sup>, Julius Ivanuš<sup>3</sup>, Zoran Božović<sup>3</sup>, Aleksandar Kalauzi<sup>3</sup>,  
Dragan Rapajić<sup>1</sup>, and Goran Nedović<sup>1</sup>

<sup>1</sup>Faculty of Defectology, Visokog Stevana 2, Belgrade, Yugoslavia

<sup>2</sup>Institute for Mental Health, Palmotićeveva 37, Belgrade, Yugoslavia

<sup>3</sup>Center for Multidisciplinary Studies, Kneza Višeslava 1, Belgrade, Yugoslavia

**Abstract.** Increased presence of specific and non-specific preictal EEG patterns (K-complexes, spike-wave (SW) complexes, non-specific delta activity etc.) enables prediction of incoming electroconvulsive activity of generalized type. Specific shape of these transients enables computer-based statistical analysis in time domain. The fact that these patterns lay mainly in delta EEG band allows adequate spectral statistical analysis. Results show that cited method early enough and with enough probability predicts incoming ictal EEG activity of generalized type. It also enables recognition of various states of consciousness: alertness, various stages of sleep, normal and pathogenic EEG activity.

**Key words:** EEG, preictal patterns, prediction, coefficient of relative dominant power, method of normalized histograms.

### 1 Introduction

Many systems have been described for the automatic recognition of various interictal epileptiform transients. Such are model-based detectors [1], or machine detectors [2] of various preictal activities. Such devices can locate and quantify paroxysmal activity more rapidly and objectively than can electroencephalographers. The search for better understanding of interictal and ictal phenomena is motivated by the urgent need for therapeutically applicable seizure preventing strategies including warning devices. [3]. A seizure warning system would allow patients and observers to take appropriate precautions, to avoid danger to the patient [4].

Our ultimate goal is also to develop a warning device of a holter type. [5]. Using adequate parameter's evaluation of preictal EEG signal such a device can early enough and with enough probability predict incoming ictal EEG activity.

### 2 Material and Methods

Six 8-channel EEG records are analyzed. They are obtained in the laboratory of Epilepsy Department, Institute for Mental Health. Four records are obtained

from two patients in sleep stage. Fifth record originates from a long-term monitoring patient with mixed sleep and alert intervals. These five records are terminated with ictal discharges. Last, control record is obtained from a patient who in the previous two weeks was without ictal EEG discharges.

Next 8-channels bipolar montage is used: F<sub>p</sub>2-F4, C4-P4, F8-T4, T6-O2, F<sub>p</sub>1-F3, C3-P3, F7-T3, T5-O1. A 50 microvolts calibration signal is used. Obtained EEG signals with an 8-level A/D converter are sampled. Sampling frequency was 128Hz. Such digitized signals were off-line analyzed in frequency domain in the following EEG bands:  $\delta$  (1-3.75 Hz),  $\theta$  (4-7.75 Hz),  $\alpha$  (8-11.75 Hz),  $\beta_1$  (12-19.75 Hz), and  $\beta_2$  (20-31.75 Hz). Artefact free segments are used. Four-second EEG epochs are used. Adequate spectral powers are calculated.

Descriptive statistical computer-aided analysis is used. It enables us to study preictal EEG activity [6]. Aiming to manifested electroconvulsive discharge prediction, a series of parameters of descriptive statistic is introduced. A set of critical predictive values of these parameters is adopted [7].

As a basic descriptive parameter coefficient of relative dominant power  $K_{RDP}$  is calculated. It is defined as a ratio of two powers: the power of the dominant EEG band and the power of the remaining EEG band. As a statistically significant predictive value  $K_{RDP} > 3$  (at least 75% of total power is in a dominant EEG band) is adopted [8]. For a time window of five successive EEG epochs (20 second interval) mean value of  $K_{RDP}$  is calculated. Using a method of moving window [9], windows limits are translated an epoch forward. Later a method of normalized histogram is used [10]. Predictive mean  $K_{RDP}$  values greater than 3 are normalized with a level value equal 1, and smaller  $K_{RDP}$  values are normalized with a zero level. Two-level normalized histograms of mean  $K_{RDP}$  value are obtained. Like a predictive criterion, a successive appearance of level 1 in a time interval greater or equal 40 seconds (two windows width), is adopted.

### 3 Results and Conclusion

Time domain analysis of preictal EEG records shows an intensified EEG activity, especially in a sleep state [11]. With their characteristic shapes and prominent amplitude in an EEG record dominate K-complexes, non-specific delta waves and SW activity. Spectral analysis of such EEG records points to increased delta activity. Method of moving histograms gives considerable numbers of predictive histograms. For a control patient such diagrams are not obtained. Conclusion is that the afore mentioned method due to intense presence of specific and non-specific EEG patterns early enough end with enough probability predicts incoming ictal activity. It suggests that developing of a warning device of a holter type is possible.

#### References

- [1] A.C. Darosa, A model-based detector of vertex waves and K complexes in sleep electroencephalogram, *EEG and Clinical Neurophysiol.* 78, (1991), pp. 71-79.
- [2] J.W. Whisler, Machine detection of spike-wave activity in the EEG and its accuracy compared with visual interpretation, *EEG Clin. Neurophysiol.* 54, (1982), pp. 541-551.
- [3] H.G. Wieser, Interplay of interictal discharges and seizures: some clinical and EEG findings, in P. Wolf ed., *Epileptic Seizures and Syndromes* (John Libbey and Company Ltd, 1994), pp. 563-578.
- [4] H.Qu, A Patient-Specific Algorithm for the Detection of Seizure Onset in Long-Term EEG monitoring: Possible Use as a Warning Device, *IEEE Trans. Biomed. Eng.* 44, (1997), pp. 115-122.
- [5] S. Šuljagić, *Prediction of the Manifested Electroconvulsive Episodes on Experimental Model*, Master Thesis (Center for Multidisciplinary Studies, Belgrade, 1990), in Serbian.
- [6] S. Šuljagić, Application of some descriptive statistical parameters in the analysis of preictal EEG activity, in *Abstracts of the II Congress of Yugoslav Neuroscience Society with International Participation* (Sveti Stefan-Kotor, 1-3. June, 1995), p. 161, in Serbian.
- [7] S. Šuljagić, The predictive role of t-histograms of crosscorrelation coefficients in the analysis of ictal EEG activity, *EEG Clin. Neurophysiol.* 99, Abstract, pp. 320.
- [8] S. Šuljagić, et al., Prediction of generalized epileptic EEG Activity of grand-mall type on experimental and human model, in Lj. Rakić, D. Raković, D. Koruga, and A. Marjanović, eds., *Consciousness: Scientific Challenge of 21th Century*, Proc. EPCD Seminar (Belgrade, 1996), pp. 94-96, in Serbian.
- [9] S. Šuljagić, A method of moving windows in the analysis of graphoepileptic EEG records, in *Abstracts of IV Congress of Yugoslav Neurologists* (Niška Banja, 1996), p. 24, in Serbian.
- [10] S. Šuljagić, Application of a method of normalized histograms in prediction of ictal EEG activity, in *Abstracts of the XV Yugoslav Symposium of Epileptology with International Participation* (Belgrade, 1996), p. 25, in Serbian.
- [11] M.G. Terzano, Effects of generalized interictal EEG discharges on sleep stability: Assessment by means of cyclic alternating pattern, *Epilepsia* 33 (1992), pp. 317-326.

## YOGA, SCIENCE AND CONSCIOUSNESS

Swami Sivamurti Saraswati

Satyanandashram Centre of Yoga, 19400 Koropi, Greece

**Abstract.** Contemporary science acknowledges all matter as energy. The human mind can affect this energy through systematic yoga practice, and our thought processes can change as a result. This evolution of consciousness is scientific in basis. Long ago Plato said that to be complete, science must include philosophy, religion and art. With the advent of the scientific revolution, the intellect became the sole province of scientific inquiry, and all other aspects of our being were relegated to art, philosophy or religion. Scientists separated themselves from the idea of purpose in the universe, and attempted to manipulate nature, rather than surrender to her wisdom, and work in harmony with her. However, with the advent of atomic physics, it became apparent that reality transcends logic and sensory perception. Scientists are now compelled to deal with a non-sensory experience of reality, and the paradoxical aspects of this experience. This has led physicists, in particular, to sense a harmonious relationship between their view of the world, and the esoteric systems of eastern thought such as yoga.

When yoga first came to the west its focus was on physical health, but this is only a very small area of the immense art and science of yoga. The aim of all yogic practices is to develop awareness. Consciousness is the experiential intelligence that manifests through awareness, and consciousness is a continuous stream of the state of being. The experience of consciousness is different from the experience of the senses and their link with the mind. With consciousness, one not only knows oneself, but the underlying unity of all creation. Consciousness of the self is synonymous with consciousness of the universe.

Yoga views the mind as four-fold: conscious, subconscious, unconscious and superconscious. To experience the consciousness, one must transcend the mind, and this is achieved, not within the mind, but by going beyond the mind. The practice of going beyond the mind is called

meditation. Meditation is the means to bring the oscillations of the mind to a state of one-pointed concentration, and full awareness of our state of being, in the totality of the present moment. In this state of awareness one is the observer, the act of observing, and the object of observation, simultaneously. One transcends the limitations of the known mind, and experiences another dimension and comprehension of reality.

As atomic physics teaches us that all is energy, and that when the atom is split there is an enormous explosion of energy, so in the state of meditation, there is a comparable release of internal energy - an inner awakening which the mystics and yogis have been describing for centuries. Both experiences are beyond the confines of normal linguistic expression, and the common knowledge of the conscious mind, and translatable only in terms of symbols and archetypes. The paradoxical nature of this experience is one of homogeneous awareness, where there is existence, but you are not there. The 'I' is completely dissolved in the totality of existence itself. Time and space are no longer there, but are brought together through fusion, and as these two elements constitute part of the mind, when this internal explosion takes place, your awareness and knowledge of reality is fused with that of universal consciousness, and there is no longer a point of separation.

Both science and yoga are ways to arrive at the same goal: the ultimate experience of reality. We live at a moment of human history when both paths are coming together to complement and share each other's knowledge, in order to lead humanity into another dimension of knowledge and being, where our essential unity is the underlying paradigm, and not our diversity.

**Key words:** *consciousness, yoga vs. science, ultimate experience of reality.*

# FORMALIZATIONS ON THE BASE OF POLYCONTEXTURAL LOGIC AND QUALITATIVE MATHEMATICS. A HETERARCHICAL APPROACH OF MATHEMATICS AND LOGIC ON NETWORKS FOR THE VERY LARGE AND COMPLEX SYSTEMS OF THE LIVING BRAIN AND A DYNAMIC CONSCIOUSNESS.

Gerhard G. Thomas

Freie Universität Berlin, Universitätsklinikum Benjamin Franklin, Abteilung Medizinische Informationsverarbeitung, Hindenburgdamm 30, D-12200, Germany

**Abstract.** The multitude of facets given by the different fields of brain research and the wide spectrum of research on consciousness is in urgent need to be joined together. Logical and mathematical Systems are worked out to manage the joining of very different qualities. Brief introductions to *polycontextural logic* ( a many-valued logic organizing different contextures, working on networks by very simple commands ) together with a basic concept of *qualitative mathematics* are given.

This qualitative mathematics itself is based on a concept of *qualitative numbers*. Qualitative numbers are simultaneously joined by five categories:

**Key words:** *polycontextural logic, non-standard logic, qualitative mathematics, mathematics on networks, logic on networks, permutography, kenogramatics, complex systems, very large complex structured living systems, structured brain, structured consciousness, information pilot systems with association structures, processing order systems, cybernetics of the second kind.*

## 1 Place, Symbol, Relation, Structure, Change.

A qualitative number on this background is a composition of  $n$  qualities on  $n$  places . That means a qualitative number is a complex of  $n$  so called *values*. Here, a value is defined as an entity which is 'worth' to be separated as an own unity (monad, holon, quality ) and has its own place. A value can have its own complexity - from an atom to again a complex system - marked by a *symbol*. The two kinds of symbols are related to closed or open systems. The whole concept can be applied to ontological *and* spiritual entities. The important philosopher and logician Gotthard Günther (1900-1984) was the founder of a real many-valued logic. He related every monad (value) its own logical value and complemented the Günther-logic to the polycontextural logic.(PCL). My part was it to visualize PCL and to develop a couple of extensions for the PCL to get practical applications. In 1979 I called this extended system *permutographical system*. A *very brief introduction to Kenogramatics* (also invented by Günther on linear emptiness-structures

and extended by me both to all kinds of joined or unjoined emptiness-structures and higher space dimensions) as an extreme mighty tool to analyze *structures* by a theory of emptiness is touched.

### Brain Consciousness

**Basic Kenogramatic Levels of structured Thinking**

**Qualitative Numbers** -Permutographs - a joined system of monads.

**Examples of Qualitative Structured Systems:** Oligodendrocytes, axontree, reticular formation, hypophysis, cortical layer, routed and piloted complex, information systems.

Reforming of rigid Universities into living institutions open for new combinable developments.

### Supplement: Graphics

### Reference

- [1] Giordano Bruno Über die Monas, die Zahl und die Figur als Elemente einer sehr geheimen Physik, Mathematik und Metaphysik, (Felix Meiner Hamburg 1997), translated from the Latin.
- [2] Heinz von Foerster Article in: (Encyclopedia of Artificial Intelligence, Wiley, 1987).
- [3] Gotthard Günther Beiträge zur Grundlegung einer operationsfähigen Dialektik (Felix Meiner Verlag Hamburg, 1976 - 1980). Band 1 1976, Band 2 1979, Band 3 1980 mit dt. u. engl. Register.
- [4] Gotthard Günther Idee und Grundriß einer nicht-Aristotelischen Logik (Felix Meiner Verlag Hamburg 1991). 3. erweiterte Auflage.
- [5] Gotthard Günther Das Bewußtsein der Maschinen (Agis-Verlag, Baden-Baden, 1963).
- [6] G. W. F. Hegel Werke in zwanzig Bänden. (Suhrkamp Verlag Frankfurt am Main 1979).

- [7] Engelbert Kronthaler Grundlegung einer Mathematik der Qualitäten, Zahl Zeichen Spur Tao (Verlag Peter Lang , Bern-Frankfurt a. M.-New York 1986).
- [8] David Loye Gehirn, Geist und Vision, (Sphinx Verlag, Basel, 1986) transl. from the Am., orig. title: The Sphinx and the Rainbow, (Shambhala 1986)
- [9] Warren St. McCulloch Embodiments of Mind, (MIT Press, Mass., 1970) .
- [10] Pierre Morell and Myelin, Spektrum der Wissenschaft Juli (1980), p. 12. Also in: Gehirn und William T. Norton Nervensystem, (1986<sup>7</sup>), p. 69. Graphic of Oligodendrocytes, used with permission of Verlag Spektrum der Wissenschaft, Heidelberg.
- [11] Gerhard G. Thomas On Permutographs, in: Proceedings of the 10th Winterschool of Abstract Analysis, Suppl. ai rend. del Circolo Mat.di Palermo, Serie II, No. 2 (1982).
- [12] Gerhard G. Thomas Introduction to Kenogramatics In: Proceedings of the 12th Winterschool of Abstract Analysis Suppl. ai rend. del Circolo Mat. di Palermo, Serie II, No. 11 (1985).
- [13] Gerhard G. Thomas On Kenogrammatic Numbers, Structures and Relations In: Proceedings of the 14th Winterschool of Abstract Analysis Suppl. ai rend. del Circolo Mat. di Palermo, Serie II, No. 11 (1986)
- [14] Gerhard G. Thomas On Permutographs II, in: Gotthard Günther -Technik, Logik, Technologie Technik -u. Wissenschaftsforsch. Bd. 24, (Profil Verlag München-Wien 1994).
- [15] Simon Le Vay Keimzellen der Lust, (Spektrum Akad. Verlag, Heidelberg, Berlin; Oxford, 1994). Original title: The sexual Brain, (MIT Press, Cambridge, Mass., 1994).
- [16] Ken Wilber Eros, Kosmos, Logos, (Wolfgang Krüger Verlag, Frankfurt a. M., 1996<sup>2</sup>) Orig. Title: Sex, Ecology, Spirituality, (Shambhala Publ., 1995).

## EEG CORRELATES OF TRANSCENDENTAL MEDITATION

Milorad Tomašević<sup>1</sup>, Dejan Raković<sup>2,3</sup>, Emil Jovanov<sup>2,4</sup>, Vlada Radivojević<sup>5</sup>, and Marko Car<sup>6</sup>

<sup>1</sup>“Vinča” Institute of Nuclear Sciences, PO Box 522, 11001 Belgrade, Yugoslavia

<sup>2</sup> Faculty of Electrical Engineering, PO Box 35-54, 11120 Belgrade, Yugoslavia

<sup>3</sup> European Centre for Peace and Development (ECPD) of the United Nations University for Peace, Terazije 41, Belgrade, Yugoslavia

<sup>4</sup> Institute "M. Pupin", Computer Systems Dept., Volgina 15, Belgrade, Yugoslavia

<sup>5</sup> Institute for Mental Health, Dept. of Clinical Neurophysiology, Palmotićevo 37, Belgrade, Yugoslavia

<sup>6</sup> Institute for Biological Research, Center for Multidisciplinary Studies, 29. Novembra 142, Belgrade, Yugoslavia

**Abstract.** Transcendental meditation (TM) is one of the most easily reproducible altered states of consciousness. In this paper the EEG correlates before and during the TM technique are evaluated within a group of 25 meditators. Meditators as a group showed a significant increase of theta activity (4-8 Hz) in meditation ( $z=2.00$ ,  $p=0.046$ ). This effect is dominant in left frontal (F3) and right temporal (T4) regions at frequency of 8 Hz. Slow alpha (8-10.5 Hz) and alpha (8-13 Hz) activity increased significantly in temporal region (T3-T4). Slow beta (13-18 Hz) activity increased significantly in prefrontal region (Fp1-Fp2). Correlation dimension did not decrease significantly, but there was significant correlation ( $r=-0.55$ ,  $p=0.026$ ) between the decrease of the correlation dimension and increase of the partial EEG power in slow alpha and alpha bands.

**Key words:** EEG, consciousness, altered states, transcendental meditation (TM) spectral analysis, chaos, correlation dimension.

### 1 Introduction

The key problem of any future theory of consciousness is how to incorporate altered states of consciousness [1] (REM sleep, meditation, hypnosis, psychedelic drug influence, some psychopathological states, near-death experience...) within a new paradigm. It should be pointed out that purely biochemical mechanisms of the extended reticular-thalamic activating system (serving as a selector and amplifier of the conscious content out of many other currently processed nonamplified contextual unconscious contents) are not accelerated up to several orders of magnitude, as the subjective time sense is dilated in altered states of consciousness - in respect to the normal awake state.

According to the biophysical model for altered states of consciousness (developed by one of us, D. R. [2-4]), the electromagnetic (EM) component of ultralowfrequency (ULF) brainwaves, related to "subjective" reference frame of consciousness, enables perfect fitting with narrowed-down limits of conscious capacity in normal awake states and very extended

limits in altered states of consciousness - due to the biophysical relativistic mechanism of dilated subjective time base. In this model, consciousness is subtle internal display in the form of EM component of ULF brainwave ionic currents, in which complete information (both conscious and unconscious) is permanently coded from brain's neural networks, as a spatio-temporal pattern resulting from changes of the electrosynaptic interconnections in the neural networks of the brain. Then, according to this model, altered states of consciousness (REM sleep, meditation, hypnosis, psychedelic drug influence, some psychopathological states, near-death experiences...) are a consequence of partial displacement of the ionic acupuncture system outside the body (when the embedded EM component of ULF brainwaves is propagating through this weakly ionized structured gaseous medium of low-dielectric relative permittivity  $\epsilon_r \approx 1$ ),<sup>a)</sup> while normal states of consciousness (alert state, non-REM sleep...) are

a) The biophysical nature of low-dielectric ( $\epsilon_r \geq \epsilon_r' \approx 1$ ) structure has also been analyzed [2-4]: this structure could be related to partly displaceable (from the body) unhomogeneous ionic acupuncture system, which can conduct ULF brainwave currents  $\sim 10^{-7}$  A, inside the conductive channels of the initial ionic concentration  $\sim 10^{15}$  cm<sup>-3</sup>, with a tendency of deterioration during a period of  $\sim 1$  hour. As a consequence of the deterioration process, the displaced part of the ionic acupuncture system can be finally "emitted" together with the informational content of the embedded ULF EM waves. Even the conditions for ULF EM field localization are not fulfilled at the end of deterioration process, as then ULF brainwave currents can flow through the surrounding weakly ionized ( $\sim 10^4$  cm<sup>-3</sup>) atmosphere, which significantly enlarges linear dimensions of the dipole source and therefore the intensity of irradiated ULF EM field. The long-range phenomena of this type are energetically supported by the existence of extremely low attenuation at ULF frequencies due to "Schumann resonances" of the earth-ionosphere cavity, well matched with EEG-spectrum [5]. The above mechanism has probably been of adaptational significance for animal species, in highly efficient global spreading of survival-important novel information [6]; inside the human population, it seems that the Maharishi effect is providing evidence [7] for the above possibility - which can be the biophysical basis of Jung's collective unconscious [8]. In that context, it could be said that ionosphere represents a dynamic collective memory of all biological species, which is continuously being refreshed by biological units with periodicity and phase of their ultradian rhythms. Further deterioration of the points of the displaced part of the ionic acupuncture system makes the whole ionic system homogeneous, without a possibility for new information to reach the subjective reference ULF EM component of brainwaves [3], bringing the ultimate transpersonal state of thought-free consciousness (nirvana, samadhi, satori, enlightenment, ... [9]). Objectively, the whole ionic system is completely open to information exchange in ULF domain, bringing the sense of oneness with the surrounding world, and subjectively, this is the state of empty consciousness, although the brain neural network can be still very active. This state lasts very shortly in nontrained persons, but presumably can be prolonged in trained persons. The lost part of the ions (of the initial concentration  $\sim 10^{15}$  cm<sup>-3</sup>) is insignificant in comparison with that which exists in the body ( $\sim 10^{20}$  cm<sup>-3</sup> [10]), and can even be regenerated during the breathing process in  $\sim 1$  h.

achieved when there are no such displacements (when brainwaves are propagating only through the structured brain tissue of high-dielectric relative permittivity,  $\epsilon_r \gg 1$ )! It should be also pointed out that it might not be quite accidental for consciousness to be related to the EM field of ULF brainwave currents, as the intensity of irradiated ULF EM field is extremely low, giving rise to consciousness localized around the body.

The aforementioned relativistic mechanism also enables the dream-like mixing of the normally conscious and unconscious contents in altered states, due to the relativistic Doppler mapping of EM component of the "objective" ULF brainwaves power spectrum on the zero-degenerate frequency "subjective" one - revealing their psychological significance [2,3]: in dreams one has continuous access and more efficient "subjective" integration of normally conscious and unconscious contents, giving rise to integration and growth of human personality (otherwise divided into conscious and unconscious associative "ego states"), which also results in alleviation of emotional conflicts.

Then, in the framework of the model, biophysical nature of the ultimate goal of yoga and related esoteric disciplines [9] is the prolongation of altered state 24 hours a day, with continuously displaced ionic system. This means that ultradian rhythm does not exist any more, which can be achieved through the gradually enhanced functional connectioning of the left and right brain hemispheres (their prevailing dominance being normally governed by ultradian rhythm [11]). So, meditation, as a prolonged altered state of consciousness, enables more efficient "subjective" integration of human personality, this being its major role in the growth of human personality (however, if a person bears strong internal psychic conflicts i.e. "ego states", the result of such a prolonged meditation will be integration of human personality around the foregoing several "ego-states", with undesirable result of multiply divided, instead of well integrated personality; competent teachers of meditation are fully aware of these perils, and do not recommend its accelerated practice to psychically weak persons, for

whom the main priority is a reprogramming of psychic conflicts [12]).

This was our motivation to start examination [13] of EEG correlates of meditation, and particularly transcendental meditation (TM), as one of the most easily reproducible altered state of consciousness [14-16].

The TM technique is normally practiced for periods of twenty minutes twice a day. The subject is instructed to sit quietly with eyes closed and is then taught to repeat a certain type of sound or "mantra" according to a particular definite set of instructions. The mantras are a set of short speech sounds, meaningless in themselves, preserved by an ancient vedic tradition and assigned to individuals by the instructor on the basis of a set of objective rules which he is trained to apply. They are chosen so as to "resonate" with the structure of an individual nervous system.

Subjectively, the meditator usually reports an immediate sense of bodily quiet and relaxation. An important feature of the subjective experience of the TM technique is an "expansion" of consciousness. As the mantra is experienced in successively finer stages, subjects report that the spatial extent of conscious self-awareness, which ordinarily seems to be localized in the area of head and upper body, undergoes a progressive expansion.

Wallace [15,16], Orme-Johnson and Farrow [16], among others, have reported physiological changes during the practice of the TM technique that are consistent with these predictions, such as reduced oxygen uptake, reduced CO<sub>2</sub> elimination, constant respiratory quotient, reduced respiratory minute ventilation, reduced respiratory frequency, reduced hearth rate, increased basal skin resistance, and EEG changes indicative of alertness. Wallace was led to propose that the TM technique produces a fourth major state of consciousness in which the mind remains alert while mental activity reaches the least excited state. A summary of the EEG correlates of states of Human Consciousness, given by Wallace [15,16], is shown in Table 1.

**Table 1.** EEG Correlates of States of Human Consciousness, after R. K. Wallace [15,16].

WAKEFULNESS	DEEP SLEEP (Stage 4)	DREAMING (Stage 1 - REM)	TRANSCENDENTAL
Low voltage mixed frequency and/or alpha activity (9-11 Hz). Alpha activity increases with eyes closed. A moment of tension or an attempt to solve a mental problem may disrupt it. Tiredness or drowsiness is characterized by a flattening of the alpha waves to low voltage mixed frequency waves with an increase in activity in the 2-7 Hz range.	Decrease in regular activity and increase in sleep spindles (14-15 Hz, 20-40 mV), K complexes, and 2-7 Hz activity. When 50% of the epoch consists of waves of 2 Hz or slower that has amplitudes greater than 75 mV, the EEG record is defined as stage 4 or deep sleep.	Low amplitude (25-50 mV), variable frequency waves accompanied by episodic REM's and quiescent EMG's. Resembles that of stage 1 of sleep except vertex sharp waves are not prominent. Saw-tooth waves frequently but not always appear in vertex and frontal regions in conjunction with a burst of a REM. Alpha activity (9-11 Hz) is more prominent than during stage 1 sleep, and the frequency of the alpha waves is lower by 1 or 2 Hz than that of the alpha waves of wakefulness. An absolute absence of sleeps spindles and K complexes (first REM period is interspersed with spindles).	Increase in alpha-wave activity (usually 8-9 Hz activity) that occurs in the central and frontal regions. Sometimes rhythmical theta-wave activity (5-7 Hz) appears in the frontal regions.

## 2 Method

**SUBJECTS** - The study was carried out on 25 healthy adult volunteers who had been practicing the TM technique from 0.2 to 25 years, with a mean of 7.2 years. There were 15 males and 10 females, whose ages ranged from 17 to 68 years with a mean age of 32 years. All subjects were free of any medication. Prior to the experiment subjects were informed verbally about all aspects of the experimental procedure.

**APPARATUS** - Electroencephalographs were recorded in an electromagnetically shielded room by a MEDELEC 1A97 EEG machine, with lower and upper band-pass filter limits set at 0.5 Hz and 30 Hz, respectively. Ag/AgCl electrodes with impedance less than 5 k $\Omega$  were placed at 16 locations (F7, F8, T3, T4, T5, T6, Fp1, Fp2, F3, F4, C3, C4, P3, P4, O1, O2) according to the International 10-20 system with average reference. The EEG output was digitized with 12-bit precision at a sampling rate of 128 Hz per channel using A/D converter Data Translation 2801.

**PROCEDURE** - The experiment was conducted in a sound-proof room, dimly lit for observation. Subjects were seated comfortably. Each recording session was divided into two sequential periods:

1. relaxing 5 min with eyes closed;
2. meditating 15 min.

During those periods two random samples, one minute each was recorded for every subject. The EEG record was stored on a hard disk.

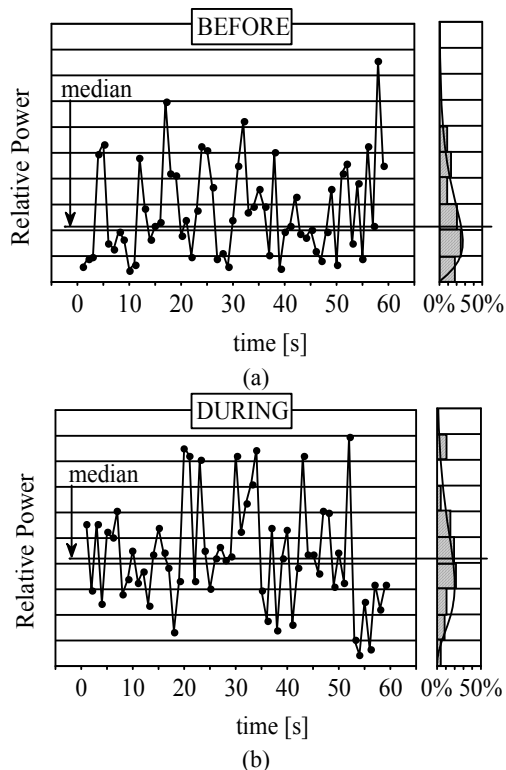

**Figure 1.** Time histories and histograms for the partial EEG power in alpha band fitted with Gamma distributions: (a) before and (b) during the TM period (subject 1, derivation O1).

**DATA ANALYSIS** - The length of each EEG-trace was 60 s (7680 points). The following measures were calculated for every EEG trace:

- **Spectral Analysis.** Time-varying EEG spectra (spectrograms) with 0.5 Hz resolution were calculated by the MATLAB program using a 256-point FFT algorithm performed on 2 s Hamming-windowed, half-overlapped epochs. An array of EEG partial power spectra for each subject and each derivation was computed by integration by the trapezoidal rule of the spectrogram over the four frequency bands:  $\theta$  (from 4 to 8 Hz),  $\alpha_1$  (from 8 to 10.5 Hz),  $\alpha$  (from 8 to 13 Hz), and  $\beta_1$  (13 to 18 Hz). Since those arrays are not distributed in a Gaussian manner (Fig. 1), the Wilcoxon matched pairs test and sign test were used to determine significant differences between the spectral arrays of the relaxing period and the spectral arrays of the meditation period.

- **Correlation Dimension.** The singular value decomposition [17] was based on the autocovariation function with time lags from 0 to 32 points. A symmetrical 32 $\times$ 32 matrix was constructed with the covariances as elements. The diagonal element was always the covariance with time lag zero. Then the eigenvectors and eigenvalues were obtained. A subset of eigenvectors corresponding to eigenvalues larger than twice the smallest of all 32 eigenvalues, was used to reconstruct the state space [18]. This selection was used to separate the signal from the noise. A calculation of the correlation dimension was done separately for 32 equidistant reference points of EEG record using the method of 'pointwise dimension' [19,20]. The number of points  $N(r)$ , which lie in a hyper sphere with radius  $r$  around the chosen reference point, is counted. This counting is performed for subsequently larger radii until ultimately all points of the time series lie within this hyper sphere. The distance between subsequent radii was so selected that each enlargement of the radius increased the total count by an exponential increasing number of points, i.e.  $N(r_{i+1}) = 2N(r_i)$ ,  $N(r_1) = 2$ . The logarithm of counts,  $\log[N(r_i)]$  are plotted against  $r_i$ . A linear fit is performed on the resulting function. If the point with the highest (or lowest) abscissa value has the largest distance to the straight line, this point is rejected and the linear fit is recalculated. The process is repeated until the extreme points have no more the largest distance from the estimated straight line or there are five points left only. After a slope and a maximum deviation were calculated for each of the reference points, the median of 20 points with the lowest maximum deviation determines the desired correlation dimension.



### 3 Results

The representative examples of spectral arrays and a sample of the corresponding EEG record in our subjects (N<sup>o</sup>s 1 and 12) with slow alpha activity and theta burst during meditation, respectively, are shown in Figs. 2 and 3.

In order to determine the type of changes (four categories: increase, significant increase, decrease, and significant decrease) in partial EEG power spectra for every subject, the two corresponding sets of medians of arrays of partial EEG power for each derivation, before and during meditation, were compared using Wilcoxon matched pairs tests.

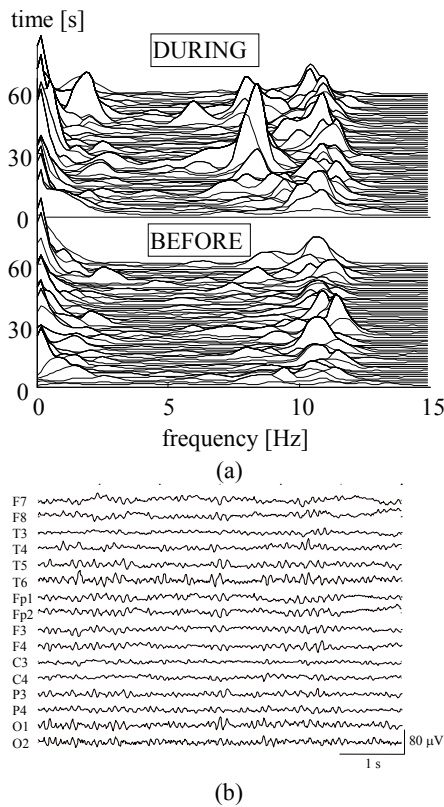

**Figure 2** (a) Compressed power spectral arrays of the EEG for subject 1 obtained from the electrode P3 before and during meditation, and (b) EEG traces during meditation showing the slow alpha waves at 8 Hz.

After summation, the sign test was done on the total numbers of subjects showing increase and decrease of power, for each frequency band. Results presented in Table 2 show that the increase of theta activity in meditation was significant ( $z=2.00$ ,  $p=0.046$ ). At slow alpha frequencies ( $\alpha_1$  range), 12 (52%) subjects showed significant power increase opposite to 4 (16%) subjects that showed significant power decrease during meditation.

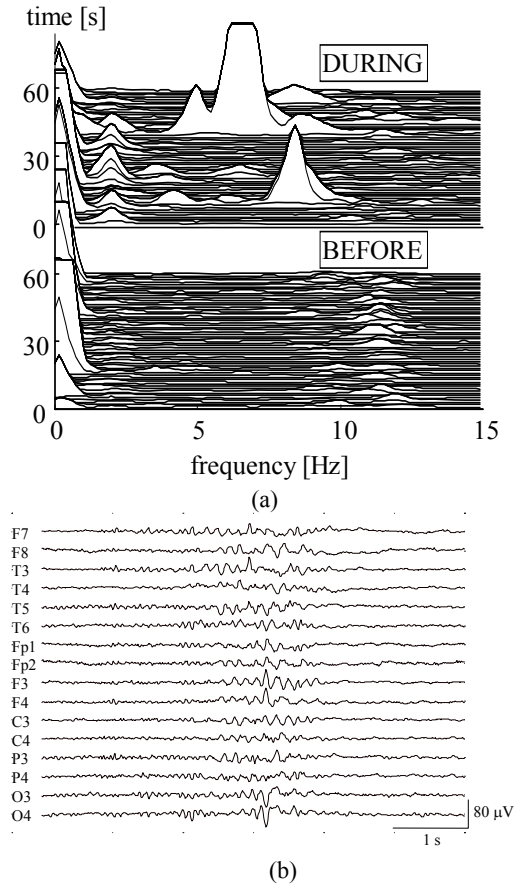
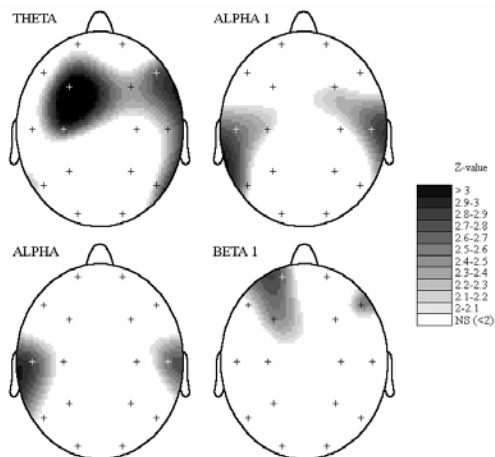

**Figure 3** (a) Compressed power spectral arrays of the EEG for subject 12 obtained from the electrode F3 before and during meditation, and (b) EEG traces during meditation showing a theta burst at 6 Hz.

**Table 2.** Comparison of Number of Subjects Showing Increase and Decrease of Partial EEG Power

BAND	EFFECT	N <sup>o</sup> OF SUBJECTS			SIGN TEST SCORES	
		S*	NS**	S	z	p
Q	power increase	10	8	18	2.000	0.046
	power decrease	4	3	7		
$\alpha_1$	power increase	12	4	16	1.200	NS(0.230)
	power decrease	4	5	9		
$\alpha$	power increase	13	3	16	1.200	NS(0.230)
	power decrease	7	2	9		
$\beta_1$	power increase	9	5	14	0.400	NS(0.689)
	power decrease	6	5	11		

\* S = significant; \*\* NS = not significant



**Figure 4.** The topographic mapping of significant ( $p < 0.05$ ) z-values of partial EEG power for each frequency band; Wilcoxon matched pairs test; inv. distance method.

The comparison of the medians of partial EEG power for one derivation was performed using Wilcoxon matched pairs test. Fig. 4 shows the spatial distribution of the changes (z-scores) over the whole head. Shaded areas indicate the fields that have significant power increase. The primary sources of differences were the left frontal region (F3,  $z = 3.24$ ,  $p = 0.001$ ) in  $\theta$ -band, right temporal region (T4,  $z = 2.65$ ,  $p = 0.008$ ) in  $\alpha_1$ -band, left temporal region (T3,  $z = 2.73$ ,  $p = 0.006$ ) in whole  $\alpha$ -band, and left prefrontal region (Fp1,  $z = 2.59$ ,  $p = 0.01$ ) in  $\beta$ -band.

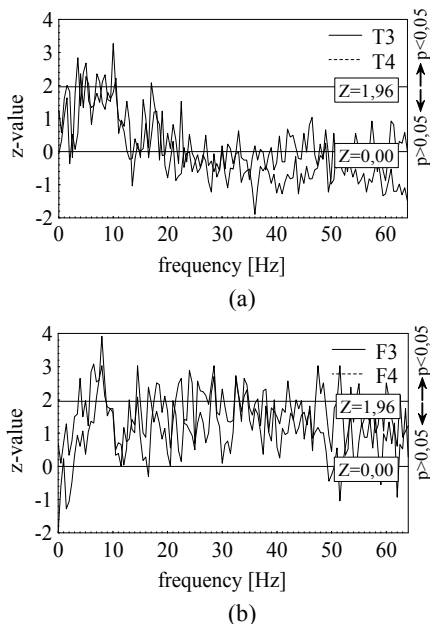
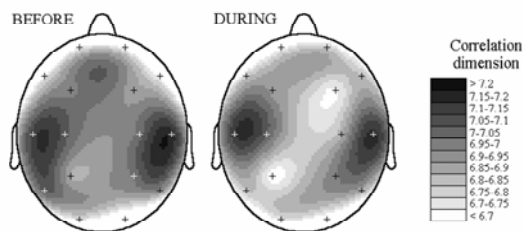

**Figure 5.** Z-scores of power spectral density against the frequency over the entire band (0-64 Hz); (a) derivations T3 and T4, and (b) derivations F3 and F4; Wilcoxon matched pairs test.

Furthermore, we examined the EEG power changes for channels T3, T4, F3, and F4 for each single frequency over the entire band (0-64 Hz) with

resolution of 0.5 Hz by calculating the arrays of power spectral densities for those channels, estimating the medians for every frequency and performing the Wilcoxon matched pairs test, successively. The results obtained in this way, i.e. the z-values of Wilcoxon matched pairs test versus frequency, are shown in Fig. 5. Frontal region (F3/F4) showed the power significantly increases in range 7-8.5 Hz. Very significant difference ( $z = 3.91$ ,  $p < 0.0001$ ) between the power spectral densities of channel F3 before and during meditation is at frequency of 8 Hz. Temporal region (T3/T4) showed an increase in several frequencies in the theta range, and the very significant increase ( $z = 3.28$ ,  $p = 0.001$ ) at 10 Hz.

Spatial distributions of medians of correlation dimension over the whole head before and during meditation are given in Fig. 6. Although there are no statistically significant changes, a decrease in correlation dimension in right frontal and left parietal regions is obvious. In Fig. 7 the z-scores obtained by comparison of the medians of correlation dimension of each channel of every subject, prior and during meditation is given. Wilcoxon matched pairs test was applied.



**Figure 6.** Spatial distribution of the correlation dimension before and during meditation.

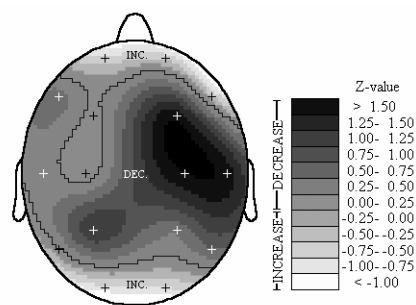

**Figure 7.** The topographic mapping of z-values of correlation dimension; Wilcoxon matched pairs test.

It should be particularly stressed that there exists a significant correlation (Table 3) between z-values of the correlation dimension and the z-values of partial EEG power in  $\alpha_1$  and  $\alpha$  band (Pearson product-moment correlations:  $r = -0.55$ ,  $N = 16$ ,  $p = 0.026$ , Spearman rank order correlations:  $r = -0.53$ ,  $N = 16$ ,  $p = 0.033$ ).

**Table 3.** Pearson product-moment correlation coefficients between z-values of the correlation dimension and z-values of partial EEG power.

	CORR. DIM.	$\theta$ POWER	$\alpha_1$ POWER	$\alpha$ POWER	$\beta_1$ POWER
CORR. DIM.	–	$r=-0.10$ NS( $p=0.700$ )	$r=-0.55$ $p=0.026$	$r=-0.55$ $p=0.026$	$r=0.34$ NS( $p=0.195$ )
$\theta$ POWER	$r=-0.10$ NS( $p=0.700$ )	–	$r=0.66$ $p=0.005$	$r=0.49$ NS( $p=0.057$ )	$r=0.54$ $p=0.030$
$\alpha_1$ POWER	$r=-0.55$ $p=0.026$	$r=0.66$ $p=0.005$	–	$r=0.96$ $p<0.001$	$r=-0.07$ NS( $p=0.799$ )
$\alpha$ POWER	$r=-0.55$ $p=0.026$	$r=0.49$ NS( $p=0.057$ )	$r=0.96$ $p<0.001$	–	$r=-0.27$ NS( $p=0.314$ )
$\beta_1$ POWER	$r=0.34$ NS( $p=0.195$ )	$r=0.54$ $p=0.030$	$r=-0.07$ NS( $p=0.799$ )	$r=-0.27$ NS( $p=0.314$ )	–

NS = not significant

## 4 Discussion

The present study confirms previous reports by Wallace [15,16], Banquet [16,21], Levine et al. [22], Kras [23], Rouzeré et al. [24] who found similar changes. The meditators as a group displayed a significant increase of  $\theta$  activity ( $z=2.00$ ,  $p=0.046$ ) over the whole head. In particular, out of 25 meditators, 10 (40%) significantly increased their  $\theta$  activity during meditation, and 4 (16%) significantly decreased. Analysis of each of the 16 derivations separately showed that the prominent theta wave activity is present in the frontal, central, and right temporal regions at frequency of 8 Hz (channel F3,  $z=3.91$ ,  $p=0.0001$ ). The patterns of theta frequencies fluctuated. Observed hypersynchronous theta bursts were similar to the theta bursts occurring during phases of emotional excitation [25,26].

The consistent changes in the other frequency bands were not observed in meditator group as a whole. Out of 25 subjects, 12 (48%) significantly increased their slow alpha activity (8-10.5 Hz) during meditation, and 4 (16%) significantly decreased. The prominent slow alpha activity occurred in right frontal, central and temporal regions. During TM there was a significant increase of alpha activity in 13 (52%) experimental subjects and significant decrease in 7 (28%), most frequently in temporal region (T3-T4). The increase of slow alpha activity during the TM technique is apparently due to the nature of the technique, which according to adherents involves the increasingly abstract experience of quieter levels of mental activity, attained without concentration or procedures of controlling the mind [27]. Increased orderly functioning of the frontal and central regions of the brain may be correlated with this improvement in mental abilities, especially since these brain areas are known to be responsible for such activities as sensory-motor integration, memory, cognition, concentration, judgment, and volition [23]. Those changes may not necessarily occur in long-term meditators. The subjects also showed a significant increase of prefrontal beta activity.

Many of the previously published papers have reported physiological changes during meditation that seems to characterize substates of wakefulness [15,16,25,28,29]. Those changes have been interpreted as a support for the fourth major state of consciousness, the *restful alertness state*, being a combination of restfulness (increase in alpha and theta activity) and alertness (increase in beta activity). This is in accordance with the Ellias and Grossberg model of neuron [30] which predicts that higher input to brain neural network increases frequency and decreases amplitude of oscillations. In this case, appearance of significant theta component and the alpha rhythm slowing may be the result of deprivation of the sensory input. On the other hand, increased beta power could be a consequence of the increased mental activity.

## 5 Conclusion

In this paper the EEG correlates estimated before and during meditation clearly distinguish these two states of consciousness:

- (1) Meditators as a group showed a significant increase of  $\theta$  activity in meditation. That effect is dominant in left frontal (F3) and right temporal (T4) region at frequency of 8 Hz.
- (2) Slow alpha ( $\alpha_1$ ) and  $\alpha$  activity increased significantly in temporal region (T3-T4).
- (3) Beta activity increased significantly in prefrontal region (Fp1-Fp2).
- (4) Correlation dimension decreased not significantly, but there was significant correlation between decreasing of the correlation dimension and increasing of the partial EEG power in  $\alpha_1$  and  $\alpha$  band.

## References

- [1] In C. Tart, ed., *Altered States of Consciousness* (Academic, New York, 1972); K. Jaspers, *Allgemeine Psychopathologie* (Springer, Berlin,

- 1953); R. A. Moody, jr., *Life after Life* (Bantam, New York, 1975).
- [2] D. Raković, Neural networks, brainwaves, and ionic structures: Acupuncture vs. altered states of consciousness, *Acup. & Electro-Therap. Res., Int. J.* 16 (1991), pp. 88-99; D. Raković, Neural networks vs. brainwaves: A model for dream-like states of consciousness, *Proc. 14th Ann. Conf. IEEE/EMBS*, (1992), pp. 2651-2652.
- [3] D. Raković, Brainwaves, neural networks, and ionic structures: Biophysical model for altered states of consciousness, in D. Raković and Đ. Koruga, eds., *Consciousness: Scientific Challenge of the 21st Century* (ECPD, Belgrade, 1995), pp. 291-316; D. Raković, *Fundamentals of Biophysics* (Grosknjiga, Belgrade, 1994,1995), Chs. 5,6, in Serbian.
- [4] D. Raković, Neural networks vs. brainwaves: Biophysical model for ELF interactions, *Proc. 14th Ann. Conf. IEEE/EMBS* (1992), pp. 2750-2751; D. Raković, Traditional psychology and healing: Biophysical model of altered states of consciousness as a clue, in B. D. Sharma, ed., *Holistic Health, Healing and Astrosciences* (Shirdi Sai Baba Centre for Spiritual Awakening and Holistic Health, Yammu, India), in press.
- [5] H. L. Konig, ELF and VLF signal properties: Physical characteristics, in M. A. Persinger, ed., *ELF & VLF Electromagnetic Effects* (Plenum, New York, 1974).
- [6] R. Sheldrake, *A New Science of Life* (Paladin Grafton, London, 1987).
- [7] J. S. Hagelin, Is consciousness the unified field? A field theorist's perspective, *Modern Science and Vedic Science* 1 (1987), pp. 29-88, and references therein; E. N. Istratov, N. N. Lybimov, and T. V. Orlova, Technologies based on the effects of the transcendental meditation (TM) and TM-siddhis: A literature review and preliminary data, *preprint*, in Russian.
- [8] C. G. Jung, *Man and His Symbols* (Dell Publ., New York, 1972).
- [9] K. Wilber, *The Atman Project* (Quest, Wheaton, IL, 1980), and references therein.
- [10] S. Alberts, D. Bray, J. Lewin, M. Raff, K. Roberts, and J. D. Watson, *Molecular Biology of the Cell* (Garland, New York, 1983), Ch. 6.
- [11] E. L. Rossi, Altered States of Consciousness in Everyday Life: Ultradian Rhythms, in B. B. Wolman and M. Ullman, eds., *Handbook of States of Consciousness* (Van Nostrand Reinhold, New York, 1986), pp. 97-132.
- [12] D. Raković, Towards a new/old humanism: Transitional states of consciousness as a clue?, in *this book*.
- [13] M. Tomašević, *EEG Correlates of Altered States of Consciousness in Transcendental Meditation*, B. Sc. Thesis (Faculty of Electrical Engineering, Belgrade, 1995), in Serbian; M. Tomašević, D. Raković, E. Jovanov, V. Radivojević, and M. Car, EEG correlates of altered states of consciousness in transcendental meditation, in Lj. Rakić, D. Raković, Đ. Koruga, and A. Marjanović, eds., *Consciousness: Scientific Challenge of the 21st Century, Proc. of ECPD Seminar*, Belgrade, 1996, pp. 121-128, in Serbian.
- [14] T. Nader, *Human Physiology: Expression of Veda and the Vedic Literature* (Maharishi Vedic Univ., Vlodrop, The Netherlands, 1995).
- [15] R. K. Wallace, Physiological effects of transcendental meditation, *Science* 167 (1970), pp. 1751-1754; R. K. Wallace, *The Physiology of Consciousness* (Maharishi Int. Univ., Fairfield, USA., 1993).
- [16] In D. W. Orme Johnson and J. T. Farrow, eds., *Scientific Research of the Transcendental Meditation Program - Collected Papers*, Vol. 1 (MERU Press, Seelisberg, Switzerland, 1977).
- [17] M. Albano, J. Muench, and C. Schwartz, Singular-value decomposition and the Grassberger-Procaccia algorithm, *Phys. Rev.* A38 (1988), pp. 3017-3026.
- [18] N. Birbaumer, W. Lutzenberger, H. Rau, G. Meyer-Kress, and C. Braun, Perception of music and dimensional complexity of brain activity, *International Journal for Bifurcation and Chaos*, in press, also <http://www.ccsr.uiuc.edu/~gmk/Papers/MusicEEG/ChaosMuTR2.html>.
- [19] B. Mandelbrot, *Fractals, Form, Chance, and Dimension* (Freeman, San Francisco, 1977).
- [20] G. Meyer-Kress and S. P. Layne, Dimensionality of the human electro-encephalogram, in S. H. Koslow, A. J. Mandell, and M. F. Shlesinger, eds., *Perspectives in Biological Dynamics and Theoretical Medicine*, *Annals N.Y. Acad. Sci.* 504 (New York, 1987), pp. 62-86.
- [21] J. P. Banquet, Spectral analyses of the EEG in meditation, *EEG Clin. Neurophysiol.* 35 (1973), pp. 143-151.
- [22] P. H. Levine, J. R. Hebert, C. T. Haynes, and U. Strobel, EEG coherence during the Transcendental Meditation technique, in D. W. Orme-Johnson and J. T. Farrow, eds., *Scientific Research of the Transcendental Meditation Program - Collected Papers*, Vol. 1 (MERU Press, Seelisberg, Switzerland, 1977), pp. 187-207.
- [23] D.J. Kras, The Transcendental Meditation technique and EEG alpha activity, *ibid.*, pp. 173-181.
- [24] A.M. Rouzeré, K. Badawi, and R. Hartmann, *High Amplitude Fronto-central Alpha and Theta Activity During the Transcendental Meditation Technique* (Department of Neurophysiology, Maharishi European Research University, Seelisberg, Switzerland, 1979).
- [25] J. P. Banquet and M. Sailhan, EEG analysis of spontaneous and induced states of consciousness, *ibid.*, pp. 165-172, also *Revue d'Electroencepha-*

- lographie et Neurophysiol. Clinique* 4 (1974), pp. 445-453.
- [26] A.C. Mundy-Castle, The electroencephalogram and mental activity, *EEG Clin. Neurophysiol.* 9 (1957), pp. 643-655.
- [27] J. Forem, *Transcendental Meditation: Maharishi Mahesh Yogi and the Science of Creative Intelligence* (Dutton, New York, NY, 1973).
- [28] N. Alexander and W. E. Larimore, *Distinguishing between Transcendental Meditation and sleep according to electrophysiological criteria* (Department of Psychology and Social Relations, Harvard University, Cambridge, MA; and The Analytic Sciences Corporation, Reading, MA, 1981).
- [29] J. M. Davidson, The physiology of meditation and mystical states of consciousness, in D. H. Shapiro and R. N. Walsh, eds., *Meditation: Classic and Contemporary Perspectives*, (ADLINE Publishing Company, New York 1984), pp. 376-395.
- [30] S. A. Ellias and S. Grossberg, Pattern information, contrast control, and oscillations in the short-term memory of shunting on-center of surround networks, *Biological Cybernetics* 20 (1975), pp. 69-98.

## EEG CORRELATES OF HEALER/HEALEE STATES OF CONSCIOUSNESS

Milorad Tomašević<sup>1</sup>, Emil Jovanov<sup>2,3</sup>,  
Dejan Raković<sup>2,4</sup>, Predrag Šuković<sup>2</sup>, Saša Stanojlović<sup>2</sup> and Marko Car<sup>5</sup>

<sup>1</sup>"Vinča" Institute of Nuclear Sciences, PO Box 522, 11001 Belgrade, Yugoslavia,

<sup>2</sup>Faculty of Electrical Engineering, PO Box 35-54, 11120 Belgrade, Yugoslavia,

<sup>3</sup>Institute "M. Pupin", Computer Systems Department, Volgina 15, Belgrade, Yugoslavia,

<sup>4</sup>European Centre for Peace and Development (ECPD) of the United Nations University for Peace,  
Terazije 41, Belgrade, Yugoslavia,

<sup>5</sup>Institute for Biological Research, Center for Multidisciplinary Studies,  
29. Novembra 142, Belgrade, Yugoslavia

**Abstract.** Transpersonal phenomena might be a key point for understanding the nature of altered states of consciousness and the very nature of consciousness. This was our motivation examining EEG correlates of the healer/heelee interactions, as presumably most intriguing and relatively easily reproducible transpersonal phenomena. This paper reports investigations evaluated within the pilot group of one healer and five heelees. The most interesting finding was that healer's EEG at the beginning of each session exhibited very low frequency rhythmicity, possibly caused by neuro-vegetative system activation. It should be added that some short temporal changes in patterns of EEG spectrograms of the healer and the heelees were observed. The results obtained by analysis of power and coherence time series in time intervals of 60 seconds were not statistically significant. This might be in accordance with the predicted transitional nature of transpersonal phenomena. Future research should take into account time-frequency analysis of short-lasting phenomena, as well as the elaborated very low frequency signal processing procedures.

**Keywords:** EEG, consciousness, altered states, transitional states, healer/heelee transpersonal interaction, ionic transfer, spectral analysis, coherence.

### 1 Introduction

The key problem of any future theory of consciousness is how to incorporate altered states of consciousness [1-3] (REM sleep, meditation, hypnosis, psychedelic drug influence, some psychopathological states, near-death experiences, ...) within a new paradigm. It should be pointed out that purely biochemical mechanisms of the extended reticular-thalamic activating system (serving as a selector and amplifier of the conscious content out of many other currently processed nonamplified contextual unconscious contents) are not accelerated up to several orders of magnitude, as the subjective time sense is dilated in altered states of consciousness - in respect to the normal awake state. According to the biophysical model for altered states of

consciousness (proposed by one of us, D. R. [4-6]), the electromagnetic (EM) component of ultralowfrequency (ULF) brainwaves, related to "subjective" reference frame of consciousness, enables perfect fitting with the narrowed-down limits of conscious capacity in normal awake states and very extended limits in altered states of consciousness - due to the biophysical relativistic mechanism of dilated subjective time base. In this model, consciousness is subtle internal display in the form of EM component of ULF brainwave ionic currents, in which complete information (both conscious and unconscious) is permanently coded from brain's neural networks, as a spatio-temporal pattern resulting from changes of the electrosynaptic interconnections in the neural networks of the brain.

Then, according to this model, altered states of consciousness are a consequence of partial displacement of the ionic acupuncture system outside the body (when the embedded EM component of ULF brainwaves is propagating through this weakly ionized structured gaseous medium of low-dielectric relative permittivity,  $\epsilon_r \approx 1$ ), while normal states of consciousness (alert state, non-REM sleep, ...) are achieved when there are no such displacements (when brainwaves are propagating only through the structured brain tissue of high-dielectric relative permittivity,  $\epsilon_r \gg 1$ )! The displaced ionic structure in this model must have a form of weakly ionized gaseous "optical" neural network, for continually inflowing information from the brain's neural networks to be "subjectively" recognized. Hence, such ionic neural network behaves also as an optical sensor, which can even perceive an environment extrasensory, as reported by reanimated persons [3].

Even most peculiar spatio-temporal transpersonal interactions are predicted in transitional states of interchange of normal and altered states of

consciousness (when brainwaves traverse from high-dielectric ( $\epsilon_r \gg 1$ ) to low-dielectric ( $\epsilon_r \approx 1$ ) state or vice versa, the relative velocity  $v = c_0 / \sqrt{\epsilon_r}$  of "subjective" reference frame being therefore subjected to abrupt change in short transitional period  $\tau \sim 0.1$  s, with "subjective frame" acceleration  $\sim c_0/\tau \sim 10^9$  m/s<sup>2</sup>) - due to the relativistic generation of so-called wormholes in highly noninertial "subjective" reference frame - fully equivalent, according to Einstein's Principle of equivalence, to extremely strong gravitational fields where generation of wormholes (or the Einstein-Rosen space-time bridges, whose entrance and exit could be in very distant space-time points) is theoretically predicted [7]. It should be pointed out that apart from the EM field, the displaced part of ionic acupuncture system (in the form of ionic neural network, having the "optical" sensory function), must also be tunneled in such (acausal) interactions of consciousness with distant events in space-time!

These transitional states of consciousness are presumably also the basis of most transpersonal phenomena [8] - being really described by rare practitioners as not subjected to spatio-temporal limitations [9-11] - providing also an explanation for their transitional nature and poor reproducibility: they last only  $\sim 0.1$  s, and spontaneous conditions for them are achieved only every 1.5-2 hours, with periodicity of ultradian rhythms which govern the interchange of normal and altered states of consciousness [12]. However, it should be noted that the non-low-dielectric barriers in interaction with the low-dielectric barriers are helping in overcoming themselves in such induced transitional states - quite opposite to normal experience in usual mechanical interactions - enabling even their deliberate control and prolongation [9,10].

It should be also pointed out that the ionic nature of the acupuncture system suggests the possibility that ions in air (prana, qi, pneuma) can be physiologically effective [13], just through the acupuncture ionic system and biophysical mechanisms that lie in the basis of acupuncture regulation [14] (out of them, the positive ions have an exciting influence (yang) and the negative ones an inhibiting influence (yin) [13]). So, qi (sometimes erroneously referred as a new kind of biological energy, bioenergy) can be related to ions flowing through the ionic channels of the acupuncture system in the form of ULF ionic currents, with informational content coded in spatio-frequency form of currents and EM fields. It should be pointed out that a lot of experimental phenomena related to external qi gong treatment [15] can be reconciled with the ionic nature of qi. So, it seems that the healing process can be related with the transfer of ions between the healer and healee, and/or transfer of the EM information patterns responsible for normal functioning of acupuncture system and overall health [4,5]. Also, even distant displacements of the healer's ionic

structure in remote diagnosis and healing [10] could be expected in transitional states of consciousness.

This was our motivation to start examination [16] of EEG correlates of the healer/healee interactions, as presumably most intriguing and relatively easily reproducible transpersonal phenomena [15]. This paper presents preliminary results obtained during five healing sessions of one healer. The results obtained will be used to set-up framework of future research.

## 2 Method

**SUBJECTS** - The study was carried out on one healer and five healthy adult volunteers. There were 3 males and 2 females, whose ages ranged from 24 to 30 years with a mean age of 26 years. All subjects were free of any medication. Prior to the experiment subjects were informed verbally about all aspects of the experimental procedure.

**APPARATUS** - Electroencephalographs were recorded in an electromagnetically shielded room by a MEDELEC 1A97 EEG machine, with lower and upper band-pass filter limits set at 0.5 Hz and 30 Hz, respectively. Ag/AgCl electrodes with impedance less than 5 k $\Omega$ . EEG was recorded simultaneously from two adult human subjects (healer and patient-healee). Electrodes were placed at 16 locations (F3, F4, T3, T4, P3, P4, O1, O2 - healer, and F3, F4, T3, T4, P3, P4, O1, O2 - healee) according to the International 10-20 system with average reference. The EEG outputs were digitized with 12-bit precision at a sampling rate of 128 Hz per channel using A/D converter Data Translation 2801.

**PROCEDURE** - The experiment was conducted in a sound-proof room. The patients were in relaxed state with eyes closed. Subjects had no physical contact. Each recording session was divided into three sequential periods:

- (1) Initial state, before the healing session (2 min with eyes closed, healer had no activity),
- (2) During the healing session (3 min.), and
- (3) After the healing session (2 min).

During those periods an EEG was recorded and stored on a hard-disk.

**DATA ANALYSIS** - The length of each EEG-trace was 420 s. Time-varying EEG spectra (spectrograms) with 0.5 Hz resolution were calculated by the MATLAB program using a 256-point FFT algorithm performed on 2 s Hamming-windowed half-overlapped epochs. An array of EEG partial power spectra for each subject and each derivation was computed by integration by the trapezoidal rule of the spectrogram over the four frequency bands:  $\theta$  (from 4 to 8 Hz),  $\alpha_1$  (from 8 to 10.5 Hz),  $\alpha$  (from 8 to 13 Hz), and  $\beta_1$  (13 to 18 Hz).

The coherence of spectral arrays was estimated using Welch's averaged periodogram method at 512-point (4 s) epochs of EEG data divided into 256-point (2 s) detrended Hamming-windowed subsets with 240-point overlap. Total coherence for the each

frequency band was calculated using the same methods as those described by Levine et al. [17].

### 3 Results

The healer's EEG at the beginning of each of the five sessions exhibited similar properties (Fig. 1). The specific pattern of this slow fluctuation is not due to the cortical activity, but to intensive neuro-vegetative reaction. This reaction is accompanied with the changes of skin resistivity, which is the greatest at the parietal and temporal brain sites.

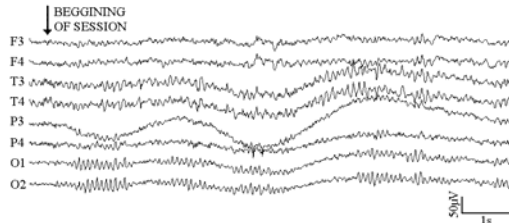

**Figure 1.** An example of the healer's neuro-vegetative reaction at the beginning of session

The healee's power spectrum exhibited small changes, the greatest being at frontal brain sites. The healee's power spectrum during the session is shown in Fig. 2.

The Mann-Whitney U-test was used to analyse coherence of spectral arrays (COSPAR's). Significant changes in 3 out of 5 experiments were observed. Changes were most pronounced at channel T3 (both healer's and healee's). However, due to their small values, medians of coherence time series (30-50%) were not taken into consideration. Increase of coherence occurred only in short intervals. Epochs of 4s, before and during the session were used to estimate maximum coherence value in alpha and theta bands. Results are summarised in Table 1. Increase of maximum coherence in alpha band was 6-13% for subjects 1, 2, and 3, while 4.4% for the whole group.

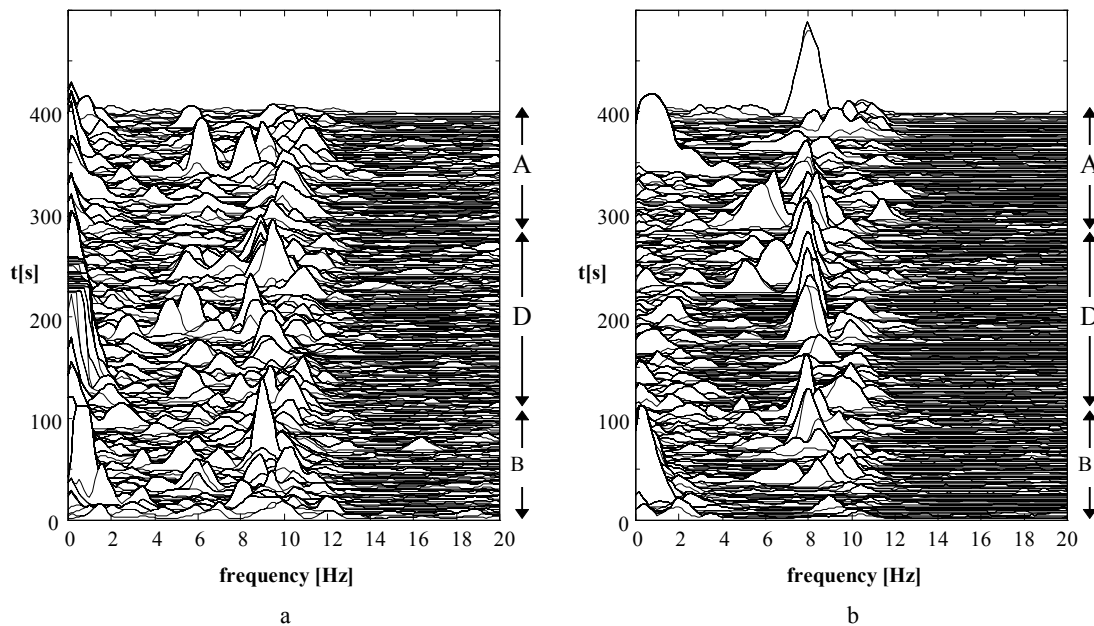

**Figure 2.** Spectrogram (channel P3) of (a) healer and (b) healee; increase in power is most pronounced in theta band; periods: B- before, D- during, and A - after the healing session.

**Table 1.** Maximum mean coherence in theta and alpha band for 4s time epochs, before, during, and after the healing session.

SUBJ.	FREQUENCY BAND					
	THETA			ALPHA		
	BEFORE	DURING	AFTER	BEFORE	DURING	AFTER
1	73%(T3-T3)	82%(F4-F4)	75%(T3-T3)	70%(O2-O2)	78%(F3-F3)	76%(P4-P4)
2	73%(P4-P4)	70%(O2-O2)	69%(P4-P4)	78%(T4-T4)	84%(O1-O1)	83%(T3-T3)
3	74%(F4-F4)	72%(P3-P3)	81%(T3-T3)	79%(O2-O2)	92%(O1-O1)	84%(O2-O2)
4	71%(F4-F4)	78%(F3-F3)	71%(F3-F3)	81%(F3-F3)	82%(O2-O2)	77%(P4-P4)
5	77%(F4-F4)	81%(P3-P3)	74%(O2-O2)	80%(T3-T3)	74%(F3-F3)	84%(O1-O1)
mean	74,6%	76,6%	74,0%	77,6%	82%	80,8%



An example of synchronized EEG signals of the healer and the healee 3 during the treatment, as well as the corresponding phase diagrams and coherence diagrams are shown in Fig. 3. The phase difference at frequencies with maximum coherence is  $180^\circ$ .

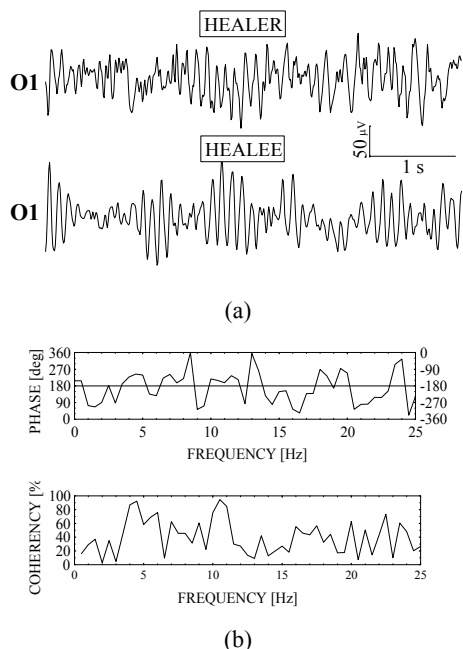

**Figure 3.** An example of short-time EEG synchronization with max. coherence; channel O1 of the healer and subject 3; plots of (a) original signal and (b) phase and coherence diagrams.

#### 4 Conclusion

The main aim of our pilot experiment made on one healer and five healees was to establish experimental set-up for larger experimental group as well as methods for quantitative analysis. Due to small experimental group and nonstationarity of EEG signals, the results obtained by dynamic analysis of power and coherence time series were not statistically significant. If the healer/healee interaction is related with the transfer of the EM information patterns, then it is to be established during short time intervals. This is suggested by the increase of the maximum mean coherence of the whole group in alpha band (4.6%), obtained by statistical analysis of the coherence of 4s long time epochs. Due to the nature of the underlying phenomenon it is necessary to perform data acquisition with a higher sampling rate ( $>256$  Hz). Quantification of the observed changes in delta and subdelta band require more elaborate signal processing procedures.

#### References

[1] In C. Tart, ed., *Altered States of Consciousness* (Academic, New York, 1972).

[2] K. Jaspers, *Allgemeine Psychopathologie* (Springer, Berlin, 1953).

[3] R. A. Moody, jr., *Life after Life* (Bantam, New York, 1975).

[4] D. Raković, Neural networks, brainwaves, and ionic structures: Acupuncture vs. altered states of consciousness, *Acup. & Electro-Therap. Res., Int. J.* 16 (1991), pp. 88-99; D. Raković, Neural networks vs. brainwaves: Biophysical model for ELF interactions, *Proc. 14th Ann. Conf. IEEE/EMBS* (1992), pp. 2750-2751; D. Raković, Traditional psychology and healing: Biophysical model of altered states of consciousness as a clue, in B. D. Sharma, ed., *Holistic Health, Healing and Astrosciences* (Shirdi Sai Baba Centre for Spiritual Awakening and Holistic Health, Yammu, India, in press).

[5] D. Raković, Brainwaves, neural networks, and ionic structures: Biophysical model for altered states of consciousness, in D. Raković and Đ. Koruga, eds., *Consciousness: Scientific Challenge of the 21st Century* (ECPD, Belgrade, 1995), pp. 291-316; D. Raković, *Fundamentals of Biophysics* (Grosknjiga, Belgrade, 1994, 1995), Chs. 5,6, in Serbian.

[6] D. Raković, Prospects for conscious brain-like computers: Biophysical arguments, *Informatica* 21 (1997), No. 3: Special Issue on Consciousness as Informational Phenomenalism, in press; D. Raković, Consciousness and quantum collapse: Biophysics versus relativity, *The Noetic J.* 1, No.1, (1997), in press.

[7] K. S. Thorne, *Black Holes and Time Warps: Einstein's Outrageous Legacy* (Picador, London, 1994), Ch. 14, and references therein.

[8] R. G. Jahn, The persistent paradox of psychic phenomena: An engineering perspective, *Proc. IEEE* 70 (1982), pp. 136-170.

[9] R. Monroe, *Journeys Out of the Body* (Doubleday, Garden City, NY, 1971).

[10] K. C. Markides, *Fire in the Heart. Healers, Sages and Mystics* (Paragon House, New York, 1990).

[11] V. P. Kaznacheev and A. V. Trofimov, *Cosmic Consciousness of Humanity, Problems of New Cosmogony* (Elendis - Progress, Tomsk, Russia, 1992).

[12] R. Broughton, Human consciousness and sleep/waking rhythms, in B. B. Wolman and M. Ullman, eds., *Handbook of States of Consciousness* (Van Nostrand Reinhold, New York, 1986).

[13] A. P. Krueger, Preliminary consideration of the biological significance of air ions, *Scientia* 104 (1969), pp. 1-17.

[14] Y. Omura, *Acupuncture Medicine* (Japan Publ., Tokyo, 1982); F. G. Portnov, *Electropuncture Reflexotherapeutics* (Zinatne, Riga, 1982), in

- Russian; A. I. Škokljević, *Acupuncturology* (ICS, Belgrade, 1976), in Serbian.
- [15] Y. Omura, T. L. Lin, L. Debreceni, B. M. Losco, S. Freed, T. Muteki, and C. H. Lin, Unique changes found on the qi gong (chi gong) master's and patient's body during qi gong treatment: Their relationships to certain meridians & acupuncture points and the recreation of therapeutic qi gong states by children & adults, *Acupuncture & Electro-Therap. Res., Int. J.* 14 (1989), pp. 61-89.
- [16] E. Jovanov, D. Raković, V. Radivojević, D. Kušić, P. Šuković, and M. Car, Evaluation of state of consciousness using software support for monitoring spatio-temporal EEG changes, *ISCA Conf. Comp. Med.*, Lafayette, 1995; E. Jovanov, D. Raković, V. Radivojević, and D. Kušić, Band power envelope analysis - A new method in quantitative EEG, *Proc. 17th Ann. Int. Conf. IEEE/EMBS* (1995).
- [17] P. H. Levine, J. R. Hebert, C. T. Haynes, and U. Strobel, EEG Coherence During the Transcendental Meditation Technique, in D. W. Orme-Johnson and J. T. Farrow, eds., *Scientific Research of the Transcendental Meditation Program -Collected Papers*, Vol. 1 (MERU Press, Seelisberg, Switzerland, 1977), pp. 187-20.

## SLEEP AND CONSCIOUSNESS - SOME MEDICAL AND FORENSIC IMPLICATIONS

Nikola N. Trajanović, Colin M. Shapiro, Helen Driver

Sleep and Alertness Clinic, Department of Psychiatry, University of Toronto, Canada

**Abstract.** The phenomena of consciousness and sleep is multifaceted, and the old dichotomy of consciousness-unconsciousness has become obsolete. Although there is the potential of measuring the level of consciousness using EEG analyses, definitive methods remain elusive. New developments, including an EEG cartography of conscious states [8], can be expected. We believe that the biological theory of structured consciousness gives a credible approach to the evaluation of such methodologies. While there are still many controversies from the medico-legal point of view, it is generally accepted that sleep-related disorders resulting in a dangerous behaviour, present cases of impaired consciousness, which is a basis for exculpation. The most common exculpatory defence is one of non-insane automatism.

**Key words:** *consciousness, sleep-related disorders, medical & forensic implications.*

Do we sleep in order to separate ourselves from our thoughts and feelings - to become detached from our consciousness, or do we lose consciousness as an unavoidable consequence of a natural sleep? Most likely, these two phenomena coexist independently and form different relations during sleep and wakefulness. Consciousness (consciousness) defies simplistic definitions. Instead, a multitude of truisms or indisputable facts regarding consciousness may be a better frame-work for further discussion.

Until relatively recently sleep was considered to be an "either-or" condition. Hence, a person is either asleep, or awake. We now recognise a number of states where we do not have a clear-cut situation. Some sleep disorders (e.g. parasomnias, dissociative states, sleep drunkenness, nocturnal seizures) and sleep-related physiological states (e.g. micro-sleeps) are good examples of how sleep and wakefulness may be juxtaposed or coexist. This is also true for sleep and consciousness. To compare the level of consciousness in different states of wakefulness or/and sleep we may choose to follow behavioural changes in a person, as well as a number of EEG patterns (transitions). In the case of the EEG, we observe electrophysiological changes in wave lengths, amplitudes, spectrums, composition, and synchronisation. When the EEG is regarded as a measure of the "neuronal chaos" [1], we may, surprisingly, realise that a petit mal seizure, or the electroencephalogram in a patient with Creutzfeld-Jacob disease may be less chaotic than during deep sleep. If we accept that EEG is a measure (or one of

the measures) of consciousness then we might be led to think that a patient with Creutzfeld-Jacob disease is less conscious when awake, than a healthy person in a deep sleep. In a similar vein, the EEG of a sleep-walker can show an abrupt change from deep-sleep into a pattern indicative of wakefulness. Does that neuro-electrical change significantly alter the level of consciousness? If so, does it reveal a fully conscious person? When we base our opinion solely on the EEG, the answer may be simple - that a person who is awake, according to the EEG criteria, must be conscious. But, obviously, this issue is more complex than it seems.

A definition of consciousness as a "sense of awareness of self and environment" is a good starting point to explain its complexity. This simple definition may be clinically used to grade the impairment of consciousness from "clouding of consciousness" to profound coma, but it is not sufficient to give a better (behavioural) explanation of consciousness. We must view consciousness as a cluster of different elements, namely: (a) vigilance - a function of the reticular formation, also considered to be the "arousal system", responsible for a range of states between coma and full responsiveness; (b) selective attention to environment, related to hippocampus, and (c) cognitive system, or mental contents - mainly cortical phenomena. The leading role in generating consciousness belongs to the thalamo-cortical system which has rich reciprocal connections to higher and lower structures. This system is fed by a sensory input in the state of wakefulness, and by the memory content during sleep (REM sleep in particular), and is modulated by the brainstem [2]. The electrophysiological substrate of consciousness seems to be a coherent 40 Hz cortical activity.

A biological theory [3,4] proposes two forms of consciousness: primary and higher order consciousness. A complex process is required by higher order consciousness as a prerequisite for full consciousness. This process involves (i) categorisation, (ii) learning, (iii) distinguishing between intrinsic and extrinsic, (iv) placing a sequence of events into a logical order, (v) complete primary consciousness interacting with the process of time sequencing and conceptualisation, and (vi) a system moderating memory and the neuronal structures which conceptualise sensations. If any of

the component is missing, consciousness becomes impaired.

Sleep is a physiological condition where consciousness becomes limited (or impaired) in many different ways. There is a contrast between the deep (or slow-wave) sleep, where most of components of consciousness are completely or partially non-existent, and REM sleep where only the component determining external v. internal (and, partially, one that brings together conceptualisation of sensation and memory structures) is suppressed. Instead, an intrinsic process which retrieves memories of sensations is activated in REM sleep. However, the sheer number of components lost or partially absent will not determine the level of impairment of consciousness. In addition to physiological alterations of consciousness in sleep, there are a number of sleep disorders where we can find abnormalities in structuring of sleep. We will focus on those disorders which may result in an injurious or dangerous behaviour, and on their potential forensic aspects.

Table 1 shows sleep disorders with an increased likelihood for legal implications; however, some unusual behaviours during sleep are linked to other medical conditions which may be related to sleep pathology (e.g. Parkinson's Disease or brain tumour associated to RBD).

**Table 1** Sleep disorders

Sleep disorders	Some CNS medical conditions associated with sleep disorders
<b>1. Parasomnias</b> Sleep walking Sleep terrors Confusional arousals REM Sleep Behaviour Disorder (RBD) Overlap parasomnias Sexual Behaviour in Sleep (SBS)	<b>1. Neuro-degenerative disorders</b> Parkinson's Disease Huntington's Disease Alzheimer's Disease Tourette's Syndrome <b>2. Organic brain syndromes</b> Tumour Insult Intoxication <b>3. Seizure disorders</b> <b>4. Psychiatric disorders</b>
<b>2. Seizure disorders and related disorders</b> Nocturnal epileptic seizures Nocturnal pseudoseizures Nocturnal wandering Paroxysmal nocturnal dystonia	
<b>3. Sleep drunkenness</b>	
<b>4. Movement disorders</b> Periodic Limb Movements in Sleep Restless Legs Syndrome	
<b>5. Psychogenic dissociative states</b>	
<b>6. Sleep apnoea</b>	
<b>7. Narcolepsy</b>	

Behaviour during sleep that may lead to litigation include damage to objects, indecent exposure, self-injury, injury to others, sexual assault and homicide. Only a small number of sleep disorders result in seriously dangerous behaviour. These include sleepwalking<sup>a</sup>, REM Sleep Behaviour Disorder (RBD), nocturnal seizures<sup>b</sup>, sleep drunkenness, psychogenic dissociative states and excessive daytime sleepiness. Patients who suffer from any of these disorders may exhibit very complex and seemingly purposeful behaviour during attacks. For example, a somnambulist (here generally referring to a person with parasomnia) may rise from his bed, walk through

the house, get into the car and drive for miles (often without causing an accident). This behaviour may, unfortunately, result in a homicide. Recently described parasomnia of Sexual Behaviour in Sleep (Shapiro et al. 1996) involves both simple (masturbation) and complex behaviour (foreplay, sexual intercourse) often directed towards an un-wanting partner.

A common denominator for all sleep-related disorders that result in dangerous behaviour is an abrupt change in the EEG representing a transition from the normal sleep pattern to one resembling wakefulness. The question is whether consciousness follows this pattern - in other words, do we have a fully conscious person, and are we able to judge that based on EEG criteria only. We have already pointed to a discrepancy in evaluating the level (quality) of consciousness using the EEG fractal dimension analysis. Accordingly, 40 Hz activity can indicate the presence of consciousness, but not its quality. This high frequency activity is recorded both during wakefulness, when the cortex is exposed to an external stimuli, and during REM sleep, when the brain processes its memory content<sup>c</sup>.

In somnambulism, as well as in other sleep-related conditions resulting in dangerous behaviour, most of the components determining consciousness are either missing or partially absent. There is usually complete amnesia for events during an attack, as the threshold for external stimuli is higher than during wakefulness, and the component of learning is completely absent. One can argue that because a somnambulist is able to avoid self-injury while walking or driving, he can, to some extent, distinguish between intrinsic and extrinsic, and that he has a level of consciousness at the time of event sufficient to bare the consequences of his acts (e.g. homicide). There are two points regarding this objection: one is that a somnambulist is only able to perform learned skills and his performance during the event is a result of automatism; the other point is that of different cortical activity when the brain is exposed to novel or familiar stimuli. There is a significant difference in cortical activity (even at 40 Hz) when exposed to a stimulus for the first time (sound, mathematical problem), as compared to activity during any subsequent exposure. The pattern of response to a known stimulus resembles one during REM sleep, which is, by definition, a state of impaired consciousness. Thus, in addition to performing learned skills, somnambulist can move through familiar environments, even when the consciousness is impaired. The existence of "overlap" parasomnias brings satisfactory answer as to why some somnambulists describe structured dreamlike experiences, rather than the incoherent contents of a confusional state.

<sup>a</sup> Precipitating factors for sleepwalking (and parasomnias in general) are alcohol/substance abuse, sleep deprivation and stress. It can be also induced by a number of drugs, including hypnotics, neuroleptics, anti-depressants, tranquilisers, stimulants and anti-histamines. Predisposing factors are family history, physical and sexual abuse, and personality disorders.

<sup>b</sup> Seizures and slow-wave sleep parasomnias usually arise from highly synchronised EEG activity

<sup>c</sup> It may be plausible to introduce at this point the term of "full internal consciousness". It comprises primary and higher order consciousness during REM sleep, when almost all components function and interact, except for an ability to process (sub-threshold) stimuli and distinguish between extrinsic and intrinsic consciousness. This state is the closest, amongst states of consciousness in other sleep stages, to full consciousness during wakefulness.

From the medico-legal aspect, there is increasing interest in dangerous nocturnal behaviour, especially if a sleep component has legal relevance. In Anglo-Saxon criminal law and its derivatives (United States, Canada, Australia) responsibility is based on existence of (a) wrongful act (*actus reus*), and (b) guilty mind (*mens rea*). There is no criminal liability for an undertaking unless both of the elements are present. It is assumed that any person who has reached the age of discretion is sane and accountable for his acts. The prerequisite for a wrongful act is volition (willed movement, as opposed to a reflex act). There are three instances where the guilty mind is absent: the mind is innocent (ignorant), as in the case of a child or person with low intelligence; there may be a disease of mind (defence of insanity), and absence of mind (defence of automatism). There is a long line of evolution of these issues originating with early criminal cases that involved the defence of insanity in mid-nineteenth century, to recent examples of defences of automatism [5,6]. Further development was the division of automatism into two sub-categories: insane and non-insane automatism (R. v. Charlson, 1955, R. v. Kemp, 1957, Bratty v. Attorney General for Northern Ireland, 1963<sup>d</sup>). Furthermore, the later case incited a criterion for automatism to be either insane or non-insane on whether the disorder was likely to recur or not. This opened the door for a number of disorders to be declared as insane automatism (epilepsy, diabetes, arteriosclerosis, or somnambulism). Later court cases endorsed the internal/external cause distinction, rather than following the Bratty precedent. The case of R. v. Quick (1973), is a good example on how the application of an external factor (insulin), resulted in non-insane automatism (due to acute hypoglycaemia), and Quick, who was regularly taking insulin to treat diabetes, was acquitted.

There are a number of criminal cases of somnambulism and homicide [3] - in many of them prosecution was abandoned due to an overwhelming evidence of somnambulist behaviour. A different case was described by Nofzinger and Wettstein [7] of a patient with sleep apnoea who fatally shot his wife during, according to the defence, a state of confusion following an arousal precipitated by sleep apnoea. The expert witness suggested that the event occurred during an episode of sleep drunkenness, or possible hypnagogic hallucination, resulting from sleep fragmentation due to sleep apnoea. The prosecution was more successful in presenting their case before the jury - they emphasised the defendant's motifs to kill his wife, complexity of behaviour during the crime, and his inaction following the crime. In the absence of evidence suggesting somnambulism or any other sleep disorder, the accused was convicted of first-degree murder.

The milestone in explaining the complexity of somnambulist and its medico-legal implications is the

<sup>d</sup> Bratty was accused of strangling his wife. The defence was based on evidence of epilepsy, and his case was successful on appeal.

case R. v. Parks [3,5]. The defendant was accused of killing his mother-in-law and injuring his father-in-law. On the night in question, he fell asleep<sup>c</sup> on the couch of his living room. In the early morning hours he got up from the couch, put on shoes and a jacket, and drove some twenty kilometres to the house of his in-laws<sup>f</sup>. He parked the car, taking the tire lever from the trunk, and upon entering the house, fetched a knife from the kitchen. He then went upstairs into the bedroom and assaulted his father-in-law, trying to strangle him. His mother-in-law was attracted by noise, and upon seeing what was happening, tried to halt the struggle; Parks inflicted a series of knife wounds on both her and her husband.

Parks claimed that he was asleep during the journey to the house, and during the actual crime. The defence presented convincing evidence of somnambulism, and the court ruled in favour of the defendant. Ontario Court of Appeal decided on whether somnambulist was a disease of mind<sup>g</sup>, or non-insane automatism. It was concluded that sleepwalking is indeed a minor dysfunction of normal sleep, and that the condition of impaired consciousness (reason, memory, understanding) "occurs before the sleepwalking begins, namely, when the person falls asleep" and therefore warrants the verdict of non-insane automatism.

The critical point in evaluating somnambulist is whether it is precipitated by an internal or external cause. As the previous case shows, there is a great likelihood for the latter interpretation. In contrast, there are some cases where the court decisions were less favourable. In the case<sup>h</sup> of R. v. Burges [3,6], the jury decided that the defendant was not guilty by reason of insanity. Although it was a clear case of somnambulist, he was subsequently ordered to be detained in a psychiatric institution.

The latest addition in the family of parasomnias is a description by Shapiro et al. (1996) of a series of cases involving various sexual activities while asleep (or arising from sleep). The case of the police officer who was initially accused of impaired driving under the influence of alcohol drew notable attention. His defence (successful in court) was that of parasomnia, based upon a previous history of sleep walking and sleep talking. Subsequently it was discovered that he had another manifestation of his parasomnia - his two current girlfriends independently confirmed that he frequently engages in sexual behaviour while asleep. This case of the "overlap" parasomnia and other cases of Sexual Behaviour in Sleep (SBS) illustrate the complexity of parasomnic behaviour, and how unconscious motifs may additionally suppress the higher order consciousness during sleep.

<sup>c</sup> Parks was under stress due to pending criminal proceedings involving his former employer - at the time of the event in question he had very little sleep.

<sup>f</sup> He drove 23 kilometres, including six turns, and encountered eight sets of traffic lights.

<sup>g</sup> in which case, as a result of the verdict (defence of insane automatism), Parks would have had to be institutionalised.

<sup>h</sup> Burges was accused of assaulting his girlfriend using the video-recorder. His defence was that he was asleep at the time.

Similar examples can be found in the case of dissociative states<sup>l</sup>, where the phenomena of altered or “fractured” consciousness is the main substrate. While there are a number of similarities between somnambulist and dissociative states (amnesia, lack of awareness in regard to environment), several key differences exist. The most prominent is the association of various psychiatric disorders with fugue states. This group of disorders may also last longer, and may not only be related to sleep. Finally, there is an impairment of memory during wakefulness. In the instance of dissociative disorders, the number of successful court cases (in terms of complete exculpation) is lower than those of somnambulist, mainly due to a dispute over their extrinsic nature, as well as their likelihood to recur.

One very important instance of impaired consciousness related, or resulting from sleep is drowsiness, or falling asleep while driving<sup>j</sup>. The tendency to fall asleep while driving may be exaggerated by physiological factors (lack of sleep, sleep deprivation), or sleep-related disorders (narcolepsy, sleep apnoea, PLMS, chronic fatigue/fibromyalgia, etc.). It is not uncommon that the court finds a driver who falls asleep and causes an accident to be not guilty if it can be proven that there was no ability to anticipate oncoming sleepiness, and there was a normal sleep schedule prior to the accident. For some, it is hard to believe that one can fall asleep while driving without any prior warning, following a good night’s sleep. A driver’s alertness can be impaired long before any telltale sign of sleepiness are apparent. The phenomena of micro-sleeps, lasting less than one second<sup>k</sup>, can impair consciousness to the level when driving becomes dangerous, without any clear sign of impending sleep.

To summarise, the phenomena of consciousness and sleep is multifaceted, and the old dichotomy of consciousness-unconsciousness has become obsolete.

Although there is the potential of measuring the level of consciousness using EEG analyses, definitive methods remain elusive. New developments, including an EEG cartography of conscious states [8], can be expected. We believe that the biological theory of structured consciousness gives a credible approach to the evaluation of such methodologies.

While there are still many controversies from the medico-legal point of view, it is generally accepted that sleep-related disorders resulting in a dangerous behaviour, present cases of impaired consciousness, which is a basis for exculpation. The most common exculpatory defence is one of non-insane automatism.

## References

- [1] B. Doyon, On the existence and the role of chaotic processes in the nervous system, *Acta Biotheor* 40 (1992), pp.113-119.
- [2] R.R. Llinas and D. Pare, Of dreaming and wakefulness, *Neuroscience* 44 (1991), pp. 521-535.
- [3] C.M. Shapiro and A McCall-Smith ed., *Forensic Aspects of Sleep* (John Wiley & Sons, UK, 1997).
- [4] G.M. Edelman, *The Remembered Present: A Biological Theory of Consciousness* (Basic Books, New York, 1989).
- [5] Canadian Criminal Cases: 75 C.C.C. 3rd - Regina v. Parks 287 (1992).
- [6] 23: Regina v. Burges, 2 A.E.R. 769 (1991)
- [7] E.A. Nofzinger, and R.M. Wettstein, Homicidal behaviour and sleep apnea: A case report and medicolegal discussion, *Sleep* 18 (1995), pp.776-782.
- [8] M.A. Tansey, J. A. Tansey, and K. H. Tachiki, Electroencephalographic cartography of conscious states, *International Journal of Neuroscience* 77 (1994), pp. 89-98.

<sup>l</sup> Dissociative fugue has, amid other dissociative states (dissociative amnesia, multiple personality disorder, depersonalisation disorder and dissociative disorder not otherwise specified), the features most with somnambulist

<sup>j</sup> In addition to falling asleep while driving, the spectre of potential medico-legal cases includes operating equipment that may cause bodily harm, as well as neglecting duty by falling asleep (police officers, soldiers, etc.).

<sup>k</sup> Covering distance of up to 20 meters at the speed of 70 km/h.



## **NATURE OF THE SUCCESS ACHIEVEMENT COMES FROM WITHIN**

Rade Vasović

“Fautoris” Agency, 7 July 64, Vrbas, Yugoslavia

**Abstract.** By a common action and scientific approach to the research of the relationships of matter and consciousness, science and religion, based upon the creative power and stimulative energy of the individual predetermination of a recognized individual screenplay, it will be possible to reach the very personality renaissance, and thereby new perspectives for the change of total material reality.

The path of future recovery and further successful development of the very personality and our planet, is in a long-lasting and patient, education process at a new basis, set and grounded on general and specific acquisition of knowledge and skills, directed toward the uncovering of the

inception, functioning and self-realization of the consciousness of man's humanity [1].

**Key words:** *being and essence, creative wisdom, starting factor, internal mechanism, stimulative energy, creative power, energy, light, individual predetermination, own screenplay.*

- [1] Rade Vasović, *Role and place of vision in the definition of enterprise strategy*, DIT, (Zrenjanin), pp. 4-5, (1996), in Serbian.



## BRAIN CHEMISTRY AND CONSCIOUSNESS

Mirjana Vojinović-Miloradov, Jasna Adamov, and Mira Popović

Institute of Chemistry, Faculty of Science, Universiti of Novi Sad,  
Trg Dositeja Obradovića 3, 21000 Novi Sad, Yugoslavia

**Abstract.** The relationship between the structure and function of the brain still represents one of the major challenges to current medical research. The study of consciousness is closely related to the study of chemical and biochemical processes in brains and may represent the leading problem of the century to come. In this paper the mechanism of transmitting of neural impulses is described via chemical substances called neurotransmitters (dopamine, serotonin). Consciousness should be understood as independent or autonomous from our perceptual mechanisms and some intriguing concepts of creation of consciousness have been postulated.

**Key words:** *brain, consciousness, serotonin, dopamine, synapse*

### 1 Introduction

As we approach the end of the 20th century our knowledge of how the human body functions has reached a remarkable level. A topical inspection of the brain, however, gives little information and the relationship between its chemical structure and function still represents one of the major challenges to current medical and scientific research. Even at our current level of understanding, no disease of the central nervous system can be considered to be adequately treated. The study of consciousness is closely related to the study of chemical and biochemical processes in brains and may represent the leading problem of the century to come. The last decade of the 20th century is declared the decade of investigation of brain and consciousness by the United nations. Possibly a new medium or mechanisms will surface to explain consciousness, much in the way the discovery of the DNA double helix redefined thinking on heredity.

Consciousness poses the most baffling problems in the science of the mind [1]. There is nothing that we know more intimately than conscious experience, but there is nothing that is harder to explain. All sorts of mental phenomena have yielded to scientific investigation in recent years, but consciousness has stubbornly resisted.

Consciousness deals with one of the most basic questions of reality, which involves the way our brain discern and filter incoming information. The process breaks down into four fundamental mechanisms which guide our thoughts and emotions: discrimination, reportage, integration and reaction.

Consciousness is something that in some way distinguishes us as humans. Other creatures have some form of it. We have it to a great extent. Understanding consciousness offers pointers to understanding why humans are unique.

Crick and Koch (1990) outlined the neurobiological theory of consciousness [2]. This theory centers on certain 35-75 Hz neural oscillations in the cerebral cortex. These oscillations are the basis of consciousness because they represent a mechanism by which the binding of information contents may be achieved by the synchronized oscillation of neuronal groups.

The other popular explanation is quantum mechanics. The logic of sensations is a quantum logic. There is an intimate connection between subjective experience (sensations) and quantum mathematics. The attractiveness of quantum theories of consciousness may stem from a Law of Minimization of Mystery: consciousness is mysterious and quantum mechanics is mysterious, so maybe the two mysteries have a common source. Quantum phenomena have some remarkable functional properties, such as nondeterminism and nonlocality. These properties may play some role in the explanation of cognitive functions, such as random choice and the integration of information, and this hypothesis cannot be ruled out a priori. Quantum processes play an important role for the relation between brain activity and conscious action. The observation can be explained in terms of electron transfer processes between different states of the membrane proteins.

The similarity in the form and structure between nerves and microtubules is a base for the microtubular dynamics concept. Microtubules seem to play a very important role in brain function [3]. From a physical point of view there are, effectively, 2-dimensional (1-space + 1-time) systems with very characteristic properties resembling closely the behaviour of 1-dimensional, extended objects, i.e. strings. Nanopoulos [4] suggests that the microtubules are the microsites in the brain for the emergence of stable macroscopic quantum coherent states, identifiable with the preconscious states. Quantum space-time effects, as described by string dynamics, trigger and organize collapse of the coherent states down to a specific or conscious state.

The discussion of consciousness tend to range over three conceptually distinct realms discussed by Popper [5] under the metaphor of Three Worlds. World One is the realm of physical things and processes. World Two is a realm of subjective human experience. World Three is the realm of culture or objective knowledge.

We believe and suggest that this concept must be extended to the *World Four* a realm of the chemical and biochemical reactions and processes.

## 2 Consciousness and the Brain Chemistry

The problem of consciousness is one of the most exciting intellectual challenges of our time. Because consciousness is both so fundamental and so ill understood, a solution to the problem may profoundly affect our conception of the universe and of ourselves.

The triangle in Fig. 1 is a simple representation of a human mind.

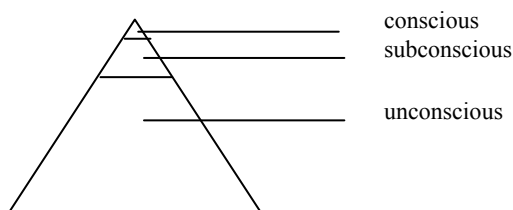

**Figure 1** A graphic representation of a human mind

Consciousness is only a tip of a triangle and can hold only restricted amount of information. The unconscious mind, however, handles an enormous amount of information of which we are mostly unaware. Information which has come into the conscious mind is then stored in the unconscious mind to make way for new information and it cannot readily be brought to the surface. The subconscious is usually described as a layer deeper than consciousness from which information can fairly easy be extracted [6].

There is a good reason to believe that consciousness arises from physical and chemical systems such as brains, but we have little idea how it arises and how could a physical system such as a brain also be an experienter.

When we think of the brain we usually think of a lump of undifferentiated gray matter, made up of neurons. But the brain actually has a quite complex internal structure, laid out very specifically by the genes, to allow it to encode and store our experience. The most ancient section, the limbic system, or what is called inner eye, is a relic from our reptilian ancestors. The limbic system lies at the center of the brain and comprises several subcomponents, including the hypothalamus, hippocampus and the amygdala. Information from all the senses (touch, smell, hearing, tasting and seeing) passes through the inner eye before being routed to the higher brain. Nerves from our senses relay information through the inner eye, where their signals can be nuanced, enhanced, ignored, or

otherwise colored, before they are processed by the cortex and our higher consciousness. The inner eye is a powerful means of control over us, it determines our temperament and who we can become.

Any accurate description of the brain has to account for many levels of understanding: medicinal chemists seek to understand the brain at the subcellular level i.e. the actual chemical processes in the brain, the common diseases associated with them and the design and synthesis of small molecules for drug therapy.

The main function of the brain is as an information storage and operating system, and the process of exchange and use of this information is known as neurotransmission, which occurs within a discrete group of highly specialised cells called neurones. The bulk of the human brain is made up of neurones, and neurotransmission can be considered as two distinct but related events: the passage of an electrical impulse along neurones; and the release of molecules (neurotransmitters) from small packages or vesicles, between two neurones.

Spine synapses regulate the propagation of nerve in the cortical network. The basic anatomical units of this network are pyramid cells with apical dendrites, finishing in a tuft-like branching in the uppermost layer of the cortex. The apical dendrites are clustered bundles, forming cortical units which are supposed to play a preeminent role in coherent brain activities. The neuron is a sophisticated system able to handle a large amount of information, whose input units of integration are the synaptic spines, about 20.000 to a cortical pyramidal cell. Both electrical signals and macromolecules travel between the spines and the soma along the dendritic branches, and the soma targets a single spine with extreme specificity.

A nerve impulse propagating into a synapse causes the process of exocytosis which is the release of transmitter substance across the synaptic membrane, resulting in a brief excitatory post-synaptic depolarization (EPSP). Many of these milli ESPSs are required to generate a discharge of an impulse by a pyramidal cell. Exocytosis is an all or nothing process, occurring with a probability much less than one per incoming nerve impulse. Synaptic transmission therefore qualifies as the basic regulator of brain activities. This has been demonstrated in various biochemical studies of the influence of drugs and narcotic substances on the ion channel properties of the synaptic membrane.

In neurones there is a potential difference of 60 mV across the cell membrane due to different ion concentration inside and outside the cell [7]. This potential is maintained by the neuronal membrane which is permeable to potassium ions,  $K^+$ , but 100 times less permeable to sodium ions,  $Na^+$ . The difference between neurones and other cells is that the neuronal membrane is subject to electrical excitation.

When special pores, ion channels, are electrically simulated, they open, allowing in sodium ions. The

potential is consequently raised for additional 30 mV. To restore the original potential difference, the sodium channels close and other channels open to allow in potassium ions. Sodium ions are gradually pumped out and potassium ions taken up to restore the original ionic balance. The whole process lasts a few milliseconds and results in an electrical impulse moving along the neurone. The passage of a nerve impulse along the neurone is a series of electrical impulses. The brain must generate ATP in large quantities to maintain the membrane potentials essential for transmission of nervous impulses (the brain's need for about 120 grams of glucose per day is equivalent to 1760 kJ - about 15% of total energy consumed).

Neurons are not physically connected to each other, so a specific mechanism is needed to propagate a signal to another neurone along the pathway: the arrival of the action potential at stimulates the opening of electrically-sensitive calcium channels. The increase of calcium ions,  $\text{Ca}^{2+}$ , concentration causes the fuse of storage vesicles containing neurotransmitters with the neuronal membrane and the release of their contents into an empty space between two neurones (synapse). The transmitters diffuse across the synapse to the receptors in membrane of the second neurone and activate the mechanism which increases the electrical susceptibility of the neurone and initializes a second action potential.

The neurotransmitter must be removed from the synapse to stop the continuous stimulation, which is done in three common ways:

- excess neurotransmitter can bind to a presynaptic receptor molecule
- specific enzymes in the synapse can metabolise and remove the neurotransmitter
- excess neurotransmitters can be reabsorbed into the presynaptic neurone

The term neurotransmitter is often used to describe any small molecule in the brain. However, it only correctly describes molecules that are synthesised, stored and released from neurones into the synapse and subsequently act at post- and presynaptic receptors. Many small molecules, including some short peptides, have been shown to be neurotransmitters, such as dopamine, acetyl-choline, histamine and serotonin (Fig. 2).

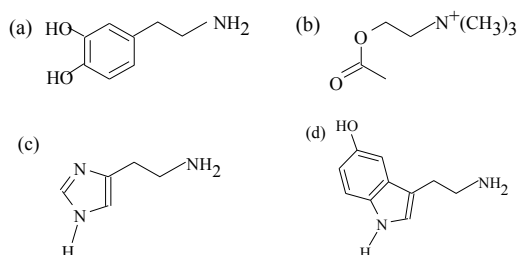

**Figure 2** Substances that act as neurotransmitters in the brain: (a) dopamine, (b) acetylcholine, (c) histamine, and (d) serotonin

Dopamine is synthesised from the amino acid tyrosine, which is actively taken into the brain by a selective mechanism (Fig. 3).

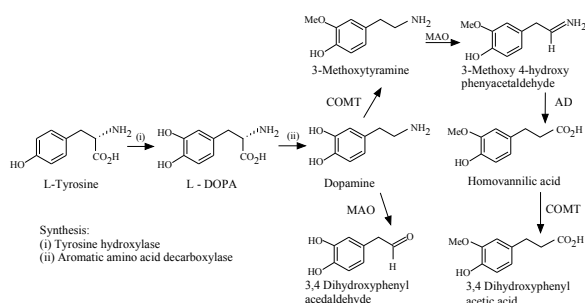

**Figure 3** Synthesis and metabolism of dopamine

The tyrosine is then hydroxylated to give 3,4-dihydroxyphenylalanine (L-dopa) by an enzyme found in the membranes of dopamine-containing neurones, tyrosine hydroxylase. L-dopa (Fig. 4) is also the starting point for the synthesis of other catecholamines related to dopamine.

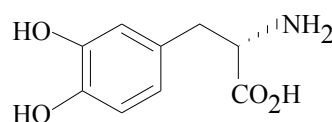

**Figure 4** The chemical representation of L-dopa, stereoisomer, enantiomer (optically active) a drug used in treating Parkinson's disease

The synthesized dopamine is stored in vesicles close to the end of the neurone. On stimulation the vesicles fuse with the end of neurone, releasing the stored dopamine which diffuses across the synapse to interact with the post-synaptic receptor. Having carried out its function, the dopamine must be removed to avoid overstimulation and this is achieved by reuptake from the synapse back in the presynaptic neurone. As reuptake mechanisms cannot be totally efficient, other enzymes, such as monoamine oxidase and aldehyde dihydrogenase, are present.

Dopamine and serotonin are important neurotransmitters in the brain [8]. Abnormalities in the level of dopamine in the brain are associated with many psychiatric disorders, including Parkinson's disease. The close association between dopamine and neurological and psychiatric diseases and with substance abuse make the dopamine system an important topic in neurosciences research and an important molecular target for drug development. For years scientists have agreed that some behaviour flaws can arise from environmental influences, raising up, the traumatic life crisis and so on. The new research results show that the simple indicator of the human behaviour and mood may be a level of a certain chemical messengers, neurotransmitters: dopamine and serotonin. Dopamine plays a pivotal role in the regulation and control of movement, motivation, and cognition. Serotonin is a compound of particular

interest because it appears to be important in maintaining stable mental processes. Since the discovery of serotonin in the 1950s, researches are finding evidence that one of its roles is to mediate emotions and judgement. It is believed that low activity of this chemical in the brain can lead to an underlying inability to handle powerful feelings, which can result in impulsive act, aggressive behaviour and suicidal tendencies. It has been suggested that the mental disorder schizophrenia may be connected with abnormalities in the metabolism of serotonin.

The brain chemistry obviously determines performance. Addictions and diseases have nothing to do with beliefs, morals and attitudes. They are the results of brain chemistry - the metabolic processes are deranged, and not the psychological condition in our heads. The reason why drugs make us feel better or normal is because of their chemical action on the brain. But the daily use of a substance whose chemical action is in the brain eventually changes the way the brain works and a person is unable to respond within the normal range. Amphetamine and mescaline (Fig. 5) have structures similar to those of serotonin, adrenaline, and noradrenaline. They are all derivatives of 2-phenylethylamine.

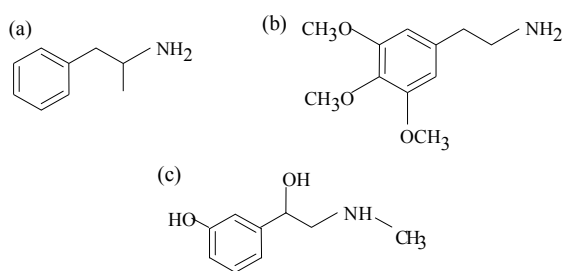

**Figure 5** (a) Amphetamine; (b) mescaline; and (c) adrenaline (epinephrine)

The structural similarities of these compounds must be related to their physiological and psychological effects because many other compounds (LSD, morphine, codeine) with similar properties are also derivatives of 2-phenylethylamine.

Although the chemical mechanism of transmitting neural impulses is explained, the creation of consciousness and awareness in brain is still a mystery. Is there a simple expression of human consciousness? Usually our minds are an enormously

complex stew of thoughts, feelings, sensations, wants, snatches of song, pains, drives, daydreams and, of course, consciousness itself more or less aware of it all. To understand consciousness in itself, the obvious thing would be to clear away as much of this internal clutter and noise as possible. Consciousness should be understood as independent or autonomous from our perceptual mechanisms.

### 3 Conclusion

The problem of consciousness lies uneasily at the border of science and philosophy. It is a scientific subject matter: it is a natural phenomenon like motion, life and cognition, and calls out for explanation in the way that these do. But it is not open to investigation by the usual scientific method. We believe that the chemical and biochemical processes included in the chemistry of brain are the dominant key to understanding consciousness and human behaviour, besides, of course, quantum mechanical and other physical factors.

### References

- [1] D.J. Chalmers, Facing up to the problem of consciousness, *Journal of Consciousness Studies* 2(3) (1995), pp. 200-219.
- [2] For more details, see F. Crick, *The Astonishing Hypothesis* (Macmillan Publ. Co., New York, 1994), and references therein.
- [3] Dj. Koruga, S. Hameroff, J. Withers, R. Loutfy, and M. Sundershan, *Fullerene C<sub>60</sub>: History, Physics, Nanobiology, Nanotechnology* (Elsevier, Amsterdam, 1993).
- [4] *In Toward a Science of Consciousness, The First Tucson Discussions and Debates*, S. Hameroff, A. Karniak, and A. Scott (MIT Press., 1996).
- [5] K.R. Popper and J.C. Eccles, *The Self and Its Brain* (Springer Verlag, Berlin, 1977), Part 1.
- [6] S. Grove, *Thank You, Brain* (Human & Rousseau, Cape Town, Johannesburg, 1990).
- [7] G.I. Stevenson and R. Baker, *Brain chemistry, Education in Chemistry* 13 (1996), pp. 124-128.
- [8] T.W.G. Solomons, *Organic Chemistry* (John Wiley & Sons Inc, New York, 1996).





## VISUALIZATION OF ILLNESS IN A DEEP RELAXATION IN ASTHMATIC CHILDREN AND ADOLESCENTS

Olga Vulićević, and Tomislava Grgurović

Municipal Institute for Lung Disease and Protection Against Tuberculosis, Belgrade, Yugoslavia

**Abstract.** The visualization method is favorable for the children treatment, because it is like a game, it occupies the imagination and provides a good transfer easily. During the process of their psychological reviewing, children explained their own imaginations through drawings which describe illness in different, symbolic ways, more or less abstractly, depending on the children's age. Patients of the age between 10 and 24, which are seriously asthma-affected, are treated by combined method: classical medication and physical therapy, reeducation of psychomotrics and sensation of the body as a whole, as well as psychotherapy. Ill children are passed through autogenic training during which they get a task to visualize a light jacket around their bodies. The light is taken as a symbol of sun, cosmic grace, self-protection by own energy field. It is suggested to the patients that the above-mentioned jacket is necessary for protection of the intimate space about their bodies. Thus it is possible to obtain the data on the nature of patient's sensation of his illness and the way in which he can oppose his illness. After completion of the visualization process, the patients drew what they "saw".

**Key words:** *children, asthma, visualization.*

### 1 Introduction

Guided affective image techniques (visualization) include both diagnostical and therapeutical procedures in psychotherapy of the children and adolescents affected by asthma. During the visualization diagnostical and therapeutical processes are often overlapped because of the adapting to the children's current attention and their personal capabilities for imagination. Since this method is often like a game and engages the imagination establishing good transfer, it was possible to establish communication with painful, pushed out emotional contents, or to obtain data about one's own body, i.e. about sensation of the illness.

The children told that they "could see" their fear, their bodies damaged by illness, illness as a strange, unwanted entity, unbalance of their energy status, and exactness of the surroundings which endanger them. During the process of their psychological reviewing, children explained their own imaginations through drawings which describe illness in different, symbolic ways, more or less abstractly, depending on the children's age. For a long time, people are interested in "the interior pictures", which appear when eyes are closed, and use them in religions, psychology and arts

as a way to getting close to God, to the subconsciousness, or to the inspiration. Guided images techniques make possible to obtain a review of subconsciousness personal dynamics and diagnostical file in the symbolic terms which can be then applied for the therapy purposes, i.e. in personal increase of self-comprehension, emotional maturity and changing of position to the life situation.

At the beginning of his research, Freud dealt with the catharsis technique, bringing up traumatic experiences to consciousness and their affective connections in the hypnosis state. Freud observed that meditation in the form of pictures is closer to subconsciousness processes than meditation in the form of the words. He searched for the symbolic experiences of patients and then he directed them to a favorable ending [1]. Frankl also studied the appearance of hypnogogic visions in the deep relaxation, and Kretschmer compared visions with dream analysis [2,3].

Differing from the above-mentioned, Jung introduced the technique of "active imagination" by which the patient was encouraging to visualize by himself, without the therapist's presence.

His opinion was that, in the therapist's absence, archetype contents appeared spontaneously, without disrupting [4]. Moreover, it was important to analyze the dreams of the patient so that his basic motives could be understood.

Schultz's method of autogenic training has been frequently used for relaxation in the past as well as today [5,6]. The relaxation consists of the willing relaxation of the body for the purpose of favorable acting on psychic structures and functions of the person. This willing process leads to the lowering excitation from the muscle receptors in the *Formatio reticularis* (FR), thus decreasing excitation of the spinal neurons of the myofibrils, with further decreasing of the FR tonus and the dynamogenic effect on the diencephalon and brain cortex.

In the relaxation, alpha waves often appear in the EEG, and it is a characteristic of the inactive mental states [7]. In this state subject communicates more easily with his suppressed contents of subconsciousness. As asthma in its psychodynamic meaning generally resembles the neurotic states of the catharsis crises, (i.e. it is hard to be eliminated by conversive mechanisms), it is considered that the asthma is the

result of the conflict between the child and his actual reality and, at the same time, it is a defence mechanism, as well as the masochistic satisfaction of the man "who dies" and "who avenges" for his rejection [8].

According to the Schulz's method, first it is necessary to pass "lower course" which consists of six phases: weight feeling, heat feeling, heartbeats, breathing, plexus solaris, and forehead freshing. "Higher course" is a meditative one, when the symbolic phantasy is introduced (visualization of colours, forms, ideas about emotions, ideas about friends and morality, etc.).

In this way, the subject is directed to the fundamental existential values, and he tends to the reasonable life position, selfrealization, mental freedom, harmony, and creativity.

Guided images techniques were used by Happich, Desoille, Leuner, Kelley et al. In general, these techniques are mutually similar. A therapist usually gives a patient an image or motive which equates with the corresponding flow of the suppressed emotional experiences. They appear in the consciousness in the form of symbols or symbolic events. By leading of the symbols (and they are usually archetype schemes) through new symbolic relations, it is possible for the emotional complex which follows the symbols to be connected to the new experiences acquired during dreaming. It is very important that these experiences are beneficial [9].

The aim of this work is reviewing of diagnostical and therapeutical possibilities of visualization, as a method suitable for the treatment of children.

## 2 Material and Methods

In this work, fifteen patients with ages from 10 to 24 years are examined. All of them are seriously asthma-affected and treated by combined method: classical medication and physical therapy, reeducation of psihomotrics and sensation of the body as a whole as well as by psychotherapy.

Children pass through the relaxation and autogenic training first. Patients' task is to visualize their body as wrapped with white light. Beams of the light start from their eyes, and the patients have to imagine that these beams go round the body, starting from the top down to the toes thus making a jacket around the body until it becomes equal in thickness and density. Patients explained their visions about changes of thickness, density, colors or possible breaks in their light jackets. Then their task was to imagine their illness: where it comes from, how they experience it, how it affects them, how it changes and how they can oppose it. After completion of the visualization, patients drew what they "saw".

## 3 Results

1. M.R., age 10: visualized the light jacket around his body; he did not "see" his illness but he told his dream about it. It is a colorless ghost like a devil with the trident, flying around chandelier. The devil is always hungry. He eats stones, trees, all around him. When the devil comes to M.R., the devil is jingling the marbles down on the floor until M.R. becomes awake. Then M.R. takes a vacuum cleaner and cleaned the devil.
2. Dj.Z., age 11: the light jacket is white and uniform, for him transparent for others opaque. He senses the illness as the "shrank lungs", with tightening in his throat. (Fig.1)



Figure 1 Dj. Z., age 11

3. M.O., age 11: the light is all over him. The illness comes from inside, from the lungs that are plugged with corks. These corks are of rubber and the lungs tighten, these corks get in the lungs and prevents me from breathing in. Like the lungs are tired, they do not have enough power to put away that obstacle. When asthma isn't present, corks fly away, like they are not here or they hide in the lungs."
4. J.K., age 13: He visualizes his illness like "small, green, freckles, plump monster, an alien. He can be evil, dangerous, but good as well" (Fig. 2).



Figure 2 J. K., age 13



5. B.B., age 13: when he is ill, then “lungs fall” and “the wounds up to 10 cm in diameter broaden over lungs. When he feels well, ”wounds are about 2 cm in diameter. Then, he feels almost healthy” (Fig. 3).

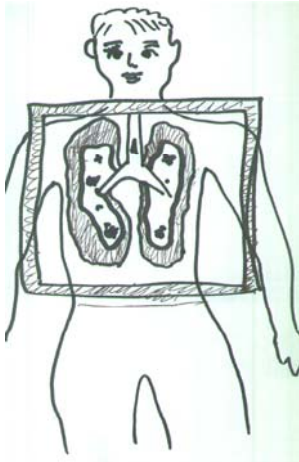

**Figure 3** B. B., age 13

6. N.U., age 15, “rolled” his body by light jacket, which is uniform and thick. He visualized his illness like a spider, which sticks inside the jacket, in the region above the rib cage (Fig. 4).

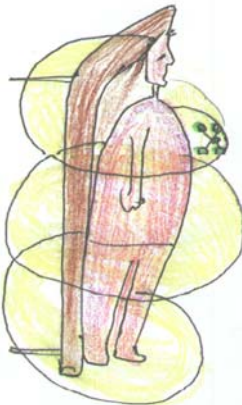

**Figure 4** N. U., age 15

7. S.S., age 14, first visualization: describes illness like “small beetles that are all over her, in fact inside her, because they are in bronchi. They make her sick”. They are ladybug size, white-brown coloured. When she coughs, she ejects them dead. Then, they are less in number, somewhere, isolated.”

*Ibid.*, age 17, second visualisation: feeling of health describes as a state “when she hasn’t got any problems”. Disease feels “from navel to chin, here, from here to this place.” It is something what arrives from outside, but she doesn’t remember when it happened. She feels in the lungs something like “scratching”, like “some small wheels that turn around and scratch her”. When she has an episode - “machinery is on”, when she hasn’t one, “machinery is off”. If she were healthy, the machinery would not be inside the lungs but

outside the organism, it would be ejected and she would feel nice and healthy.” Illness is always here, it walks through the lungs and heart. It is a strange body, surplus, and a burden to her.

8. E.K. age 18: she wrapped herself in the light, she feels more light in the rib cage region. She feels that illness comes from outside, “the new light, which tends to penetrate into the lungs dark-brown colour”. The illness comes from far, attracted by the glow of the E.K.'s light, which is bright and it stops dark one coming from outside, but not completely because some of the rays penetrate in the rib cage region. It happens sometimes, that she senses certain weakness and when her own light radiates less. She doesn’t know why it happens, spontaneously. “The light (my) tries to remain around my body, it seems that my light is fighting the dark one, get tired at the moment and then resists and radiates again”. The dark light comes “from the right side, from southeast, from below, from backside, askance”. The dark ray comes from far. She can push it back when she “puts her light as a shield”. For this purpose, she “intensifies her light”. Then, the strange ray is rejected and “like a smoke goes back, diluted and discolored” (Fig. 5).



**Figure 5** E. K., age 18

9. Z.S., age 18: visualizes “the fog, always present, of black color, which is dense during the attack, in the absence of attack light-pink colored, translucent, sunlight penetrates through it. "All people cannot see the fog; it disturbs those who can see it." People who are sensible can see the fog, people who care for others. People who do not see the fog, do not care what is happening, the fog does not disturb them; people who can see the fog try to put it away. If the black fog disappears, the white one comes. The white fog is always present. The appearance of black fog is connected with myself. If I am alone in the room and have a problem, and I do nothing to solve it, I’ll go insane!” During the relaxation, she feels that the wire which is around her neck chokes her. She often touches her neck.
10. M.S., age 18, the month after caesium operation: aphonyis occurred first, by subsequent hindered

breathing, like asthmatic. She undergoes psychotherapy treatment, and a few months later, during the light wrapping of her body, she feels "certain pressure in the regions of thighs and abdomen, as if the therapist presses her down from outside". She continues to wrap her body in the light, but it does not seem the same. She visualized the big, dark, big mass above her pelvic bones and thighs. A week later she comes with strong pains in the region of the scar from caesium operation accompanied by heat feeling in that region, by vomiting and by stiffing of her right leg. Various specialists' checkups could not give a diagnose. Finally, six days later, orthopedic examination showed partial break of fibres at the abdomen muscles (mm. rectus et externus abdominis). After the treatment of these injuries, asthma got worse, attacks became more serious, followed by night tightening.

11. M.O., age 19, visualizes black stain on her lungs, by broadening to her trachea and bronchi. Illness appeared in the age of 5-6. She feels "as she inhaled it", as illness "entered in her body." When she does not feel well, the stain grows taking the form of the ring, about 5 cm in diameter, which wraps bronchi on left side of the rib cage. When she is not ill, stain reduces up to 1-2 cm in diameter only or, however, it is not present in her body. As if she ejected it and then she feels well. As if the stain, that "blackness" goes out together with air, however, its place remains, and when she gets cold the stain takes its place again. When she was young, the stain came first, and after that, the place was formed. It began when she ate some snow. If the treatment were prolonged, it would be possible that black stain stay away from her lungs and then the place for the stain would be leveled.
12. D.S., age 21, visualizes his illness like a dark grey-olive green fog, a cloud, which appears in the early evening, by subsequent condensation like a fog on the earth, he visualizes that the cloud is in the garden. The garden is a relaxation place in his imagination: plants, bushes, flowers, grass, a labyrinth of paths. He likes this garden (Fig. 6).



Figure 6 N. P., age 21

13. N.P., age 21, during the wrapping in the light, he cannot make it around his nose (which is large-size and outside of the wrapping) and around his neck (as it slips down). However, the other parts of his body are continuously wrapped in the light jacket.
14. V.P., age 21, during the relaxation, he doesn't feel heat about his neck. He visualized a big, white cylinder about his neck; the cylinder is connected with the atmospheric changes, not with people. Without the cylinder he feels like "the right me". That "the real part of himself" he feels like something new what arises from his breast, grows like a fan and knows something good about him, it is "on his side", he likes it. "The old me" and "that the new" created a new stronger person in me." This is me, essentially". He removed the cylinder (collar) but it returned again. Then, he put it into two closed boxes in order to prevent it from going out. He threw the boxes at the certain hill, water. He is feeling well. The jacket around the whole body has, at first, yellow-white layer, then whitish-blue one and afterwards all around it is blue. Around the "collar", which chokes him about his neck, the light is thickened. Between the collar and aureole there is the empty space as the collar "repulse" the jacket and doesn't allow it to approach (Fig. 7).



Figure 7 V. P., age 21

15. Z.S., age 24, at the relaxation feels thickening about her neck, as there is here the tampon with the small hole for the breathing. She imagines that there is here - the frog. She visualizes her illness as the spider which stays near her place, waiting for the chance to seize her on in order to choke her, when she sleeps. She hasn't got any way to oppose it.

#### 4 Discussion

The children in the puberty age visualize their illnesses like a creature arrived from outside world or like changed body-lung. The symbolization is somewhat better in adolescents - movable machinery or the small organisms. The older patients feel their problem in their light jacket or in the atmosphere around them.

In all cases, the illness is something what came nonwillingly, it can be felt like the attack from something which endorses their survival. On the other hand, it seems that person missed the moment to oppose it, but he wishes to make it now. There are indefinite consciousness about own weakness, fatigue or the loss of energy at the moment of asthmatic attack. During the prolonged treatment, patient clearly drew their experience about illness.

## 5 Conclusion

The visualization of illness in the age from 10 to 24 gives the different symbolic contents, but it is always present consciousness about the danger, about the changeable own defense power, as well as about the need for the resistance. The imagination gives the good diagnostical and therapeutical possibilities during the work with the children.

## References

- [1] S. Freud, *An Onthine of Psychoanalysis* (Norton, New York, 1949).
- [2] E.V. Frankl, *The Decor and the Sou* (Pelican Books, 1973.).
- [3] C. Kelley, *Education in Feeling and Purpose*, (The Radix Institute, Santa Monica, CA, 1974), Ch.4.
- [4] C.G. Jung, *Man and His Symbols* (Dell Publ., New York, 1972).
- [5] J.H. Schultz, *Le training autogene* (PUF, Paris, 1970).
- [6] H. Lindeman, *Autogenic Training*, (Prosveta, Zagreb, 1976), Serbo-Croat transl.
- [7] S. Bojanin, *Neuropsychology of the Adolescent Age and General Reeducative Method* (Zavod za udžbenike i nastavna sredstva, Belgrade, 1985), in Serbian.
- [8] N. Kožinkova, and M. Hristova, Converse mehanisms of the egzabcerbations of acute states of the bronchial asthma, *Proc. 1st Yug. Congr. of Neurol. & Psychiat. of Adolescent Age*, Belgrade, May/June 1979, p. 225.
- [9] Lj. Klisić, *Integration of Psychotherapeutics Tehniques of Guided Pictures and Movements* M. Sc. Thesis (Faculty of Medicine, Belgrade, 1978), in Serbian.

## AUTHOR INDEX

<b>A</b>	
Abramović V. ....	15
Adamov J. ....	205
Alečković-Nikolić M. ....	35
Amoroso R.L. ....	297
<b>B</b>	
Bondi Man. ....	201
Bondi Mas. ....	201
Božović Z. ....	241, 245
Brakus R. ....	75
Brakus V. ....	75
<b>C</b>	
Cakić J. ....	49
Car M. ....	255, 263, 269
<b>Č</b>	
Čulić M. ....	223, 227, 237
<b>D</b>	
Damianovitch E.V. ....	219
Delić N. V. ....	321
Desimirović V. ....	39
Dreimanis A. ....	317
Driver H. ....	247
<b>Đ</b>	
Đoković S. ....	83
Đorđević V. ....	71
Đurović T. ....	59
<b>F</b>	
Fenwick P. ....	7
<b>G</b>	
Gec V. ....	69
Grgurović T. ....	165
<b>H</b>	
Hadži-Nikolić Č. ....	159
<b>I</b>	
Ivanuš J. ....	241, 245, 69
Ivoić G. ....	285
<b>J</b>	
Jaćimovski S.K. ....	321
Janković B. ....	223, 227
Janković B.I. ....	237
Janković M. ....	223, 227, 237
Jovanov E. ....	213, 251, 255, 263, 269, 291
Jovanović-Ignjatić Z. ....	213
Jovićević M. ....	133
<b>K</b>	
Kalauzi A. ....	241, 245
Kalezić J. ....	177
Kanazir D. T. ....	3
Kaznatcheev V.P. ....	19
Klisić Lj. ....	123
Kljakić Lj. ....	27
Koruga Dj. ....	335
Kostopoulos G. ....	185
Kostov A. ....	233
Kovelman J.A. ....	313
<b>L</b>	
Lobovikov V.O. ....	11
<b>M</b>	
Margot A. ....	101
Martinović Ž. ....	251
Matija L. ....	331
Mirjanić D.Lj. ....	321
Mišić L. ....	93
Mojović D. ....	171
Momirov M. ....	137
<b>N</b>	
Nedović G. ....	241, 245
<b>O</b>	
Orlova T.V. ....	219
<b>P</b>	
Pantelić S. ....	79
Pavlović D. ....	43
Percinkova B. ....	303
Perović P. ....	173
Petković-Medved B. ....	159
Petrović S.P. ....	209
Polak M. ....	233
Popović M. ....	205
Popović S. ....	237
<b>R</b>	
Radenović D. ....	213, 263
Radičević V. ....	275
Radičević Z. ....	275
Radivojević V. ....	213, 251, 255, 263
Rajšić M. ....	241
Rajšić N. ....	241, 245
Rakočević M.M. ....	107
Raković D. ....	145, 213, 251, 255, 263, 269
Rapajić D. ....	241, 245
Ribarić I. ....	195
Ribnikar J. ....	141
<b>S</b>	
Saraswati S.S. ....	121
Schmieke M. ....	307
Schubert M. ....	129
Shapiro C.M. ....	247
Smith C.W. ....	283
Sovilj M. ....	79
Stanojević M. ....	101
Stanojević-Vitaliano G. ....	151
Stanojlović S. ....	269
Šubota N. ....	71
<b>Š</b>	
Šaponjić J. ....	223, 227, 237
Šesterikov B. ....	327
Šetrajčić J.P. ....	321
Škarić L. ....	263
Škokljević A. ....	87
Škokljević I. ....	87
Šuković P. ....	251, 263, 269
Šuljagić S. ....	241, 245
<b>T</b>	
Tomašević M. ....	213, 255, 263, 269
Trajanović N. ....	247
<b>U</b>	
Udović S. ....	237
Utješanović A.S. ....	321
<b>V</b>	
Vojinović - Miloradov M. ....	205
Vujićin P. ....	117
Vulićević O. ....	165
<b>Z</b>	
Zorić V.M. ....	321