

Durasan[®] BRAND

Prefinished Gypsum Board



National 
Gypsum[®]

Beautiful Walls Don't Get Any Easier Than This!



Santa Fe Adobe

With National Gypsum Durasan® BRAND Prefinished Gypsum Board, durable yet elegant interior walls don't require a lot of work! Or a lot of time! Or a lot of money! Because the panels are already finished, there's no taping, no joint finishing, no sanding, no priming, no painting, and no wall covering application.

All those steps, all those trades, all that mess and all those expenses are eliminated. Installation is quick and easy. In most cases, your walls are up and finished in one day or less.

Colors And Textures For A New Century

Today's workspace continues to evolve, and Durasan panels are designed to take on the challenge. With a variety of stylish patterns and colors to choose from, Durasan panels will fit right in. Whatever the look, whatever the feeling you are trying to achieve in your space, Durasan panels can help you achieve it beautifully, simply and cost effectively.



Santa Fe Porcelain

The Perfect Panel For Perpetually Changing Work Spaces

Once the exception, now the rule, change is as much a part of today's workplace as computers and networks. Because so much of the usual effort and expense of wall installation is eliminated, Durasan panels provide you with the flexibility to accommodate changing workspace configurations, so important in today's highly "wired" environments.

Benefits Go To The Bottom Line

Yes, the installed cost of Durasan panels is typically less than conventional drywall with field-applied wall coverings. But, that's only the beginning. Their washability and low maintenance provides an additional savings in overhead costs.

In addition, depending on the design plan, when Durasan panels are installed as part of a relocatable wall system, they may be eligible for accelerated depreciation. Thus, they can generally be depreciated

over seven years instead of the usual 39 years for conventional construction. Your tax adviser can give you the specifics.

A Tradition Of Value

Business owners, architects, builders, facility managers and interior designers have recognized Durasan panels as the leader, and the dependable constant, in the ever-changing gypsum board market. That trusted reputation is built on National Gypsum's continuing commitment to quality, value and performance.

An Easy Choice

With all these advantages, it is easy to see why Durasan Prefinished Gypsum Board is the preferred choice for distinctive walls that are elegant, economical and easy to install.

Pattern and Color Selection

Group 1 – Stipple

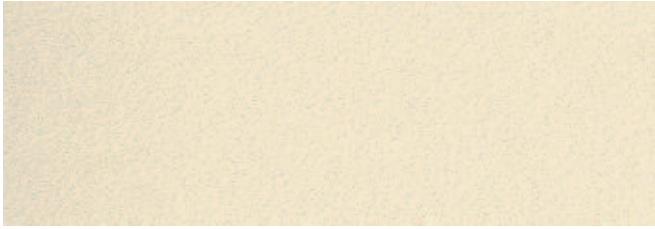

Champagne

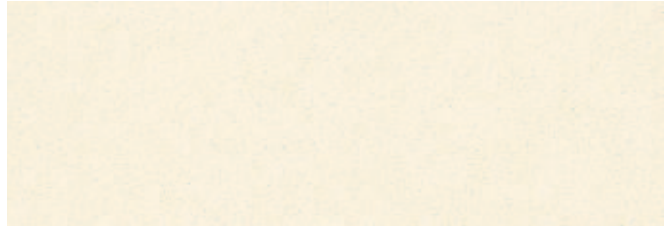

Chiffon



Off White

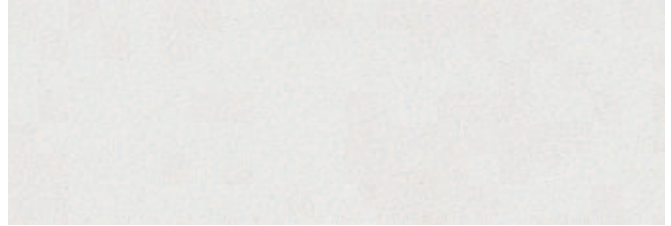

Cloud

Group 3 – Santa Fe



Porcelain

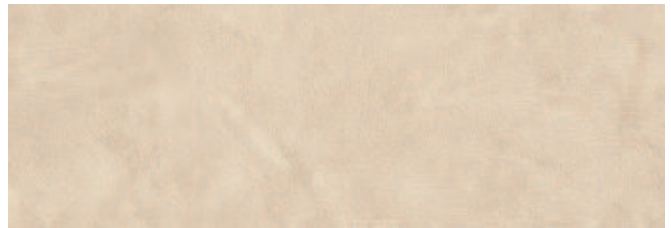

Adobe

Group 3 – Harvest



Cotton



Oyster White



Rice

Color accuracy of these Durasan panel patterns is limited in printing. Therefore, it is suggested that reference also be made to actual samples in the Durasan Pocket

Selector. Contact your National Gypsum Sales Representative for Selectors and for information on Durasan panel delivery schedules in your area.

Durasan Patterns by Price Group
(in order of ascending value)

Group 1 – Stipple

Group 3 – Santa Fe, Harvest

Durasan[®] BRAND Prefinished Gypsum Board

Description

The Durasan line consists of Durasan[®] BRAND vinyl covered panels. All Durasan panels can be applied directly to studs or as a finish layer over gypsum board. Durasan panels are especially suited for most demountable partition systems. Because Durasan is prefinished, it is generally less expensive to install than building a wall and then applying a wall covering material.

Durasan is the registered trademark for National Gypsum Company prefinished gypsum wall panels. This quality paneling combines the time-proven characteristics of gypsum board with the beauty, colors, textures, and durability of a wide variety of vinyl coverings.

Durasan can be toploaded on gypsum trucks and is available from most National Gypsum plants. Some plants maintain inventories of the most popular colors and patterns, which are available for immediate shipment.

Technical Data

PHYSICAL PROPERTIES

Thickness: Available 1/2" thick as a standard product. Fire-Shield Durasan is also available as a special order item in 1/2" or 5/8" thicknesses.

Width: Durasan panels are 4' wide.

Lengths: 8', 9' and 10'. Other lengths between 8' and 14' are available on special order.

Edges: The long edges of all Durasan panels are wrapped with a vinyl film covering. Panel edges are beveled.

Vinyl covered Durasan panels comply with ASTM Specification C 1396 and Federal Specification SS-L-30D. Approved by Board of Standards and Appeals for use in New York City under Calendar Nos. 709-39.

NONCOMBUSTIBLE

Durasan panels are considered noncombustible, since they meet the following generally accepted requirements:

1. A structural base of noncombustible material such as gypsum.
2. A surface material not over 1/8" thick which has a flame spread of not over 50.

FIRE RATED CONSTRUCTION

Assemblies employing Durasan panels used as a wall surfacing material have been accorded fire resistance ratings by Factory Mutual Research Corp. and Underwriters Laboratories.

VAPOR PERMEANCE

The water vapor permeance of Durasan panels is less than 1.0 perms by the Wet Cup Method and less than 0.5 perms by the Dry Cup Method at typical conditions of 73°F and 50% relative humidity, tested in accordance with ASTM E 96. Caution: Durasan vinyls are vapor retarders, and a second vapor retarder should not be placed behind these products, i.e. kraft face insulation. For this reason, foil backed Durasan is not available.

COLOR PERMANENCE

The high-quality vinyl surface of Durasan panels offers good fade resistance. The vinyl films are specially formulated with light-stable compounds and pigments to provide maximum stability and color retention under varying environmental conditions.

SURFACE BURNING CHARACTERISTICS

(Fire Hazard Classification)
(ASTM E 84) Source: Underwriters Laboratories, Inc.

Product	Flame Spread	Smoke Developed
Durasan Vinyl	25 or less	50 or less

DURASAN AVERAGE LIGHT REFLECTANCE VALUES*

Group	Pattern	Color	Reflectance Value	
Group 1	Stipple	Champagne	69	
		Chiffon	77	
		Cloud	69	
		Off White	85	
Group 3	Santa Fe	Porcelain	69	
		Adobe	55	
		Harvest	Cotton	65
			Oyster White	52
			Rice	68

*X-RITE 968 Reflection Spectrophotometer used in accordance with ASTM Test Method E 97.

DURASAN VAPOR PERMEANCE VALUES

Patterns	Perms	mil	(mm)
Stipple	0.49	6	0.15
Santa Fe	0.25	6	0.15
Harvest	0.28	6	0.15

Above vapor permeance values determined using the Dry Cup (Desiccant) Method at typical conditions of 70°F (21.1°C) and 50% Relative Humidity in accordance with ASTM E 96.

CLEANING

Complete removal of dirt, stains and marks is easier if cleaning action is started before staining material has dried, cured or set.

To remove most common dirt and marks, simply rub lightly with a moistened cloth, sponge or soft hair bristle brush, using a mild soap, detergent or non-abrasive cleaner. Then rinse with water and wipe dry.

More stubborn stains can be safely removed by wiping away excess material, scrubbing the stained area with a stiff bristle brush wetted with appropriate solvent as listed in chart below, and quickly wiping dry with a clean cloth.

Caution: The use of strong organic solvents (such as ketones), harsh abrasive cleaners or steel wool are not recommended. These materials may cause dulling, discoloration, softening and other permanent damage to the vinyl surface.

Some proprietary solvent cleaners used for fabric spot stain removal may remove the vinyl surface overprint pattern.

If the suitability of any cleaning agent is unknown, check its effect on the Durasan surface in a hidden area or on a scrap piece before attempting to remove a field stain.

CLEANING RECOMMENDATIONS

Common Staining Material	Recommended Solvent
Grease, tar, shoe polish, lipstick, oil paints	Kerosene or mineral spirits
Nail polish	Denatured alcohol
Ink (regular or ballpoint)	1:1 mixture—Denatured alcohol and Aromatic 150*

*Aromatic 150 is a proprietary solvent manufactured by Exxon Company USA.

ABRASION RESISTANCE

Durasan panels are extremely abrasion resistant, and are tested by a Taber Abraser with CS-17 Calibrate wheels and a 500 gram loading. Durasan has withstood over 10,000 revolutions without breaking through the vinyl film. During this testing, some loss of texture and overprint resulted.

PAINTING

Durasan is a factory-finish decorative product which does not require painting.

However, if desired, Durasan can be satisfactorily painted with the following products:

1. Two coats of an alkyd or latex semigloss enamel.
2. Oil primer with finish coat of oil paint or flat latex.
3. Two coats of flat oil paint.

PATCHING

It is suggested that scraps of Durasan be saved in case patching a damaged area is necessary. When patching small rips or tears, remove the vinyl film from a Durasan scrap. Place the film over the damaged area and, using a razor blade or very sharp knife, make straight cuts through both layers of film. The damaged film underneath is then removed and the patch cemented in its place with a good quality vinyl-to-vinyl adhesive.

WALLCOVERING

Matching Durasan in 30 Lineal Yard Rolls

Fabric-backed vinyl film is available in most Durasan patterns, colors and textures for field application to provide a **close, commercial color match** for use on columns, curved surfaces or where extensive cutouts would make Durasan panels difficult to use. Because field-applied vinyl is fabric-backed, the **Durasan panels and the complementary vinyl roll goods may vary slightly in color and texture.**

Durasan fabric-backed wallcoverings meet or exceed the criteria outlined in Federal Specification CCC-W-408B.

LIMITATIONS

High Heat

Durasan panels have the same limitations regarding heat as regular gypsum board and should not be used in areas where surface temperatures will exceed 125°F.

Durasan panels are not suitable for use behind stoves where direct heat or steam could affect the panel covering.

Moisture Conditions

Durasan panels should not be used around bath tubs, in shower enclosures or in areas where panels will be subject to free moisture.

When Durasan panels abut concrete floors and/or ceilings, cut the panel to allow a minimum of 1/8" clearance between panels and floors and/or ceilings to prevent potential wicking.

Treated Lumber

If Durasan panels will be applied over treated lumber, tests should be conducted prior to application to be sure the chemical treatment of the wood does not affect the bond or color of the panel covering.

Masonry Walls

Do not apply Durasan panels over wet or damp masonry walls. Mildew or staining problems could result if the walls are not dry or will not remain dry.

Trim Application

Plastic, wood or metal trim must be applied at both floor and ceiling.

Trim should be applied carefully to Durasan panels to avoid creating excessive pressures which might later cause delamination of the covering.

Color Variation

Since manufacturers of the laminate used on Durasan panels finish to a commercial color match, minor color variations are possible. Therefore, care should be taken during application to ensure that panels applied on single walls or visual areas are color matched to minimize any such variations in the laminate.

Storage and Handling

Durasan panels are a prefinished product, and as such, special care should be taken during their storage and handling.

Durasan panels should be stored inside a warehouse or other suitable structure where it will not be exposed to the weather or to temperatures exceeding 125° F. Durasan panels should never be stored outside. A firm, dry and level floor is recommended to ensure that stacks of Durasan panels are evenly supported and away from dampness. Durasan panels should not be stored in areas of excessive

humidity or in heavy traffic areas where they may be damaged by fork trucks or other warehouse equipment. Avoid storing Durasan panels at aisle corners whenever possible.

Units of Durasan panels should be properly supported to minimize sagging and waviness.

Use extra care in the placement of risers (also known as dunnage or spacers). Vertical alignment of these risers is critical to the proper storage of Durasan panels. The diagrams below indicate the correct and incorrect method of placing risers when storing Durasan panels.

Correct Method Of Placing Risers

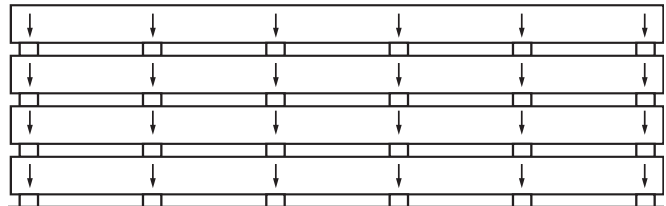

Note that all risers are placed in proper vertical alignment so each tier is evenly supported. Arrows indicate pressure.

Incorrect Method Of Placing Risers

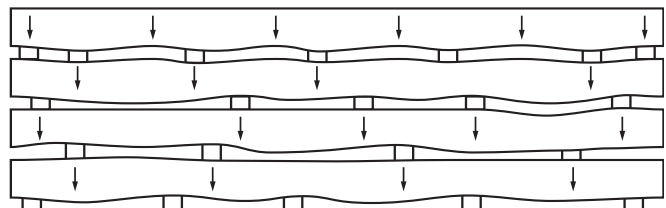

Cumulative pressure on unsupported lower units causes gypsum board to sag. Risers are not spaced evenly or in proper vertical alignment.

A minimum number of risers should be used based on the length of the Durasan panels as indicated by the following chart.

MINIMUM NUMBER OF RISERS PER UNIT				
Unit length in feet	7-8	9-11	12-14	15-16
Minimum number of risers	4	5	6	7

The following guidelines should be used when warehousing Durasan panels to avoid the potential of sagging, blocking or emboss flattening.

WAREHOUSING REQUIREMENTS			
Laminated panels shall be warehoused as follows:			
Product Thickness	Pieces Per Unit (Max.)	Units Per Stack (Max.)	Total Pieces Per Stack (Max.)
1/2"	50	4	200
	60	3	180
	100	2	200
5/8"	40	4	160
	48	3	144
	80	2	160

Unusual conditions during warehousing such as high humidity and long term storage may require the use of additional risers per unit length and/or a reduction in the number of total pieces per stack.

Accessories

MATCHING TRIM (Snap-On)

Two-part, Snap-On Outside Corner and Interior Trim consist of galvanized steel retainers and matching vinyl snap-on facings. Both trim pieces are installed after the Durasan panels

are erected. Each may be used with any Durasan thickness. Retainers are secured through the Durasan into the framing.

Snap-On Interior Trim may also be used at interior corners, at ceiling line and as a batten. Snap-on Trim can be used in Fire Rated Assemblies.

SNAP-ON OUTSIDE CORNER TRIM

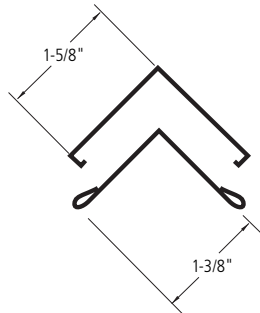
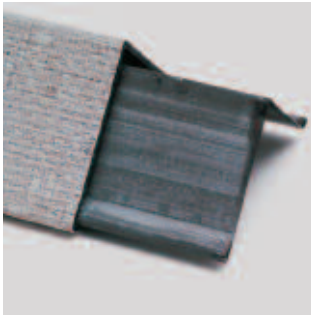

SNAP-ON INTERIOR TRIM

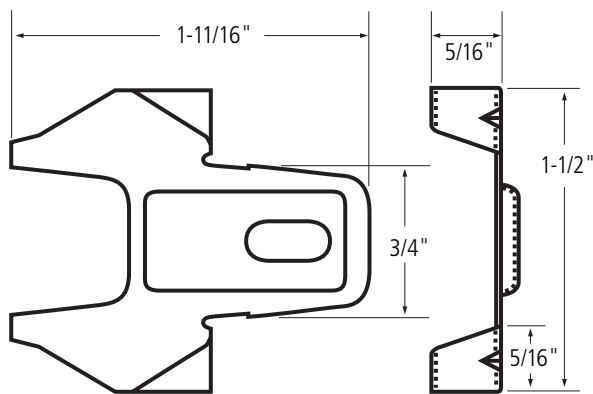
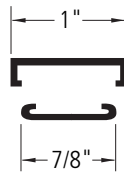
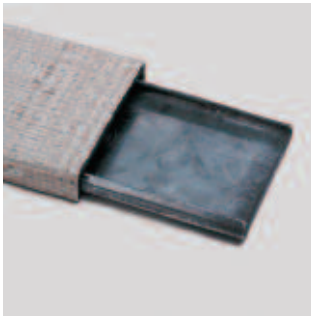

Edge grip clips provide for a simple one-step partition. The patented clips work with common framing wood or metal. Refer to pages 9 and 10 for installation recommendations.

1/2" PANELS ONLY

MATCHING TRIM (One Piece for 1/2" panels only)

Single-Part Trim (see below) is available in vinyl shapes to match all standard vinyl Durasan colors for 1/2" panels. Dimensions shown are trim for 1/2" panels.

One piece trims are progressive in nature and as such must be installed at the same time as the Durasan panels.

ONE-PIECE MATCHING TRIM FOR 1/2" PANELS ONLY	
Shapes	Vinyl
Divider	
Outside Corner	
Inside Corner	
End Cap	

General Installation

INSTALLING DURASAN PANELS

Several methods of installation may be used with Durasan products in order to meet specific job requirements. As in regular drywall construction, ceilings are installed first, before Durasan paneling is erected. Panels are attached vertically. Durasan should not be applied to ceilings.

CUTTING DURASAN PANELS

Scoring and snapping is the easiest and fastest way to make straight cuts. To do this, merely score the pre-decorated surface with a sharp knife guided by a thin board with a straight edge. Then position the scored panel so the piece to be removed is overhanging a straight edge parallel to the scored mark. Press this free end until the gypsum core snaps. Cut the back paper to remove excess piece.

Sawing Durasan Panels is easier than cutting lumber. For best results, keep the prefinished surface up and use a sharp, fine-tooth saw or appropriate router bit.

Note: Cut Durasan panels to length, 1/4" shorter than ceiling height so panels are not forced into place.

PANEL LAYOUT

Before application, proper arrangement of panels should be studied. For a most pleasing result, all joints of panels should be centered on architectural features of the wall, such as fireplaces, windows, doors, etc. If the wall contains no such openings, arrange for the two end panels to be of equal width. Narrow strips are difficult to install and should be avoided. Any special use of decorative trims and moulding should be considered at this time.

CORNER TREATMENT

Inside Corners: Where two walls intersect to form an inside corner, the last panel installed at this intersection should have two finished edges to create a professionally installed look. See photographs, "Forming A Narrow Plank With Two Finished Edges," for directions on finishing an edge on the job. This treatment can be eliminated by using Durasan Snap-On Interior Trim.

Outside Corners: Wood, plastic or metal corner mouldings, nailed or glued to wood or steel framing, are recommended for edge protection where panels meet to form outside corners. These mouldings can be stained or painted either in matching or contrasting colors, or use matching Durasan Snap-On Cornerbead.



Curved Cuts can be made easily with a keyhole saw. If an area must be cut from the center of the board, it is recommended that a hole be bored that will take the point of the saw.



Where Two Cuts Join, one cut must be made with a saw, the other cut can be made by scoring and snapping. Cuts like this are required around door and window openings.



Electrical Outlet Box openings can be made easily by cutting the Durasan as shown by the solid lines in the picture above. Strike a sharp hammer blow to the "X". Cut away back paper.

FORMING A NARROW PLANK WITH TWO FINISHED EDGES



1. Cut Decorative Surface with a sharp knife to a dimension of 1" wider than the panel width desired. Then turn vinyl surface face down.



2. Score Back Surface with knife to the desired panel width. Snap gypsum core and peel this 1" piece from decorative surface. Smooth core if uneven.



3. Wrap the excess flap of vinyl over the exposed gypsum core and staple to back.

Four Options of Installation

OPTION 1

NAILING RECOMMENDATIONS

A plastic-headed or padded hammer is used when driving the nails to avoid chipping the surface of the color pin head.

Durasan panels are easy to nail. Panels are normally applied vertically to the framing with 1-3/8" matching colored nails (Color Pins) driven into the studs every 12" and spaced not less than 3/8" from panel edges.

When you plan to nail Durasan panels in place, one of the three following wood framing methods is recommended. Select the one that best suits your needs.

1. New Wall Construction. In new construction, wood studs shall be spaced exactly 16" or 24" o.c. See drawing below. Consider suggestions under "Panel Layout" before positioning studs. Make sure studs are dry, straight and flush with top and bottom plates. Shim out or plane off the studs, if necessary, to make them flush and in alignment. With studs spaced on 16" centers, one 48" wide panel will cover three stud spaces.

APPLICATION – NAILING

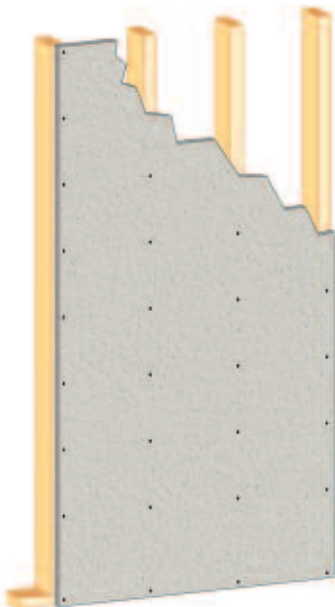

Metal or wood studs must be dry, straight and spaced exactly 16" or 24" o.c.

2. Modifying Existing Framing.

If you wish to apply Durasan to areas where studs are already in place but are warped, unevenly spaced, or poorly aligned, employ 1" x 3" wood furring strips horizontally nailed on 16" centers over the existing framework. Shim out strips where necessary to form a solid, even nailing surface for panels.

3. Over Masonry of Broken Plaster Surfaces. When applying over brick, block or cement surfaces. 2" x 2" wood furring strips are required. 1" x 3" furring strips may be used on old plaster surfaces. Furring strips should be anchored to the masonry walls using concrete stub nails or any one of several masonry fasteners on the market. These furring strips may be applied to the wall 16" o.c. horizontally, which is easier and preferred, or vertically, with additional horizontal strips at the ceiling and floor lines.

If masonry walls are extremely rough or out of plumb, it is recommended that conventional framing be erected several inches away from, and parallel to, the existing wall.

OPTION 2

ADHESIVE RECOMMENDATIONS

Durasan panels are quality wall paneling products that can be applied to wood studs, provided an appropriate drywall adhesive meeting ASTM C 557 is applied to the studs. Durasan panels can be adhesively applied to steel studs, provided an appropriate adhesive recommended for use with vinyl faced gypsum board and steel studs is used. Consult adhesive manufacturer for a suitable adhesive product. Steps for this application, which are limited to walls only, are as follows:

1. Durasan panels are applied vertically to steel or wood studs or to furring strips that are straight, on one plane, and located 16" or 24" o.c.

2. All panels must be "bowed," or pre-curved the length of the board, so that when

applied to the adhesive coated studs, a natural pressure will result at the center of the panel when nailed or screwed top and bottom. (See "Bowing the Board" on page 9.)

3. Each stud that has two panels meeting to form a joint should have two beads of adhesive, each one located as close to each edge of the stud as possible. This reduces the possibility of adhesive oozing through the joint and getting on the prefinished surface. All other studs must receive a single bead of adhesive. Apply panels within 15 minutes of adhesive application.

4. When using adhesive, nail or screw the panel at the floor and ceiling line, spacing fasteners 6" to 8" apart.

5. If cove moulding or baseboards are to be omitted, you may wish to attach each panel at top and bottom with 1-3/8" matching Color Pins in place of 1-1/4" wallboard nails when using wood studs.

6. Immediately remove any adhesive that may have been deposited on tools or the prefinished surface.

APPLICATION – ADHESIVE



Nailing or screwing is required only at top and bottom of prefinished gypsum panels when adhesive is applied and panels are prebowed to give pressure at the center of the board.

OPTION 3

LAMINATING RECOMMENDATIONS

1. Apply to clean, dry, sound surfaces only. Remove all wallpaper, high points, calcimine, loose paint, and scratch any other paint for good bond. Test any painted surface by laminating a small sample. Allow to dry and check bond.

2. Bow the Durasan panels (see Bowing the Board) so that each panel, when nailed at top and bottom, will have built-in pressure being exerted at the center of the board on the existing wall until the adhesive dries.

3. Apply the drywall adhesive with a caulking gun to the back surface of each panel, using 3/8" diameter beads 16" apart. Apply beads parallel to and 3/4" to 1" from each long edge of the panel.

4. Laminate with Joint Compound. Durasan panels can be laminated to existing surfaces with Sta-Smooth or Ready Mix Joint Compounds. Joint compound is applied as nominal 5" ribbons or four 1/4" x 1/4" beads located around the perimeter and center of the panels. (approximate coverage for Ready Mix is 9–10 gal./1000 sq. ft. and Sta-Smooth is 50–60 lbs./1000 sq.ft.) An alternative is 2" diameter daubs 1/2" thick, 16" o.c. (approximate coverage for Ready Mix is 5-1/2–6 gal./1000 sq.ft. and Sta-Smooth is 30–35 lbs./1000 sq.ft.).

5. Nail or screw panels at top first. Locate 6d nails or 1-7/8" drywall screws 6" to 8" apart. Press panels progressively from ceiling to floor line. Nail at floor line if necessary. If panels do not stay in proper alignment, add temporary bracing for 24 hours. Use suitable moulding at floor and ceiling line to cover exposed fasteners.

BOWING THE BOARD
(Required in Methods #2 and #3)

Durasan panels must be warped or bowed to give pressure at the center of the board during adhesive and cementing applications. If the boards were not bowed, temporary bracing would be required. Illustrated are two methods of bowing. Be sure to remove bundling tape from the boards. Cut to proper ceiling height, and stack as shown with all prefinished surfaces facing up or down depending on which method of bowing is used. Use padded blocks cut from 2 x 4's to protect prefinished surfaces. Stack in such a manner that, when applying, each panel would have a tendency to spring away at the top when nailed at the bottom. Proper bowing can take from one to several days depending on weather conditions.

BOWING METHOD #1

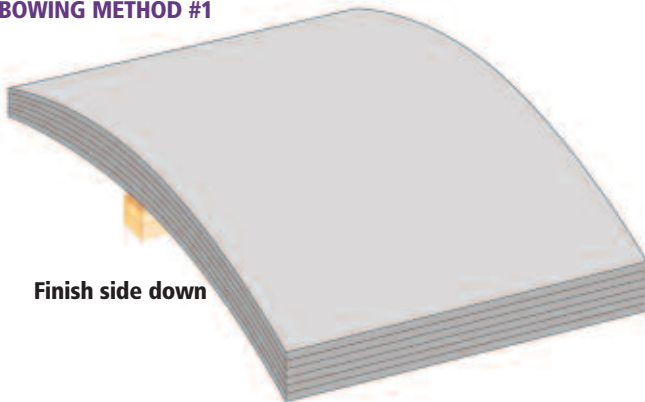

Finish side down

BOWING METHOD #2

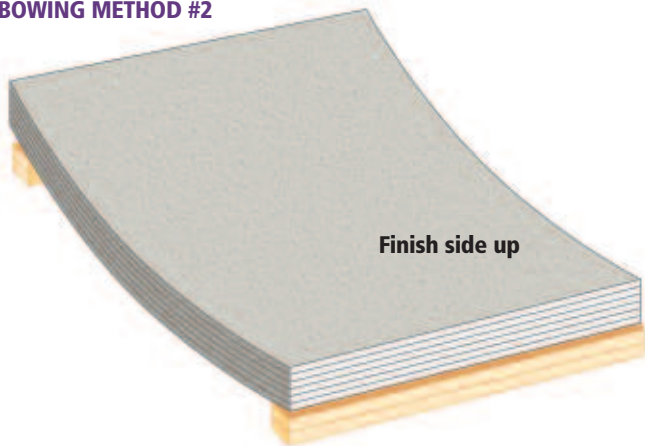

Finish side up

OPTION 4
EDGE GRIP CLIP
RECOMMENDATIONS

Edge Grip Clips are the key to a simple concept for installing gypsum board – plain or predecorated. It's called the Edge Grip Clip System. It provides mechanical attachment of the board over steel framing, wood framing, over steel or wood furring on concrete block, or any other sound and level wall surface. The clip is positioned on the back of the board and tapped in place, using the installation tool, so the prongs are driven into the board edges. The leading edge of each clip along one edge of the board is screw or nail attached to the studs, furring or other wall surface. The clips on succeeding panels slip under the previously applied panel causing the clips to

disappear behind the panels. Top and bottom edges must be fastened to the framing, furring, or wall. The Edge Grip Clips hold the board firmly in place. When using 4'-wide panel, use adhesive along intermediate studs.

In a battenless system, Durasan panels must be absolutely flat to prevent lipping. Prebowing overnight with the vinyl surface concave is recommended.

Steel Framing

Align floor and ceiling tracks or plates to ensure plumb partition, and secure with suitable fasteners 24" o.c. max. Position studs or furring 24" o.c. max. (30" o.c. for 30" panels). Secure steel studs located adjacent to door and window frames, intersections and corners with 3/8" Type S Pan Head or low-profile head screws. Application over steel furring requires that the channels have a flat surface in contact with the board (Screw Furring Channel has beaded edges).

APPLICATION OF DURASAN

Apply the 1/2" or 5/8" Durasan vertically. Start at the end of a wall or partition intersection and cut the first panel if necessary so that its leading, uncut edge (the direction in which work will progress) falls at the center of a framing member.

CLIP INSTALLATION INSTRUCTIONS

Edge Grip Clips should be installed into the edge of the Durasan with the wooden tool included in each box of clips.

EDGE GRIP CLIP
INSTALLATION TOOL

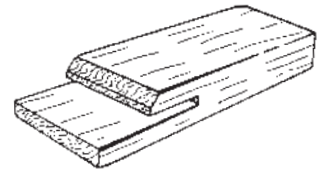

1. Place the clip into the slot of the tool, as shown on the drawing, making sure the back edges of the teeth are against the wood.

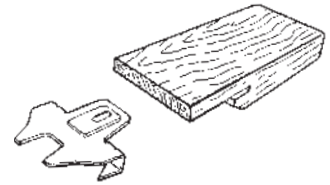

2. Position the clip and tool, as shown, against the back surface of the Durasan so that the clip is flat to the back, and perpendicular to the edge of the Durasan.

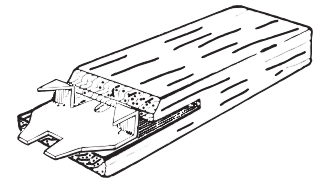

3. Using a hammer, tap the end of the installation tool until both teeth of the clip are fully inserted and the back legs are tight against the edge. Do not over drive the clips, as this can cause deformation of the board edge.

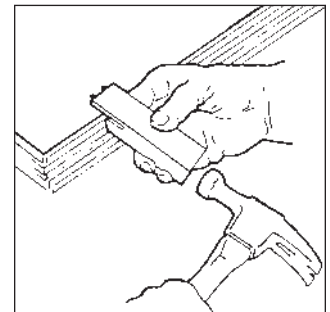

Apply clips to the leading edge of the panel 16" o.c., starting 16" down from the top. Clips on the trailing edge of the next panel are also spaced 16" o.c. but are about 2" from those on the first panel's leading edge. If greater rigidity is desired, clip spacing may be reduced. All panels require clips along both edges except when panels abut doors, windows, intersections or corners, in which case one edge of the panel will be directly fastened with nails or screws.

Position the first panel, aligning the uncut edge at the center of the framing member, plumb, and attach it top and bottom as well as directly to the starting stud. Attach top and bottom with fastener 1" from each panel edge and 12" o.c. between. Fasten clips to steel studs with screws provided, wood studs with 1" nails or 1-1/4" Type W screws through the hole in the clip. Do not fasten clips before securing top and bottom of this first panel.

On all intermediate framing, apply 1/4" diameter beads of drywall adhesive. In fixed wood or furred wall construction, adhesive must be applied progressively with Durasan application. In a steel stud system, adhesive need not be applied until the opposite face of the partition is finished. Intermediate studs are rotated back into position. This procedure allows the intermediate studs, which are joint studs on the opposite face, to be adjusted as necessary when second side panels are erected.

Apply base trim at bottom of partition; install snap-on accessories at inside corners, outside corners, and wall-ceiling juncture if desired.

Note: Substrate must be straight and true. Durasan must be flat or prebowed.

EDGE GRIP CLIP SYSTEM

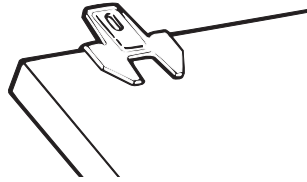

1. Edge Grip Clips are driven along both edges of the Durasan panels with attention not to over drive or allow points to move up towards vinyl surface.

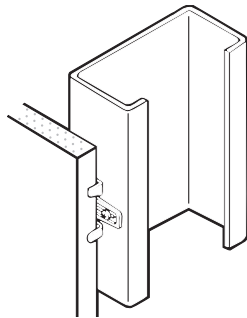

2. With edge of panel centered on stud face, clip is secured with standard Type S Pan Head Screws.

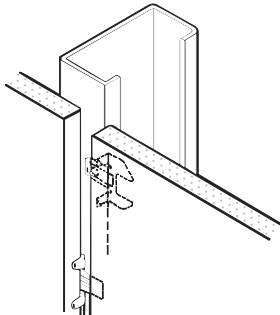

3. Clips on adjoining panel slide behind the first panel without screws.

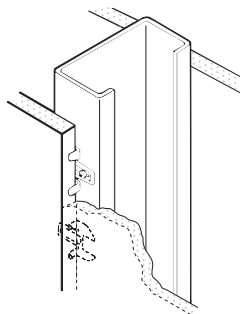

4. Edges butt snugly for fine line joint.

EDGE GRIP CLIP APPLICATION METHODS

1. Wood Stud

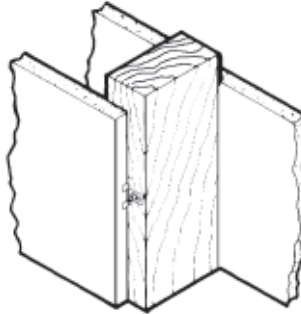

2. Wood Furring

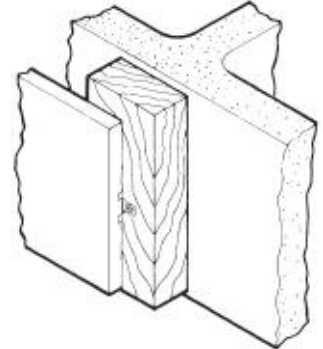

3. Z Furring Channel

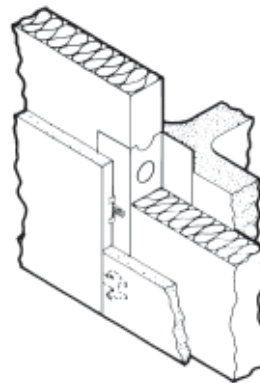

4. Double Layer

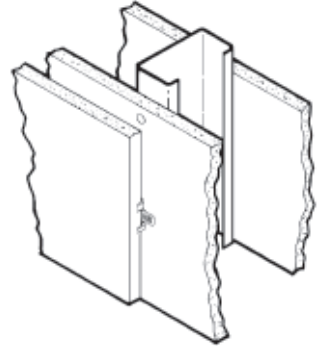

SNAP-ON TRIM

1. Apply Durasan and base trim in normal manner before installing outside corner trim, then proceeding with any interior ceiling and corner trim.

2. Cut steel retainers to fit outside corners, interior ceiling and corner trim.

3. Nail or screw attach retainer strip. Space fasteners 8" o.c. for interior ceiling and corner retainers,

and 12" o.c. for outside corner retainers. All retainers should begin fasteners 1/2" from each end.

4. Cut face cover to length with tin snip or miter cut. After cutting cover, restore flanges to original configuration by using a screwdriver blade as a wedge. Snap cover over retainer by engaging one leg on retainer flange. Then use palm or thumb pressure until opposite leg engages retainer flange and snaps into place.

SNAP-ON TRIM APPLICATION METHODS

Exterior Corner

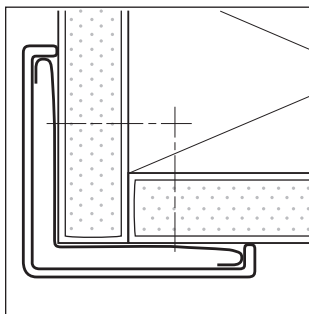

Interior Corner

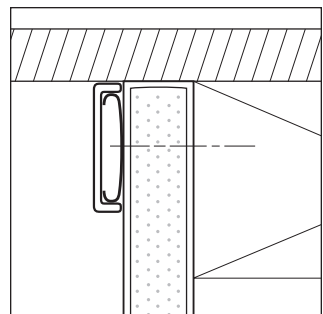

Specifications

Section 09 72 00 Prefinished Gypsum Wall Panels

This section is written in CSI 3-part format and it assumes that the general conditions of the contract will be AIA A201. This section is proprietary and includes only National Gypsum products.

PART 1 GENERAL

1.01 Summary

- A. Section Includes: Factory finished gypsum board with trim system for joints.

1.02 System Description

- A. Performance Requirements: Provide UL listed materials with fire hazard classification of surface covering, as determined by ASTM E 84, as follows:

1. Flame spread not more than 25 (Vinyl Durasan).
2. Smoke developed of not more than 50 (Vinyl Durasan).

1.03 Submittals

- A. Product Data: Manufacturer's specifications and installation instructions for each product specified.
- B. Samples: Minimum 2"x5" samples of manufacturer's full range of patterns and colors for each panel covering material specified.

PART 2 PRODUCTS

2.01 Manufacturer

- A. National Gypsum Company.

2.02 Materials

- A. Gypsum Board:
 1. National Gypsum Durasan Prefinished Regular Gypsum Board.
 2. National Gypsum Durasan Prefinished Fire-Shield Gypsum Board.

- B. Panel Covering:

1. National Gypsum Vinyl Durasan.

2.03 Accessories

- A. Trim: Durasan Matching Trim, Snap-On.
- B. Trim: Durasan Matching Trim, One Piece.
- C. Fasteners, Adhesives, and Joint Compounds:
 1. Edge Grip Clips.
 2. Screws: ASTM C 954 or ASTM C 1002 or both with threads, points, and finish as recommended by the manufacturer.
 3. National Gypsum ProForm® BRAND All Purpose Ready Mix Joint Compound.
 4. National Gypsum ProForm® BRAND Multi-Use Joint Compound.
 5. National Gypsum Easy Finish® BRAND Ready Mix Joint Compound.
 6. National Gypsum ProForm® BRAND Sta-Smooth Setting Compound.
 7. Color Pins.

PART 3 EXECUTION

3.01 Installation

- A. In accordance with the manufacturer's recommendations as follows:
 1. National Gypsum's "Gypsum Construction Guide."

3.02 Protection

- A. Protect prefinished gypsum wall panel installations from damage and deterioration until the date of Substantial Completion.



CUSTOMER SERVICE SALES AREAS

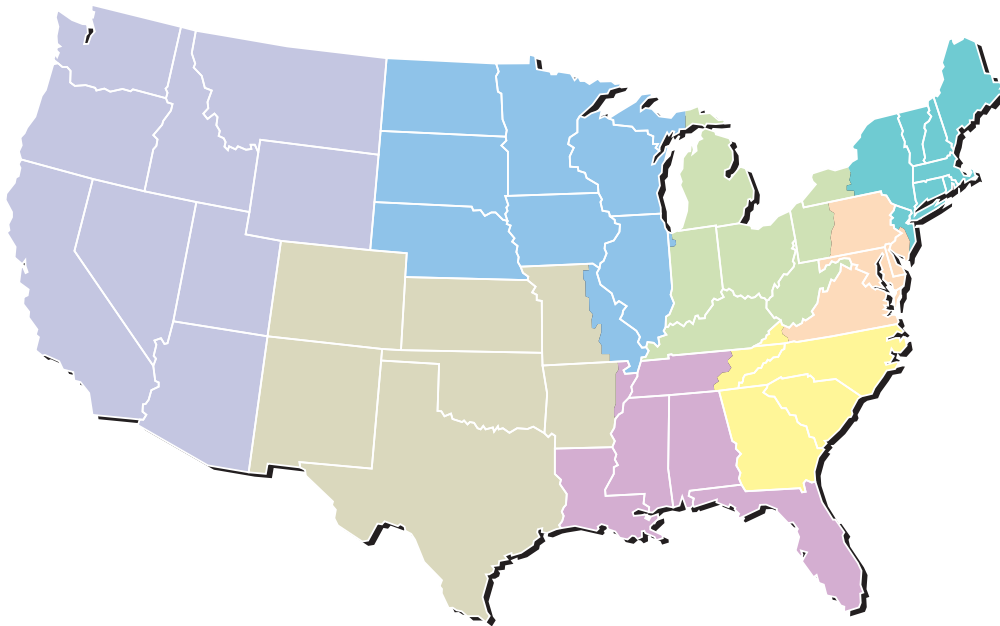

Atlantic Area

Phone: (800) 237-9167
Fax: (877) 252-0430

Central Area

Phone: (800) 252-1065
Fax: (866) 232-0440

Gulf Area

Phone: (800) 343-4893
Fax: (866) 482-8940

Midwest Area

Phone: (800) 323-1447
Fax: (866) 692-8590

Northeast Area

Phone: (800) 253-3161
Fax: (866) 632-1480

Southeast Area

Phone: (800) 548-9394
Fax: (866) 732-1990

Southwest Area

Phone: (800) 548-9396
Fax: (866) 792-7520

Western Area

Phone: (800) 824-4227
Fax: (800) 438-6266

National Accounts

Phone: (800) 440-1230
Fax: (866) 622-3590

Manufactured Housing

Phone: (800) 455-3185
Fax: (800) 639-1714

LIMITED WARRANTY AND REMEDIES

Products manufactured and sold by National Gypsum are warranted by National Gypsum to its customers to be free from defects in materials and workmanship at the time of shipment. **THIS EXPRESS WARRANTY IS THE ONLY WARRANTY APPLICABLE TO SUCH PRODUCTS, AND IS IN LIEU OF AND EXCLUDES ALL OTHER EXPRESS ORAL OR WRITTEN WARRANTIES AND ALL IMPLIED WARRANTIES, INCLUDING BUT NOT LIMITED TO THE IMPLIED WARRANTIES OF MERCHANTABILITY AND FITNESS FOR A PARTICULAR PURPOSE.**

National Gypsum will not be liable for any incidental, indirect or consequential losses, damages or expenses. The customer's exclusive remedy for any type of claim or action for defective products will be limited to the replacement of the products (in the form originally shipped) or, at National Gypsum's option, to a payment or credit not greater than the original purchase price of the products.

National Gypsum will not be liable for products claimed to be defective where the defect resulted from causes not within National Gypsum's control, or which arose or occurred after shipment, including but not limited to accidents, misuse, mishandling, improper installation, contamination or adulteration by other materials or goods, or abnormal conditions of temperature, moisture, dirt or corrosive matter.

Any claim that products sold by National Gypsum were defective or otherwise did not conform to the contract of sale is waived unless the customer submits it in writing to National Gypsum within thirty (30) days from the date the customer discovered or should have discovered the defect or nonconformance. No legal action or proceeding complaining of goods sold by National Gypsum may be brought by the customer more than one year after the date the customer discovered or should have discovered the defect or problem of which it complains.

Corporate Headquarters

National Gypsum Company
2001 Rexford Road
Charlotte, NC 28211
Phone: (704) 365-7300
Web: nationalgypsum.com
nationalgypsum.com/espanol

Technical Information

Phone: (800) NATIONAL
(800) 628-4662
Fax: (800) FAX-NGC1
(800) 329-6421

National 
Gypsum®

Excellence Across The Board®