

Brief introduction to tropical geometry

Erwan Brugallé, Ilia Itenberg, Grigory Mikhalkin, and Kristin Shaw

ABSTRACT. The paper consists of lecture notes for a mini-course given by the authors at the Gökova Geometry & Topology conference in May 2014. We start the exposition with tropical curves in the plane and their applications to problems in classical enumerative geometry, and continue with a look at more general tropical varieties and their homology theories.

CONTENTS

1. Tropical algebra	3
1.1. Tropical semi-field	3
1.2. Maslov Dequantization	3
1.3. Tropical polynomials	4
1.4. Relation to classical algebra	5
2. Tropical curves in \mathbb{R}^2	6
2.1. Definition	6
2.2. Dual subdivision	7
2.3. Balanced graphs and tropical curves	8
2.4. Tropical curves as limits of amoebas	9
3. Patchworking	13
3.1. Patchworking of a line	14
3.2. Patchworking of non-singular tropical curves	14
3.3. Haas Theorem	21
4. Applications in enumerative geometry	22
4.1. Complex and real enumerative problems	22
4.2. Enumeration of tropical curves	26
4.3. Quantum enumeration of tropical curves	28
4.4. Floor diagrams	30

2000 *Mathematics Subject Classification.* Primary 14T05; Secondary 14P25, 14N10, 14N35.

Key words and phrases. Tropical varieties, patchworking, tropical homology.

Research is supported in part by the FRG Collaborative Research grant DMS-1265228 of the U.S. National Science Foundation (I.I.); the project TROPGEO of the European Research Council, the grants 140666 and 141329 of the Swiss National Science Foundation, the National Center of Competence in Research SwissMAP of the Swiss National Science Foundation (G.M.); and an Alexander von Humboldt Foundation Postdoctoral Research Fellowship (K.S.).

5.	Tropical subvarieties of \mathbb{R}^n and \mathbb{T}^n	35
5.1.	Tropical hypersurfaces of \mathbb{R}^n	35
5.2.	Tropical subvarieties of \mathbb{R}^n	38
5.3.	Tropical limits of algebraic varieties	39
5.4.	Linear spaces and hyperplane arrangements	41
5.5.	Tropical subvarieties of \mathbb{T}^n	44
5.6.	Tropical modifications	45
6.	Tropical curves in tropical surfaces	51
6.1.	Approximation of pairs	51
6.2.	Intersection of fan tropical curves in fan tropical planes	52
6.3.	From local to global	55
7.	Tropical manifolds and their homology groups	57
7.1.	Abstract tropical manifolds	57
7.2.	Abstract tropical curves	58
7.3.	Tropical toric varieties	60
7.4.	Tropical homology	61
7.5.	Some examples of homology computations	65
7.6.	Straight cycles	67
7.7.	Tropical cohomology	67
7.8.	Cohomology of tropical curves	69
	References	72

The goal of these lectures is to give a basic introduction to tropical geometry focusing on some of its particularly simple and visual aspects. The first section is devoted to tropical arithmetic and its relations to classical arithmetic. The second section reviews tropical curves in \mathbb{R}^2 . The content of these two sections is quite standard, and we refer to [Bru09, Bru12, BS14a] for their extended versions. Section 3 contains a tropical version of the combinatorial patchworking construction for plane curves, as well as a tropical reformulation of Haas’ theorem. Section 4 presents some enumerative applications of tropical geometry, as well as the floor diagram technique. Section 5 looks at general tropical subvarieties of \mathbb{R}^n and their approximation by complex algebraic varieties. Section 6 is devoted to a basic study of tropical curves inside non-singular affine tropical surfaces. Finally, in Section 7 we define abstract tropical manifolds and review their homology theories.

For other introductions to tropical geometry one can look, for example, at [BPS08, RGST05, IM12, Vir08, Vir11, Gat06, MS15] and references therein. A more advanced reader may refer to [Mik06, Mik04a, IMS07].

Acknowledgements: The authors are grateful to Matteo Ruggiero for providing helpful comments on a preliminary version of these notes.

1. Tropical algebra

1.1. Tropical semi-field

The set of *tropical numbers* is defined as $\mathbb{T} = \mathbb{R} \cup \{-\infty\}$. We endow \mathbb{T} with the following operations, called *tropical addition* and *multiplication*:

$$"x + y" = \max\{x, y\} \quad "x \times y" = x + y$$

with the usual conventions:

$$\forall x \in \mathbb{T}, \quad "x + (-\infty)" = \max(x, -\infty) = x \quad \text{and} \quad "x \times (-\infty)" = x + (-\infty) = -\infty.$$

In the entire text, tropical operations will be placed under quotation marks. Just as in classical algebra we often abbreviate " $x \times y$ " to " xy ". The tropical numbers along with these two operations form a semi-field, *i.e.*, they satisfy all the axioms of a field except the existence of an inverse for the law "+".

To familiarize ourselves with these two operations, let us do some simple calculations:

$$\begin{aligned} "1 + 1" &= 1, \quad "1 + 2" = 2, \quad "1 + 2 + 3" = 3, \quad "1 \times 2" = 3, \quad "1 \times (2 + (-1))" = 3, \\ "1 \times (-2)" &= -1, \quad "(5 + 3)^2" = 10, \quad "(x + y)^n" = "x^n + y^n". \end{aligned}$$

Be careful when writing tropical formulas! As, " $2x$ " \neq " $x+x$ " but " $2x$ " = $x+2$, similarly " $1x$ " \neq x but " $1x$ " = $x+1$, and again " $0x$ " = x and " $(-1)x$ " = $x-1$.

A very important feature of the tropical semi-field is that it is *idempotent*, which means that " $x + x$ " = x for all x in \mathbb{T} . This implies, in particular, that one cannot solve the problem of non-existence of tropical subtraction by adding more elements to \mathbb{T} (see Exercise 1(1)).

1.2. Maslov Dequantization

Let us explain how the tropical semi-field arises naturally as the limit of some classical semi-fields. This procedure, studied by V. Maslov and his collaborators, is known as *dequantization of positive real numbers*.

The non-negative real numbers form a semi-field $\mathbb{R}_{\geq 0}$ under the usual addition and multiplication. If t is a real number greater than 1, then the logarithm of base t provides a bijection between the sets $\mathbb{R}_{\geq 0}$ and \mathbb{T} . This bijection induces a semi-field structure on \mathbb{T} with the operations denoted by " $+_t$ " and " \times_t ":

$$"x +_t y" = \log_t(t^x + t^y) \quad \text{and} \quad "x \times_t y" = \log_t(t^x t^y) = x + y.$$

The equation on the right-hand side already shows classical addition arising from the multiplication on $(\mathbb{R}_{\geq 0}, +, \times)$. Notice that by construction, all semi-fields $(\mathbb{T}, "+_t", "\times_t")$ are isomorphic to $(\mathbb{R}_{\geq 0}, +, \times)$. The inequalities $\max(x, y) \leq x + y \leq 2 \max(x, y)$ on $\mathbb{R}_{\geq 0}$ together with the fact that the logarithm of base $t > 1$ is an increasing function gives us the following bounds for " $+_t$ ":

$$\forall t > 1, \quad \max(x, y) \leq "x +_t y" \leq \max(x, y) + \log_t 2.$$

If we let t tend to infinity, $\log_t 2$ tends to 0, and the operation “ $+_t$ ” therefore tends to the tropical addition “ $+$ ”! Hence the tropical semi-field comes naturally from degenerating the classical semi-field $(\mathbb{R}_{\geq 0}, +, \times)$. From an alternative perspective, we can view the classical semi-field $(\mathbb{R}_{\geq 0}, +, \times)$ as a deformation of the tropical semi-field. This explains the use of the term *dequantization*.

1.3. Tropical polynomials

As in classical algebra, a tropical polynomial expression $P(x) = “\sum_{i=0}^d a_i x^i”$ induces a tropical polynomial function, still denoted by P , on \mathbb{T} :

$$\begin{aligned} P: \mathbb{T} &\longrightarrow \mathbb{T} \\ x &\longmapsto “\sum_{i=0}^d a_i x^i” = \max_{i=1}^d (a_i + ix) \end{aligned}$$

Note that the map which associates a tropical polynomial function to a tropical polynomial is surjective, by definition, but is *not* injective. In the whole text, tropical polynomials have to be understood as *tropical polynomial functions*.

Let us look at some examples of tropical polynomials:

$$\begin{aligned} “x” = x, \quad “1+x” = \max(1, x), \quad “1+x+3x^2” = \max(1, x, 2x+3), \\ “1+x+3x^2+(-2)x^3” = \max(1, x, 2x+3, 3x-2). \end{aligned}$$

Now define the roots of a tropical polynomial. For this, let us take a geometric point of view of the problem. A tropical polynomial is a convex piecewise affine function and each piece has an integer slope (see Figure 1). We call *tropical roots* of the polynomial $P(x)$ all points x_0 of \mathbb{T} for which the graph of $P(x)$ has a corner at x_0 . Notice, this is equivalent to $P(x_0)$ being equal to the value of at least two of its monomials evaluated at x_0 . Moreover, the difference in the slopes of the two pieces adjacent to a corner gives the *order* of the corresponding root.

Definition 1.1. The roots of a tropical polynomial $P(x) = “\sum_{i=0}^d a_i x^i”$ are the tropical numbers x_0 for which either $P(x_0) = -\infty$, or there exists a pair $i \neq j$ such that $P(x_0) = “a_i x_0^i” = “a_j x_0^j”$.

The order of a root x_0 is the maximum of $|i-j|$ for all possible such pairs i, j if $x_0 \neq -\infty$, and is the minimal i such that $a_i \neq -\infty$ if $x_0 = -\infty$.

Thus, the polynomial “ $0+x$ ” has a simple root at $x_0 = 0$, the polynomial “ $0+x+(-1)x^2$ ” has simple roots 0 and 1, and the polynomial “ $0+x^2$ ” has a double root at 0.

Proposition 1.2. The tropical semi-field is algebraically closed. In other words, every tropical polynomial of degree $d > 0$ has exactly d roots when counted with multiplicities.

Example 1.3. We have the following factorizations:

$$“0+x+(-1)x^2” = “(-1)(x+0)(x+1)” \quad \text{and} \quad “0+x^2” = “(x+0)^2”.$$

Once again the equalities hold in terms of polynomial functions and not on the level of the polynomial expressions. For example, “ $0+x^2$ ” and “ $(0+x)^2$ ” are equal as polynomial functions but not as polynomials.

Brief introduction to tropical geometry

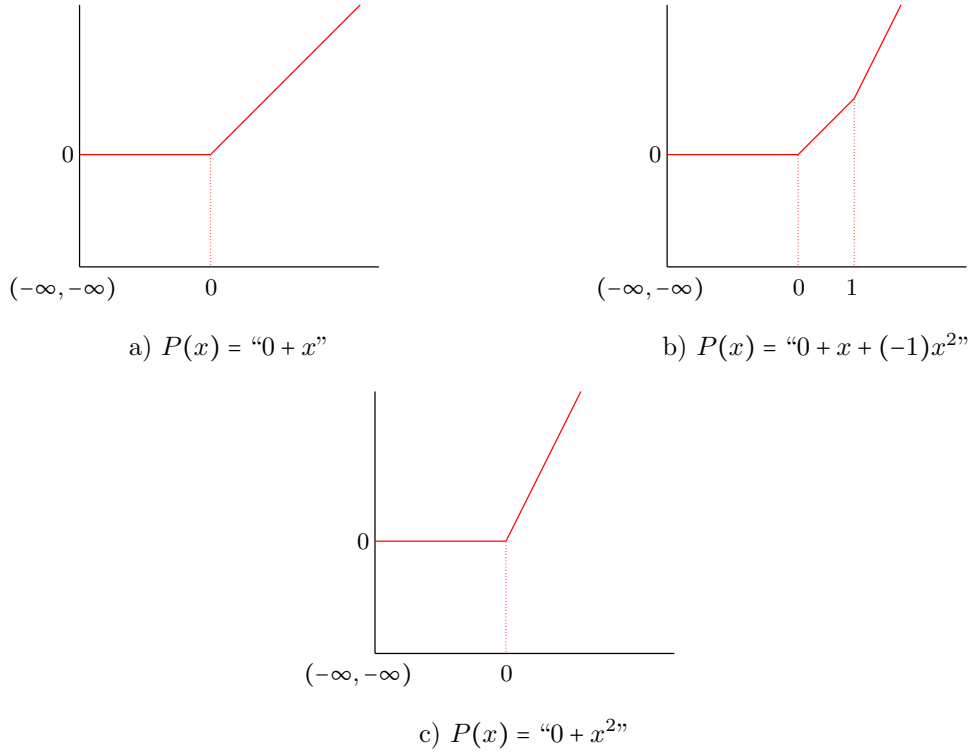

FIGURE 1. The graphs of some tropical polynomials

1.4. Relation to classical algebra

Let $P_t(z) = \sum \alpha_i(t)z^i$ be a family of complex polynomials parameterized by t which we assume to be a sufficiently large positive number. We make the assumption that

$$\forall i, \exists a_i \in \mathbb{T}, \exists \beta_i \in \mathbb{C}, \alpha_i(t) \sim_{t \rightarrow +\infty} \beta_i t^{a_i}.$$

Then, we define the tropical polynomial, called the *tropical limit* of the family P_t , by

$$P_{trop}(x) = " \sum a_i x^{i} ".$$

We also define the map

$$\begin{aligned} \text{Log}_t : \mathbb{C} &\longrightarrow \mathbb{T} \\ z &\longmapsto \log_t(|z|) \end{aligned}$$

The following theorem can be seen as a dual version of Newton-Puiseux method.

Theorem 1.4. *One has*

$$\text{Log}_t(\{\text{roots of } P_t\}) \xrightarrow[t \rightarrow +\infty]{} \{\text{roots of } P_{trop}\}.$$

Moreover, the order of any tropical root x_0 of P_{trop} is exactly the number of roots of P_t whose logarithms converge to x_0 .

- Exercises 1.** (1) Why does the idempotent property of tropical addition prevent the existence of additive inverses?
- (2) Draw the graphs of the tropical polynomials $P(x) = "x^3 + 2x^2 + 3x + (-1)"$ and $Q(x) = "x^3 + (-2)x^2 + 2x + (-1)"$, and determine their tropical roots.
- (3) Prove that the only root of the tropical polynomial $P(x) = "x"$ is $-\infty$.
- (4) Prove that x_0 is a root of order k of a tropical polynomial $P(x)$ if and only if there exists a tropical polynomial $Q(x)$ such that $P(x) = "(x + x_0)^k Q(x)"$ and x_0 is not a root of $Q(x)$. (Note that a factor $x - x_0$ in classical algebra gets transformed to the factor $"x + x_0"$, since the root of the polynomial $"x + x_0"$ is x_0 and not $-x_0$.)
- (5) Prove Proposition 1.2.
- (6) Let $a \in \mathbb{R}$ and $b, c, d \in \mathbb{T}$. Determine the roots of the polynomials $"ax^2 + bx + c"$ and $"ax^3 + bx^3 + cx + d"$.

2. Tropical curves in \mathbb{R}^2

Let us now extend the preceding notions to the case of tropical polynomials in two variables. Since this makes all definitions, statements and drawings simpler, we restrict ourselves to tropical curves in \mathbb{R}^2 instead of \mathbb{T}^2 .

2.1. Definition

A tropical polynomial in two variables is

$$P(x, y) = " \sum_{(i,j) \in A} a_{i,j} x^i y^j " = \max_{(i,j) \in A} (a_{i,j} + ix + jy),$$

where A is a finite subset of $(\mathbb{Z}_{\geq 0})^2$. Thus, a tropical polynomial is a convex piecewise affine function, and we denote by $\tilde{V}(P)$ the corner locus of this function. That is to say,

$$\tilde{V}(P) = \{(x_0, y_0) \in \mathbb{R}^2 \mid \exists (i, j) \neq (k, l), P(x_0, y_0) = "a_{i,j} x_0^i y_0^j" = "a_{k,l} x_0^k y_0^l" \}.$$

Example 2.1. Let us look at the tropical line defined by the polynomial $P(x, y) = "x + y + 0"$. We must find the points (x_0, y_0) in \mathbb{R}^2 that satisfy one of the following three conditions:

$$x_0 = 0 \geq y_0, \quad y_0 = 0 \geq x_0, \quad x_0 = y_0 \geq 0$$

We see that the set $\tilde{V}(P)$ is made of three standard half-lines (see Figure 2a):

$$\{(0, y) \in \mathbb{R}^2 \mid y \leq 0\}, \{(x, 0) \in \mathbb{R}^2 \mid x \leq 0\}, \text{ and } \{(x, x) \in \mathbb{R}^2 \mid x \geq 0\}.$$

The set $\tilde{V}(P)$ is a piecewise linear graph in \mathbb{R}^2 : it is a finite union of possibly infinite straight edges in \mathbb{R}^2 . As in the case of polynomials in one variable, we take into account the difference in the slopes of $P(x, y)$ on the two sides of an edge.

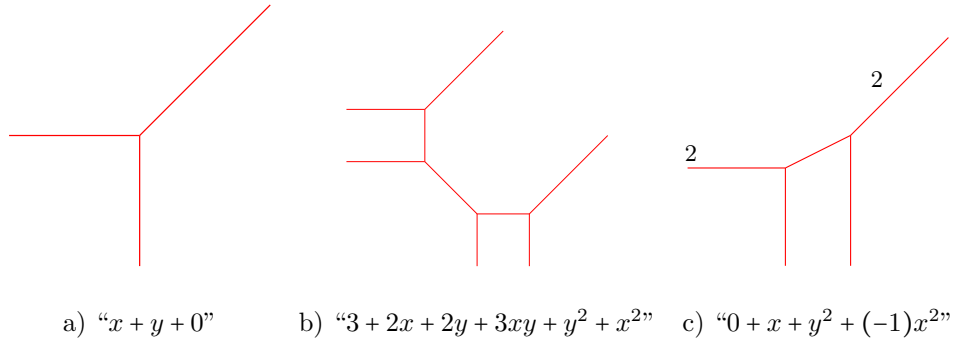

FIGURE 2. A tropical line and two tropical conics.

Definition 2.2. The weight of an edge of $\tilde{V}(P)$ is defined as the maximum of the greatest common divisor (gcd) of the numbers $|i - k|$ and $|j - l|$ for all pairs (i, j) and (k, l) such that the value of $P(x, y)$ on this edge is given by the corresponding monomials.

The tropical curve defined by $P(x, y)$ is the graph $\tilde{V}(P)$ equipped with this weight function on the edges.

Example 2.3. Figures 2a,b,c depict tropical curves in \mathbb{R}^2 . The weight of an edge is assumed to be 1, unless indicated otherwise. For example, in the case of the tropical line, all edges are of weight 1.

2.2. Dual subdivision

A polynomial $P(x, y)$ over any field or semi-field always comes with a Newton polygon. Let $P(x, y) = \sum_{i,j} a_{i,j} x^i y^j$ be a tropical polynomial. The *Newton polygon* of $P(x, y)$, denoted by $\Delta(P)$, is defined by

$$\Delta(P) = \text{Conv}\{(i, j) \in (\mathbb{Z}_{\geq 0})^2 \mid a_{i,j} \neq -\infty\} \subset \mathbb{R}^2.$$

In classical algebra, one just replaces $-\infty$ by 0 in the definition of $\Delta(P)$.

A tropical polynomial also determines a subdivision of $\Delta(P)$, called its *dual subdivision*. Given $(x_0, y_0) \in \mathbb{R}^2$, let

$$\Delta_{(x_0, y_0)} = \text{Conv}\{(i, j) \in (\mathbb{Z}_{\geq 0})^2 \mid P(x_0, y_0) = a_{i,j} x_0^i y_0^j\} \subset \Delta(P).$$

The tropical curve C defined by $P(x, y)$ induces a polyhedral decomposition of \mathbb{R}^2 , and the polygon $\Delta_{(x_0, y_0)}$ only depends on the cell $F \ni (x_0, y_0)$ of the decomposition given by C . Thus, we define $\Delta_F = \Delta_{(x_0, y_0)}$ for $(x_0, y_0) \in F$.

Example 2.4. Let us go back to the tropical line L defined by the polynomial $P(x, y) = x + y + 0$ (see Figure 2a). On the 2-cell $F_1 = \{\max(x, y) < 0\}$, the value of $P(x, y)$ is given by the monomial 0, and so $\Delta_{F_1} = \{(0, 0)\}$. Similarly, we have $\Delta_{F_2} = \{(1, 0)\}$ and $\Delta_{F_3} = \{(0, 1)\}$ for the cells $F_2 = \{x > \max(y, 0)\}$ and $F_3 = \{y > \max(x, 0)\}$.

Along the horizontal edge e_1 of L the value of $P(x, y)$ is given by the monomials 0 and y , and so Δ_{e_1} is the the vertical edge of $\Delta(P)$. In the same way, Δ_{e_2} is the the horizontal edge of $\Delta(P)$ for the vertical edge e_2 of L , and Δ_{e_3} is the the edge of $\Delta(P)$ with endpoints $(1, 0)$ and $(0, 1)$ for the diagonal edge e_3 of L .

The point $(0, 0)$ is the vertex v of the line C . This is where the three monomials 0 , x and y take the same value, and so $\Delta_v = \Delta(P)$, (see Figure 3a).

All polyhedra Δ_F form a subdivision of the Newton polygon $\Delta(P)$. This subdivision is dual to the tropical curve defined by $P(x, y)$ in the following sense.

Proposition 2.5. *One has*

- $\Delta(P) = \bigcup_F \Delta_F$, where the union is taken over all cells F of the polyhedral subdivision of \mathbb{R}^2 induced by the tropical curve defined by $P(x, y)$;
- $\dim F = \text{codim } \Delta_F$;
- Δ_F and F are orthogonal;
- $\Delta_F \subset \Delta_{F'}$ if and only if $F' \subset F$; furthermore, in this case Δ_F is a face of $\Delta_{F'}$;
- $\Delta_F \subset \partial\Delta(P)$ if and only if F is unbounded.

Example 2.6. The dual subdivisions of the tropical curves in Figure 2 are drawn in Figure 3 (the black points represent the points of $\Delta(P)$ which have integer coordinates; note that these points are not necessarily vertices of the dual subdivision).

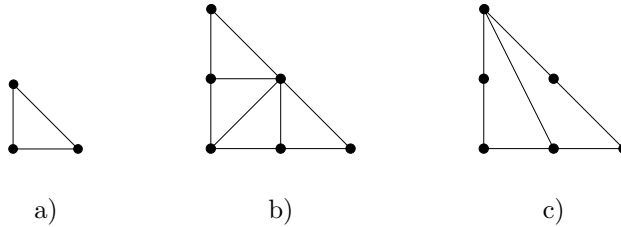

FIGURE 3. Subdivisions dual to the tropical curves depicted in Figure 2

The weight of an edge of a tropical curve can be read off from the dual subdivision.

Proposition 2.7. *An edge e of a tropical curve has weight w if and only if the integer length of Δ_e is w , i.e. $\text{Card}(\Delta_e \cap \mathbb{Z}^2) - 1 = w$.*

2.3. Balanced graphs and tropical curves.

Let v be a vertex of a tropical curve C , and let e_1, \dots, e_k be the edges adjacent to v . Denote by w_1, \dots, w_k the weights of e_1, \dots, e_k . Let $v_i, i = 1, \dots, k$, be the primitive integer vector (i.e., having mutually prime \mathbb{Z} -coordinates) in the direction of e_i and pointing outward from v , see Figure 4a. The vectors $w_1 v_1, \dots, w_k v_k$ are obtained from the sides of the closed polygon Δ_v (oriented counter-clockwise) via rotation by $\pi/2$, (see Figure

4b). Hence, the tropical curve C satisfies the so called *balancing condition* at each of its vertices v .

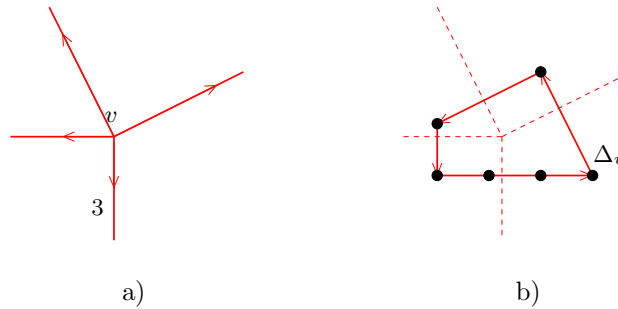

FIGURE 4. Balancing condition.

Proposition 2.8 (Balancing condition). One has

$$\sum_{i=1}^k w_i v_i = 0.$$

A rectilinear graph $\Gamma \subset \mathbb{R}^2$ whose edges have rational slopes and are equipped with positive integer weights is called a *balanced graph* if Γ satisfies the balancing condition at each vertex. We have just seen that every tropical curve is a balanced graph. The converse is also true.

Theorem 2.9 ([Mik04b]). *Any balanced graph in \mathbb{R}^2 is a tropical curve.*

For example, there exist tropical polynomials of degree 3 whose tropical curves are the weighted graphs depicted in Figure 5. The figure also contains the dual subdivisions of these curves.

2.4. Tropical curves as limits of amoebas

As in the case of polynomials in one variable, tropical curves can be approximated, via the logarithm map, by algebraic curves in $(\mathbb{C}^\times)^2$. For this, we need the following map (where $t > 1$):

$$\begin{aligned} \text{Log}_t : (\mathbb{C}^\times)^2 &\longrightarrow \mathbb{R}^2 \\ (z, w) &\longmapsto (\log_t |z|, \log_t |w|) \end{aligned}$$

Definition 2.10 (Gelfand-Kapranov-Zelevinsky [GKZ94]). The *amoeba* (in base t) of $V \subset (\mathbb{C}^\times)^2$ is $\text{Log}_t(V)$.

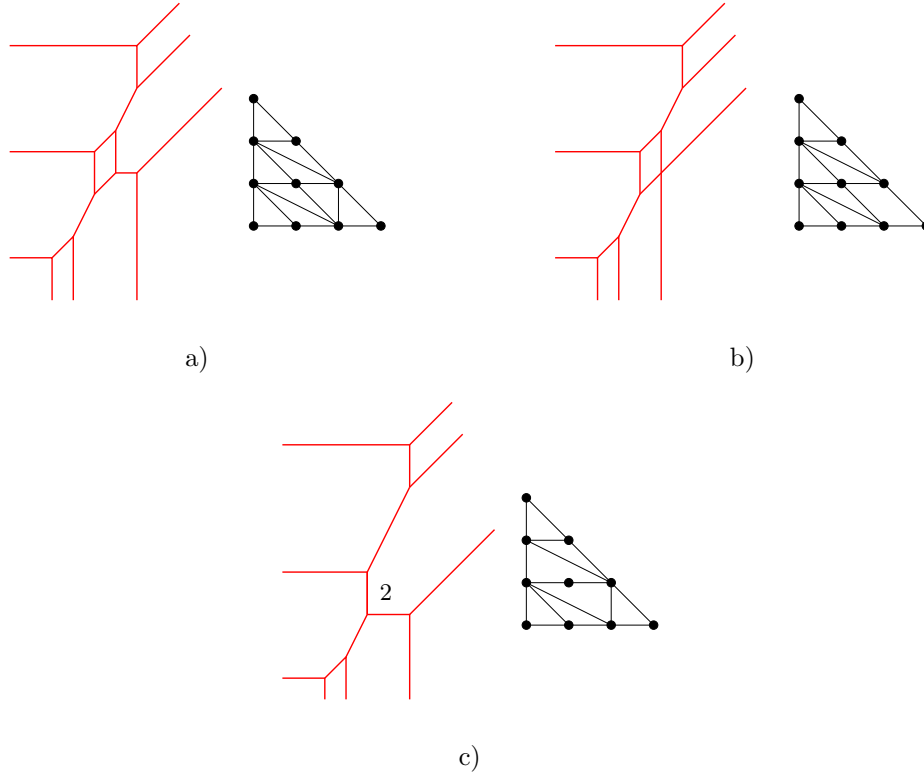

FIGURE 5. Some tropical cubics and their dual subdivisions

For example, the amoeba of the line \mathcal{L} defined by $z + w + 1 = 0$ in $(\mathbb{C}^\times)^2$ is depicted in Figure 6a. This amoeba has three asymptotic directions: $(-1, 0)$, $(0, -1)$, and $(1, 1)$.

The amoeba of \mathcal{L} in base t is a contraction by a factor $\log t$ of the amoeba of \mathcal{L} in base e (see Figures 6b, c). Hence, when t goes to $+\infty$, the amoeba is contracted to the origin, only the three asymptotic directions remain. In other words, what we see at the limit in Figure 6d is a tropical line!

Of course, the same strategy applied to any complex curve in $(\mathbb{C}^\times)^2$ produces a similar picture at the limit: a collection of rays emerging from the origin in the asymptotic directions of the amoeba. To get a more interesting limit, one can look at the family of amoebas, $\text{Log}_t(\mathcal{C}_t)$, where $(\mathcal{C}_t)_{t \in \mathbb{R}_{>1}}$ is a non-trivial family of complex curves.

Example 2.11. Figure 7 depicts the amoeba of the complex curve given by the equation $1 - z - w + t^{-2}z^2 - t^{-1}zw + t^{-2}w^2 = 0$ for t sufficiently large, and the limiting object which is... a tropical conic.

The following statement is the two-dimensional counterpart of Theorem 1.4.

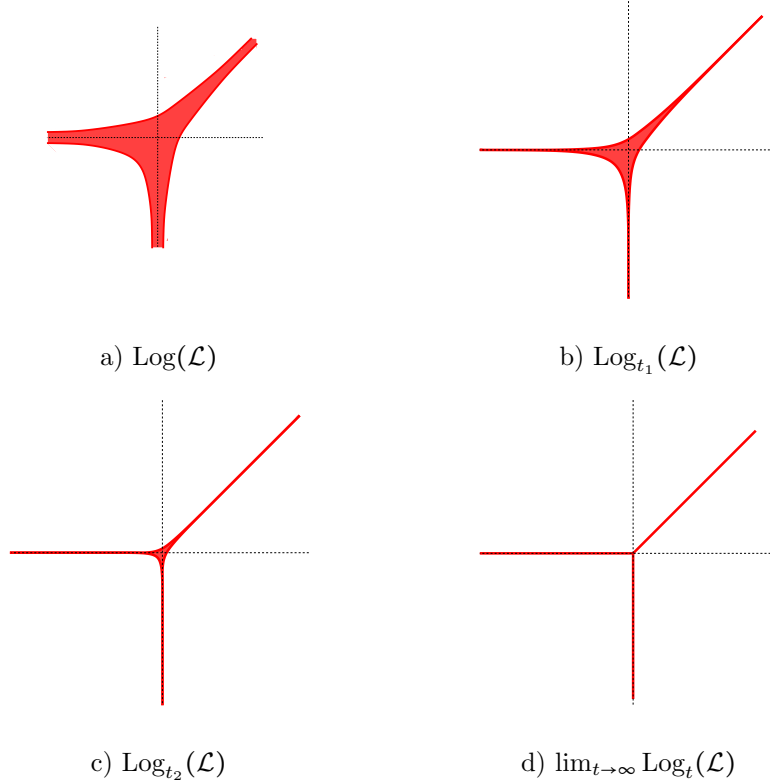

FIGURE 6. Dequantization of a line ($e < t_1 < t_2$)

Theorem 2.12. (cf. [Kap00, Mik04b]) Let $P_t(z, w) = \sum_{i,j} \alpha_{i,j}(t) z^i w^j$ be a polynomial whose coefficients are functions $\alpha_{i,j} : \mathbb{R} \rightarrow \mathbb{C}$, and suppose that $\alpha_{i,j}(t) \sim \gamma_{i,j} t^{a_{i,j}}$ when t goes to $+\infty$ with $\gamma_{i,j} \in \mathbb{C}^\times$ and $a_{i,j} \in \mathbb{T}$.

If \mathcal{C}_t denotes the curve in $(\mathbb{C}^\times)^2$ defined by the polynomial $P_t(z, w)$, then the amoebas $\text{Log}_t(\mathcal{C}_t)$ converge to the tropical curve defined by the tropical polynomial $P_{\text{trop}}(x, y) = \sum_{i,j} a_{i,j} x^i y^j$.

It remains to explain the relation between amoebas and weights of a tropical curve. Let $P_t(z, w)$ and $P'_t(z, w)$ be two families of complex polynomials, defining two families of complex algebraic curves $(\mathcal{C}_t)_{t \in \mathbb{R}_{>1}}$ and $(\mathcal{C}'_t)_{t \in \mathbb{R}_{>1}}$, respectively. As in Theorem 2.12, these two families of polynomials induce two tropical polynomials $P_{\text{trop}}(x, y)$ and $P'_{\text{trop}}(x, y)$, which in turn define two tropical curves C and C' .

Proposition 2.13 (cf. [Mik04a, PR04]). Let $p \in C \cap C'$ be a point which is not a vertex of C or C' . Assume that the edges of C and C' which contain p are not parallel. Then,

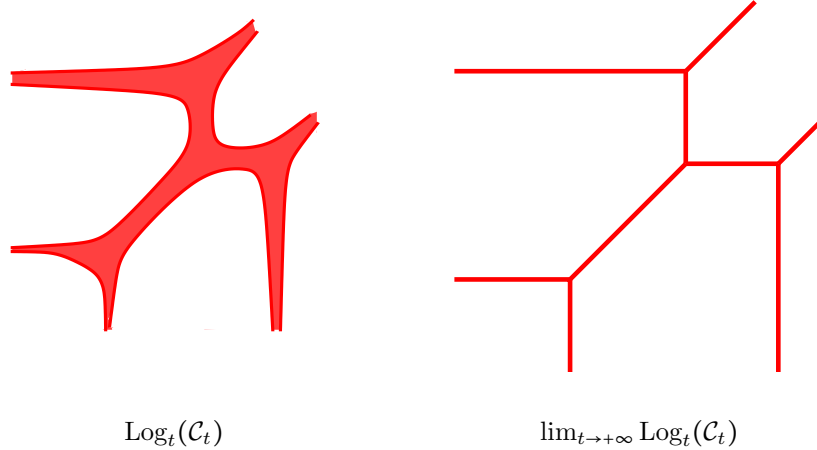

FIGURE 7. $C_t : 1 - z - w + t^{-2}z^2 - t^{-1}zw + t^{-2}w^2 = 0$

the number of intersection points of C_t and C'_t whose image under Log_t converges to p is equal to the Euclidean area of the polygon Δ_p dual to p in the subdivision dual to $C \cup C'$.

The above number is denoted by $(C \cdot C')_p$ and is called the *multiplicity* of the intersection point p of C and C' . It is worth noting that the number of intersection points which converge to p depends only on C and C' , that is, only on the order at infinity of the coefficients of $P_t(z, w)$ and $P'_t(z, w)$.

If e is an edge of a tropical curve C , and p is an interior point of e , then the weight of e is equal to the minimal multiplicity $(C \cdot C')_p$ for all possible tropical curves $C' \ni p$ such that $(C \cdot C')_p$ is defined.

Example 2.14. Figures 8a,c depict different mutual positions of a tropical line and a tropical conic. The corresponding dual subdivisions of the union of the two curves are depicted in Figures 8b,d.

In Figure 8a (respectively, Figure 8c), the tropical line intersects the tropical conic in two points of multiplicity 1 (respectively, in one point of multiplicity 2).

The combination of Theorem 2.12 and Proposition 2.13 allows one, for example, to deduce the Bernstein Theorem [Ber75] in classical algebraic geometry from the tropical Bernstein Theorem (see Exercise 2(4)).

Exercises 2.

- (1) Draw the tropical curves defined by the tropical polynomials $P(x, y) = "5 + 5x + 5y + 4xy + 1y^2 + x^2"$ and $Q(x, y) = "7 + 4x + y + 4xy + 3y^2 + (-3)x^2"$, as well as the dual subdivisions of these tropical curves.

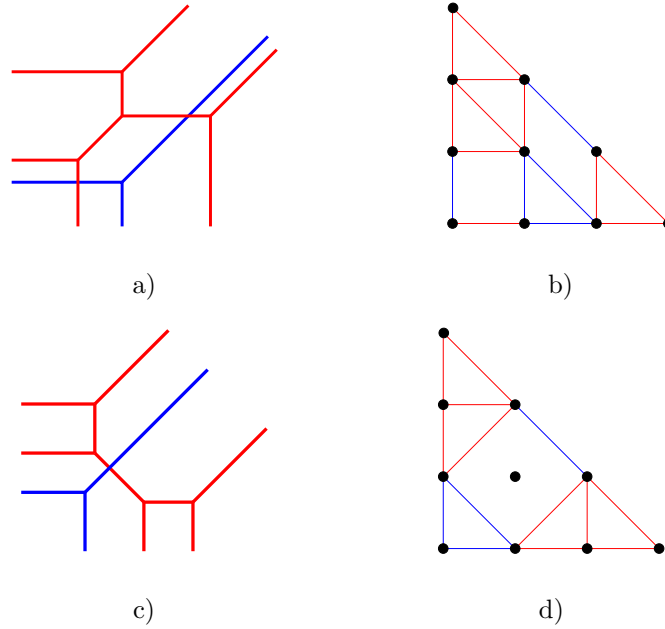

FIGURE 8. Tropical intersections

- (2) Show that a tropical curve defined by a polynomial of degree d has at most d^2 vertices.
- (3) Find an equation for each of the tropical curves in Figure 5. The following reminder might be helpful: if v is a vertex of a tropical curve defined by a tropical polynomial $P(x, y)$, then the value of $P(x, y)$ in a neighborhood of v is given uniquely by the monomials corresponding to the polygon dual to v .
- (4) Prove the tropical Bernstein Theorem: let C and C' be two tropical curves such that $C \cap C'$ does not contain any vertex of C or C' ; then, the sum of the multiplicities of all intersection points of C and C' is equal to the mixed volume of $\Delta(C_1)$ and $\Delta(C_2)$, *i.e.* to

$$\text{Area}(\Delta(C \cup C')) - \text{Area}(\Delta(C)) - \text{Area}(\Delta(C')).$$

Here, $\text{Area}(\Delta(C))$ is the Euclidean area of the Newton polygon of C . Deduce the classical Bernstein Theorem from its tropical counterpart.

3. Patchworking

In this section, we present a first application of the material discussed above to real algebraic geometry. The patchworking technique invented by O. Viro at the end of the 1970's constitutes one of the roots of tropical geometry. At that time the formalism of tropical geometry did not exist yet, and the original formulation of patchworking is dual to

the presentation we give here. Tropical formulation of patchworking became natural with the introduction of amoebas due to I.M. Gelfand, M.M. Kapranov and A.V. Zelevinsky [GKZ94], further relations between amoebas and real algebraic curves were found by O. Viro and G. Mikhalkin (see [Vir01] and [Mik00]). We discuss here only a particular case of the general patchworking theorem. This case, called *combinatorial patchworking*, turned out to be a powerful tool to construct plane real algebraic curves (and, more generally, real algebraic hypersurfaces of toric varieties).

A *real algebraic curve* in $(\mathbb{C}^\times)^2$ is an algebraic curve defined by a polynomial with real coefficients. Given such a real algebraic curve \mathcal{C} , we denote by $\mathbb{R}\mathcal{C}$ the set of real points of \mathcal{C} , *i.e.* $\mathbb{R}\mathcal{C} = \mathcal{C} \cap (\mathbb{R}^\times)^2$.

3.1. Patchworking of a line

Let us start by looking more closely at the amoeba of the real algebraic line $\mathcal{L} \subset (\mathbb{R}^\times)^2$ given by the equation $az + bw + c = 0$ with $a, b, c \in \mathbb{R}^\times$. The whole amoeba $\mathcal{A}(\mathcal{L})$ is depicted in Figure 6a, and the amoeba of $\mathbb{R}\mathcal{L}$ is depicted in Figure 9c. Note that $\mathcal{A}(\mathcal{L})$ does not depend on a, b , and c up to translation in \mathbb{R}^2 , and that $\partial\mathcal{A}(\mathcal{L}) = \mathcal{A}(\mathbb{R}\mathcal{L})$.

We can label each arc of $\mathcal{A}(\mathbb{R}\mathcal{L})$ by the pair of signs corresponding to the quadrant of $(\mathbb{R}^\times)^2$ through which the corresponding arc of $\mathbb{R}\mathcal{L}$ passes (see Figure 6d, where $\varepsilon(x)$ denotes the sign of x). This labeling only depends on the signs of a, b , and c . Moreover, if two arcs of $\mathcal{A}(\mathbb{R}\mathcal{L})$ have an asymptotic direction (u, v) in common, then these pairs of signs differ by a factor $((-1)^u, (-1)^v)$.

We may recover from $\mathcal{A}(\mathbb{R}\mathcal{L})$ the isotopy class (up to axial symmetries) of $\mathbb{R}\mathcal{L}$ in $(\mathbb{R}^\times)^2$. To do this, we assign a pair of signs to some arc of $\mathcal{A}(\mathbb{R}\mathcal{L})$ (Figure 10a). As we have seen, this determines a pair of signs for the two other arcs of $\mathcal{A}(\mathbb{R}\mathcal{L})$ (Figure 10b). For an arc $A \subset \mathcal{A}(\mathbb{R}\mathcal{L})$ labeled by $((-1)^{\varepsilon_1}, (-1)^{\varepsilon_2})$ we draw its image under the map $(x, y) \mapsto ((-1)^{\varepsilon_1} e^x, (-1)^{\varepsilon_2} e^y)$ in $(\mathbb{R}^\times)^2$. Clearly, the image of A is contained in the $((-1)^{\varepsilon_1}, (-1)^{\varepsilon_2})$ -quadrant. The union of the images of the three arcs (shown on Figure 10c) is isotopic to a straight line (shown on Figure 9a).

3.2. Patchworking of non-singular tropical curves

Viro's patchworking theorem is a generalization of the previous observations, in the case of an approximation of a *non-singular tropical curve* by a family of amoebas of real algebraic curves.

Definition 3.1. A tropical curve in \mathbb{R}^2 is *non-singular* if its dual subdivision is formed by triangles of Euclidean area $\frac{1}{2}$.

Equivalently, a tropical curve is non-singular if and only if it has exactly $2 \text{Area}(\Delta(C))$ vertices. Recall that a triangle with vertices in \mathbb{Z}^2 and having Euclidean area $\frac{1}{2}$ can be mapped, via the composition of a translation and an element of $SL_2(\mathbb{Z})$, to the triangle with vertices $(0, 0), (1, 0), (1, 1)$. In other words, an algebraic curve in $(\mathbb{C}^\times)^2$ with Newton polygon of Euclidean area $\frac{1}{2}$ is nothing else but a line in suitable coordinates. We use this observation in the following construction.

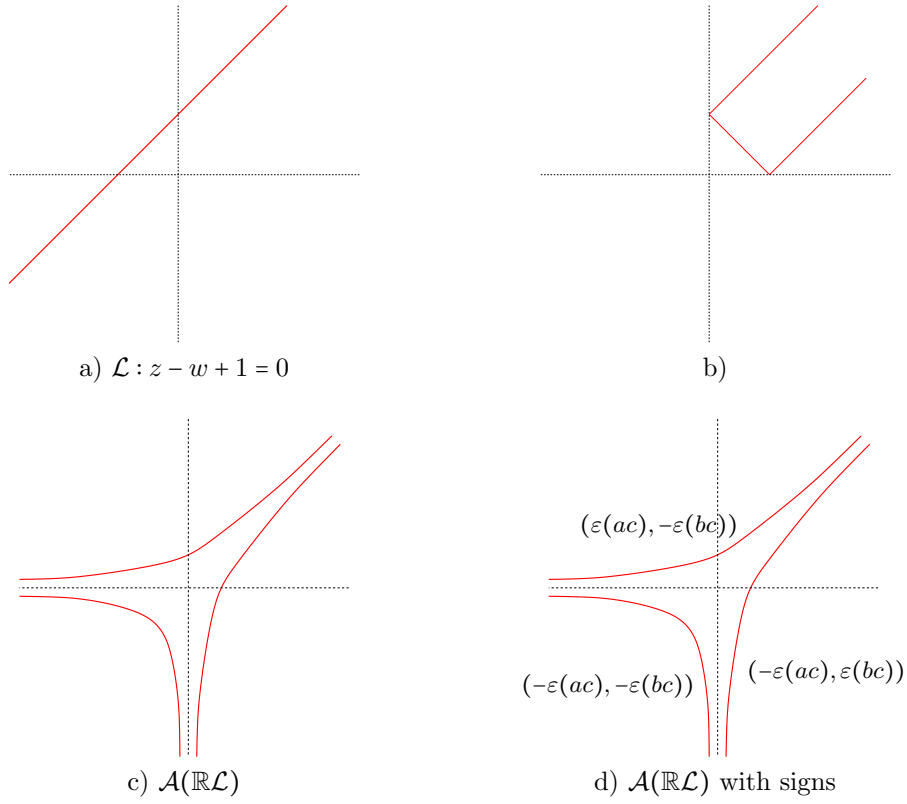

FIGURE 9. Amoeba of a real line

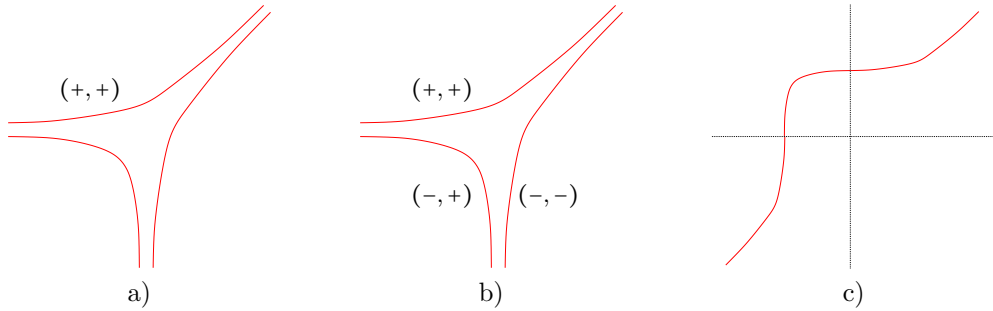

FIGURE 10. Patchworking of a line

Let C be a non-singular tropical curve in \mathbb{R}^2 . Let $(C_t)_{t \in \mathbb{R}_{>1}}$ be a family of real algebraic curves whose amoebas approximate C in the sense of Theorem 2.12. Then, one can show that when t is sufficiently large, the following hold:

- for any vertex a of C , in a small neighborhood U_a of a the amoeba $\mathcal{A}_t(\mathbb{R}\mathcal{C}_t) \cap U_a$ is made of three arcs as depicted in Figure 11a, corresponding to three arcs on $\mathbb{R}\mathcal{C}_t$;
- for each bounded edge e of C , in a small neighborhood U_e of e the amoeba $\mathcal{A}_t(\mathbb{R}\mathcal{C}_t) \cap U_e$ is made of four arcs, corresponding to four arcs on $\mathbb{R}\mathcal{C}_t$. The position of the arcs with respect to the edge is as depicted in either Figure 11b or c. Moreover, if e has primitive integer direction (u, v) , then the two arcs of $\mathcal{A}_t(\mathbb{R}\mathcal{C}_t) \cap U_e$ converging to e correspond to arcs of $\mathbb{R}\mathcal{C}_t$ contained in quadrants of $(\mathbb{R}^\times)^2$ whose corresponding pairs of signs differ by a factor $((-1)^u, (-1)^v)$.

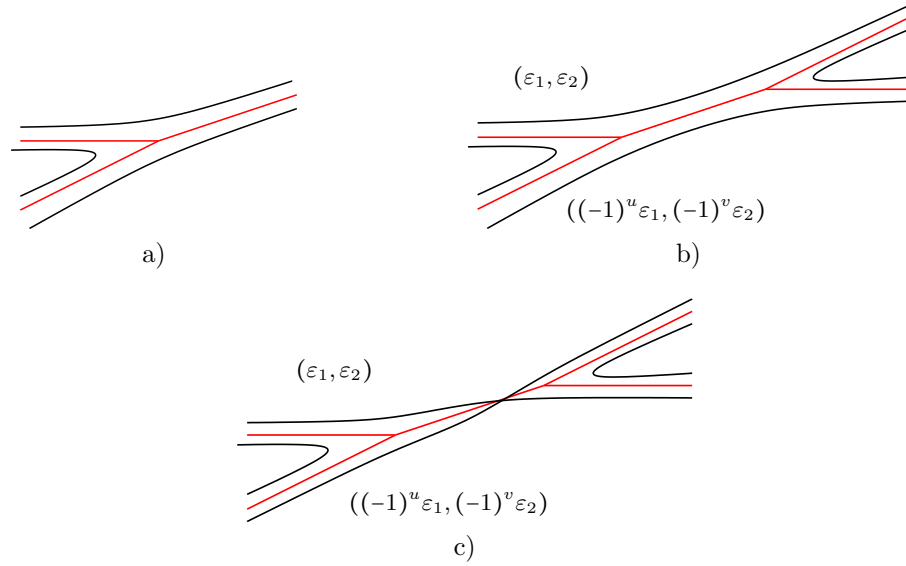

FIGURE 11. $\mathcal{A}_t(\mathbb{R}\mathcal{C}_t) \cap U$ for large t

The above two properties imply that the position of $\mathbb{R}\mathcal{C}_t$ in $(\mathbb{R}^\times)^2$ up to the action of $(\mathbb{Z}/2\mathbb{Z})^2$ by axial symmetries $(z, w) \mapsto (\pm z, \pm w)$ is entirely determined by the partition of the edges of C between the two types of edges depicted in Figures 11b, c.

Definition 3.2. An edge of C as in Figure 11c is said to be *twisted*.

Not any subset of the edges of C may arise as the set of twisted edges. Nevertheless, the possible distributions of twists are easy to describe.

Definition 3.3. A subset T of the set of bounded edges of C is called *twist-admissible* if they satisfy the following condition:

for any cycle γ of C , if e_1, \dots, e_k are the edges in $\gamma \cap T$, and if (u_i, v_i) is a primitive integer vector in the direction of e_i , then

$$\sum_{i=1}^k (u_i, v_i) = 0 \pmod{2}. \quad (1)$$

The Viro patchworking theorem [Vir01] may be reformulated in terms of twist-admissible sets as follows.

Theorem 3.4. *For any twist-admissible set T in a non-singular tropical curve C in \mathbb{R}^2 , there exists a family of non-singular real algebraic curves $(C_t)_{t \in \mathbb{R}_{>1}}$ in $(\mathbb{C}^\times)^2$ which converges to C in the sense of Theorem 2.12 and such that the corresponding set of twisted edges is T .*

Example 3.5. One may choose T to be empty as the empty set clearly satisfies (1). The resulting curve corresponds to the construction of *simple Harnack curves* described in [Mik00] via Harnack distribution of signs, see [IV96].

Example 3.6. If C is a tree then any set of edges is twist-admissible.

Example 3.7. Consider the tropical cubic depicted in Figure 5a, and choose two subsets T of the set of edges (marked by a cross) of C as depicted in Figures 12a, b. The first one is twist-admissible, while the second is not.

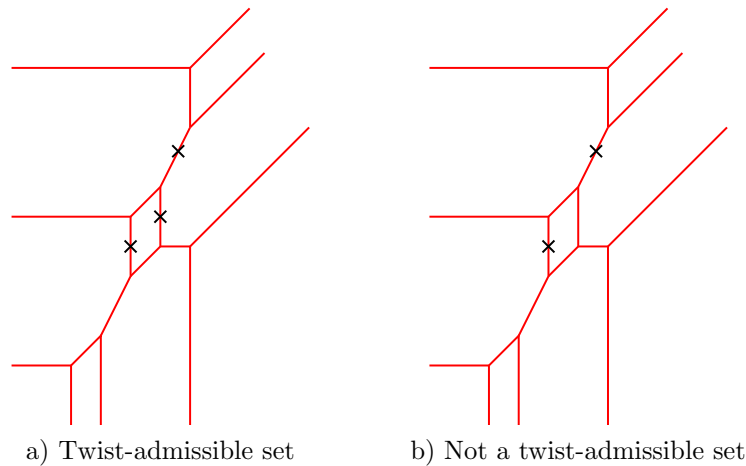

FIGURE 12

Below is a summary of the procedure recovering the isotopy type of $\mathbb{R}C_t \subset (\mathbb{R}^\times)^2$ (up to axial symmetries) from a smooth tropical curve $C \subset \mathbb{R}$ and a twist-admissible set T of edges in C .

- At each vertex of C , we draw three arcs as depicted in Figure 11a.
- For each bounded edge e adjacent to the vertices v and v' we join the two corresponding arcs at v to the corresponding ones for v' in the following way: if $e \notin T$, then join these arcs as depicted in Figure 11b; if $e \in T$, then join these arcs as depicted in Figure 11c; denote by \mathcal{P} the curve obtained.
- We choose arbitrarily a connected component of \mathcal{P} and a pair of signs for it. (Different choices produce the same isotopy type in $(\mathbb{R}^\times)^2$ up to axial symmetries.)
- We associate pairs of signs to all connected components of \mathcal{P} using the following rule. Given an edge e with primitive integer direction (u, v) , the pairs of signs of the two connected components of \mathcal{P} corresponding to e differ by a factor $((-1)^u, (-1)^v)$. (The compatibility condition (1) ensures that this rule is consistent.)
- We map each connected component A of \mathcal{P} to $(\mathbb{R}^\times)^2$ by $(x, y) \mapsto (\varepsilon_1 e^x, \varepsilon_2 e^y)$, where $(\varepsilon_1, \varepsilon_2)$ is the pair of signs associated to A . The resulting curve is the union of these images over all connected components of \mathcal{P} .

Example 3.8. Figures 13, 14, 15, and 16 depict tropical curves of degree 3, 4, and 6 enhanced with twist-admissible collections of edges, and the isotopy types of the corresponding real algebraic curves in both $(\mathbb{R}^\times)^2$ and $\mathbb{R}P^2$.

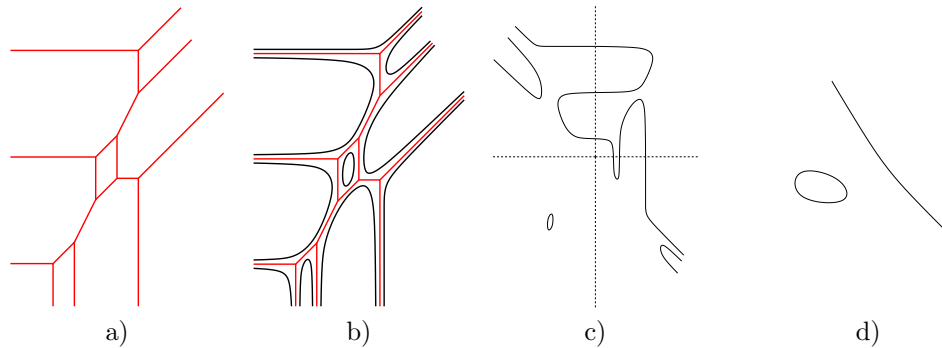

FIGURE 13. A Harnack cubic

A real algebraic curve of degree 6 which realizes the isotopy type in $\mathbb{R}P^2$ depicted in Figure 16d was first constructed by D. A. Gudkov in 1960's by a different technique. This answered one of the questions posed by D. Hilbert in 1900.

Remark 3.9. We may find an explicit equation for a family $(\mathcal{C}_t)_{t \in \mathbb{R}_{>1}}$ from Theorem 3.4 as follows. Suppose that the tropical curve C is given by the tropical polynomial $P_{trop}(x, y) = \sum_{i,j} a_{i,j} x^i y^j$. We define the family $(\mathcal{C}_t)_{t \in \mathbb{R}_{>1}}$ by a family of real polynomials $P_t(z, w) = \sum_{i,j} \gamma_{i,j} t^{a_{i,j}} z^i w^j$, with $\gamma_{i,j} \in \mathbb{R}^\times$. For any choice of $\gamma_{i,j}$ the resulting family will

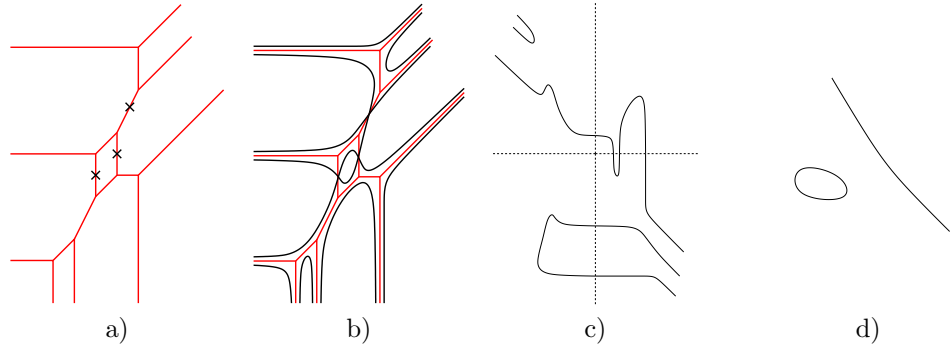

FIGURE 14. Another patchworking of a cubic

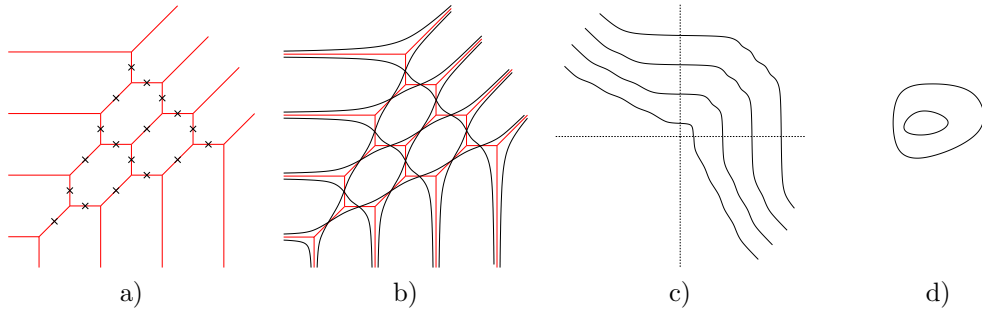

FIGURE 15. A hyperbolic quartic

converge to C in the sense of Theorem 2.12. In turn the set of twisted edges only depends on the signs of $\gamma_{i,j}$, as described below.

For each bounded edge e of C , denote by p_1^e and p_2^e the two vertices of the segment Δ_e dual to e . The segment Δ_e is adjacent to exactly two other triangles of the dual subdivision. Let p_3^e and p_4^e denote the vertices of these two triangles not equal to p_1^e, p_2^e . Then, the set of twisted edges of the family $(\mathcal{C}_t)_{t \in \mathbb{R}_{>1}}$ is exactly T if and only if for each bounded edge e of the dual subdivision, the following holds:

- if the coordinates modulo 2 of p_3^e and p_4^e are distinct, (see Figure 17a), then e is twisted if and only if $\gamma_{p_1^e} \gamma_{p_2^e} \gamma_{p_3^e} \gamma_{p_4^e} > 0$;
- if the coordinates modulo 2 of p_3^e and p_4^e coincide (see Figure 17b), then e is twisted if and only if $\gamma_{p_3^e} \gamma_{p_4^e} < 0$.

Remark 3.10. We may also determine the topological type of the surface $\mathcal{C}_t / \text{conj}$ for sufficiently large t , where conj is the restriction on \mathcal{C}_t of the complex conjugation in $(\mathbb{C}^\times)^2$. Start with a small tubular neighborhood S of C in \mathbb{R}^2 . For each twisted edge e of C , we cut S along a fiber at some point inside e and glue it back with a half-twist. In other

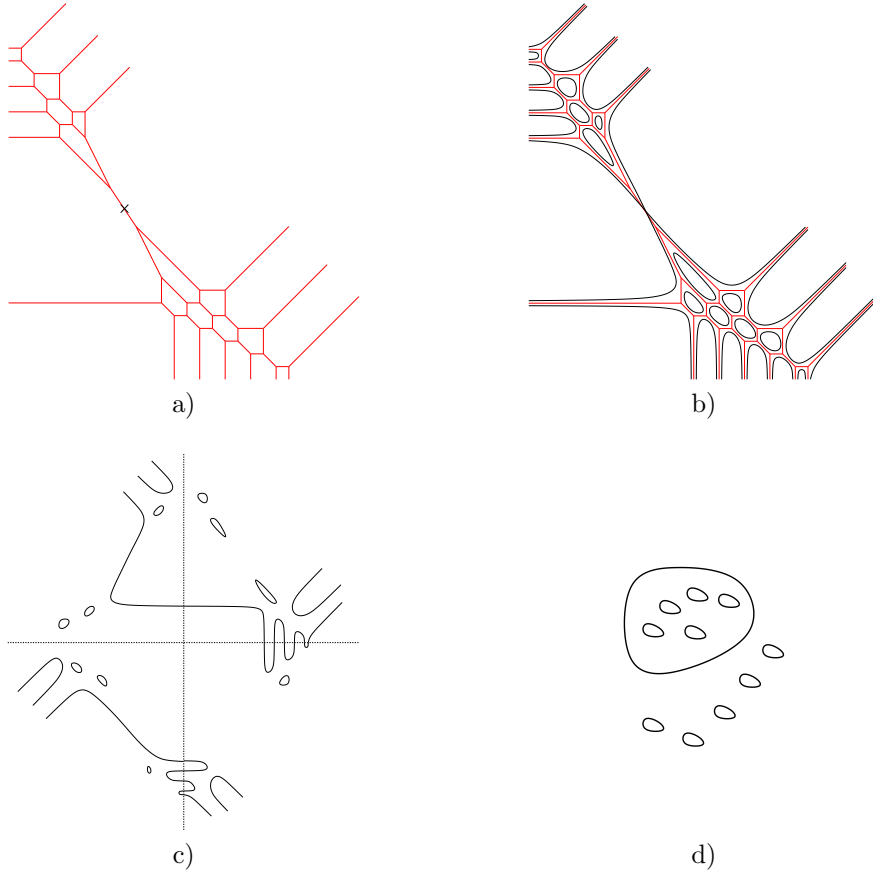

FIGURE 16. Gudkov's sextic

words, we start with the amoeba $\mathcal{A}_t(\mathcal{C}_t)$ (for large t) and add a half-twist wherever we see a double point of $\mathcal{A}_t(\mathbb{R}\mathcal{C}_t)$.

The result is a surface with boundary (and punctures) diffeomorphic to $\mathcal{C}_t/\text{conj}$ for t large enough. For example, the surface $\mathcal{C}_t/\text{conj}$ corresponding to the patchworking depicted in Figure 18a is depicted in Figure 18c (compare with Figure 18b).

Recall that a non-singular real curve $\mathbb{R}\mathcal{C}_t$ is said to be of *type I* if $\mathcal{C}_t/\text{conj}$ is orientable.

Proposition 3.11 ([Haa97]). *Let $C \subset \mathbb{R}^2$ be a smooth tropical curve, and let $(\mathcal{C}_t)_{t \in \mathbb{R}_{>1}}$ be a family of non-singular real curves converging to C in the sense of Theorem 2.12, so that the corresponding set of twisted edges is T . A curve $\mathbb{R}\mathcal{C}_t$ is of type I for sufficiently large t if and only if each cycle in C contains an even number of edges from T .*

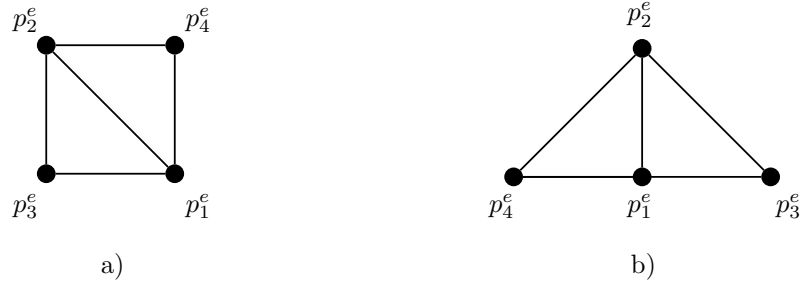

FIGURE 17. The dual subdivision surrounding Δ_e from Remark 3.9.

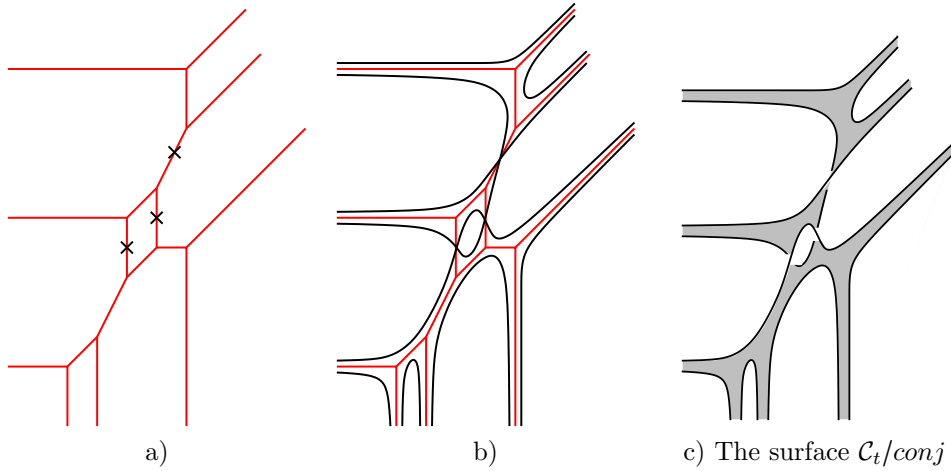

FIGURE 18

Accordingly, we say that a twist-admissible set T is *of type I* if each cycle in C contains an even number of edges from T .

3.3. Haas Theorem

Let \mathcal{C} be a non-singular real algebraic curve in $(\mathbb{C}^\times)^2$. Denote by $\Delta(\mathcal{C})$ the Newton polygon of \mathcal{C} , that is, the Newton polygon of a polynomial defining \mathcal{C} ; the polygon $\Delta(\mathcal{C})$ is defined up to translation by a vector with integer coordinates. Topologically, the curve \mathcal{C} may be obtained from a closed Riemann surface $\bar{\mathcal{C}}$ by removing a finite number of points (corresponding to the ends of \mathcal{C}). We denote by $\mathbb{R}\bar{\mathcal{C}}$ the topological closure of $\mathbb{R}\mathcal{C}$ in $\bar{\mathcal{C}}$. By Harnack's inequality, the maximal number of connected components of $\mathbb{R}\bar{\mathcal{C}}$ is equal to $g(\bar{\mathcal{C}}) + 1$, where $g(\bar{\mathcal{C}})$ is the genus of $\bar{\mathcal{C}}$; this genus in turn equals to $\text{Card}(\mathbb{Z}^2 \cap \text{Int}(\Delta(\mathcal{C})))$. We say that $\mathbb{R}\mathcal{C}$ is an *M-curve*, or a *maximal curve*, if the number

of connected components of $\mathbb{R}\bar{C}$ is equal to $g(\bar{C}) + 1$. The maximal curves constitute extremal objects in real algebraic geometry; their study goes back to A. Harnack and F. Klein in the XIXth century. We refer to [Vir] for an introduction to the subject.

B. Haas in [Haa97] found a nice criterion for a curve obtained by the combinatorial patchworking to be an M -curve.

Definition 3.12. Let C be a non-singular tropical curve in \mathbb{R}^2 , and let T be a twist-admissible set of edges in C . We say that T is *maximal* if it is of type I, and for any edge $e \in T$, either $C \setminus e$ is disconnected or there exists an edge $e' \in T$ such that $C \setminus e$ and $C \setminus e'$ are connected, but $C \setminus (e \cup e')$ is disconnected.

For example, an empty collection T is not only twist-admissible, but also maximal.

Theorem 3.13 ([Haa97]). *Let C be a non-singular tropical curve in \mathbb{R}^2 , and let T be a twist-admissible set of edges in C . Suppose that $(C_t)_{t \in \mathbb{R}_{>1}}$ is a family of non-singular real algebraic curves in $(\mathbb{C}^\times)^2$ such that $(C_t)_{t \in \mathbb{R}_{>1}}$ converges to C in the sense of Theorem 2.12 and T is the corresponding set of twisted edges. Then, the real curve C_t is maximal for sufficiently large t if and only if T is maximal.*

Example 3.14. If T is a twist-admissible set of edges in a non-singular tropical curve C , and T contains an edge which is not adjacent to an unbounded connected component of $\mathbb{R}^2 \setminus C$, then T is not maximal (cf. Figure 15).

Exercises 3.

- (1) Show that the first Betti number of a non-singular tropical curve in \mathbb{R}^2 is equal to the number of integer points contained in the interior of the Newton polygon of this curve.
- (2) Let C be a non-singular tropical curve, and let $(C_t)_{t \in \mathbb{R}_{>1}}$ be a family of non-singular real algebraic curves converging to C so that there are no twisted edges. Prove that, for sufficiently large values of t , the isotopy type of C_t in $(\mathbb{R}^\times)^2$ is determined (up to the action of $(\mathbb{Z}/2\mathbb{Z})^2$ by axial symmetries) by the Newton polygon $\Delta(C)$ of C and does not depend on the choice of a particular tropical curve with given Newton polygon.
- (3) Show that any twist-admissible set of edges in the tropical cubic depicted at Figure 5a produces an M -cubic. Find another tropical cubic together with a twist-admissible set for it such that they produce a connected real cubic in $\mathbb{R}P^2$.
- (4) Following Remark 3.9, write equations of families of non-singular real algebraic curves $(C_t)_{t \in \mathbb{R}_{>1}}$ corresponding to tropical curves and twisted edges in Example 3.8.

4. Applications in enumerative geometry

4.1. Complex and real enumerative problems

Tropical geometry has various applications in enumerative geometry. We restrict our attention here to one of the classical enumerative problems: enumeration of curves of

given degree $d > 0$ and (geometric) genus $g \geq 0$ that pass through the appropriate number (equal to $3d - 1 + g$) of points in general position in the projective plane. This problem can be considered over different fields (and even semi-fields). The easiest and the most studied framework is the one of complex geometry. Consider a collection ω of $3d - 1 + g$ points in general position in the complex projective plane $\mathbb{C}P^2$. The number $N_{d,g}$ of irreducible complex algebraic curves of degree d and genus g which pass through the points of ω depends only on d and g and not on the choice of points as long as this choice is generic: as we will see later, this number can be interpreted as the degree of certain algebraic variety.

A non-singular algebraic curve in $\mathbb{C}P^2$ of degree d has genus $\frac{(d-1)(d-2)}{2}$, so we obtain

$$N_{d,g} = 0 \quad \text{if } g > \frac{(d-1)(d-2)}{2}.$$

The case $g = \frac{(d-1)(d-2)}{2}$ is also easy. If $d = 1$ and $g = 0$, we are counting straight lines which pass through two points, so $N_{1,0}$ is equal to 1. In the case $d = 2$ and $g = 0$, we are counting conics which pass through five points in general position, so $N_{2,0}$ is also equal to 1. More generally, for any choice of $\frac{d(d+3)}{2}$ points in general position in $\mathbb{C}P^2$, there exists exactly one curve of degree d in $\mathbb{C}P^2$ and genus $g = \frac{(d-1)(d-2)}{2}$ which passes through these points. Indeed, the space $\mathbb{C}C_d$ of all curves of degree d in $\mathbb{C}P^2$ can be identified with a projective space $\mathbb{C}P^N$ of dimension $N = \frac{d(d+3)}{2}$: the coefficients of a polynomial $\sum \alpha_{i,j} z^i w^j u^{d-i-j}$ defining a given curve can be taken for homogeneous coordinates $[\alpha_{0,0} : \alpha_{0,1} : \alpha_{1,0} : \dots : \alpha_{d,0}]$ of the corresponding point in $\mathbb{C}C_d$. The condition to pass through a given point $[z_0 : w_0 : u_0]$ in $\mathbb{C}P^2$ gives rise to the linear condition

$$\sum \alpha_{i,j} z_0^i w_0^j u_0^{d-i-j} = 0$$

on the coefficients $\alpha_{i,j}$ of a polynomial defining the curve, and thus defines a hyperplane in $\mathbb{C}C_d$. If the collection of the $\frac{d(d+3)}{2}$ chosen points is sufficiently generic, the corresponding $\frac{d(d+3)}{2}$ hyperplanes in $\mathbb{C}C_d$ have exactly one common point, and this point corresponds to a non-singular curve. Hence, we proved the following statement.

Proposition 4.1. *For any positive integer d , we have*

$$N_{d, \frac{(d-1)(d-2)}{2}} = 1.$$

A more interesting situation arises in the cases $g < \frac{(d-1)(d-2)}{2}$, as illustrated by the following example.

Example 4.2. The number of rational cubic curves in $\mathbb{C}P^2$ which pass through a collection ω of 8 points in general position is equal to 12, *i.e.* $N_{3,0} = 12$. Indeed, the collection ω determines a straight line \mathcal{P} in $\mathbb{C}C_3$, that is, a pencil \mathcal{P} of cubics. Since this pencil is generated by any two of its elements, the intersections of all cubics of \mathcal{P} consists of ω together with a ninth point. Let $\overline{\mathbb{C}P^2}$ be the projective plane $\mathbb{C}P^2$ blown up at these 9 points. The Euler characteristic $\chi(\overline{\mathbb{C}P^2})$ of $\overline{\mathbb{C}P^2}$ is then equal to $3 + 9 = 12$. On the other

hand, the pencil \mathcal{P} induces a projection $\widehat{\mathbb{C}P^2} \rightarrow \mathcal{P}$, which has two types of fibers: either a smooth elliptic curve, or a nodal cubic. Since the former has Euler characteristic 0, and the latter has Euler characteristic 1, we obtain that $\chi(\widehat{\mathbb{C}P^2}) = N_{3,0}$.

Example 4.2 generalizes to any degree.

Proposition 4.3. *For any positive integer d , we have*

$$N_{d, \frac{(d-1)(d-2)}{2} - 1} = 3(d-1)^2.$$

We may give another geometric interpretation of the numbers $N_{d, \frac{(d-1)(d-2)}{2} - 1}$. Consider the hypersurface $D \subset \mathbb{C}C_d$ formed by the points corresponding to singular curves of degree d in $\mathbb{C}P^2$. This hypersurface is called the *discriminant* of $\mathbb{C}C_d$. The smooth part of D is formed by the points corresponding to curves whose only singular point is a non-degenerate double point. A generic collection of $\frac{d(d+3)}{2} - 1$ points determines a straight line in $\mathbb{C}C_d$, and moreover, this line intersects the discriminant only in its smooth part and transversally. Thus, the number $N_{d, \frac{(d-1)(d-2)}{2} - 1}$ coincides with the degree of D .

To reformulate in a similar way the general problem formulated in the beginning of the section, choose a collection ω of $\frac{d(d+3)}{2} - \delta = 3d - 1 + g$ points in general position in $\mathbb{C}P^2$, where $\delta = \frac{(d-1)(d-2)}{2} - g$. The expression “*in a general position*” can be made precise in the following way. Denote by $S_d(\delta)$ the subset of $\mathbb{C}C_d$ formed by the points corresponding to irreducible curves of degree d satisfying the following property: each of these curves has δ non-degenerate double points and no other singularities (such curves are called *nodal*). The *Severi variety* $\overline{S}_d(\delta)$ is the closure of $S_d(\delta)$ in $\mathbb{C}C_d$. It is an algebraic variety of codimension δ in $\mathbb{C}C_d$. The smooth part of $\overline{S}_d(\delta)$ contains $S_d(\delta)$ (see, for example, [Zar82]). We say that the points of ω are *in a general position* (or that ω is *generic*) if the following hold,

- the dimension of the projective subspace $\Pi(\omega) \subset \mathbb{C}C_d$ defined by the points of ω is equal to δ ;
- the intersection $\Pi(\omega) \cap \overline{S}_d(\delta)$ is contained in $S_d(\delta)$;
- and the above intersection is transverse.

It can be proved (see, for example, [KP99]) that the generic collections form an open dense subset in the space of all collections of $\frac{d(d+3)}{2} - \delta$ points in $\mathbb{C}P^2$. If ω is generic, any irreducible curve of degree d and genus g in $\mathbb{C}P^2$ which passes through the points of ω corresponds to a point of $\Pi(\omega) \cap \overline{S}_d(\delta)$. Thus, the number $N_{d,g}$ coincides with the degree of the Severi variety $\overline{S}_d(\delta)$.

Remark 4.4. Since we consider generic collections $\omega \subset \mathbb{C}P^2$, we can restrict ourselves to the situation where all points of ω are contained in the complex torus $(\mathbb{C}^\times)^2 \subset \mathbb{C}P^2$; then, $N_{d,g}$ becomes the number of irreducible nodal curves in $(\mathbb{C}^\times)^2$ which pass through the points of ω , are defined by polynomials of degree d in two variables and have $\delta = \frac{(d-1)(d-2)}{2} - g$ double points.

The numbers $N_{d,g}$ are *Gromov-Witten invariants* of $\mathbb{C}P^2$. The number $N_d = N_{d,0}$ is the number of rational curves of degree d which pass through a generic collection of $3d-1$ points in $\mathbb{C}P^2$. A recursive formula for the numbers N_d , was found by M. Kontsevich (see [KM94]). A recursive formula that allows one to calculate all numbers $N_{d,g}$ was obtained by L. Caporaso and J. Harris [CH98].

The enumerative problem discussed above can as well be considered over the real numbers. Consider a collection ω of $3d-1+g$ points in general position in the real projective plane $\mathbb{R}P^2$. This time, the number $R_{d,g}(\omega)$ of irreducible **real** curves of degree d and genus g which pass through the points of ω , in general, depends on ω . For example, for $d=3$ and $g=0$, the number $R_{d,g}(\omega)$ can take values 8, 10, and 12 (see [DK00], or Example 4.8).

J.-Y. Welschinger suggested to treat real curves differently for enumeration, so that some real curves are counted with multiplicity +1 and some with multiplicity -1. He proved that the result is invariant on the choice of points in general position in the case $g=0$ (see [Wel05]). To define the Welschinger signs, recall that all the curves under enumeration are nodal. A real non-degenerate double point of a nodal real curve \mathcal{C} can be

- *hyperbolic* (*i.e.*, intersection of two real branches of the curve, see Figure 19a),
- or *elliptic* (*i.e.*, intersection of two imaginary conjugated branches, see Figure 19b).

Denote by $s(\mathcal{C})$ the number of elliptic double points of \mathcal{C} .

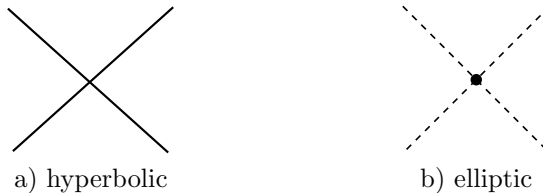

FIGURE 19. Two types of real nodes

Theorem 4.5 (Welschinger, [Wel05]). Let ω be a collection of $3d-1$ points in general position in $\mathbb{R}P^2$. The number

$$W_d(\omega) = \sum_{\mathcal{C}} (-1)^{s(\mathcal{C})},$$

where the sum runs over all real rational curves of degree d in $\mathbb{R}P^2$ which pass through the points of ω , does not depend on the choice of (generic) collection ω .

The number $W_d(\omega)$ is denoted by W_d , and is called *Welschinger invariant*. Notice that the absolute value of W_d provides a lower bound for the numbers $R_{d,0}(\omega)$.

Remark 4.6. More generally we could have chosen a real collection of points in $\mathbb{C}P^2$, *i.e.* a collection made of real points and pairs of complex conjugated points. In this more general situation, Welschinger proved in [Wel05] that the signed enumeration of real rational curves given in Theorem 4.5 only depends on d and on the number of real points in ω . For the sake of simplicity, we consider here only the case $\omega \subset \mathbb{R}P^2$.

Example 4.7. Since rational curves of degree 1 and 2 in $\mathbb{C}P^2$ are non-singular, we have $W_1 = W_2 = 1$.

Example 4.8. Adapting to the real setting the calculation performed in Example 4.2, we can compute W_3 . A collection ω of 8 points in general position in $\mathbb{R}P^2$ defines a pencil $\mathbb{R}\mathcal{P}$ of real cubics which pass through all the points of ω . In particular, the 9 intersection points of all cubics in \mathcal{P} are real. Let $\widetilde{\mathbb{R}P^2}$ be the real projective plane $\mathbb{R}P^2$ blown up at these 9 points. The Euler characteristic $\chi(\widetilde{\mathbb{R}P^2})$ of $\widetilde{\mathbb{R}P^2}$ is equal to $1 - 9 = -8$. On the other hand, the calculation of the Euler characteristic of $\widetilde{\mathbb{R}P^2}$ via the pencil $\mathbb{R}\mathcal{P}$ gives $\chi(\widetilde{\mathbb{R}P^2}) = -W_3$. Thus $W_3 = 8$.

The lower bound 8 for the number of real rational cubics passing through 8 points in general position in $\mathbb{R}P^2$ is sharp and was proved by V. Kharlamov before the discovery of the Welschinger invariants (see, for example, [DK00]). Using floor diagrams (see Section 4.4), E. Rey showed that the lower bound provided by the Welschinger invariant W_4 is also sharp. It is not known whether the lower bounds provided by W_d , $d \geq 5$ are sharp.

The values of W_d with $d \geq 4$ are more difficult to calculate; the first calculation of the numbers W_d for $d \geq 4$ was obtained via tropical geometry.

Note that the enumeration of real curves with Welschinger signs does not give rise to an invariant count if $g > 0$ (see [Wel05, IKS03]).

4.2. Enumeration of tropical curves

The above enumerative problem can be also considered over the tropical semi-field. Since we did not yet introduce the notion of *tropical projective plane*, as well as the notion of *genus* for tropical curves (these notions are respectively introduced in Section 7.3 and in Definition 7.7), we reformulate our problem similarly to Remark 4.4 and consider tropical curves in the tropical torus $\mathbb{R}^2 = (\mathbb{T}^\times)^2$.

A tropical curve C in \mathbb{R}^2 is said to be *irreducible* if it is not a union of two tropical curves, both different from C . A tropical curve C in \mathbb{R}^2 is called *nodal* if each unbounded edge of C is of weight 1 and each polygon of the subdivision dual to C is either a triangle or a parallelogram. We define the *number of double points* of a nodal tropical curve C of degree d in \mathbb{R}^2 to be equal to $I(C) + P(C)$, where $I(C)$ is the number of integer points of the triangle $\text{Conv}\{(0,0), (d,0), (0,d)\} \subset \mathbb{R}^2$ which are not vertices of the subdivision dual to C , and $P(C)$ is the number of parallelograms in the dual subdivision. For any irreducible nodal tropical curve C having exactly δ double points in \mathbb{R}^2 , we can define the genus g of C putting $g = \frac{(d-1)(d-2)}{2} - \delta$ (cf. the definition of genus of a tropical curve at the end of Section 7.1). In the case of genus 0, we speak about *rational* tropical curves.

Example 4.9. A non-singular tropical curve whose Newton polygon is the triangle with vertices $(0, 0)$, $(d, 0)$, and $(0, d)$ has genus $\frac{(d-1)(d-2)}{2}$ (compare with Exercise 3(1)).

Example 4.10. The tropical curves depicted in Figures 2a, b are irreducible, nodal, and rational. This is also the case for the tropical curves in Figures 5b,c. The tropical curve depicted in Figure 5a is irreducible, nodal, and has genus 1.

For different choices of $3d - 1 + g = \frac{d(d+3)}{2} - \delta$ points in general position in \mathbb{R}^2 , the numbers of irreducible nodal tropical curves of degree d which pass through these points and have δ double points can be different. Nevertheless, these tropical curves may be prescribed multiplicities in such a way that the resulting numbers are invariant. Consider a collection ω of $3d - 1 + g = \frac{d(d+3)}{2} - \delta$ points in general position in \mathbb{R}^2 . Let C be an irreducible nodal tropical curve of degree d such that C passes through the points of ω and has δ double points (*i.e.*, has genus g). Each vertex of C is either trivalent (dual to a triangle) or four-valent (dual to a parallelogram). To each trivalent vertex v of such a tropical curve C we associate two numbers:

- $m_{\mathbb{C}}(v)$ equal to twice the Euclidean area of the dual triangle;
- $m_{\mathbb{R}}(v)$ equal to 0 if $m_{\mathbb{C}}(v)$ is even and $(-1)^{i(v)}$ if $m_{\mathbb{C}}(v)$ is odd, where $i(v)$ is the number of integer points in the interior of the triangle dual to v .

Put

$$m_{\mathbb{C}}(C) = \prod_v m_{\mathbb{C}}(v),$$

$$m_{\mathbb{R}}(C) = \prod_v m_{\mathbb{R}}(v),$$

where the products are taken over all trivalent vertices of C .

Theorem 4.11 (Mikhalkin's correspondence theorem, [Mik05]). *Let ω be a collection of $3d - 1 + g$ points in general position in \mathbb{R}^2 . Then,*

- (1) *the number of irreducible nodal tropical curves C of degree d and genus g in \mathbb{R}^2 , counted with multiplicities $m_{\mathbb{C}}(C)$, which pass through the points of ω is equal to $N_{d,g}$;*
- (2) *if $g = 0$, then the number of irreducible nodal rational tropical curves C of degree d in \mathbb{R}^2 , counted with multiplicities $m_{\mathbb{R}}(C)$, which pass through the points of ω is equal to W_d .*

Example 4.12. For each integer $1 \leq d \leq 3$, we depicted in Figure 20 a generic collection of $\frac{d(d+3)}{2}$ points in \mathbb{R}^2 and the unique nodal tropical curve C of degree d and genus $\frac{(d-2)(d-1)}{2}$ which passes through the points of the chosen collection. In each case we have $m_{\mathbb{C}}(C) = m_{\mathbb{R}}(C) = 1$, and Theorem 4.11 gives $N_{1,0} = N_{2,0} = N_{3,1} = W_1 = W_2 = 1$.

Example 4.13. We depicted in Figure 21 the rational nodal tropical cubics that pass through the points of a given generic collection of 8 points in \mathbb{R}^2 . For each curve, we precise its real and complex multiplicities (as well as the multiplicity G which will be

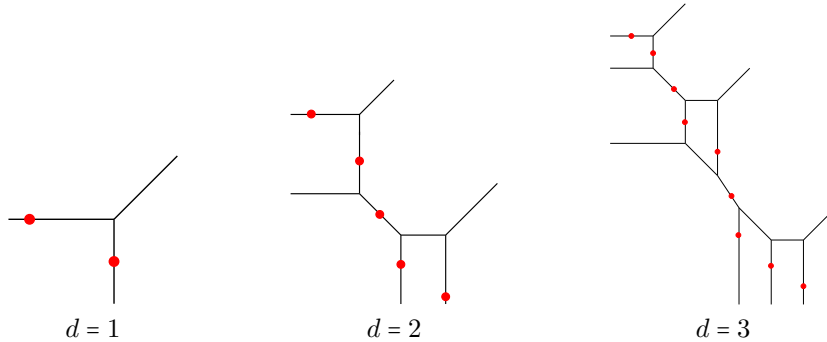

FIGURE 20

defined in Section 4.3). In particular, using Theorem 4.11, we obtain again $N_{3,0} = 12$ and $W_3 = 8$.

4.3. Quantum enumeration of tropical curves

As we saw in the previous section, the numbers $N_{d,g}$ and W_d can be expressed in terms of certain tropical invariants. It turned out that there are many other enumerative tropical invariants (and complex/real analogs for most of them are unknown). For example, in the tropical world Welschinger invariants exist in arbitrary genus.

Theorem 4.14 ([IKS04]). Let ω be a collection of $3d - 1 + g$ points in general position in \mathbb{R}^2 . Then, the number of irreducible nodal tropical curves C of degree d and genus g in \mathbb{R}^2 , counted with multiplicities $m_{\mathbb{R}}(C)$, which pass through the points of ω does not depend on the choice of a (generic) collection ω .

Denote by $W_{d,g}^{trop}$ the invariant provided by Theorem 4.14. This theorem can be generalized in the following way.

F. Block and L. Göttsche [BG14] proposed a new type of multiplicities for tropical curves (a motivation for these multiplicities is provided by a Caporaso-Harris type calculation of the refined Severi degrees; the latter degrees were introduced by Göttsche in connection with [KST11]). Consider again a collection ω of $3d - 1 + g$ points in general position in \mathbb{R}^2 , and let C be an irreducible nodal tropical curve of degree d and genus g which pass through the points of ω . To each trivalent vertex v of C we associate

$$G(v) = \frac{q^{m_C(v)/2} - q^{-m_C(v)/2}}{q^{1/2} - q^{-1/2}}.$$

Put

$$G(C) = \prod_v G(v).$$

where the product is taken over all trivalent vertices of C . The value of the Block-Göttsche multiplicity $G(C)$ at $q = 1$ is $m_{\mathbb{C}}(C)$. It is not difficult to check that the value of $G(C)$

Brief introduction to tropical geometry

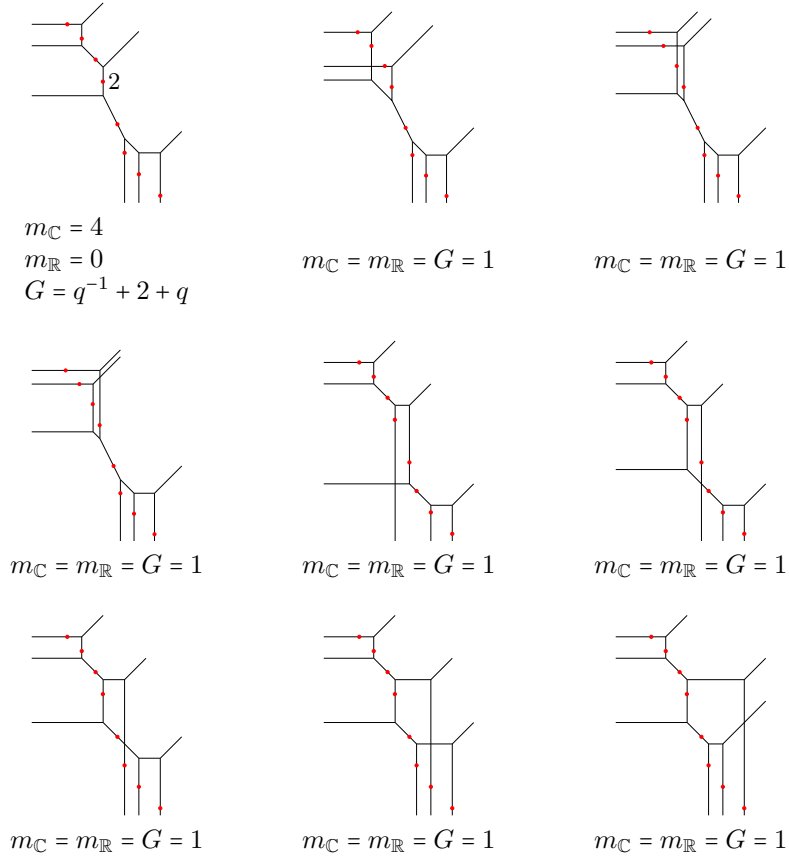

FIGURE 21

at $q = -1$ is equal to $m_{\mathbb{R}}(C)$, so the Block-Göttsche multiplicities interpolate between the complex and real multiplicities for tropical curves.

Theorem 4.15 ([IM13]). Let ω be a collection of $3d - 1 + g$ points in general position in \mathbb{R}^2 . Then, the sum of the Block-Göttsche multiplicities $G(C)$ over the irreducible nodal tropical curves C of degree d and genus g in \mathbb{R}^2 which pass through the points of ω does not depend on the choice of a (generic) collection ω .

Denote by $G_{d,g}$ the invariant provided by Theorem 4.15. Again, we have $G_{d,g} = 0$ whenever $g > \frac{(d-1)(d-2)}{2}$.

Example 4.16. We have $G_{1,0} = G_{2,0} = G_{3,1} = 1$ (see Figure 20). More generally, one easily shows that

$$G_{d, \frac{(d-1)(d-2)}{2}} = 1.$$

Example 4.17. We have (see Figure 21)

$$G_{3,0} = q^{-1} + 10 + q.$$

Example 4.18. Using the technique of floor diagrams, presented in the next section, one can compute the invariants $G_{4,g}$:

$$\begin{aligned} G_{4,2} &= 3q^{-1} + 21 + 3q, \\ G_{4,1} &= 3q^{-2} + 33q^{-1} + 153 + 33q + 3q^2, \\ G_{4,0} &= q^{-3} + 13q^{-2} + 94q^{-1} + 404 + 94q + 13q^2 + q^3. \end{aligned}$$

Each coefficient of $G_{d,g}$ is an integer valued tropical invariant. The sum of these coefficients is equal to $N_{d,g}$, and the alternating sum of the coefficients of $G_{d,g}$ is equal to $W_{d,g}^{trop}$. It is not clear what is a complex enumerative interpretation of individual coefficients of $G_{d,g}$.

Theorem 4.15 has the following corollary.

Corollary 4.19 (cf. [IM13]). *Fix a non-negative integer g and a positive integer k . Then, for any sufficiently large integer d and any generic collection ω of $3d - 1 + g$ points in \mathbb{R}^2 , there exists an irreducible nodal tropical curve C of degree d and genus g in \mathbb{R}^2 such that C passes through the points of ω and $m_{\mathbb{C}}(C) \geq k$.*

4.4. Floor diagrams

Theorem 4.11 reduces the problem of enumeration of complex (or real) curves to calculation of the corresponding tropical invariants. One of the most efficient techniques for computation of enumerative tropical invariants (and, in particular, Gromov-Witten invariants $N_{d,g}$ and Welschinger invariants W_d) is based on so-called *floor diagrams*. Floor diagrams are related to the Caporaso-Harris approach [CH98]; we refer to [Bru14] for more details.

Definition 4.20. A (plane) floor diagram of degree d and genus g is the data of a connected oriented graph \mathcal{D} (considered as a topological object; edges of \mathcal{D} are not necessarily compact) which satisfy the following conditions:

- the oriented graph \mathcal{D} is acyclic;
- \mathcal{D} has exactly d vertices;
- the first Betti number $b_1(\mathcal{D})$ of \mathcal{D} is equal to g ;
- each edge has a weight which is a positive integer number;
- there are exactly d non-compact edges of \mathcal{D} ; all of them are of weight 1 and are oriented towards their unique adjacent vertex;
- for each vertex of \mathcal{D} , the sum of weights of incoming edges is greater by 1 than the sum of weights of outgoing edges.

A floor diagram inherits a partial ordering from its orientation. A map m between two partially ordered sets is said to be *increasing* if

$$m(i) > m(j) \Rightarrow i > j.$$

Definition 4.21. A marking of a floor diagram \mathcal{D} of degree d and genus g is an increasing map $m : \{1, \dots, 3d - 1 + g\} \rightarrow \mathcal{D}$ such that for any edge or vertex x of \mathcal{D} , the set $m^{-1}(x)$ consists of exactly one element. A floor diagram enhanced with a marking is called a marked floor diagram.

We consider the floor diagrams up to a natural equivalence: two floor diagrams \mathcal{D} and \mathcal{D}' are equivalent if there exists a homeomorphism of oriented graphs \mathcal{D} and \mathcal{D}' which respects the weights of all edges. Similarly, two marked floor diagrams (\mathcal{D}, m) and (\mathcal{D}', m') are equivalent if there exists a homeomorphism of oriented graphs $\varphi : \mathcal{D} \rightarrow \mathcal{D}'$ which respects the weights of all edges and such that $m' = \varphi \circ m$.

Example 4.22. Figure 22 shows all floor diagrams (up to equivalence) of degree at most 3 and indicates for each of them the number of possible markings. Similarly, Figures 23, 24, and 25 show all floor diagrams of degree 4.

We use the following convention to depict floor diagrams: vertices of \mathcal{D} are represented by white ellipses, edges are represented by vertical lines, and the orientation is implicitly from down to up. We specify the weight of an edge only if this weight is at least 2.

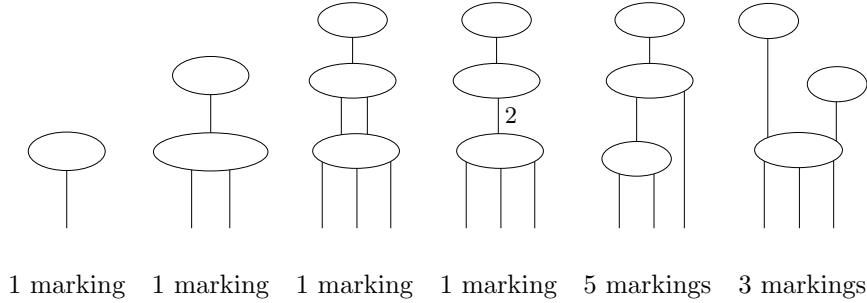

FIGURE 22. Floor diagrams of degree ≤ 3

To each floor diagram \mathcal{D} of degree d and genus g we can associate its complex, real and Block-Göttsche multiplicities putting, respectively,

$$m_{\mathbb{C}}(\mathcal{D}) = \prod_e (w(e))^2,$$

$$m_{\mathbb{R}}(\mathcal{D}) = \prod_e r(e),$$

$$G(\mathcal{D}) = \prod_e \left(\frac{q^{w(e)/2} - q^{-w(e)/2}}{q^{1/2} - q^{-1/2}} \right)^2,$$

where the products are taken over all edges e of \mathcal{D} , the number $w(e)$ is the weight of e , and $r(e)$ is equal to 0 if $w(e)$ is even and is equal to 1 otherwise. Note that $m_{\mathbb{C}}(\mathcal{D})$ is the value of $G(\mathcal{D})$ at $q = 1$, and $m_{\mathbb{R}}(\mathcal{D})$ is the value of $G(\mathcal{D})$ at $q = -1$.

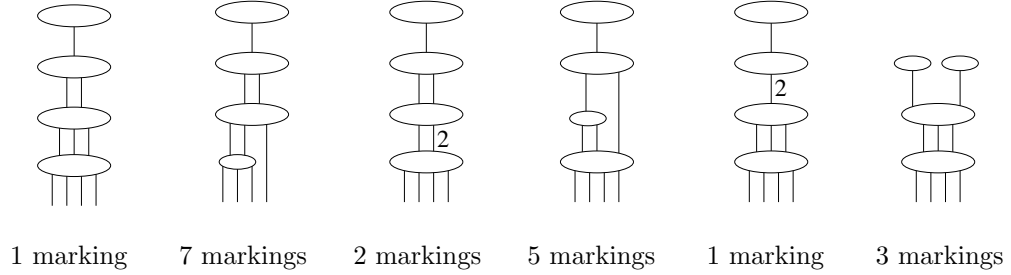

FIGURE 23. Floor diagrams of degree 4 and genus 3 or 2

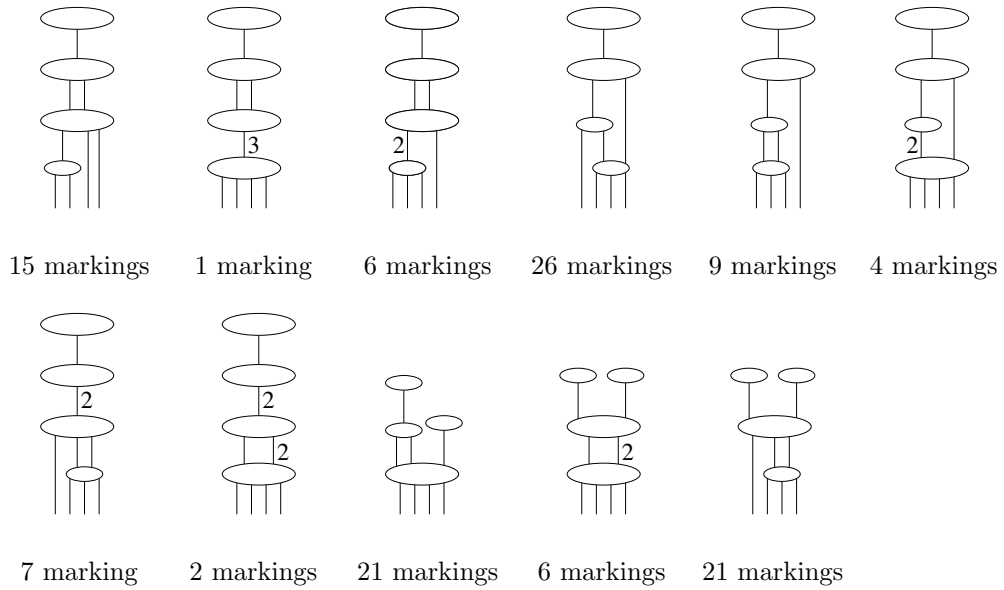

FIGURE 24. Floor diagrams of degree 4 and genus 1

Let us relate floor diagrams to enumeration of tropical curves. A collection ω of $3d-1+g$ points in \mathbb{R}^2 is said to be *vertically stretched* if the absolute value of the difference between the second coordinates of any two of these points is much larger than the absolute value of the difference between the first coordinates of any two of the points considered (in other words, all points of ω are in a very narrow strip $[a, a + \varepsilon] \times \mathbb{R}$). Fix a vertically stretched collection ω of $3d-1+g$ points in \mathbb{R}^2 , and associate to the points of ω the numbers $1, \dots, 3d-1+g$ in such a way that higher point always has a larger number. Given an irreducible

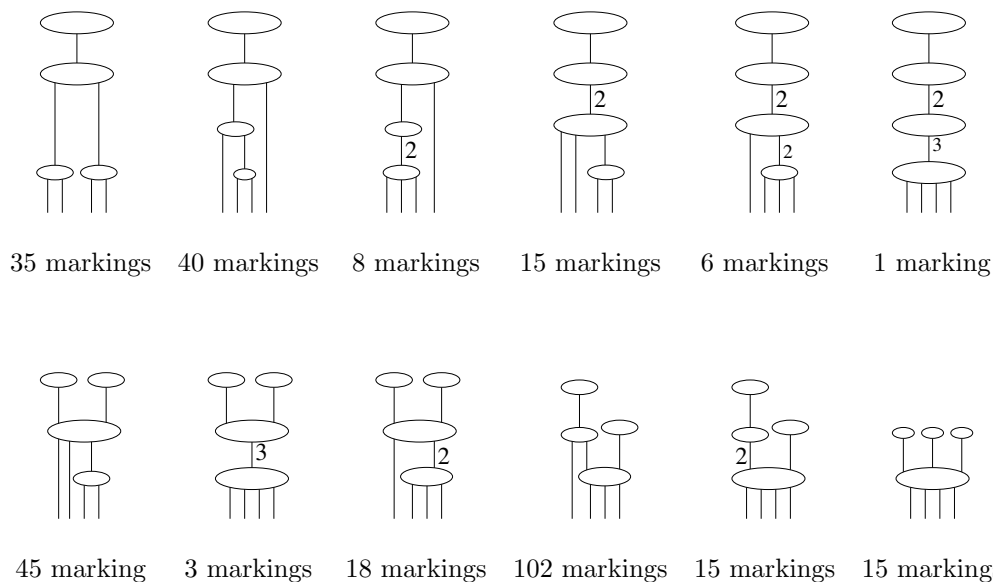

FIGURE 25. Floor diagrams of degree 4 and genus 0

nodal tropical curve of degree d and genus g in \mathbb{R}^2 such that C passes through the points of ω , one can show that each vertical edge (an *elevator*) of C , as well as each connected component (a *floor*) of the complement in C of the union of interiors of elevators, contains exactly one point of ω (see Figures 20, 21, and 26).

Contracting each floor of C , we obtain a weighted graph whose edges correspond to vertical edges of C ; orient these edges in the direction of increasing of the second coordinate. As it was shown by E. Brugallé and Mikhalkin [BM08], the result is a floor diagram of degree d and genus g , and the $3d - 1 + d$ points in ω provide a marking of this floor diagram (see Figure 26). Conversely, any marked floor diagram of degree d and genus g corresponds to exactly one irreducible tropical curve of degree d and genus g passing through the points of ω . This leads to the following statement (which is an immediate generalization of a theorem proved in [BM08]).

Theorem 4.23 (cf. [BM08]). One has

$$G_{d,g} = \sum_{\mathcal{D}} G(\mathcal{D}),$$

where the sum is taken over all marked floor diagrams \mathcal{D} of degree d and genus g .

Example 4.24. Combining Theorem 4.23 with the lists of Figures 22,23, 24, and 25, we obtain the values of $G_{d,g}$ given in Examples 4.16, 4.17, and 4.18.

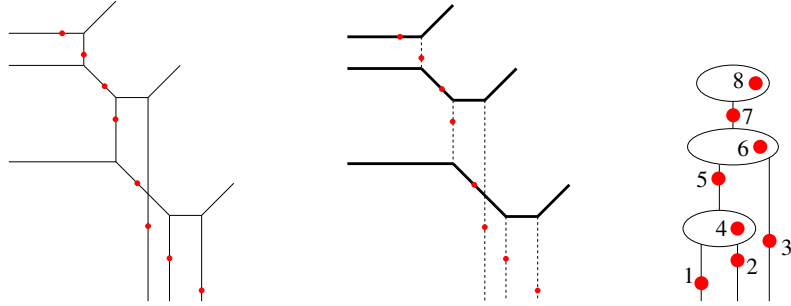

FIGURE 26. From tropical curves to floor diagrams

Theorem 4.23 immediately implies the following formulas for $N_{d,g}$ and $W_{d,g}^{trop}$:

$$N_{d,g} = \sum_{\mathcal{D}} m_{\mathbb{C}}(\mathcal{D}), \quad W_{d,g}^{trop} = \sum_{\mathcal{D}} m_{\mathbb{R}}(\mathcal{D}),$$

where the sums are again taken over all marked floor diagrams \mathcal{D} of degree d and genus g .

Beyond providing an efficient tool for explicit computations of enumerative invariants, floor diagrams also turned out to be a powerful technique in the study of (piecewise-)polynomial behaviour of Gromov-Witten invariants of complex surfaces, see for example [FM10, Blo11, AB13, LO14, AB14].

Exercises 4.

- (1) Fix a positive integer d , and put $g = \frac{(d-1)(d-2)}{2} - 1$. By adapting the approach used in Examples 4.2 and 4.8, prove that

$$N_{d,g} = 3(d-1)^2,$$

and that the quantity

$$\sum_C (-1)^{s(C)}$$

from Theorem 4.5 depends on ω for $d \geq 4$.

- (2) Fix a positive integer d . It is clear from the definition that the numbers W_d and N_d are equal modulo 2. Prove that

$$W_d = N_d \pmod{4}.$$

- (3) Show that either 9 or 10 distinct rational tropical cubics pass through a given generic configuration of 8 points in \mathbb{R}^2 .
 (4) With the help of Figures 23, 24, and 25, work out the computations of Example 4.18.
 (5) Fix a positive integer d . Using floor diagrams, prove that

$$G_{d, \frac{(d-1)(d-2)}{2}} = 1 \quad \text{and} \quad G_{d, \frac{(d-1)(d-2)}{2} - 1} = (d-1) \cdot \left[\frac{d-2}{2} \cdot q^{-1} + 2d-1 + \frac{d-2}{2} \cdot q \right].$$

- (6) Fix a positive integer d and an integer $0 \leq g \leq \frac{(d-1)(d-2)}{2}$. Prove that the highest power of q which appears in $G_{d,g}$ is $\frac{(d-1)(d-2)}{2} - g$, and that the coefficient of the corresponding monomial of $G_{d,g}$ is equal to

$$\binom{\frac{(d-1)(d-2)}{2}}{g}.$$

5. Tropical subvarieties of \mathbb{R}^n and \mathbb{T}^n

We focused so far on plane tropical curves. In this section we define tropical subvarieties of higher dimension and codimension in \mathbb{R}^n . We have seen three equivalent definitions of a tropical curve in \mathbb{R}^2 :

- (1) an algebraic one via tropical polynomials;
- (2) a combinatorial one via balanced graphs;
- (3) a geometric one via limits of amoebas.

All these three definitions can be generalized to arbitrary dimensions. In the case of tropical hypersurfaces of \mathbb{R}^n , all these three definitions remain equivalent. Moreover, the proof that these yield equivalent definitions is exactly the same as for tropical curves in \mathbb{R}^2 . However, these three definitions produce different objects in higher codimension.

5.1. Tropical hypersurfaces of \mathbb{R}^n

As stated above, the situation for tropical hypersurfaces is entirely similar to the case of tropical curves in \mathbb{R}^2 . Let n be a positive integer number. A tropical hypersurface in \mathbb{R}^n is defined by a tropical polynomial in n variables

$$P(x_1, \dots, x_n) = \sum_{i \in A} a_i x^i = \max_{i \in A} \{a_i + \langle x, i \rangle\},$$

where $A \subset (\mathbb{Z}_{\geq 0})^n$ is a finite subset, $x^i = x_1^{i_1} x_2^{i_2} \dots x_n^{i_n}$, and $\langle x, i \rangle$ denotes the standard inner product in \mathbb{R}^n . As usual we are interested only in the function defined by P , and not in the polynomial expression. Once again P is a piecewise integer affine function on \mathbb{R}^n , and the definition from Section 2.1 of the set $\tilde{V}(P)$ for tropical curves generalizes directly to higher dimensions:

$$\tilde{V}(P) = \{x \in \mathbb{R}^n \mid \exists i \neq j, \quad P(x) = "a_i x^i" = "a_j x^j"\}.$$

The set $\tilde{V}(P)$ is a finite union of convex polyhedral domains of dimension $n - 1$ forming a polyhedral complex (see Section 5.2), and its facets are equipped with a weight in the same way as in Definition 2.2. The *tropical hypersurface defined by P* , denoted by $V(P)$, is the set $\tilde{V}(P)$ equipped with this weight function on the facets.

Example 5.1. The tropical hypersurface of \mathbb{R}^3 defined by the tropical polynomial

$$P(x, y, z) = "x + z + 0"$$

is a cylinder in the y -direction. It is formed by the three facets

$$\begin{aligned} F_1 &: z = 0 \text{ and } x \leq 0 \\ F_2 &: x = 0 \text{ and } z \leq 0 \\ F_3 &: x = z \text{ and } x \geq 0 \end{aligned}$$

that meet along the line E with equation $x = z = 0$, and equipped with the constant weight function equal to 1 (see Figure 27a).

Example 5.2. Consider the linear tropical polynomial

$$P(x_1, \dots, x_n) = "a_1x_1 + \dots + a_nx_n + a_0".$$

The tropical hyperplane $V(P)$ is a fan of dimension $n-1$ equipped with weight one on all of its facets. Any such facet has the point $(a_0 - a_1, \dots, a_0 - a_n)$ as vertex, and is generated by $n-1$ of the vectors

$$(-1, 0, \dots, 0), (0, -1, 0, \dots, 0), \dots, (0, \dots, 0, -1), (1, \dots, 1).$$

Conversely, any $n-1$ elements of this set of $n+1$ vectors define a facet of $V(P)$. If $n=2$, we have again a tropical line in the plane (cf. Example 2.1). A tropical plane in \mathbb{R}^3 is depicted in Figure 27b. Such a tropical plane has 4 rays, in the directions

$$(-1, 0, 0), (0, -1, 0), (0, 0, -1), (1, 1, 1),$$

and 6 top dimensional faces, one spanned by each pair of rays.

Example 5.3. A tropical quadric surface in \mathbb{R}^3 is depicted in Figure 27c.

Just as described in Section 2.2 for tropical curves in \mathbb{R}^2 , any tropical polynomial P induces a subdivision of its Newton polygon

$$\Delta(P) = \text{Conv}(\{i \in (\mathbb{Z}_{\geq 0})^n \mid a_i \neq -\infty\}) \subset \mathbb{R}^n.$$

The tropical hypersurface $V(P)$ is dual to this subdivision in the sense of Proposition 2.5. By this duality, a top dimensional face F of $V(P)$ is dual to an edge e of the subdivision of $\Delta(P)$, and the weight of F is equal to the lattice length of e . As a result, the tropical hypersurface satisfies a generalization of the balancing condition from Section 2.3 along the faces of dimension $n-2$. Let E be a face of dimension $n-2$ of $V(P)$, and let F_1, \dots, F_k be the faces of dimensions $n-1$ of $V(P)$ that are adjacent to E . Denote by w_1, \dots, w_k the weights of F_1, \dots, F_k . Let $v_i, i = 1, \dots, k$, be the primitive integer vector orthogonal to E and such that $x + \varepsilon v_i \in F_i$ if $x \in E$ and $1 \gg \varepsilon > 0$.

Proposition 5.4 (Balancing condition for tropical hypersurfaces). *One has*

$$\sum_{i=1}^k w_i v_i = 0.$$

The converse holds, *i.e.* Theorem 2.9 generalizes to tropical hypersurfaces of \mathbb{R}^n .

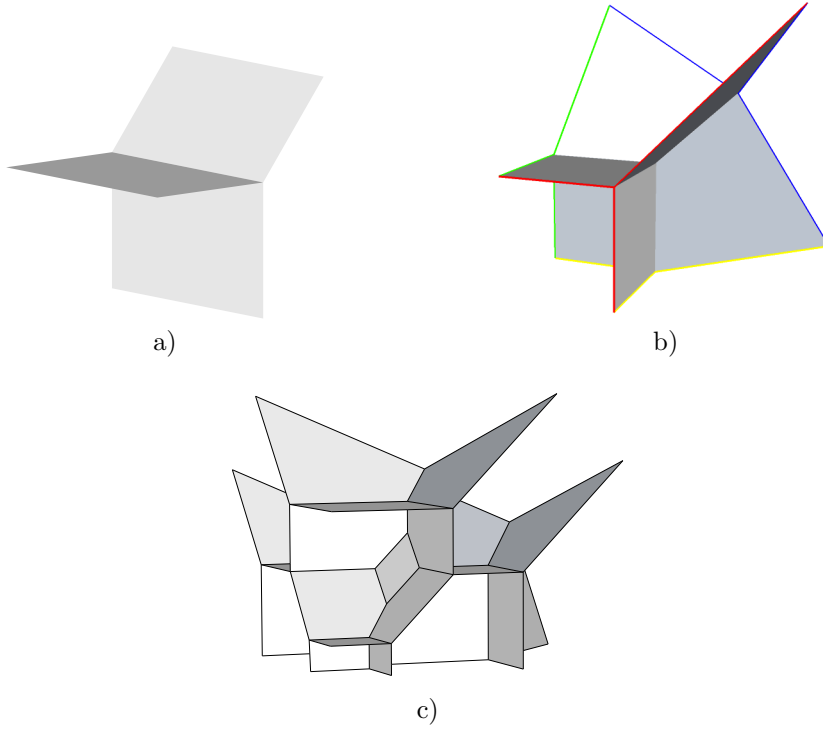

FIGURE 27. Two tropical planes in a) and b) and a tropical quadric in \mathbb{T}^3 in c).

Example 5.5. For the tropical surfaces of Example 5.1 we have

$$v_1 = (-1, 0, 0), \quad v_2 = (0, 0, -1), \quad v_3 = (1, 0, 1),$$

and $v_1 + v_2 + v_3 = 0$.

As in the case of curves, any tropical hypersurface of \mathbb{R}^n is the limit of amoebas of algebraic hypersurfaces of $(\mathbb{C}^\times)^n$. The next theorem generalizes Theorem 2.12.

Theorem 5.6. (cf. [Kap00, Mik04b]) *Let $P_t(z_1, \dots, z_n) = \sum_i \alpha_i(t) z^i$ be a polynomial whose coefficients are functions $\alpha_i : \mathbb{R} \rightarrow \mathbb{C}$, and suppose that $\alpha_i(t) \sim \gamma_i t^{a_i}$ when t goes to $+\infty$ with $\gamma_i \in \mathbb{C}^\times$ and $a_i \in \mathbb{T}$. If \mathcal{V}_t denotes the hypersurface in $(\mathbb{C}^\times)^n$ defined by the polynomial $P_t(z)$, then the amoeba $\text{Log}_t(\mathcal{V}_t)$ converges to the tropical hypersurface of \mathbb{R}^n defined by the tropical polynomial $P_{\text{trop}}(x) = \sum_i a_i x^i$.*

A tropical hypersurface is said to be *non-singular* if any top dimensional cell of its dual subdivision has Euclidean volume $\frac{1}{n!}$, as the standard simplex in \mathbb{R}^n . Equivalently,

a tropical hypersurface is non-singular if each vertex has a neighborhood which is the same, up to translations and the action of $GL_n(\mathbb{Z})$, as a neighborhood of the tropical hyperplane from Example 5.2. More generally, a non-singular tropical subvariety of \mathbb{R}^n locally looks like a tropical linear space. We treat these objects in Section 5.4.

5.2. Tropical subvarieties of \mathbb{R}^n

A k -dimensional *finite polyhedral complex* in \mathbb{R}^n is the union of finitely many k -dimensional convex polyhedral domains $F_1, \dots, F_s \subset \mathbb{R}^n$ (each F_j is the intersection of some half-spaces in \mathbb{R}^n) such that the intersection of two polyhedra F_i and F_j is either empty or a face of both F_i and F_j . We define tropical subvarieties of \mathbb{R}^n by generalizing the above balancing condition to finite polyhedral complexes of any dimension in \mathbb{R}^n . A finite polyhedral complex $V \subset \mathbb{R}^n$ is said to be

- *rational* if for each face $F \subset V$ the integer vectors tangent to F form a lattice of rank equal to $\dim F$;
- *weighted* if each of the top dimensional faces of V is equipped with a *weight* that is an integer.

Definition 5.7 (General balancing condition in \mathbb{R}^n). Let V be a weighted rational finite polyhedral complex of dimension k in \mathbb{R}^n , and let $E \subset V$ be a codimension one face of V . Let F_1, \dots, F_s be the facets adjacent to E , and let $\Lambda_{F_i} \subset \mathbb{Z}^n$ denote the lattice parallel to F_i , (analogously for Λ_E). Let v_i be a primitive integer vector such that, together v_i and Λ_E generate Λ_{F_i} , and for any $x \in E$, one has $x + \varepsilon v_i \in F_i$ for $1 \gg \varepsilon > 0$. We say that V is *balanced* along E if the vector

$$\sum_{i=1}^s w_{F_i} v_i$$

is in Λ_E , where w_{F_i} is the weight of the facet F_i .

Using this we introduce the definition of a tropical subvariety of \mathbb{R}^n .

Definition 5.8. A *tropical cycle* V of \mathbb{R}^n of dimension k is a k -dimensional weighted rational finite polyhedral complex which is balanced along every codimension one face.

A tropical cycle of \mathbb{R}^n equipped with non-negative integer weights is called *effective*, or also a *tropical subvariety* of \mathbb{R}^n .

Example 5.9. A tropical curve in \mathbb{R}^2 is precisely a balanced graph as defined in Section 2.3. Note that this definition from Section 2.3 generalizes immediately to any weighted rectilinear graph in \mathbb{R}^n with rational slopes, and this generalization is again equivalent to Definition 5.8.

In the case of tropical subvarieties of \mathbb{R}^n of dimension $n-1$, Definition 5.8 is equivalent to the definition of tropical hypersurfaces of \mathbb{R}^n we gave in Section 5.1.

Example 5.10. Consider again the tropical surface in \mathbb{R}^3 from Example 5.1. This is indeed a tropical surface in the sense of Definition 5.7, since we have

$$v_1 = (-1, a, 0), \quad v_2 = (0, b, -1), \quad v_3 = (1, c, 1),$$

and so

$$v_1 + v_2 + v_3 = (0, a + b + c, 0)$$

which is parallel to E .

5.3. Tropical limits of algebraic varieties

As in the case of hypersurfaces, families of algebraic subvarieties of $(\mathbb{C}^\times)^n$ are related to tropical subvarieties of \mathbb{R}^n . We briefly indicate below this relation and refer to [IKMZ] for more details.

Let $(\mathcal{V}_t)_{t \in A}$ be a family of proper complex analytic subvarieties of dimension k in $(\mathbb{C}^\times)^n$. Here, $A \subset (1, +\infty)$ is any subset not bounded from above (our main examples are $A = (1, +\infty)$ and $A = \mathbb{Z} \cap (1, +\infty)$). The amoebas $\text{Log}_t(\mathcal{V}_t) \subset \mathbb{R}^n$ form a family of closed subsets.

Definition 5.11. We say that $\text{Log}_t(\mathcal{V}_t)$ *uniformly converges* to a closed subset $V \subset \mathbb{R}^n$ if V is the limit of $\text{Log}_t(\mathcal{V}_t)$ with respect to the Hausdorff metric on closed subsets of the metric space \mathbb{R}^n .

We say that $\text{Log}_t(\mathcal{V}_t)$ *converges* to a closed subset $V \subset \mathbb{R}^n$ if it uniformly converges on compacts in \mathbb{R}^n , *i.e.* for any compact $K \subset \mathbb{R}^n$ the family $K \cap \text{Log}_t(\mathcal{V}_t)$ uniformly converges to $K \cap V$.

We write $V = \lim_{t \rightarrow +\infty} \text{trop } \mathcal{V}_t$ for any of these convergences. It turns out that $\lim_{t \rightarrow +\infty} \text{trop } \mathcal{V}_t$ admits the structure of a rational finite polyhedral complex of dimension k .

Example 5.12. Any linear map $M : \mathbb{Z}^n \rightarrow \mathbb{Z}^m$ is the multiplicative character map for a homomorphism $\Phi_M : (\mathbb{C}^\times)^m \rightarrow (\mathbb{C}^\times)^n$. Also it is (additively) dual to a map $\phi_M : \mathbb{R}^m \rightarrow \mathbb{R}^n$. Amoebas $\text{Log}_t(\Phi_M((\mathbb{C}^\times)^m)) \subset \mathbb{R}^n$ of the constant (independent of t) family Φ_M coincide with $\phi_M(\mathbb{R}^m)$ for any t , so we have

$$\phi_M(\mathbb{R}^m) = \lim_{t \rightarrow +\infty} \text{trop } (\Phi_M((\mathbb{C}^\times)^m)).$$

In this case the tropical limit is a k -dimensional linear subspace of \mathbb{R}^n .

Let $V = \lim_{t \rightarrow +\infty} \text{trop } \mathcal{V}_t$ for some family $\mathcal{V}_t \subset (\mathbb{C}^\times)^n$ of k -dimensional varieties. Consider a facet $F \subset V$. Since F is a k -dimensional affine subspace of \mathbb{R}^n we may find an $(n - k)$ -dimensional affine subspace $Y \subset \mathbb{R}^n$ intersecting F transversely in a single generic point p in the relative interior of F and such that the integer vectors tangent to Y and those tangent to F generate the entire lattice \mathbb{Z}^n . We may find a linear map $M : \mathbb{Z}^n \rightarrow \mathbb{Z}^{n-k}$ such that $Y = p + \phi_M(\mathbb{R}^{n-k})$ so that $Y = \lim_{t \rightarrow +\infty} t^p \Phi_M((\mathbb{C}^\times)^{n-k})$, where $t^p(z_1, \dots, z_n) = (t^{p_1} z_1, \dots, t^{p_n} z_n)$.

Definition 5.13. We say that the face $F \subset \lim_{t \rightarrow +\infty} \text{trop } (\mathcal{V}_t)$ is *of weight w* if for any sufficiently small open set $U \ni p$ in \mathbb{R}^n the set

$$t^p \Phi_M((\mathbb{C}^\times)^{n-k}) \cap \mathcal{V}_t \cap \text{Log}_t^{-1}(U)$$

consists of w points (counted with the intersection multiplicities of cycles of complementary dimension) whenever t is sufficiently large. It is a fact that this definition of weight does not depend on the choice of a generic point $p \in F$ or the subspace Y with properties as above.

We say that $V = \lim_{t \rightarrow +\infty} \text{trop } \mathcal{V}_t$ is the *tropical limit* of the family \mathcal{V}_t if all the faces of V acquire a well-defined weight. If the convergence of $\text{Log}_t(V_t)$ is uniform then we say that the tropical limit $V = \lim_{t \rightarrow +\infty} \text{trop } \mathcal{V}_t$ is uniform.

Example 5.14. Suppose that $M : \mathbb{Z}^n \rightarrow \mathbb{Z}^k$ is a homomorphism such that the cokernel group $\mathbb{Z}^k / \text{Im}(M)$ is finite. Then the weight of the affine k -space $\lim_{t \rightarrow +\infty} \Phi_M((\mathbb{C}^\times)^k)$ from Example 5.12 coincides with the cardinality of $\mathbb{Z}^k / \text{Im}(M)$.

The following theorem generalizes Theorems 2.12 and 5.6.

Theorem 5.15 ([IKMZ]). *The tropical limit $\lim_{t \rightarrow +\infty} \text{trop } \mathcal{V}_t$ is a tropical subvariety of \mathbb{R}^n .*

Definition 5.16. A tropical subvariety $V \subset \mathbb{R}^n$ is called *approximable* if there exists a family of complex algebraic subvarieties \mathcal{V}_t of $(\mathbb{C}^\times)^n$ such that $\lim_{t \rightarrow +\infty} \text{trop } \mathcal{V}_t = V$. It is called *uniformly approximable* if the convergence can be made uniform.

The following example illustrates the difference between uniform and conventional (that is uniform only on compacts) tropical convergence. If a family of hypersurfaces $\mathcal{V}_t \subset (\mathbb{C}^\times)^n$ with the Newton polyhedron Δ has the tropical hypersurface $V \subset \mathbb{R}^n$ as its uniform tropical limit, then $\Delta(V) = \Delta$ (up to translation). However, if the convergence is uniform only on compacts, then it might happen that $\Delta(V)$ is strictly smaller than Δ as a part of the hypersurface may escape to infinity.

Example 5.17. The tropical curve in \mathbb{R}^2 defined by the tropical polynomial “ $0 + x$ ” is the tropical limit of the family $(\mathcal{C}_t)_{t \in \mathbb{R}_{>1}}$ of curves in $(\mathbb{C}^\times)^2$ with equation

$$1 + z + t^{-t}w = 0,$$

but is not a uniform tropical limit of this family.

Remark 5.18. Specifying the weights of the facets in the tropical limit as in Definition 5.13 may be further refined. Namely, we can specify a finite covering of degree w for the k -torus $(S^1)^k$ corresponding to each facet F of weight w . This refined weight is essential for consideration of tropical subvarieties, but for the sake of keeping it simple we ignore it in this survey (replacing refined tropical subvarieties with effective tropical cycles). Note though that there is no difference if the weights of all facets are 1.

The weight refinement can be incorporated to the notion of the tropical limit. This refinement may force subdividing facets of the tropical limit to smaller subfacets with different pattern of refined weights. There is a tropical compactness theorem ensuring that any family of algebraic varieties admits a tropically converging subfamily. By passing to a subfamily we can also ensure that the tropical limit in the refined sense exists.

Not every tropical subvariety of \mathbb{R}^n is approximable, as illustrated by the following example. Determining which tropical subvarieties of codimension different from one are approximable is quite difficult, even in the case of curves.

Example 5.19. Consider the plane tropical cubic C of genus 1 depicted in Figure 5a, and draw it in the affine plane with equation $z = 0$ in \mathbb{R}^3 . On each of the three unbounded edges in the direction $(1, 1, 0)$, choose a point in such a way that these three points are not contained in a tropical line in $z = 0$. Now at these three points, replace the unbounded part of C in the direction $(1, 1, 0)$ by two unbounded edges, one in the direction $(0, 0, -1)$ and one in the direction $(1, 1, 1)$ to obtain a spatial tropical cubic \tilde{C} (see Figure 28).

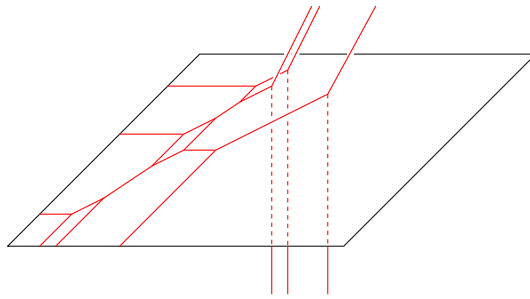

FIGURE 28. A non-approximable tropical spatial cubic curve.

The choice we made of the three points ensure that \tilde{C} is not contained in any tropical hyperplane; since as we saw in Example 5.2, the unbounded rays in the $-e_3$ direction contained in a tropical plane in \mathbb{R}^3 project to a tropical line on the plane $z = 0$. For the sake of simplicity, we show that \tilde{C} is not uniformly approximable *i.e.* there does not exist a family $(\mathcal{C}_t)_{t \in \mathbb{R}_{>1}}$ of spatial elliptic cubics with $\lim_{t \rightarrow +\infty} \text{trop}(\mathcal{C}_t) = \tilde{C}$. The tropical curve \tilde{C} is not approximable even without requiring uniform convergence, however the proof is more involved.

Any spatial algebraic elliptic cubic curve is planar. Hence if an appropriate family $(\mathcal{C}_t)_{t \in \mathbb{R}_{>1}}$ of elliptic cubics exists, each member \mathcal{C}_t would be necessarily contained in a plane \mathcal{P}_t . After passing to a subfamily we may assume that $\lim_{t \rightarrow +\infty} \text{trop} \mathcal{P}_t$ exists. It is a tropical plane that contains $\lim_{t \rightarrow +\infty} \text{trop} \mathcal{C}_t$. However our initial tropical curve is not contained in any tropical plane.

Example 5.19 admits generalisations, see [Spe14, Nis09, BM].

5.4. Linear spaces and hyperplane arrangements

Now we turn to tropical limits of constant families of linear spaces, and more generally to *fan tropical linear spaces*. These objects will make a reappearance in Section 7.1 where

they will play the role of the local models for tropical manifolds. Regarding more general tropical linear spaces which are not necessarily fans, we refer to [Spe08].

Let us start with an affine linear space $\tilde{\mathcal{L}} \subset \mathbb{C}^n$ of dimension k , and assume $\mathcal{L} = \tilde{\mathcal{L}} \cap (\mathbb{C}^\times)^n \subset (\mathbb{C}^\times)^n$ is non-empty. We obtain a natural hyperplane arrangement \mathcal{A} in $\mathbb{C}P^k$ by compactifying \mathcal{L} to $\tilde{\mathcal{L}} \cong \mathbb{C}P^k \subset \mathbb{C}P^n$. This arrangement consists of the intersection of $\tilde{\mathcal{L}}$ with all coordinates hyperplanes in $\mathbb{C}P^n$. Here we give a description of the tropical variety $\limtrop_{t \rightarrow +\infty} \mathcal{L}$. In this case, it turns out that the weights of the top dimensional faces of $\limtrop_{t \rightarrow +\infty} \mathcal{L}$ are all equal to 1.

We already mentioned that given a complex curve \mathcal{C} , the tropical limit $\limtrop_{t \rightarrow +\infty} \mathcal{C}$ has only one vertex and directions corresponding to the asymptotic directions of the amoeba. The same is true for $\limtrop_{t \rightarrow +\infty} \mathcal{L}$. It can be equipped with the structure of a finite polyhedral fan, and the faces record the asymptotic directions. This type of limit for any $\mathcal{V} \subset (\mathbb{C}^\times)^n$ is also known as the Bergman fan of the variety. These objects were considered by G.M. Bergman before the birth of tropical geometry [Ber71].

Proposition 5.20. [Stu02] *Let $\mathcal{L} \subset (\mathbb{C}^\times)^n$ be a linear space, then $\limtrop_{t \rightarrow +\infty} \mathcal{L}$ depends only on the intersection properties of the hyperplanes in \mathcal{A} .*

Let us explain what do we mean by “intersection properties”. A hyperplane arrangement $\mathcal{A} = \{H_0, \dots, H_n\}$ in $\mathbb{C}P^k$ is a stratified space, here we refer to the strata as *flats*. Each flat can be indexed by the maximum subset $I \subset \mathcal{A}$ of hyperplanes which contains it; label such a flat F_I . See Figure 29 for a line arrangement where some of the flats are labeled. The flats form a partially ordered set, the order being given by inclusion and is known as the *lattice of flats* of the arrangement \mathcal{A} . Now a more precise statement of the above proposition is that for a linear space, the set $\limtrop_{t \rightarrow +\infty} \mathcal{L}$ can be determined from the lattice of flats of \mathcal{A} and does not depend on the position of the hyperplanes.

Now we show how to construct the fan $\limtrop_{t \rightarrow +\infty} \mathcal{L}$ explicitly.

Construction 5.1 ([AK06]). Set $v_i = -e_i$ for $i = 1, \dots, n$ and $e_0 = \sum_{i=1}^n e_i$, where e_i are the standard basis of \mathbb{R}^n . For any $I \subset \{0, \dots, n\}$ let $v_I = \sum_{i \in I} v_i$. A chain of flats is a collection of flats satisfying

$$F_{I_1} \subset F_{I_2} \subset \dots \subset F_{I_{l-1}} \subset F_{I_l},$$

such that $\dim(F_{I_i}) = \dim(F_{I_{i-1}}) - 1$. For every chain of flats, there is a cone in $\limtrop_{t \rightarrow +\infty} \mathcal{L}$ spanned by the vectors v_{I_1}, \dots, v_{I_l} . Then, $\limtrop_{t \rightarrow +\infty} \mathcal{L}$ is the underlying set which is the union of all such cones, every top dimensional face being equipped with weight 1.

Example 5.21. A linear space $\mathcal{L} \subset (\mathbb{C}^\times)^n$ is called ∂ -transversal if the corresponding hyperplane arrangement satisfies $\text{codim}(\cap_{i \in I} H_i) = |I|$ for any subset $I \subset \{0, \dots, n\}$. Such a hyperplane arrangement is also known as *uniform*. The condition for a linear space to be ∂ -transversal implies that any subset $I \subset \{0, \dots, n\}$ gives a flat F_I , just as any chain of subsets of $\{0, \dots, n\}$ gives a cone in $\limtrop_{t \rightarrow +\infty} \mathcal{L}$.

To understand $\lim_{t \rightarrow +\infty} \text{trop } \mathcal{L}$ as a set, notice that there are $n + 1$ one-dimensional rays in directions v_0, v_1, \dots, v_n . For every k -tuple $\{i_1, \dots, i_k\} \subset \{0, \dots, n\}$, there is a cone of dimension k in $\lim_{t \rightarrow +\infty} \text{trop } \mathcal{L}$ spanned by the vectors v_{i_1}, \dots, v_{i_k} . Any other cone from the construction above simply subdivides one of the above cones, thus does not add anything to the set $\lim_{t \rightarrow +\infty} \text{trop } \mathcal{L}$.

In particular, the tropical limit of a ∂ -transversal hyperplane is exactly the standard hyperplane from Example 5.2. The tropical limit of a ∂ -transversal linear space of dimension k in $(\mathbb{C}^\times)^n$ is the k -skeleton of the standard tropical hyperplane, meaning it consists of all faces of dimension less than or equal to k of the standard tropical hyperplane.

The special case $k = 1$ is particularly easy to describe: a ∂ -transversal fan tropical line in \mathbb{R}^n is made of $n + 1$ rays emanating from the origin and going to infinity in the directions

$$(-1, 0, \dots, 0), (0, -1, 0, \dots, 0), \dots, (0, \dots, 0, -1), \text{ and } (1, \dots, 1).$$

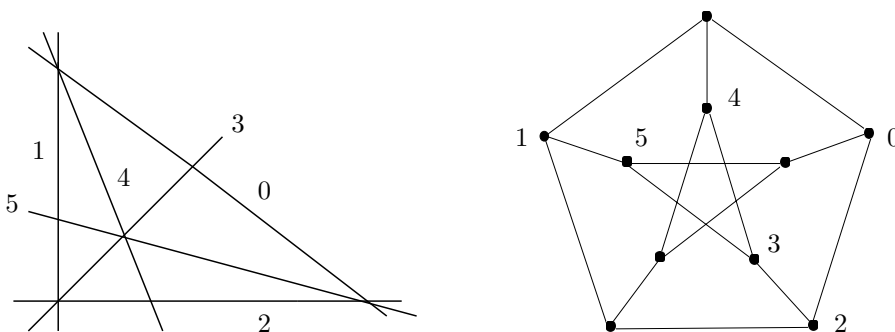

FIGURE 29. The braid arrangement of lines and the link of the vertex of its tropical limit.

Example 5.22. Take the arrangement of six hyperplanes defined in $\mathbb{C}P^2$ by

$$\mathcal{A} = \{x = 0, y = 0, z = 0, x = y, x = z, y = z\}.$$

This is the well known braid arrangement in dimension 2. The line arrangement is shown on the left of Figure 29. The complement $\mathbb{C}P^2 \setminus \mathcal{A}$ can be identified with the moduli space $\mathcal{M}_{0,5}$ of 5-marked rational curves up to automorphism. Moreover, the complement has a linear embedding to $(\mathbb{C}^\times)^5$. As for the flats of this arrangement, there are the lines themselves, there are 4 points which are the intersection of 3 lines, and 3 points which are the intersection of just 2 lines. The link of the singularity of the tropical limit (*i.e.* the intersection of $\lim_{t \rightarrow +\infty} \text{trop } \mathcal{L}$ with a small sphere centered at the vertex of $\lim_{t \rightarrow +\infty} \text{trop } \mathcal{L}$) is the Petersen graph drawn on the right-hand side of Figure 29. This tropical space is also the moduli space of 5-marked tropical rational curves (see [Mik07]).

There is a combinatorial object, introduced by H. Whitney, which seeks to capture and generalize the notion of independence coming from linear algebra and also graph theory. This object is called a *matroid*. We refer, for example, to [Oxl92] for an introduction to the rich theory of matroids.

The lattice of flats of a hyperplane arrangement in $\mathbb{C}P^k$ encodes a matroid. Yet there exists many matroids which are not realizable by the lattice of flats of a hyperplane arrangement over a fixed field, and some which are not realizable over any field at all. As examples, the Fano plane arrangement is only realizable in characteristic two, and the “non-Pappus” matroid (which violates Pappus’ hexagon theorem) is not realizable over any field.

The construction 5.1 above utilizes only the information from the intersection lattice of the hyperplane arrangement. Any matroid comes with this data, thus we can construct a finite polyhedral fan as above and moreover the resulting space is a tropical subvariety of \mathbb{R}^n [Stu02]. So in a sense, any matroid has a geometric representation as a tropical object.

Definition 5.23. A fan tropical linear space $L \subset \mathbb{R}^n$ is a tropical subvariety of \mathbb{R}^n obtained from the Construction 5.1 applied to a matroid.

Fan tropical linear spaces which come from a matroid non-realizable over \mathbb{C} provide a class of examples of tropical subvarieties of \mathbb{R}^n which are not uniformly approximable by linear spaces in $(\mathbb{C}^\times)^n$.

5.5. Tropical subvarieties of \mathbb{T}^n

The tropical affine space \mathbb{T}^n is naturally a stratified space. For any $I \subset [n] := \{0, \dots, n\}$ let

$$\mathbb{T}^J := \{x \in \mathbb{T}^n \mid x_i = -\infty \text{ for all } i \notin J\}.$$

Then $\partial\mathbb{T}^n$ is the union of $\mathbb{T}^{[n]\setminus i}$ for all $1 \leq i \leq n$, and $\mathbb{T}^{[n]\setminus i}$ is of codimension one in \mathbb{T}^n . Notice that $\partial\mathbb{T}^n$ looks like n simple normal crossing divisors. The *sedentarity* $I(x)$ of a point $x \in \mathbb{T}^n$ is the set of coordinates of x which are equal to $-\infty$. For $J = [n]\setminus I$ denote by $\mathbb{R}^J \subset \mathbb{T}^J$ the subset of points of sedentarity I .

The coordinate-wise logarithm map $(\mathbb{C}^\times)^n \rightarrow \mathbb{R}^n$ has fibers $(S^1)^n$. We extend this map to \mathbb{T}^n , by setting $\log(0) = -\infty$. Notice that different strata have different fibers. Over a point in the interior of the boundary strata \mathbb{T}^J the fiber is $(S^1)^{|J|}$. Over the tropical origin $(-\infty, \dots, -\infty)$ there is only the point $(0, \dots, 0)$.

We can also extend our definitions of tropical subvarieties and tropical limits to \mathbb{T}^n and \mathbb{C}^n .

Definition 5.24. A *tropical subvariety* V of \mathbb{T}^n of *sedentarity* I is the closure in \mathbb{T}^n of a tropical subvariety V° of \mathbb{R}^J for $J = [n]\setminus I$. A *tropical subvariety* of \mathbb{T}^n is a union of tropical subvarieties of \mathbb{T}^n of possibly different sedentarities.

As algebraic curves in \mathbb{C}^n , tropical curves in \mathbb{T}^n also have a degree.

Definition 5.25. The *degree* of a tropical curve $C \subset \mathbb{T}^n$ is defined as

$$\deg(C) = \sum_e w_e \max_{j=1}^n \{0, s_j(e)\},$$

where the sum is taken over all unbounded edges of C , the vector $(s_1(e), \dots, s_n(e))$ is the primitive integer vector of e in the outgoing direction, and w_e is the weight of the edge e . (By convention $s_j(e) = 0$ if $j \in I$, where I is the sedentarity of C .)

The tropical and classical notions of degree are related by the following proposition.

Proposition 5.26. Let $\mathcal{C} \subset \mathbb{C}^N$ be a complex algebraic curve, and put $C = \lim_{t \rightarrow +\infty} \text{trop } \mathcal{C}$. Then $\deg(\bar{C}) = \deg(C)$, where \bar{C} is the closure of \mathcal{C} in the compactification of \mathbb{C}^N to $\mathbb{C}P^N$.

5.6. Tropical modifications

From all the examples and pictures of tropical subvarieties of \mathbb{R}^n we provided so far, one can observe a particular feature of tropical geometry: different tropical limits of the same classical variety can have different topologies depending on the embedding of the classical variety. There is a way to understand how to relate these different tropical models, it is called *tropical modification* and was introduced in [Mik06].

Given a tropical subvariety V of \mathbb{T}^n and a tropical polynomial $P : \mathbb{T}^n \rightarrow \mathbb{T}$, a tropical modification is a map $\pi_P : \tilde{V} \rightarrow V$, where \tilde{V} is a tropical subvariety of \mathbb{T}^{n+1} defined below and π_P is simply the linear projection of $\mathbb{T}^{n+1} \rightarrow \mathbb{T}^n$ with kernel e_{n+1} . The tropical modification is a space \tilde{V} along with the map π_P , so our notation is similar to that for birational modifications in classical geometry.

Now we describe precisely how to obtain the space \tilde{V} . Firstly, consider the graph $\Gamma_P(V)$ of the piecewise integer affine function P restricted to V . The graph $\Gamma_P(V)$ is equipped with the weight function inherited from the weight function on V . In general, this graph is not a tropical subvariety of \mathbb{T}^{n+1} as it may not be balanced in the e_{n+1} direction. Recall our first considerations of graphs of tropical polynomials: the graphs shown in Figure 1 are not tropical curves. At every codimension one face of $\Gamma_P(V)$ which fails to satisfy the balancing condition, add a new top dimensional face in the $-e_{n+1}$ direction equipped with the unique integer weight so that balancing condition is now satisfied. This is what the dashed vertical line segments represent in Figure 1.

Definition 5.27. Let V be a tropical subvariety of \mathbb{T}^n with sedentarity \emptyset , and $P : \mathbb{T}^n \rightarrow \mathbb{T}$ a tropical polynomial. The map $\pi_P : \tilde{V} \rightarrow V$ described above is the *tropical modification* of V along the function P .

The *divisor* $\text{div}_V(P) \subset V$ of P restricted to V is the union of the set of the points $x \in V$ such that $P(x) = -\infty$ and of the projection of the corner locus of the graph of $\Gamma_P(V)$. The weight of a top dimensional face F of $\text{div}_V(P)$ is described by the following two cases.

- If F is a face with empty sedentarity, the weight of F is the unique integer weight on

$$\tilde{F} = \{(x, P(x)) - te_{n+1} \mid x \in F \text{ and } t > 0\}$$

required to make $\Gamma_P(V) \cup \tilde{F}$ balanced along $\Gamma_P(F)$.

- If F is a face with non-empty sedentarity (*i.e.* if $P(F) = \{-\infty\}$), let F_1, \dots, F_k denote the facets of V adjacent to F , and let $w_i, i = 1, \dots, k$, denote the weight of the facet F_i of V . For each $i = 1, \dots, k$, there exists a unique primitive integer vector $v_i \in \mathbb{Z}^n$ such that $\lim_{t \rightarrow +\infty} x_i - tv_i$ is contained in the relative interior of F if $x_i \in F_i$. In a neighborhood of F , the value of P restricted to F_i is given by a single monomial “ $a_{\alpha_i} x^{\alpha_i}$ ”, and the weight of F in $\text{div}_V(P)$ is defined as

$$\sum_{i=1}^k w_i \langle \alpha_i, v_i \rangle.$$

The divisor $\text{div}_V(P)$ is a union of tropical subvarieties of \mathbb{T}^n of possibly different sedentarities. Definition of divisors can be extended to tropical rational functions $R = \frac{P}{Q} = P - Q$ which are tropical quotients of polynomials. In this case, a divisor is a tropical cycle in the sense of Definition 5.8. When the divisor is effective, *i.e.* is a tropical subvariety of \mathbb{T}^n , the definition of a tropical modification can also be extended.

Example 5.28. Consider $V = \mathbb{T}^2$ and $P(x, y) = “x + y + 0”$. The function P has three domains of linearity in \mathbb{T}^2 ,

$$P(x, y) = \begin{cases} x & \text{if } x \geq \max\{y, 0\} \\ y & \text{if } y \geq \max\{x, 0\} \\ 0 & \text{if } 0 \geq \max\{x, y\} \end{cases}.$$

Therefore, the graph of Γ_P has three one-dimensional faces, and $\text{div}(P)$ is precisely the tropical line defined by P . In addition, the surface \tilde{V} is a tropical plane in \mathbb{T}^3 , and the tropical modification $\pi_P : \tilde{V} \rightarrow V$ is the vertical projection, see Figure 30.

Example 5.29. More generally, if $V = \mathbb{T}^n$ and $P(x_1, \dots, x_n)$ is a tropical polynomial, the divisor $\text{div}(P) \subset \mathbb{T}^n$ is the tropical hypersurface defined by $P(x_1, \dots, x_n)$, and $\tilde{V} \subset \mathbb{T}^{n+1}$ is the tropical hypersurface defined by the tropical polynomial “ $x_{n+1} + P(x_1, \dots, x_n)$ ”.

The next proposition relates tropical modifications and tropical limits of subvarieties of \mathbb{C}^n .

Proposition 5.30. *Let $V \subset \mathbb{T}^n$ be the tropical limit of a family of complex algebraic subvarieties $(\mathcal{V}_t)_{t \in \mathbb{R}_{>1}}$ of \mathbb{C}^n , and $P : \mathbb{T}^n \rightarrow \mathbb{T}$ be a tropical polynomial. Denote by $\pi_P : \tilde{V} \rightarrow V$ the tropical modification of V along P . Choose a family of complex polynomials P_t such that the tropical limit of this family is P , and denote by $\Gamma_{P_t}(\mathcal{V}_t) \subset \mathbb{C}^{n+1}$ the graph of \mathcal{V}_t along the function P_t . Then, for a generic choice of the family P_t , we have*

$$\lim_{t \rightarrow +\infty} \text{trop } \Gamma_{P_t}(\mathcal{V}_t) = \tilde{V}.$$

Upon taking the tropical limit, properties of varieties which may be of interest sometimes are no longer visible, and the tropical limit of a different embedding can reveal new features. We make this vague remark explicit with two examples, returning to curves in the plane.

Brief introduction to tropical geometry

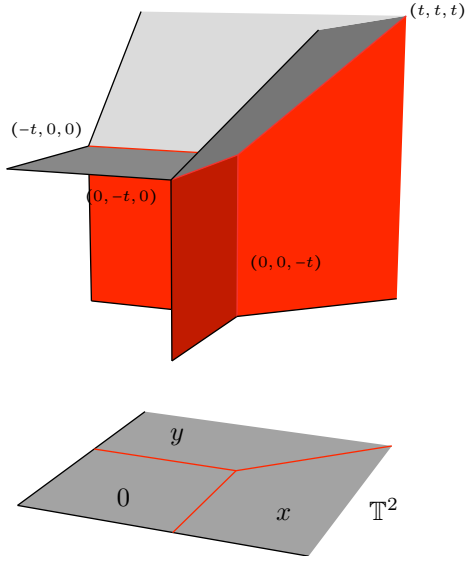

FIGURE 30. Tropical modification of the tropical affine plane \mathbb{T}^2 along “ $x + y + 0$ ”.

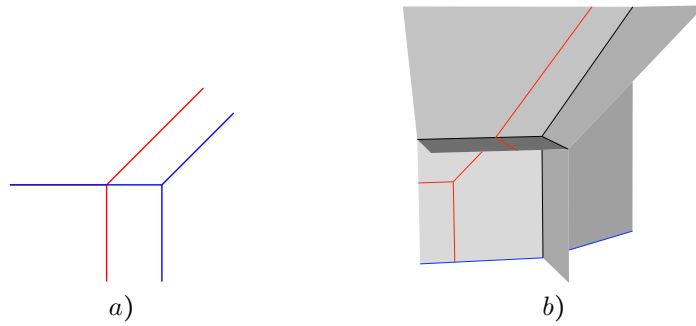

FIGURE 31. The two lines from Example 5.28 and the tropical limit of the configuration in the modified tropical plane

Example 5.31. For a pair of planar tropical curves C and C' intersecting transversally, Proposition 2.13 relates the tropical limit of the intersection points of the families $(C_t)_{t \in \mathbb{R}_{>1}}$ and $(C'_t)_{t \in \mathbb{R}_{>1}}$ counted with multiplicities to the area of polygons in the subdivision dual to $C \cup C'$. When C and C' do not intersect transversally, we cannot determine the precise

location of the limit of the intersection points $\mathcal{C}_t \cap \mathcal{C}'_t$. By embedding suitably \mathbb{C}^2 to \mathbb{C}^3 , we may reveal the location of the tropical limit of $\mathcal{C}_t \cap \mathcal{C}'_t$.

Consider the constant family \mathcal{C} defined by $P(z, w) = z + w + 1$ and let \mathcal{C}'_t be defined by

$$Q_t(z, w) = (t + 1)z + w + (1 - t^{b+1}) = 0 \text{ with } b \leq -1.$$

A simple substitution verifies that \mathcal{C} and \mathcal{C}'_t intersect at $\mathbf{p}_t = (t^b, -1 - t^b)$ whose tropical limit is to $(b, 0) \in \mathbb{R}^2$. In the tropical limit we obtain two tropical lines which intersect along a real half line $\{(t, 0) \mid t \leq -1\}$, thus the limit of the point \mathbf{p}_t is not visible in this tropical limit (see Figure 31a). Consider the reembedding given by taking the graph along P , *i.e.* the graph $\Gamma_P : \mathbb{C}^2 \rightarrow \mathbb{C}^3$ of the function $(z, w) \mapsto (z, w, P(z, w))$. This graph is simply a hyperplane in \mathbb{C}^3 and $\lim_{t \rightarrow +\infty} \text{trop } \Gamma_P(\mathbb{C}^2)$ is a tropical plane Π from Example 5.2. Moreover the projection $\Pi \rightarrow \mathbb{T}^2$ is a tropical modification along the tropical function “ $x + y + 0$ ”.

The reembedding of the family of lines \mathcal{C}'_t is

$$\Gamma_P(\mathcal{C}'_t) = \{(z, t^{b+1} - 1 - (t + 1)z, t^{b+1} - tz) \mid z \in \mathbb{C}\} \subset \mathbb{C}^3.$$

Denote the tropical limit of $\Gamma_P(\mathcal{C}'_t)$ by \tilde{C}' . Then \tilde{C}' is a tropical curve which must be contained in Π and satisfy $\pi(\tilde{C}') = C'$. Moreover, the intersection point $\Gamma_P(\mathbf{p}_t) = (t^b, -1 - t^b, 0)$ is sent to $(b, 0, -\infty)$ in the tropical limit. This implies that the tropical curve \tilde{C}' must have an unbounded ray of the form $(b, 0, -s)$ for $s \gg 0$. In the modified picture the position of the intersection point of \mathcal{C} and \mathcal{C}'_t is revealed (see Figure 31b). The use of tropical modifications to study intersection points in the non-transverse case is a technique used in [BLdM12].

Example 5.32. Consider the family of complex curves in \mathbb{C}^2 defined by the polynomials $P_t(z_1, z_2) = z_1 + z_2 + t^a z_1 z_2 + z_1^2 z_2 + z_1 z_2^2$ for $a > 0$. It can be checked that these curves are smooth and of genus one. Then, $\lim_{t \rightarrow +\infty} \text{trop } \mathcal{C}_t$ is the tropical curve defined by the tropical polynomial “ $x_1 + x_2 + ax_1 x_2 + x_1^2 x_2 + x_1 x_2^2$ ”. This tropical curve is non-singular and has a cycle of length $4a$. The tropical curve and its dual subdivision are depicted in Figures 32a,b.

Now perform a linear coordinate change $z_3 = z_1 - \alpha t^a$ for some complex number α . Then, we have

$$P_t(z_3, z_2) = \alpha t^a + z_3 + (1 + \alpha t^{2a} + \alpha^2 t^{2a}) z_2 + (t^a + 2\alpha t^a) z_2 z_3 + z_3^2 z_2 + z_2^2 z_3 + \alpha t^a z_2^2.$$

As long as $\alpha \neq -1$ or $-1/2$ the tropical limit of this family is given by the tropical polynomial

$$P_{trop}(x_3, x_2) = “a + x_3 + 2ax_2 + ax_2 x_3 + x_3^2 x_2 + x_2^2 x_3 + ax_2^2”.$$

The tropical limit is dual to the subdivision of the Newton polygon depicted in Figures 32c,d. Therefore, the tropical curve defined by this change of coordinates contains no cycle.

Brief introduction to tropical geometry

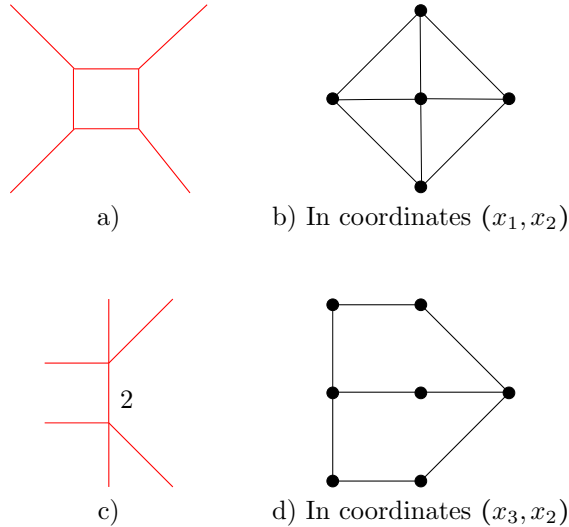

FIGURE 32. The two tropical limits of the curve in Example 5.32 with respect to the two coordinate systems. Beside them are the respective subdivisions of their Newton polygons.

Of the two tropical limits above the one we started with is arguably better. First of all, the first Betti number of C is equal to the genus of a member of \mathcal{C}_t . Moreover, C is non-singular and this implies a relation between the integer length of the cycle of C and the limit as $t \rightarrow +\infty$ under \log_t of the j -invariants of \mathcal{C}_t [KMM09]. There is also a tropical picture, which captures both of these tropical limits, it is obtained by a tropical modification as follows. Consider the family of embeddings $i_t : \mathbb{C}^2 \rightarrow \mathbb{C}^3$ given by taking the graph along the function $z_1 - \alpha t^a$. Taking the tropical limit, we obtain the tropical modification of \mathbb{T}^2 along the vertical line $x_1 = a$. It consists of three 2-dimensional faces intersecting in a line shown in Figure 33. Taking the tropical limit of $i_t(\mathcal{C}_t) \subset \mathbb{C}^3$ we obtain the tropical curve contained in the union of these three faces also depicted in the same figure.

Both tropical limits above can be seen from this picture. Indeed we obtain the first curve if we project onto the (x_1, x_2) coordinates and we obtain the second picture if we project onto the (x_3, x_2) coordinates. We could imagine that had we started with a curve defined by a polynomial in the second set of coordinates, we would wish to find the change of coordinates which produces a smooth tropical curve. “Repairing” tropical limit of curves using tropical modifications is the subject of [CM14].

Exercises 5.

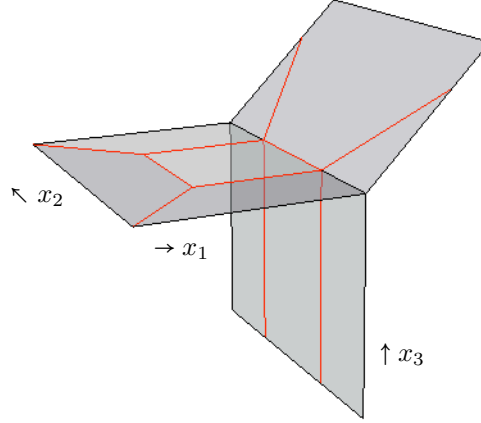

FIGURE 33. The tropical modification of \mathbb{T}^2 which captures the tropical limit of the family of curves $(\mathcal{C}_t)_{t \in \mathbb{R}_{>1}}$ from Example 5.32 with respect to both systems of coordinates.

- (1) Prove that a tropical hypersurface V in \mathbb{R}^n with Newton polytope the standard n -simplex of size d has at most d^n vertices, and that V is non-singular if and only if equality holds (compare with Exercise 2(2)).
- (2) Let S be a non-singular tropical surface in \mathbb{R}^3 with Newton polytope the standard 3-dimensional simplex of size 2. Show that S has a unique compact facet. (Hint: one has to prove that the dual subdivision of the simplex has a unique edge not contained on the boundary; use the fact that the tetrahedron has Euler characteristic 1).
- (3) For a ∂ -transversal linear space $\mathcal{L} \subset (\mathbb{C}^*)^n$ of dimension k , show that $\lim_{t \rightarrow +\infty} \text{trop } \mathcal{L}$ is the k -skeleton of the hyperplane in \mathbb{T}^n from Example 5.2.
- (4) Verify that the braid arrangement from 5.22 produces the cone over the Petersen graph from Figure 29.
- (5) Let $\mathcal{L} \subset (\mathbb{C}^*)^n$ be a 2-dimensional linear space. Find a formula for the Euler characteristic of \mathcal{L} in terms of $\lim_{t \rightarrow +\infty} \text{trop } \mathcal{L}$.
- (6) Let $\mathcal{L} \subset (\mathbb{C}^*)^n$ be a linear space. Using Construction 5.1, show that $\lim_{t \rightarrow +\infty} \text{trop } \mathcal{L}$ satisfies the balancing condition.
- (7) Let $\Pi \subset \mathbb{T}^3$ be the tropical plane from Example 5.2 with vertex at the origin, and let $L = \{(x, x, 0) \mid x \in \mathbb{T}\} \subset \Pi$, equipped with weight one on each of its two edges. Find a function P such that $\text{div}_{\Pi}(P) = L$. Can P be a tropical polynomial?
- (8) Find the image of the tropical limit of the curve from Example 5.32 when $\alpha = -1$ and $-\frac{1}{2}$.

6. Tropical curves in tropical surfaces

We have had quite an in-depth look at the applications of tropical geometry in several questions related to curves in $\mathbb{C}P^2$, or more generally in toric surfaces. The patchworking construction allows one to construct real algebraic curves with prescribed topology. The correspondence theorem 4.11 tells us how to count tropical curves with multiplicities in order to obtain both Gromov-Witten and Welschinger invariants.

Here we take a look at what happens with tropical curves in more general tropical surfaces in \mathbb{R}^n or \mathbb{T}^n , and simultaneous approximation of curves and surfaces. We mainly restrict to approximations by *constant families* of pairs of *fan tropical curves* (*i.e.* tropical curves with at most one vertex, at the origin) in tropical planes. This is not only an easier particular case of the approximation problem, instead it constitutes also a *local* approximation problem needed to further study of any *global* approximation. We provide more details in Section 6.3.

6.1. Approximation of pairs

We are interested in the following problem: given $C \subset S \subset \mathbb{T}^n$ (or $C \subset S \subset \mathbb{R}^n$) a tropical curve C contained in a tropical surface S , does there exist two families $\mathcal{C}_t \subset \mathcal{S}_t \subset \mathbb{C}^n$ (or $\mathcal{C}_t \subset \mathcal{S}_t \subset (\mathbb{C}^\times)^n$) of complex algebraic curves and surfaces such that $\lim_{t \rightarrow +\infty} \text{trop } \mathcal{C}_t = C$ and $\lim_{t \rightarrow +\infty} \text{trop } \mathcal{S}_t = S$?

It turns out that even if C and S are both approximable by families $(\mathcal{C}_t)_{t \in \mathbb{R}_{>1}}$ and $(\mathcal{S}_t)_{t \in \mathbb{R}_{>1}}$, it might not be possible to find families satisfying the extra condition that $\mathcal{C}_t \subset \mathcal{S}_t$.

In the next section we will focus only on approximation of pairs by constant families $\mathcal{C} \subset \mathcal{P} \subset (\mathbb{C}^\times)^n$, where \mathcal{C} is an algebraic curve and \mathcal{P} is a plane. Recall that the tropical limits of \mathcal{C} and \mathcal{P} must both be fans in this case.

Example 6.1. Consider the tropical plane $\Pi \subset \mathbb{T}^3$ centered at the origin, and the tropical curve C made of three rays in the directions

$$(-2, -3, 0), \quad (0, 1, 1), \quad (2, 2, -1),$$

each ray being equipped with weight 1. We already saw that Π is approximable. The tropical curve C is also approximable, for example one can check that $C = \lim_{t \rightarrow +\infty} \text{trop } \mathcal{C}$ where

$$\mathcal{C} = \left\{ \left(\frac{u^2}{(u-1)^2}, \frac{u^3}{(u-1)^2}, u-1 \right), u \in \mathbb{C} \right\}.$$

However, we claim that there are no pairs $\mathcal{C} \subset \mathcal{P} \subset \mathbb{C}^3$ for which

$$C = \lim_{t \rightarrow +\infty} \text{trop } \mathcal{C} \quad \text{and} \quad \Pi = \lim_{t \rightarrow +\infty} \text{trop } \mathcal{P}.$$

We give several (related) proofs of this fact further in the text, nevertheless we can already explain the reason why such a pair $\mathcal{C} \subset \mathcal{P} \subset \mathbb{C}^3$ does not exist: if it did, the curve \mathcal{C} should

have degree 3, and have two cusps singularities. This contradicts the fact that a plane cubic curve cannot have more than one cusp singularity.

6.2. Intersection of fan tropical curves in fan tropical planes

As mentioned above, we restrict in this section to approximations by *constant families* of pairs of fan tropical curves in fan tropical planes.

Intersection theory can be used to detect tropical curves in tropical surfaces which are not approximable as pairs. For the sake of simplicity, we restrict to the intersection of fan tropical curves in fan tropical planes. We refer to [Sha13, AR10] for more elaborate tropical intersection theories. Also we will restrict to planes $\mathcal{P} \subset (\mathbb{C}^\times)^n$ that are ∂ -transversal, *i.e.* no three lines in the corresponding line arrangement are concurrent. We refer to [BS14b] for the general case.

Recall that in Proposition 2.13 we used the Euclidean area of subdivisions dual to $C \cup C'$ to determine the intersection multiplicities of curves C_t and C'_t . This tool is no longer available to us when the tropical curves are in general fan linear planes. However, what is visible from a fan tropical curve $\lim_{t \rightarrow +\infty} \text{trop } C \subset \lim_{t \rightarrow +\infty} \text{trop } \mathcal{P}$ are the *Newton diagrams of the curve* in different coordinates given by the intersection points of the lines in the arrangement \mathcal{A} corresponding to \mathcal{P} .

Let $P(x, y)$ be a polynomial with Newton polygon $\Delta(P)$, and let

$$\bar{\Delta}(P) = \text{Conv}\{\Delta(P) \cup (0, 0)\} \quad \text{and} \quad \Delta(P)^c = \bar{\Delta}(P) \setminus \Delta(P).$$

The polygon $\Delta(P)^c$ is the Newton diagram of the singularity in coordinates (x, y) at the origin of the curve defined by P . For a different system of coordinates the curve has different Newton diagrams. For tropical curves in \mathbb{T}^2 containing none of the coordinate axes, by duality there is a correspondence between the unbounded rays of the tropical curve heading toward $(-\infty, -\infty)$ and the non vertical/horizontal edges of Δ^c . The unbounded rays of the tropical limit $\lim_{t \rightarrow +\infty} \text{trop } C$ of a curve $C \subset (\mathbb{C}^\times)^n$ contained in a ∂ -transversal plane \mathcal{P} provide an information on the Newton diagrams of the curve in $\mathbb{C}P^2 \simeq \bar{\mathcal{P}} \subset \mathbb{C}P^n$ in the systems of coordinates coming from pairs of lines in the arrangement \mathcal{A} defined by \mathcal{P} .

Example 6.2. Let $\mathcal{P} = \mathbb{C}^2$ equipped with some coordinate system, and let $\mathcal{C} \subset \mathcal{P}$ be a complex algebraic curve. Then, $\Delta(\mathcal{C})^c$ is the triangle with vertices $(0, 0)$, $(0, 2)$, and $(3, 0)$ if and only if $\lim_{t \rightarrow +\infty} \text{trop } \mathcal{C}$ has a unique ray passing through $(-\infty, -\infty)$, and this latter is of weight 1 with direction $(-2, -3)$. Note that this is also equivalent to the fact that the curve \mathcal{C} has a cusp at the origin, with the tangent at the origin being the abscissa axis.

Example 6.3. Returning to the curve from Example 6.1, each ray is contained in a different face of the standard tropical plane $\Pi = \lim_{t \rightarrow +\infty} \text{trop } \mathcal{P}$, where \mathcal{P} is defined by the equation $z_1 + z_2 + z_3 = 0$. The ray in direction $(-2, -3, 0)$ is contained in the face spanned by $-e_1$ and $-e_2$. It tells us that in coordinates given by lines $\mathcal{L}_1 = \{z_1 = 0\}$ and $\mathcal{L}_2 = \{z_2 = 0\}$, an approximating curve \mathcal{C} must have the triangle with vertices $(0, 0)$, $(0, 2)$, and $(3, 0)$ as

Newton diagram. According to Example 6.2, the curve \mathcal{C} must have a cusp at $\mathcal{L}_1 \cap \mathcal{L}_2$. Similarly, the ray in direction $(2, 2, -1)$ is contained in the face spanned by e_0 and $-e_3$ since as this direction is $(2, 2, -1) = 2e_0 - 3e_3$. Again, this indicates that \mathcal{C} has a cusp at the intersection of $\mathcal{L}_3 = \{z_3 = 0\}$ with the line at infinity. The last direction $(0, 1, 1)$ tells us that the curve is of multiplicity one at the point $\mathcal{L}_0 \cap \mathcal{L}_1$.

This along with the fact that an approximating curve must have degree three, tells us that the tropical curve from Example 6.1 can not be approximated by a complex cubic curve in \mathcal{P} : each cusp singularity decreases the genus of a curve by one, and a degree three curve in a plane has genus at most one.

Now we define the intersection of two fan tropical curves in a fan tropical plane. Recall that if $\mathcal{P} \subset \mathbb{C}^n$ is a ∂ -transversal plane, each two-dimensional face of $\lim_{t \rightarrow +\infty} \text{trop } \mathcal{P}$ is the cone generated by two vectors v_i, v_j corresponding to a pair of lines of the line arrangement \mathcal{A} associated with \mathcal{P} . Thus, the two-dimensional faces of $\lim_{t \rightarrow +\infty} \text{trop } \mathcal{P}$ are in bijection with pairs of lines $\mathcal{L}_i, \mathcal{L}_j$ of \mathcal{A} .

Definition 6.4. Let $\mathcal{P} \subset (\mathbb{C}^\times)^n$ be a ∂ -transversal plane. Given two fan tropical curves $C_1, C_2 \subset \lim_{t \rightarrow +\infty} \text{trop } \mathcal{P} \subset \mathbb{R}^n$, suppose that for a two-dimensional face F_{ij} of $\lim_{t \rightarrow +\infty} \text{trop } \mathcal{P}$ spanned by v_i, v_j , the curves C_1, C_2 have each exactly one ray in its interior. Suppose the ray of C_1 has weight w_1 and is in direction $p_1 v_i + q_1 v_j$ and the ray of C_2 has weight w_2 and is in direction $p_2 v_i + q_2 v_j$. Define the *corner intersection multiplicity* of C_1 and C_2 in F_{ij} as

$$(C_1 \cdot C_2)_{ij} = w_1 w_2 \min\{p_1 q_2, q_1 p_2\}.$$

When the curves C_1, C_2 have several rays in the interior of a face, the above definition is extended by distributivity.

Definition 6.5. Let $\mathcal{P} \subset (\mathbb{C}^\times)^n$ be a ∂ -transversal plane. Given two fan tropical curves C_1 and C_2 in $\lim_{t \rightarrow +\infty} \text{trop } \mathcal{P}$, their *tropical intersection multiplicity* at the origin of $\lim_{t \rightarrow +\infty} \text{trop } \mathcal{P}$ is defined as

$$(C_1 \cdot C_2)_0 = \deg(C_1) \cdot \deg(C_2) - \sum_{F_{ij}} (C_1 \cdot C_2)_{ij},$$

where the sum is taken over all two-dimensional faces of $\lim_{t \rightarrow +\infty} \text{trop } \mathcal{P}$.

Here $\deg(C)$ is the degree of the tropical curve considered in \mathbb{T}^n (see Definition 5.25). Notice that the above definition also applies to tropical curves which have edges in common, and even to self-intersections.

Example 6.6. Suppose that $\mathcal{P} = (\mathbb{C}^\times)^2$, and that C_1 and C_2 are two fan tropical curves in $\lim_{t \rightarrow +\infty} \text{trop } \mathcal{P} = \mathbb{R}^2$ centered at the origin. Then $(C_1 \cdot C_2)_0$ is equal to the mixed volume of $\Delta(C_1)$ and $\Delta(C_2)$, *i.e.*

$$(C_1 \cdot C_2)_0 = \text{Area}(\Delta(C_1 \cup C_2)) - \text{Area}(\Delta(C_1)) - \text{Area}(\Delta(C_2)),$$

where $\text{Area}(\Delta(C))$ is the Euclidean area of the Newton polygon of C (compare with Exercise 2(4)). In particular $(C_1 \cdot C_2)_0 \geq 0$.

Example 6.7. Let C be the degree 3 tropical curve from Example 6.1, and let

$$L = \{(x, x, 0) \mid x \in \mathbb{R}\}$$

be the degree 1 tropical curve equipped with weight one on its edges. Both tropical curves are contained in the tropical plane Π centered at the origin in \mathbb{R}^3 , and we have the following intersection numbers in Π

$$(L^2)_0 = -1, \quad (C^2)_0 = -4, \quad \text{and} \quad (C \cdot L)_0 = -1.$$

Classical and tropical intersections are related by the following theorem. Recall that two complex algebraic curves intersect *properly* if they intersect in finitely many points.

Theorem 6.8 ([BS14b]). *Let $\mathcal{C}_1, \mathcal{C}_2 \subset (\mathbb{C}^\times)^n$ be two complex algebraic curves in a ∂ -transversal plane $\mathcal{P} \subset (\mathbb{C}^\times)^n$. We denote respectively by C_1 and C_2 the tropical limits of \mathcal{C}_1 and \mathcal{C}_2 , and by $m(\mathcal{C}_1 \cdot \mathcal{C}_2)$ their number of intersection points in \mathcal{P} counted with multiplicity. If \mathcal{C}_1 and \mathcal{C}_2 intersect properly, then we have*

$$m(\mathcal{C}_1 \cdot \mathcal{C}_2) \leq (C_1 \cdot C_2)_0.$$

If in addition the intersection of C_1 and C_2 is reduced to a point, then this inequality is an equality.

Remark 6.9. A similar result holds without the assumption that \mathcal{P} is ∂ -transversal.

Recall that intersection points of two complex algebraic curves are always positive. As a consequence, we deduce two immediate corollaries from Theorem 6.8.

Corollary 6.10 ([BS14b]). *Let $\mathcal{P} \subset (\mathbb{C}^\times)^n$ be a ∂ -transversal plane. Suppose there exists an irreducible and reduced complex algebraic curve $\mathcal{C} \subset \mathcal{P}$ such that $\lim_{t \rightarrow +\infty} \text{trop } \mathcal{C} = C$. If $D \subset \lim_{t \rightarrow +\infty} \text{trop } \mathcal{P}$ is another fan tropical curve such that $D \neq C$ and $(C \cdot D)_0 < 0$, then D is not the tropical limit of any irreducible complex algebraic curve $\mathcal{D} \subset \mathcal{P}$.*

Example 6.11. It follows from Corollary 6.10 that at most one of the two tropical curves from Example 6.7 can be the tropical limit of a complex algebraic curve contained in the plane \mathcal{P} with equation $z_1 + z_2 + z_3 + 1 = 0$. Since one easily sees that L is the tropical limit of a line $\mathcal{L} \subset \mathcal{P}$, this proves that the tropical curve C is not the tropical limit of any irreducible complex algebraic curve $\mathcal{C} \subset \mathcal{P}$.

Corollary 6.12 ([BS14b]). *Let $\mathcal{P} \subset (\mathbb{C}^\times)^n$ be a non-degenerate plane, and suppose that there exists a reduced irreducible curve $\mathcal{C} \subset \mathcal{P}$ such that $\lim_{t \rightarrow +\infty} \text{trop } \mathcal{C} = C$. If $(C^2)_0 < 0$, then \mathcal{C} is the unique complex algebraic curve in \mathcal{P} whose tropical limit is C .*

Example 6.13. The tropical line L from Example 6.7 is approximable by a unique line contained in the plane \mathcal{P} with equation $z_1 + z_2 + z_3 + 1 = 0$.

Combining Theorem 6.8 with classical results from algebraic geometry, one may obtain further obstructions to the approximability of pairs. As an example, the following theorem can be deduced from Theorem 6.8 together with the adjunction formula.

Theorem 6.14 ([BS14b]). *Let $\mathcal{P} \subset (\mathbb{C}^\times)^n$ be a ∂ -transversal plane, and let $C \subset \lim_{t \rightarrow +\infty} \text{trop } \mathcal{P} \subset \mathbb{R}^n$ be a fan tropical curve of degree d . If there exists an irreducible and reduced complex algebraic curve $\mathcal{C} \subset \mathcal{P}$ such that $\lim_{t \rightarrow +\infty} \text{trop } \mathcal{C} = C$, then*

$$(C^2)_0 + (n-2)d - \sum_e w_e + 2 \geq 2g(\mathcal{C}),$$

where the sum goes over all edges e of C , w_e is the weight of e , and $g(\mathcal{C})$ is the geometric genus of \mathcal{C} . In particular, if the left hand side is negative, then C is not approximable by a reduced and irreducible complex algebraic curve in \mathcal{P} .

Example 6.15. We provide another proof of the fact that the tropical curve C from Example 6.1 does not form an approximable pair with the tropical plane Π . Indeed, since $(C^2)_0 = -4$, the left hand side is equal to -2 .

Another example of application of the techniques introduced in this section is the classification of approximable trivalent fan tropical curves in fan tropical planes. The next statement is a special case of this classification.

Theorem 6.16 ([BS14b]). *Let $\mathcal{P} \subset (\mathbb{C}^\times)^3$ be a ∂ -transversal plane, and $C \subset \lim_{t \rightarrow +\infty} \text{trop } \mathcal{P}$ be a fan tropical curve made of at most three rays. Then, there exists an irreducible and reduced complex curve $\mathcal{C} \subset \mathcal{P}$ such that $\lim_{t \rightarrow +\infty} \text{trop } \mathcal{C} = C$ if and only if $(C^2)_0 = 0$ or $(C^2)_0 = -1$.*

6.3. From local to global

So far we have mostly restricted to considering tropical limits of constant families of planes and curves defined over \mathbb{C} . This restriction always produces tropical spaces which are fans. Considering these cases is still useful when we pass to tropical limits of families of varieties due to a *localization procedure*. Suppose that a family $(\mathcal{V}_t)_{t \in A}$ in $(\mathbb{C}^\times)^n$ has V as tropical limit. For any point x of the tropical variety V , we denote by $V(x)$ the fan composed of all vectors $v \in \mathbb{R}^n$ such that $x + \varepsilon v$ is contained in V for a sufficiently small positive real number ε ; this fan is equipped with the weight function on its facets which is inherited from V . The localization procedure provides, for each point $x \in V$, a complex algebraic variety $\mathcal{V}(x) \subset (\mathbb{C}^\times)^n$ such that $\lim_{t \rightarrow +\infty} \text{trop } \mathcal{V}(x) = V(x)$. This localization procedure extends to approximations of a pair (or any tuple) of tropical varieties. Therefore, if a pair consisting of a tropical curve in a tropical surface is not locally approximable at some point, this pair is not globally approximable. However, there are also global obstructions to approximating tropical curves in surfaces.

Example 6.17. Let C be the tropical curve whose directions to infinity are

$$(-2, 1, 1), \quad (1, -2, 1), \quad (0, 0, -1), \quad \text{and} \quad (1, 1, -1),$$

and which contains a bounded edge in direction $(1, 1, -2)$ (see Figure 34). The curve C is contained in the tropical plane Π centered at the origin, and the pair is locally approximable (see Theorem 6.16). However global approximability by planar cubics would

imply the existence of an algebraic cubic in the projective plane together with a line passing through exactly two of its inflection points. This contradicts the fact that a line passing through two inflection points of a cubic actually intersects this cubic in three inflection points.

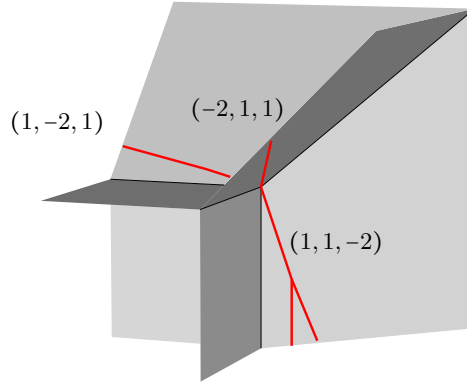

FIGURE 34

Nevertheless, some situations only require the consideration of local obstructions. An example is given by the generalization of the Correspondence Theorem 4.11 to the enumeration of tropical curves in the tropical surface from Example 5.1 (see [BM14]). Another example is provided by the study of tropical lines in tropical surfaces.

In [Vig09] and [Vig07], M. Vigeland exhibited generic non-singular tropical surfaces of degree $d \geq 4$ containing tropical lines, and generic non-singular tropical surfaces of degree $d = 3$ containing infinitely many tropical lines. The following theorem shows that when we restrict our attention to the tropical lines which are approximable in the surface, the situation turns out to be analogous to the case of complex algebraic surfaces.

Theorem 6.18 ([BS14b]). *Let S be a generic non-singular tropical surface in \mathbb{T}^3 of degree d . If $d = 3$, then there exist only finitely many tropical lines $L \subset S$ such that L and S form an approximable pair.*

If $d \geq 4$, then there exist no tropical lines $L \subset S$ such that L and S form an approximable pair.

Exercises 6.

- (1) Show that the tropical curve from Example 6.1 is contained in Π , and show that it has degree 3.
- (2) Recheck the computation of $(L \cdot C)_0$ of Example 6.7.
- (3) Show that the tropical curve L of Example 6.7 together with Π form an approximable pair.

- (4) Let $\Pi \subset \mathbb{R}^n$ be the ∂ -transversal tropical plane centered at the origin. Show that the intersection number of the ∂ -transversal tropical line in Π with any fan tropical curve C in Π is equal to $\deg(C)$.

7. Tropical manifolds and their homology groups

7.1. Abstract tropical manifolds

So far we have seen examples of tropical subvarieties in \mathbb{R}^n and \mathbb{T}^n . In this section, we introduce the notion of *tropical manifold*. The notion of *abstract tropical variety* was first introduced in [Mik06]. Tropical manifolds have the restriction that they are locally modeled on fan tropical linear spaces (defined in Section 5.4). Namely, we say that $M \subset \mathbb{R}^N \times \mathbb{T}^s \subset \mathbb{T}^{N+s}$ is a *tropical smooth local model* if $M = L \times \mathbb{T}^s$, where $L \subset \mathbb{R}^N$ is a fan tropical linear space. The dimension of such a tropical smooth local model is $\dim L + s$.

Definition 7.1. An n -dimensional tropical manifold X is a Hausdorff topological space equipped with an atlas of charts $\{(U_\alpha, \Phi_\alpha)\}$, with $\Phi_\alpha : U_\alpha \rightarrow X_\alpha \subset \mathbb{T}^{N_\alpha}$, such that the following hold:

- (1) for every α , the map $\Phi_\alpha : U_\alpha \rightarrow X_\alpha \subset \mathbb{T}^{N_\alpha}$ is such that X_α is an n -dimensional tropical smooth model, and Φ_α is an open embedding of U_α in X_α ;
- (2) for every α_1, α_2 , the overlapping map $\Phi_{\alpha_1} \circ \Phi_{\alpha_2}^{-1}$, defined on $\Phi_{\alpha_2}(U_{\alpha_1} \cap U_{\alpha_2})$, is the restriction of an integer affine linear map $\mathbb{T}^{N_{\alpha_2}} \rightarrow \mathbb{T}^{N_{\alpha_1}}$ (*i.e.*, of the continuous extension of an integer affine linear map $\mathbb{R}^{N_{\alpha_2}} \rightarrow \mathbb{R}^{N_{\alpha_1}}$);
- (3) X is of finite type, *i.e.*, there is a finite collection of open sets $\{W_i\}_{i=1}^m$ such that $\bigcup_{i=1}^m W_i = X$ and, for each i , there exists α satisfying the conditions $W_i \subset U_\alpha$ and $\overline{\Phi_\alpha(W_i)} \subset \Phi_\alpha(U_\alpha) \subset \mathbb{T}^{N_\alpha}$.

As usual, two atlases on X are called *equivalent* if their union is again an atlas on X ; any equivalence class of atlases on X has a unique saturated (or maximal) representative. We always implicitly consider a tropical manifold equipped with its maximal atlas, even when defining its tropical structure using a non-maximal one.

Example 7.2. The set of tropical numbers \mathbb{T} equipped with the identity chart $Id : \mathbb{T} \rightarrow \mathbb{T}$ is a tropical manifold of dimension 1.

The tropical torus $\mathbb{T}^\times = \mathbb{R}$ equipped with the unique chart $Id : \mathbb{R} \rightarrow \mathbb{R}$ is not a tropical manifold since it does not satisfy the finite type condition. Nevertheless one can enlarge this atlas with the two charts

$$\begin{array}{ccc} (0, +\infty) & \longrightarrow & \mathbb{R} \\ x & \longmapsto & x \end{array} \quad \text{and} \quad \begin{array}{ccc} (-\infty, 1) & \longrightarrow & \mathbb{R} \\ x & \longmapsto & -x \end{array}$$

which turn \mathbb{R} into a tropical manifold of dimension 1.

Analogously, the set $\mathbb{R}_{>0}$ equipped with the inclusion chart $\mathbb{R}_{>0} \hookrightarrow \mathbb{R}$ is not a tropical manifold. However there is no way to complete this atlas to turn $\mathbb{R}_{>0}$ into a tropical manifold.

Example 7.3. The product of two tropical manifolds, equipped with the product atlas, is a tropical manifold. In particular, the affine tropical spaces \mathbb{T}^n and the tropical torus $\mathbb{R}^n = (\mathbb{T}^\times)^n$ for any n are tropical manifolds.

Example 7.4. Consider a tropical subvariety V of \mathbb{R}^n , equipped with the atlas induced by the one on \mathbb{R}^n . Then V is a k -dimensional tropical manifold if and only if the fan $V(x)$ defined in Section 6.3 is a tropical linear space for all points x of V .

Example 7.5. Consider a lattice Λ of rank k in \mathbb{R}^n , and the atlas on \mathbb{R}^n given by the identity map $Id: U \rightarrow U$ on open sets U satisfying $U \cap (U + \Lambda) = \emptyset$. This atlas induces a structure of tropical manifold of dimension n on the quotient space \mathbb{R}^n/Λ . Note that this atlas also turns \mathbb{R}^n/Λ into a differentiable manifold diffeomorphic to $(S^1)^k \times \mathbb{R}^{n-k}$.

It is also possible to think of a tropical manifold as a locally ringed space (X, \mathcal{O}_X) . There is a sheaf of *regular functions* on \mathbb{T}^n , coming from the pre-sheaf of tropical polynomials. By restricting the sheaf of regular functions on \mathbb{T}^{N_α} to X_α for each chart we obtain a sheaf \mathcal{O}_{U_α} . The condition on the overlapping maps in Definition 7.1 ensures that the local sheaves are compatible, that is, the restrictions of $\mathcal{O}_{U_{\alpha_1}}$ and $\mathcal{O}_{U_{\alpha_2}}$ to $U_{\alpha_1} \cap U_{\alpha_2}$ agree. We direct the reader to [Mik06] or [MZ14] for more details.

If a tropical manifold X is compact, then X can be enhanced with a structure of a finite polyhedral complex of pure dimension n .

7.2. Abstract tropical curves

Since $GL_1(\mathbb{Z}) = O_1(\mathbb{R}) = \{\pm 1\}$, a compact smooth tropical curve gives rise to a finite graph equipped with a complete metric on the complement of the set of 1-valent vertices. Conversely, each finite graph (without isolated vertices) equipped with a complete inner metric on the complement of the set of 1-valent vertices can be seen as a compact smooth tropical curve: the interiors of edges can be identified by isometries with open intervals in \mathbb{R} (these intervals are unbounded for the edges adjacent to 1-valent vertices), and for each vertex v with valence $N_v + 1 \geq 3$, we choose a chart $\Phi_v: U_v \rightarrow X_v \subset \mathbb{R}^{N_v} \subset \mathbb{T}^{N_v}$, where U_v is a neighborhood of v , and X_v is the ∂ -transversal fan tropical line in \mathbb{R}^{N_v} (see Example 5.21).

Recall tropical modifications of subvarieties of \mathbb{T}^n from Section 5.6. Let Γ and Γ' be two abstract tropical curves, and let p be a point in the complement of the set of 1-valent vertices of Γ . We say that Γ' is the *elementary tropical modification of Γ at p* if Γ' is obtained by gluing Γ and $[-\infty, 0] \subset \mathbb{T}$ at p and 0 (the metric considered on $(-\infty, 0]$ is the standard Euclidean metric). Notice that this is equivalent to performing, in a single chart, a tropical modification in the sense of Section 5.6. We say that Γ' is a *tropical modification of Γ* if Γ' is obtained by a finite sequence of elementary tropical modifications of Γ . Tropical modifications can also be performed on tropical manifolds of arbitrary dimension (see [Mik06]). However, unlike for tropical curves, it can be quite difficult to determine if two tropical manifolds of higher dimension are related by this operation.

One can introduce the notion of *tropical morphism* between tropical manifolds. For the sake of brevity once again, we do it in this text only in the case of morphisms from a tropical curve to \mathbb{R}^n . Let Γ be a compact connected smooth tropical curve. As we already noticed, the curve Γ can be seen as a graph equipped with a complete inner metric on the complement of the set of 1-valent vertices of Γ .

Definition 7.6. Let $\Gamma^0 \subset \Gamma$ be the complement of a subset of 1-valent vertices of Γ (we do not have to remove all 1-valent vertices from Γ , but only those sent to infinity by the morphism). A *tropical morphism* from Γ^0 to \mathbb{R}^n is a proper continuous map $f : \Gamma^0 \rightarrow \mathbb{R}^n$ subject to the following two properties.

Integrality: the restriction of f to each edge of Γ^0 is integer affine linear. Equivalently, the image of any unit tangent vector to Γ^0 under the differential df is integer, i.e. an element of $\mathbb{Z}^n \subset \mathbb{R}^n$.

Balancing: for each vertex v of Γ^0 , we have

$$\sum_e u(e) = 0,$$

where the sum is taken over all edges adjacent to v , and $u(e)$ is the image under df of the unit tangent vector to e such that this vector points outward of v .

Notice that an edge e of Γ^0 is mapped to a point if and only if $u(e) = 0$. Since in Definition 7.6 we required f to be proper we have the following property: an edge of Γ adjacent to a 1-valent vertex v is mapped to a point by f if and only if $v \in \Gamma^0$.

If $f : \Gamma^0 \rightarrow \mathbb{R}^n$ is a tropical morphism, then $f(\Gamma^0)$ gives rise to a tropical curve C in \mathbb{R}^n . For each edge e of Γ^0 with $u(e) \neq 0$ (we may take $u(e)$ with respect to any vertex adjacent to e), the weight $w(e)$ of $f(e)$ is the positive integer such that $\frac{u(e)}{w(e)}$ is a primitive integer vector. If for several edges e_1, \dots, e_r of Γ^0 the intersection $\cap_{i=1}^r f(e_i)$ is a segment, we put the weight of this segment to be equal to $\sum_{i=1}^r w(e_i)$. We say that Γ is a *parameterization* of C .

Definition 7.7. The *genus* of a tropical curve Γ is defined as the first Betti number $b_1(\Gamma)$ of Γ . The *genus* of an irreducible tropical curve C in \mathbb{R}^n is the minimal genus of parameterizations of C .

One can easily check that in the case of irreducible nodal tropical curves in \mathbb{R}^2 , this definition of genus coincides with the definition given in Section 4.2. There exist tropical curves whose only tropical morphisms to \mathbb{R}^n are the constant maps. Nevertheless, up to tropical modifications and after removing 1-valent vertices, any tropical curve admits a non-constant tropical morphism to some \mathbb{R}^n .

Example 7.8. Figure 35a shows an example of a tropical curve Γ of genus 1. Clearly, the curve Γ does not admit any non-constant tropical morphism to \mathbb{R}^n . By a sequence of nine elementary tropical modifications, one obtains the tropical curve Γ' depicted in Figure 35b, which parameterizes (after removing its nine 1-valent vertices) the tropical cubic in \mathbb{R}^2 depicted in Figure 35c.

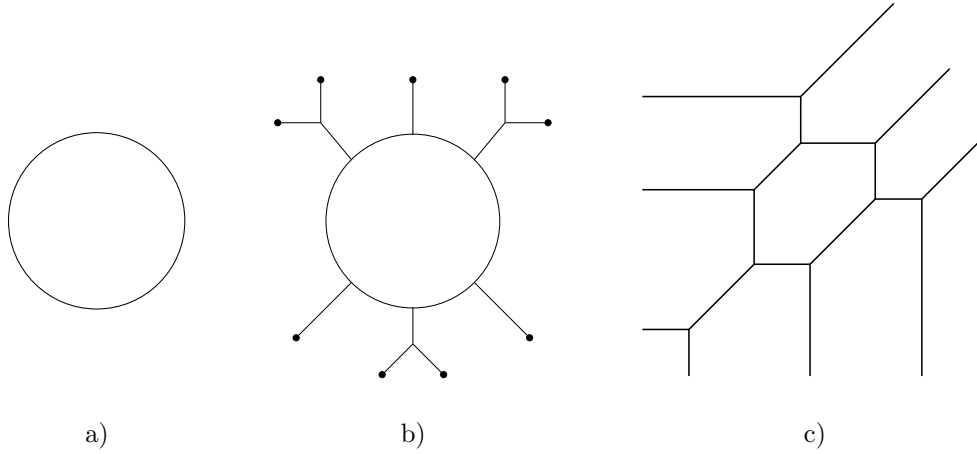

FIGURE 35. Tropical curve, tropical modification, and parameterization from Example 7.8

7.3. Tropical toric varieties

The logarithm transforms multiplication to addition. As a consequence, any operation performed in complex algebraic geometry using only monomial maps translates *mutatis mutandis* in the tropical setting. In other words, non-singular tropical toric varieties are constructed analogously as in complex geometry. Let us illustrate this in the case of projective spaces.

The projective line $\mathbb{C}P^1$ may be obtained by taking two copies of \mathbb{C} , with coordinates z_1 and z_2 , and gluing these copies along \mathbb{C}^\times via the identification $z_2 = z_1^{-1}$. Similarly, the projective plane $\mathbb{C}P^2$ can be constructed by taking three copies of \mathbb{C}^2 , with coordinates (z_1, w_1) , (z_2, w_2) , and (z_3, w_3) , and gluing them along $(\mathbb{C}^\times)^2$ via the identifications

$$(z_2, w_2) = (z_1^{-1}, w_1 z_1^{-1}) \quad \text{and} \quad (z_3, w_3) = (z_1 w_1^{-1}, w_1^{-1}).$$

Taking into account that “ x^{-1} ” = $-x$, the above constructions over \mathbb{T} also yield the projective tropical line $\mathbb{T}P^1$ and plane $\mathbb{T}P^2$. In particular, we see that $\mathbb{T}P^1$ is a segment (Figure 36a), and $\mathbb{T}P^2$ is a triangle (Figure 36b). More generally, the projective space $\mathbb{T}P^n$ is a simplex of dimension n , each of its faces corresponding to a coordinate hyperplane. For example, the tropical 3-space $\mathbb{T}P^3$ is a tetrahedron (Figure 36c). Note that tropical toric varieties have more structure than just a bare topological space. Since all gluing maps are classical linear maps with integer coefficients, each open face of dimension q can be identified with \mathbb{R}^q together with the lattice \mathbb{Z}^q inside. As usual, the affine space \mathbb{T}^n embeds naturally into $\mathbb{T}P^n$, and any tropical subvariety of \mathbb{T}^n has a closure in $\mathbb{T}P^n$. For example, we depicted in Figure 36d the closure in $\mathbb{T}P^2$ of a tropical line in \mathbb{T}^2 .

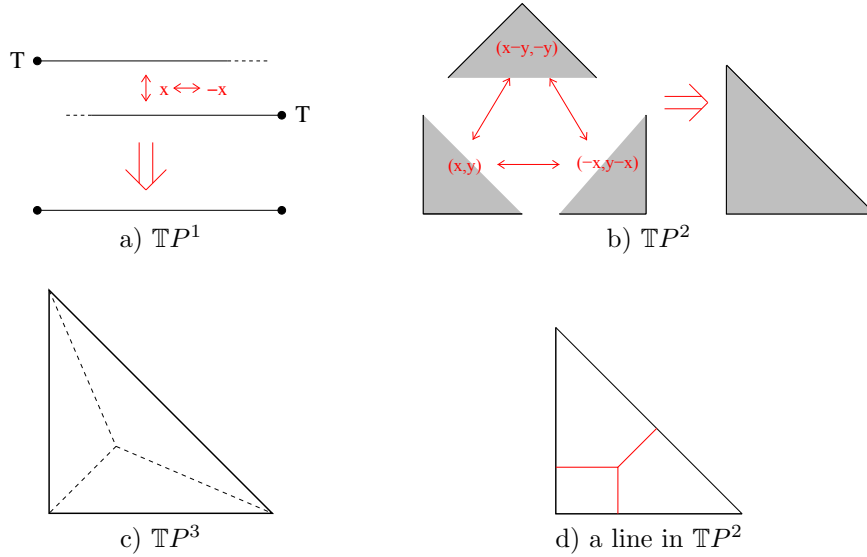

FIGURE 36. Tropical projective spaces

7.4. Tropical homology

This section delivers an introduction to tropical homology and cohomology. For a more in depth look the reader is referred to [IKMZ] and [MZ14]. One of the main interests of tropical homology comes from its connection to the Hodge theory of complex algebraic varieties. As in the case of tropical subvarieties of \mathbb{R}^n , some abstract tropical manifolds appear as a tropical limit of a family (\mathcal{X}_t) of complex algebraic varieties of the same dimension. It turns out that if the varieties \mathcal{X}_t are projective and under certain additional conditions, the Hodge numbers of \mathcal{X}_t are encoded in the tropical limit as ranks of the tropical (p, q) -homology groups, (see Theorem 7.34 or [IKMZ]).

Let $M \subset \mathbb{R}^N \times \mathbb{T}^s \subset \mathbb{T}^{N+s}$ be a tropical smooth local model, and let $x \in M$ be a point. Recall the sedentarity $I(x)$ of x from Section 5.6, and set $J(x) = \{1, 2, \dots, N+s\} \setminus I(x)$. Consider the stratum $\mathbb{T}^{J(x)} \subset \mathbb{T}^{N+s}$ and its relative interior $\mathbb{R}^{J(x)}$. Let $T_x(\mathbb{R}^{J(x)})$ be the vector space tangent to $\mathbb{R}^{J(x)}$ at x . For a face $E \subset M \cap \mathbb{R}^{J(x)}$ adjacent to x , denote by $T_x(E) \subset T_x(\mathbb{R}^{J(x)})$ the cone formed by the tangent vectors to E that are directed towards E from x .

Definition 7.9. The *tropical tangent space* $\mathcal{F}_1(x)$ is the linear subspace of $T_x(\mathbb{R}^{J(x)})$ generated by $T_x(E) \subset T_x(\mathbb{R}^{J(x)})$ for all faces E adjacent to x .

Let X be a tropical manifold, and let $x \in X$ be a point. Different charts at x exhibit neighborhoods of x as tropical smooth local models in various tropical spaces \mathbb{T}^N (perhaps even of different dimensions N). However, the differentials of overlapping maps at x

provide canonical isomorphisms among the corresponding tangent spaces $\mathcal{F}_1(x)$. Thus, the tangent space $\mathcal{F}_1(x)$ of X at x is well defined since it does not depend on the choice of a chart. In addition to the tangent space we have multitangent spaces $\mathcal{F}_p(x)$ that are spanned by multivectors tangent to the same face adjacent to x .

Definition 7.10. For any integer $p \geq 0$, the multitangent space $\mathcal{F}_p(x) \subset \Lambda^p(T_x(\mathbb{R}^{J(x)}))$ of X at x is the linear subspace generated by the p -vectors of the type $\lambda_1 \wedge \cdots \wedge \lambda_p$, where $\lambda_1, \dots, \lambda_p \in T_x(E)$ for a face $E \subset X$ (in a tropical smooth local model) adjacent to x .

In particular, $\mathcal{F}_0(x) = \mathbb{R}$.

Example 7.11. Let $X = \mathbb{T}^n$, and let $x \in \mathbb{T}^n$ be a point of sedentarity $I \subset \{1, 2, \dots, n\}$. Then, $\mathcal{F}_p(x)$ is isomorphic to $\Lambda^p(\mathbb{R}^{J(x)})$.

Example 7.12. Consider the tropical line in \mathbb{T}^2 depicted in Figure 37. The tangent spaces $\mathcal{F}_1(x_5)$ and $\mathcal{F}_1(x_6)$ are null. The tangent space $\mathcal{F}_1(x_2) \subset \mathbb{R}^2$ is generated by the vector $(1, 0)$, and so is isomorphic to \mathbb{R} . Analogously, the tangent spaces $\mathcal{F}_1(x_3)$ and $\mathcal{F}_1(x_4)$ are isomorphic to \mathbb{R} . The tangent space $\mathcal{F}_1(x_1) \subset \mathbb{R}^2$ is generated by the vectors

$$(-1, 0), \quad (0, -1), \quad \text{and} \quad (1, 1),$$

and so is isomorphic to \mathbb{R}^2 .

The multitangent space $\mathcal{F}_2(x_2) \subset \Lambda^2(\mathbb{R}^2)$ is equal to $\Lambda^2(\mathbb{R}(1, 0)) = \{0\}$. Analogously, the multitangent spaces $\mathcal{F}_2(x_3)$ and $\mathcal{F}_2(x_4)$ are null. Since the multitangent space $\mathcal{F}_2(x_1) \subset \Lambda^2(\mathbb{R}^2)$ is generated by $\mathcal{F}_2(x_2)$, $\mathcal{F}_2(x_3)$, and $\mathcal{F}_2(x_4)$, we obtain that $\mathcal{F}_2(x_1)$ is null as well.

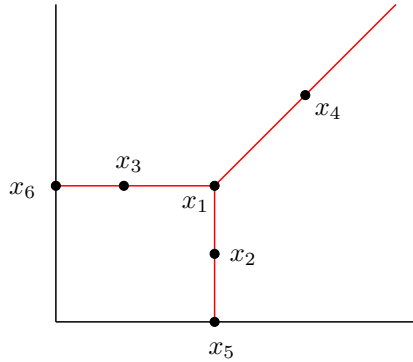

FIGURE 37. Multitangent spaces of an affine tropical line.

Note that a tropical smooth local model $M \subset \mathbb{T}^N$ is naturally stratified by maximal linear subspaces of $\mathbb{R}^J \subset \mathbb{T}^J \subset \mathbb{T}^N$ locally contained in M . Namely, for $x \in M$ the union of the cones $T_x(E)$, for E adjacent to x , is the fan $V(x) \subset T_x(\mathbb{R}^{J(x)})$ described in Section

6.3. *A priori*, there might be several maximal linear subspaces contained inside the fan $V(x)$. Let $W_x \subset V(x)$ be the intersection of all such maximal subspaces. The intersection W_x itself is a linear subspace of $T_x(\mathbb{R}^{J(x)})$. Note that $x + W_x$ is locally (near x) contained in M by the balancing condition.

Definition 7.13 (cf. [MZ14]). A *tropical stratum* is a subset $E \subset X$ that locally looks like $x + W_x$ in charts.

Any tropical stratum E is a differentiable manifold by construction. Tropical strata of X are partially ordered: we say that E is *dominated* by E' if the topological closure $\overline{E'}$ of E' in X contains E . Since an n -dimensional tropical manifold X admits a structure of (a pure) n -dimensional polyhedral complex, any tropical stratum is dominated by a n -dimensional tropical stratum. These strata are called *open facets* of X .

Example 7.14. Let X be a non-singular tropical hypersurface of \mathbb{R}^n . Tropical duality provides a correspondence between tropical strata of dimension k of X and cells of dimension $n - k$ of the subdivision of $\Delta(X)$ dual to X . In particular, open facets of X correspond to edges of this subdivision.

Example 7.15. If x is a point in an open facet of X , then $\mathcal{F}_p(x)$ is isomorphic to $\Lambda^p(\mathbb{R}^{\dim(X)})$. Indeed, in this case we have $W_x = T_x(\mathbb{R}^{J(x)})$ which is isomorphic to $\mathbb{R}^{\dim(X)}$.

Notice that if E is a tropical stratum of X , any path $\gamma : [0, 1] \rightarrow E$ gives rise to an identification (by parallel translation) of the multitangent spaces $\mathcal{F}_p(\gamma(t))$, $t \in [0, 1]$, for each p . Let E be a tropical stratum of X , and let E' be a tropical stratum such that E is dominated by E' . Consider a path $\gamma : [0, 1] \rightarrow (E' \cup E)$ such that $\gamma([0, 1)) \subset E'$ and $\gamma(1) \in E$. Put $x = \gamma(0)$ and $y = \gamma(1)$. For each p , the identifications by parallel translations of $\mathcal{F}_p(\gamma(t))$, for $t \in [0, 1)$, extend to a map

$$\rho_p(\gamma) : \mathcal{F}_p(x) \rightarrow \mathcal{F}_p(y). \quad (2)$$

If the points x and y have the same sedentarity, then $\rho_p(\gamma) : \mathcal{F}_p(x) \rightarrow \mathcal{F}_p(y)$ is a monomorphism, since by definition the tangent space $\mathcal{F}_1(\gamma(t))$ is a subspace of $\mathcal{F}_1(y)$ when $\gamma(t)$ is contained in a tropical smooth local model of X at y . If $I(x) \neq I(y)$, then since E' dominates E we have $I(x) \subset I(y)$. Then $\rho_p(\gamma) : \mathcal{F}_p(x) \rightarrow \mathcal{F}_p(y)$ is given by the composition of the projection along the directions indexed by $I(y) \setminus I(x)$, with the same monomorphism as in the case of equal sedentarity. We obtain immediately the following statement.

Proposition 7.16. *Let $E' \ni x$ and $E \ni y$ be tropical strata of X such that E is dominated by E' . Consider two paths γ_1 and γ_2 to $E \cup E'$ such that*

- $\gamma_1(0) = \gamma_2(0) = x$ and $\gamma_1(1) = \gamma_2(1) = y$,
- $\gamma_1([0, 1)) \subset E'$ and $\gamma_2([0, 1)) \subset E'$,
- γ_1 and γ_2 are homotopic among paths satisfying the two above conditions.

Then, for each p , the maps $\rho_p(\gamma_1)$ and $\rho_p(\gamma_2)$ coincide.

Example 7.17. Let $I_1 \subset I_2 \subset \{1, \dots, n\}$. Then, the tropical stratum $E = \mathbb{R}^{I_2}$ is dominated by the tropical stratum $E' = \mathbb{R}^{I_1}$ inside the tropical manifold \mathbb{T}^n . The map

$$\Lambda^p(\mathbb{R}^{n-|I_1|}) \rightarrow \Lambda^p(\mathbb{R}^{n-|I_2|})$$

induced by any path as above is given by the projection $\mathbb{R}^{n-|I_1|} \rightarrow \mathbb{R}^{n-|I_2|}$ along the directions indexed by $I_2 \setminus I_1$.

Example 7.18. For the tropical line of Example 7.12, the two morphisms $\mathcal{F}_1(x_2) \rightarrow \mathcal{F}_1(x_5)$ and $\mathcal{F}_1(x_3) \rightarrow \mathcal{F}_1(x_6)$ are null. The tangent space $\mathcal{F}_1(x_1)$ is naturally identified with \mathbb{R}^2 . We identify the tangent spaces $\mathcal{F}_1(x_2)$, $\mathcal{F}_1(x_3)$, and $\mathcal{F}_1(x_4)$ with \mathbb{R} by respectively choosing $(0, 1)$, $(1, 0)$, and $(-1, -1)$ as directing vectors. Then, paths from x_2 , (respectively, x_3 or x_4) to x_1 induce the morphisms

$$\begin{array}{ccc} \rho_2 : \mathcal{F}_1(x_2) & \longrightarrow & \mathcal{F}_1(x_1) \\ x & \longmapsto & (0, x) \end{array} \quad \begin{array}{ccc} \rho_3 : \mathcal{F}_1(x_3) & \longrightarrow & \mathcal{F}_1(x_1) \\ x & \longmapsto & (x, 0) \end{array}$$

and

$$\rho_4 : \mathcal{F}_1(x_4) \longrightarrow \mathcal{F}_1(x_1) \\ x \longmapsto (-x, -x).$$

Notice that

$$\rho_2(1) + \rho_3(1) + \rho_4(1) = 0 \in \mathcal{F}_1(x_1).$$

The multitangent spaces $\mathcal{F}_p(x)$ can be thought of as a kind of coefficient system parameterized by points of X . However, this coefficient system is not locally constant as its value may jump at smaller-dimensional strata. But, as we saw, the coefficient groups $\mathcal{F}_p(x)$ at different points x are related via the morphisms ρ_p described above. Such coefficient systems are known as *constructible cosheaves*, and can be used as coefficients for homology groups of X .

Let us review, for example, the construction from [IKMZ, MZ14] of singular homology, with coefficients in \mathcal{F}_p , of a tropical manifold X . Given a closed standard q -dimensional simplex σ_q , we say that a singular simplex $f : \sigma_q \rightarrow X$ is *compatible with tropical stratification* if for each open face $\sigma' \subset \sigma_q$ there exists a tropical stratum $E_{\sigma'}$ such that $f(\sigma') \subset E_{\sigma'}$. The singular simplex $f : \sigma_q \rightarrow X$ is then equipped with a coefficient $\phi(f)$ in $\mathcal{F}_p(f(c))$, where c is the barycenter of σ_q . The term $\phi(f) \cdot f$ is called a (p, q) -*cell*, and the coefficient $\phi(f)$ is often referred to as the *framing* of the (p, q) -cell $\phi(f) \cdot f$.

We define the *tropical chain group* $C_{p,q}(X)$ to be the direct sum of $\mathcal{F}_p(f(c))$ over all q -dimensional singular simplices f which are compatible with the tropical stratification of X . Note that due to Proposition 7.16 we have a well-defined boundary map

$$\partial : C_{p,q}(X) \rightarrow C_{p,q-1}(X).$$

This map is the usual simplicial boundary map along with the restrictions of the coefficients given by the maps ρ described above. It is well defined since the homotopy class of the path from the barycenter of a simplex to the barycenter of any of its faces is unique. Furthermore, we have $\partial \circ \partial = 0$ by the same argument as in the case of singular homology groups with constant coefficients.

Definition 7.19 (Tropical homology, cf. [IKMZ]). The *tropical homology group* $H_{p,q}(X)$ of X is the q -th homology group of the complex

$$\dots \rightarrow C_{p,q+1}(X) \rightarrow C_{p,q}(X) \rightarrow C_{p,q-1}(X) \rightarrow \dots$$

Remark 7.20. The differentials of overlapping maps in the atlas of a tropical manifold are integer linear maps. In particular, each tangent space $\mathcal{F}_1(x)$ contains a full rank lattice, and one could consider integer multitangent spaces $\mathbb{Z}\mathcal{F}_p(x) \subset \Lambda^p(T_x(\mathbb{Z}^{J(x)}))$ instead of the multitangent spaces $\mathcal{F}_p(x)$ as above. The corresponding homology groups of X are called *tropical integer homology groups* of X .

7.5. Some examples of homology computations

Example 7.21. Since \mathcal{F}_0 is locally constant with stalk \mathbb{R} , any tropical manifold X satisfies

$$H_{0,q}(X) = H_q(X; \mathbb{R}).$$

Example 7.22. The contraction $\phi(f) \cdot tf$ by a factor $t \in [0, 1]$ of a (p, q) -cell $\phi(f) \cdot f$ in \mathbb{R}^n is again a (p, q) -cell in \mathbb{R}^n . Moreover, the boundary map clearly commutes with the contraction. As a consequence, any (p, q) -cycle in \mathbb{R}^n is homologous to a (p, q) -cycle supported at the origin of \mathbb{R}^n , and so

$$H_{p,0}(\mathbb{R}^n) = \Lambda^p(\mathbb{R}^n) \quad \text{and} \quad H_{p,q}(\mathbb{R}^n) = 0 \quad \text{for any } q \geq 1.$$

Example 7.23. Given $t \in \mathbb{T}$, consider the map

$$\begin{aligned} \tau_t : \quad \mathbb{T}^n &\longrightarrow \mathbb{T}^n \\ (x_1, \dots, x_n) &\longmapsto \text{“}t(x_1, \dots, x_n)\text{”} = (x_1 + t, \dots, x_n + t) \end{aligned}$$

The boundary map commutes with τ_t , and $\phi(f) \cdot (\tau_t \circ f)$ is a (p, q) -cell in \mathbb{T}^n for any $t \in \mathbb{T}$ and any (p, q) -cell $\phi(f) \cdot f$ in \mathbb{T}^n . Hence, any (p, q) -cycle in \mathbb{T}^n is homologous to a (p, q) -cycle supported at $(-\infty, \dots, -\infty)$, and so

$$H_{0,0}(\mathbb{T}^n) = \mathbb{R} \quad \text{and} \quad H_{p,q}(\mathbb{T}^n) = 0 \quad \text{if } p + q \geq 1.$$

Example 7.24. We compute the tropical homology of the affine tropical line L of Example 7.12. By Example 7.21 we have

$$H_{0,0}(L) = \mathbb{R} \quad \text{and} \quad H_{0,1}(L) = 0.$$

We use the same identifications of $\mathcal{F}_1(x_2)$, $\mathcal{F}_1(x_3)$, and $\mathcal{F}_1(x_4)$ with \mathbb{R} as in Example 7.18. The group $H_{1,0}(L)$ is clearly generated by $1 \cdot x_2$, $1 \cdot x_3$, and $1 \cdot x_4$. The obvious path from x_2 to x_5 equipped with the framing 1 gives $1 \cdot x_2 = 0$ in $H_{1,0}(L)$. Analogously, we have $1 \cdot x_3 = 0$ in $H_{1,0}(L)$. It follows from Example 7.18 that the obvious path from x_4 to x_1 equipped with the framing 1 gives $1 \cdot x_4 = -1 \cdot x_2 - 1 \cdot x_3$ in $H_{1,0}(L)$. Altogether we obtain

$$H_{1,0}(L) = 0.$$

Analogously, one sees that any $(1, 1)$ -cycle is homologous to a cycle with support disjoint from the open edge containing x_4 , implying that

$$H_{1,1}(L) = 0.$$

Example 7.25. Let us consider the tropical line L' in \mathbb{R}^2 obtained by removing the vertices x_5 and x_6 from the affine line of Example 7.12. The same computations as in Example 7.24 give

$$H_{0,0}(L') = \mathbb{R}, \quad H_{0,1}(L') = H_{1,1}(L') = 0,$$

and

$$H_{1,0}(L') = \mathbb{R}(1 \cdot x_2) \oplus \mathbb{R}(1 \cdot x_3) \oplus \mathbb{R}(1 \cdot x_4) / \mathbb{R}v \simeq \mathbb{R}^2,$$

where $v = 1 \cdot x_2 + 1 \cdot x_3 + 1 \cdot x_4$.

Example 7.26. Since \mathbb{TP}^1 is contractible as a topological space, we have

$$H_{0,0}(\mathbb{TP}^1) = \mathbb{R} \quad \text{and} \quad H_{0,1}(\mathbb{TP}^1) = 0.$$

Moreover as in Example 7.24, any $(1,0)$ -cell is a boundary, and so

$$H_{1,0}(\mathbb{TP}^1) = 0.$$

Let ϕ be a non-zero element of $\mathcal{F}_1(\mathbb{R})$. The $(1,1)$ -cell $\phi \cdot \mathbb{TP}^1$ is clearly a $(1,1)$ -cycle, and any $(1,1)$ -cycle is a multiple of $\phi \cdot \mathbb{TP}^1$. Thus we have

$$H_{1,1}(\mathbb{TP}^1) = \mathbb{R}(\phi \cdot \mathbb{TP}^1) \simeq \mathbb{R}.$$

Example 7.27. Consider a point $x \in \mathbb{R}^2 \subset \mathbb{TP}^2$ and a simplicial subdivision of \mathbb{TP}^2 into three triangles T_1 , T_2 , and T_3 , induced by the point x and the three vertices of \mathbb{TP}^2 . Suppose that ϕ_1 , ϕ_2 , and ϕ_3 are three elements of $\mathcal{F}_p(\mathbb{R}^2)$ such that at least one of them is not zero. Note that

$$\partial(\phi_1 \cdot T_1 + \phi_2 \cdot T_2 + \phi_3 \cdot T_3) = 0 \Leftrightarrow \phi_1 = \phi_2 = \phi_3 \quad \text{and} \quad p = 2,$$

from which we deduce that

$$H_{2,2}(\mathbb{TP}^2) = \Lambda^2(\mathbb{R}^2) \simeq \mathbb{R} \quad \text{and} \quad H_{0,2}(\mathbb{TP}^2) = H_{1,2}(\mathbb{TP}^2) = 0.$$

As in the classical case, there are homogeneous coordinates $[x : y : z]$ on the tropical projective plane \mathbb{TP}^2 . Any (p,q) -cycle in \mathbb{TP}^2 with $p < 2$ is homologous to a (p,q) -cycle in \mathbb{TP}^2 whose support does not contain the point $[-\infty : -\infty : 0]$. As in Examples 7.22 and 7.23, the maps

$$\begin{array}{ccc} \mathbb{TP}^2 \setminus \{[-\infty : -\infty : 0]\} & \longrightarrow & \mathbb{TP}^2 \setminus \{[-\infty : -\infty : 0]\} \\ [x : y : z] & \longmapsto & [x : y : z + t] \end{array}$$

can be used to show that any (p,q) -cycle in $\mathbb{TP}^2 \setminus \{[-\infty : -\infty : 0]\}$ is homologous to a (p,q) -cycle with support contained in $\{z = -\infty\}$. Since this latter is a tropical projective line, by Example 7.26 we have

$$H_{0,0}(\mathbb{TP}^2) \simeq H_{1,1}(\mathbb{TP}^2) \simeq \mathbb{R}$$

(one sees easily that the generators of these groups remain non-homologous to zero when we pass to \mathbb{TP}^2) and

$$H_{0,1}(\mathbb{TP}^2) = H_{1,0}(\mathbb{TP}^2) = H_{2,0}(\mathbb{TP}^2) = H_{2,1}(\mathbb{TP}^2) = 0.$$

7.6. Straight cycles

Let X be a tropical manifold, and suppose that $Z \subset X$ is a finite *weighted balanced polyhedral subcomplex of dimension p* in X . This means that Z is a weighted balanced polyhedral subcomplex of pure dimension p of X in each chart of X , and the weight of a point in a facet does not depend on a choice of the chart. A choice of an orientation on a facet F of Z produces a canonical framing in $\mathbb{Z}\mathcal{F}_p(X)$, equal to the weight of F multiplied by the primitive integer element of $\Lambda^p(\mathcal{F}_1(F))$ that agrees with the chosen orientation of F . (Recall that $\mathcal{F}_1(F)$ comes with a lattice of full rank, see Remark 7.20.)

We form the *fundamental class* $[Z]$ of Z as follows. Choose an orientation for each facet of Z , subdivide each facet into singular p -simplices, and enhance each p -simplex with the corresponding canonical framing in $\mathbb{Z}\mathcal{F}_p(X)$. The sum of all these (p, p) -cells is an integer (p, p) -chain $[Z]$. The balancing condition is equivalent to the condition $\partial[Z] = 0$, *i.e.* $[Z]$ is a cycle (compare with Example 7.18). Note that the choice of orientation of facets of Z , and their subdivision into singular p -simplices is irrelevant for the resulting cycle class $[Z]$ in $H_{p,p}(X)$. This is because the orientation of each facet is used in the construction of $[Z]$ twice: once in the orientation of the underlying facet, and once in the choice of the p -framing.

Definition 7.28 (cf. [MZ14]). The (p, p) -cycles that can be presented as fundamental class $[Z]$ for some weighted balanced subcomplex $Z \subset X$ are called *straight cycles*.

Straight cycles generate a subspace in $H_{p,p}(X)$ that behaves in a semicontinuous way with respect to deformation of the tropical structure of X . The problem of detecting whether a cycle in $H_{p,p}(X)$ is straight is a very interesting question related to the famous Hodge conjecture.

7.7. Tropical cohomology

There is also a dual theory of tropical cohomology. We may consider the spaces

$$\mathcal{F}^p(x) = \text{Hom}(\mathcal{F}_p(x); \mathbb{R})$$

together with the morphisms

$$\mathcal{F}^p(y) \rightarrow \mathcal{F}^p(x) \tag{3}$$

dual to morphisms (2). The coefficient system \mathcal{F}^p forms a *constructible sheaf* and we may take cohomology groups with coefficients in \mathcal{F}^p . Namely, we form the cochain groups

$$C^{p,q}(X) = \text{Hom}(C_{p,q}(X), \mathbb{R}).$$

An element of this group can be interpreted as a functional associating an element of $\mathcal{F}^p(f) = \text{Hom}(\mathcal{F}_p(f(c)), \mathbb{R})$ to each compatible singular q -simplex $f : \sigma_q \rightarrow X$, where c is the barycenter of the q -dimensional simplex σ_q . Accordingly, we have a coboundary map

$$\delta : C^{p,q}(X) \rightarrow C^{p,q+1}(X)$$

with $\delta \circ \delta = 0$.

Definition 7.29 (Tropical cohomology, cf. [IKMZ]). The *tropical cohomology group* $H^{p,q}(X)$ is the q -th cohomology group of the complex

$$\dots \rightarrow C^{p,q-1}(X) \rightarrow C^{p,q}(X) \rightarrow C^{p,q+1}(X) \rightarrow \dots$$

As usual, cohomology groups admit the cup product. It is based on the following observation. Suppose that f_1 and f_2 are two singular simplices of dimensions q_1 and q_2 , respectively, which are faces of a compatible singular simplex f . Then, we have the composed homomorphism

$$\mathcal{F}^{p_1}(f_1) \otimes \mathcal{F}^{p_2}(f_2) \rightarrow \mathcal{F}^{p_1}(f) \otimes \mathcal{F}^{p_2}(f) \rightarrow \mathcal{F}^{p_1+p_2}(f).$$

The first homomorphism in this composition is obtained with the help of (3), while the second homomorphism is given by the exterior product. This product in coefficients descends to the cup product

$$H^{p_1,q_1}(X) \otimes H^{p_2,q_2}(X) \rightarrow H^{p_1+p_2,q_1+q_2}(X)$$

with the usual super-commutativity property

$$\alpha \cup \beta = (-1)^{p_1 p_2 + q_1 q_2} \beta \cup \alpha$$

for $\alpha \in H^{p_1,q_1}(X)$ and $\beta \in H^{p_2,q_2}(X)$.

Example 7.30. As for tropical homology, we have

$$H^{0,q} = H^q(X; \mathbb{R}).$$

Example 7.31. As in Examples 7.22 and 7.23 we compute

$$H^{p,0}(\mathbb{R}^n) = \Lambda^p(\mathbb{R}^n) \quad \text{and} \quad H^{p,q}(\mathbb{R}^n) = 0 \quad \text{for any } q \geq 1,$$

and

$$H^{0,0}(\mathbb{T}^n) = \mathbb{R} \quad \text{and} \quad H^{p,q}(\mathbb{T}^n) = 0 \quad \text{if } p+q \geq 1.$$

Example 7.32. Let L be the tropical line from Example 7.12. Denote by e_i , $i = 1, \dots, 5$, the edge of L with vertices x_i and x_1 oriented toward x_1 . We use the same identifications of $\mathcal{F}_1(x_2)$, $\mathcal{F}_1(x_3)$, and $\mathcal{F}_1(x_4)$ with \mathbb{R} as in Example 7.18. Given $\Phi_p \in C^{p,0}(X)$, we have

$$\delta\Phi_0(e_i)(1) = \Phi_0(x_1)(1) - \Phi_0(x_i)(1),$$

and

$$\begin{aligned} \delta\Phi_1(e_5)(1) &= \Phi_1(x_1)(0,1), & \delta\Phi_1(e_6)(1) &= \Phi_1(x_1)(1,0), \\ \delta\Phi_1(e_4)(1) &= \Phi_1(x_1)(-1,-1) - \Phi_1(x_4)(1). \end{aligned}$$

From this we deduce

$$H^{0,0}(L) = \mathbb{R} \quad \text{and} \quad H^{0,1}(L) = H^{1,0}(L) = H^{1,1}(L) = 0.$$

Whereas the cohomology groups of $L' = L \cap \mathbb{R}^2$ are

$$H^{0,0}(L') = \mathbb{R}, \quad H^{1,0}(L') = \mathbb{R}^2, \quad \text{and} \quad H^{0,1}(L') = H^{1,1}(L') = 0.$$

The homology groups of L and L' are calculated in Examples 7.24 and 7.25, respectively. Next example generalizes the computation of the groups $H^{p,q}(L')$ for any tropical limit of a linear space.

Example 7.33. Let a fan $L \subset \mathbb{R}^n$ be the tropical limit of a linear space $\mathcal{L} \subset (\mathbb{C}^\times)^n$ (see Section 5.4). As in Example 7.31, we have

$$H^{p,0}(L) = \mathcal{F}^p(x) \quad \text{and} \quad H^{p,q}(L) = 0 \text{ for any } q \geq 1,$$

where x is the vertex of the fan L . Along with the cup product, $H^\bullet(L)$ is isomorphic to the cohomology ring of \mathcal{L} which is known as an Orlik-Solomon algebra, cf. [Zha13].

As seen in the last example, it turns out that tropical cohomology groups capture the cohomology groups of complex varieties $\mathcal{X}_t \subset \mathbb{C}P^n$ in the case when our tropical manifold $X \subset \mathbb{T}P^n$ comes as the tropical limit of a family $(\mathcal{X}_t)_{t \in U}$. Here for a parameterizing set U we take a subset $U \subset \mathbb{C}$ such that $\mathbb{C} \setminus U$ is bounded, *i.e.* U is a punctured neighborhood of ∞ in $\mathbb{C}P^1 = \mathbb{C} \cup \{\infty\}$. The definition of tropical limit that we use here is a projective version of Definition 5.16. This means that X is the limit of the subsets $\text{Log}_{|t|} \mathcal{X}_t \subset \mathbb{T}P^n$ (called *amoebas* of \mathcal{X}_t), where $\text{Log}(z_0 : \cdots : z_N) = (\log |z_0| : \cdots : \log |z_N|)$. As in Definition 5.16 the tropical limit should be enhanced with weights. Given a tropical manifold X , we define

$$h^{p,q}(X) = \dim H^{p,q}(X).$$

Theorem 7.34 ([IKMZ]). *Let X be a tropical submanifold of $\mathbb{T}P^n$ (in particular, the weights of facets of X are all equal to 1). If X is the tropical limit of a complex analytic family $(\mathcal{X}_t)_{t \in U}$ of projective varieties, then for sufficiently large $|t|$ the complex variety $\mathcal{X}_t \subset \mathbb{C}P^n$ is smooth. Furthermore, we have the following relation between the Hodge numbers of \mathcal{X}_t (for sufficiently large $|t|$) and the dimensions of tropical cohomology groups of X :*

$$h^{p,q}(\mathcal{X}_t) = h^{p,q}(X).$$

As a consequence, if an n -dimensional tropical submanifold X of $\mathbb{T}P^n$ is the tropical limit of a complex analytic family \mathcal{X}_t of projective varieties, then X must satisfy

$$h^{p,q}(X) = h^{q,p}(X) = h^{n-p,n-q}(X) \text{ for any } p, q \geq 0.$$

7.8. Cohomology of tropical curves

Let Γ be a connected compact tropical curve (see Section 7.2). According to Example 7.30, we have $H^{0,0}(\Gamma) = \mathbb{R}$ and $H^{0,1}(\Gamma) \simeq \mathbb{R}^g$, where $g = b_1(\Gamma)$ is the genus of Γ .

Consider the space $H^{1,0}(\Gamma) = H^0(\Gamma; \mathcal{F}^1)$. There is a map $C^{1,0}(\Gamma) \rightarrow C_{0,1}(\Gamma)$ which descends to an isomorphism between the cohomology and homology groups. To describe this map, first fix an orientation of every edge of Γ . For an oriented edge E of Γ , choose a point x inside E and enhance x with the unit tangent vector in the direction of E to produce a 0-chain with coefficients in $\mathcal{F}_1(x)$. Denote this chain by $\tau_E \in C_{1,0}(\Gamma)$. A cochain $\beta \in C^{1,0}(\Gamma)$ can be evaluated at τ_E , and we set

$$Z_\beta = \sum_{E \in \text{Edge}(\Gamma)} \beta(\tau_E)E.$$

The condition that β is a cocycle implies that Z_β is a cycle, and thus $\dim H^{1,0}(\Gamma) = \dim H_{0,1}(\Gamma) = g$.

Finally, we compute the group $H^{1,1}(\Gamma) = \mathbb{R}$ directly from the sequence,

$$C^{1,0}(\Gamma) \rightarrow C^{1,1}(\Gamma) \rightarrow 0,$$

along with the observation that it suffices to take $C^{1,0}(\Gamma)$ and $C^{1,1}(\Gamma)$ as simplicial cochains. Therefore, these groups are finite dimensional and we have explicitly,

$$C^{1,0}(\Gamma) = \bigoplus_{v \in \text{Vert}(\Gamma)} \mathbb{R}^{\text{val}(v)-1} = \mathbb{R}^{2E-V} \quad \text{and} \quad C^{1,1}(\Gamma) = \mathbb{R}^E,$$

where $\text{Vert}(\Gamma)$ is the set of vertices of Γ , and V (respectively, E) denotes the number of vertices (respectively, edges) of Γ . The kernel of the map $C^{1,0}(\Gamma) \rightarrow C^{1,1}(\Gamma)$ is $H^{1,0}(\Gamma) \simeq \mathbb{R}^g$ by our previous computation. Thus $H^{1,1}(\Gamma) \simeq \mathbb{R}$. Notice also that a $(1,1)$ -cochain can be evaluated on the fundamental $(1,1)$ -cycle $[\Gamma]$ described in Section 7.6. One sees easily that the image of δ is contained in subspace $\{\phi \mid \phi([\Gamma]) = 0\} \subseteq C^{1,1}(\Gamma)$. Moreover, both subspaces are of codimension one in $C^{1,1}(\Gamma)$, so they are equal. Therefore, we obtain a non-degenerate pairing between the cohomology and homology groups $H^{1,1}(\Gamma) \times H_{1,1}(\Gamma) \rightarrow \mathbb{R}$.

We have determined the tropical cohomology groups of the curve Γ . Their dimensions can be arranged in a diamond shape which is exactly the same as the Hodge diamond of a Riemann surface of genus g :

$$\begin{array}{ccc} & 1 & \\ & g & g \\ & 1 & \end{array}$$

Remark 7.35 (Electric networks interpretation). We may think of the tropical curve Γ as an electric network, where each edge has resistance equal to its length. Note, in particular, that resistance is additive, so it agrees with the length interpretation: if an edge is subdivided into two smaller edges by a two-valent vertex, then its resistance is the sum of two smaller resistances. Usual cohomology and homology of graphs have interpretations in terms of electrical circuits, and tropical cohomology groups provide an even better framework for such interpretation. The measure of the magnitude and direction of a stationary electrical current flowing through Γ can be viewed as a $(1,0)$ -cochain $I \in C^{1,0}$. Indeed, for a point $x \in \Gamma$ that is not a vertex and a unit tangent vector u at x (an element of $\mathcal{F}_1(x)$) we may insert the ammeter at x in the direction of u and measure the current. It follows from Kirchhoff's current law (divergence-free current) that such a cochain I is a cocycle.

Similarly, with a voltmeter we can measure voltage between any two points of Γ . Measuring it at the endpoints of an oriented edge gives us a 1-cochain $V_0 \in C^{0,1}(\Gamma) = C^1(\Gamma; \mathbb{R})$. Note that V_0 must be a coboundary by Kirchhoff's voltage law, which also implies it is a cocycle. This reflects the fact that no stationary electric current can be present in such networks. Since energy dissipates in resistance, to support a stationary current we need power sources in our network. We may think of these power elements to

be localized in some edges. For an edge $E \subset \Gamma$ we define $V(E)$ to be $V_0(E)$ minus the voltage of the power element (taken with sign).

Let $E \subset \Gamma$ be an oriented edge disjoint from power elements. Suppose that R is the resistance of E . Let I be a current through E and V be the voltage drop at the endpoints of E . Recall Ohm's law: $V = RI$. This may be interpreted through the so-called *eigenwave* of the tropical variety Γ , see [MZ14]. This is a particular 1-cochain Φ with the coefficients in \mathcal{W}_1 , the constructible sheaf with $\mathcal{W}_1(x) = T_x^*(E)$ if x is a point inside an edge E and $\mathcal{W}_1(x) = 0$ if x is a vertex of Γ (which we assume to have valence greater than 2). The eigenwave Φ is determined by

$$\Phi(E) = \int_E \omega, \tag{4}$$

where $E \subset \Gamma$ is an edge and $\omega \in \text{Hom}(\mathcal{W}_1(E), \mathbb{R}) = T_x^*(E)$ is the coefficient at the 1-simplex E . In (4) we interpret ω as the (constant) 1-form on the edge E . Recall that the length of E represents the resistance.

In this way Ohm's law comes as taking the cup-product with Φ producing the homomorphism

$$H^{1,0}(\Gamma) \rightarrow H^{0,1}(\Gamma)$$

responsible for the definition of the Jacobian of Γ , see [MZ08].

Exercises 7.

- (1) Consider $\mathbb{R}_{>0}$ equipped with the inclusion chart $\mathbb{R}_{>0} \hookrightarrow \mathbb{R}$. Prove that there is no way to complete this atlas to turn $\mathbb{R}_{>0}$ into a tropical manifold.
- (2) Revise Example 7.8 by showing that three tropical modifications of the circle from Figure 35a suffice to find a morphism to a cubic curve in \mathbb{R}^2 .
- (3) For each example of computation of tropical homology and cohomology performed in Section 7.4, compute the corresponding tropical integral homology and cohomology (see Remark 7.20).
- (4) Let X be the Klein bottle obtained by quotienting the unit square $[0, 1]^2 \subset \mathbb{R}^2$ by the subgroup of $O_2(\mathbb{R})$ generated by $(x, y) \mapsto (x, y+1)$ and $(x, y) \mapsto (x+1, -y+1)$. Show that X inherits a tropical structure from the tropical structure of \mathbb{R}^2 , and compute tropical (real and integral) homology and cohomology of X .
- (5) Compute tropical homology and cohomology of \mathbb{TP}^n . In particular, show that the tropical cohomology ring of \mathbb{TP}^n is isomorphic to the cohomology ring of \mathbb{CP}^n .
- (6) Find explicit generators of the homology and cohomology groups of a compact tropical curve.
- (7) Consider two tropical curves Γ and Γ' such that Γ' is a tropical modification of Γ . Show that the groups $H_{p,q}(\Gamma)$ and $H_{p,q}(\Gamma')$ are canonically isomorphic, as well as the groups $H^{p,q}(\Gamma)$ and $H^{p,q}(\Gamma')$.
- (8) Express the energy loss (the Joule-Lenz law) in terms of the cup product in tropical cohomology (followed by evaluation on the fundamental class) on an electric network considered as a tropical curve.

- (9) Let X be the product of two compact tropical curves of genus 1 without 1-valent vertices (*i.e.* as in Figure 35a). In particular X is diffeomorphic to $S^1 \times S^1$. Show that all $(1,1)$ -cycles in X are straight. Construct a deformation of X (*i.e.*, a tropical 3-fold Y and a tropical map $h : Y \rightarrow \mathbb{R}$ with $X = h^{-1}(0)$) such that the general fiber Z does not have a single straight $(1,1)$ -cycle. Deduce that if Z' is a connected tropical manifold that admits a non-constant map $Z' \rightarrow Z$ which is given by affine maps in charts, then Z' is not projective (*i.e.* is not embeddable to \mathbb{P}^n).

References

- [AB13] F. Ardila and F. Block. Universal polynomials for Severi degrees of toric surfaces. *Adv. Math.*, 237:165–193, 2013.
- [AB14] F. Ardila and E. Brugallé. The double Gromov-Witten invariants of Hirzebruch surfaces are piecewise polynomial. arXiv:1412.4563, 2014.
- [AK06] F. Ardila and C.J. Klivans. The bergman complex of a matroid and phylogenetic trees. *J. Comb. Theory Ser. B*, 96(1):38–49, 2006.
- [AR10] L. Allermann and J. Rau. First steps in tropical intersection theory. *Mathematische Zeitschrift*, 264:633–670, 2010.
- [Ber71] G. M. Bergman. The logarithmic limit-set of an algebraic variety. *Trans. Amer. Math. Soc.*, 157:459–469, 1971.
- [Ber75] D. N. Bernstein. The number of roots of a system of equations. *Funkcional. Anal. i Priložen.*, 9(3):1–4, 1975.
- [BG14] F. Block and L. Göttsche. Refined curve counting with tropical geometry. arXiv:1407.2901, 2014.
- [BLdM12] E. Brugallé and L. Lopez de Medrano. Inflection points of real and tropical plane curves. *Journal of Singularities*, 3:74–103, 2012.
- [Blo11] F. Block. Relative node polynomials for plane curves. In *23rd International Conference on Formal Power Series and Algebraic Combinatorics (FPSAC 2011)*, Discrete Math. Theor. Comput. Sci. Proc., AO, pages 199–210. Assoc. Discrete Math. Theor. Comput. Sci., Nancy, 2011.
- [BM] E. Brugallé and G. Mikhalkin. Realizability of superabundant curves. In preparation.
- [BM08] E. Brugallé and G. Mikhalkin. Floor decompositions of tropical curves : the planar case. *Proceedings of 15th Gökova Geometry-Topology Conference*, pages 64–90, 2008.
- [BM14] E. Brugallé and H. Markwig. Deformation of tropical Hirzebruch surfaces and enumerative geometry. To appear in *Journal of Algebraic Geometry*, 2014.
- [BPS08] N. Berline, A. Plagne, and C. Sabbah, editors. *Géométrie tropicale*. Éditions de l'École Polytechnique, Palaiseau, 2008. available at <http://www.math.polytechnique.fr/xups/vol08.html>.
- [Bru09] E. Brugallé. Un peu de géométrie tropicale. *Quadrature*, (74):10–22, 2009.
- [Bru12] E. Brugallé. Some aspects of tropical geometry. *Newsletter of the European Mathematical Society*, (83):23–28, 2012.
- [Bru14] E. Brugallé. Floor diagrams of plane curves relative to a conic and GW-W invariants of Del Pezzo surfaces. arXiv:1404.5429, 2014.
- [BS14a] E. Brugallé and K. Shaw. A bit of tropical geometry. *Amer. Math. Monthly*, 121(7):563–589, 2014.
- [BS14b] E. Brugallé and K. Shaw. Obstructions to approximating tropical curves in surfaces via intersection theory. To appear in *Canadian Journal of Mathematics*, 2014.
- [CH98] L. Caporaso and J. Harris. Counting plane curves of any genus. *Invent. Math.*, 131(2):345–392, 1998.

Brief introduction to tropical geometry

- [CM14] A. Cueto and H. Markwig. How to repair tropicalizations of plane curves using modifications. arXiv:1409.7430, 2014.
- [DK00] A. I. Degtyarev and V. M. Kharlamov. Topological properties of real algebraic varieties: Rokhlin’s way. *Russian Math. Surveys*, 55(4):735–814, 2000.
- [FM10] S. Fomin and G. Mikhalkin. Labelled floor diagrams for plane curves. *Journal of the European Mathematical Society*, 12:1453–1496, 2010.
- [Gat06] A. Gathmann. Tropical algebraic geometry. *Jahresber. Deutsch. Math.-Verein.*, 108(1):3–32, 2006.
- [GKZ94] I. M. Gelfand, M. M. Kapranov, and A. V. Zelevinsky. *Discriminants, resultants, and multidimensional determinants*. Mathematics: Theory & Applications. Birkhäuser Boston Inc., Boston, MA, 1994.
- [Haa97] B. Haas. Real algebraic curves and combinatorial constructions. Thèse doctorale, Université de Strasbourg, 1997.
- [IKMZ] I. Itenberg, L. Katzarkov, G. Mikhalkin, and I. Zharkov. Tropical homology. In preparation.
- [IKS03] I. Itenberg, V. Kharlamov, and E. Shustin. Welschinger invariant and enumeration of real rational curves. *Int. Math. Research Notices*, 49:2639–2653, 2003.
- [IKS04] I. Itenberg, V. Kharlamov, and E. Shustin. Logarithmic equivalence of Welschinger and Gromov-Witten invariants. *Uspehi Mat. Nauk*, 59(6):85–110, 2004. (in Russian). English version: *Russian Math. Surveys* 59 (2004), no. 6, 1093-1116.
- [IM12] I. Itenberg and G. Mikhalkin. Geometry in the tropical limit. *Math. Semesterber.*, 59(1):57–73, 2012.
- [IM13] I. Itenberg and G. Mikhalkin. On Block-Göttsche multiplicities for planar tropical curves. *Int. Math. Res. Not. IMRN*, (23):5289–5320, 2013.
- [IMS07] I. Itenberg, G. Mikhalkin, and E. Shustin. *Tropical Algebraic Geometry*, volume 35 of *Oberwolfach Seminars Series*. Birkhäuser, 2007.
- [IV96] I. Itenberg and O. Ya. Viro. Patchworking algebraic curves disproves the Ragsdale conjecture. *Math. Intelligencer*, 18(4):19–28, 1996.
- [Kap00] M. Kapranov. Amoebas over non-archimedean fields. Preprint, 2000.
- [KM94] M. Kontsevich and Yu. Manin. Gromov-Witten classes, quantum cohomology, and enumerative geometry. *Comm. Math. Phys.*, 164(3):525–562, 1994.
- [KMM09] Eric Katz, Hannah Markwig, and Thomas Markwig. The tropical j -invariant. *LMS J. Comput. Math.*, 12:275–294, 2009.
- [KP99] S. Kleiman and R. Piene. Enumerating singular curves on surfaces. In *Algebraic geometry: Hirzebruch 70 (Warsaw, 1998)*, volume 241 of *Contemp. Math.*, pages 209–238. Amer. Math. Soc., Providence, RI, 1999.
- [KST11] M. Kool, V. Shende, and R. P. Thomas. A short proof of the Göttsche conjecture. *Geom. Topol.*, 15(1):397–406, 2011.
- [LO14] F. Liu and B. Osserman. Severi degrees on toric surfaces. arXiv:1401.7023, 2014.
- [Mik00] G. Mikhalkin. Real algebraic curves, the moment map and amoebas. *Ann. of Math. (2)*, 151(1):309–326, 2000.
- [Mik04a] G. Mikhalkin. Amoebas of algebraic varieties and tropical geometry. In *Different faces of geometry*, volume 3 of *Int. Math. Ser. (N. Y.)*, pages 257–300. Kluwer/Plenum, New York, 2004.
- [Mik04b] G. Mikhalkin. Decomposition into pairs-of-pants for complex algebraic hypersurfaces. *Topology*, 43(6):1035–106, 2004.
- [Mik05] G. Mikhalkin. Enumerative tropical algebraic geometry in \mathbb{R}^2 . *J. Amer. Math. Soc.*, 18(2):313–377, 2005.
- [Mik06] G. Mikhalkin. Tropical geometry and its applications. In *International Congress of Mathematicians. Vol. II*, pages 827–852. Eur. Math. Soc., Zürich, 2006.

- [Mik07] G. Mikhalkin. Moduli spaces of rational tropical curves. *Proceedings of Gökova Geometry/Topology conference 2006*, pages 39–51, 2007.
- [MS15] D. Maclagan and B. Sturmfels. *Introduction to Tropical Geometry*, volume 161 of *Graduate Studies in Mathematics*. American Mathematical Society, Providence, RI, 2015.
- [MZ08] G. Mikhalkin and I. Zharkov. Tropical curves, their Jacobians and theta functions. In *Curves and abelian varieties*, volume 465 of *Contemp. Math.*, pages 203–230. Amer. Math. Soc., Providence, RI, 2008.
- [MZ14] G. Mikhalkin and I. Zharkov. Tropical eigenwave and intermediate jacobians. In *Homological Mirror Symmetry and Tropical Geometry*, volume 15 of *Lecture Notes of the Unione Matematica Italiana*, pages 309–349. 2014.
- [Nis09] T. Nishinou. Correspondence theorems for tropical curves. arXiv:0912.5090, 2009.
- [Oxl92] J. Oxley. *Matroid theory*. Oxford University Press, New York, 1992.
- [PR04] Mikael Passare and Hans Rullgård. Amoebas, Monge-Ampère measures, and triangulations of the Newton polytope. *Duke Math. J.*, 121(3):481–507, 2004.
- [RGST05] J. Richter-Gebert, B. Sturmfels, and T. Theobald. First steps in tropical geometry. In *Idempotent mathematics and mathematical physics*, volume 377 of *Contemp. Math.*, pages 289–317. Amer. Math. Soc., Providence, RI, 2005.
- [Sha13] K. Shaw. A tropical intersection product in matroidal fans. *SIAM J. Discrete Math.*, 27(1):459–491, 2013.
- [Spe08] D. Speyer. Tropical linear spaces. *SIAM J. Discrete Math.*, 22(4):1527–1558, 2008.
- [Spe14] D. Speyer. Parameterizing tropical curves I: Curves of genus zero and one. *Algebra Number Theory*, 8(4):963–998, 2014.
- [Stu02] B. Sturmfels. *Solving systems of polynomial equations*, volume 97 of *CBMS Regional Conference Series in Mathematics*. American Mathematical Society, Providence, RI., 2002.
- [Vig07] M. D. Vigeland. Tropical lines on smooth tropical surfaces. arXiv:0708.3847, 2007.
- [Vig09] M. D. Vigeland. Smooth tropical surfaces with infinitely many tropical lines. *Arkiv för Matematik*, 48(1):177–206, 2009.
- [Vir] O. Ya. Viro. Introduction to topology of real algebraic varieties. <http://www.math.sunysb.edu/~oleg/es/index.html>.
- [Vir01] O. Ya. Viro. Dequantization of real algebraic geometry on logarithmic paper. In *European Congress of Mathematics, Vol. I (Barcelona, 2000)*, volume 201 of *Progr. Math.*, pages 135–146. Birkhäuser, Basel, 2001.
- [Vir08] O. Ya. Viro. From the sixteenth Hilbert problem to tropical geometry. *Japanese Journal of Mathematics*, 3(2), 2008.
- [Vir11] O. Ya. Viro. On basic concepts of tropical geometry. *Tr. Mat. Inst. Steklova*, 273(Sovremennye Problemy Matematiki):271–303, 2011.
- [Wel05] J. Y. Welschinger. Invariants of real symplectic 4-manifolds and lower bounds in real enumerative geometry. *Invent. Math.*, 162(1):195–234, 2005.
- [Zar82] O. Zariski. Dimension-theoretic characterization of maximal irreducible algebraic systems of plane nodal curves of a given order n and with a given number d of nodes. *Amer. J. Math.*, 104(1):209–226, 1982.
- [Zha13] I. Zharkov. The Orlik-Solomon algebra and the Bergman fan of a matroid. *J. Gökova Geom. Topol. GGT*, 7:25–31, 2013.

Brief introduction to tropical geometry

ERWAN BRUGALLÉ, ÉCOLE POLYTECHNIQUE, CENTRE DE MATHÉMATIQUES LAURENT SCHWARTZ, 91
128 PALAISEAU CEDEX, FRANCE

E-mail address: `erwan.brugalle@math.cnrs.fr`

ILIA ITENBERG, INSTITUT DE MATHÉMATIQUES DE JUSSIEU - PARIS RIVE GAUCHE, UNIVERSITÉ PIERRE
ET MARIE CURIE, 4 PLACE JUSSIEU, 75252 PARIS CEDEX 5, FRANCE AND DÉPARTEMENT DE MATHÉMATI-
QUES ET APPLICATIONS, ÉCOLE NORMALE SUPÉRIEURE, 45 RUE D'ULM, 75230 PARIS CEDEX 5, FRANCE

E-mail address: `ilia.itenberg@imj-prg.fr`

GRIGORY MIKHALKIN, UNIVERSITÉ DE GENÈVE, SECTION DE MATHÉMATIQUES, VILLA BATTELLE, 7
ROUTE DE DRIZE, 1227 CAROUGE, SWITZERLAND.

E-mail address: `grigory.mikhalkin@unige.ch`

KRISTIN SHAW, TECHNISCHE UNIVERSITÄT BERLIN, MA 6-2, 10623 BERLIN, GERMANY.

E-mail address: `shaw@math.tu-berlin.de`