**Brooks Automation
CTI-Cryogenics
8200 Compressor
Installation, Operation, and
Service Instructions**

Information provided within this document is subject to change without notice, and although believed to be accurate, Brooks Automation assumes no responsibility for any errors, omissions, or inaccuracies.

AcuLigner, AcuLine, AcuTran, AcuTrav, AeroLoader IV, AeroTrak, ARV 2000, AquaTran, Atmospheric Express, BALI 400 Indexer, BiSymmetrik, ExpressLock, FabExpress, FixLoad, FrogLeg, Gemini, Gemini Express, Gemini Express Tandem, Guardian Bare Reticle Stocker, Hercules, Hercules Express, InCooler, InLigner, InLine Express, Leapfrog, Linear eXchange, MagnaTran 7, MagnaTran 70, MagnaTran 8, MagnaTran X, Marathon, Marathon Express, Marathon Express Tandem, MicroTool, MultiTran, OneFab AMHS, OpenMTS, PASIV, PF-100, PowerPak, Reliance ATR, Reliance DFR, Reliance WCR, SENTRY, TCM, Time Optimal Trajectory, Top-Cooler, TurboStocker, TurboStocker XT, Ultrasort, VacuTran, VCD, VCE, VPE, WAVE, WAVE II, Zaris, Z-Bot, Aquatrap, Conductron, Convectron, Cool Solutions, Cryodyne, Cryogem, Cryogenerator, CryoTiger, Cryo-Torr, CTI-Cryogenics, FastRegen™, GOLDLink, Granville-Phillips, GUTS, Helix, Micro-Ion, Mini-Convectron, Mini-Ion™, On-Board, Polycold, RetroEase, RetroFast, Stabil-Ion, ThinLine™, TrueBlueSM, TurboPlus, and Vacuum AssuranceSM are trademarks of Brooks Automation Hardware.

All other trademarks are properties of their respective owners.

© Brooks Automation 2005, All Rights Reserved. The information included in this manual is Brooks Proprietary Information and is provided for the use of Brooks customers only and cannot be used for distribution, reproduction, or sale without the expressed written permission of Brooks Automation. This information may be incorporated into the user's documentation, however any changes made by the user to this information is the responsibility of the user.



Brooks Automation
15 Elizabeth Drive
Chelmsford, MA 01824
Phone +1 (978) 262-2400
Fax +1 (978) 262-2500
For emergencies, contact Technical Support +1 (978) 262-2900
www.brooks.com

March 19, 2007 Revision 108 part number 8040353 Per ECO #18029; Alison Dann

This manual is available in the following formats: CD, Paper, Cleanroom.

This manual is available in the following languages: English.

This technology is subject to United States export Administration Regulations and authorized to the destination only; diversion contrary to U.S. law is prohibited.

Printed in the U.S.A.

Contents

Introduction

General.	1-2
Installation, Operation and Servicing Instructions.	1-3

Safety

Introduction	2-2
Signal Word Descriptions.	2-3
Safety Shape Descriptions.	2-4
References	2-4

Inspection

The Compressor	3-2
--------------------------	-----

Installation

Compressor Installation	4-2
Preparing the Compressor Input-Power Cable	4-2
Final Preparation of Compressor.	4-8
Connecting the Compressor to the Cold Head	4-9

Maintenance Procedures

Scheduled Maintenance	5-2
---------------------------------	-----

Unscheduled Maintenance5-6
Helium Circuit Decontamination5-9

Appendices

Appendix A: Customer Support Information6-2
Appendix B: Troubleshooting Procedures.....6-3
Appendix C: Electrical Schematics for 8200 Compressor6-7
Appendix D: Components in the Electrical Control Module of the 8200 Compressor
6-10
Appendix E: Flow Diagrams for 8200 Air-Cooled and Water-Cooled Compressors6-
12
Appendix F: Additional Cooling Water Quality Parameters6-15

Figures

1-1	Air and Water Cooled 8200 Compressor Dimensions	1-3
1-2	Component Locations	1-4
4-1	Electrical Terminal Enclosure with Cover in Place.....	4-4
4-2	Assembly of Conductors to Terminal Block	4-4
4-3	8200 Compressor Cooling Water Flow and Pressure Requirements	4-7
4-4	8200 Compressor Water Cooling Requirements	4-7
4-5	Typical 8200 Compressor Installation.....	4-10
5-1	Adjusting the Self-Sealing Connectors	5-3
5-2	Disconnecting/Connecting the Adsorber Self-Sealing Coupling.....	5-3
5-3	Removing the Adsorber from the Compressor	5-4
6-1	8200 Compressor Electrical Schematic part number 8032563P001	6-8
6-2	8200 Compressor Electrical Schematic part number 8032564P001	6-9
6-3	Components in the Electrical Control Chassis of the 8200 Compressor Three-Phase Scott-T Configuration	6-10
6-4	Components in the Electrical Control Chassis of the 8200 Compressor Single-Phase RC Configuration	6-11
6-5	Flow Diagram of the 8200 (Air-Cooled) Compressor	6-13
6-6	Flow Diagram of the 8200 (Water-Cooled) Compressor.....	6-14

This Page Intentionally Left Blank

Tables

1-1	Power Requirements (Steady-State Conditions)	1-5
1-2	General Specifications	1-5
2-1	Safety Signal Words	2-3
2-2	Safety Shapes	2-4
4-1	Cooling Water Specifications	4-6
6-1	Compressor Troubleshooting Procedures	6-3
6-2	Additional Cooling Water Quality Parameters	6-15

This Page Intentionally Left Blank

1

Introduction

Overview

This chapter describes this manual and the compressor, including specifications.

Chapter Contents

General.....1-2
Installation, Operation and Servicing Instructions.....1-3

General

The manual provides instructions for installing, operating and servicing the 8200 Compressor. This compressor is available in two versions: air-cooled, part number 8032549G001/G002 and water cooled, part number 803255G001/G002.

If you are installing or operating a Cryo-Torr or On-Board System you should also have available the appropriate cryopump or refrigerator.

When you purchase a system, you will receive two manuals necessary for system installation.

Installation, Operation and Servicing Instructions

Installation, Operation and Servicing Instructions for your 8200 Compressor provide easily accessible information. All personnel with installation, operation, and servicing responsibilities should become familiar with the contents of these instructions to ensure high quality, safe, reliable performance.

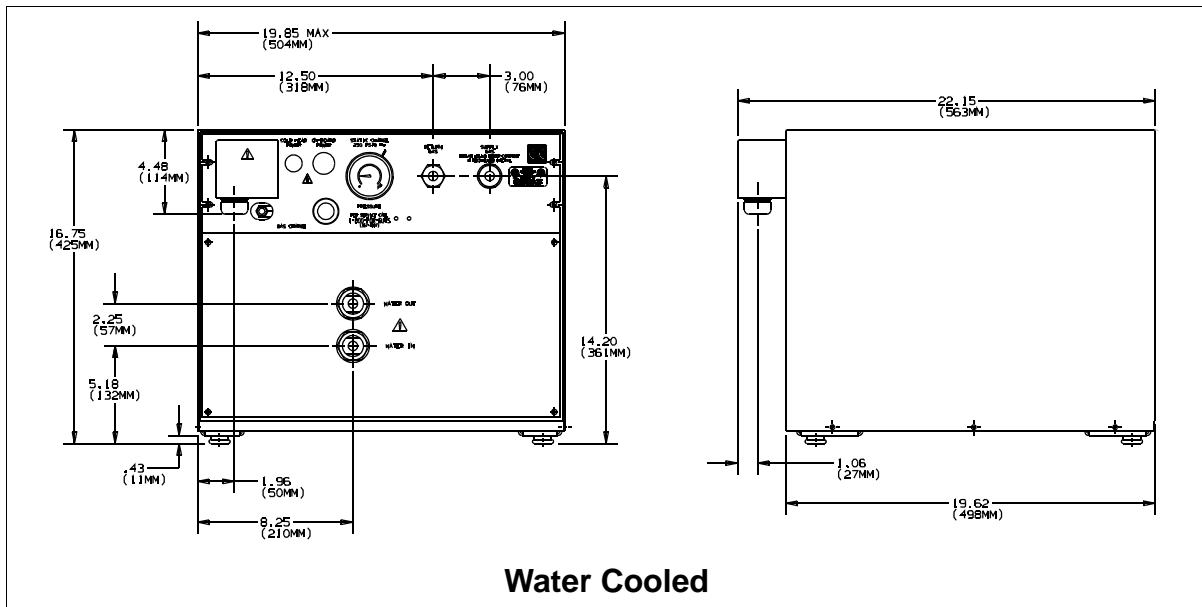
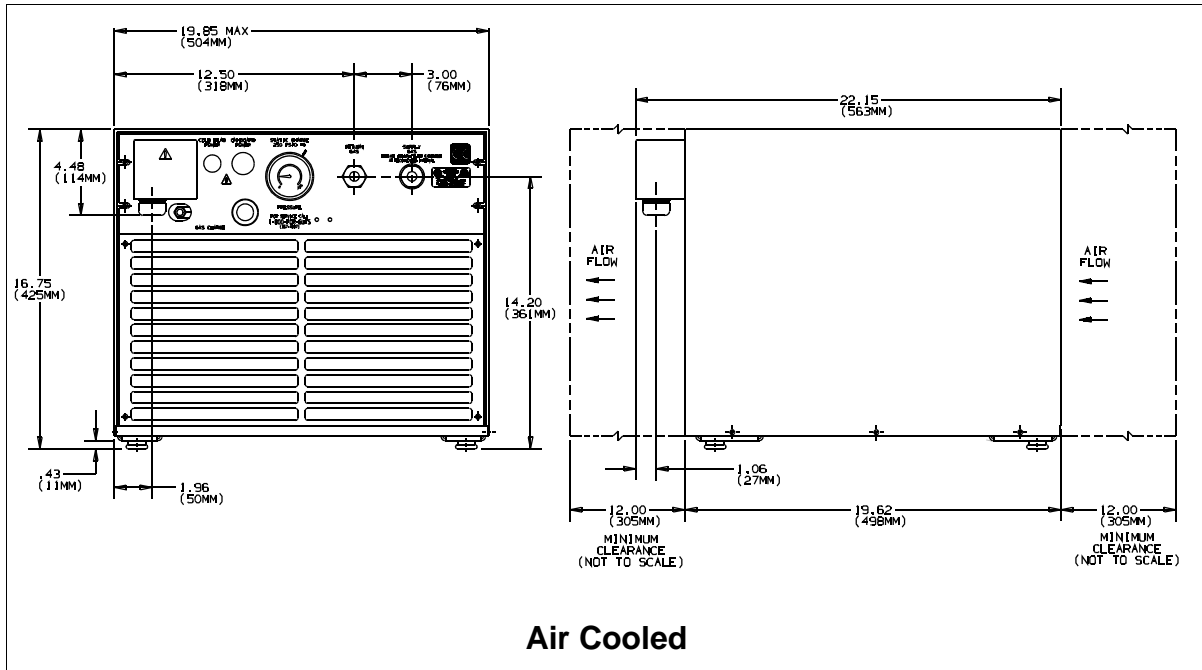
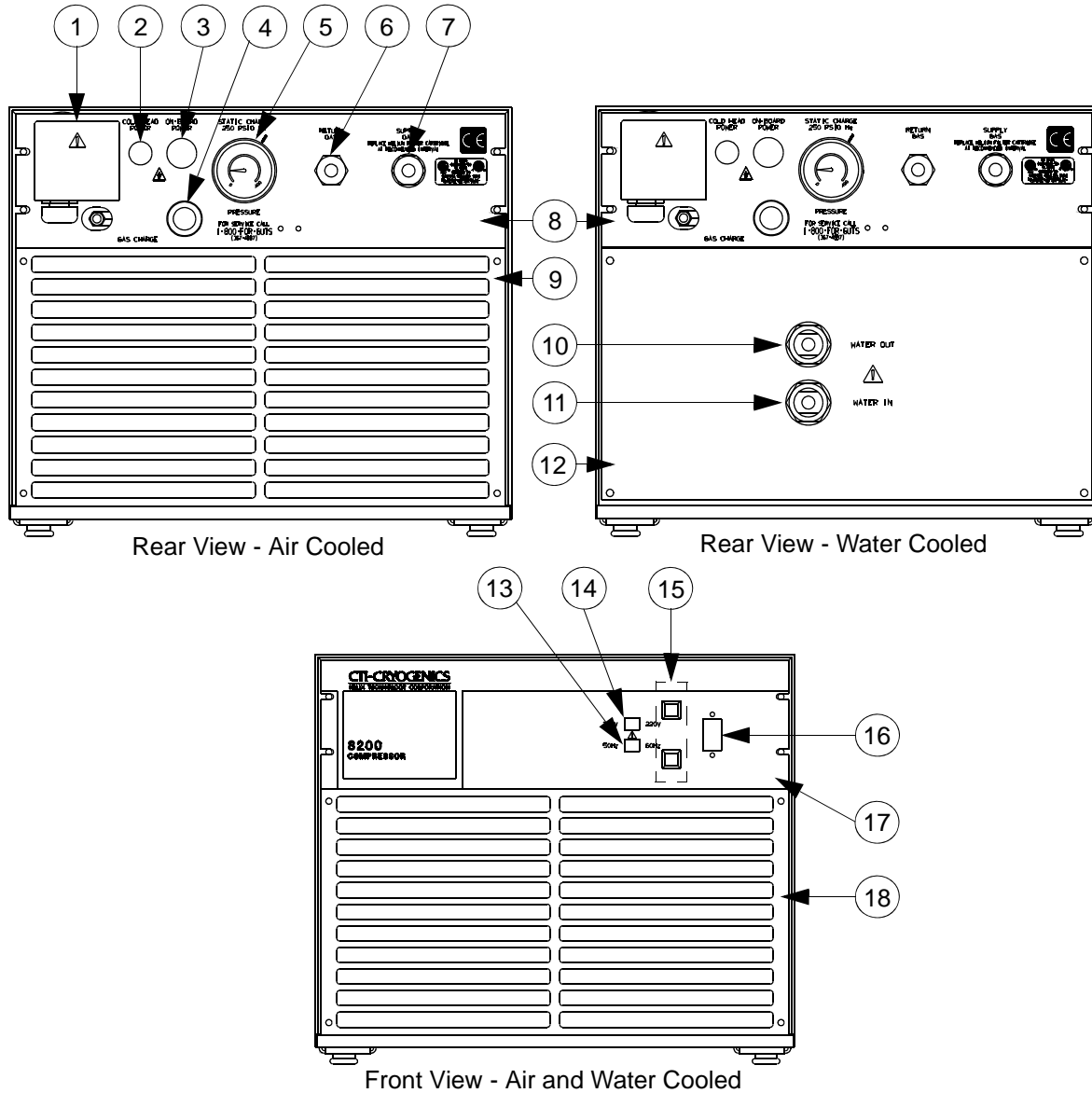

Figure 1-1: Air and Water Cooled 8200 Compressor Dimensions



LEGEND

- | | |
|--|---|
| 1. Compressor Input Power Block | 10. Cooling Water Output |
| 2. Cold Head Power Receptacle | 11. Cooling Water Input |
| 3. On-Board Power Receptacle | 12. Rear Plate |
| 4. Helium Gas Fitting and Charge Valve | 13. 50/60 Hz Frequency Selector Switch |
| 5. Helium Supply Pressure Gauge | 14. 208/220 Voltage Range Selector Switch |
| 6. Helium Gas Return Connector | 15. Resettable Circuit Breakers |

Figure 1-2: Component Locations

Table 1-1: Power Requirements (Steady-State Conditions)

Part Number	Cooling	Phase	Hz	Operating Voltage Range	Nominal Operating Current	Rated Full Load/Locked Current
8032549G001	Air	3	50	180-220	10A	12/30A
	Air	3	60	198-250	10A	
8032549G002	Air	1	50	180-220	10A	12/30A
	Air	1	60	198-250	10A	
8032550G001	Water	3	50	180-220	8.5A	12/30A
	Water	3	60	198-250	8.5A	
8032550G002	Water	1	50	180-220	8.5A	12/30A
	Water	1	60	198-250	8.5A	

*See the nameplate on the back of the compressor for more details.

Table 1-2: General Specifications

Specification	Description
Weight	150 lbs (68 kg) max.
Weight (shipping)	155 lbs (70 kg) max.
Power consumption	2.0 kw, nominal operating(water), 2.1 kw nominal operating (air)
Compressor input-power cable (customer-supplied)	Recommended type SO-4 conductor, 600V, neoprene jacket and 14-gauge wire. Install per Appendix C: Electrical Schematics for 8200 Compressor on page 6-7 , Electrical Schematic diagram, ensuring compliance with all national, state and local standards.
Helium pressure	Static: 245-255 psig (1688-1757 kPa) at 70 to 80°F (21 to 27°C) Supply: nominal operation: 270-290 psig (1860-2000 kPa) at operating temperature.
Ambient operating temperature range	50 to 100°F (10 to 38°C)

Table 1-2: General Specifications (Continued)

Specification	Description
Interface	<p>Cold head power receptacle: Mates with plug on cold head power cable.</p> <p>On-Board power receptacle: Mates with plug on cold-head power cable.</p> <p>Compressor input-power terminal block enclosure: Mates with input power cable, fabricated by customer or available from CTI-Cryogenics.</p> <p>Gas-supply connector: 1/2-inch self-sealing coupling</p> <p>Gas-return connector: 1/2-inch self-sealing coupling</p>
Adsorber service schedule	Replace every 12 months.
Cooling water requirements (water cooled only)	<p>100°F (38°C) maximum discharge temperature</p> <p>Refer to Table 1-1 on page 1-5, Figure 1-1 on page 1-3, and Figure 1-2 on page 1-4, for parameters.</p>

2

Safety

Overview

This section describes safety conventions for the Brooks Automation Product. All personnel involved in the operation or maintenance of the product must be familiar with the safety precautions outlined in this section.

NOTE: *These safety recommendations are basic guidelines. If the facility where the Product is installed has additional safety guidelines they should be followed as well, along with the applicable national and international safety codes.*

Chapter Contents

Introduction	2-2
Signal Word Descriptions.....	2-3
Safety Shape Descriptions.....	2-4
References	2-4

Introduction

Follow all safety precautions during installation, normal operation, and when servicing CTI-Cryogenics products.



This chapter explains the safety conventions used throughout this manual. CTI-Cryogenics uses a specific format for cautions and warnings, which includes standard signal words and safety shapes.

See also the *Customer Support* appendix or call your local Customer Support Center for assistance.

Signal Word Descriptions

All cautions and warnings contain signal words, which call attention to safety messages and designate the degree of hazard seriousness. The following table shows the signal words and their meanings that may be used in this document.



Table 2-1: Safety Signal Words

Term	Example	Definition
CAUTION		A signal word that indicates a situation or unsafe practice, which if not avoided may result in equipment damage . A CAUTION is highlighted in yellow.
CAUTION		A signal word accompanied by a safety shape that indicates a potentially hazardous situation or unsafe practice. If not avoided, the action may result in minor or moderate personal injury or equipment damage . A CAUTION is highlighted in yellow.
WARNING		A signal word accompanied by a safety shape that indicates a potentially hazardous situation. If not avoided, the action may result in serious injury or death . A WARNING is highlighted in orange.

Safety Shape Descriptions

All cautions and warnings contain safety shapes, which have specific safety meanings. The following table shows some of the safety shapes used in this document and their meanings.

Table 2-2: Safety Shapes

Example	Term	Shape Definition
	General Warning	Indicates a general hazard. Details about this hazard appear in the safety notice explanation.
	High Voltage	Indicates a high voltage hazard.
	Hot Surface	Indicates a surface is hot enough to cause discomfort or a burn.

References

For more information about safety standards, see the following documents:

- ISO 7010: 2003(E), Graphic symbols - Safety colours and safety signs - Safety signs used in workplaces and public areas
- ISO 3864-1: 2002(E), Graphic symbols - Safety colours and safety signs - Part 1: Design principles for safety signs in workplaces and public areas

3

Inspection

Overview

This chapter details unpacking the compressor.

A High-Vacuum Pump or Refrigerator System is packaged in separate cartons for each major component. An Installation, Operation, and Servicing Manual is included in the carton for the component packaged in that carton.

Chapter Contents

[The Compressor](#)3-2

The Compressor

On receipt, remove the 8200 Compressor from its shipping carton and inspect the compressor for evidence of damage as described in this Section.

1. Unpack and remove the compressor from its shipping carton.
2. Check the carton contents. It should contain:
 - a. 8200 Compressor (air cooled or water cooled).
 - b. Compressor Manual part number 8040353.
3. After unpacking, inspect the compressor for evidence of damage as follows:
 - c. Inspect the compressor overall exterior for damage.
 - d. Report damage to the shipper at once.
 - e. Retain shipping cartons for storage or return shipment.

When installing your system, CTI recommends that as you unpack a component, you perform an inspection and the necessary tasks for system installation for the component according to the manual included with the component. Final system installation and operation will be performed following procedures in the high-vacuum pump or refrigerator manual.

4. Check the helium pressure gauge. The gauge should indicate 250 psig (1725 kPa) minimum at 70°F. If additional gas pressure is required, follow the instructions in [Helium Circuit Decontamination on page 5-9](#).

4

Installation

Overview

This chapter provides complete installation procedures for the Brooks Automation Product.

Chapter Contents

Compressor Installation	4-2
Preparing the Compressor Input-Power Cable.....	4-2
Cooling Water Requirements (Water-Cooled Compressors Only)	4-4
Cooling Water: General Considerations.....	4-5
Cooling Water: Flow and Pressure Requirements	4-6
Cooling Water: Heat Load and Temperature Rise	4-7
Final Preparation of Compressor.....	4-8
Connecting the Compressor to the Cold Head	4-9

Compressor Installation

Installation of your compressor requires no special tools other than those supplied in the Installation and Scheduled Maintenance Tool Kit.

Preparing the Compressor Input-Power Cable

To supply input power to the 8200 compressor requires the fabrication of a 600-volt power cable that has an SO-4 conductor, 600-volt rating neoprene jacket and 14-gauge or 2.3 mm² wire.

Unit must be wired by an authorized electrician in accordance with the national Electrical Code, ANSI/NFPA 70-1987, as well as the local codes. This shall include installation of a readily accessible disconnect device into the fixed wiring supplying power.

An insulated earthing conductor that is identical in size, insulation material and thickness to the earth and unearth branch circuit supply conductors, except that it is green with or without one or more yellow stripes is to be installed as part of the branch circuit which supplies the unit or system. The earthing conductor described is to be connected to the earth at the service equipment, or supplied by a separately derived system at the supply transformer or generator.

Proceed as follows:

	⚠ WARNING
	High Voltage High voltage electric shock could cause severe injury or loss of life. Do not connect the compressor to the power source at this time. Complete the preparation and panel reinstallation before electrically connecting the compressor.

1. Prepare the input power cable by terminating each of the four conductors with a #10 ring terminal. Follow the terminal manufacturer's instructions to insure proper crimping.
2. Disassemble the electrical terminal enclosure cover, mounted on the compressor rear panel, as shown in [Figure 4-1 on page 4-4](#). Remove the two screws securing the cover and lift it off.
3. If necessary, back off strain relief screws.

4. Thread input power cable end up through the strain relief into the enclosure.
5. Attach the power conductors onto the appropriate terminals of the terminal block.
 - a. For three-phase hookups, attach the three power leads to terminals X, Y and Z.
 - b. For single-phase hookups, attach the two power leads to terminals X and Y. **DO NOT USE TERMINAL Z.**
6. Tighten all terminals to 18-22 in.-lbs. torque.
7. Tighten down screws on strain relief.

	CAUTION Equipment Damage To avoid damaging the power cable, ensure that strain relief is tightened down on the outer insulation of the input power cable, and that the cable does not slide.
---	--

8. Remount the terminal enclosure cover and secure with two screws.
9. Refer to [Final Preparation of Compressor on page 4-8](#) for correct phasing checkout procedure.

	WARNING High Voltage High voltage electric shock could cause severe injury or loss of life. Ensure that the ground wire is grounded and uninterrupted.
---	--

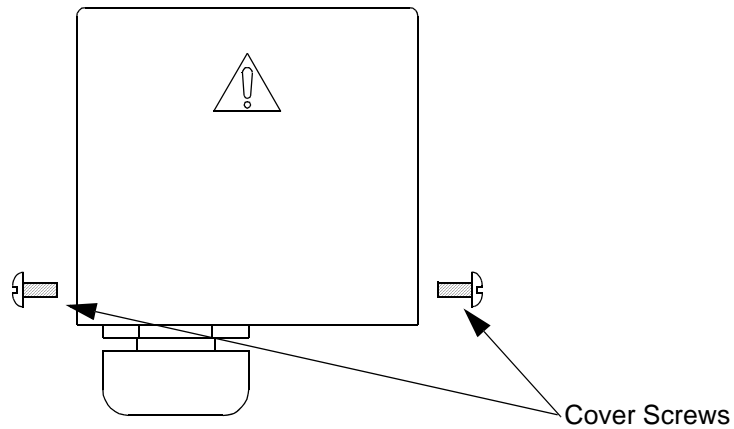

Figure 4-1: Electrical Terminal Enclosure with Cover in Place

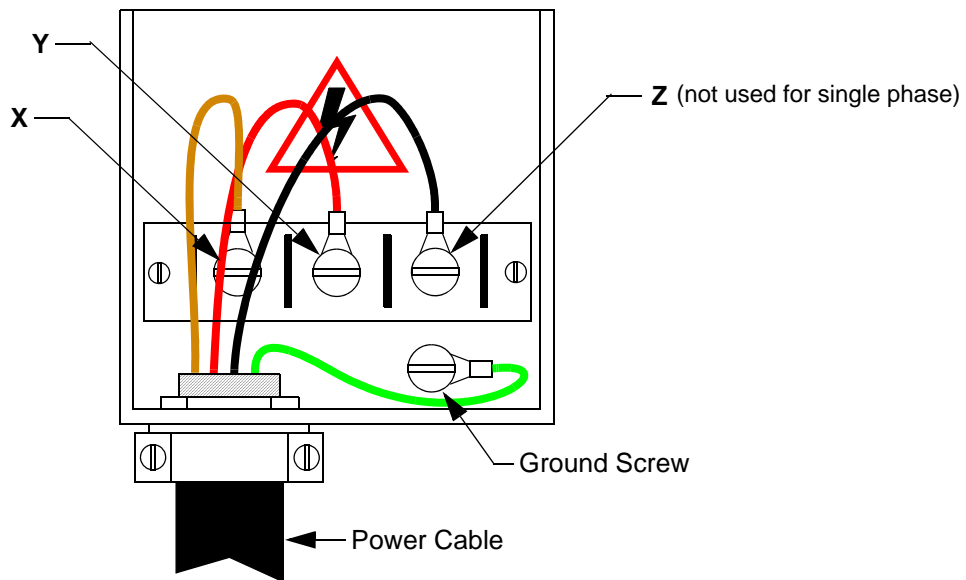

Figure 4-2: Assembly of Conductors to Terminal Block

Cooling Water Requirements (Water-Cooled Compressors Only)

If flexible water hose connections are used, install the barbed fittings supplied with the compressor on the input and output connections:

1. Apply a light coating of standard plumbing thread sealant on the barbed fitting threads.

2. Tighten fittings on 1/2-inch FPT input and 1/2-inch FPT output connections. DO NOT OVERTIGHTEN.
3. Connect flexible hoses to the fittings and secure with hose clamps.

If hard piping is desired, install the water lines directly onto the compressor 1/2-inch FPT input and output connections. DO NOT OVERTIGHTEN.

	CAUTION Equipment Damage To avoid damaging adjacent equipment, check water connections for leaks.
---	---

Cooling Water: General Considerations

- Cooling water must meet flow and pressure requirements. See [Cooling Water: Flow and Pressure Requirements on page 4-6](#).
- To conserve water, the shut off the cooling water when the compressor is not running.

NOTE: *If cooling water below 45°F (7°C) runs through the compressor while the compressor is not operating, the compressor oil will change viscosity and thicken, causing the compressor to overheat and shut off at startup. In this event, repeatedly restart the compressor, allowing it to run until it has shut off several times. The oil temperature will rise and then the compressor will run continuously.*

- Drain and purge water from the compressor before shipping it back to the factory or subjecting it to freezing conditions. Purge water from the compressor by blowing compressed air, regulated between 30 to 40 psig (200 to 275 kPa) into the compressor output connection, and allow water to exit from the water input connection.

Table 4-1: Cooling Water Specifications

Parameter	Value
Maximum Inlet Temperature	90°F (32°C)
Minimum Inlet Temperature	50°F (10°C)
Flow Rate	1.0±0.5 gpm (3.8±1.9 lpm)
Pressure Drop (inlet-to-outlet)	approximately 3.5 psig differential
Min. / max. Inlet Pressure	5 to 100 psi (6.9 bars)
Alkalinity	7.0 - 8.7 pH
Calcium Carbonate	<75 ppm
Resistivity	<100k Ohm - cm
<p>NOTE: <i>Water conditioning may be required for applications not meeting these requirements. Additional parameters appear in Appendix F: Additional Cooling Water Quality Parameters on page 6-15.</i></p>	

Cooling Water: Flow and Pressure Requirements

Use [Figure 4-1 on page 4-4](#) and [Figure 4-4 on page 4-7](#) to determine the minimum acceptable cooling water supply pressure at different flow rates and temperatures

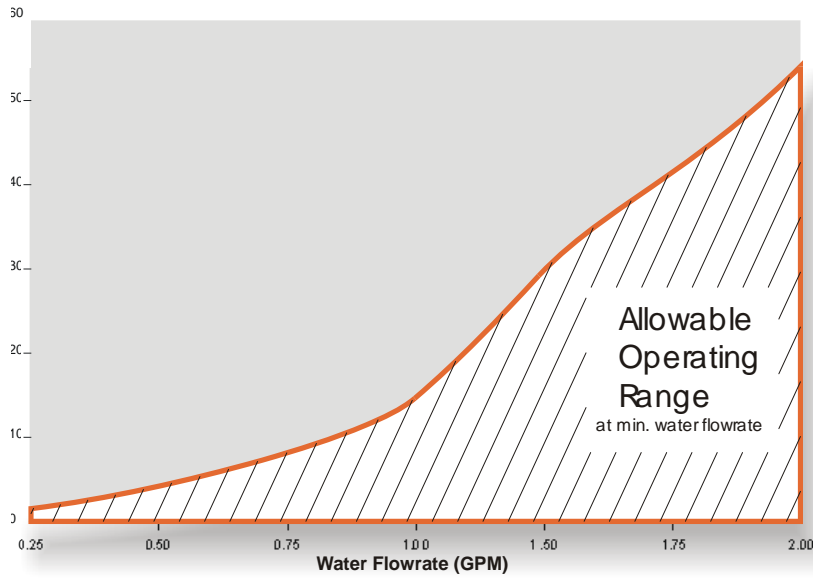

Figure 4-3: 8200 Compressor Cooling Water Flow and Pressure Requirements

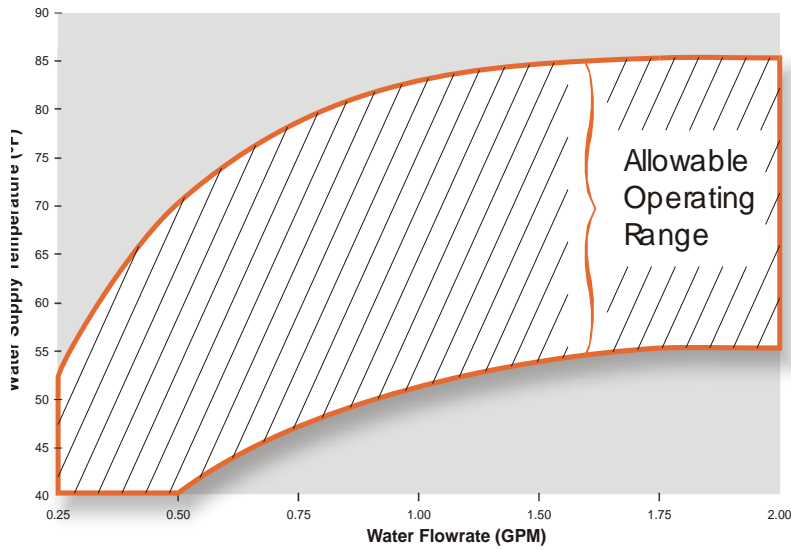

Figure 4-4: 8200 Compressor Water Cooling Requirements

Cooling Water: Heat Load and Temperature Rise

Heat load to facility water is approximately 5000 Btu/hr, or 1500 Watts. With a 1.0 GPM water flow this translates to an approximate water temperature rise of 10°F (5.6°C)

Final Preparation of Compressor

1. Using a voltmeter, measure the phase-to-phase voltage from the power source. Compare this voltage to [Table 4-1](#) and position the voltage range selector switch to the “208V” or “220V” position as required. Also, set the frequency selector switch to the 50 Hz or 60 Hz position, as appropriate. See [Figure 1-2 on page 1-4](#) for location of selector switches.

Table 4-1: Voltage Specifications

Operating Voltage Range		Voltage Adjustment Switch S1 Position
60 Hz	50 Hz	
198-212	180-212	208V
213-250	213-220	220V

2. Ensure that water is turned on for the water-cooled compressor.
3. Set the compressor ON/OFF switch (3) to OFF. Connect the input-power cable to the power source Refer to [Table 1-1 on page 1-5](#), for electrical power requirements.
4. Turn the compressor switch to the ON position and allow the compressor to run for 15 minutes to stabilize the oil circuit. Make sure that the compressor fan operates freely in the air-cooled compressor.
5. Switch off the compressor and disconnect the input-power cable.
6. Install the compressor in its permanent location on a level surface. Air cooled units must have a minimum clearance of 12 inches at the front and back for adequate airflow.

Connecting the Compressor to the Cold Head

Make the connections between the cryopump and compressor. See [Figure 4-5 on page 4-10](#).

1. Remove dust plugs and caps from the supply fittings and return lines, compressor, and cold head. Check all fittings.
2. Connect the helium-gas return line from the gas-return connector on the rear of the compressor to the gas-return connector on the cold head.
3. Connect the helium-gas supply line from the gas-supply connector on the rear of the compressor to the gas-supply connector on the cold head.
4. Attach the supply and return line identification decals (CTI-Cryogenics supplied) to their respective connecting piping ends.
5. Verify proper helium supply static pressure by confirming that the helium pressure gauge reads 245-250 psig (1690-1725 kPa), in an ambient temperature range of 60 to 100°F (16 to 38°C).

NOTE: *To ensure the compressor continues to perform optimally, do not run it unless it is connected to a cryopump or waterpump.*

If the indicated pressure is higher than 250 psig (1725 kPa), reduce the pressure as follows:

- a. Remove the flare cap from the gas charge fitting located on the rear of the compressor.
- b. Open the gas charge valve very slowly. Allow a slight amount of helium gas to escape until the helium pressure gauge reads 250 psig (1725 kPa).
- c. Close the gas charge valve and reinstall the flare cap.

If the indicated pressure is lower than 245 psig (1690 kPa), add helium gas as described in [Helium Circuit Decontamination on page 5-9](#).

	⚠ WARNING
	High Voltage
	High voltage electric shock could cause severe injury or loss of life.
	Before you make any electrical connections, turn off the compressor with the ON/OFF power switch on the front of the compressor.

6. Make the following electrical connections.
 - a. Connect the cold head power cable to the rear panel of the compressor and the other end to the electrical power connector on the high-vacuum pump cold head.
 - b. Connect the compressor input power cable to the power source.
 - c. Turn on compressor.
 - d. Your system is now ready for operation.

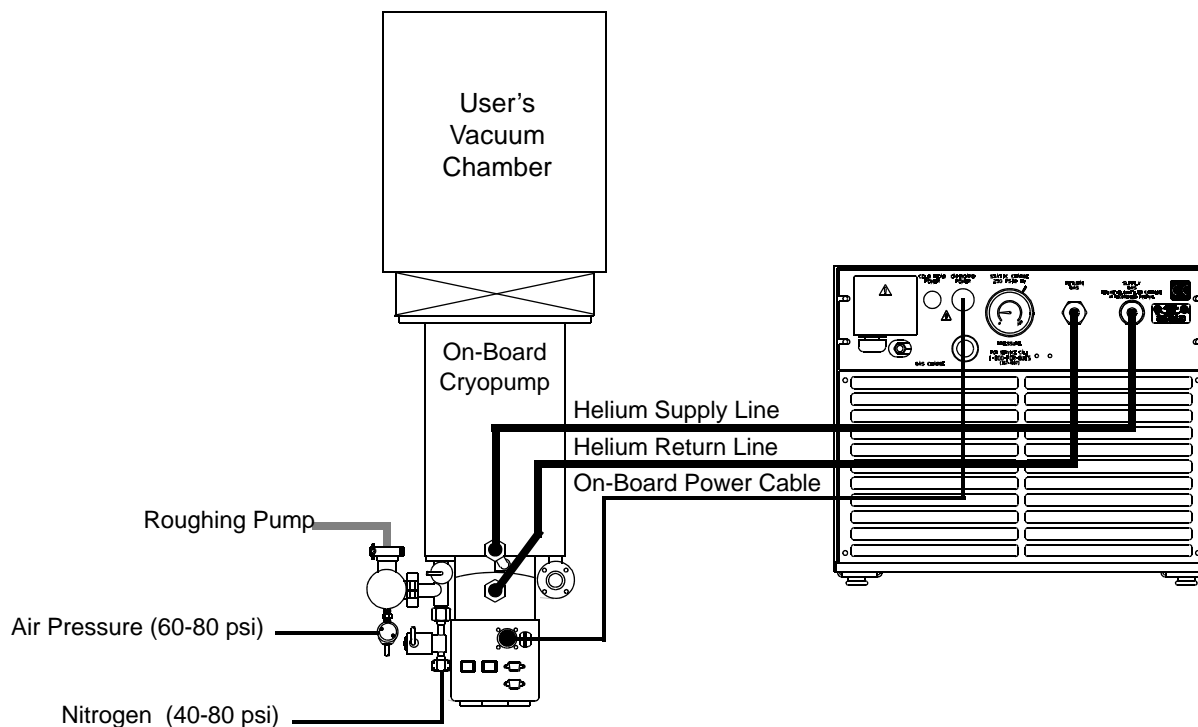

Figure 4-5: Typical 8200 Compressor Installation

5 Maintenance Procedures

Overview

This chapter provides complete maintenance procedures for the Brooks Automation Product.

Chapter Contents

Scheduled Maintenance	5-2
Unscheduled Maintenance	5-6
Helium Circuit Decontamination	5-9

Scheduled Maintenance

The only scheduled maintenance required on the 8200 Compressor is replacement of the compressor adsorber (part number 8080255K001) every 12 months.

	⚠ WARNING High Voltage High voltage electric shock could cause severe injury or loss of life. Always disconnect the compressor from all sources of electrical power before performing any maintenance procedures.
---	--

Removing the Compressor Adsorber

1. Shut down the compressor.
2. Disconnect the compressor input power cable from its electrical power source.
3. Disconnect the flex lines from the gas-return and gas-supply connectors at the rear of the compressor.
4. Remove the screws holding the compressor rear grille, rear panel, front panel and cover ([Figure 1-2 on page 1-4](#)). Front and rear panels remain in place.
5. Use the two wrenches (supplied) to avoid loosening the body of the coupling from its adapter.
6. Unscrew the two self-sealing coupling halves quickly to minimize gas leakage as shown in [Figure 5-2 on page 5-3](#).
7. Disconnect the adsorber-inlet self-sealing coupling as shown in [Figure 5-2 on page 5-3](#).
8. Remove the bolts, nuts, and washers that secure the adsorber to the base of the compressor. Save all nuts, bolts, and washers for installing the replacement adsorber.
9. Carefully lift the adsorber inward until the outlet self-sealing coupling clears the rear panel and remove the adsorber as shown in [Figure 5-3 on page 5-4](#).
10. Remove the adsorber from the compressor as shown in [Figure 5-2 on page 5-3](#).

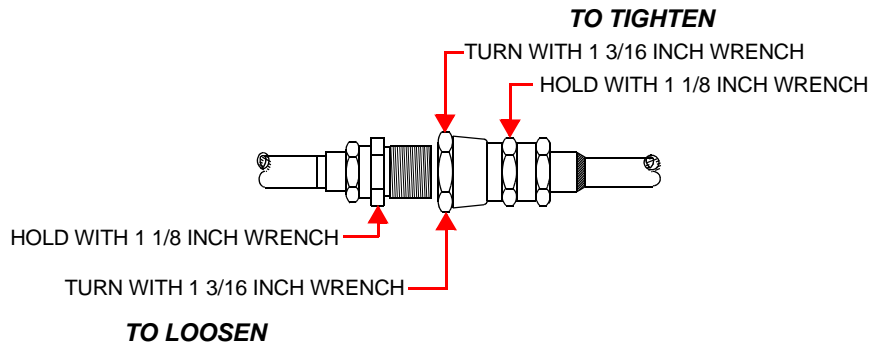

Figure 5-1: Adjusting the Self-Sealing Connectors

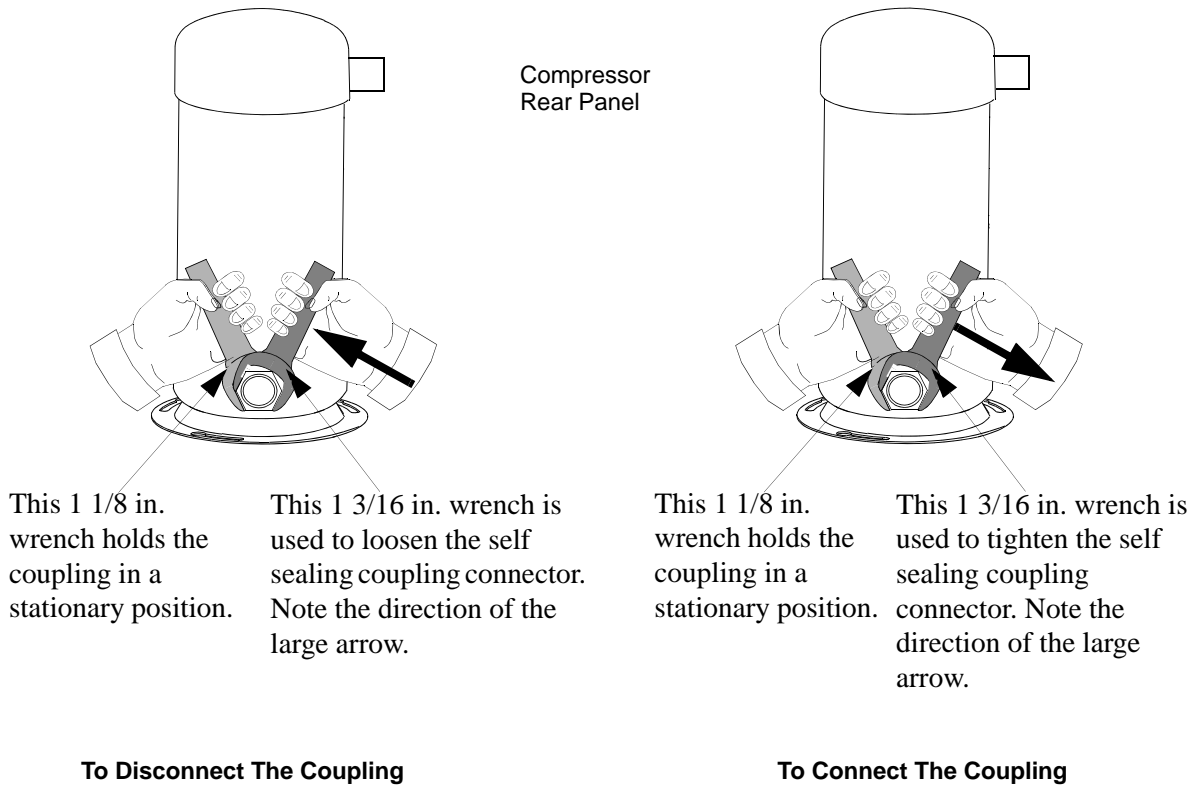



Figure 5-2: Disconnecting/Connecting the Adsorber Self-Sealing Coupling

	<p style="text-align: center;">⚠ CAUTION</p> <p style="text-align: center;">Explosive Pressure</p> <p>High pressure explosions could cause severe injury and equipment damage. Appropriately depressurize the adsorber before disposing of it.</p>
---	--

To depressurize the adsorber, attach the depressurization fitting (included in the *Installation and Scheduled Maintenance Tool Kit*) to the coupling half at either end of the adsorber and tighten it slowly.

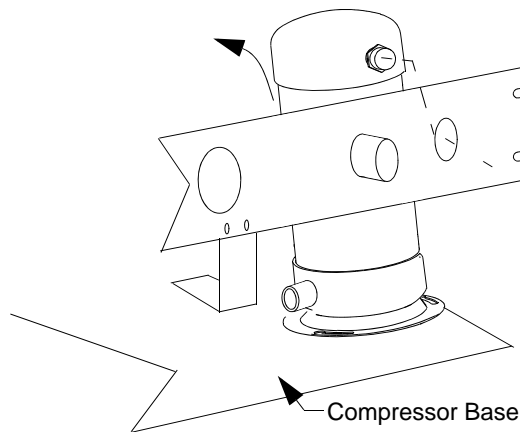



Figure 5-3: Removing the Adsorber from the Compressor

Installing the Compressor Adsorber

1. Install the replacement adsorber as follows:
 - a. Remove the dust caps from the self-sealing coupling halves at each end of the replacement adsorber.
 - b. Write installation date on the adsorber decal.
 - c. Install the replacement adsorber following the steps for compressor adsorber removal in reverse order. Use the hardware saved in [Step 5](#) on [Page 5-2](#).
2. Connect the adsorber to the compressor internal piping. Refer to [Figure 5-2](#) on [page 5-3](#).

- a. Check the self-sealing connector flat rubber gasket to make sure that it is clean and properly positioned.

	CAUTION Equipment Damage To avoid damaging equipment, ensure you hold the left coupling nut while tightening the right coupling nut, as shown in Figure 5-2 on page 5-3 and Figure 5-1 on page 5-3 .
---	--

- b. Make the first turns by hand and then firmly seal the connection using the two wrenches until the fittings “bottom.” Refer to [Figure 5-2 on page 5-3](#) and [Figure 5-1 on page 5-3](#), for proper coupling of the self-sealing connection
3. Replace the cover and the front and rear grilles and secure them
4. Ensure that the pressure gauge reads 245-250 psig (1690-1725 kPa). If additional gas pressure is required, follow the instructions in [Adding Helium Gas on page 5-6](#).
5. Reconnect the return and supply flex lines to the compressor.
6. Connect the compressor input power cable to the electrical power source.

Unscheduled Maintenance

Suggested Unscheduled Maintenance Equipment

It is advisable to keep on hand the unscheduled maintenance equipment and disposable supplies listed below.

1. Helium, 99.999% pure.
2. Pressure regulator (0-3000/0-400 psig).
3. Maintenance manifold, part number 8080250K003*.
4. Helium charging line terminating in a 1/4-inch female flare fitting, part number 7021002P001.
5. Installation and Scheduled Maintenance Tool Kit, part number 8032040G004.

*Available from stock; consult the factory or your sales representative.

Adding Helium Gas

Use only 99.999% pure helium gas.

	<p style="text-align: center;">CAUTION</p> <p style="text-align: center;">Equipment Damage</p> <p>To avoid damaging the cold head and other parts through contamination, maintain pressure in the cold head.</p>
---	--

If the compressor helium pressure gauge reads 0, decontamination is required. Refer to the [Helium Circuit Decontamination on page 5-9](#), or contact the Product Service Department.

1. A user-supplied helium charging line terminating in a 1/4-inch female flare fitting, and a two-stage pressure regulator rated at 0-3000/0-400 psig is required for this operation.
2. If you need to add helium more than once every several months, check for leaks caused by improperly connected self-sealing connections or any mechanical joint within the compressor.

There are two conditions that require the addition of helium gas:

1. Compressor not operating; helium pressure gauge reads 245 psig or below.
2. Compressor operating; helium pressure reads 270 psig, or below.

To add helium gas:

1. Attach a pressure regulator (0-3000/0-400 psig) and charging line to a helium gas (99.999% pure) bottle. **DO NOT OPEN THE BOTTLE AT THIS TIME.** Purge the regulator and charging lines as instructed in steps a through e below. Do not use helium gas that is less than 99.999% pure.
 - a. Open the regulator a small amount by turning the adjusting knob clockwise until it contacts the diaphragm, then turn approximately 1/8 to 1/4 turn more, so that the regulator is barely open.
 - b. Slowly open the bottle valve, and purge the regulator for 10 to 15 seconds. Turn the regulator knob counterclockwise until the helium stops flowing.
 - c. Connect the charge line to the helium pressure regulator.
 - d. Remove the flare cap of the gas charge fitting on the rear of the compressor. Loosely connect the charge line to the charge fitting.
 - e. Set the helium pressure regulator to 10 to 25 psig (70-125 kPa). Allow helium gas to flow through the charging line and around the loosened flare fitting for 30 seconds to purge the charging line of air. Then tighten the flare nut at the end of the charge line.

(This procedure is required to ensure that both the regulator and the charging line will be purged of air and that the air trapped in the regulator will not diffuse back into the helium bottle. For best results, CTI suggests a dedicated helium bottle, regulator, and line, which are never separated, for adding helium.)

2. Set the helium pressure regulator to 300 psig (2070 kPa). Depending on the compressor operating state, add helium gas:
 - a. If the compressor is running (approximately 2 hours operating time) under normal operating conditions, slowly open the helium charge valve on the rear of the compressor. When the helium pressure gauge rises to 270 - 290 psig (1860 - 2000 kPa) tightly close the charge valve.

- b. If the compressor is not running, slowly open the helium charge valve. When the helium pressure gauge rises to 245 - 255 psig (1688 - 1757 kPa), tightly close the charge valve.

	<p style="text-align: center;">CAUTION</p> <p style="text-align: center;">Equipment Damage</p> <p>To avoid discharging the relief valve, add helium gas slowly, less than 50 psi per second.</p>
---	--

3. Ensure that the helium charge valve on the compressor is tightly closed. Shut off the helium pressure regulator on the helium bottle and remove the charging line from the male flare fitting. Shut off the helium gas bottle valve. Reinstall the flare cap.

Helium Circuit Decontamination

Refer to **Section 4 - Maintenance** of the appropriate On-Board Cryopump Installation Operation, and Maintenance manual for information on helium circuit decontamination.

This Page Intentionally Left Blank

6

Appendices

Overview

The following appendices are included to provide the user with a single location for specific information related to the Brooks Automation Product.

Contents

Appendix A: Customer Support Information	6-2
Appendix B: Troubleshooting Procedures	6-3
Appendix C: Electrical Schematics for 8200 Compressor	6-7
Appendix D: Components in the Electrical Control Module of the 8200 Compressor	6-10
Appendix E: Flow Diagrams for 8200 Air-Cooled and Water-Cooled Compressors	6-12
Appendix F: Additional Cooling Water Quality Parameters	6-15

Appendix A: Customer Support Information

Customer Support Center Locations

To locate a Customer Support Center near you, please visit our website www.brooks.com on the world wide web and select *CONTACT* on the home page.

Guaranteed Up-Time Support (GUTS®)

For 24-hour, 7-day per week Guaranteed Up-Time Support (GUTS) dial:

1 800-367-4887 - Inside the United States of America

+1 508-337-5599 - Outside the United States of America

Product Information

Please have the following information available when calling so that we may assist you:

- Product Part Number
- Product Serial Number
- Product Application
- Specific Problem Area
- Hours of Operation
- Equipment Type
- Vacuum System Brand/Model/Date of Manufacture

E-mail

For your convenience, you may also e-mail us at:

techsupport@brooks.com

Appendix B: Troubleshooting Procedures

Read these safety notices before you perform any troubleshooting procedures:

	<p>⚠ WARNING</p> <p>High Voltage</p> <p>High voltage electric shock could cause severe injury or loss of life. Always disconnect the compressor from all sources of electrical power before performing any maintenance or troubleshooting procedures.</p>
---	---

	<p>⚠ CAUTION</p> <p>Burn Hazard</p> <p>To avoid being burned, wait for the pump to cool down so that it is cool to the touch after operating, before working on the inside of the compressor.</p>
---	---

Table 6-1: Compressor Troubleshooting Procedures

Problem	Possible Cause	Corrective Action
<p>1) System power ON/OFF switch (CB1) and compressor switch (S1) remains in the ON position when switched on but the compressor will not run. Refer to Figure 6-1 on page 6-8 for identification of all electrical components.</p>	<p>1a) The thermal protective switch (TS1) is closed, activating the relay-trip coil in the ON/OFF switch (SW1).</p> <p>1b) Incorrect phasing at input power.</p> <p>1c) Excessive current drain has activated the series trip in the compressor ON/OFF switch.</p>	<p>1a) Test switch (TS1) on air-cooled compressor; test (TS1) and (TS2) on water-cooled compressor. If continuity is found in any switch, contact the Product Service Department.</p> <p>1b) Correct phase sequence at input power cable.</p> <p>1c) Measure and record the current and contact the Product Service Department.</p>

Table 6-1: Compressor Troubleshooting Procedures

Problem	Possible Cause	Corrective Action
<p>2) System power ON/OFF switch (CB1) remains in the ON position, but the compressor will not run.</p>	<p>2a) No power coming from the power source.</p> <p>2b) Incorrect or disconnected wiring within the compressor.</p>	<p>2a) Check service fuses, circuit breakers, and wiring associated with power source, and repair as needed.</p> <p>2b) Check the compressor against its electrical schematic, Figure 6-1 on page 6-8.</p>

Table 6-1: Compressor Troubleshooting Procedures

Problem	Possible Cause	Corrective Action
<p>3) Compressor stops after several minutes of operation and remains off.</p>	<p>3a) High temperature of the compressor is caused by insufficient cooling water, resulting in the opening of thermal protective switch (water-cooled compressor only).</p> <p>3b) After turn-off, very cold cooling water was left running through the compressor. The resulting low oil temperature has caused a restriction of oil flow through the metering orifice during startup.</p> <p>3c) Very cold cooling water is circulating through the compressor. The resulting low oil temperature causes a restriction of oil flow through the metering orifice during startup.</p> <p>3d) Ambient temperature is unusually high resulting in the opening of the thermal protective switch (air-cooled compressor only).</p> <p>3e) Insufficient helium supply pressure is indicated by the supply pressure gauge.</p> <p>3f) High temperature of the compressed helium in the discharge line from the compressor pump has tripped the thermal protective switch.</p> <p>3g) Mechanical seizure.</p>	<p>3a) Confirm that cooling water to the compressor is flowing. Confirm that proper cooling water flow rate and pressure exist by referring to Figure 4-3 on page 4-7.</p> <p>3b) Turn on the compressor and allow it to run until it has stopped several times, allowing the oil temperature to rise and the compressor to operate continuously for one hour minimum.</p> <p>3c) Recheck for proper cooling water temperature per, Cooling Water Requirements (Water-Cooled Compressors Only).</p> <p>3d) Provide a free flow of air to the compressor. Confirm a 12-inch (30 cm) clearance at the front and back of the compressor. Confirm unobstructed and clean heat exchanger surfaces.</p> <p>3e) Add helium per, Unscheduled Maintenance on page 5-6.</p> <p>3f) Confirm that oil is visible in the compressor sight glass (air-compressor only).</p> <p>3g) Contact the Product Service Department.</p>

Table 6-1: Compressor Troubleshooting Procedures

Problem	Possible Cause	Corrective Action
<p>4) Compressor pump stops after several minutes of operating and then switches ON and OFF at short intervals.</p>	<p>4a) Intermittent power source voltage.</p>	<p>4a) Confirm power source voltage between 198-250V, 60 Hz or 180-220V, 50 Hz and restore if necessary.</p>
<p>5) Compressor operates but cold head motor does not run.</p>	<p>5a) Loose or defective cable.</p>	<p>5a) Check cold head cable.</p>
<p>6) Cooling water leaving the compressor exceeds 100°F.</p>	<p>6a) The water coming into the compressor is too warm.</p> <p>6b) The water is becoming too warm within the compressor due to a problem with the compressor.</p>	<p>6a) Ensure the water coming into the compressor is between 50°F (32°C) and 90°F (10°C).</p> <p>6b) Contact the Product Service Department.</p>

Appendix C: Electrical Schematics for 8200 Compressor

The following electrical schematics for the 8200 Compressor are in this appendix:

- [8200 Compressor Electrical Schematic part number 8032563P001](#)
- [8200 Compressor Electrical Schematic part number 8032564P001](#)

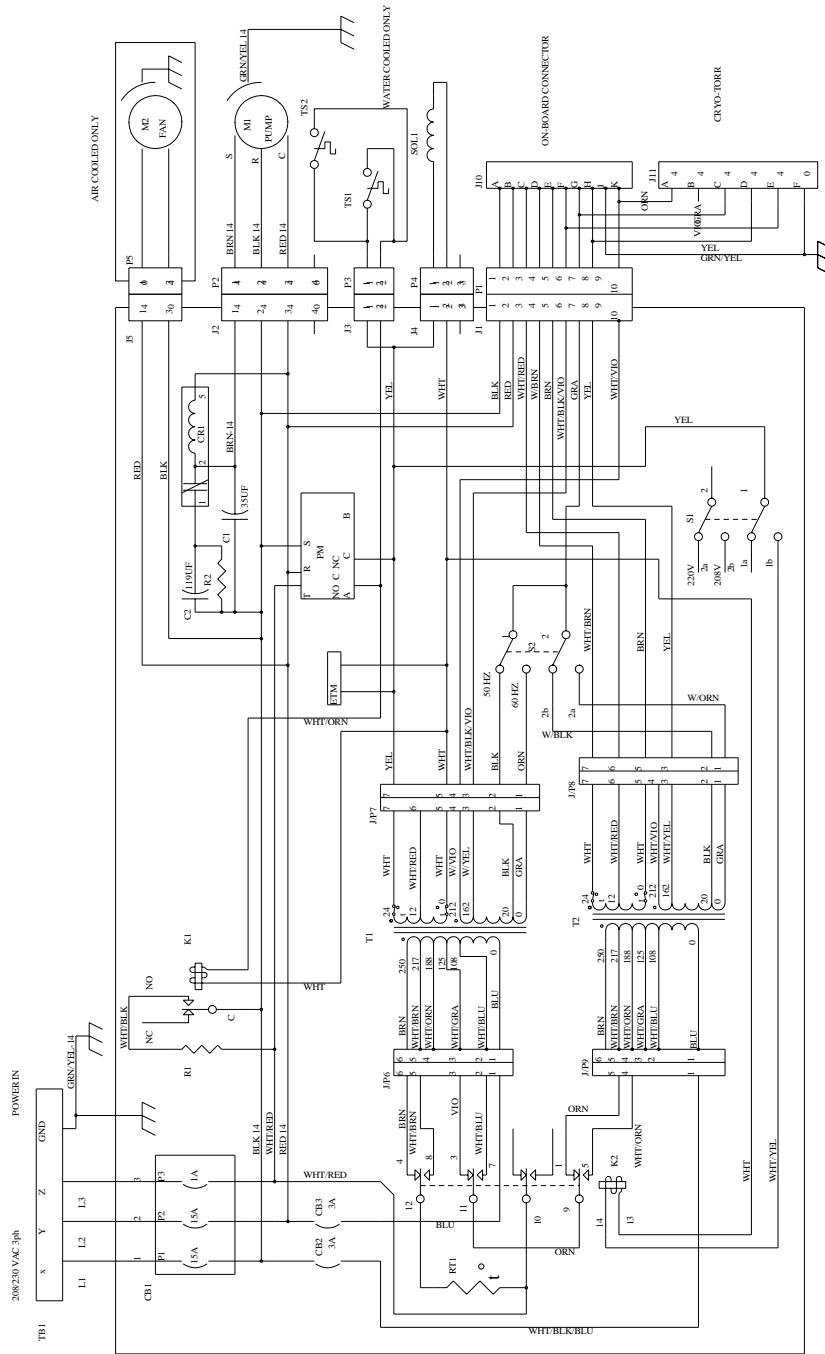

- C1 RUN CAPACITOR, 35UF
- C2 START CAPACITOR, 110UF
- CB1 MAIN CIRCUIT BREAKER
- CB2 CIRCUIT BREAKER, 3A
- CB3 CIRCUIT BREAKER, 3A
- CR1 MOTOR START RELAY
- ETM METER ELAPSED TIME
- J1 COLDBEAD CONNECTOR
- J2 PUMP CONNECTOR
- J3 THERMOSTAT CONNECTOR
- J4 SOLENOID CONNECTOR
- J5 FAN CONNECTOR
- JP6 TRANSFORMER CONNECTOR
- JP7 TRANSFORMER CONNECTOR
- JP8 TRANSFORMER CONNECTOR
- JP9 TRANSFORMER CONNECTOR
- K1 OVERTEMPERATURE TRIP RELAY
- K2 VOLTAGE SELECTOR RELAY
- M1 PUMP MOTOR
- M2 FAN MOTOR, AIR COOLED ONLY
- PM PHASE MONITOR
- J10 ON-BOARD CONNECTOR
- J11 CRYO-TORR CONNECTOR
- R1 OVERTEMPERATURE RESISTOR
- R2 BLEED RESISTOR
- RTI CURRENT LIMITER
- S1 VOLTAGE SELECTOR SWITCH
- S2 FREQUENCY SELECTOR SWITCH
- SOLENOID
- T1 TRANSFORMER
- T2 TRANSFORMER
- TB1 TERMINAL BLOCK, INCOMING VOLTAGE
- TS1 THERMOSTAT
- TS2 THERMOSTAT FOR WATER COOLED USE TS1 AND TS2

NOTES:

1. VOLTAGE SELECTION:

FREQUENCY	LINE VOLTS	S1	S2	CH VOLTS	CONTROL VOLTS
50 Hz	180 - 212	208V	50 Hz	118 - 139	19.9 - 23.5
	213 - 220	220V	50 Hz	121 - 125	20.5 - 21.2
	198 - 212	208V	60 Hz	148 - 159	21.9 - 23.5
60 Hz	213 - 250	230V	60 Hz	138 - 162	20.5 - 24.0

Figure 6-1: 8200 Compressor Electrical Schematic part number 8032563P001

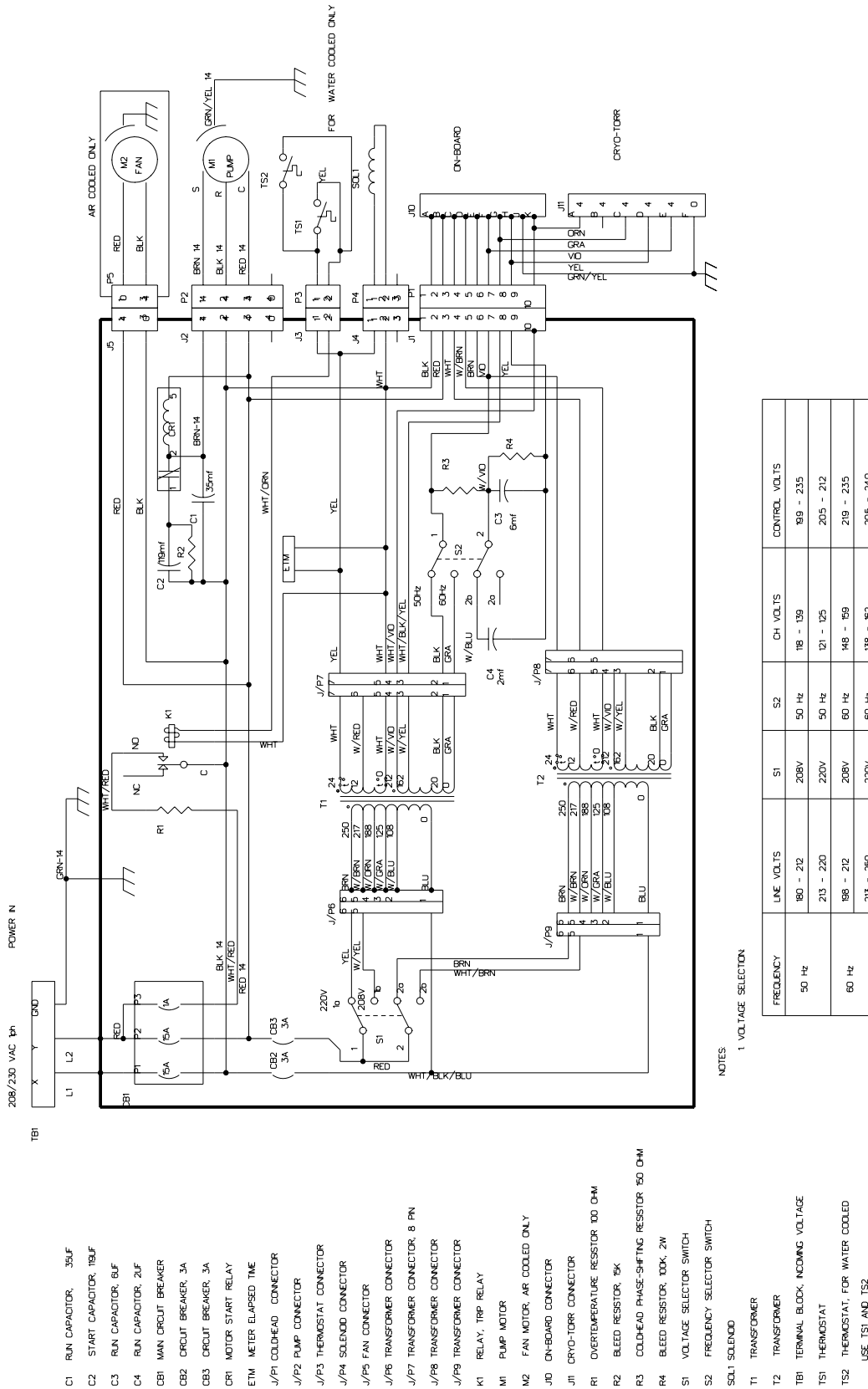
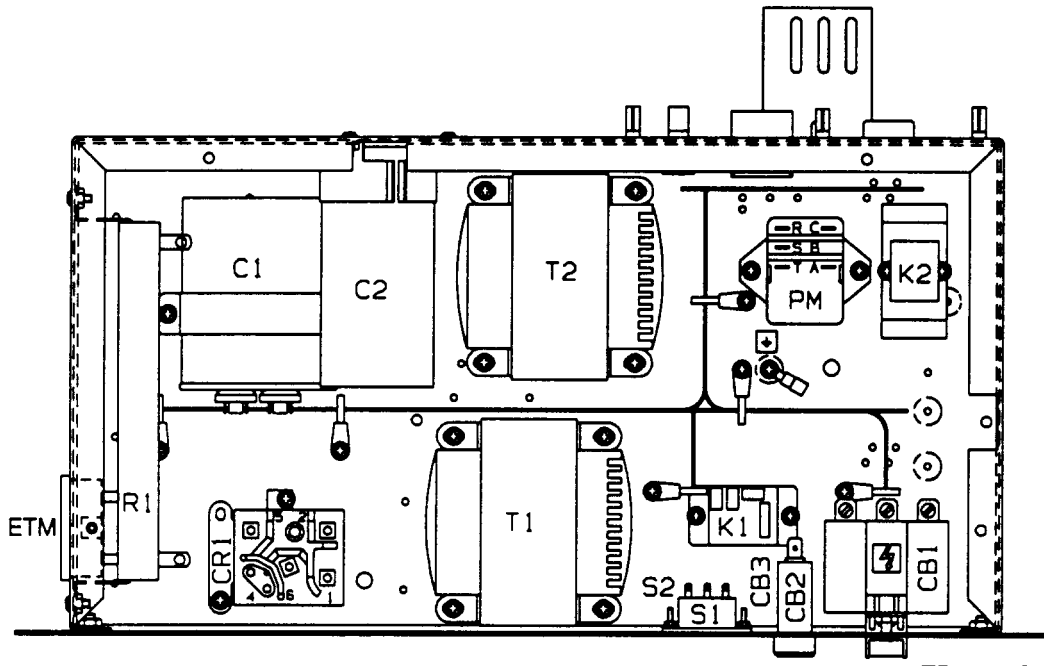

Figure 6-2: 8200 Compressor Electrical Schematic part number 8032564P001

Appendix D: Components in the Electrical Control Module of the 8200 Compressor

The following illustrations are shown in this chapter:

- [Components in the Electrical Control Chassis of the 8200 Compressor Three-Phase Scott-T Configuration](#) (this page)
- [Components in the Electrical Control Chassis of the 8200 Compressor Single-Phase RC Configuration](#)



- | | |
|------------------------------------|-----------------------------------|
| 1. Overtemperature Resistor R1 | 9. Circuit Breaker, 3ACB3 |
| 2. Run Capacitor, 35 μ F C1 | 10. Voltage Selector Switch S1 |
| 3. Start Capacitor, 119 μ F C2 | 11. Frequency Selector Switch S2 |
| 4. Transformer T2 | 12. Overtemperature Trip Relay K1 |
| 5. Phase Monitor PM | 13. Transformer T1 |
| 6. Voltage Selector Relay K2 | 14. Motor Start Relay CR1 |
| 7. Main Circuit Breaker CB1 | 15. Meter, Elapsed Time ETM |
| 8. Circuit Breaker, 3ACB2 | |

Figure 6-3: Components in the Electrical Control Chassis of the 8200 Compressor Three-Phase Scott-T Configuration

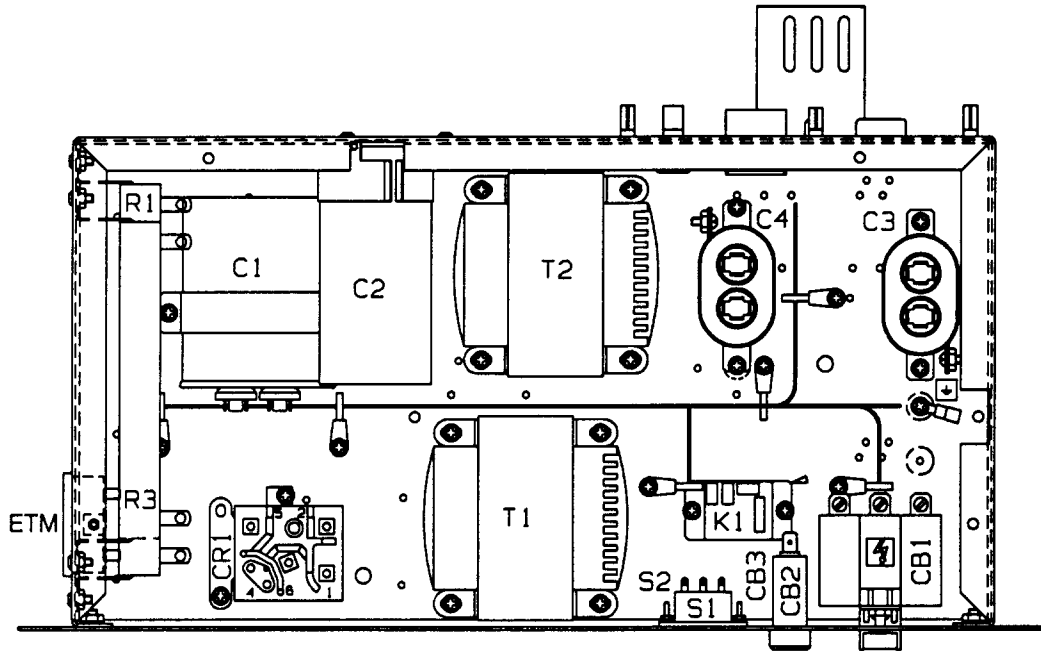

- | | | | |
|-------------------------------------|-----|-------------------------------|-----|
| 1. Coldhead Phase-Shifting Resistor | R3 | 9. Circuit Breaker, 3A | CB2 |
| 2. Overtemperature Resistor | R1 | 10. Circuit Breaker, 3A | CB3 |
| 3. Run Capacitor, 35 µf | C1 | 11. Voltage Selector Switch | S1 |
| 4. Start Capacitor, 119 µf | C2 | 12. Frequency Selector Switch | S2 |
| 5. Transformer | T2 | 13. Relay, Trip Relay | K1 |
| 6. Run Capacitor, 2 µf | C4 | 14. Transformer | T1 |
| 7. Run Capacitor, 6 µf | C3 | 15. Motor Start Relay | CR1 |
| 8. Main Circuit Breaker | CB1 | 16. Meter, Elapsed Time | ETM |

Figure 6-4: Components in the Electrical Control Chassis of the 8200 Compressor Single-Phase RC Configuration

Appendix E: Flow Diagrams for 8200 Air-Cooled and Water-Cooled Compressors

Refer to [Figure 6-5 on page 6-13](#) or [Figure 6-6 on page 6-14](#) while reviewing this subsection.

Helium returning from the cold head enters the compressor, and a small quantity of oil is injected into the gas stream, thereby overcoming helium low specific head and inability to carry heat produced during compression. Helium is then compressed and passed through a heat exchanger for removal of compression-caused heat. The helium flows through a bulk oil separator, oil-mist separator, and helium filter cartridge, where oil and contaminants are removed.

A differential pressure relief valve in the compressor limits the operating pressure differential between the helium supply and return lines, thereby allowing compressor operating without cold head operation. When cold head operation reaches a steady-state condition, further pressure regulation is unnecessary.

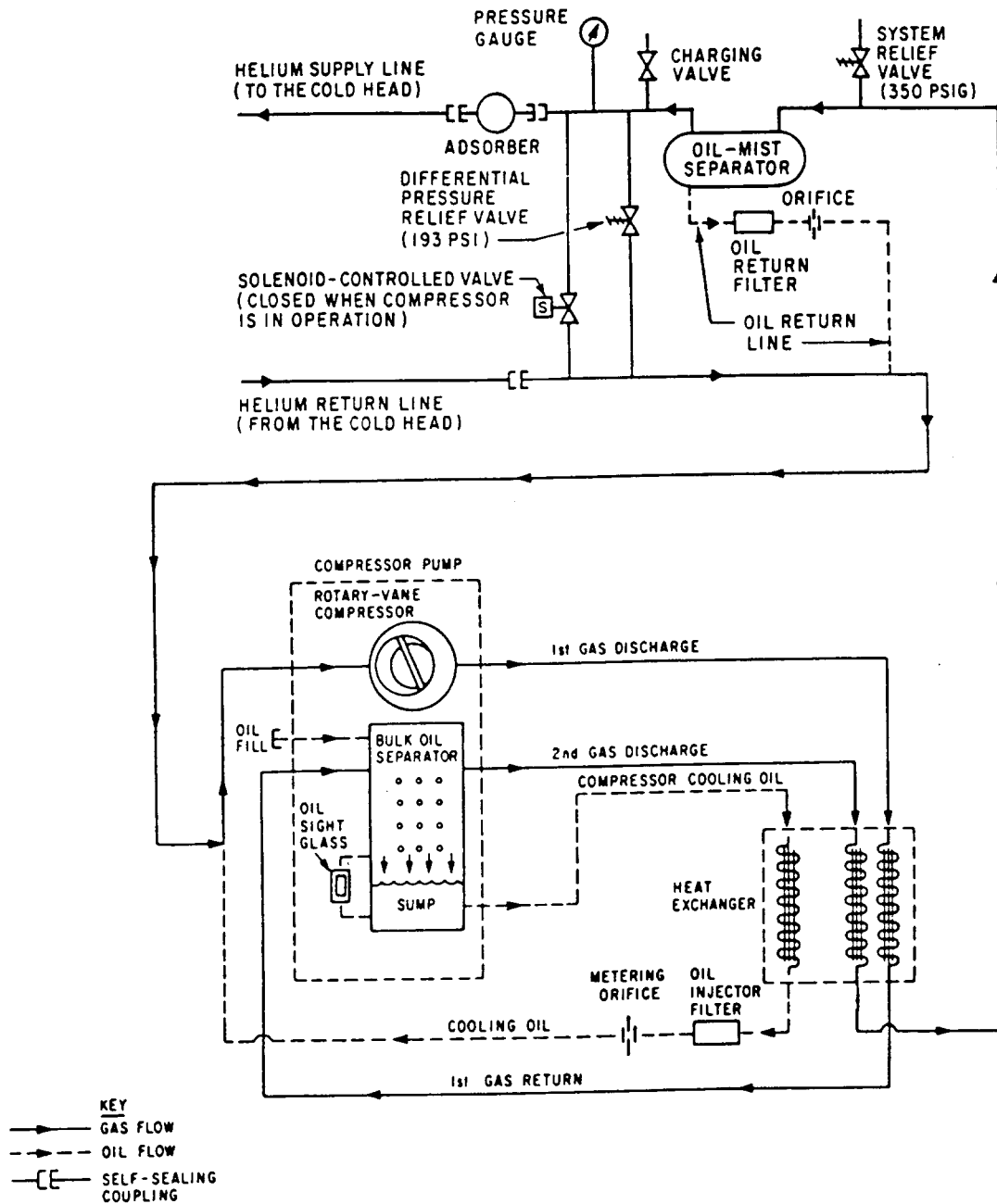

Figure 6-5: Flow Diagram of the 8200 (Air-Cooled) Compressor

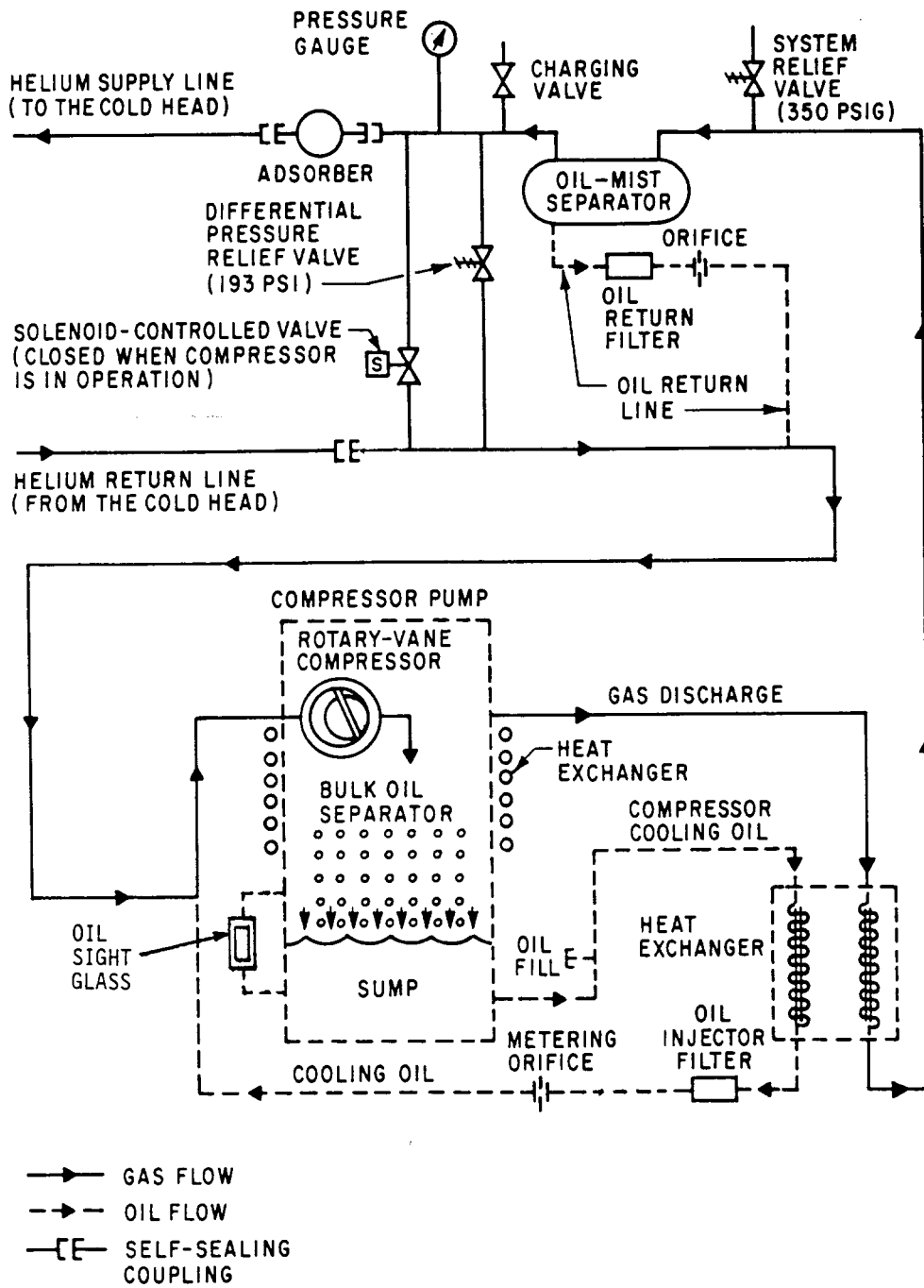

Figure 6-6: Flow Diagram of the 8200 (Water-Cooled) Compressor

Appendix F: Additional Cooling Water Quality Parameters

Table 6-2: Additional Cooling Water Quality Parameters

Water Constituent	Unit	Acceptable Limits
Saturation-Index SI (delta pH-value)		-0.2 < 0 < +0.2
Total hardness	°dH	6 - 15
Conductivity	mg/l	10...500
Filtered substances	mg/l	<30
Chlorides	mg/l	<500
Free chlorine	mg/l	<0.5
Hydrogen sulphide	mg/l	<0.05
Ammonia	mg/l	<2
Sulphates	mg/l	<100
Hydrogen carbonate	mg/l	<300
Hydrogen carbonate / sulphates	mg/l	>1.0
Sulphide	mg/l	<1
Nitrate	mg/l	<100
Nitrite	mg/l	<0.1
Iron	mg/l	<0.2
Manganese	mg/l	<0.1
Free aggressive carbonic acid	mg/l	<20

This Page Intentionally Left Blank