

Building a Pinewood Derby Car



Building a Pinewood Derby Car

The Cub Scout Pinewood Derby (PwD) is one of the most popular "fun event" that a young Scout will participate in. It primarily is a race to find the fastest car, but also is a competition for the coolest car design. Recognition of the time spent building the car may be seen as trophies for the fastest in the race, or for most colorful, most inventive, most "radical" and as many other "Show Car" categories as one can imagine.

Every year, boys with their parent's help, build cars of every description to enter at the local Pack competition. Construction of the car is intended to be a parent and son project [with the son doing the majority of the work](#). The parent should supply advice and limited assistance with the more difficult tasks, while ensuring safety is practiced during all stages of the project. Please remember above all that the [PwD is intended to be fun for all](#). So get started early and take your time building and testing your car. Plan to spend at least 4 to 6 hours building the car over several days. The experienced builders / racers may spend many times this amount which will show in the appearance and racing performance of their cars.

Planning and construction of a car can be approached in many ways. This information will serve only as a guide to some while providing good first-time information and pointers for others. The experienced wood craftsman will find the teaching experience a great project for a young man while the "Klutz" may find it just a little challenging. No matter, the time spent working and learning with your son should be a lot of fun.

If you are designing a car for maximum racing speed, here are the most important points about car design to keep in mind:

- ✓ Maximum Weight (5 ounces)
- ✓ Smooth, Round Wheels
- ✓ Carefully Prepared / Polished Axles
- ✓ Good Lubrication (dry only)
- ✓ Straight Tracking
- ✓ Sleek Shape

On the other hand if your objective is to create a unique or personal design for entering in a "Show Car" competition, then consider these points:

- ☆ Model your car after something you like or adapt a theme from a Cub Scout or other recognizable object or character.
- ☆ Use color and finish as a way to get your car noticed. A bright red or yellow paint job with a high gloss finish is always an attention-getter.
- ☆ Attention to the details of car construction shows in the final product
- ☆ Design on paper before you start cutting wood

Construction Step 1 - The Plan (or What are we Doing?)

You may already have an idea how you want your car to look when built, but in order to take this idea to a completed car, you should have a plan. Take a little time to sketch out your idea on paper. If you haven't decided what you want to do, you may want to get some ideas by looking at the [profiles](#) provided with this guide. Draw your design at full scale so you can directly transfer the profile and shape to the wood block. Using the wood block from the kit as a guide, place it on a piece of paper and draw an outline of the Top and Side views as a starting point for drawing your design.

Ready-made templates or car outlines can also be purchased at Scout supply outlets, the Scout Shop or Scout mail-order catalog, or from on-line retailers over the internet. These can help you choose and transfer a predefined profile to your car, but they are certainly not required. The creative aspects of deciding the cars shape, color and decoration may be the most enjoyable part of the project for some.

Starting with a block of wood is like a hand full of clay. What are you going to do with it? What kind of car do you want to build? Well, there are several basic types of car classifications: 1) ones that are fast, 2) ones that are fast to build, and then there are 3) character, or "Show" cars. Character cars are cars that model other types of cars or objects. Remember that a highly decorative car with characters, decals and other trim may have more wind resistance than a "plain" car. Sleek, low profile designs tend to have less wind drag and therefore are faster. A fast car is usually not a handsome car.

Don't limit your design ideas, but we'll be talking primarily about the plain, more aerodynamic designs. And remember, you can paint your car just about any way you'd like. Just be sure to [paint the car several days before the race so there's adequate time for it to dry thoroughly](#). Be especially certain the paint is dry where the hub of the wheels can contact the side of the car, or the soft paint will slow down your car.



Official PwD Car Kit Contents

Construction Step 2 - Materials and Tools.

You will, of course, need the basic car kit that includes the wood block, axles, wheels and numeric decals. An official Cub Scout Grand Prix Pinewood Derby kit is supplied to each scout by the Pack. These kits produced for BSA have unpredictable quality wheels and axles that make it challenging to produce a *fast car*. Learning how to build a fast car is an excellent way to become familiar with using tools safely while following a process for building a *quality* car. For the purpose of **fairness**, it is imperative that each scout use the official BSA wheels and axles supplied in the kit. Do not substitute the wheels or axles from non-BSA kits into your car design, as this will make it illegal in most races and you can be disqualified. Following the official Pinewood Derby rules for your Pack is a way of practicing the important values of integrity and honesty. Below are recommended tools and additional materials:

- **Safety Glasses = #1 Tool (while drilling, sanding, or when near tools)**
- Electric or Portable Drill Motor (for preparing wheels and axles)
- Wheel turning mandrel (for preparing wheels.. from hobby shop or online)
- Small Metal File(s) (Mill or Fine Cut for filing axles)
- 320 and 600 Grit Wet-or-Dry sand paper (for preparing axles)
- Small Strip of Soft Cloth (ie: cut from old Tee Shirt)
- Metal Polish (for polishing axles... a mirror finish is desired)
- Tracing Paper (for drawing car outline)
- Coping Saw (To cutout body... power Dremel or Scroll Saw may also be used)
- 3/8"/10 mm Drill Bit (if round weights are placed internally)
- 3/8"/10 mm Tubular Weight (from Scout Shop, Hobby Shop, online)
- Wood Putty (to fill holes for internal weights)
- Sanding Sealer or Wood Primer (to harden surface for smooth finish)
- 100 Grit and 220 Grit Garnet Sand Paper (for sanding wood body)
- Finish Paint (Either Spray or Brush on)
- Decals and Decorations as Desired
- Time & Patience (must be supplied... not for purchase ☺☺)

This set of tools and materials will vary depending what you have available and the extent of work you have in mind. Local hobby stores usually stock Pinewood Derby materials, supplies and tools typically available from PineCar® or Pine-Pro®.

Construction Step 3 - Cutting the Basic Car Shape.

Decide how you want your car to look. When you have a design idea it's time to transfer the profile (side view of the car) and plan view (top view of the car) to your block of wood. The block included in your kit is usually close to 7 inches (17.8 cm) in length but may vary a little shorter or longer. Be careful to measure the final overall dimensions of the finished car to insure that your design does not violate the racing specifications / qualification criteria that will be provided to you from the Scout Pack.

Using your side profile drawing and a sheet of carbon tracing paper align the drawing to the block and carefully trace the outside lines of your car so the image is transferred to the wood. If you prefer, you may find it just as easy to copy or duplicate your lines on the wood directly. Use a hard lead pencil or ball point-point pen so that the lines are easy to see when cutting.

Construction Step 4 - Wheel Mount Preparation.

It's been discovered over the years that cars with a longer wheelbase can be faster than shorter wheelbase cars. With this in mind you may want to relocate the two axle slots in the car block toward the ends of the block. Remember to set wheel slots back from block ends at least half the diameter of a wheel so that wheels don't extend past the maximum car length. Remember overall length of the car (including wheels) cannot exceed seven inches. It is very important to cut the new axle slots exactly square to the sides of the block so that the axles have a good alignment for tracking straight.

Another method is to use a drill press to make the holes, using a #43 (2.3 mm) drill bit. A special Derby Worx™ tool, including the drill bit, is available from various sources on the web to provide accurate axle hole drilling without a drill press. Once website demonstrating the tool use is: <http://www.maximum-velocity.com/pro-body.htm>.

Whatever method is used to mount wheels, make sure the final position of axles isn't so high on the body that it creates a problem for the block dragging on the track's guide strip. BEFORE painting the car, insert axles in each of the slots, or holes, so you know they will fit later and so the wood fiber around slots or holes is opened, and then remove the axles. Wheels and axles are permanently installed after paint has dried.

Construction Step 5 - Drilling Holes for Weight.

Your finished wood block along with wheels, axles and trim will usually weigh not much over 2.5 ounces (71 grams) while a finished car is allowed to weigh up to 5.0 ounces (141.75 grams). Adding weight is essential if you want to be race competitive by allowing gravity to work for you. Overcoming friction is what will allow it to win over other cars. Your car must overcome breakaway friction and minimize air resistance, and it will do this by being as heavy as allowed while presenting the smallest profile to the air-stream. That's why a low and skinny body design is recommended.

There are two basic approaches to adding weight to a derby car. The easiest is to attach pre-drilled and shaped lead or zinc weights to the outside of the car. Some of the commercial varieties are cast such that they provide a tapered shape and break-off ribs that permit convenient adjustment to overall weight after the car is assembled. It is best to attach this type of weight to the bottom of the car so the center of gravity is kept low. But be sure the weight doesn't hang down too far, as it may not be obvious until race-day that the weight drags on the track guide, which could prevent the car from moving off the starting line. To prevent this, mortise or "hog out" a void in the wood on the underside of the car and then attach the weight inside the void.

The other method involves installation of weight internal to the body so that there is no additional wind resistance. This may be only a small advantage but it just might make the difference of a winning inch or two at the end of the track. Most car profiles will be narrower at the nose and provide little space for adding lead internally. There is also an advantage in placing the weight in the back. The front wheels perform the function of guiding or steering and the less weight on these wheels the easier the car corrects itself when it strikes the guide strip. Fewer and shorter contacts with the guide strip means less friction to slow it down and hence a faster car.

Drilling the Car Body. Each internally weighted car will have a little different cavity placement based on the wheel / axle position and amount of wood available to accommodate the weight. The hole or cavity for a weight must be large enough to fit the shape used. Using weights with higher weight per size (density) you will need fewer holes than for other materials. Plan on drilling at least 2 or 3 holes of 3/8" (10 mm) (or 7/16") diameter typically at a depth of 1 1/2" (38 mm) each. Experience has shown that holes drilled from the side or back tend to work the best. Locate and drill the holes being careful to make sure you are leaving enough wood around the hole to provide a margin of safety in your drilling operation. Due to the precision required, these holes should only be drilled on a drill press with the body held by a vise. If you are using the BSA kit wood block for the body, it's advisable to drill holes for weights BEFORE cutting the block to the profile shape.

Construction Step 6 - Adding the Weight.

There are many things you might use to add weight to the car, but lead, zinc and tungsten are used most often. These are the heaviest materials available for their volume. Lead works easily and is commonly available in a number of forms. You can use steel in plate (mending plates) or tubular forms (rod or bolts) cut to length with a hack saw. Other metals (brass, copper) may also be used, but just as steel, you may find them difficult to work and sometimes awkward to attach or insert.

Warnings

Lead is toxic and should be handled as little as possible. Use gloves and **never put your hands in or near your mouth after handling it.** Always wash hands thoroughly.

NEVER use mercury at all! It is toxic, difficult to handle and should never be touched by Cub Scouts or adults.

Weigh your car on accurate scales - household scales are usually not very accurate. If you have access to calibrated scales, compare a known item weight on the calibrated scales to your home scale indication for that same item. Mark this reference for use later. Allow for scale inaccuracies by not adding to exactly the 5.0 oz. (141.75 grams) to avoid having to remove weight on race day. Consider also, while you may have an accurate scale, your pack may not, which could weigh items heavier than they actually are! Another solution is to use weights designed to easily allow removing a small amount at the official weigh-in.

Weigh your car body, wheels, axles and any other parts that will be on your car all at once. This weight is usually less than 3 ounces (85 grams). Now, with your car also lying on the scale add your weights until the total weight is just over 4.5 ounces (128 grams). Allow enough space in the holes so that you can add filler material in the next step. If you find there isn't enough room to add weight to get to 4.5 ounces (128 grams) you will have to drill an additional hole or holes. Remember, you will be adding wood filler and paint to your car later which will add little more weight. When you are satisfied, it's time to permanently install the weights and go to the next step.

Construction Step 7 - Sealing the Holes.

Once you have the correct amount of weight installed, you are ready to seal the hole(s) in your car body. There are a number of materials that you can use to cover the weight holes in car body. If you are in a hurry and want a good seal, try using automobile body putty (like Bondo®). This type of filler material is a two-part mix that sets in 15 minutes. You will need only a small amount but it works very easily and may be sanded, drilled and painted easily. Standard wood fillers that don't use a catalyst will take longer to harden (usually overnight) and may need to be applied with several thin coats. Apply the filler so that it may be sanded down smooth to the original wood surface. You'll want to recheck you total car weight after holes are filled.

Construction Step 8 - Sanding and Smoothing.

Sanding the wood body will eliminate any of the saw blade marks as well as any small blemishes in the wood surface. If you have access to a motorized belt-disc sander your work will be quickly done but for most of us a sheet of sandpaper and a sanding block will do just fine. Start by using a 100 or 120 grit paper and wood or rubber block on the filler and rough portions of the wood car body. Gently smooth the edges and corners of the car while using a little more pressure on the flat areas. Then switch to a 220 grit paper to smooth the sanding marks left from the initial sanding. DO NOT WET-SAND UNPAINTED WOOD, as it will "raise the grain" of the wood.

Construction Step 9 - Painting and Finishing.

A bare wood surface will act much like a sponge when paint is first applied, and even after several coats of paint the finish can appear textured and uneven in smoothness. A better approach is to first apply a **wood sanding sealer** to penetrate the wood soft grain that hardens for sanding to provide a good base to apply the color finish paint.

Prepare a place to paint your car that will be out of the house while you are painting and out of the reach of younger children while your car is drying. You may either paint one side at a time waiting between coats or suspend the car on a string with a nail in the axle slot and paint all of it. Brush or spray the sanding sealer on the car with a complete coat and wait for it to thoroughly dry. You may notice the grain of the wood will raise slightly. After the paint is thoroughly dry, sand it with lightly with 320 or 400 grit sandpaper until the sanding-sealer is smooth, but through it to bare wood.

You are now ready for the finish coats of paint. The best and smoothest finishes will be had with a spray paint, but brush-on paint will not affect the overall speed of the car. Use fast drying enamels and avoid using different brands on top of each other. Above all don't use lacquer paint on top of enamel paint. Your paint will wrinkle and bubble. If you get a run in the paint, let it dry then sand it smooth. Re-coat it later. You can achieve a very, very smooth finish if you wet-sand between coats with 600 grit wet-or-dry sandpaper. You can also use fine steel wool followed by polishing cream on a soft cloth to achieve a glasslike finish. Several coats of paint and fine sanding are usually required before polishing can be attempted. **NOTE: Make sure your car is painted several days before the race to allow adequate time for the paint to thoroughly dry.**

If you are going to apply decals and detail work, now is time to do this type of work. If you are careful, you can apply a clear coat of finish over the decals to seal them. Don't use too much clear-coat at one time, though, or decals could become wrinkled.

Construction Step 10 - Wheel Work.

The wheels are one of the most important elements in the car. The biggest challenge is there's not much you can legally do with them. For maximum speed, wheels must roll smoothly, in a straight line and roll very easily. The wheels contained in BSA kits are generally very inconsistent, so there are things to check and fix on each of the wheels. First, wheels must be perfectly round to roll smoothly. BSA wheels are produced in Multi-cavity molds and some molds may produce slightly out-of-round wheels which will be slower than others. To check for this, place the wheel on an axle and spin it. [A good wheel should turn with the outside surface at a single reference point never varying, and with no vibration felt.](#) The run-out or the wheel movement along the axle axis should also be minimal. If you find an out-of-round wheel discard it and buy the BSA axle-wheel kit (\approx \$3.00 for 5 wheels and axles) or another car kit at your Scout supply outlet. There isn't much you can do to correct a bad wheel.

Inspect wheels for burrs or mold injection marks on the running surface of the tire and hub areas. These need to be freed of any extra plastic residue or molding marks. Most Packs and council races require racers to do minimal work on the wheel surface. This means that the outside wheel surface must be sanded or filed to remove the mold marks making it flat across the bottom of the "tire". To perform this work you need a means of spinning the wheel with a drill motor while placing the wheel surface in contact with sandpaper or a fine file. A good solution for this is to purchase a commercially-available wheel turning kit from the Scout supply distributor or PineCar® source, such as a hobby shop / store. These kits include a wheel turning mandrel designed to hold a single wheel in a drill motor for turning (see below). With a wheel mounted, turn it slowly in the drill to quickly reveal out-of-round wheels to discard. For wheels that are "true" when spun slowly, spin the wheel faster with the drill motor and sand or file off enough of the surface to eliminate the injection mold marks. For further wheel testing, please see later discussion on testing wheel-axle lubrication, and how to tell if a wheel is well balanced and round.

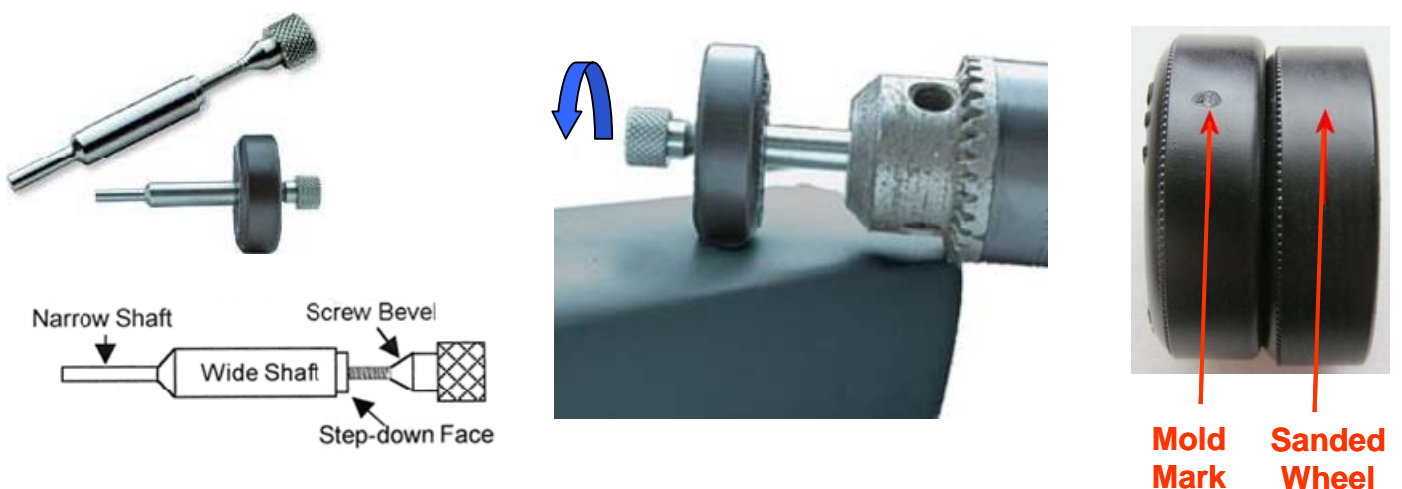

Construction Step 11 - Axle Preparation – CRITICAL PROCESS

The official 'nail' type axles included in the BSA Pinewood derby kit must be used in the construction of your car. These axles provide no bearing surface so there is friction between the plastic wheel's internal surface and the metal axle. Since this friction reduces speed we need to minimize it by making the mating surfaces smooth and lubricating them. It is usually against the rules to machine the plastic wheel and these procedures usually require a lathe or other tools not typically available to a Cub Scout. That still leaves the axle open to "play with". The following suggestions are things you can mostly do with hand tools and drill to greatly improve performance of the axles.

Axle Burr Removal. Heads of the nails used as axles in the kit have a mold or casting mark in two places just where the head attaches to nail shaft. Remove the metal webs with a file, being careful not to gouge or scratch the running surface of the shaft. This will prevent the axle from grinding the wheel hub area, slowing down your car.

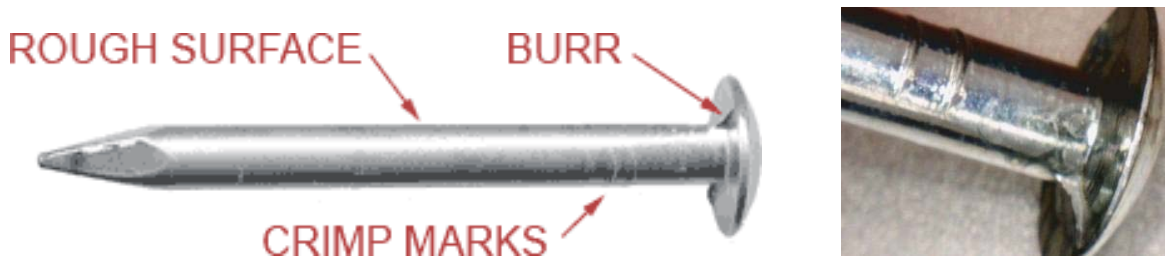

Axle Filing. Use a small, fine file to remove crimp marks and improve roundness of the axle. To do this, chuck the pointed end of the axle into a drill press or drill motor that's secured with a vise or clamp. Spin the drill slowly and look for wobble in the axle shaft (not the head). If the shaft is not straight and wobbles while spinning, discard it and try another axle. With the drill spinning, carefully place the flat file against the rotating axle and apply even pressure while moving the file slowly. Do this only to 1/2" (10 mm) of the shaft nearest the head until the crimp marks are removed completely and the axle becomes round, which means the shaft will become slightly smaller than the rest of the axle body. Be careful not to remove too much metal or the axle becomes weak where it will not tolerate being dropped or withstand handling without bending. This is a trial and error process with testing required to result in a fast turning wheel. You may want to buy extra axles for this step and use the best on your car.



Filing Burrs underneath Head

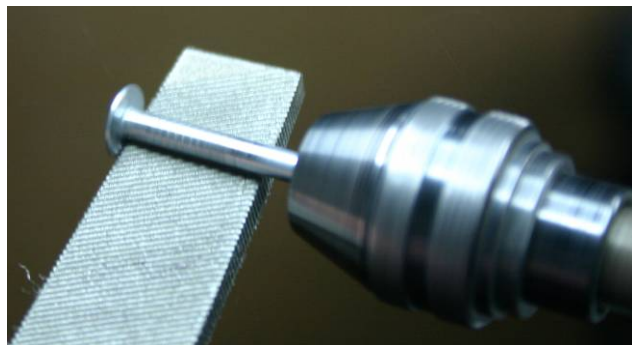

Filing Crimp Marks from Shaft

First-Surface Polishing. Axles can be finished to a high luster by following the steps detailed here. First, mount the axle in drill motor chuck exposing the head and the first 1/2" of the axle. Secure the drill so that it doesn't move. Cut 320 and 600 grit wet-or-dry sandpaper to strips approximately 1/2" (10 mm) wide and 4 to 6 inches (about 100mm) in length. Starting with the 320 grit, wet the surface of the sand paper with water, start the drill and stretch the sandpaper over the axle (see below), pulling it back and forth like a shoe polish cloth. Repeat the same using the 600 grit paper, working the sandpaper until the metal is smooth in the wheel running area (1/2" next to head of axle). This usually takes a several minutes per axle.



Wet sanding axle shaft



High-speed axle polishing axle

Final Polishing. Now, using pumice paste, polishing compound or metal polish in a soft cloth (like an old tee-shirt), start the drill spinning at the highest possible speed and stretch the cloth and polish compound and hold it against the axle shaft with a slight movement back and forth (see above). You should see the color of the cloth turn black as the polish removes some metal from the axle shaft. This will take a several minutes to produce a smooth finished axle with a mirror-like appearance.



BSA Kit Axle "Nail"



Finished Axle after polishing

The axle preparation process should transform the nails with flaws from the PwD kit into a set of highly polished axles, as shown, above.

Construction Step 12 - Lubrication.

The type of lubrication is restricted to dry lubricants at most Pinewood Derby races, but there are great advantages to using the *right* lubrication. By the same token there is harm in using the *wrong* lubricant. First, let's discuss what it's all about.

The wheel should turn on a dry axle without any undo force, but **friction** between the two parts will act to slow it down. This friction is the #1 enemy to eliminate. While we can't eliminate friction completely, it can be greatly reduced. Automobiles use steel roller or ball bearings to reduce friction on its wheels, but our car isn't permitted to use those. We can only lubricate what we already have. A lubricant is any agent that provides a reduction of friction. While there are many types, some lubricants will either not work on lightweight parts or are not formulated to work with plastics. Petroleum products such as motor and household oil will soften the plastic wheels, where, after a period of time, could fail to turn at all. This is not the surprise you'd like on race day. **Liquid or aerosol lubricants including spray-on Teflon, WD-40, CRC and 3-in-1 oil, which you'll want to avoid, as they are illegal for Pinewood Derby races, anyway.**

The most common and successfully used lubricants for PwD are *dry lubricants* from **graphite formulations** and **Graphite-Moly blends**, which provide a very thin plating of *microscopic spheres* to greatly reduce rolling friction. Plain graphite, usually in a plastic squeeze tube, is available in hardware and some variety stores, and Graphite-Moly blend lubricant, such as **PineCar Hob-E-Lube™**, can be found at hobby stores. After inserting an axle through a wheel, hold the axle where its point and the wheel hub are pointing up and the wheel's spoked side is resting against the axle head. You will notice a gap between the wheel and axle. Hold the lubricant tube at an angle so the tip is pointing to this gap then squeeze the tube to "puff" out some lubricant. Spin the wheel to help distribute the lubricant through the running surface. Repeat this several times to ensure the wheel-axle gap has lubricant spread throughout.



Popular PwD Dry Lubricants



Puff between wheel and axle

A good test of reducing adequate wheel friction is a spin test. While holding the axle in a horizontal position, spin the wheel with a flick of your finger. It should spin smoothly and *quietly*, then slowly come to a stop after 20-30 seconds. If it didn't spin that long,

take a look at wheel clearance, axle finish (polishing) and lubrication, then correct any problems and test again. If you hear noise and / or feel vibration while the wheel is spinning, this indicates the wheel is out-of-round, or out-of-balance and you should try another wheel. If you don't find 4 wheels that spin smoothly, consider purchasing the BSA axle-wheel kit (approx \$3.00 for 5 wheels and axles), again follow steps 10-12 with each wheel and axle, then pick the best four wheel-axle combinations to install on your car. Remember, a smooth spinning, quiet wheel is key to having a fast PwD car.

Construction Step 13 - Wheel Installation and Alignment.

A pinewood derby track must have a guide strip in each lane to keep cars on the track and to prevent them from hitting each other. But each time a car's wheels hit it the car slows down a little. This is where wheel installation becomes important because a car will hit the guide strip fewer times during a race if it runs straight down the track.

Install wheels so there is approximately 1/32 inch clearance (0.95 mm) between the body and wheel hub, and insure the car body surface has a hard, smooth finish where the wheel hub touches it as it rolls down the track (no washers allowed).

At this stage of car building there are some additional tricks to consider. First, while you must race with all 4 wheels, they all don't necessarily have to touch the track surface. If each wheel has rolling resistance, don't roll all of them. Simple. Usually, the best one to elevate off the track is one of the front wheels.

Second, you might prevent additional rolling resistance by installing axles at a slight angle to the body where wheels ride the end of the axle against the head, instead of the car body. This can be a tricky thing to do, so if you decide to try this, be careful the angle of the axle is just slight off 90°.

Test roll the car so you are satisfied it rolls in a perfect line. Put the car on a flat board or other smooth surface with a straight line scribed for reference. Lift the board so the car begins to roll. It should roll very close to the line. If it doesn't, then a front end alignment is required. Slightly bend the wheel axle(s) to correct the drift.

Checking Alignment. Another test using a long smooth surface is to check for tracking or wheel alignment. Draw a straight reference line on your surface and place the car on the surface with the wheels on top of that line. Now elevate the surface to the rear of the car to start the car rolling. Your car should roll along that line if it's tracking straight.

Construction Step 14 - Other Testing.

Now that you've finished construction and initial wheel alignment of your car, you will want to test and re-test it until you're sure you have achieved the best the car can do.

This will involve reviewing the last few steps in the construction phase of the car and verifying those details. Go back to any previous steps if you feel the car isn't right. You might just decide to build another car for comparison, and then race the fastest😊😊.

Breakaway Friction. Using a smooth board or table, evaluate how soon the car(s) start to roll. To judge rolling resistance and the initial breakaway friction resistance, place your car(s) on the surface then slowly elevate one side until they just start rolling. The lower the angle, the lower the friction and the better your car.

Forward or "R" for Race. You will find sometimes for no apparent reason a car runs faster when racing backwards. Maybe its weight position, alignment, wheel placement or other more obscure reason, but for whatever reason, it is a fact that most cars will run slightly faster in one direction than in another. Please understand that while there is a slight difference it may not be enough to make a huge difference in the long run. Just the same, if there's difference you're just as well to take advantage of it. Run your car against another car and try racing it both frontwards and backwards to see which is faster. Maybe that "R" on the gear shifter is for RACE in Reverse.

Step 15 - Racing your Car.

It's too bad that you don't have a chance to race your car every day, but that makes it all the more special when you do race. We'll talk about technique and technical racing tips in just a minute. First we have to remember what this is all about. Fun! Of course we've spent a considerable amount of time building this car and we expect it to do well, b-u-t so did a lot of other racers. At the end of all the racing there will one car declared Champion. It may or may not be yours. It may not be your fault or something you have control over. Sometimes luck may in the end help determine the winner. This is where your **sportsmanship** will come into play. Sometimes it's hard to be a good loser, but remember you are in good company, you will have done your best, and that's what scouting is all about! It's a Cub Scout tradition to "Do your best!"

Even with the fastest car you can lose a race.

It is a fact. How can this be you ask? Well, first you should try to determine if you are playing a fair game. Does your car comply with all the rules for the contest? If it doesn't you may be eliminated before the race starts.

Are all the other cars obeying the racing specifications?

For instance, you won't have a chance against a car that weights an ounce or two over the limit. The race committee should be uniform in checking everyone's cars.

Insist all cars be weighed by the same scale and that no car races heavy!

All cars should be inspected prior to the race to a set of specifications published well before the race day. Cars not in compliance must be repaired before being allowed to race.

Is the race track fair?

It is highly likely that a track will have some lanes that are faster than others. For the sake of fairness, races must be managed so each car races in each of the lanes to avoid any car having an unfair advantage. This requires a racing scheme where each car is assigned to race once in each lane.

Is the racing chart fair?

There should be a race chart or elimination technique designed to make sure that each racer races at least twice before being eliminated. Single elimination races are not very good or accurate contests. The more races the better.

The following hints will help give you the best chance to win:

1. Insure your **car is tracking (steering) in a straight line** before check-in
2. Insure that you have **thoroughly lubricated your car before check-in**
3. Check your wheels for minimum friction. **Can you spin each of the wheels and have them spin 20 to 30 seconds before they come to a stop?**
4. **Always handle your car by the body** not the wheels.
5. **Don't roll your car in the dirt or on concrete surfaces.** It's a sure way to ruin the wheels and axles before the real race even begins!
6. **Don't run while carrying you car.** While running you're more likely to drop your car, which may break something you cannot repair.
7. Insure your car is placed on the track with **wheels spaced so that they do not touch the lane guide** at the starting gate.
8. **Insure when placed at the starting gate** the car points straight down the track.
9. If your car doesn't do very well rolling forward **try racing it backwards.** Cars may run faster one way than another.

With a good attitude and Scout Spirit, no matter what happens, you'll always be a winner in everyone's eyes.

Good luck! Have fun!

Some Reference Websites for Pinewood Derby

- <http://home.simplyweb.net/bosworth/howto.htm>
- <http://www.pinewoodderby.com/>
- <http://www.maximum-velocity.com/>
- <http://www.pinewoodprofessor.com/>
- <http://www.abc-pinewood-derby.com/>
- <http://www.derbychamp.com/>
- <http://www.winderby.com/>
- <http://www.pinewoodextreme.com/>

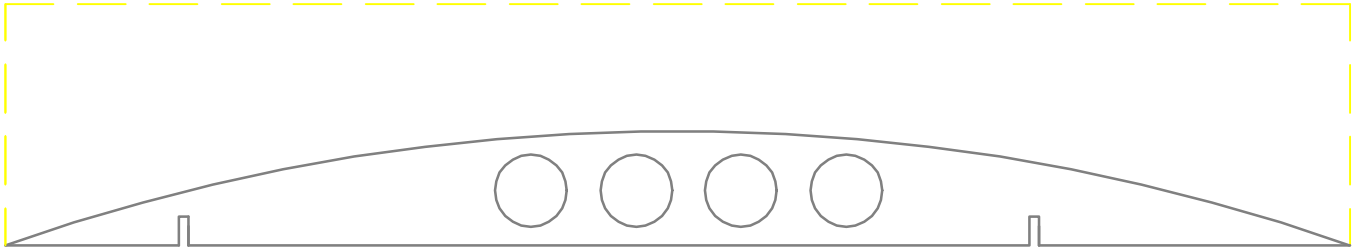
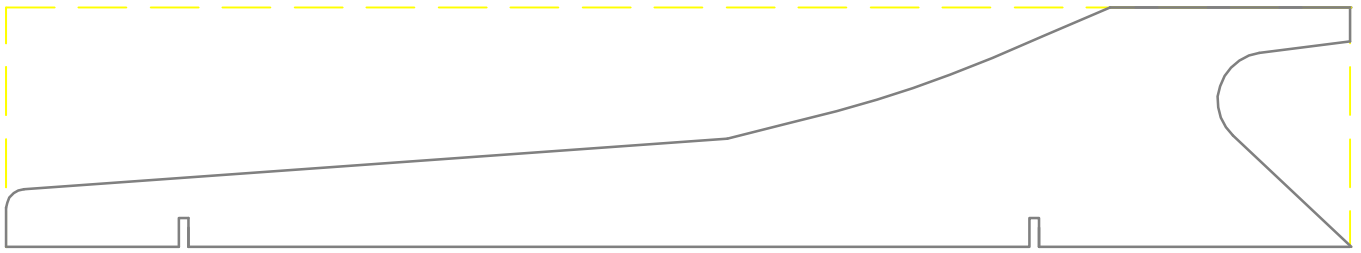

3/8" HOLES FOR WEIGHT



GLUE EXTRA WOOD TO BLOCK FOR REQUIRED HEIGHT

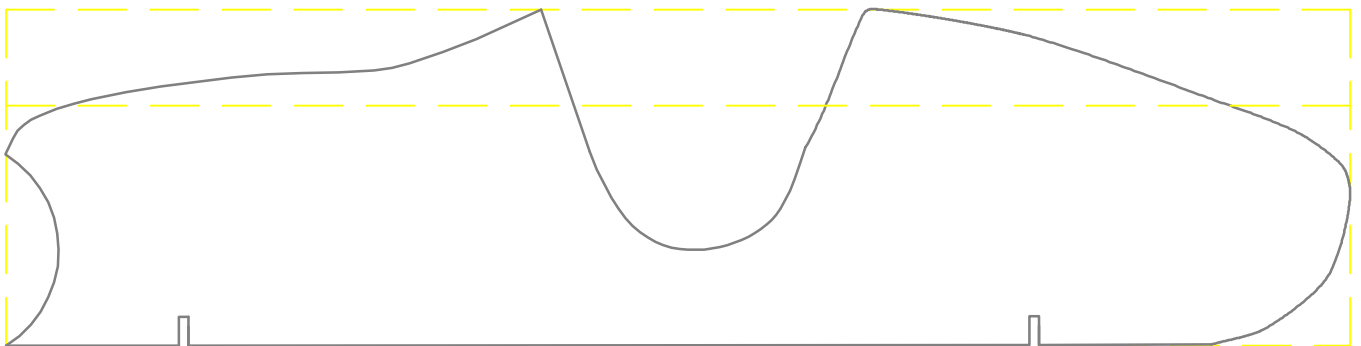

GLUE EXTRA WOOD TO BLOCK FOR REQUIRED HEIGHT

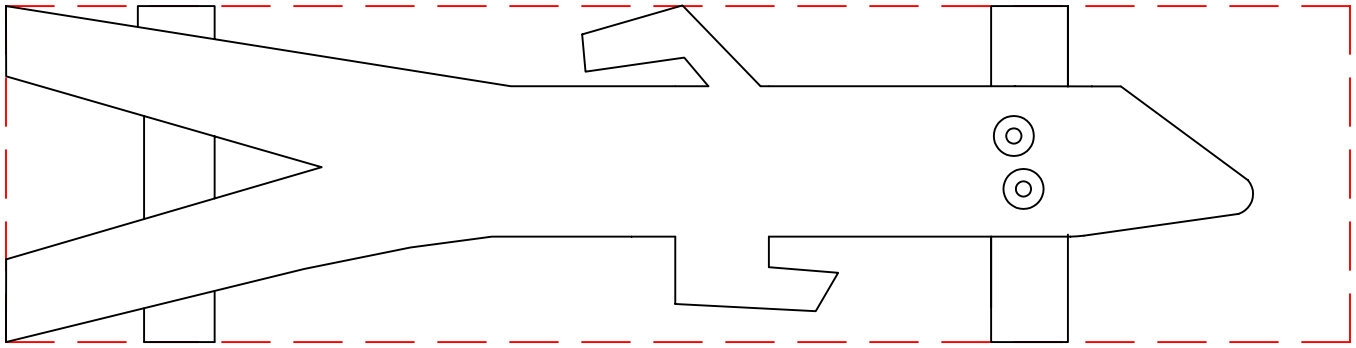

GUMBY

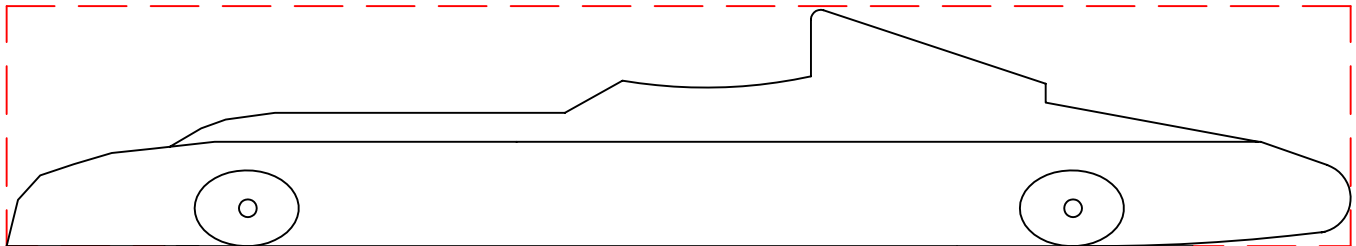
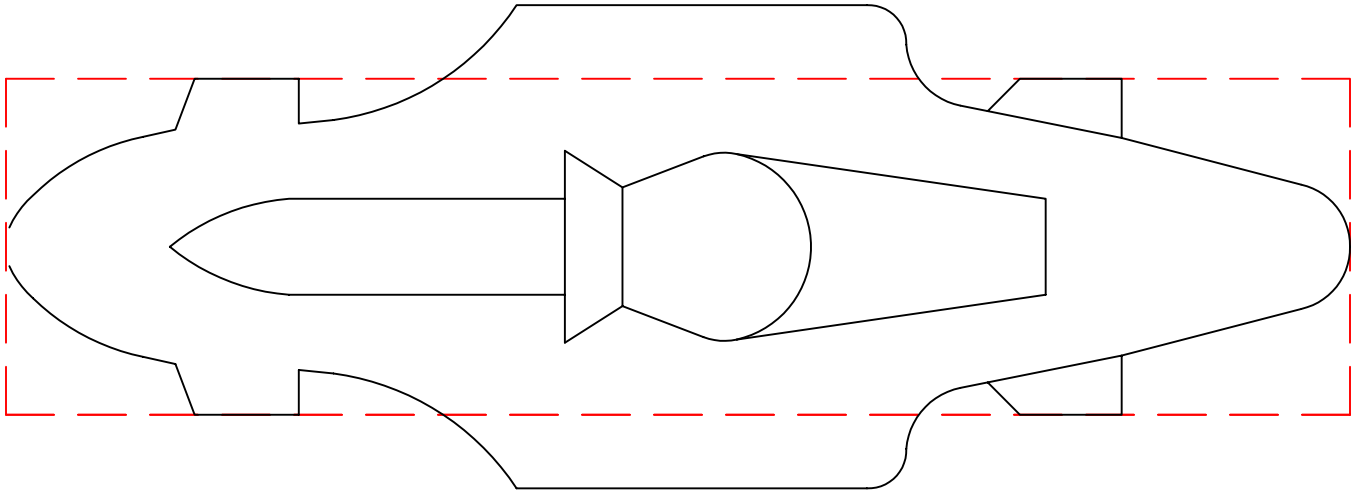
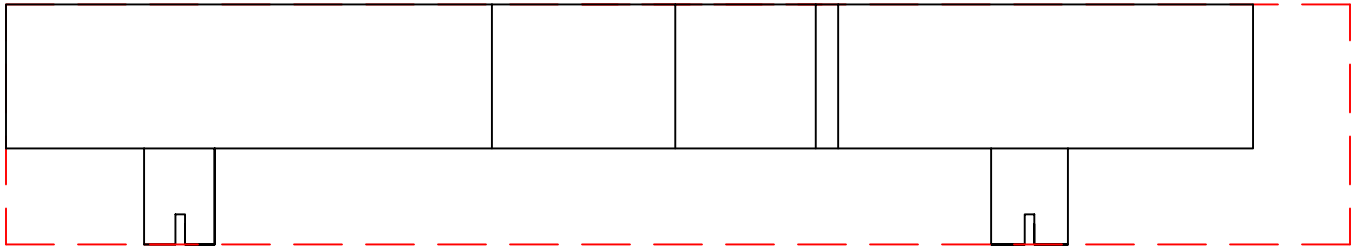

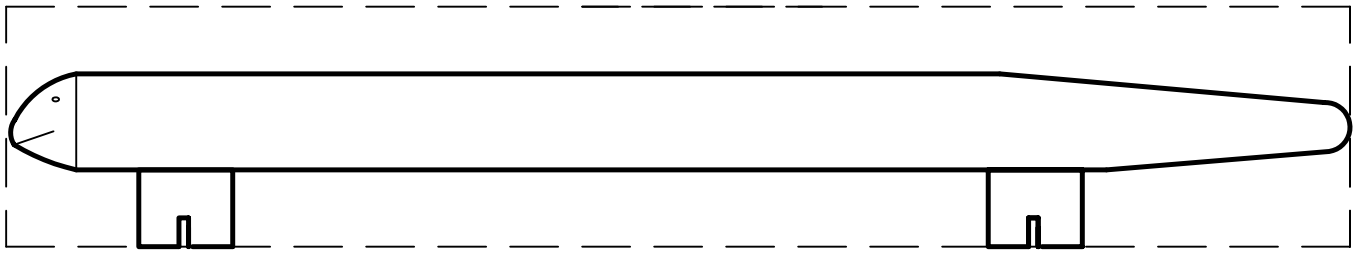

"SNEAKY SNAKE SIDE VIEW"

FRAGILE DESIGN, USE REINFORCEMENT

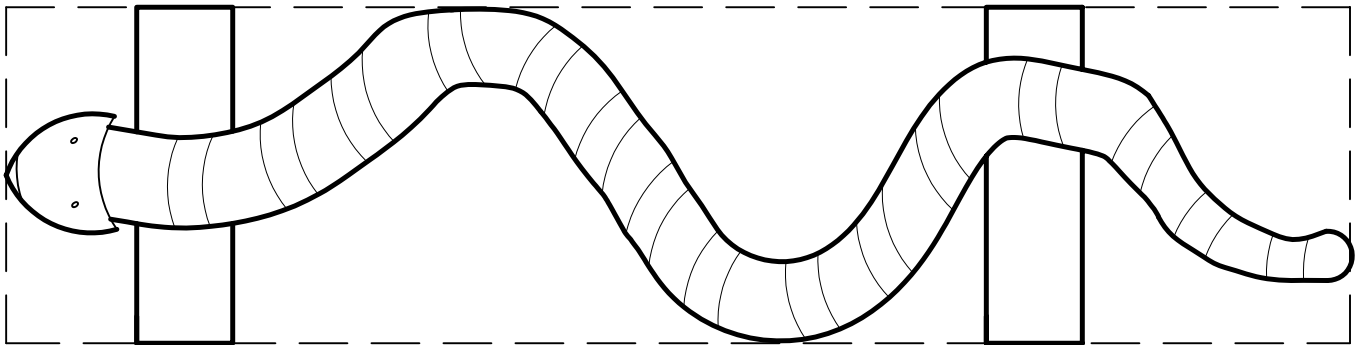

"SNEAKY SNAKE TOP VIEW"

1/8" WOOD DOWELS

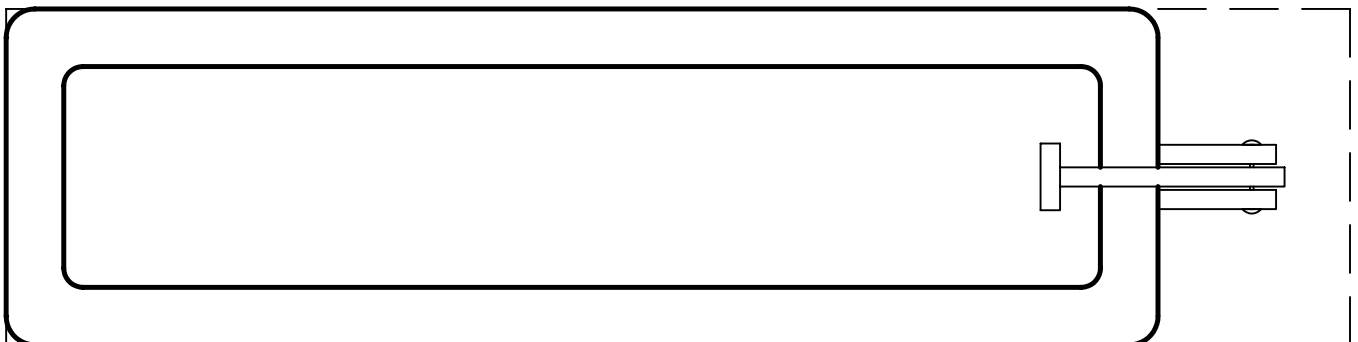

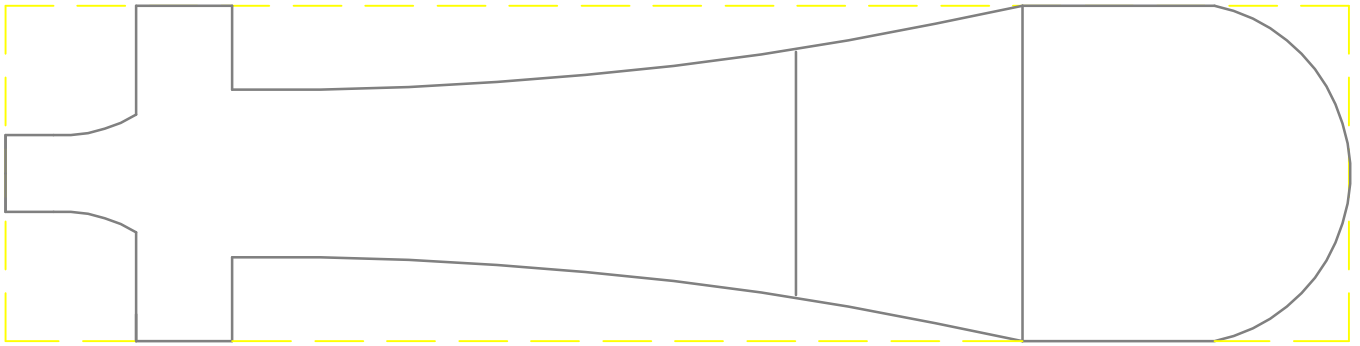
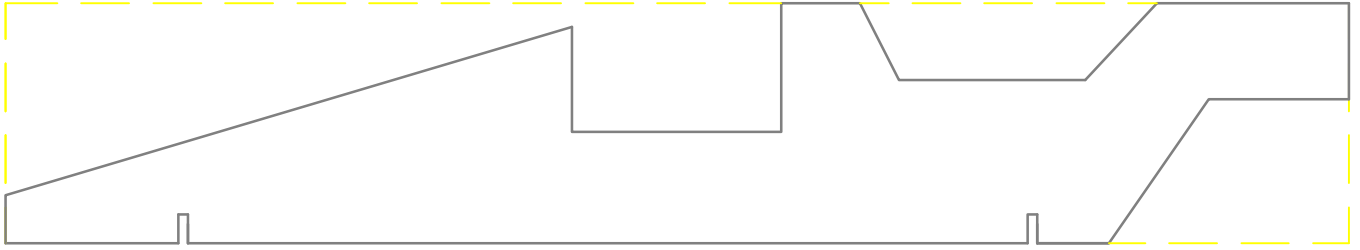

"DRAGSTER TOP VIEW"

"DRAGSTER"

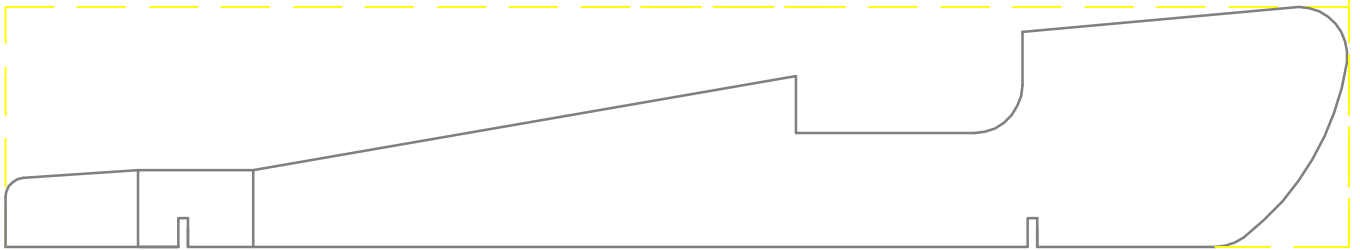

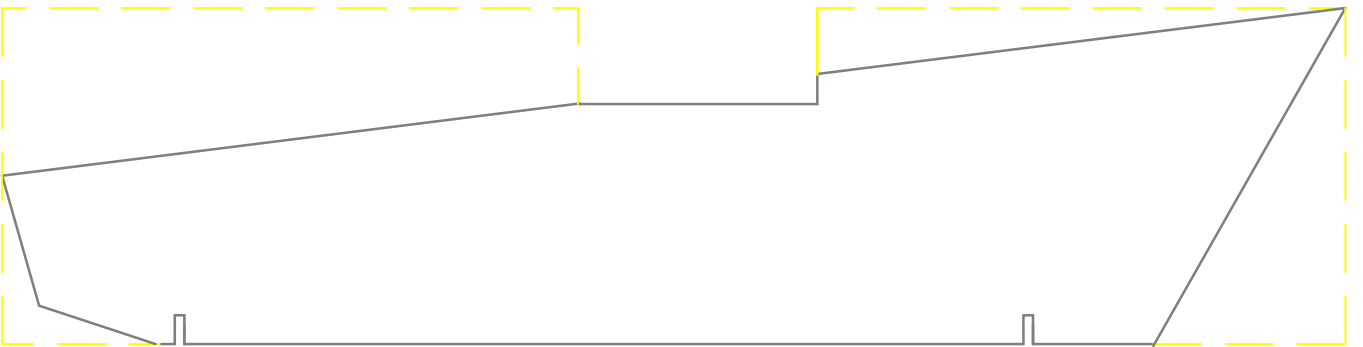
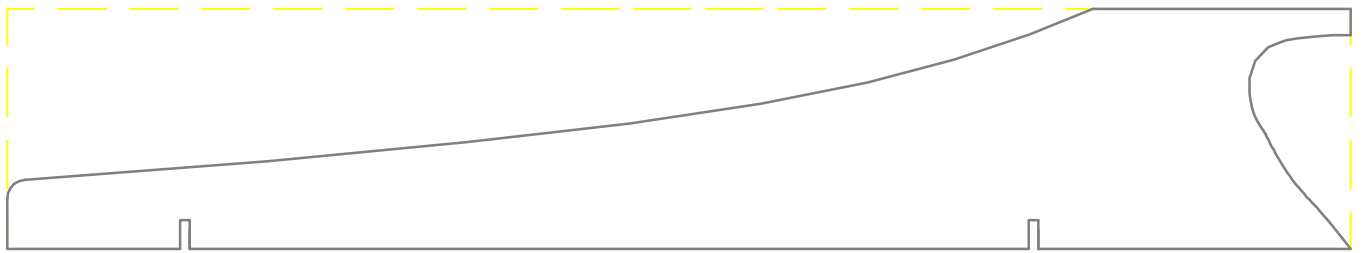

OLD STYLE BLOCK

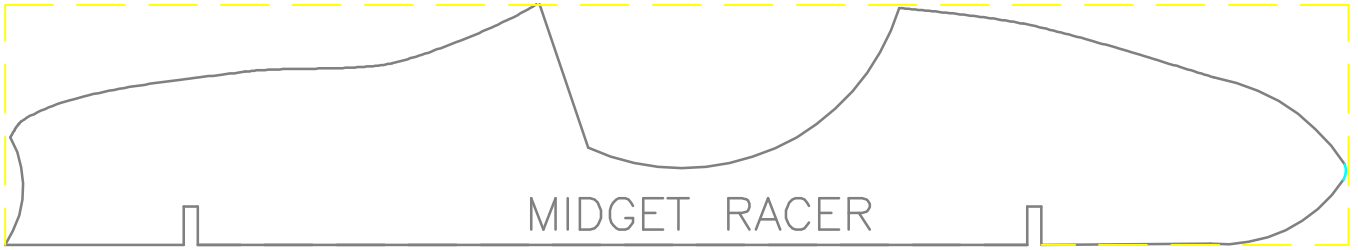
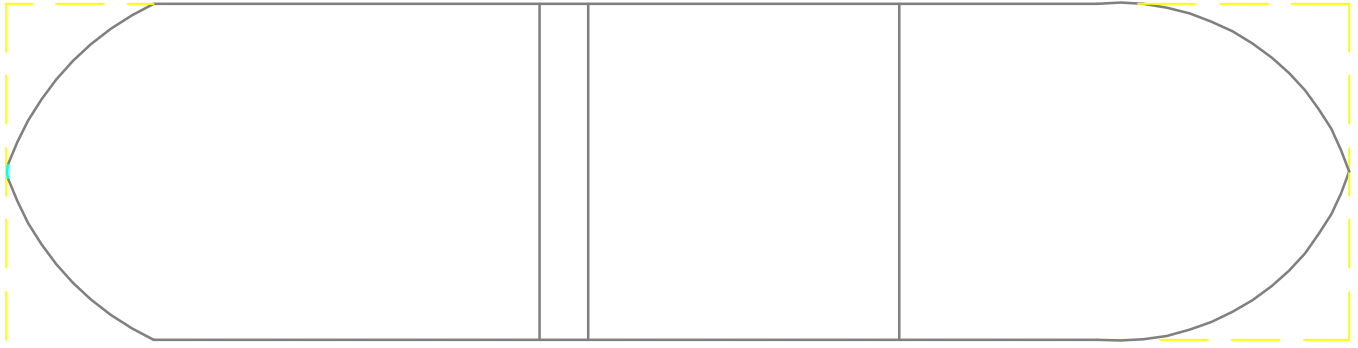

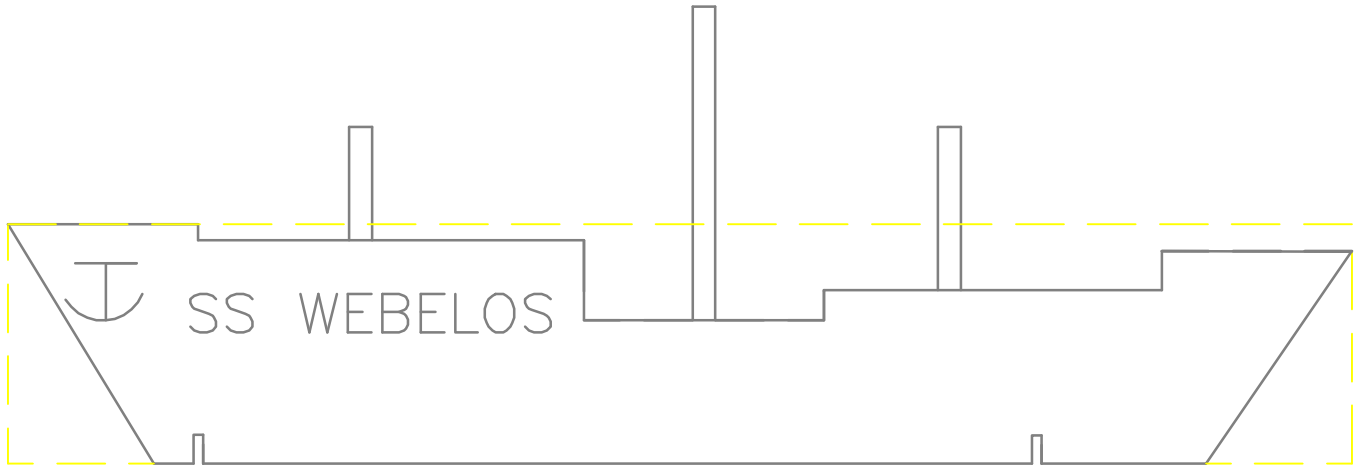
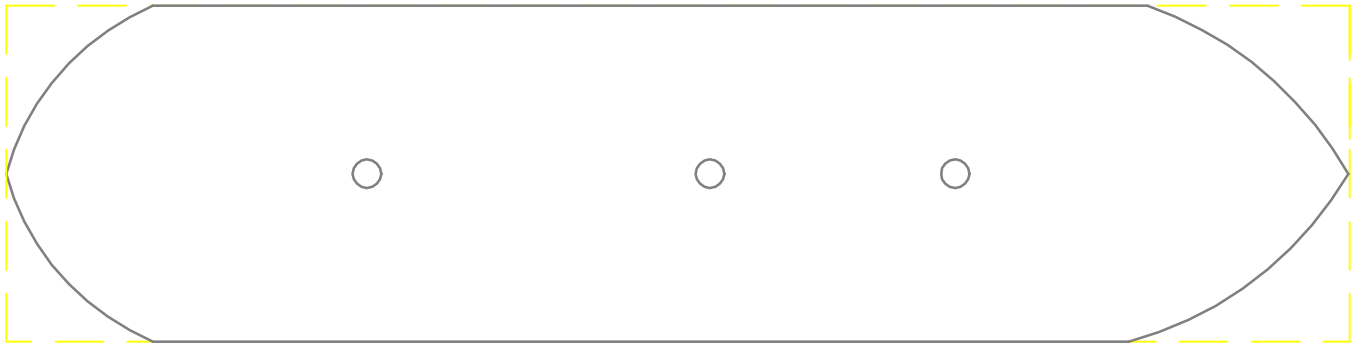

GLUE ON ROUNDED 1/2" DOWEL

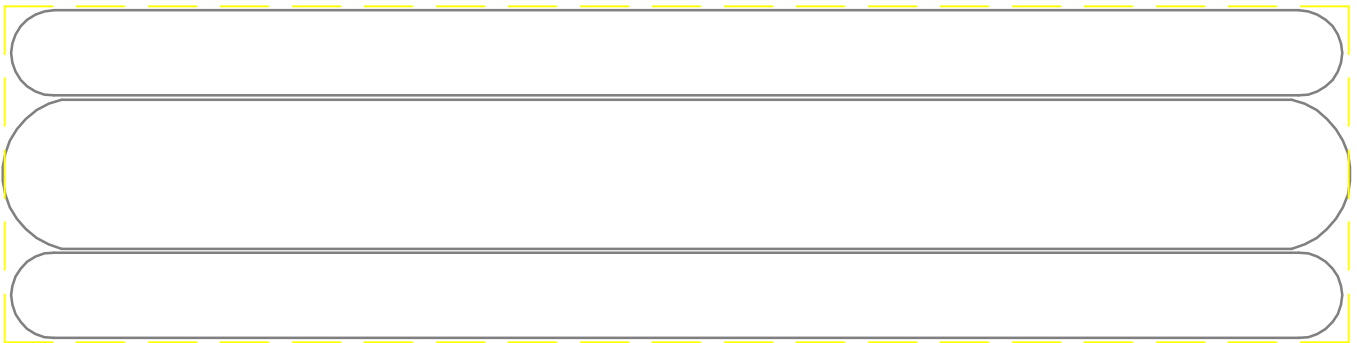
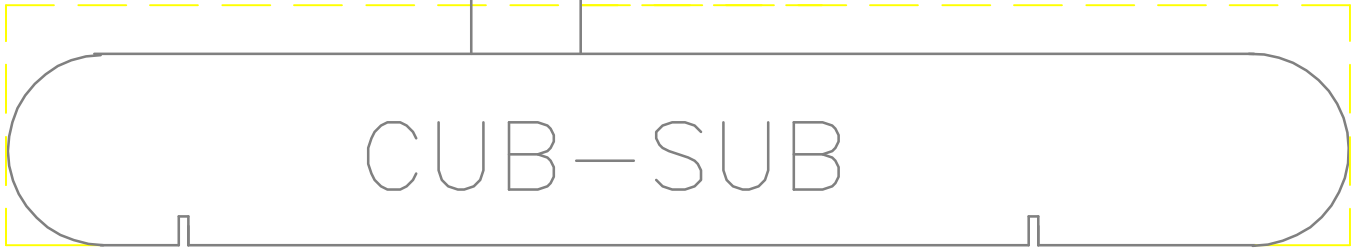

HOTDOGGER TOP VIEW

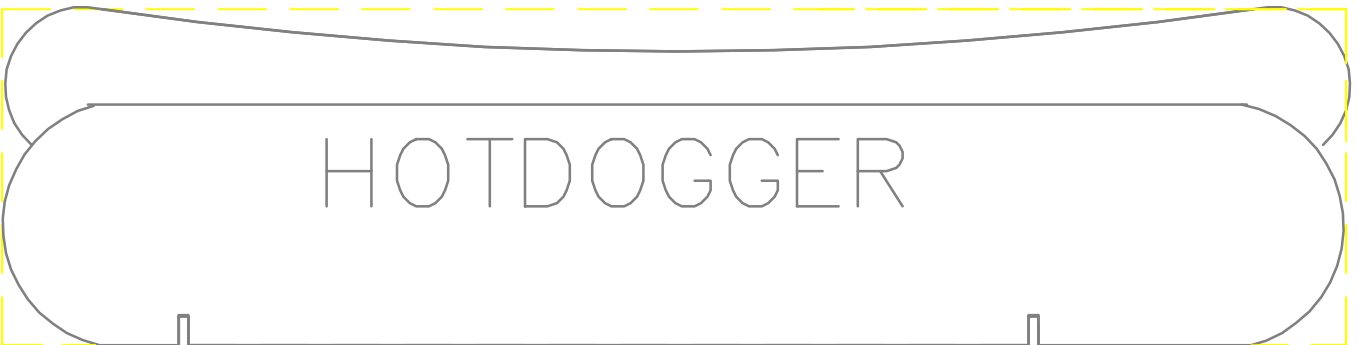

GLUE ADDITIONAL WOOD FOR HEIGHT

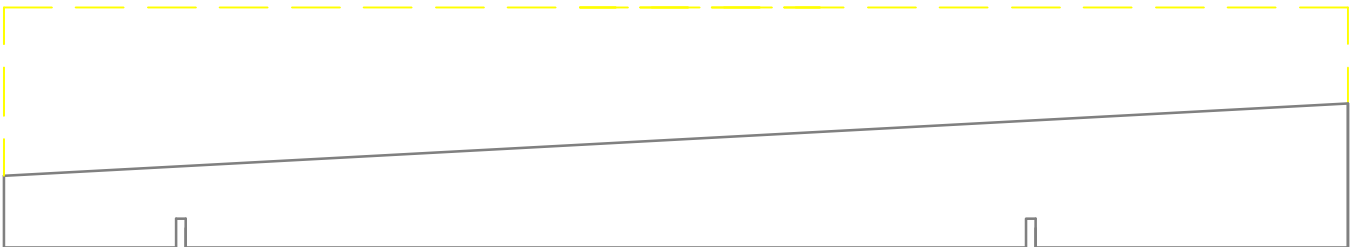

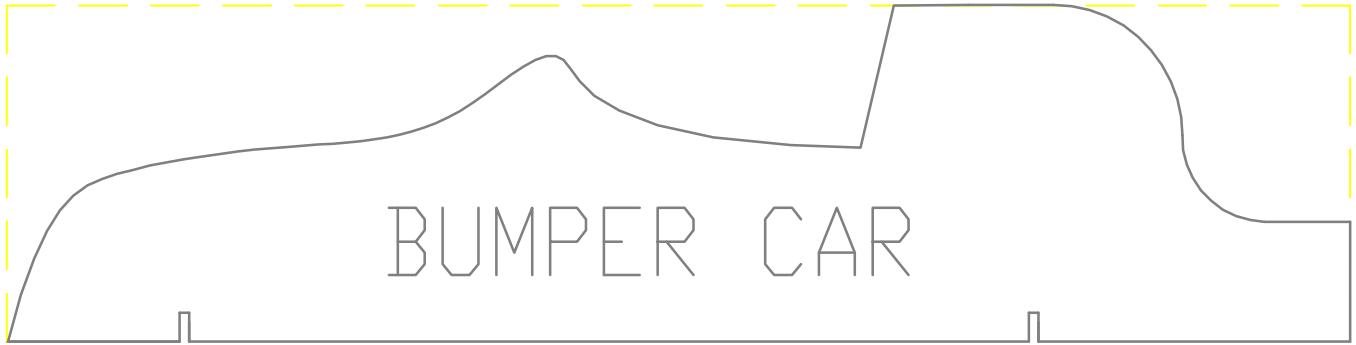

GLUE EXTRA WOOD FOR ADDITIONAL HEIGHT



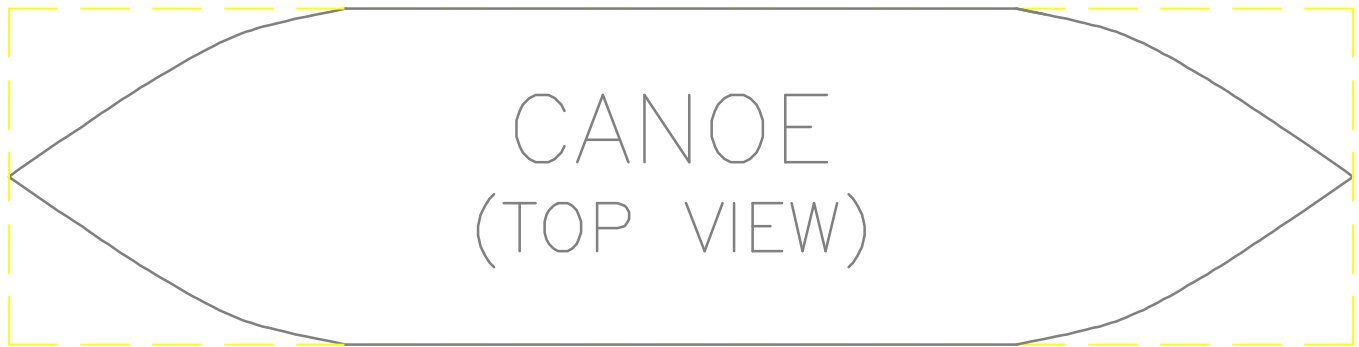
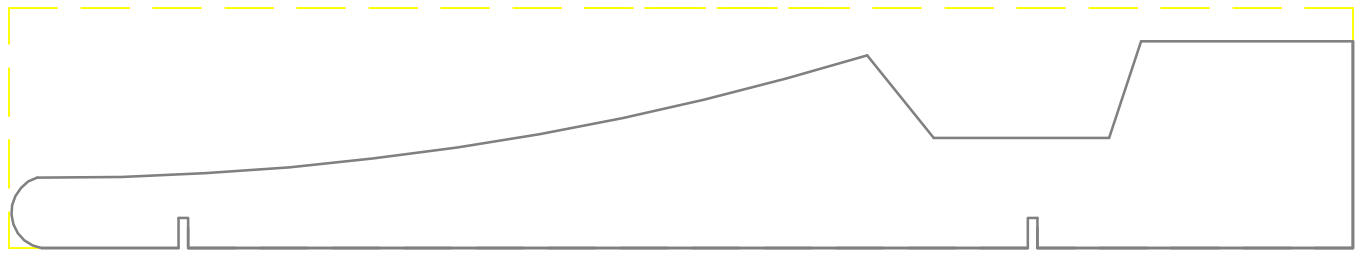
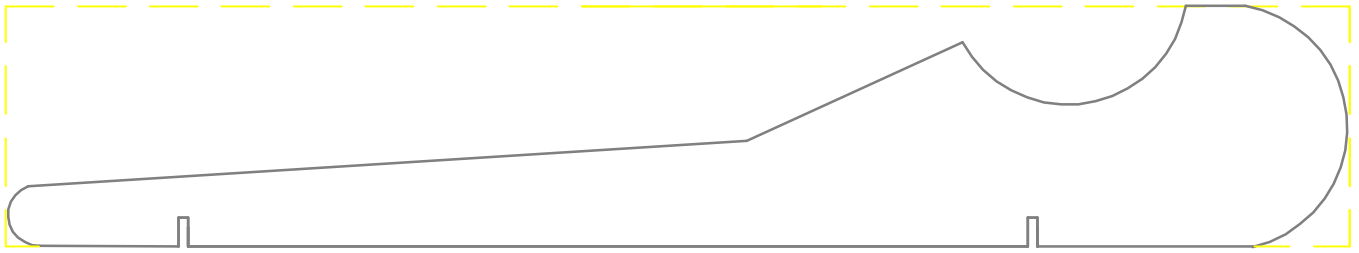

REQUIRES EXTRA HEIGHT



SHORTEN WHEELBASE

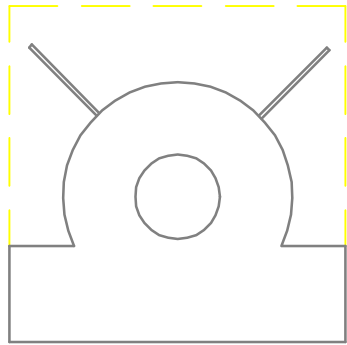
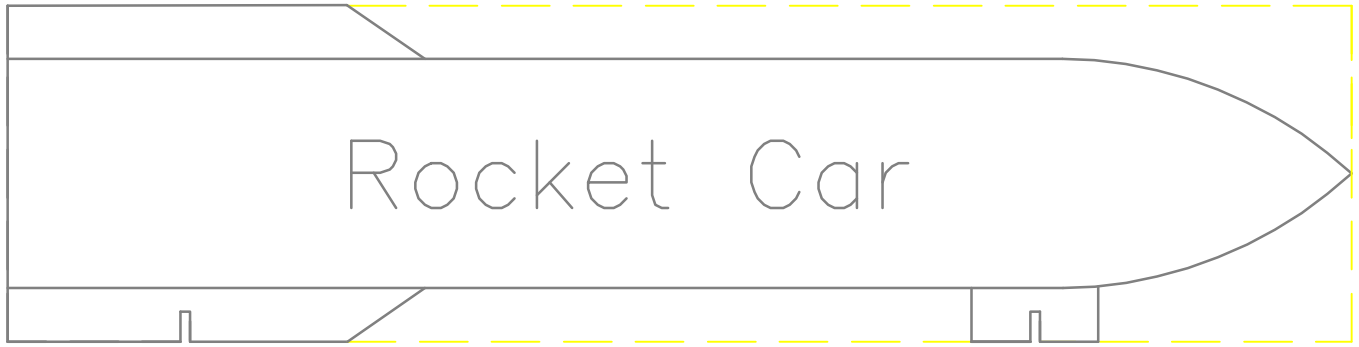

END VIEW

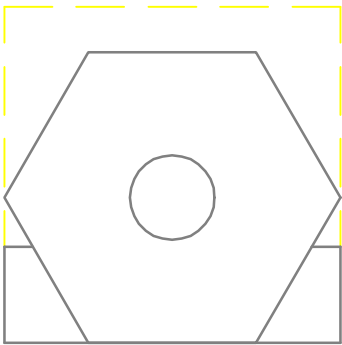

END VIEW

GLUE ADDITIONAL WOOD FOR THESE DESIGNS

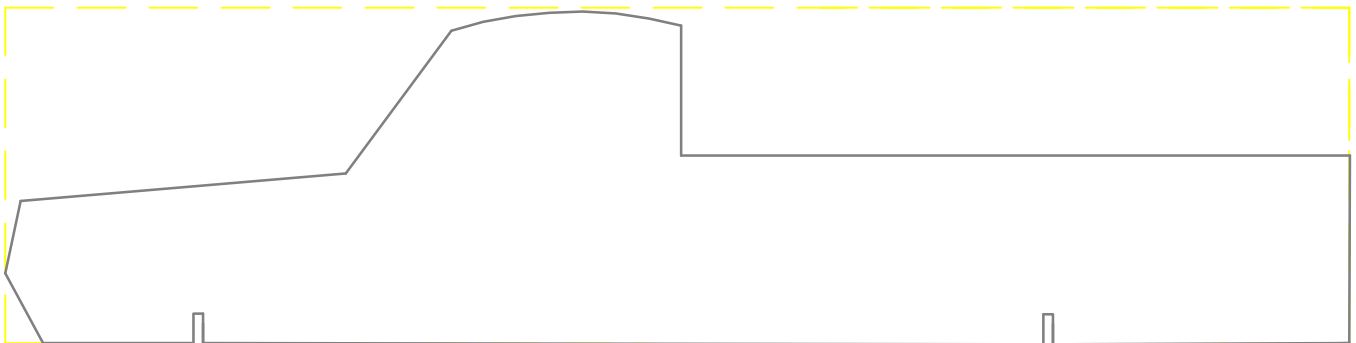
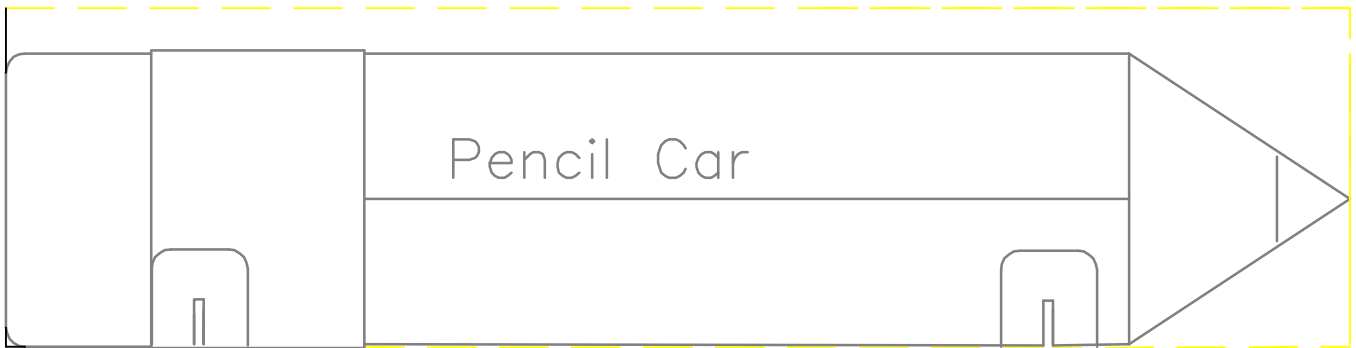

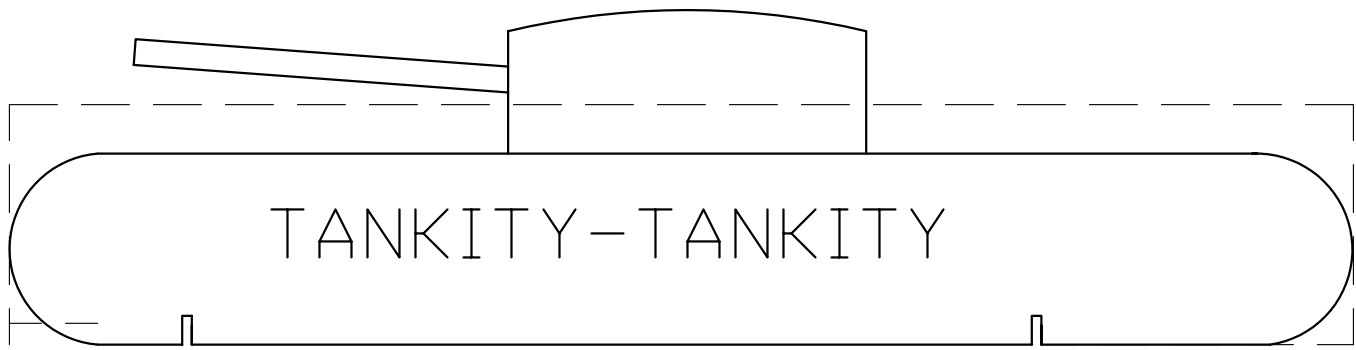

TANKITY-TANKITY

ADD WOOD FOR TURRET AND BARREL

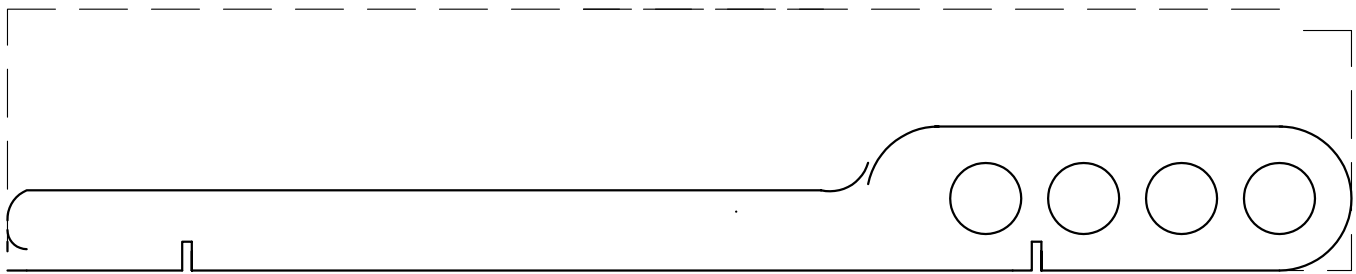

ADD WEIGHT IN 3/8" HOLES

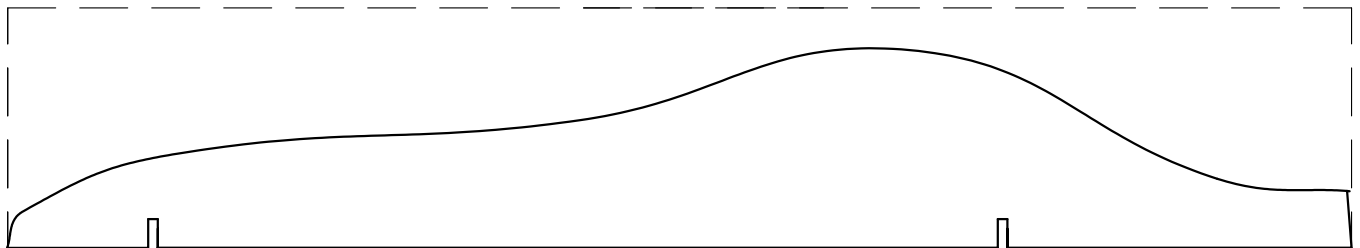
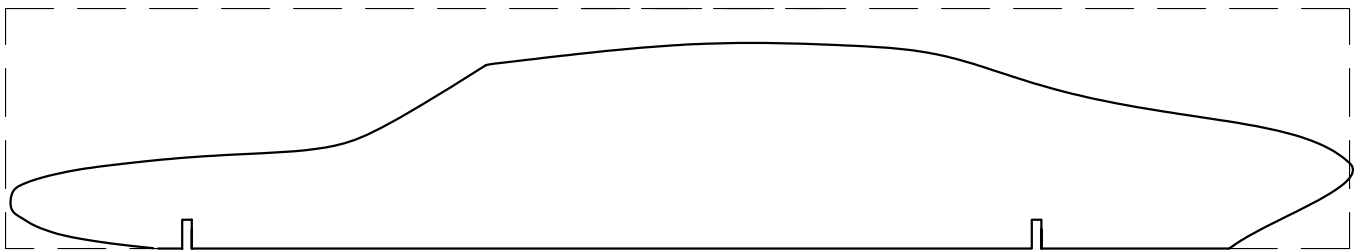

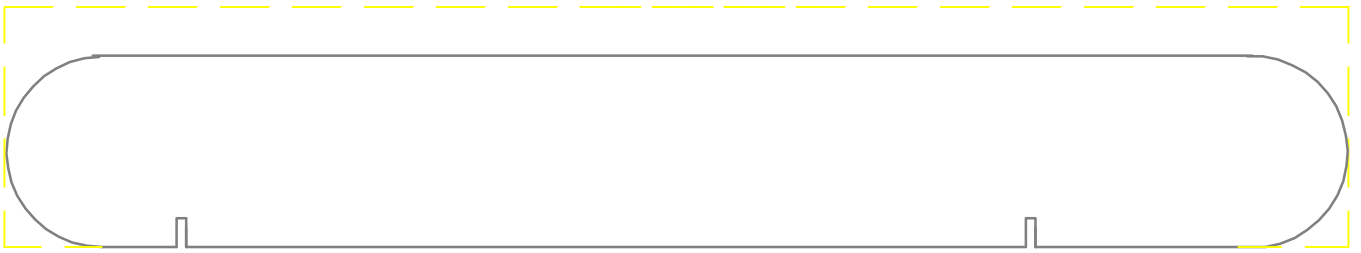
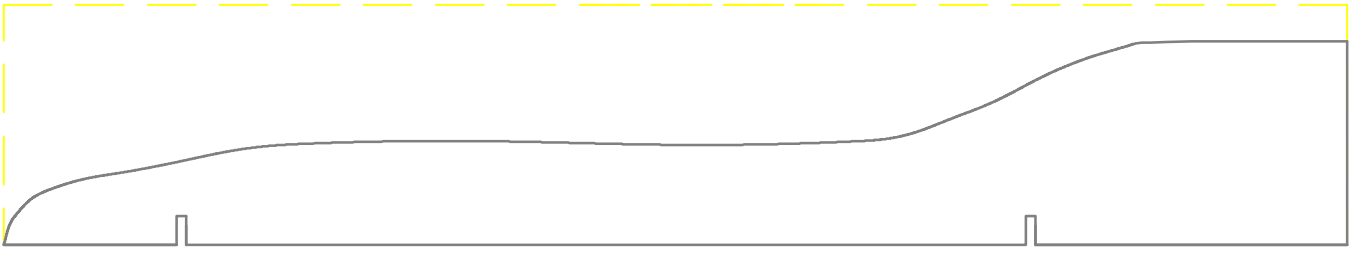

THE CRAYON CAR CAN BE CUT FROM THE STANDARD BLOCK THEN ROUTED TO REMOVE WOOD TO PROVIDE SPACE FOR ACTUAL CRAYONS TO BE INSERTED AS SHOWN. THE PAINT SCHEME COLORS DEPICT REALISTIC COLORS THAT MIGHT BE FOUND ON COMMERCIAL BOXES.

