

BUILDING ENERGY EFFICIENCY  
TECHNICAL GUIDELINE FOR

# PASSIVE DESIGN





BUILDING ENERGY EFFICIENCY  
TECHNICAL GUIDELINE FOR

# PASSIVE DESIGN



## **Building Energy Efficiency Technical Guideline for Passive Design**

Published by the Building Sector Energy Efficiency Project (BSEEP), Malaysia.  
© BSEEP. All rights reserved.

### **Building Sector Energy Efficiency Project (BSEEP)**

Environment and Energy Branch  
Public Works Department Malaysia Headquarters  
Level 22-23, PJD Tower  
No. 50 Jalan Tun Razak  
50400 Kuala Lumpur  
Malaysia

### **Component 4: Information and Awareness Enhancement**

CK Tang | Lead Consultant  
Nic Chin | Consultant & Production Manager

### **Art Direction, Design, Layout, Charts & Editing**

Kane+Ein Creative

### **3D Graphics**

Kiub Design

### **Printed in Malaysia by**

Printmore Sdn Bhd

The contents of this publication may be freely reproduced for non-commercial purposes with attribution to the copyright holders.

This document is produced as part of Component 4, Building Sector Energy Efficiency Program (BSEEP). The views expressed in this document, are those of the authors and do not necessarily reflect the views of either JKR or UNDP.

First published in July 2013.

This is a limited edition print. Not for sale or resale.

ISBN 978-967-5957-25-3

# FOREWORD

The climate is changing. The earth is warming up. The Intergovernmental Panel on Climate Change (IPCC) Fourth Assessment Report (AR4) has stated an increase of 0.74°C in the global average surface temperature which could wreck havoc upon humans, radically altering habitats and accelerating extinction.

International action to combat climate change is necessary. The Global Environment Facility (GEF) has set up funds to help combat climate change and the Building Sector Energy Efficiency Project (BSEEP) is one such project financed by those funds. The United Nation Development Programme (UNDP) and Public Works Department (PWD) Malaysia are the global and local implementers for BSEEP respectively.

The goal of BSEEP is to reduce annual growth rate of Green House Gas (GHG) emissions from the building sector in Malaysia by improving energy utilisation efficiency. BSEEP consists of 5 components. This technical guide book is one of the outputs from Component 4 which is on information and awareness enhancement.

This guide book is divided into 2 parts, i.e. (i) Passive and (ii) Active elements in energy efficient building design. This is the first part of the guide book which focuses on passive design.

I hope the designers in this country will find this guidebook relevant and useful in working towards energy efficient buildings in particular and sustainable development in general.

In closing, I would like to thank and congratulate to all parties involved in the production of this guide book. I would also like to give a special mention to the support given by Mr Tang Chee Khoay, Mr Nic Chin Yee Choong, Mr Bruce Rowse and Mr Asfaazam in putting together this guide book in such a short period of time.

**Dato' Seri Ir. Hj. Mohd Noor Bin Yaacob**

Director General  
Public Works Department Malaysia

*Concurrently*  
Chairman  
National Steering Committee  
Building Sector Energy Efficiency Project (BSEEP)

# PREFACE

This Energy Efficiency Technical Guideline for Passive Design was written specifically for Malaysian climate zone. It is an attempt to provide a simple and yet useful guideline to practicing building designers in Malaysia for design decisions to be made quickly for the promotion of energy efficiency in buildings.

An industry dialogue was carried out on 13<sup>th</sup> June 2012 to gain an understanding on the status of current energy efficiency design practices and to identify the information that is sought after by the industry, for energy efficiency to be practiced on new building developments. 18 industry leaders from both private and public sectors attended the dialogue session. The valuable contributions by these attendees are recognised herewith:

Name	Department
Azme bin Hassan	Unit Pengurusan Fasiliti Bangunan , Cawangan Kejuruteraan Senggara, JKR
Sr. Syamilah binti Yacob	Unit Pengurusan Fasiliti Bangunan , Cawangan Kejuruteraan Senggara, JKR
Muhammad Nazri bin Omar	Unit Kecekapan Tenaga dan Tenaga Diperbaharui, Cawangan Kejuruteraan Mekanikal, JKR
Mohammad Faeiz bin Ismail	Unit Kecekapan Tenaga dan Tenaga Diperbaharui, Cawangan Kejuruteraan Mekanikal, JKR
Maznida Shahila binti Mat Salleh	Bahagian Perkhidmatan Kejuruteraan Senggara (BPKS)
Rozail Fitri bin Othman	Bahagian Perkhidmatan Kejuruteraan Senggara (BPKS)
Rozina binti Sudin	Unit Perunding Kecekapan Tenaga, Cawangan Kejuruteraan Elektrik, JKR
Mohd Zaini bin Abu Hassan	Unit Perunding Kecekapan Tenaga, Cawangan Kejuruteraan Elektrik, JKR
Ar. Yong Razidah Rashid	Cawangan Arkitek, JKR
Ar. Wan Norisma binti Wan Ismail	Cawangan Arkitek, JKR
Nor Sadilah binti Sadikun	Unit Pengurusan Aset Menyeluruh (UPAM), Bahagian Perkhidmatan Kejuruteraan Senggara, JKR
Ar. Chan Seong Aun	Malaysia Green Building Confederation (MGBC)
Ar. Michael Ching Chee Hoong	Pertubuhan Arkitek Malaysia (PAM)
Sandra Shim	REHDA
Ir. Wong See Foong	Association of Consulting Engineers Malaysia (ACEM)
Ir. Soong Peng Soon	Institute of Engineers Malaysia (IEM)
Ar. Thulasaidas S.	Cawangan Arkitek, JKR
Ar. Serina Hijjas	Pertubuhan Arkitek Malaysia (PAM)

A “wish list” of information was created from the industry dialogue session. From this “wish list” a few sets of building energy simulation studies (using the climate weather data of Malaysia) were developed and conducted to provide the foundation for the recommendations made in this guideline.

The building energy simulation tool used for the studies made in this guide is IES <Virtual Environment> version 6.4 from the UK (<http://www.iesve.com>). This software meets the requirements of Ashrae Standard 140 and Cibse AM11 for a building dynamic energy simulation tool. This software is adequately comprehensive, allowing different types of passive and active design features to be studied for the purpose of this guideline.

The weather data used for the energy simulation study is the Test Reference Year (TRY) weather data from an analysis of 20 years of weather data from the weather station of Subang Airport in Selangor and is described in detail in Chapter 2 of this guideline.

In the interest of keeping this document simple to use, the Mechanical and Electrical system in the building has been defaulted to the minimum requirements of Malaysian Standard (MS) 1525 (2007) and where the MS is silent, the Ashrae 90.1 (2010) was used instead. Based on these conditions, the average water-side system coefficient of performance (SCOP) was simulated to be approximately 3.1. The air side was modelled as a variable air volume (VAV) system in the rational that it should be able to capture the efficiency of the passive features better than a constant air volume (CAV) system. The total fan efficiency was assumed to be 65% with 750 Pa (2.5 in of H<sub>2</sub>O) as the total pressure.

It should be highlighted that if the actual building uses a more efficient air-conditioning system, the savings from the passive features will be lower than the estimates provided in this guideline because the air-conditioning system is able to remove more heat from the building using a lower amount of electricity. This circumstance of a higher efficiency air-conditioning system providing less energy saving for passive features in building does provide a dilemma to a guideline like this, i.e. which item comes first, passive or active features? Whichever item that is used later will provide less energy savings. For this guideline, it is proposed that passive features should be practiced first, before an attempt is made to optimise the active air-conditioning system. This assumption would then simplify the estimated energy and cost savings provided in this guideline as it is based on the **worst** allowable air-conditioning system to be installed in the building based on the current version of MS1525 (2007) and is used as the basis for this passive design guideline.

Finally, due to limited time available to produce this guideline, only one building model was used to derive all the estimated energy reduction. Different building sizes, shapes and models will yield slightly different results. However, the results and recommendations from this guideline is deemed accurate enough as a general guide to make informed building design decisions quickly in the interest of energy efficiency in buildings. The default building model used for the studies was based on a hypothetical office building scenario of 17 floors with a floor utilisation efficiency of 78% and a gross floor area (GFA) of 38,403m<sup>2</sup>. The full description of the base building is described in detail in Chapter 3, Case 1, square building scenario.

## ACKNOWLEDGEMENTS

**Christopher Barry** of Pilkington for his contribution to Chapter 5 on Glazing Properties, which is proving to be a very popular chapter, where the draft version was downloaded approximately 8,000 times in 4 months (end of August 2012 until early January 2013).

**Bruce Rowse** of Carbonetix, Australia, for his contribution to review all the chapters in this Passive Design Guideline, providing very useful tips that helped to make this document clearer and easier to understand by building design professionals.

**Dr. Nirmal Kishnani** from the National University of Singapore, whom inspired the original idea for Chapter 3, on the energy efficiency impact due to the "building form, core location and orientation".

**CK Tang**  
Lead Consultant

# MESSAGES FROM THE AUTHORS



## CK TANG

Lead Consultant

This Building Energy Efficiency Technical Guideline on Passive Design was developed with the intention of providing a simple yet useful reference, with information that is relevant and appropriate for the Malaysian climate.

It is sincerely hoped that this document will become a resourceful guide for architects and engineers to design and construct buildings in Malaysia that are energy efficient, for the benefit of our environment and our future generations.

CK Tang is currently a partner in Veritas Environment Sdn Bhd in Malaysia. CK has over the years contributed significant work to many energy efficient demonstration buildings in Malaysia, such as the Low Energy Office building (100 kWh/m<sup>2</sup>/year), Green Energy Office building (30 kWh/m<sup>2</sup>/year), and the Energy Commission's Diamond Building (65 kWh/m<sup>2</sup>/year). He is also one of the active contributors to the Malaysian Energy Efficiency in Non-Residential Building Standard, MS 1525 and the Malaysian Green Rating System, the Green Building Index.



## NIC CHIN

Consultant

Just like "Sustainability" has in recent years, "Energy Efficiency" has increasingly become a very important aspect in the development of new buildings and the refurbishment of old ones. In our current urban environment, energy efficiency cannot be ignored, especially when it comes to large developments.

A well-implemented passive building design strategy would be able to provide comfortable conditions in building while reducing the building's cooling demand, and hence reducing its energy consumption.

This guideline should provide building owners, engineers and architects with the essential knowledge to design buildings that are energy efficient from a passive design perspective.

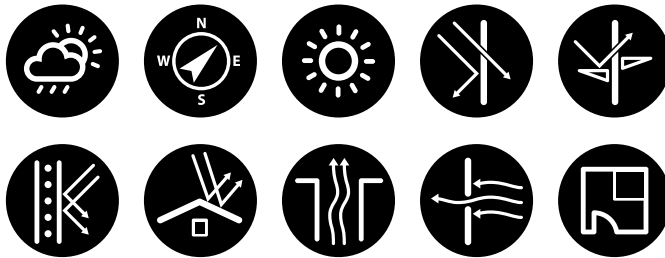
I sincerely hope that this guide will be widely read and will increase the awareness of the importance of energy efficiency in buildings.

Nic Chin is relatively new to this industry. However he has had the opportunity to be involved in various energy efficient building projects in Malaysia such as the Energy Commission's Diamond Building, Sarawak Energy Berhad Headquarters, Shell Cyberjaya, and the Works Department Headquarters. During his time in this field, he has simulated hundreds of cases to optimise energy efficiency in buildings in the Malaysian climate.



BUILDING ENERGY EFFICIENCY  
TECHNICAL GUIDELINE FOR

# PASSIVE DESIGN



# TABLE OF CONTENTS

Foreword.....	5
Preface.....	6
Messages from the Authors.....	8

## CHAPTER 1 FUNDAMENTALS OF ENERGY EFFICIENCY IN BUILDINGS

Introduction.....	17
A Holistic Approach.....	18
1st Law of Thermodynamics.....	21
Fundamentals of Air Properties.....	23
Dry Bulb Temperature (°C).....	23
Wet Bulb Temperature (°C).....	23
Dew Point Temperature (°C).....	23
Moisture Content in Air (kg/kg).....	23
Relative Humidity (%).....	23
Effective Sky Temperature (°C).....	23
Fundamentals of Heat.....	24
Sensible Heat.....	24
Latent Heat.....	24
Fundamentals of Heat Transfer.....	24
Fundamentals of Thermal Comfort.....	26
Operative Temperature.....	26
Fanger’s PMV-PPD Thermal Comfort Model.....	27
Adaptive Thermal Comfort Model.....	28
Summary.....	28

## CHAPTER 2 MALAYSIA’S WEATHER DATA

Introduction.....	31
Source of Weather Data.....	31
Location and Sun Path.....	32
Dry Bulb Temperature.....	34
Design Potential.....	34
Design Risk.....	34
Wet Bulb Temperature.....	35
Design Potential.....	35
Design Risk.....	35
Humidity Ratio (Moisture Content).....	36
Design Potential.....	36
Design Risk.....	36

<b>Dew Point Temperature</b> .....	37
Design Potential .....	37
Design Risk .....	37
<b>Relative Humidity</b> .....	38
Design Potential .....	38
Design Risk .....	38
<b>Horizontal Global Radiation</b> .....	39
<b>Diffuse Solar Radiation</b> .....	39
<b>Direct Solar Radiation</b> .....	40
<b>Comparison of Global, Direct and Diffuse Radiation</b> .....	41
Design Potential .....	41
Design Risk .....	41
<b>Cloud Cover (Oktas)</b> .....	42
Design Potential .....	42
Design Risk .....	42
<b>Effective Sky Temperature</b> .....	43
Design Potential .....	43
Design Risk .....	43
<b>Ground Temperature</b> .....	44
Design Potential .....	44
Design Risk .....	44
<b>Wind Speed</b> .....	45
Design Potential .....	45
Design Risk .....	45
<b>Wind Direction &amp; Hours of Air Temperature below 29°C</b> .....	46
Design Potential .....	46
Design Risk .....	46
<b>Summary</b> .....	48



## CHAPTER 3 BUILDING FORM, CORE LOCATION AND ORIENTATION

<b>Objective</b> .....	51
<b>Key Recommendations</b> .....	52
Location of AHU Room .....	52
<b>Executive Summary</b> .....	53
<b>Introduction</b> .....	55
<b>Methodology</b> .....	55
<b>Test Cases</b> .....	58
<b>Test Results</b> .....	59
Ranking Based on BEI (kWh/m <sup>2</sup> -year) .....	60
Ranking Based on Ratio of BEI/View Out .....	62
<b>Detailed Layout of Each Case Scenario</b> .....	64
<b>Building Model</b> .....	69
<b>Weather Data</b> .....	69
<b>HVAC Details of Case 0</b> .....	69



## CHAPTER 4 DAYLIGHT HARVESTING

<b>Introduction</b> .....	75
Daylight Availability .....	76
Daylight Factor .....	76
Acclimatisation of Daylight Factor to Malaysia .....	77
<b>Key Principles of Daylight Harvesting</b> .....	79
Solar Heat Gain Minimisation .....	79
Glare Prevention .....	80
Deep Penetration of Daylight .....	80
Uniform Daylight Distribution .....	80
Electrical Light Response to Daylight Harvested .....	80
Interior Design .....	80
Design Tools .....	81
<b>Technologies for Daylight Harvesting</b> .....	82
“Classical” Daylight Harvesting for the Tropical Climate .....	82
External Light Shelves .....	83
Internal Light Shelves .....	83
Embedded Blinds in Double Glazing with External Light Shelves .....	83
<b>Rules for Good Daylight Harvesting</b> .....	84
Right-Sizing the Window Area on the Façade .....	84
Harvesting Daylight from the Façade .....	85
Harvesting Daylight from the Roof .....	90
Harvesting Daylight from Skylight .....	92
<b>Summary</b> .....	96



## CHAPTER 5 GLAZING PROPERTIES

<b>Introduction</b> .....	99
<b>Key Recommendations</b> .....	100
<b>The Solar Spectrum</b> .....	101
<b>Glazing Terminologies</b> .....	102
Visible Light Transmission (VLT) .....	102
Solar Heat Gain Coefficient (SHGC) or G-value .....	102
Light to Solar Gain Ratio (LSG) .....	102
U-value (W/m <sup>2</sup> K) .....	102
<b>Glazing Technologies for Energy Efficiency</b> .....	103
Single Glazing Low-E .....	103
Double Glazing Low-E .....	103
<b>Glazing Properties &amp; Energy Reduction</b> .....	104
Reduction of Glazing Area .....	104
Reduction of Solar Heat Gain Coefficient (SHGC) .....	105
Reduction of U-value in Glazing .....	107
<b>The MS1525 OTTV</b> .....	107
Replacement of SC with SHGC in OTTV .....	109
Using OTTV to Estimate Energy Reduction .....	109
<b>Summary</b> .....	110



## CHAPTER 6 EXTERNAL & INTERNAL SHADES

<b>Introduction</b> .....	113
<b>Key Recommendations</b> .....	114
Estimating SHGC Values .....	116
Estimating Energy Saved .....	117
<b>External Shading Devices</b> .....	118
Horizontal Shading Devices .....	118
Estimating SHGC of Horizontal Shading Devices with Offset Distance .....	120
Vertical Shading Devices .....	123
Combined Horizontal and Vertical Shades .....	124
Estimating Energy Reduction .....	124
<b>Internal Shading Devices</b> .....	125
Reflective Internal Blinds .....	126
SHGC of Internal Shades .....	127
Important Considerations for Internal Shades .....	128
<b>Summary</b> .....	128



## CHAPTER 7 WALL INSULATION

<b>Introduction</b> .....	131
<b>Key Recommendations</b> .....	132
Estimating Energy Saved .....	132
<b>Simulation Model</b> .....	135
Wall Properties .....	136
Night Time Parasitic Load .....	139
<b>Simulation Results</b> .....	139
<b>Summary</b> .....	140



## CHAPTER 8 ROOF INSULATION

<b>Introduction</b> .....	143
<b>Key Recommendations</b> .....	144
Concrete Flat Roof .....	144
Light Weight Pitch Roof with Plasterboard Ceiling .....	146
Light Weight Pitch Roof with Concrete Ceiling .....	148
<b>Simulation Models</b> .....	150
Concrete Flat Roof Model .....	150
Pitch Roof with Plasterboard Ceiling Model .....	150
Pitch Roof with Concrete Ceiling Model .....	151
Air-Conditioning System .....	151
<b>Detailed Simulation Charts</b> .....	152
<b>Simulation Results</b> .....	154
<b>Summary</b> .....	154



## CHAPTER 9 ATRIUM VENTILATION STRATEGIES

Introduction .....	157
Key Recommendations .....	158
Comfort .....	159
Natural Ventilation .....	160
Simulation model .....	162
Air-conditioned Atrium Strategies .....	163
Natural Ventilation Strategies .....	165
Summary .....	168



## CHAPTER 10 ZONING AND INFILTRATION CONTROLS

Introduction .....	171
Key Recommendations .....	172
Modelling of Zoning Control .....	174
The Science of Zoning Control .....	175
Modelling of Infiltration .....	177
Infiltration Control .....	180
Infiltration Limits .....	180
Prescriptive requirements for doors separating non-air-conditioned and air-conditioned zones .....	180
Examples of window and door seal installation .....	181
Summary .....	184



## CHAPTER 11 INTERIOR LAYOUT OF OFFICES

Introduction .....	187
Key Recommendations .....	188
Estimating Energy Saved .....	188
Simulation Model .....	190
Simulation Results .....	192
Summary .....	193

Glossary of Terms .....	194
-------------------------	-----

CHAPTER

# 1

# FUNDAMENTALS OF ENERGY EFFICIENCY IN BUILDINGS





## 1

# FUNDAMENTALS OF ENERGY EFFICIENCY IN BUILDINGS

## INTRODUCTION

Optimising the energy efficiency in a building is a far more cost effective measure to reduce carbon emissions than by using renewable energy. Unfortunately, there is no magic silver bullet when it comes to energy efficiency in office buildings for the Malaysian climate. In other words, there does not exist one single item which can reduce building energy consumption by 50% or more. Energy efficiency in office buildings in this climate has to be addressed holistically by addressing every available opportunity.

The typical energy breakdown in Malaysian office buildings is 50% for air-conditioning, 25% for electrical lighting and 25% for small power (equipment). In addition, air-conditioning energy consumption is not only due to heat from solar gain in the building, but also due to heat from electrical lighting, electrical equipment, conduction (through the building fabric), the provision of fresh air in the building and human occupancy. Each of these items contribute a significant part to the

air-conditioning energy used. Unless air-conditioning is not used at all, it is not possible to reduce the energy consumption in a building by 50% or more by addressing only one item alone. Refer to **Chart 1.1** for a better understanding.

**It is not possible to reduce the energy consumption in a building by 50% or more by addressing only one item alone**

Due to the rapid technological advancements in Malaysia in electrical lighting, air-conditioning and the availability of cheap energy from the mid-20th century onwards, unhealthy energy efficiency design practices in has crept into building design and operation. Today, one can easily identify hundreds, if not thousands, of items in building design and construction that can

be made better to help improve the energy efficiency in buildings. Nowadays, many building product manufacturers and suppliers are aggressively marketing building materials with claims of improving the energy efficiency in buildings.

With so many options available in the market, it has become quite confusing for building designers. Are all the claims made by suppliers 100% truthful? Is it really possible to save the amount of energy claimed? In addition, due to the complexities of energy efficiency in buildings, it is easy to mislead the market by providing and/or withholding information. One simple example that is often heard in the industry is the 'oversell' of reducing solar heat gain in buildings. While it is true that the reduction of solar gain in a building plays a very important part in the building's energy efficiency, claims of a 50% reduction in solar gain in buildings (which can be easily done, read Chapters 5 and 6), is not the same as a 50% reduction in building energy consumption.

This guideline will attempt to correct the mis-information in the building industry by providing simple and clear advice on the energy efficiency impact of typical design options already practiced by many architects and engineers in Malaysia. The design options provided in this guideline are not new to architects and engineers, but an attempt is made to provide a general guide on the real and quantifiable benefits of these design options. With the provision of quantifiable benefits, it is hoped that architects and engineers will be able to make building energy efficiency decisions quickly, if not instantly, on a majority of energy efficiency design issues.

In addition, this guideline will show that the combination of many good design practices in energy efficiency will yield much greater energy savings than by addressing only one or two energy efficiency features in a building.

It is also very important to understand that if 50 energy efficient features are implemented in a building, even a 1% efficiency gain per feature will yield a total of 50% energy savings for the building. In addition, if more than 50 items are addressed, the inability to meet one item alone will not destroy the entire energy efficiency of a building. For example, it is not disastrous if the site does not allow

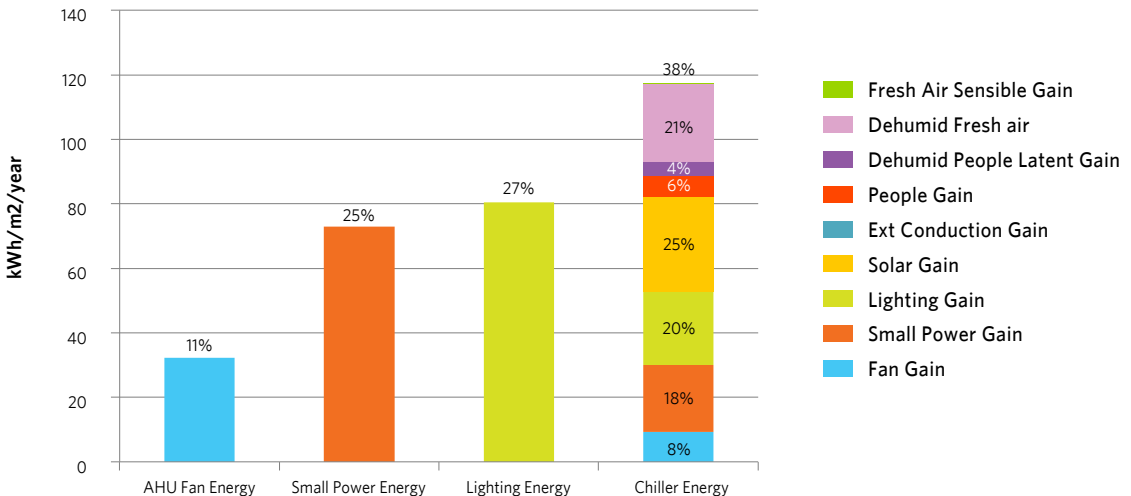
for good orientation of the building because it is still possible to make improvements on many other energy efficiency features to compensate for this loss of efficiency. It is only disastrous when a majority of opportunities to improve the energy efficiency in the building are totally ignored.

This chapter also provides a quick introduction to the fundamental science related to energy efficiency in buildings. Understanding the fundamental physics is an important part of designing buildings that use building science to cool the building naturally before an active system is employed.

## A HOLISTIC APPROACH

A study on the reformulation of the Malaysian Standard (MS) 1525, Overall Thermal Transfer Value (OTTV) in 2005 by Danida, produced a simple chart on the energy breakdown in typical buildings. This chart is important in this section because it provides a clear understanding of the typical energy distribution in typical office buildings in Malaysia. This chart then allows a clear strategy to be developed to address the energy efficiency priorities in buildings.

**CHART 1.1 | TYPICAL ENERGY BREAKDOWN IN A BUILDING**



A chiller system is used to remove heat from a building to maintain it at a certain temperature for occupant comfort. Heat in a building is generated from solar radiation, conduction, people, fresh air intake, electrical lights, electrical fans and electrical equipment. The amount of heat generated by each element may be marginally different between buildings but will not significant enough to change the conclusion of the study made in 2005.

The chiller energy breakdown in **Chart 1.1** shows the following heat elements that are removed by the air-conditioning system to provide comfortable conditions in the building:

- 1 Fan Gain**  
 The 1<sup>st</sup> law of thermodynamics states that all electrical energy used by the motor to drive the fan would end up as heat within the building.
- 2 Small Power Gain**  
 All electrical equipment that is plugged into a power point constitute small power energy use. The 1<sup>st</sup> law of thermodynamics states that all electrical energy used by electrical equipment will end up as heat in the air-conditioned space.
- 3 Lighting Gain**  
 The 1<sup>st</sup> law of thermodynamics also states that all electrical energy used by the lighting system would end up as heat within the building.
- 4 Solar Radiation Gain**  
 The heat gain due to solar radiation through the building windows is known as Solar Radiation Sensible Heat Gain.
- 5 Conduction Gain Due to Building Fabric**  
 The difference in temperature between the outdoor space and the indoor space will cause conduction heat gain through the building fabric.
- 6 People Sensible Gain**  
 The sensible heat gain from people is the heat emitted by people in air-conditioned spaces.
- 7 Dehumidification of People Latent Gain**  
 The latent heat gain from people is the moisture emitted by people in air-conditioned spaces.
- 8 Dehumidification of Fresh Air Ventilation**  
 The mechanical ventilation and infiltration (air leakage) of fresh air (outside air) into air-conditioned spaces brings along the moisture content of the fresh air.
- 9 Fresh Air Ventilation Sensible Gain**  
 The infiltration of fresh air (outside air) into air-conditioned spaces brings along the heat content of the fresh air.

Depending on the cooling load, a typical chiller system may consist of a chiller, chilled water pump, condenser water pump and cooling tower or just a simple air-cooled compressor unit placed outdoors (as in a split unit air-conditioning system). The efficiency of the chiller system can vary significantly depending on the combination of equipment selected by the air-conditioning system designer based on the available budget and design concept.

Based on **Chart 1.1**, it can be summarised that energy efficiency in buildings should be prioritised according to these seven (7) fundamental steps:

### 1 Chiller System Efficiency

A high-efficiency chiller system will reduce the total energy use within a building significantly because less electrical energy is used to remove the same amount of heat from the building. The term 'chiller system' would typically consist of the chiller (also known as the compressor), chilled water and condenser water pumps and cooling tower fans. The entire chiller system including the chillers, pumps and fans should be optimised for energy efficiency. A technical guideline on optimising the chiller system efficiency will be produced as Part 2 of the BSEEP project.

### 2 Lighting Efficiency

Natural daylight harvesting is the most efficient method because it provides light with the least amount of heat. Other options for lighting efficiency include the use energy efficient lighting systems, proper zoning of lighting circuits, etc.

### 3 Reduce Small Power Load

Reduction of small power load in office buildings can be achieved by the selection of energy efficient computers, servers, and control systems. In addition, night time energy consumption of small power should also be closely monitored to ensure that energy is only used where needed. A very large part of the responsibility to ensure a low small power load in a building rests on the occupants of the building. Therefore, awareness of energy efficient small power equipment should be provided to existing and potential occupants of an energy efficient building.

### 4 Fan Efficiency

The fan described here is used by the air-conditioning system to deliver cool air to a space. The energy used by the fan is the combination of two factors – total efficiency and total pressure loss. The efficiency of the fan and motor is largely a selection choice, while the total pressure loss in a fan system is a factor of duct size, duct distance, cooling coil pressure losses and air filtration system pressure losses.

### 5 Control of Fresh Air Intake and Infiltration

Fresh air is required to be provided in buildings. However, too often, the amount of fresh air that is provided in Malaysian buildings far exceeds the recommended minimum fresh air requirements by the Malaysian Uniform Building By Law (UBBL) and Ashrae 62.1 (2007). This is largely caused by uncontrolled fresh air intake by the mechanical system and the infiltration of air into the building. Since Malaysia has a hot and humid climate, the fresh air provided causes a high latent (moisture) load for the air-conditioning system. The mechanical fresh air intake system can be controlled using a CO<sub>2</sub> sensor, while building infiltration can be addressed using good construction practices for an air-tight building. More information can be found in Chapter 10.

### 6 Control of Solar Heat Gain

The control of solar heat gain is a combination of building orientation, exterior shading devices, glazing properties and interior shading devices. Chapters 3, 5 and 6 address these items.

### 7 Insulation of Building Fabric

The climate in Malaysia is rather moderate, therefore, insulation of the building fabric in this climate need not be excessively provided. The optimal roof and wall insulation is addressed in Chapters 7 and 8.

**All seven (7) fundamental steps mentioned above need to be addressed in order to design a building that is energy efficient. The options to address each of these fundamental steps is almost limitless. It is really up to the designers' creativity to address each fundamental step in ways that are most suited to the building aesthetics, site and budget requirements.**

# 1<sup>ST</sup> LAW OF THERMODYNAMICS

A basic understanding of the 1<sup>st</sup> Law of Thermodynamics is essential to understand energy flow in buildings

Energy exists in many forms, such as heat, light, chemical, kinetic (mechanical) and electrical energy. The 1<sup>st</sup> law of thermodynamics states the law of conservation of energy. **Energy can be changed from one form into another, but it cannot be created or destroyed.**

However, it is known that there exists many skeptics (trained engineers included) that would disagree with this law. Skeptics would often make claims of a perpetual machine with the ability to produce more energy than consumed. Unfortunately, according to the 1<sup>st</sup> law of thermodynamics, this type of machine cannot be made to work, although there are still many believers that it is possible to bend the 1<sup>st</sup> law of thermodynamics.

Energy can be changed from one form into another, but it cannot be created or destroyed.

The full statement of the 1<sup>st</sup> law of thermodynamics was first made in the 1850s and until today, it has **NEVER EVER** been proven wrong. Moreover it has been proven again and again that this law is not only applicable to building science, but it is applicable for the entire universe; from a molecular level to the entire universe of galaxies, planets and stars. Until today, there has been no equipment or event that has managed to disprove the 1<sup>st</sup> law of thermodynamics.

The full statement of the 1<sup>st</sup> law of thermodynamics was first made in the 1850s and until today, it has **NEVER EVER** been proven wrong

As building designers, you have to place your absolute confidence in this law until someone, somewhere, manages to prove otherwise. More importantly, if ever someone managed to prove this law wrong, it would be such a big event in this world that it cannot be ignored by anyone. Everyone would know about it because it would then be possible to invent a perpetual energy machine and you do not have to be concerned about energy efficiency anymore! So until this can become a reality (if ever), building designers are required to work within the limits of the 1<sup>st</sup> law of thermodynamics.

The key reason why the 1<sup>st</sup> law of thermodynamics is mentioned in this chapter is to dispel a few building industry myths that hinder the understanding energy flow in buildings. These are some of the common myths in the industry:

1

### Only a fraction of the electrical lighting energy used ends up as heat in the building

**MYTH – A 100 watt light bulb only produces 50 watts of heat in the building**

**TRUTH – A 100 watt light bulb produces 100 watts of heat in the building**

Depending on the efficiency of the light bulb, a part of the electrical energy is converted into light energy, while the rest of it is immediately converted into heat energy. The light energy is then absorbed and reflected by its surroundings (depending on its colour) until it is fully absorbed by the building furniture and materials. The absorbed light energy is then converted into heat energy in these building materials. That is why a dark coloured material is always warmer than a light coloured material when it is exposed to light energy. Basically dark coloured materials absorb more light energy than light colours. This heat is then removed by the air-conditioning system.

The only situation where this myth may have some truth is when the light is directed out of the building. In this situation, part of the light energy produced by the lamp ends up outside the building and would not contribute 100% of the electricity used as heat within the building.

2

### Only a fraction of the fan motor energy used ends up as heat in the building

**MYTH – A 100 watt fan motor with 70% efficiency only produces 30 watts of heat in the building**

**TRUTH – A 100 watt fan motor of any efficiency produces 100 watts of heat in the building**

It is true that with a fan motor efficiency of 70%, 30% of heat is immediately produced by the frictional losses in the motor and fan rotation while only 70% of the electrical energy used is converted into kinetic energy to move the air. The question is, what happens next to this kinetic energy? The 1<sup>st</sup> law of thermodynamics states that energy cannot be destroyed, so where would this energy end up? It will end up as heat. Frictional losses will convert all the kinetic energy in the air into heat. Frictional losses in the ducts, air filters, cooling coils and as the air flows across the office furniture and building occupants, all the kinetic energy in the air will eventually be converted into heat in the building.

Again, it is possible for this myth to have some truth. It is when the fan blows air directly out of the building. In this situation, the electrical energy used by the fan motor ends up outside the building and would not contribute to heat within the building.

3

### All the electrical energy used by a pump ends up as heat in the pump room

**MYTH – A 100 watt pump motor with 60% efficiency produces 100 watts of heat in the pump room**

**TRUTH – 40 watts will end up as heat in the pump room**

The other 60 watts will heat up the water in the pipes and stored as potential energy if the water is pumped up to height. A pump motor with a 60% efficiency means that it can convert 60% of the electrical energy into the kinetic energy to move the water. Again, the 1<sup>st</sup> law of thermodynamics states that energy cannot be destroyed, so where would the kinetic energy end up? Part of it may end up as potential energy if it lifts the water up to a higher point, and the rest will end up as heat in the water. Frictional losses in the pipes will convert all the kinetic energy in the water into heat. Therefore, the water will heat up due to the energy transferred from the pump into the water.

In summary, **energy changes form but it cannot be destroyed**. By having a clear understanding of energy flow, one can start to appreciate how energy changes within the building and how improvements made in one area has a cascading effect on the entire building. **Simply put, almost all electrical energy used within the building ends up as heat which the air-conditioning system has to remove in order to keep the building conditions comfortable for the occupants.**

# FUNDAMENTALS OF AIR PROPERTIES

The properties of the air are defined with a minimum of two known parameters, such as:

- **Dry Bulb Temperature and Wet Bulb Temperature**
- **Dry Bulb Temperature and Relative Humidity**
- **Dry Bulb Temperature and Moisture Content**

Having any two known properties as defined above, it is possible to find out all other properties of the air. For example, if we know the Dry Bulb Temperature and Relative Humidity, using a psychrometric diagram or Mollier chart, we can find out the Wet Bulb Temperature, Moisture Content in the air and the Dew Point Temperature of the air.

## 1 Dry Bulb Temperature (°C)

The Dry Bulb Temperature is typically referred to as the air temperature. It is called “Dry Bulb” because the air temperature is as indicated by a thermometer exposed to air flow but shaded from the sun and radiation, as opposed to the “Wet Bulb” temperature where the thermometer is wrapped in permanently wet muslin.

## 2 Wet Bulb Temperature (°C)

The Wet Bulb Temperature is the temperature of adiabatic saturation. This is the temperature indicated by a moistened thermometer bulb exposed to the air flow. The evaporation of water from the thermometer and the cooling effect is indicated by the “Wet Bulb Temperature”. The Wet Bulb Temperature is always lower than the Dry Bulb Temperature but will be identical at 100% Relative Humidity. The Wet Bulb Temperature is an indication of the lowest Dry Bulb Temperature that can be achieved when the air is 100% saturated (e.g. the use of an evaporative cooler).

## 3 Dew Point Temperature (°C)

The Dew Point is the temperature at which water vapour starts to condense out of the air (the temperature at which air becomes completely saturated). Above this temperature, the moisture will stay in the air and will not condensate. If condensation is found on the surface of any object, it means that the surface temperature of the object is below the Dew Point Temperature of the air.

A good example of natural condensation of water in our climate is on vehicles parked outdoors throughout the night. The colder night sky cools the vehicles’ surfaces (via radiation) to below the Dew Point Temperature of the air, allowing condensate to form on the surface of the vehicles in the early morning hours.

## 4 Moisture Content In Air (kg/kg)

There is always water vapour in the air. A useful way to define the amount of water in the air is by using the “Moisture Content” measured as in kg (or grams) of water in 1 kg of air. In the Malaysian climate, the outdoor air moisture content is fairly consistent, day or night and throughout the year, ranging from 18 to 20 grams of water in 1 kg of air. Unfortunately, human beings are not sensitive enough to “feel” the moisture content in the air, but we are able to feel the “Relative Humidity” in the air. Moisture Content in the air also commonly known as “Humidity Ratio”.

## 5 Relative Humidity (%)

Relative Humidity is a measure of the amount of water (moisture) in the air compared to the maximum amount of water the air can absorb, expressed as a percentage. When the air cannot absorb any more moisture (is fully saturated), its Relative Humidity is 100 percent. The higher the air temperature, the more moisture it can absorb, which is why a laundry dryer uses high temperatures to extract water out from wet laundry. This also means that the Relative Humidity is a factor of the Dry Bulb Air Temperature and Moisture Content. A Relative Humidity of 50% in an air-conditioned room at 23°C will have a Moisture Content of approximately 11g/kg, while the same 50% Relative Humidity outdoors at an air temperature of 35°C will have a Moisture Content of approximately 20g/kg.

## 6 Effective Sky Temperature (°C)

The Effective Sky Temperature is the temperature of the sky as seen by objects on the ground, accounting for all the gas molecules and suspended particles in the atmosphere that emit and absorb radiation. In fact, outer space is a “perfect black body” at 0° Kelvin (-273.15°C). On a cloudless night, the Effective Sky Temperature is lower than the ambient temperature, but it will not be 0°K due to the atmosphere.

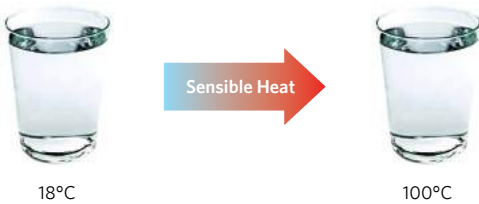
# FUNDAMENTALS OF HEAT

Heat is actually a form of energy. With the right mechanism, heat can be converted into other forms of energy such as kinetic or electrical energy. Heat is also a form of energy that can easily be stored in building materials with a high thermal capacity such as water, bricks and stones.

There are two distinct types of heat: **Sensible Heat** and **Latent Heat**.

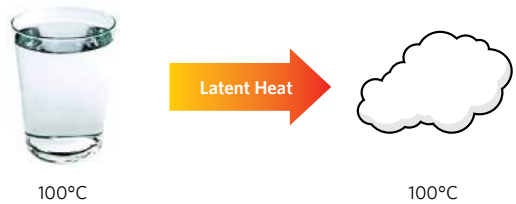
## SENSIBLE HEAT

Sensible Heat is heat energy that causes a change in temperature in an object. In building science, any object that causes a temperature increase is called Sensible Heat. These objects include computers, printers, lighting, solar radiation through windows, etc.



## LATENT HEAT

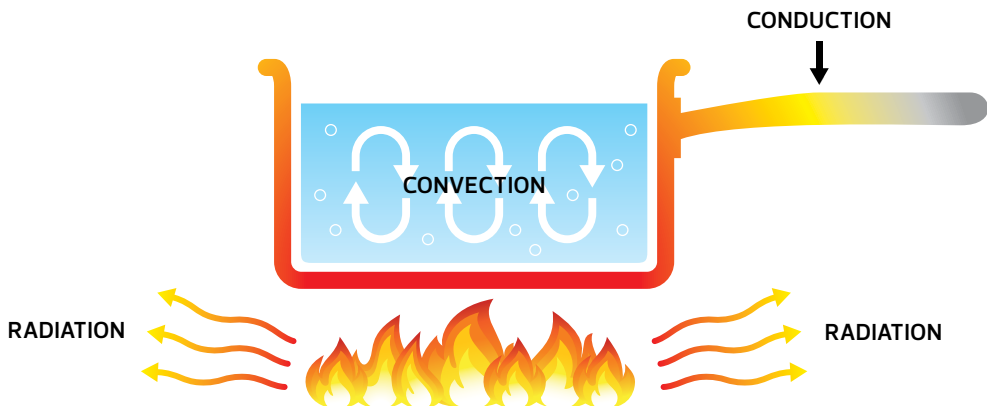
Latent Heat is heat energy that causes the change of phase of a substance from one state to another without affecting the temperature. For example, water remains at 100°C while boiling. The heat added to keep the water boiling is Latent Heat. The quantity of heat that is added to the water in order for it to evaporate cannot be displayed by an ordinary thermometer. This is because both the water and steam remain at the same temperature during this phase change.



In tropical climate building science, Latent Heat represents moisture in the air that needs to be dehumidified by an air-conditioning system. Typical air-conditioning systems remove moisture from the air by providing surfaces on a cooling coil that is below the Dew Point Temperature of the air. As water condensates on this cooling coil, heat is removed from the moisture in the air and transferred into the cooling coil.

# FUNDAMENTALS OF HEAT TRANSFER

DIAGRAM 1.1





Heat transfer is classified into four mechanisms:

1. Conduction
2. Convection
3. Radiation
4. Phase change (evaporation/condensation)

**1 Conduction (Sensible Heat)**

Conduction is the transfer of heat when adjacent atoms vibrate against one another and those with greater molecular kinetic energy pass their thermal energy to regions with less molecular energy through direct molecular contact. The better the conductor, the more rapidly heat will transfer.

In building science, conduction heat transfer is represented by the U-value of building materials. A high U-value indicates high conduction ability. A low U-value indicates low conduction ability. The inverse of the U-value is the R-value (Resistivity Value), where a higher R-value indicates a low conduction ability (or high resistance). Both the U-value and R-value are computed from the K-value (conductivity value) and the thickness of the building material. The K-value is a measure of the heat transfer rate per meter thickness of a building material.

**2 Convection (Sensible Heat)**

Convection is heat transfer from one place to another by the movement of air or water. The heated water rises and is replaced by the colder water, hence it will move away from the source of heat. In building science, the convection heat transfer is normally assumed as a constant number that is directly proportional to the air speed. A higher air speed will cause higher convection heat to be transferred.

**3 Radiation (Sensible Heat)**

Radiation is often the least understood heat transfer mechanism. Radiation is heat transfer by emission of electromagnetic waves through space. As long as two objects of different temperatures can “see” each other, radiation heat transfer will occur, regardless if it is an air space or vacuum space between these two objects.

In building science, radiation is an important component of heat transfer because any object (wall, window, roof, computer screen, oven, etc.) that is hot will radiate heat to a cooler object such as a building occupant, causing thermal discomfort.

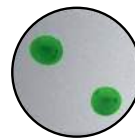
The efficiency of radiation heat transfer is determined by a material property called emissivity. Most objects have an emissivity close to 1.0 meaning that

Heat transfer is always from a hotter (higher) temperature object to the colder (lower) temperature object

close to 100% of the heat of the object is radiated to cooler objects surrounding it. There exists low-emissivity materials such as aluminium foil that have an emissivity of 0.05 or lower. Although these low-emissivity materials may be hot, only 5% or less of the heat is radiated to cooler objects surrounding it.

**4 Condensation/Evaporation (Latent Heat)**

Condensation is the change from a vapour to a condensed state (solid or liquid), while Evaporation is the change of a liquid into a gas.



MICROSCOPIC VIEW OF A GAS

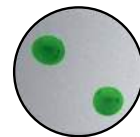


MICROSCOPIC VIEW AFTER CONDENSATION

When a gas is sufficiently cooled or the pressure on the gas increases, the forces of attraction between molecules prevent them from moving apart, and the gas condenses to either a liquid or a solid. An example of condensation is when water vapour condenses and forms liquid water on the outside of a cold glass.



MICROSCOPIC VIEW OF A LIQUID



MICROSCOPIC VIEW AFTER EVAPORATION

When a liquid is sufficiently heated or the pressure on the liquid is decreased sufficiently, the forces of attraction between the molecules are weakened and the liquid would evaporate into a gas. An example is the condensate water on the outside of a cold glass evaporating when the glass warms.

In building science, evaporative cooling is often used in this climate as a method of lowering the air temperature by humidifying the air. As water evaporates, it absorbs heat from the air, cooling the air.

# FUNDAMENTALS OF THERMAL COMFORT

There have been many studies linking thermal comfort to productivity in offices.<sup>1</sup> More importantly, compared to the cost of salary for building occupants, the energy cost in a building is almost insignificant; making it almost impossible to justify energy efficiency in a building that reduces building occupant productivity.<sup>2</sup> Therefore, thermal comfort in a building has a higher priority than energy efficiency in building. Fortunately, when energy efficiency is implemented well in a building, the thermal comfort would be improved as well.

Within building science, thermal comfort is defined as a heat transfer balance between a person with his/her surroundings. In many literatures, thermal comfort is also defined as a condition of mind which expresses thermal satisfaction within the environment. Because there are large variations, both physiologically and psychologically, from person to person, it is not possible to satisfy everyone in a space with the same conditions. Many thermal comfort models recommend satisfying a minimum of 80% to 90% of the occupants as the minimum criteria for thermal comfort.

Although there are many thermal comfort models available in the market today; it is recommended to gain a basic understanding of the three (3) thermal comfort models that are described in this chapter as a foundation.

These three (3) basic thermal comfort models are:

1. Operative Temperature
2. Fanger's PMV-PPD Comfort Model (for Conditioned spaces)
3. Thermal Adaptive Comfort (for Natural and Hybrid Ventilation spaces)

The above 3 thermal comfort models are internationally recognised by both ASHRAE and ISO standards.

Within building science, thermal comfort is defined as a heat transfer balance between a person with his/her surroundings

## 1 OPERATIVE TEMPERATURE

The Operative Temperature is perhaps the simplest and most useful indicator of thermal comfort in buildings.

Operative Temperature describes the average of Air Temperature and Mean Radiant Temperature. While Air Temperature is simply the temperature of the air, the Mean Radiant Temperature is more complicated; it is the average surface temperature of the surrounding walls, windows, roof and floor. Hot equipment like ovens and halogen lights also add to the Mean Radiant Temperature of a space. In addition, the view factor (percentage of exposure) of each surface also contribute to the final Mean Radiant Temperature of a space.

In a typical conditioned space in Malaysia where the relative humidity ranges from 50% to 65%, the Operative Temperature is recommended to be maintained below 25°C to provide comfortable thermal conditions. This means that if the Air Temperature is set to 23°C, the maximum allowable Mean Radiant Temperature is 27°C in order to obtain an Operative Temperature of 25°C.

This also means that if a room's Mean Radiant Temperature is more than 28°C, the Air Temperature of the room needs to be lower than 22°C to provide comfort to the building occupants. **Table 1.1** on the next page shows the various Air Temperatures in combination with the Mean Radiant Temperatures to provide the same comfort condition.

<sup>1</sup> D.P. Wyon, Indoor environmental effects on productivity. IAQ 96 Paths to better building environments/Keynote address, Y. Kevin. Atlanta, ASHRAE, 1996, pp. 5-15.

<sup>2</sup> R. Kosonen, F.Tan, Assessment of productivity loss in air-conditioned buildings using PMV index. Halton OY, CapitaLand Commercial Limited, 2004.

In the Malaysian climate, it is possible to provide adequate insulation to external walls, windows or roofs to reduce the Mean Radiant Temperature in the building to match the Air Temperature of the space. However, it is not possible to reduce it below the Air Temperature using insulation alone. Active cooling technologies are required to reduce the Mean Radiant Temperature below the Air Temperature. Active surface cooling technologies are also known as Radiant Cooling Systems, including technologies such as chilled floor slabs, chilled beams, chilled ceilings, etc.

The Operative Temperature is a better indicator of thermal comfort than Air Temperature alone because both the Air Temperature and the Mean Radiant Temperature have an equal influence on the thermal comfort of a person.

**TABLE 1.1 | AIR TEMPERATURE, MEAN RADIANT TEMPERATURE AND OPERATIVE TEMPERATURE**

Air Temperature (°C)	Mean Radiant Temperature (°C)	Operative Temperature (°C)
22	28	25
23	27	25
24	26	25
25	25	25
26	24	25
27	23	25
28	22	25

## 2 FANGER'S PMV-PPD THERMAL COMFORT MODEL

The Fanger's PMV-PPD thermal comfort model states that thermal comfort is a balance of heat transfer between a person with his/her surroundings. This model has identified six (6) primary factors that must be addressed when defining conditions for thermal comfort.

The six primary factors are:

1. Metabolic Rate
2. Clothing Insulation
3. Air Temperature
4. Mean Radiant Temperature
5. Air Speed
6. Relative Humidity

All six of these factors may vary with time. However, this standard only addresses thermal comfort in a steady state. As a result, people entering a space that meet the requirements of this standard may not immediately find the conditions comfortable if they have experienced different environmental conditions just prior to entering the space. The effect of prior exposure or activity may affect comfort perceptions for approximately one hour.

Fanger's PMV-PPD comfort model provides a set of equations to compute two (2) factors:

1. Predicted Mean Vote (PMV)
2. Predicted Percentage Dissatisfied (PPD)

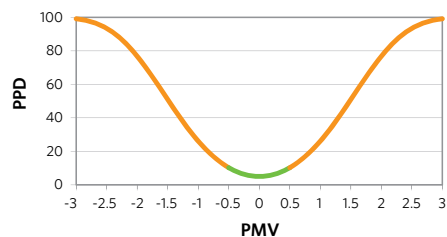
### 1 Predicted Mean Vote (PMV)

The PMV index predicts the mean response of a larger group of people according to the ASHRAE thermal sensation scale of -3 to +3 where 0 is neutral.

-3	-2	-1	0	+1	+2	+3
cold	cool	slightly cool	neutral	slightly warm	warm	hot

### 2 Predicted Percentage Dissatisfied (PPD)

The PPD predicts the percentage of people that will be thermally dissatisfied. The PPD curve is based on the PMV as provided below.



The ISO 7730 on thermal comfort recommends that the PPD should not be higher than 10%, while Ashrae 55 recommends that the PPD should not be higher than 20%. There are many free softwares available on the internet to calculate the PMV and PPD.

### 3 ADAPTIVE THERMAL COMFORT MODEL

While the Fanger’s PMV-PPD is well accepted for conditioned spaces, many published papers suggest other thermal comfort models should be used for naturally ventilated spaces.<sup>34</sup> The adaptive thermal comfort model in Ashrae 55 was provided to address this.

The adaptive model states that people in general are naturally adaptable. They will make various adjustments to themselves and their surroundings to reduce discomfort and physiological stress. Typical actions taken in a warm climate like Malaysia includes alteration of clothing (no jacket), diet (consuming cold drinks), ventilation (opening/closing windows) and air movement (switching on the fan). It was presented that due to these adaptive actions taken, people would be able adapt to a comfort condition that is close to the average air temperature.

The thermal adaptive model suggests the following equation to predict the thermal comfort requirement:

$$T_{oc} = 18.9 + 0.255 T_{out}$$

Where:

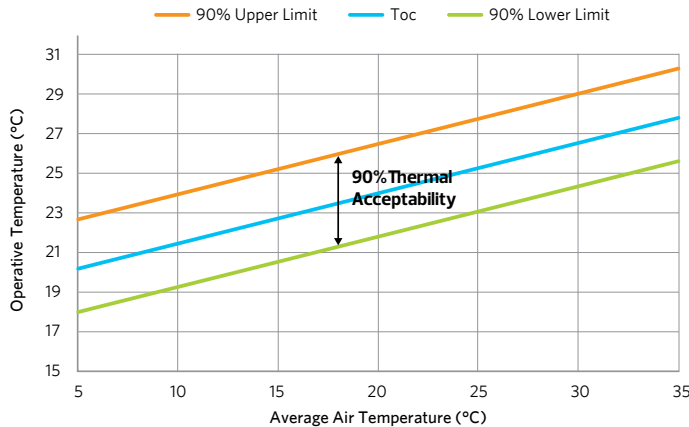
$T_{oc}$  is the operative comfort temperature (°C)

$T_{out}$  is the outdoor average day and night temperature (°C)

The boundary temperatures for a 90% thermal acceptability are approximately  $T_{oc} + 2.5^{\circ}\text{C}$  and  $T_{oc} - 2.2^{\circ}\text{C}$ .

For the Malaysian climate where the annual average temperature is  $26.9^{\circ}\text{C}$  (refer to Chapter 2),  $T_{oc} = 25.75^{\circ}\text{C}$ . At 90% thermal acceptability, the upper limit of  $T_{oc} = 25.75^{\circ}\text{C} + 2.5^{\circ}\text{C} = 28.25^{\circ}\text{C}$ .

#### CHART 1.2 | ADAPTIVE THERMAL COMFORT



This comfort model is recommended for natural and hybrid ventilated spaces and states that for the Malaysian climate, it is recommended to maintain the Operative Temperature below  $28.25^{\circ}\text{C}$  for a 90% acceptance.

<sup>3</sup> Deuble, M.P and de Dear, R.J. (2012) Mixed-mode buildings: A double standard in occupants’ comfort expectations’, Building and Environment, Volume 54, Issue 8, Pages 53-60  
<sup>4</sup> Denis J. Bourgeois, 2005, Detailed occupancy prediction, occupancy-sensing control and advanced behavioural modelling within whole-building energy simulation, Chapter 6, Thermal adaptation: applying the theory to hybrid environments

### SUMMARY

In a conditioned space, it is recommended to use Fanger’s PMV-PPD thermal comfort model to predict the comfort condition. Alternatively, the design operative temperature of not more than  $25^{\circ}\text{C}$  is suggested as the simplest design indicator of thermal comfort in conditioned spaces in this climate zone. However, for a naturally ventilated space, the Adaptive Thermal Comfort model is recommended to be used instead of Fanger’s PMV-PPD model. In this climate zone the Adaptive Thermal Comfort model states that we should maintain operative temperature below  $28^{\circ}\text{C}$  for a 90% acceptance of the comfort level provided.

CHAPTER

# 2

## MALAYSIA'S WEATHER DATA





## 2

MALAYSIA'S  
WEATHER DATA

## INTRODUCTION

**A clear understanding of Malaysia's weather data enables designers to design buildings that benefit from the climate conditions**

The daily climate in Malaysia is fairly consistent throughout the entire year; therefore it is useful to have an overview of an average day's patterns and the maximum and minimum hourly weather values for a full year. This chapter provides information on dry bulb temperature, wet bulb temperature, relative humidity, humidity ratio (moisture content), dew point temperature, global radiation, direct radiation, diffuse radiation, cloud cover, wind speed & direction, effective sky temperature and ground temperature. Charts are provided to make it easier to understand the data and a table of raw cross tabulation data made using the pivot table function in Excel is also provided for users who wish to make use of this data for more in-depth analysis on their own.

## SOURCE OF WEATHER DATA

The hourly weather data of Kuala Lumpur used in this chapter was based on a Test Reference Year (TRY)<sup>1</sup> weather data developed in University Teknologi Malaysia (UiTM) under the DANCED (Danish International Assistant) project for Energy Simulations for Buildings in Malaysia. The TRY is based on 21 years (1975 to 1995) of weather data from the Malaysian Meteorological Station in Subang, Klang Valley, Selangor. The hourly weather data that was obtained from this station is as shown in **Table 2.1** below.

**TABLE 2.1 | WEATHER DATA COLLECTED IN SUBANG**

Subang Meteorological Station (Klang Valley, Selangor, Malaysia) Longitude: 101deg 33' Latitude: 3deg 7'	
Parameters (hourly <sup>2</sup> )	Units
Cloud Cover	[oktas]
Dry Bulb Temperature	[°C]
Wet Bulb Temperature	[°C]
Relative Humidity	[%]
Global Solar Radiation	[100*MJ/m <sup>2</sup> ]
Sunshine Hours	[hours]
Wind Direction	[deg.]
Wind Speed	[m/s]

A Test Reference Year (TRY) consists of weather data for a given location. In order for the TRY to be representative of the climate, it was constructed on the basis of at least 10 years of weather data. The TRY is made up from actual monthly data (not average values) that are picked after having been subjected to different types of analysis.

It should be noted that a typical energy simulation program requires two extra data values that were not collected by the Malaysian Meteorological Service, namely the direct and diffuse radiation. The missing radiation data was calculated for the TRY via Erbs' Estimation Model from the horizontal global solar radiation.

Although not perfect, the TRY is currently the only known set of weather data for energy simulation that was compiled based on statistical analysis and it has been used in many energy simulations of various buildings in Malaysia with satisfactory results. This weather data was also used for the development of the constants in the Overall Thermal Transmission Value (OTTV) equation found in the Malaysia Standard (MS) 1525 (2007), Energy Efficiency in Non-Residential Buildings.

<sup>1</sup> Reimann, G. (2000) Energy Simulations for Buildings in Malaysia, Test Reference Year, 18-25.  
<sup>2</sup> The values are integrated over a period of one hour, but the exact time interval has not been specified.

# LOCATION AND SUN-PATH

The global position and solar noon of six (6) cities in Malaysia is provided in **Table 2.2** below.

**TABLE 2.2 | GLOBAL POSITIONING AND SOLAR NOON OF 6 CITIES IN MALAYSIA**

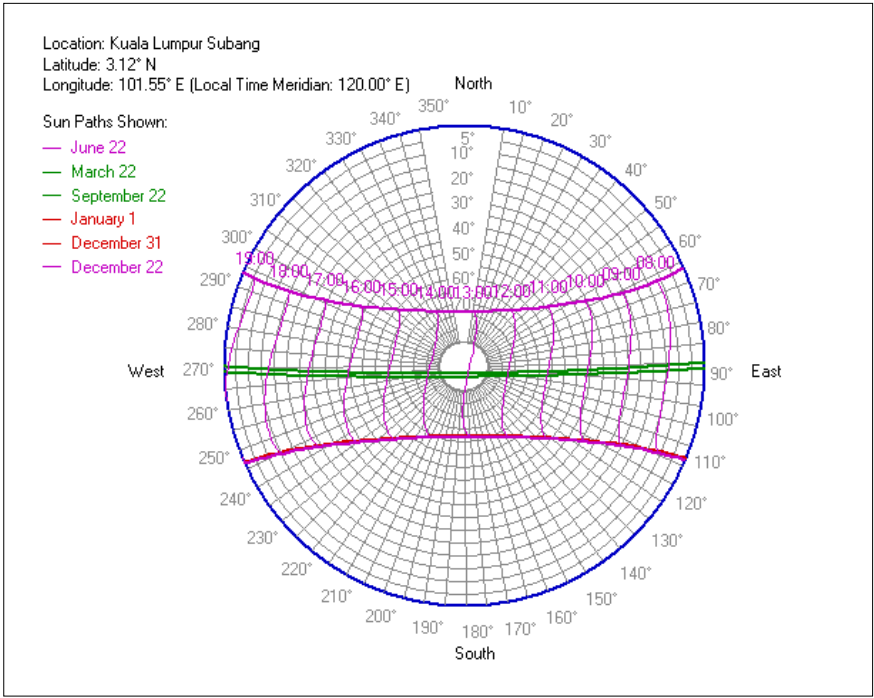
Locations	Latitude (°N)	Longitude (°E)	Solar Noon
1. Kuala Lumpur (Subang)	3.12	101.55	13:11
2. Penang	5.30	100.27	13:16
3. Johor Bharu	1.48	103.73	13:02
4. Kota Bharu	6.17	102.28	13:08
5. Kuching	1.48	110.33	12:36
6. Kota Kinabalu	5.93	116.05	12:13

The sun-path diagram for the 6 locations above is presented in this section and shows that the sun position is almost the same for all six (6) locations, except for the time of the Solar Noon. The Solar Noon (when the sun is at its highest point) is 13:11 in Kuala Lumpur, while in Kota Kinabalu it is about an hour earlier at 12:13.

The sun-path is generally from east-west with the sun approximately 25° to the north during summer solstice and 25° to the south during winter solstice for all locations in Malaysia.

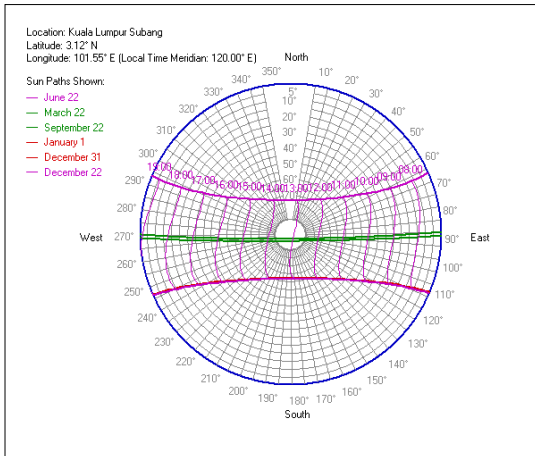
The sun-path diagram is a useful tool to help in the design of external shading devices. The sun-path diagram is used to estimate the sun's angle at various times of the day and year, allowing architects and engineers to design shading devices to block or allow direct sunlight into the building at any time of the day.

**CHART 2.1.1 | LARGE SUN-PATH OF KUALA LUMPUR**

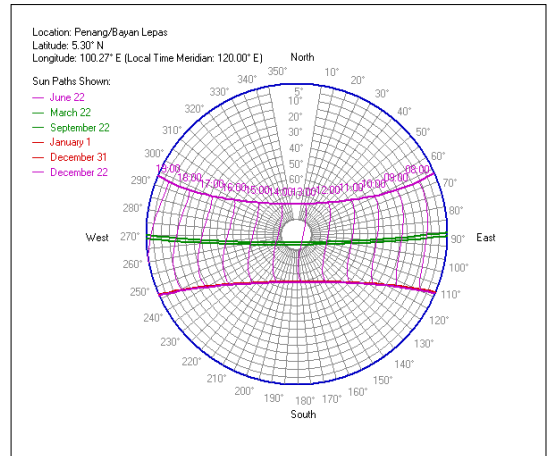




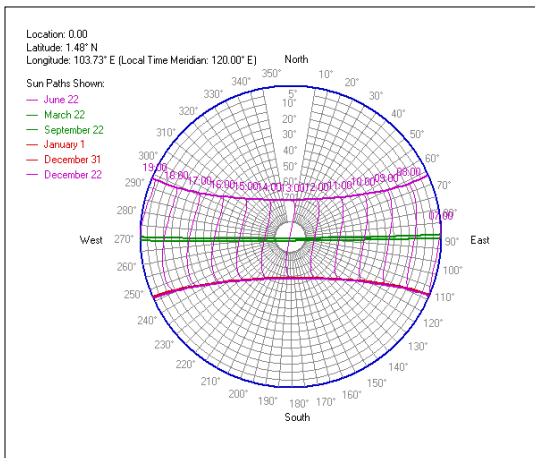
**CHART 2.1.2 | SUN-PATH OF KUALA LUMPUR**



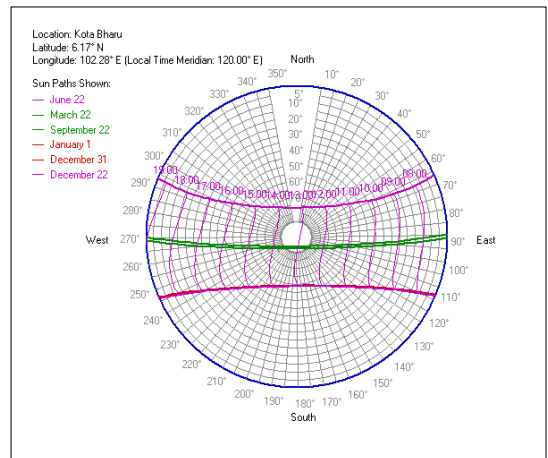
**CHART 2.1.3 | SUN-PATH OF PENANG**



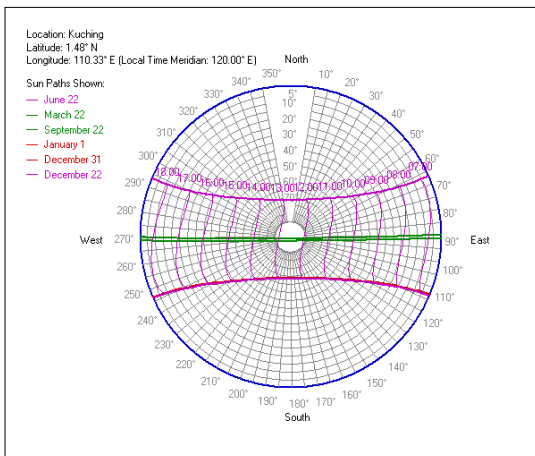
**CHART 2.1.4 | SUN-PATH OF JOHOR BHARU**



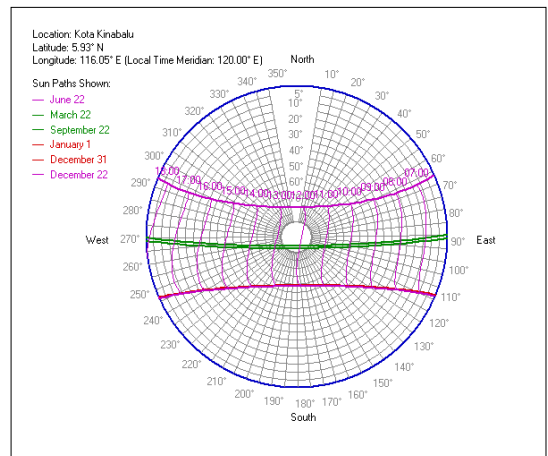
**CHART 2.1.5 | SUN-PATH OF KOTA BHARU**



**CHART 2.1.6 | SUN-PATH OF KUCHING**



**CHART 2.1.7 | SUN-PATH OF KOTA KINABALU**



# DRY BULB TEMPERATURE

The daily average, maximum and minimum dry bulb temperature is shown in the chart in this section. The standard deviation is more than 2°C from 2pm to 6pm indicating that the afternoon hours have a higher change of temperature from day to day; while in the hours of midnight to 7am, the standard deviation of the dry bulb temperature is less than 1°C, indicating a fairly consistent and predictable dry bulb temperature from midnight to the early morning hours.

The average dry bulb temperature of the whole year (including day and night) is 26.9°C.

The average peak dry bulb temperature is just below 32°C between 1pm to 2pm, while the maximum dry bulb temperature of the TRY is 35.6°C at 3pm.

The average low dry bulb temperature is 23.7°C at 6am in the morning; while the lowest dry bulb temperature of the TRY is 20.6°C at 7am in the morning.

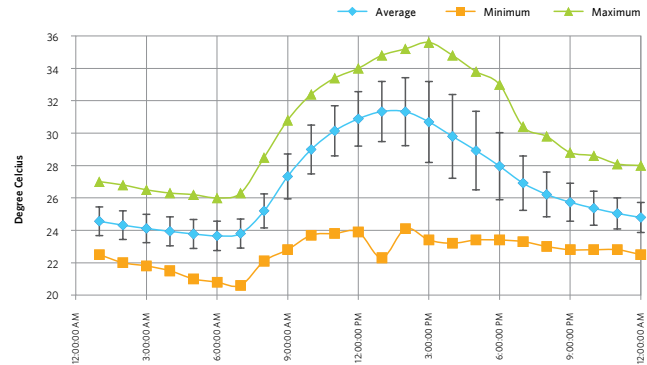
### DESIGN POTENTIAL

The understanding of the dry bulb temperature allows a clear appreciation of when natural ventilation will work and when it is not likely to work. In addition, data centre designers can also make use of this knowledge to provide natural ventilation to the computer servers whenever possible to save a significant amount of air-conditioning energy.

### DESIGN RISK

The TRY is 21 years of weather data in Subang Airport from year 1975 to 1995. During these years, the Subang Airport location was fairly well surrounded by greenery. The peak dry bulb temperature in cities is expected to be higher due to the urban heat island effect.

CHART 2.2 | DRY BULB TEMPERATURE



RAW DATA | DRY BULB TEMPERATURE

Hours	Average	Minimum	Maximum	Std Dev.
1:00:00 AM	24.6	22.5	27.0	0.9
2:00:00 AM	24.3	22.0	26.8	0.9
3:00:00 AM	24.1	21.8	26.5	0.9
4:00:00 AM	23.9	21.5	26.3	0.9
5:00:00 AM	23.8	21.0	26.2	0.9
6:00:00 AM	23.7	20.8	26.0	0.9
7:00:00 AM	23.8	20.6	26.3	0.9
8:00:00 AM	25.2	22.1	28.5	1.1
9:00:00 AM	27.3	22.8	30.8	1.4
10:00:00 AM	29.0	23.7	32.4	1.5
11:00:00 AM	30.1	23.8	33.4	1.5
12:00:00 PM	30.9	23.9	34.0	1.7
1:00:00 PM	31.3	22.3	34.8	1.9
2:00:00 PM	31.3	24.1	35.2	2.1
3:00:00 PM	30.7	23.4	35.6	2.5
4:00:00 PM	29.8	23.2	34.8	2.6
5:00:00 PM	28.9	23.4	33.8	2.4
6:00:00 PM	28.0	23.4	33.0	2.1
7:00:00 PM	26.9	23.3	30.4	1.7
8:00:00 PM	26.2	23.0	29.8	1.4
9:00:00 PM	25.7	22.8	28.8	1.2
10:00:00 PM	25.4	22.8	28.6	1.1
11:00:00 PM	25.0	22.8	28.1	1.0
12:00:00 AM	24.8	22.5	28.0	0.9

# WET BULB TEMPERATURE

The wet bulb temperature is fairly consistent between day and night and throughout the year. The average peak of the wet bulb temperature is 25.4°C at 2pm, while the maximum wet bulb temperature in the TRY is 28.4°C at 2pm.

The average low of the wet bulb temperature is 23.1°C at 6am, and the lowest wet bulb temperature in the TRY is 19.9°C at 7am in the morning.

## DESIGN POTENTIAL

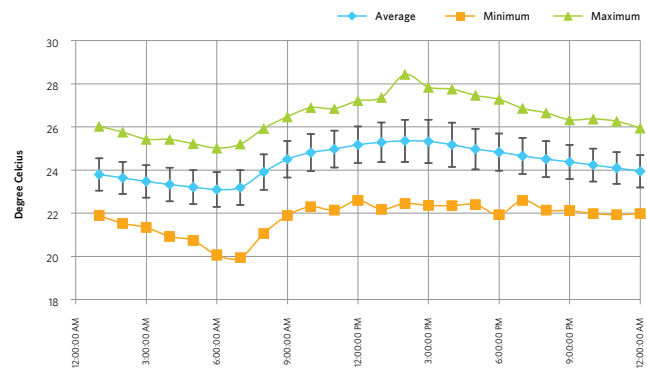
The wet bulb temperature is a good indicator of the potential of a direct evaporative cooling strategy. If the direct evaporative cooling system is 100% efficient, the lowest air temperature that can be achieved by the evaporative cooling system is the wet bulb temperature. The efficiency of direct evaporative cooling devices depends on the system water droplet size, wetted surface area and air speed, and has an efficiency of up to 90%<sup>3</sup>. During the daytime, the dry bulb temperature is significantly higher than the wet bulb temperature; therefore, evaporative cooling will work well. However, during the night time, the dry bulb temperature is very close to the wet bulb temperature, therefore the effectiveness of evaporative cooling is reduced significantly, i.e. the reduction of air temperature is very small with the use of evaporative cooling, even at 90% efficiency.

The wet bulb temperature is also a very important factor for sizing and predicting the performance of a cooling tower. The lower the wet bulb temperature, the better the performance of the cooling tower. Ashrae recommends designing an approach temperature of the cooling tower to be 5.5°C higher than the wet bulb temperature. The lower the condenser water temperature as it exits from the cooling tower, the more efficient it is for the performance of the chiller. Based on the TRY data, it will be best to run the chiller early in the morning, when the wet bulb temperature is the lowest, to gain the maximum efficiency from the chiller. Unfortunately, most buildings are only occupied from 8am onwards and the use of thermal storage solutions will normally introduce further inefficiencies that may negate any efficiency gained by running the chiller system in the early morning hours.

## DESIGN RISK

The wet bulb temperature is not much affected by the urban heat island effect. Therefore, the wet bulb temperature provided by the TRY is reliable to be used.

CHART 2.3 | WET BULB TEMPERATURE



RAW DATA | WET BULB TEMPERATURE

Hours	Average	Minimum	Maximum	Std Dev.
1:00:00 AM	23.8	21.9	26.0	0.7
2:00:00 AM	23.6	21.5	25.8	0.7
3:00:00 AM	23.5	21.3	25.4	0.8
4:00:00 AM	23.3	20.9	25.4	0.8
5:00:00 AM	23.2	20.7	25.2	0.8
6:00:00 AM	23.1	20.1	25.0	0.8
7:00:00 AM	23.2	19.9	25.2	0.8
8:00:00 AM	23.9	21.1	25.9	0.8
9:00:00 AM	24.5	21.9	26.5	0.8
10:00:00 AM	24.8	22.3	26.9	0.9
11:00:00 AM	25.0	22.1	26.9	0.9
12:00:00 PM	25.2	22.6	27.2	0.8
1:00:00 PM	25.3	22.2	27.4	0.9
2:00:00 PM	25.4	22.5	28.4	1.0
3:00:00 PM	25.3	22.4	27.8	1.0
4:00:00 PM	25.2	22.4	27.8	1.0
5:00:00 PM	25.0	22.4	27.5	0.9
6:00:00 PM	24.8	21.9	27.3	0.9
7:00:00 PM	24.7	22.6	26.9	0.8
8:00:00 PM	24.5	22.2	26.7	0.8
9:00:00 PM	24.4	22.1	26.3	0.8
10:00:00 PM	24.2	22.0	26.4	0.8
11:00:00 PM	24.1	21.9	26.3	0.7
12:00:00 AM	23.9	22.0	26.0	0.8

<sup>3</sup> <http://www.wescorhvac.com/Evaporative%20cooling%20white%20paper.htm>

# HUMIDITY RATIO (MOISTURE CONTENT)

The humidity ratio or moisture content of the TRY weather data is fairly consistent throughout the year. The average moisture content in the TRY is 18.3g/kg and is consistent day or night. Day to day fluctuation is highest at 2pm in the afternoon with a peak standard deviation of 1.6g/kg.

### DESIGN POTENTIAL

The humidity ratio gives us information about how much water is in one kilogram of air; therefore, it gives a potential water quantity that can be “squeezed” out from the air. The following known methodologies for “squeezing” water out from the air are:

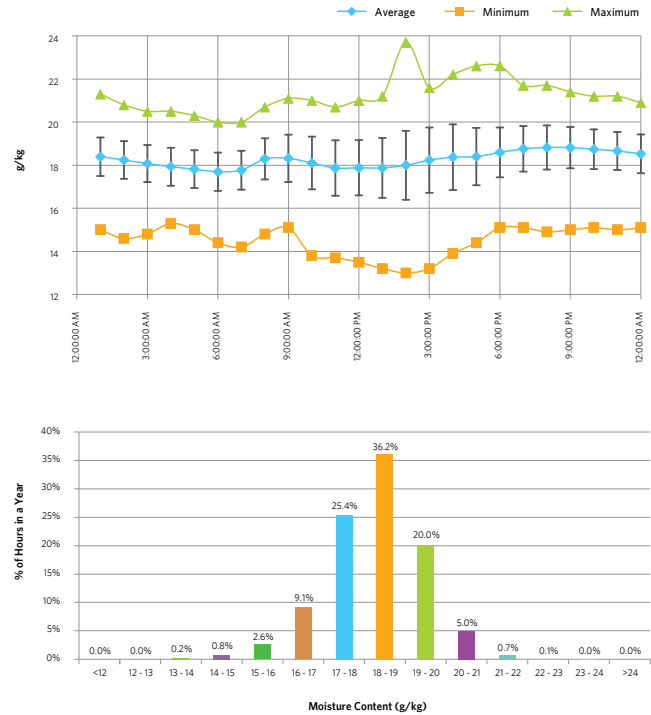
- Cold surfaces that are below the dew point temperature
- Desiccant material that absorbs moisture from the air

A clear understanding of the humidity ratio (moisture content) provides a very useful method for engineers to estimate the amount of latent load and condensation rate that the system needs to be designed for. For example, the humidity ratio provides an indication of the amount of water that needs to be extracted from the outdoor air to supply air-conditioned air at 11°C and 100% relative humidity (approximately 8.2g/kg) at the cooling coil (off-coil condition). As the average moisture content of outdoor air in Malaysia is 18.3g/kg, an average extraction of 10.1 grams of water from each kilogram of outdoor air is required to provide a supply of air-conditioned air at 11°C and 100% relative humidity. This value provides an approximation of the condensation rate of a typical cooling coil in Malaysian air handling units due to the intake of fresh air.

### DESIGN RISK

Water features and greenery would increase the moisture content in the air. During photosynthesis process, greenery expels moisture from leaves to provide evaporative cooling to the environment. Therefore, it is not necessary true that placing a fresh air intake duct near to greenery (to take in cooler air) will yield lower energy use because it may have a higher moisture content in it.

CHART 2.4 | MOISTURE CONTENT



RAW DATA | MOISTURE CONTENT

Hours	Average	Minimum	Maximum	Std Dev.
1:00:00 AM	18.4	15.0	21.3	0.9
2:00:00 AM	18.2	14.6	20.8	0.9
3:00:00 AM	18.1	14.8	20.5	0.9
4:00:00 AM	17.9	15.3	20.5	0.9
5:00:00 AM	17.8	15.0	20.3	0.9
6:00:00 AM	17.7	14.4	20.0	0.9
7:00:00 AM	17.8	14.2	20.0	0.9
8:00:00 AM	18.3	14.8	20.7	1.0
9:00:00 AM	18.3	15.1	21.1	1.1
10:00:00 AM	18.1	13.8	21.0	1.2
11:00:00 AM	17.9	13.7	20.7	1.3
12:00:00 PM	17.9	13.5	21.0	1.3
1:00:00 PM	17.9	13.2	21.2	1.4
2:00:00 PM	18.0	13.0	23.7	1.6
3:00:00 PM	18.2	13.2	21.6	1.5
4:00:00 PM	18.4	13.9	22.2	1.5
5:00:00 PM	18.4	14.4	22.6	1.3
6:00:00 PM	18.6	15.1	22.6	1.2
7:00:00 PM	18.8	15.1	21.7	1.1
8:00:00 PM	18.8	14.9	21.7	1.0
9:00:00 PM	18.8	15.0	21.4	1.0
10:00:00 PM	18.7	15.1	21.2	0.9
11:00:00 PM	18.7	15.0	21.2	0.9
12:00:00 AM	18.5	15.1	20.9	0.9

# DEW POINT TEMPERATURE

The dew point temperature is directly linked to the moisture content in the air. However, the dew point temperature has the advantage of providing us information on the condensation risk due to exposure to outdoor air. Any surface temperature that is below the dew point temperature will have condensation on it. The average dew point temperature in the TRY is 23.4°C and is fairly consistent day or night and throughout the year. The peak standard deviation of the dew point temperature is 1.5°C at 2pm in the afternoon.

For more than 70% of the hours, the dew point temperature is below 24°C and for more than 95% of the hours, the dew point temperature is below 25°C.

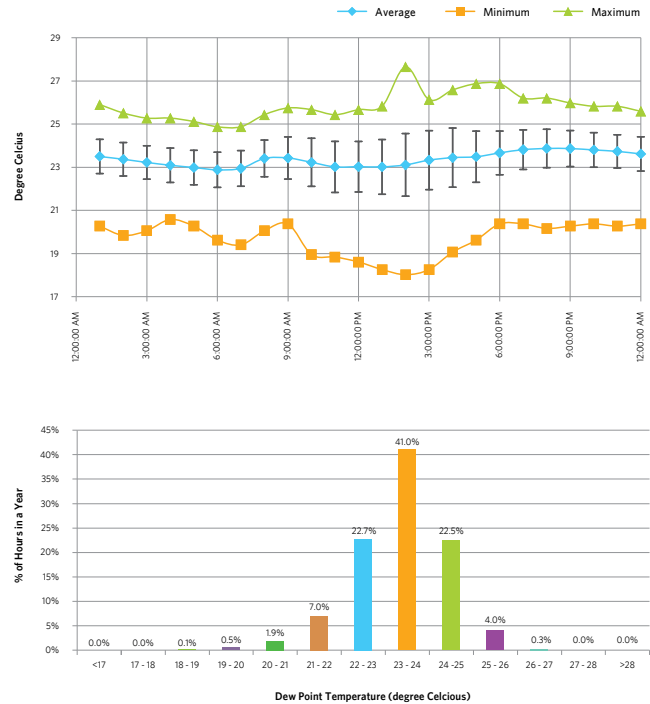
## DESIGN POTENTIAL

The dew point temperature provides an indication when condensation will occur. As long as the surface temperature is kept above the dew point temperature, there will be no condensation. For example, if a surface temperature exposed to outdoor air is kept above 25°C, the risk of condensation is less than 5% and above 26°C, the risk of condensation is less than 0.5%. This provides a possibility to provide radiant cooling to an outdoor area (e.g. al-fresco dining, etc.) where the surface temperature can be kept above the dew point temperature to avoid condensation while minimising energy consumption to cool occupants in an outdoor space.

## DESIGN RISK

If there are water features, greenery and cooking done (evaporation of water) within the space, the moisture content in the air may increase and cause the dew point temperature to increase as well. Therefore, condensation may occur at a higher surface temperature due to these micro-climatic conditions.

CHART 2.5 | DEW POINT TEMPERATURE



RAW DATA | DEW POINT TEMPERATURE

Hours	Average	Minimum	Maximum	Std Dev.
1:00:00 AM	23.5	20.3	25.9	0.8
2:00:00 AM	23.4	19.8	25.5	0.8
3:00:00 AM	23.2	20.1	25.3	0.8
4:00:00 AM	23.1	20.6	25.3	0.8
5:00:00 AM	23.0	20.3	25.1	0.8
6:00:00 AM	22.9	19.6	24.9	0.8
7:00:00 AM	22.9	19.4	24.9	0.8
8:00:00 AM	23.4	20.1	25.4	0.8
9:00:00 AM	23.4	20.4	25.7	1.0
10:00:00 AM	23.2	19.0	25.7	1.1
11:00:00 AM	23.0	18.8	25.4	1.2
12:00:00 PM	23.0	18.6	25.7	1.2
1:00:00 PM	23.0	18.3	25.8	1.3
2:00:00 PM	23.1	18.0	27.7	1.5
3:00:00 PM	23.3	18.3	26.1	1.4
4:00:00 PM	23.4	19.1	26.6	1.4
5:00:00 PM	23.5	19.6	26.9	1.2
6:00:00 PM	23.7	20.4	26.9	1.0
7:00:00 PM	23.8	20.4	26.2	0.9
8:00:00 PM	23.9	20.2	26.2	0.9
9:00:00 PM	23.9	20.3	26.0	0.8
10:00:00 PM	23.8	20.4	25.8	0.8
11:00:00 PM	23.7	20.3	25.8	0.8
12:00:00 AM	23.6	20.4	25.6	0.8

# RELATIVE HUMIDITY

Relative humidity is a measure of the amount of water (moisture) in the air as compared to the maximum amount of water the air can absorb, expressed in percentage. It is not a direct indicator of how much water is in the air, as provided by the humidity ratio (moisture content) or dew point temperature. The dry bulb temperature determines the maximum moisture the air can absorb; therefore, relative humidity is directly linked to both the humidity ratio (moisture content) as well as the dry bulb temperature, expressed in percentage of moisture in the air.

As the moisture content in the air is fairly constant day or night, the change of relative humidity is strongly related to the dry bulb temperature of the air. During the night time and early morning hours when the dry bulb temperature is low, the relative humidity is very high (between 90% to 100% relative humidity). However during the daytime hours when the dry bulb temperature is high, the relative humidity has an average low of 62%.

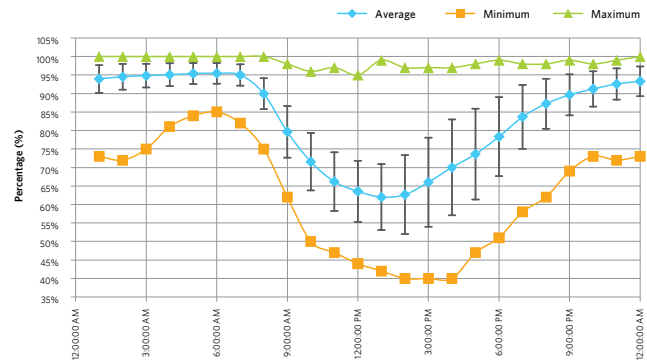
### DESIGN POTENTIAL

A low relative humidity is an indication of how well evaporative cooling will work. The lower the relative humidity, the easier it is for water to evaporate to reduce the dry bulb air temperature. At a very high relative humidity level of 90% or more, only a very small amount of water will be able to evaporate.

### DESIGN RISK

Relative humidity is a factor of both dry bulb temperature and moisture content. It is not possible to compute energy changes when provided with the relative humidity alone. For example, how much energy will it take to reduce the relative humidity of 90% to 50%? It would not be possible to give an answer to such a question. However, it will be possible to compute the energy change if the question is rephrased into how much energy will it take to reduce the relative humidity of 90% at 25°C to a relative humidity of 50% at 23°C. Relative humidity is useful as an indicator of moisture in the air only when provided with the dry bulb temperature.

CHART 2.6 | RELATIVE HUMIDITY



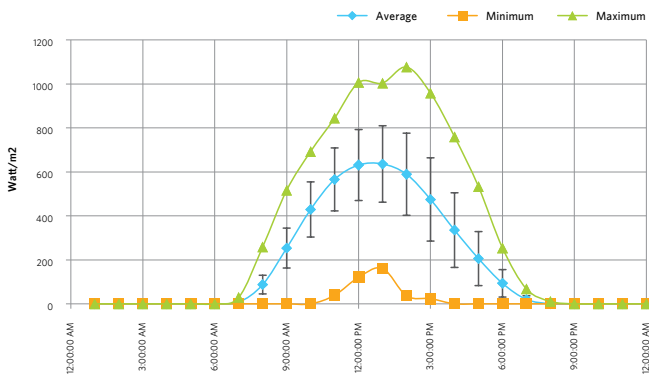
RAW DATA | RELATIVE HUMIDITY

Hours	Average	Minimum	Maximum	Std Dev.
1:00:00 AM	93.9	73	100	3.7
2:00:00 AM	94.5	72	100	3.5
3:00:00 AM	94.8	75	100	3.2
4:00:00 AM	95.1	81	100	3.1
5:00:00 AM	95.4	84	100	2.8
6:00:00 AM	95.4	85	100	2.8
7:00:00 AM	95.0	82	100	2.9
8:00:00 AM	89.9	75	100	4.2
9:00:00 AM	79.6	62	98	7.0
10:00:00 AM	71.6	50	96	7.8
11:00:00 AM	66.2	47	97	7.9
12:00:00 PM	63.6	44	95	8.3
1:00:00 PM	62.0	42	99	8.9
2:00:00 PM	62.7	40	97	10.7
3:00:00 PM	66.0	40	97	12.0
4:00:00 PM	70.0	40	97	13.0
5:00:00 PM	73.6	47	98	12.3
6:00:00 PM	78.3	51	99	10.7
7:00:00 PM	83.7	58	98	8.6
8:00:00 PM	87.2	62	98	6.8
9:00:00 PM	89.6	69	99	5.5
10:00:00 PM	91.2	73	98	4.8
11:00:00 PM	92.6	72	99	4.2
12:00:00 AM	93.3	73	100	4.0

# HORIZONTAL GLOBAL RADIATION

The average global radiation is almost a perfect symmetry between the morning hours and afternoon hours with its peak close to the solar noon. The average peak is 636 W/m<sup>2</sup> at 1pm while the absolute peak in the TRY is 1,077 W/m<sup>2</sup> at 2pm, western sun. The absolute peak of solar radiation is almost double of the average peak. This indicates that there are days where the cloud cover is low, allowing direct solar radiation to cause high solar gain in buildings. However on average, the cloud cover in a tropical climate provides good protection to reduce the impact of direct solar radiation. The TRY data also showed that it is possible at any time of day for the solar radiation to be reduced to close to zero, most likely caused by heavy rain cloud covers.

**CHART 2.7 | HORIZONTAL GLOBAL RADIATION**



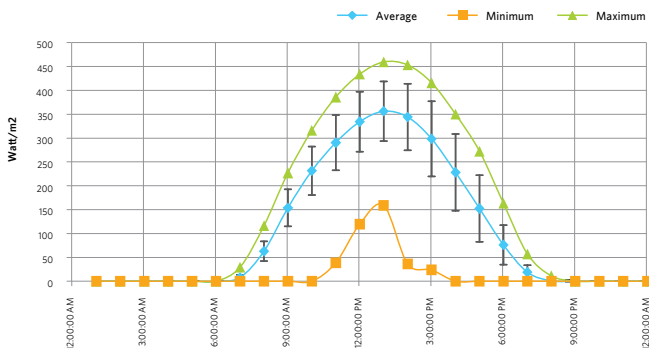
**RAW DATA | GLOBAL RADIATION**

Hours	Average	Minimum	Maximum	Std Dev.
1:00:00 AM	0.0	0.0	0.0	0.0
2:00:00 AM	0.0	0.0	0.0	0.0
3:00:00 AM	0.0	0.0	0.0	0.0
4:00:00 AM	0.0	0.0	0.0	0.0
5:00:00 AM	0.0	0.0	0.0	0.0
6:00:00 AM	0.0	0.0	0.0	0.0
7:00:00 AM	7.7	0.0	29.2	5.7
8:00:00 AM	87.5	0.0	259.1	42.4
9:00:00 AM	253.6	0.0	516.2	90.7
10:00:00 AM	429.0	0.0	692.8	125.4
11:00:00 AM	565.7	38.9	844.3	143.2
12:00:00 PM	631.0	120.8	1006.4	161.3
1:00:00 PM	635.9	161.1	1003.7	173.8
2:00:00 PM	589.2	36.1	1076.5	186.7
3:00:00 PM	474.6	23.7	958.0	189.3
4:00:00 PM	335.2	0.0	759.7	169.7
5:00:00 PM	205.7	0.0	532.7	122.8
6:00:00 PM	93.2	0.0	254.1	62.4
7:00:00 PM	20.0	0.0	67.7	16.7
8:00:00 PM	0.7	0.0	11.1	1.7
9:00:00 PM	0.0	0.0	0.0	0.0
10:00:00 PM	0.0	0.0	0.0	0.0
11:00:00 PM	0.0	0.0	0.0	0.0
12:00:00 AM	0.0	0.0	0.0	0.0

# DIFFUSE SOLAR RADIATION

The average peak diffuse radiation is 356 W/m<sup>2</sup> at 1pm, while the absolute peak diffuse radiation is 460 W/m<sup>2</sup> also at 1pm. The standard deviation is generally low, with the highest at 80 W/m<sup>2</sup> at 4pm in the afternoon.

**CHART 2.8 | DIFFUSE SOLAR RADIATION**



**RAW DATA | DIFFUSE RADIATION**

Hours	Average	Minimum	Maximum	Std Dev.
1:00:00 AM	0.0	0.0	0.0	0.0
2:00:00 AM	0.0	0.0	0.0	0.0
3:00:00 AM	0.0	0.0	0.0	0.0
4:00:00 AM	0.0	0.0	0.0	0.0
5:00:00 AM	0.0	0.0	0.0	0.0
6:00:00 AM	0.0	0.0	0.0	0.0
7:00:00 AM	7.7	0.0	29.2	5.7
8:00:00 AM	62.8	0.0	116.1	20.7
9:00:00 AM	153.8	0.0	227.1	38.8
10:00:00 AM	231.4	0.0	316.2	50.8
11:00:00 AM	290.4	38.7	386.1	58.0
12:00:00 PM	334.4	119.7	434.0	62.9
1:00:00 PM	356.2	158.9	459.7	62.5
2:00:00 PM	344.1	36.0	453.3	69.8
3:00:00 PM	298.4	23.6	415.9	78.8
4:00:00 PM	228.1	0.0	350.1	80.4
5:00:00 PM	152.3	0.0	272.5	69.8
6:00:00 PM	76.1	0.0	163.3	41.4
7:00:00 PM	18.8	0.0	57.1	14.6
8:00:00 PM	0.7	0.0	11.1	1.7
9:00:00 PM	0.0	0.0	0.0	0.0
10:00:00 PM	0.0	0.0	0.0	0.0
11:00:00 PM	0.0	0.0	0.0	0.0
12:00:00 AM	0.0	0.0	0.0	0.0

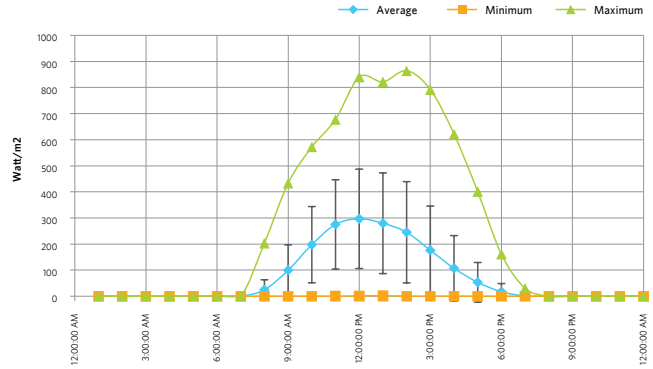
# DIRECT SOLAR RADIATION

The average peak direct radiation is 297 W/m<sup>2</sup> at 12noon, while the absolute peak direct radiation is 865 W/m<sup>2</sup> at 2pm in the afternoon.

The absolute peak direct solar radiation is almost 3 times higher than the average peak direct solar radiation. The standard deviation is rather high, with the highest at 194 W/m<sup>2</sup> at 2pm in the afternoon.

All this data indicates that there is a significant difference between the average and the absolute peak direct radiation in the TRY. It is also quite clear from the direct radiation chart that the average direct radiation is higher in the morning hours than the afternoon hours. However, the absolute peak direct solar radiation occurs in the afternoon hours.

CHART 2.9 | DIRECT SOLAR RADIATION



RAW DATA | DIRECT SOLAR RADIATION

Hours	Average	Minimum	Maximum	Std Dev.
1:00:00 AM	0.0	0.0	0.0	0.0
2:00:00 AM	0.0	0.0	0.0	0.0
3:00:00 AM	0.0	0.0	0.0	0.0
4:00:00 AM	0.0	0.0	0.0	0.0
5:00:00 AM	0.0	0.0	0.0	0.0
6:00:00 AM	0.0	0.0	0.0	0.0
7:00:00 AM	0.0	0.0	0.0	0.0
8:00:00 AM	24.7	0.0	203.2	38.2
9:00:00 AM	99.8	0.0	433.1	97.1
10:00:00 AM	197.6	0.0	572.2	146.1
11:00:00 AM	275.2	0.2	677.7	171.1
12:00:00 PM	296.7	1.2	840.6	190.6
1:00:00 PM	279.7	2.3	821.7	193.0
2:00:00 PM	245.1	0.1	864.5	194.2
3:00:00 PM	176.2	0.0	792.2	169.6
4:00:00 PM	107.0	0.0	621.7	125.4
5:00:00 PM	53.4	0.0	401.0	76.0
6:00:00 PM	17.2	0.0	160.8	31.4
7:00:00 PM	1.2	0.0	30.6	4.0
8:00:00 PM	0.0	0.0	0.0	0.0
9:00:00 PM	0.0	0.0	0.0	0.0
10:00:00 PM	0.0	0.0	0.0	0.0
11:00:00 PM	0.0	0.0	0.0	0.0
12:00:00 AM	0.0	0.0	0.0	0.0



# COMPARISON OF GLOBAL, DIRECT & DIFFUSE RADIATION

Placing the average global, direct and diffuse radiation in the same chart provides a distinct understanding that the average direct solar radiation is more intense in the morning while the average diffuse radiation is more intense in the afternoon hours.

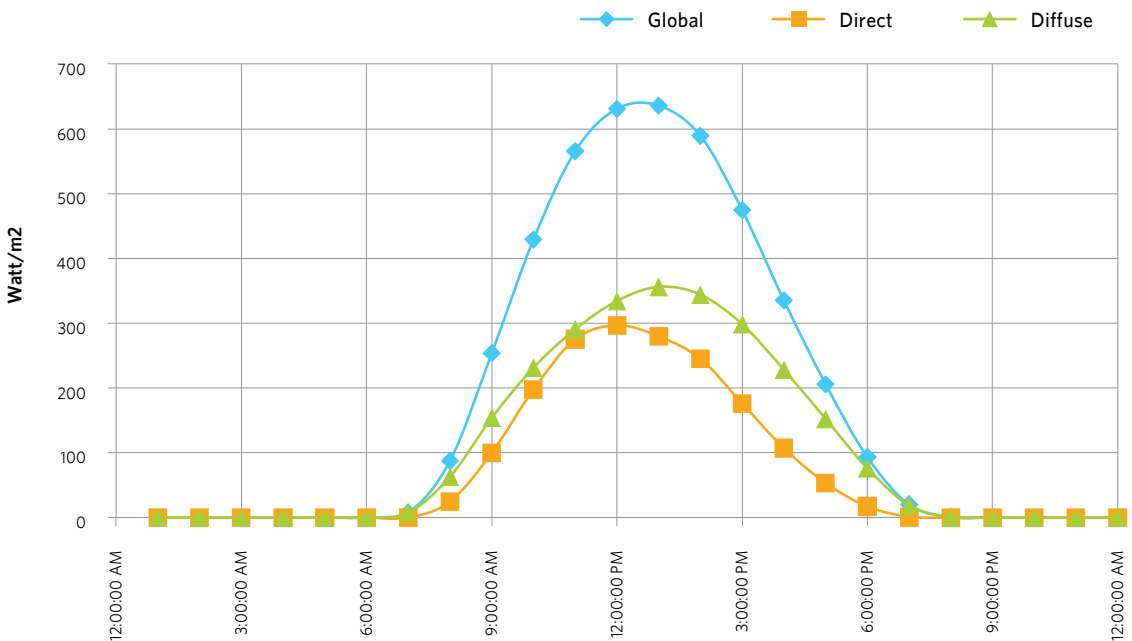
### DESIGN POTENTIAL

It is important to shade the western façade from direct solar radiation to reduce the peak cooling load in buildings. The peak cooling load in a building determines the size of air-conditioning equipment to be provided. However for energy efficiency, the plot of average solar radiations showed that it is more important to shade the eastern façade from direct solar radiation to reduce the annual energy consumption in building.

### DESIGN RISK

The direct and diffuse radiation in the TRY is not a measured value but computed from the measured horizontal global radiation using the Erbs' Estimation Model. However, the result generally agrees with the daily observation of solar radiation in this climate. In the tropical climate where it rains more often in the afternoon than in the morning, creates skies with a heavier average cloud cover in the afternoon than in the morning.

CHART 2.10 | AVERAGE DAILY RADIATION



# CLOUD COVER (OKTAS)

The cloud cover in the TRY is measured in Oktas units. Oktas is defined by the World Meteorological Organization as provided by the table below<sup>4</sup>.

Oktas	Definition	Category
0	Sky clear	Fine
1	1/8 of sky covered or less, but not zero	Fine
2	2/8 of sky covered	Fine
3	3/8 of sky covered	Partly Cloudy
4	4/8 of sky covered	Partly Cloudy
5	5/8 of sky covered	Partly Cloudy
6	6/8 of sky covered	Cloudy
7	7/8 of sky covered or more, but not 8/8	Cloudy
8	8/8 of sky completely covered, no breaks	Overcast

The cloud cover is generally high in the TRY and is reflective of a tropical climate. The average cloud cover has an Oktas of 6.8 in Malaysia and is fairly consistent day and night and throughout the year. The maximum cloud cover has the maximum Oktas of 8 and can occur at any time of day. However the minimum 0 Oktas is recorded by the TRY happening at 6am and 7am in the early morning and the minimum cloud cover in the afternoon is at least 1 Oktas higher than in the morning, indicating that minimum cloud cover is heavier in the afternoon than in the morning.

The standard deviation is higher in the morning as compared to the afternoon, indicating that there is a larger day to day variation of cloud cover in the morning as compared to the afternoon. In other words, in the afternoon, the sky is consistently heavy with clouds, whereas in the morning, the cloud cover may sometimes be low.

### DESIGN POTENTIAL

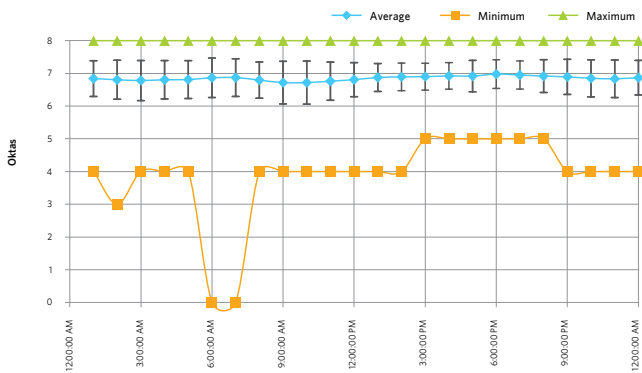
High numbers indicate heavy cloud cover in Malaysia's climate. It also means that during the daytime, the Malaysian sky is normally bright because the sky will be illuminated by the clouds as opposed to clear blue skies.

Heavy cloud cover also hinders radiation heat transfer between objects on the ground with the sky. In general the lower the Oktas number, the better it is for the sky to cool objects on the ground surface.

### DESIGN RISK

Oktas measurements are done manually by meteorologists. They would take a look at the sky and decide how many eighths of the sky is covered by clouds.

CHART 2.11 | CLOUD COVER



RAW DATA | CLOUD COVER

Hours	Average	Minimum	Maximum	Std Dev.
1:00:00 AM	6.8	4.0	8.0	0.5
2:00:00 AM	6.8	3.0	8.0	0.6
3:00:00 AM	6.8	4.0	8.0	0.6
4:00:00 AM	6.8	4.0	8.0	0.6
5:00:00 AM	6.8	4.0	8.0	0.6
6:00:00 AM	6.9	0.0	8.0	0.6
7:00:00 AM	6.9	0.0	8.0	0.6
8:00:00 AM	6.8	4.0	8.0	0.6
9:00:00 AM	6.7	4.0	8.0	0.7
10:00:00 AM	6.7	4.0	8.0	0.7
11:00:00 AM	6.8	4.0	8.0	0.6
12:00:00 PM	6.8	4.0	8.0	0.5
1:00:00 PM	6.9	4.0	8.0	0.4
2:00:00 PM	6.9	4.0	8.0	0.4
3:00:00 PM	6.9	5.0	8.0	0.4
4:00:00 PM	6.9	5.0	8.0	0.4
5:00:00 PM	6.9	5.0	8.0	0.5
6:00:00 PM	7.0	5.0	8.0	0.4
7:00:00 PM	7.0	5.0	8.0	0.4
8:00:00 PM	6.9	5.0	8.0	0.5
9:00:00 PM	6.9	4.0	8.0	0.5
10:00:00 PM	6.8	4.0	8.0	0.6
11:00:00 PM	6.8	4.0	8.0	0.6
12:00:00 AM	6.9	4.0	8.0	0.5

<sup>4</sup> <http://worldweather.wmo.int/oktas.htm>

# EFFECTIVE SKY TEMPERATURE

It is useful to provide the effective sky temperature in this chapter because it provides an indication of the possibility of using the sky to cool buildings passively. The effectiveness of radiation heat exchange between objects on the ground surface with the sky is defined by the effective sky temperature. The effective sky temperature is not provided by the TRY but is estimated from the dry bulb temperature, the dew point temperature and the cloud cover using equations provided by Clark and Blanplied<sup>5</sup>.

The estimated average effective sky temperature in TRY is 18°C. It is higher during the daytime and lower during the night time. The average lowest effective sky temperature is 14.6°C at 7am in the morning. While the absolute lowest effective sky temperature was estimated to be 9.5°C at 8am in the morning. Although the daytime average effective sky temperature is in the low 20s°C, the direct and diffuse solar radiation during the daytime is providing much more heat than the sky is removing.

On average, the effective sky temperature is below 20°C from the hours of 6pm to 11am. The lowest average effective sky temperature is approximately 15°C at 6am in the morning.

## DESIGN POTENTIAL

The lower the effective sky temperature is, the better it is for the sky to absorb heat from (cooling) objects on the ground. Therefore, as long as a surface is shielded from

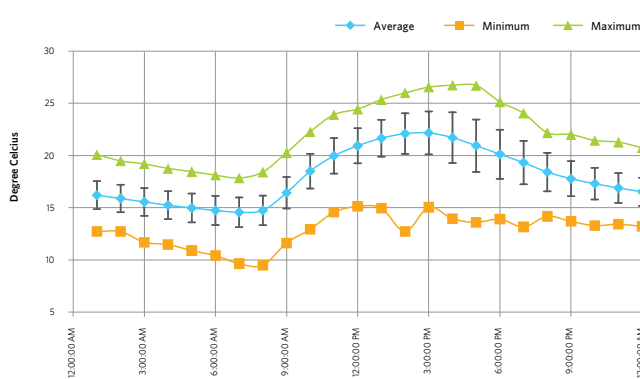
direct radiation or does not absorb solar radiation (as in products with very high solar reflectivity) or during the night time (no solar radiation), the sky can be used as a means of heat rejection or cooling source.

A roof system that can block heat gain during the daytime and release heat during the night time will potentially be an effective means of cooling a building. Buildings that are primary used during the night time such as residential homes will benefit significantly from such a roof design. Movable roof insulation, cool roof paints that reject solar radiation during the daytime while having high emissivity to release heat, etc. may be interesting solutions for residential homes.

## DESIGN RISK

An average effective sky temperature above 20°C during the daytime is not considered to be sufficient to cool objects on the ground. Therefore, using the sky to cool objects on the ground will only be useful during the night time when the effective sky temperature reduces below 20°C. In countries where the cloud cover is low and the ambient air temperature is moderate, it is possible for the sky to provide a consistent effective sky temperature below 10°C (in some places, even below 0°C, making it possible to make ice with the night sky<sup>6</sup>). The high effective sky temperature found in this climate is largely due to the high moisture content in the air and the heavy cloud cover.

CHART 2.12 | EFFECTIVE SKY TEMPERATURE



RAW DATA | EFFECTIVE SKY TEMPERATURE

Hours	Average	Minimum	Maximum	Std Dev.
1:00:00 AM	16.20	12.7	20.1	1.3
2:00:00 AM	15.89	12.7	19.5	1.3
3:00:00 AM	15.55	11.7	19.2	1.3
4:00:00 AM	15.24	11.5	18.8	1.3
5:00:00 AM	14.98	10.9	18.5	1.4
6:00:00 AM	14.74	10.4	18.1	1.4
7:00:00 AM	14.56	9.6	17.9	1.4
8:00:00 AM	14.75	9.5	18.4	1.4
9:00:00 AM	16.43	11.6	20.3	1.5
10:00:00 AM	18.51	12.9	22.3	1.7
11:00:00 AM	19.97	14.6	23.9	1.7
12:00:00 PM	20.93	15.1	24.4	1.7
1:00:00 PM	21.66	15.0	25.4	1.8
2:00:00 PM	22.10	12.7	26.0	1.9
3:00:00 PM	22.17	15.0	26.6	2.1
4:00:00 PM	21.72	13.9	26.7	2.4
5:00:00 PM	20.94	13.6	26.7	2.5
6:00:00 PM	20.12	13.9	25.1	2.4
7:00:00 PM	19.33	13.2	24.1	2.1
8:00:00 PM	18.42	14.2	22.2	1.8
9:00:00 PM	17.78	13.7	22.0	1.7
10:00:00 PM	17.31	13.3	21.4	1.5
11:00:00 PM	16.89	13.4	21.3	1.4
12:00:00 AM	16.53	13.2	20.7	1.3

<sup>5</sup> Gene Clark and M. Blanplied, 1979. "The Effect of IR Transparent Windscreens on Net Nocturnal Cooling from Horizontal Surfaces," Proceedings of the 4th National Passive Solar Conference, Kansas City, MO.  
<sup>6</sup> "Lesson 1: History Of Refrigeration, Version 1 ME". Indian Institute of Technology Kharagpur. Archived from the original on 2011-11-06.

# GROUND TEMPERATURE

The ground temperature was computed from the TRY using Kasuda's equation<sup>7</sup> at a 1 meter depth. It was computed that the soil temperature is constant at 26.9°C for the entire year. Further investigation using Kasuda's equation showed that at any depth greater than 0.5 meters, the ground temperature will be constant at 26.9°C.

It is also important to note that the groundwater temperature will also be the same temperature as the ground (soil) temperature.

## DESIGN POTENTIAL

There exists designs that channel air intake into building through an underground chamber to pre-cool the air before entering the building. However, this strategy will only work well in this climate during the daytime when the outdoor air temperature is higher than the soil temperature. During the night time, the outdoor air temperature is lower than the soil temperature, so channelling night air into the underground chamber will heat up the air instead of cooling it down. In short, this strategy will work well with office buildings where the building is occupied during daytime; it will not work well for residential homes because the homes are normally occupied during the night time.

The TRY has an average wet bulb temperature of 24.3°C and a typical cooling tower design calls for an approach temperature of 5.5°C higher than the wet bulb temperature, providing an average of 29.8°C return water temperature to the chiller. The groundwater temperature is estimated to be 26.9°C; therefore it is approximately 3°C cooler than the water from the cooling tower. Colder water for the condensing side of the chiller will improve the efficiency of the chiller significantly. Water from deep lakes would also have good potential for such an opportunity improve the efficiency of the chiller because the temperature of the water in deep lakes will also follow the ground temperature.

## DESIGN RISK

Kasuda's equation does not account for rainfall on the soil. As water from the soil will evaporate at the wet bulb temperature, the surface of the soil may be cooler on average for a climate such as Malaysia's where it rains fairly often and consistently throughout the year. The effect of rainfall is expected to be minimal on the ground temperature. However, actual measurement of the on-site ground temperature is highly recommended.

In addition, further studies are recommended to ensure that the cooler daytime air achieved via an underground chamber can be achieved without increasing the moisture content of the air. An increase in moisture content will increase the energy consumption of the air-conditioning system.

Excessive groundwater harvesting without adequate recharge will cause soil properties to deteriorate and may cause the ground to sink. Moreover, pumping water over long distances will also increase the water temperature due to friction and conduction gain through the pipes, which may cause the predicted 3°C cooler water temperature to be unachievable.

<sup>7</sup> Kasuda, T., and Archenbach, P.R. 1965. Earth Temperature and Thermal Diffusivity at Selected Stations in the United States, ASHRAE Transactions, Vol. 71, Part 1.

# WIND SPEED

The average wind speed in the TRY showed that the wind speed is low (less than 0.5 m/s) from the hours of 8pm to 8am. The wind speed starts to increase at 8am and has an average peak of 3.5 m/s at 3pm in the afternoon. The hourly maximum wind speed showed that it is possible to have a high wind speed at any time of the day, with the lowest chance of a high wind speed at 8am in the morning. The data also showed that it is also possible to have zero wind speed at any time of the day.

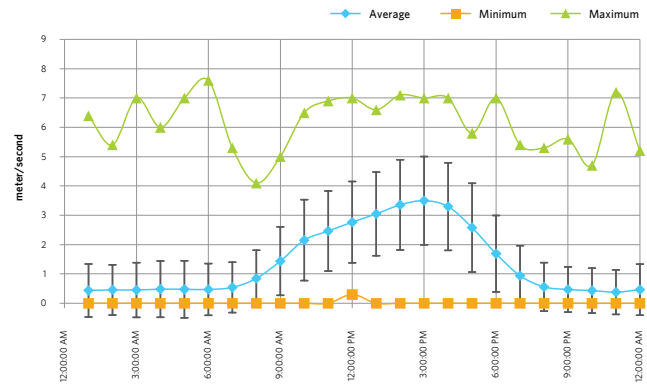
## DESIGN POTENTIAL

It is important to note that the peak average wind speed occurs at the same time of high dry bulb temperature. Similarly, when the dry bulb temperature is low, the average wind speed is also low. This indicates that buildings designed with cross-ventilation at all hours will on average bring more hot air than cool air into the building. As the wind speed data showed that high wind speeds can occur at any time, it is also possible for cross ventilation to bring in cool air to benefit the building occupants. Therefore, cross-ventilation designs need to consider the hours occupants make use of the space and also the possibility of diverting hot wind away from occupants during certain hours/conditions of the day and to divert cool air towards the occupants during certain hours/conditions of the day. Operable windows, where the building occupant has control over when cross ventilation is used is highly recommended.

## DESIGN RISK

The wind speed and wind direction data should be checked further against other year's data to ensure that the data in TRY is reflective of the actual situation. The selected months of the TRY data was predominantly selected based on the dry bulb temperature, global horizontal solar radiation and humidity ratio. Therefore, it is recommended for academicians and researchers to investigate the wind data further to confirm the behaviour of wind speed and wind direction according to the hour of the day and day of the year.

CHART 2.13 | WIND SPEED



RAW DATA | WIND SPEED

Hours	Average	Minimum	Maximum	Std Dev.
1:00:00 AM	0.44	0.0	6.4	0.9
2:00:00 AM	0.46	0.0	5.4	0.9
3:00:00 AM	0.45	0.0	7.0	0.9
4:00:00 AM	0.48	0.0	6.0	1.0
5:00:00 AM	0.48	0.0	7.0	1.0
6:00:00 AM	0.47	0.0	7.6	0.9
7:00:00 AM	0.54	0.0	5.3	0.9
8:00:00 AM	0.85	0.0	4.1	1.0
9:00:00 AM	1.44	0.0	5.0	1.2
10:00:00 AM	2.15	0.0	6.5	1.4
11:00:00 AM	2.46	0.0	6.9	1.4
12:00:00 PM	2.77	0.3	7.0	1.4
1:00:00 PM	3.05	0.0	6.6	1.4
2:00:00 PM	3.36	0.0	7.1	1.5
3:00:00 PM	3.50	0.0	7.0	1.5
4:00:00 PM	3.30	0.0	7.0	1.5
5:00:00 PM	2.58	0.0	5.8	1.5
6:00:00 PM	1.69	0.0	7.0	1.3
7:00:00 PM	0.94	0.0	5.4	1.0
8:00:00 PM	0.56	0.0	5.3	0.8
9:00:00 PM	0.47	0.0	5.6	0.8
10:00:00 PM	0.43	0.0	4.7	0.8
11:00:00 PM	0.38	0.0	7.2	0.8
12:00:00 AM	0.46	0.0	5.2	0.9

# WIND DIRECTION & HOURS OF AIR TEMPERATURE BELOW 29°C

Based on Ashrae 55's thermal adaptive comfort model for natural ventilation, an operative temperature of 29°C in Malaysia's climate will provide an 80% population satisfaction rate<sup>8</sup>. Harvesting natural ventilation with air temperatures above 29°C will only heat up the environment, providing uncomfortable conditions for the building occupants. Therefore, natural ventilation should only aim to harvest the cool wind that is below 29°C. This section provides information on which direction wind below 29°C normally comes from and what is the right hour in the day to harvest cool wind in Malaysia.

Detailed analysis of the TRY of its wind direction and dry bulb air temperature shows that for a significant 37.5% of the hours in the whole year, the dry bulb (wind) temperature is below 29°C. The occurrence of cool wind is largely during the hours of late evening to mid-morning. Charts provided in this section show that colder wind comes from the North (946 hours, 29%), North-West (593 hours, 18%), East (430 hours, 13%), South (326 hours, 10%), South-East (297 hours, 9%), South-West (249 hours, 8%), North-East (248 hours, 8%) and lastly West (196 hours, 6%). In short, cooler wind is primary from the North and North-West (combined to provide 47% of total cool wind available), then followed by the East and South.

Cool wind from the North and North-West normally occurs during the late afternoon (~5pm) until the late morning (~9am). While cool wind from the East mainly occurs in the morning hours of 8am to 9am. Cool wind from the South is low but is consistent throughout the day.

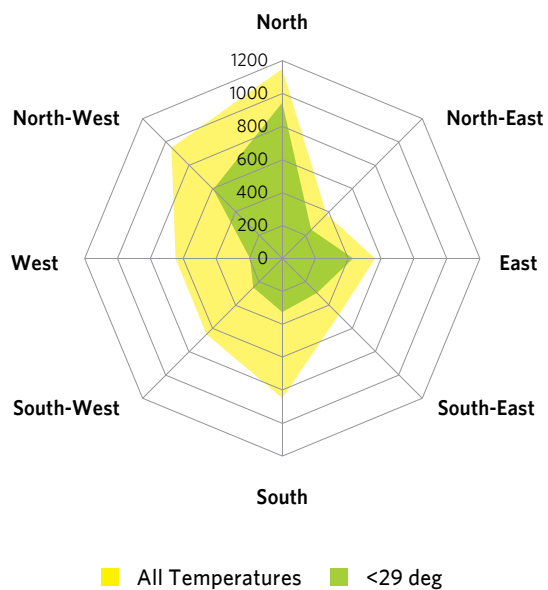
## DESIGN POTENTIAL

Capturing wind from the North and North-West should be the primary objective to use natural ventilation to cool the environment. Cool wind is primary available from the hours of 5pm to 9am. When the air temperature is high during noon, it will not be comfortable to harvest natural ventilation. Ideally the building occupants should have control over the natural ventilation by giving the building occupants the ability to close windows or doors, to divert the wind away from the occupied space when the wind is hot and to allow wind towards the occupied space when the wind is cool. Motorised louvres with temperature sensors may also be used to provide this diversion of natural ventilation without requiring manual intervention.

## DESIGN RISK

The wind speed and wind direction data should be checked further against other year's data to ensure that the data in TRY is reflective of the actual situation. The selected months of the TRY data was predominantly selected based on the dry bulb temperature, global horizontal solar radiation and humidity ratio. Therefore, it is recommended for academicians and researchers to investigate the wind data further to confirm the behaviour of wind speed and wind direction according to the hour of the day and day of the year.

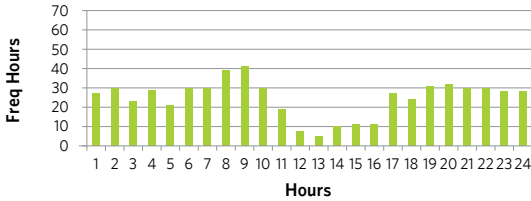
CHART 2.14 | HOURS OF WIND DIRECTION IN TRY



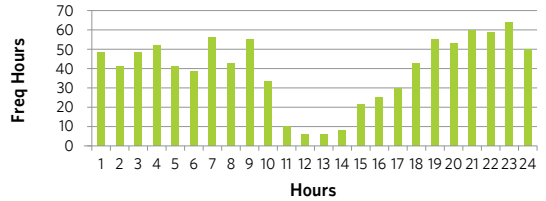
<sup>8</sup> Ashrae 55

CHARTS 2.15 | WIND CHARTS OF AIR TEMPERATURE BELOW 29°C

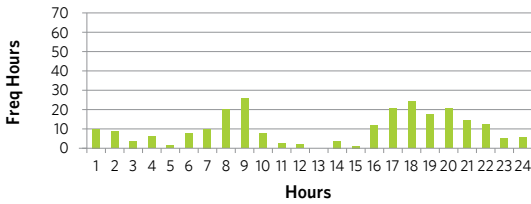
**NORTH-WEST WIND**



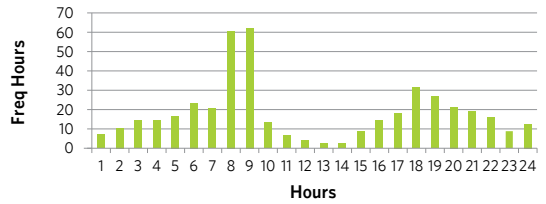
**NORTH WIND**



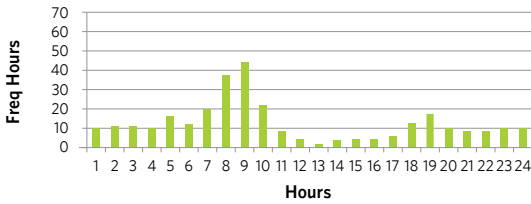
**NORTH-EAST WIND**



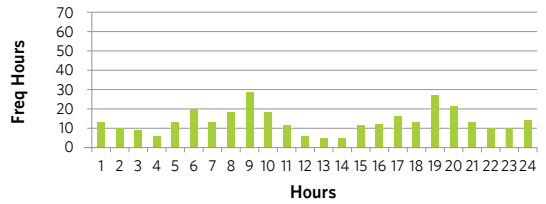
**EAST WIND**



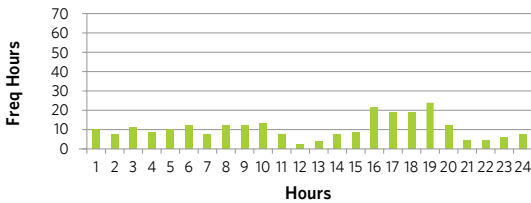
**SOUTH-EAST WIND**



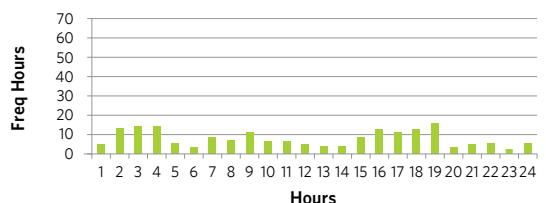
**SOUTH WIND**



**SOUTH-WEST WIND**



**WEST WIND**



## SUMMARY

A clear understanding of our local weather data will enable architects and engineers to become better building designers. Fortunately, the Malaysian climate zone is easy to comprehend because the seasonal variation is rather small, i.e. every day is more or less the same for the whole year.

An attempt is made in this chapter to clarify the Malaysian climate on its dry bulb temperature, wet bulb temperature, dew point temperature, moisture content, relative humidity, effective sky temperature, ground temperature, solar radiation and the relationship of wind speed and direction to the air temperature based on a Test Reference Year weather data. An attempt is also made to provide the Design Potential based on each of these climatic properties presented, providing the possibility of design options to harness the climate to benefit the building design for low energy consumption.

There may also be situations where the localised micro-climatic conditions may alter the design possibilities presented by the Test Reference Year weather data. The Design Risk is therefore provided for each climatic property presented, allowing building designers to understand the risk of implementing the design options presented in this chapter.

Building designers are encouraged to make use of the data provided in this chapter to innovate building designs to benefit from the climate. Ideally, buildings in Malaysia should benefit from night cooling from the sky, taking advantage of cooler night time air temperatures while preventing heat gain during the daytime from solar radiation, warm air temperatures and high moisture content. The challenge to the building designer is to strike the right balance between all these various climatic conditions to provide a comfortable environment for the building occupants while minimising carbon-based energy use.

It is also proposed that the data provided in this chapter be used as a fundamental check against any new design ideas proposed by designers, suppliers and manufacturers that may not understand the Malaysian climate well enough. For example, an evaporative cooling system that seems to work very well in an air-conditioned exhibition hall/showroom where the air is both cool and dry, will not be effective to be used outdoors during the night time because the relative humidity is very high during the night time in this climate zone, but it is still possible to use it during the daytime because the relative humidity is lower during the daytime in this climate zone.

---

### END OF CHAPTER 2

---

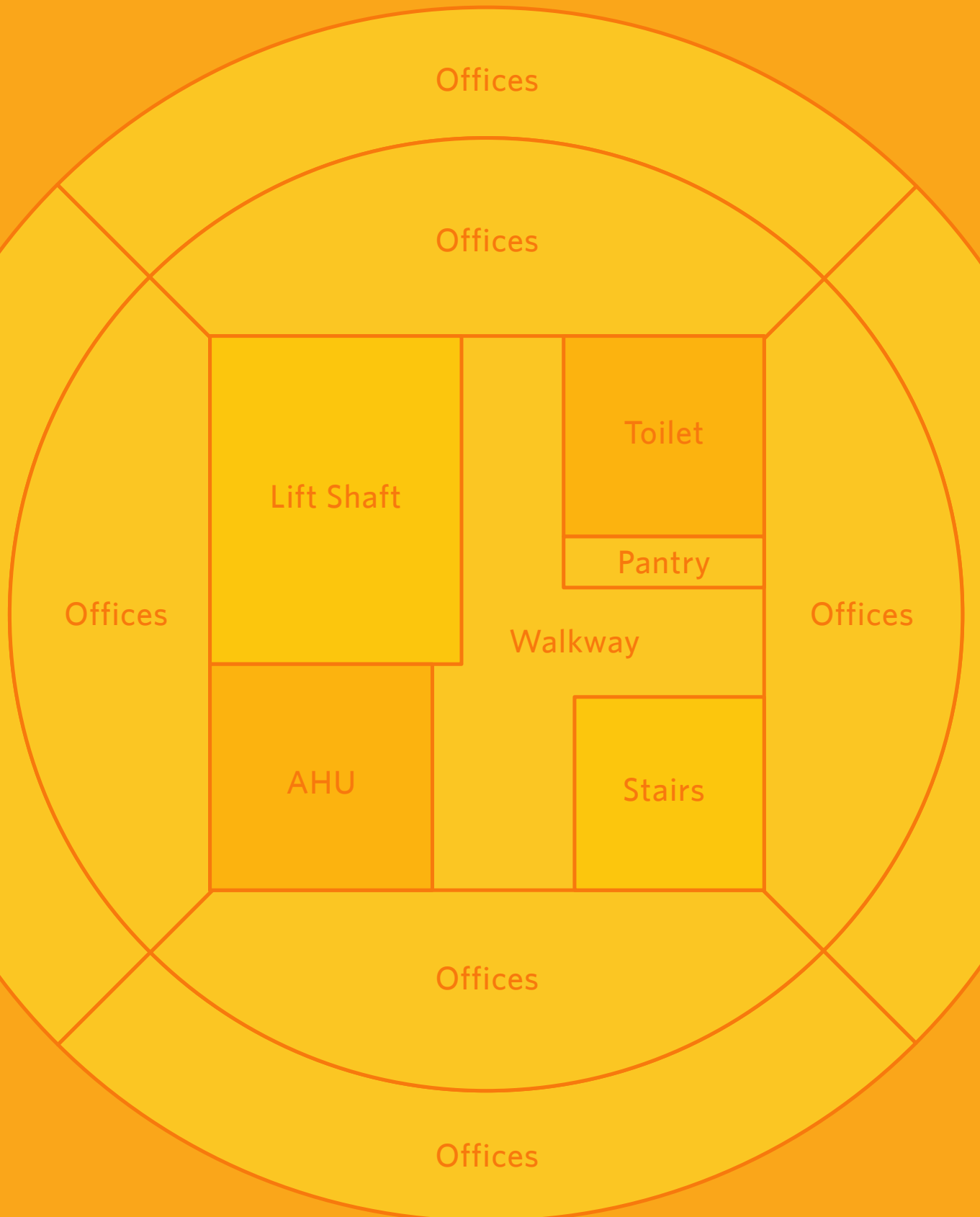


CHAPTER

# 3

## BUILDING FORM, CORE LOCATION & ORIENTATION





## 3

# BUILDING FORM, CORE LOCATION & ORIENTATION

## OBJECTIVE

Every architect has been taught about the importance of building orientation in terms of energy efficiency. However, the evaluation of building orientation cannot be made without including the building form and core location because these items have a significant influence on the overall energy efficiency of the building.

The selection of building form often dictates where the core location can be placed, while the core location dictates whether mechanical system is used to ventilate spaces such as toilets. Moreover, it is also possible to place the core location as a buffer zone to reduce the impact of solar radiation in the air-conditioned space of the building. The selection of the core location would then dictate the main orientation of the building that exposes the air-conditioned spaces to direct solar heat gain.

In addition to solar heat gain, exposing a façade to a particular orientation may also increase the infiltration rate due to the exposure to higher wind velocities.

Chapter 3 takes these factors into consideration and provides a simple guide on the impact of the building form, core location and orientation, to enable designers to understand the influence of their decision at the early stages of building design. It is important to note that Chapter 3 is not dictating how all buildings should be orientated. This chapter is provided to allow designers to consider using the next best option if the best option is not possible due to site conditions or other factors.

The objective of this chapter is to provide a guideline from an energy efficiency perspective on the selection of building form, core location and orientation.

# KEY RECOMMENDATIONS

The selection of building form, core location and orientation for energy efficiency should have the following priorities:

1

## Provide Less Glazing Areas When Possible

Choose a building form and core location that provides the least amount of glazing but maintains the necessary aesthetic appeal of the building and the view out.

2

## Provide Excellent View Out

If the building is located in a place that will benefit from having views in all directions (360°), selection of a building with a 360° view out is an acceptable option due to the low ratio of BEI/View Out as compared to other building forms, core locations and orientations.

3

## Provide Good Orientation

Expose glazing to the North and South, but limit the exposure to the East and West. Whenever possible, place the core location in the following order of priority:

- |                 |                |
|-----------------|----------------|
| i. East         | v. North-West  |
| ii. North-East  | vi. South-West |
| iii. South-East | vii. North     |
| iv. West        | viii. South    |

**Use this chapter as a general guide to pick the most energy efficient building form, core location and orientation to fit the site, taking into consideration the high priority of the building's aesthetic value to the client and the quality of the view out.**

## LOCATION OF AHU ROOM

The location of the AHU room has a large influence on the fan energy consumption of a building. The AHU room should ideally be located for the ductwork to distribute cold air evenly in the building via the shortest route. The longer the distance of the ductwork, the more energy will be used to distribute air-conditioned air to the space.

**TIP:** Place AHU room(s) for the shortest distance to distribute conditioned air evenly in the building.

# EXECUTIVE SUMMARY

This study showed that the most significant factor for lowering building energy consumption in a building is the glazing area

This study was conducted primarily for a multi-storey office building scenario. The conclusions drawn from this study may or may not be applicable for other building types.

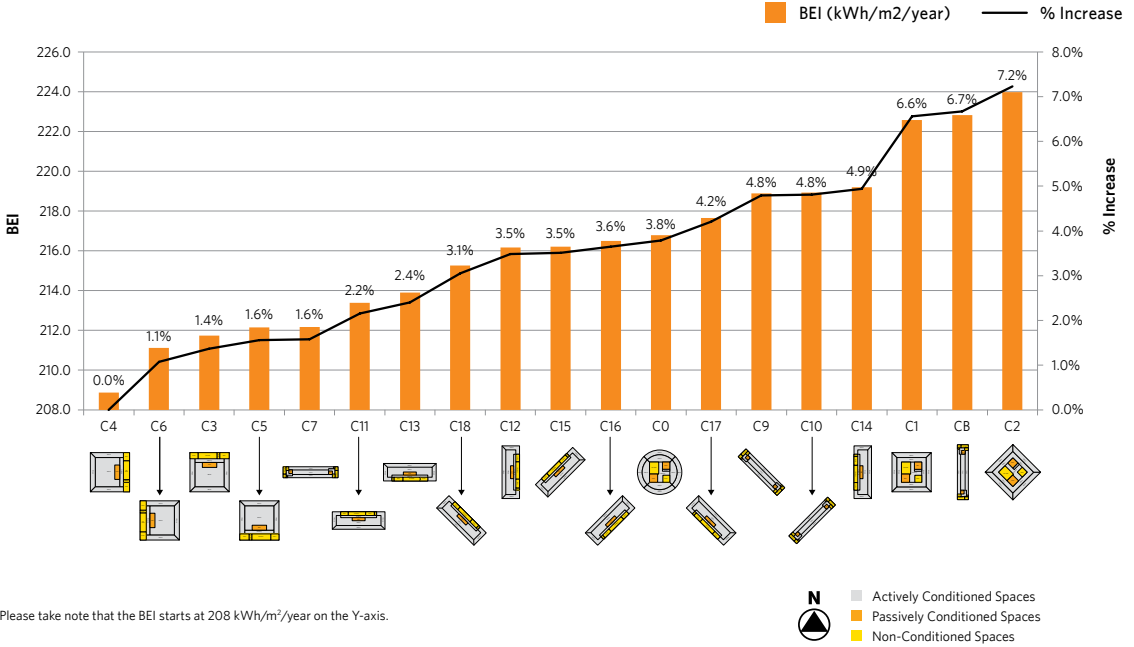
The models in this study showed that it is possible to save up to 7.2% energy based on the selection of building form, core location and orientation. This study showed that the most significant factor for lowering building energy consumption in a building is the glazing area. Although the external façade's window-to-wall ratio of the office space is fixed at 70% for every model simulated, the absolute external glazing area (in  $m^2$ ) differs up to 48% between models because of the different location of core spaces.

The second significant factor that impacts the building's energy efficiency is the ability to view out of the building. The view out of a building is computed in this study via the assumption of a person standing in the middle of the building looking out through the external façade (internal partitions are assumed to be invisible/transparent, while opaque external façade is opaque to compute the view out in degrees). A ratio of Building Energy Index (BEI) in  $kWh/m^2$ -year to View Out in degrees was computed to factor in the energy costs for the view out of different building forms, core locations and orientations. The ratio of BEI to View Out (degree) indicates the amount of energy used for each degree of view out for each building model. The lower the value, the less energy is used for each degree of view out. The results from this study indicate that the energy penalty for increasing the view out reduces as the view out is increased. In simple terms - Yes, the energy consumption of the building increases with more view out, but it is not critically bad because the energy penalty for each degree of view out reduces as the view out increases.

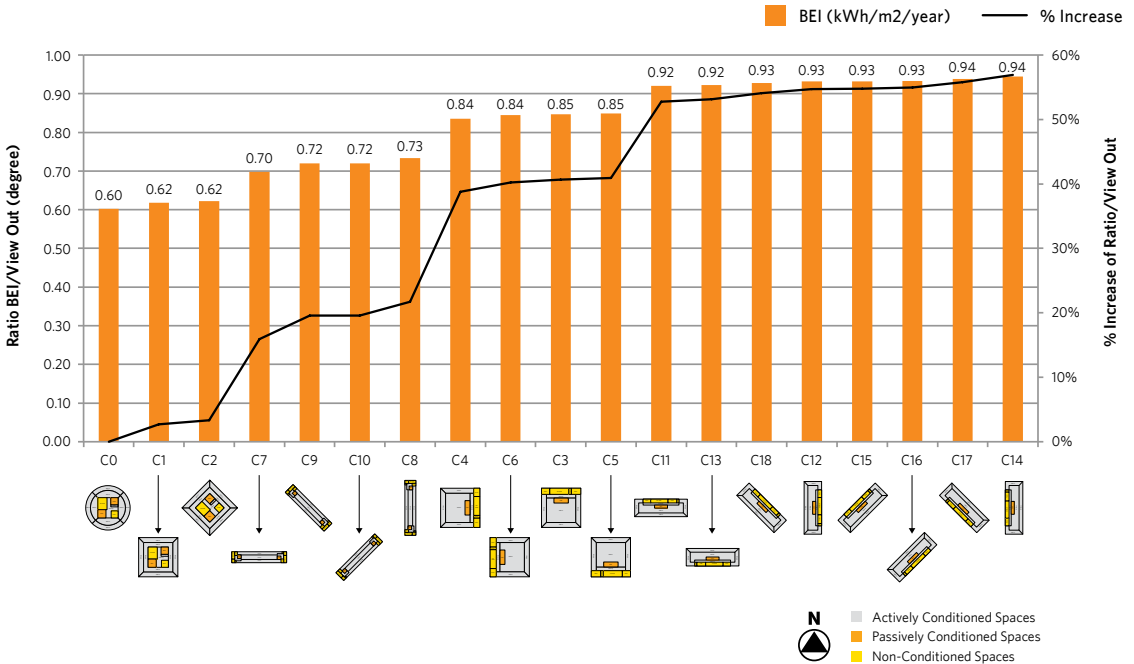
The orientation of the building is also shown to have a significant impact on a building's energy efficiency. The benefit of having a good orientation allowed for a higher glazing area and a better view out while reducing the BEI of the building in certain cases. In short, having the glazing facing North and South will have a lower energy consumption than having the glazing facing East and West.

The additional fan power due to ventilation of the toilet in the center core is accounted for in this study, as well as the infiltration rate of the building due to the wind speed and wind direction. The use of daylight harvesting in the office spaces up to 3.5m depth from the building façade was also taken into account in this study. In addition, the potential daylight use of core spaces such as staircases, toilets and pantries were also accounted for if they are located on the side instead of the center. In short, this study assumed that all the good behaviour for energy efficiency was practiced.

## BUILDING FORM, CORE LOCATION AND ORIENTATION



## RATIO OF BEI/VIEW OUT



# INTRODUCTION

The model were based on a multi-storey office building as a basis for comparison between different options of building form, core location and orientation in the Malaysian climate zone.

The results of any similar study on building form, core location and orientation can be easily tweaked to reflect the preference for one form over another rather easily by the assumptions made. Therefore, the assumptions made in this chapter have to be clearly specified and transparent. In general, this study assumed that all good building design practices are implemented reasonably well. This includes harvesting daylight wherever possible, and natural ventilation wherever feasible as well.

This chapter attempts to find an optimum balance of the benefit of daylight harvesting in office spaces versus having a “buffer zone” of non-air-conditioned spaces to keep solar and conduction heat gain away from air-conditioned office spaces. Spaces such as pantry areas are assumed to be air-conditioned if they are located without access to external windows and naturally ventilated when it has an external window. In addition, it is also assumed that toilets located in the middle of the building require mechanical ventilation to provide 10 air-changes per hour (ACH) while toilets located with external windows was modelled without mechanical ventilation. Natural ventilation was modelled instead for toilets with external windows.

It is also observed in many buildings that daylight harvesting is a fairly common practice for fire escape staircases, pantries and toilets located with external windows and it is modelled as such for this study. However, if these spaces are located away from the façade, the electrical lights for these spaces are assumed to be switched on during occupancy, while fire escape staircase lights are on all the time.

# METHODOLOGY

A medium-rise building of 17 floors is assumed for this study. The floor to floor height is assumed to be 4 meters. The floor areas are as described in the table below.

No	Description	Floor Area	Units	Ventilation Concept
1	Office Floor Area	1,650	m <sup>2</sup> /floor	AC
2	Lift Lobby/Walkway	170	m <sup>2</sup> /floor	AC
3	3 AHU rooms	100	m <sup>2</sup> /floor	AC
4	4 Lift shafts	165	m <sup>2</sup> /floor	NV
5	Pantry	22	m <sup>2</sup> /floor	NV if located with external façade. AC otherwise.
6	2 Fire staircases	72	m <sup>2</sup> /floor	NV
7	Toilets	80	m <sup>2</sup> /floor	NV if located with external façade. 10 ACH otherwise.
<b>Total Area per Floor</b>		<b>2,259</b>	m <sup>2</sup> /floor	
<b>No. of Floors</b>		<b>17</b>	floors	
<b>Total Building GFA</b>		<b>38,403</b>	m <sup>2</sup>	

For each building form, core location and orientation, the air-conditioning system was sized for the peak cooling load. Thereafter a dynamic energy simulation of one full year was conducted to provide the annual energy consumption of the building for each case study.

These assumptions were made in this study to generate a comparison between building forms:

No	Description	Location: Not Connected to any External Wall	Location: Connected with an External Wall
1	<b>Toilet Ventilation Strategy</b>	Mechanically ventilated for 10 ACH as exhaust air. Fan Static Pressure of 2" w.g. (500 Pa) assumed. Combined fan, motor and belt (total) efficiency of 50% assumed. Fan operates during occupancy hours of 9am to 6pm.	100% Natural Ventilation. Window area assumed to be 10% of floor area. Only 50% window area is open for ventilation.
2	<b>Toilet Lighting Strategy</b>	100% electrical lights at 10W/m <sup>2</sup> , switched on during occupancy hours. Occupancy sensor is assumed to be installed. It is assumed that the toilet lights is only switched on 50% of the time during occupancy hours and switched off during non-occupancy hours.	Occupancy sensor is assumed to be installed. It is assumed that the toilet is occupied only 50% of the time during occupancy hours and switched off during non-occupancy hours. 50% of the electrical lights will be switched off whenever the outdoor light level exceeds 15,000 lux.
3	<b>Pantry Lighting Strategy</b>	100% electrical lights at 10W/m <sup>2</sup> , switched on during occupancy hours. Occupancy sensor assumed as well, that will keep the lights switched off 50% of the time.	50% of the electrical lights are switched on during occupancy hours. 50% of the electrical lights are dependent on daylight. Occupancy sensor assumed as well, that will keep lights switched off 50% of the time.
4	<b>Pantry Ventilation Strategy</b>	Air-conditioned as part of Office space with same operating hours of Office space.	100% Natural Ventilation. Window area is assumed to be 10% of floor area. Only 50% window area is open for ventilation.
5	<b>Pantry Small Power</b>	A small 330 watt fridge is on continuously.	A small 330 watt fridge is on continuously.
6	<b>Fire Escape Staircases Lighting Strategy</b>	2 W/m <sup>2</sup> Lights are switched on 24 hours daily.	2 W/m <sup>2</sup> Lights are switched off from 8am to 7pm daily. Window area is assumed to be 10% of floor area. Only 50% window area is open for ventilation.
7	<b>Lift Lobby/Walkway</b>	100% lights at 10 W/m <sup>2</sup> switched on during occupancy hours from 9am to 6pm weekdays. 50% lights on during other hours and weekends. Because this space is air-conditioned, it will always be assumed to be located away from external wall. i.e. since it is an air-conditioned space, locating it with an external wall would give it the same conditions as an office space, which would defeat the purpose of this study.	
8	<b>AHU rooms</b>	Always assumed to be located away from the external wall because it does not benefit in terms of daylight harvesting or view out and because it is also an air-conditioned space.	
9	<b>Office Lighting Strategy</b>	15 W/m <sup>2</sup> switched on from the hours of 9am to 6pm on weekdays. Office spaces with external walls are assumed to harness daylight up to 3.5 meters depth from the façade whenever the outdoor horizontal illumination is higher than 15,000 lux. In addition, 5% lights are assumed switched on during non-occupancy hours in the office space.	
10	<b>Office Small Power</b>	15 W/m <sup>2</sup> peak load is assumed during office hours of 9am to 6pm with 30% dip in power consumption from 12:30 noon to 1:30pm on weekdays. 35% of the peak load is assumed for all other hours.	

The allocation of space is made so that areas that do not need air-conditioning are grouped together. This is useful for this study where the grouping of naturally ventilated spaces can be used as a buffer zone to air-conditioned spaces. However, placement of non-air-conditioned spaces on an external wall also deprives the office space from harvesting daylight for energy efficiency. These factors were all captured in this study.



Other key assumptions:

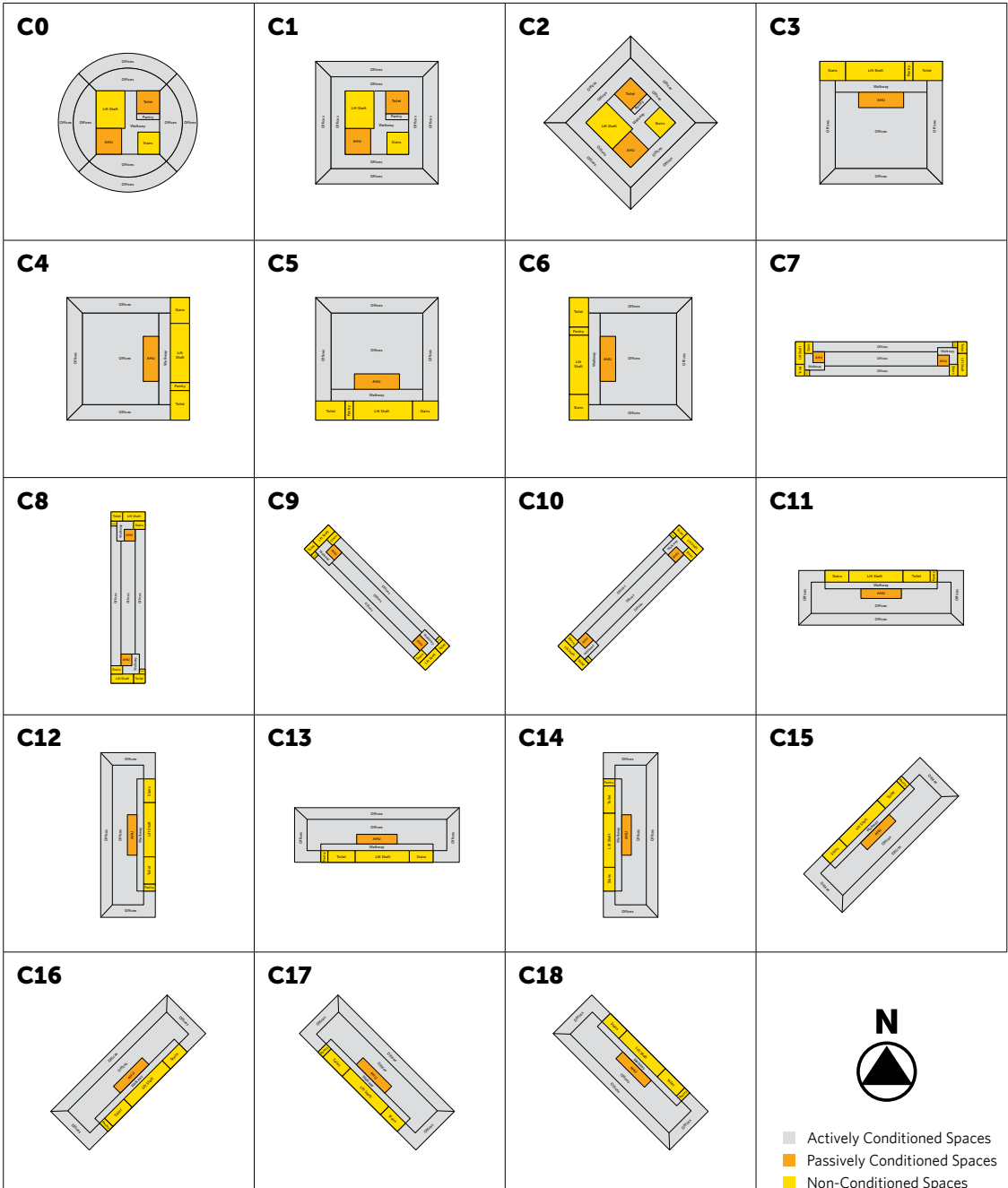
No	Description	Assumptions
1	<b>Windows to wall ratio</b>	70% for façade connected to Office space. Window area assumed to be 10% of floor area for external façade connected to Pantry, Toilet, and Fire Escape Staircase. Note: Locating a non-air-conditioned core space on an external wall will cause the office space to lose one façade to the exterior, losing the view out, reducing the heat gain (70% WWR on one façade is gone) and reducing the potential for daylight harvesting in an office space.
2	<b>Glazing properties</b>	Single glazing tinted. SHGC = 0.65 VLT = 45% U-value 5.7 W/m <sup>2</sup> K
3	<b>External Wall properties</b>	Typical 100mm thick Concrete Wall with 15mm Cement Screed, U-value 3.2 W/m <sup>2</sup> K
4	<b>Internal Wall properties</b>	Typical Internal Brick Wall with Cement Screed, U-value 2.0 W/m <sup>2</sup> K
5	<b>Roof properties</b>	Insulated Flat Roof, Heavy Weight with 50mm polystyrene foam used for a U-value of 0.52 W/m <sup>2</sup> K
6	<b>Ventilation System</b>	VAV Fan Total Pressure: 3" w.g. (750 Pa) Fan Total Efficiency: 65% Turn Down Ratio: 30% Design Off-coil Temperature: 12°C
7	<b>Chill Water System</b>	Variable Primary Flow Pump Total Head: 35m Pump Total Efficiency: 65% Minimum Flow Rate: 70% of peak Chill Water Supply Temperature: 6.7°C Chill Water Return Temperature: 13.4°C
8	<b>Chiller</b>	Multiple Centrifugal Chillers in Parallel. Chiller capacity is identical with an allowable maximum per chiller of 800 ton. COP = 5.7 (0.62 kW/ton)
9	<b>Condenser System</b>	Constant flow at rated condition (3 gpm/ton) Pump Total Head: 30m Pump Total Efficiency: 65% Design Condenser Water Supply Temperature: 29.4°C Design Condenser Delta Temperature: 5.6°K
10	<b>Cooling Tower</b>	Fan power at 0.025 kW/HRT
11	<b>Fresh Air Supply</b>	Ashrae 62.1 (2007)
12	<b>Infiltration</b>	The infiltration rate of the building is based on the assumption of a crack along the window perimeter. Windows are assumed to be 2.8m height (for 70% WWR with ribbon window layout) and each piece of window is 1.2 meters width. It is also assumed that 2 pieces of window is required to make the total height of 2.8 meters. The assumption of crack coefficient is based on 0.13 (l s <sup>-1</sup> m <sup>-1</sup> Pa <sup>-0.6</sup> ) for a weather-stripped hinged window. <sup>1</sup> The simulation study uses the wind pressure coefficients taken from the Air Infiltration and Ventilation Centre's publication <i>Air Infiltration Calculation Techniques - An Applications Guide</i> <sup>2</sup> . These coefficients are derived from wind tunnel experiments.
13	<b>Office Occupancy</b>	Weekdays: 10 m <sup>2</sup> /person, 9am to 6pm, with 50% reduction at lunch time of 12.30 noon to 1.30pm. Weekends: Empty
14	<b>Façade and External Lights</b>	Façade and external lights are ignored in this study because it will be the same for all the buildings and only has a small influence on the total energy consumption of the building.
15	<b>Other Misc Power</b>	All other miscellaneous power use is ignored. These items includes potable water pumps, escalators, security access system, etc. because it will be the same for all the buildings and only have a small influence on the total energy consumption of the building.

<sup>1</sup> An Analysis and Data Summary of the AIVC's Numerical Database. Technical Note AIVC 44, March 1994. Air Infiltration and Ventilation Centre.

<sup>2</sup> Air Infiltration Calculation Techniques - An Applications Guide, Air Infiltration and Ventilation Centre. University of Warwick Science Park. Sovereign Court, Sir William Lyons Road, Coventry CV4 7EZ.

# TEST CASES


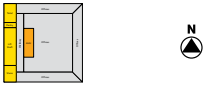
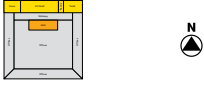
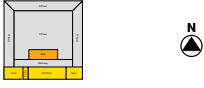



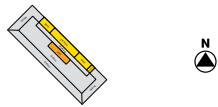

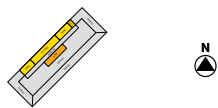
19 building forms, core locations and orientations were created for this study. These test cases are presented below:



# TEST RESULTS

Case	Total Energy (MWh)	Solar Gain (MWh)	Infil. Sensible (MWh)	Infil. Latent (MWh)	Chillers energy (MWh)	AHU energy (MWh)	Chill Water Pumps energy (MWh)	Heat rej fans/pumps energy (MWh)	Total Lights energy (MWh)	Total Small Power energy (MWh)	Office Glazing Areas (m <sup>2</sup> )	BEI (kWh/m <sup>2</sup> -year)	View Out (deg)	Ratio of BEI/View Out
C0	6,081	2,811	9.4	73.7	1,845	596	64	619	1,046	1,911	8,032	216.8	360	1.66
C1	6,243	3,309	5.7	60.1	1,972	628	61	678	994	1,911	9,050	222.6	360	1.62
C2	6,282	3,340	5.8	60.2	1,995	632	60	691	994	1,911	9,050	224.0	360	1.61
C3	5,939	2,314	3.5	41.5	1,762	524	59	595	1,088	1,911	6,107	211.7	250	1.18
C4	5,859	2,057	3.9	41.1	1,716	508	58	578	1,088	1,911	6,107	208.9	250	1.20
C5	5,951	2,292	3.5	41.4	1,774	506	55	617	1,088	1,911	6,107	212.1	250	1.18
C6	5,922	2,292	3.4	41.2	1,753	517	59	593	1,088	1,911	6,107	211.1	250	1.18
C7	5,951	2,698	5.6	54.4	1,827	552	62	613	987	1,911	8,254	212.2	304	1.43
C8	6,250	3,363	4.4	56.1	2,007	560	54	731	987	1,911	8,254	222.8	304	1.36
C9	6,140	3,011	5.3	55.2	1,941	558	55	689	987	1,911	8,254	218.9	304	1.39
C10	6,141	3,105	5.0	55.5	1,941	571	58	673	987	1,911	8,254	218.9	304	1.39
C11	5,985	2,691	7.2	66.0	1,826	539	63	612	1,034	1,911	7,754	213.4	232	1.09
C12	6,063	2,742	7.1	66.1	1,873	538	56	652	1,034	1,911	7,754	216.2	232	1.07
C13	6,000	2,665	8.2	67.8	1,833	536	58	629	1,034	1,911	7,754	213.9	232	1.08
C14	6,148	3,023	7.7	68.9	1,921	554	59	670	1,034	1,911	7,754	219.2	232	1.06
C15	6,065	2,919	7.5	68.4	1,872	555	64	628	1,034	1,911	7,754	216.2	232	1.07
C16	6,073	2,718	7.6	65.8	1,878	537	56	657	1,034	1,911	7,754	216.5	232	1.07
C17	6,105	2,876	7.9	68.8	1,896	542	57	665	1,034	1,911	7,754	217.7	232	1.07
C18	6,038	2,703	7.4	65.2	1,857	543	59	634	1,034	1,911	7,754	215.3	232	1.08


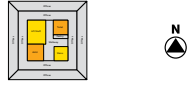
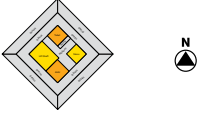

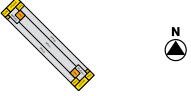
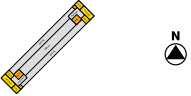
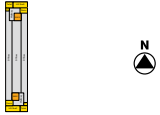
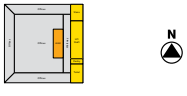
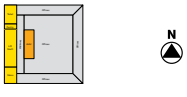
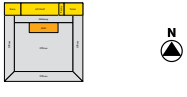
## RANKING BASED ON BEI (kWh/m<sup>2</sup>-year)

Ranking	Case	Plan View	BEI (kWh/m <sup>2</sup> -year)	% Increase	Office Space Glazing Area (m <sup>2</sup> )	View Out (degrees)
1	C4		208.9	Base	6,107	250
2	C6		211.1	1.1%	6,107	250
3	C3		211.7	1.4%	6,107	250
4	C5		212.1	1.6%	6,107	250
5	C7		212.2	1.6%	8,254	304
6	C11		222.6	6.6%	7,754	232
7	C13		222.6	6.6%	7,754	232
8	C18		222.6	6.6%	7,754	232
9	C12		222.6	6.6%	7,754	232
10	C15		222.6	6.6%	7,754	232

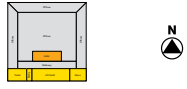
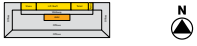

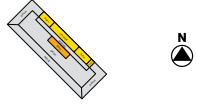
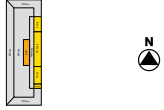
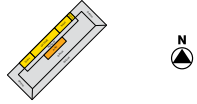
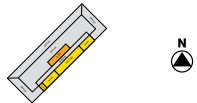
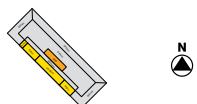
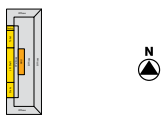
## RANKING BASED ON BEI (kWh/m<sup>2</sup>-year)

Ranking	Case	Plan View	BEI (kWh/m <sup>2</sup> -year)	% Increase	Office Space Glazing Area (m <sup>2</sup> )	View Out (degrees)
11	C16	 	222.6	6.6%	7,754	232
12	C0	 	216.8	3.8%	8,032	360
13	C17	 	222.6	6.6%	7,754	232
14	C9	 	218.9	4.8%	8,254	304
15	C10	 	222.6	6.6%	8,254	304
16	C14	 	222.6	6.6%	7,754	232
17	C1	 	222.6	6.6%	9,050	360
18	C8	 	222.8	6.7%	8,254	304
19	C2	 	224.0	7.2%	9,050	360

## RANKING BASED ON RATIO OF BEI / VIEW OUT

Ranking	Case	Plan View	Ratio BEI/ View Out	% Decrease	View Out (degrees)	BEI (kWh/ m <sup>2</sup> -year)	Office Glazing Area (m <sup>2</sup> )
1	C0		<b>0.60</b>	0.0%	360	216.8	8,032
2	C1		<b>0.62</b>	-2.6%	360	222.6	9,050
3	C2		<b>0.62</b>	-3.2%	360	224.0	9,050
4	C7		<b>0.70</b>	-13.7%	304	212.2	8,254
5	C9		<b>0.72</b>	-16.4%	304	218.9	8,254
6	C10		<b>0.72</b>	-16.4%	304	218.9	8,254
7	C8		<b>0.73</b>	-17.8%	304	222.8	8,254
8	C4		<b>0.84</b>	-27.9%	250	208.9	6,107
9	C6		<b>0.84</b>	-28.7%	250	211.1	6,107
10	C3		<b>0.85</b>	-28.9%	250	211.7	6,107

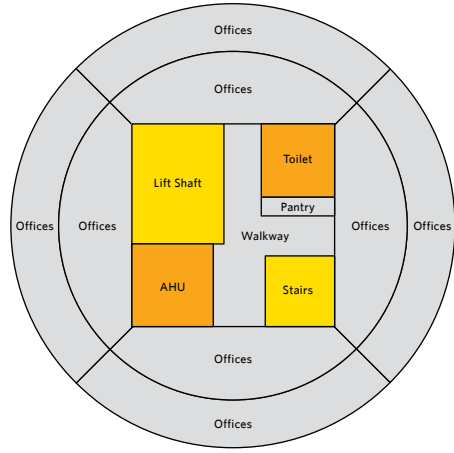
## RANKING BASED ON RATIO OF BEI / VIEW OUT

Ranking	Case	Plan View	Ratio BEI/ View Out	% Decrease	View Out (degrees)	BEI (kWh/ m <sup>2</sup> -year)	Office Glazing Area (m <sup>2</sup> )
11	C5		<b>0.85</b>	-29.0%	250	212.1	6,107
12	C11		<b>0.92</b>	-34.5%	232	213.4	7,754
13	C13		<b>0.92</b>	-34.7%	232	213.9	7,754
14	C18		<b>0.93</b>	-35.1%	232	215.3	7,754
15	C12		<b>0.93</b>	-35.4%	232	216.2	7,754
16	C15		<b>0.93</b>	-35.4%	232	216.2	7,754
17	C16		<b>0.93</b>	-35.5%	232	216.5	7,754
18	C17		<b>0.94</b>	-35.8%	232	217.7	7,754
19	C14		<b>0.94</b>	-36.3%	232	219.2	7,754

# DETAILED LAYOUT OF EACH CASE SCENARIO

The following pages provide further information that is adequate for this study to be repeated.

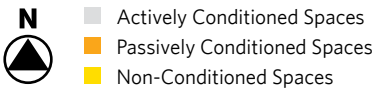
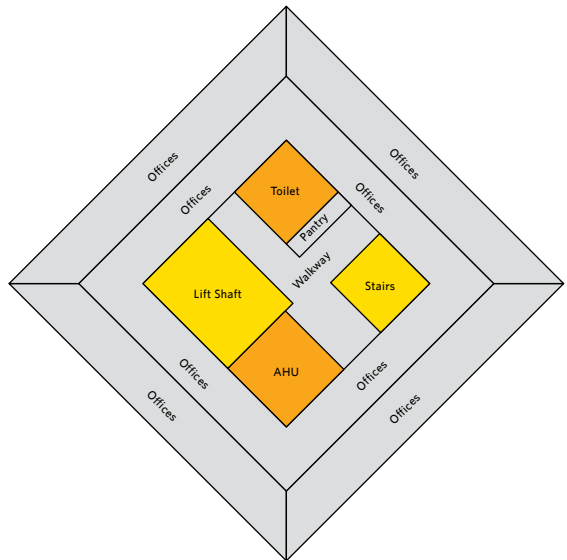
## C0 ROUND BUILDING CENTER CORE



## C1 SQUARE BUILDING CENTER CORE

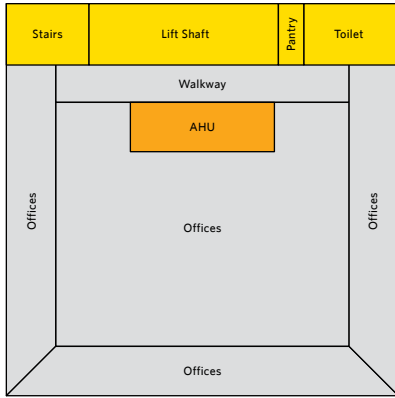


## C2 SQUARE BUILDING CENTER CORE DIAGONAL

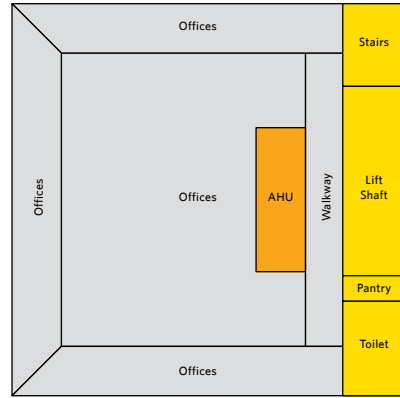




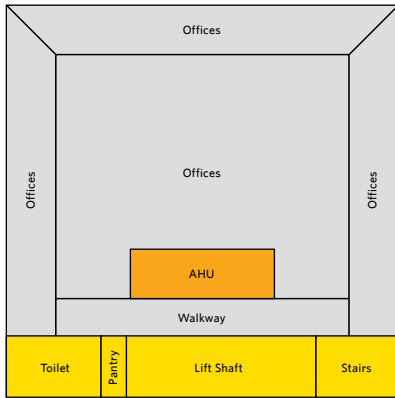
**C3**  
SQUARE BUILDING SIDE CORE ON NORTH



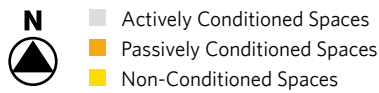
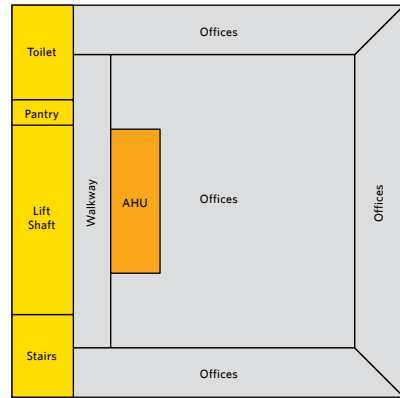
**C4**  
SQUARE BUILDING SIDE CORE ON EAST



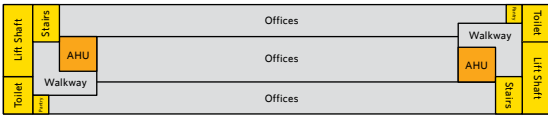
**C5**  
SQUARE BUILDING SIDE CORE ON SOUTH



**C6**  
SQUARE BUILDING SIDE CORE ON WEST



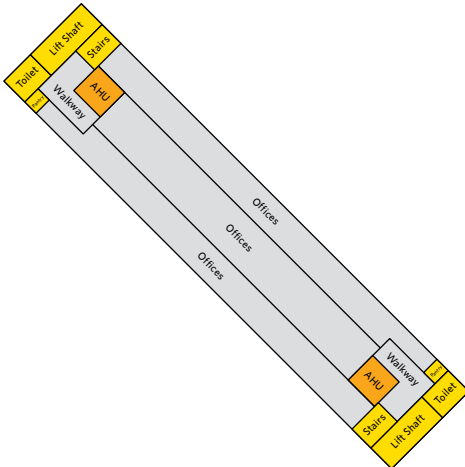
**C7**  
ASPECT RATIO 1:5, CORE ON EAST/WEST



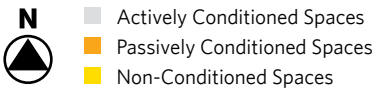
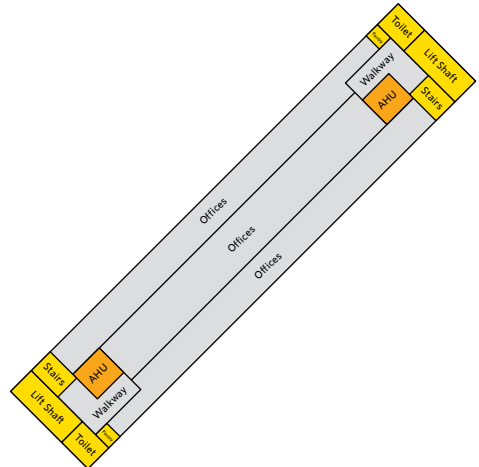
**C8**  
ASPECT RATIO 1:5, CORE ON NORTH/SOUTH



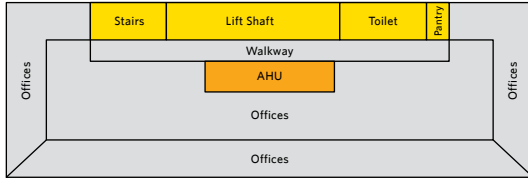
**C9**  
ASPECT RATIO 1:5  
CORE ON NORTH-WEST/SOUTH EAST



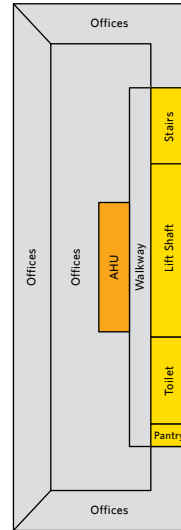
**C10**  
ASPECT RATIO 1:5  
CORE ON NORTH-EAST/SOUTH-WEST



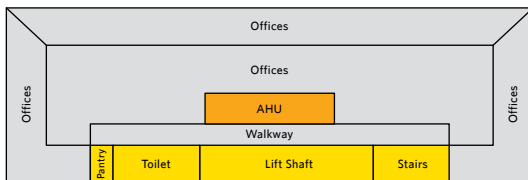
**C11**  
ASPECT RATIO 1:3, CORE ON NORTH



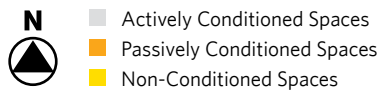
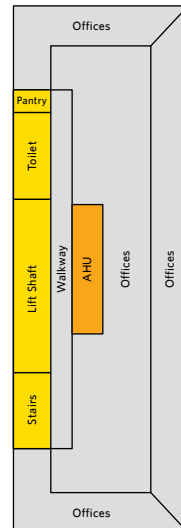
**C12**  
ASPECT RATIO 1:3  
CORE ON EAST



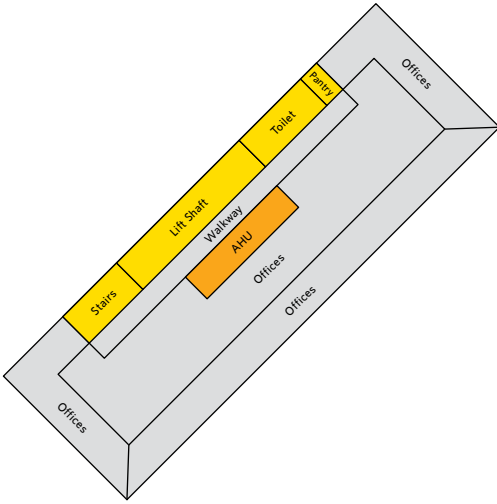
**C13**  
ASPECT RATIO 1:3, CORE ON SOUTH



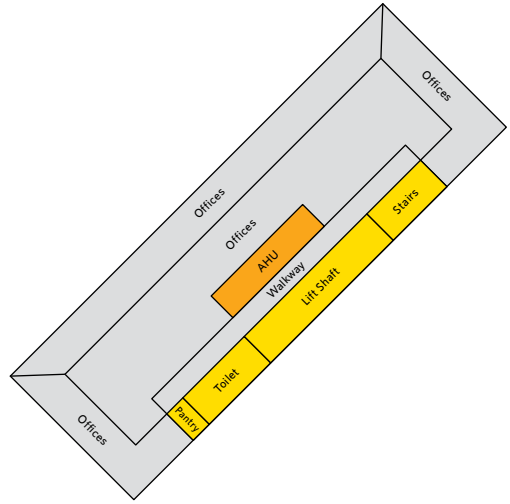
**C14**  
ASPECT RATIO 1:3  
CORE ON WEST



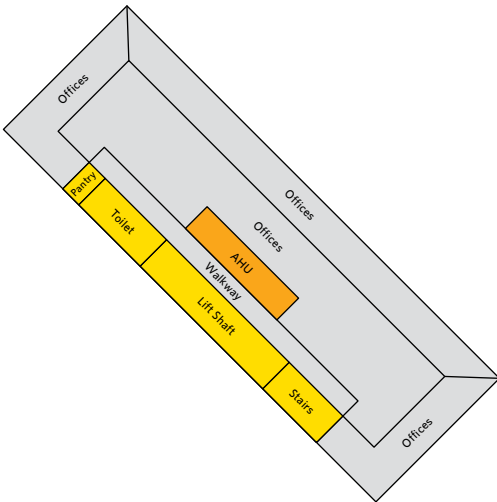
**C15**  
ASPECT RATIO 1:3, CORE ON NORTH-WEST



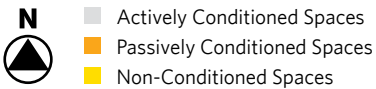
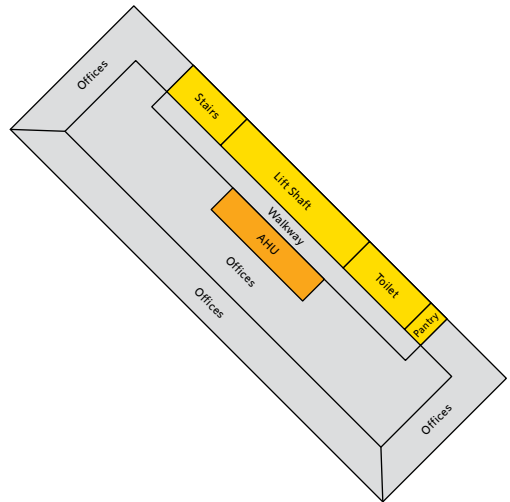
**C16**  
ASPECT RATIO 1:3, CORE ON SOUTH-EAST



**C17**  
ASPECT RATIO 1:3, CORE ON SOUTH-WEST



**C18**  
ASPECT RATIO 1:3, CORE ON NORTH-EAST



# BUILDING MODEL

**TOTAL 186 ZONES CREATED FOR CASE 0**



# WEATHER DATA

The hourly weather data of Kuala Lumpur used in this chapter was based on a Test Reference Year (TRY)<sup>1</sup> weather data developed in University Teknologi Malaysia (UiTM) under the DANCED (Danish International Assistant) project for Energy Simulations for Buildings in Malaysia. The TRY is based on 21 years (1975 to 1995) of weather data from the Malaysian Meteorological Station in Subang, Klang Valley, Selangor.

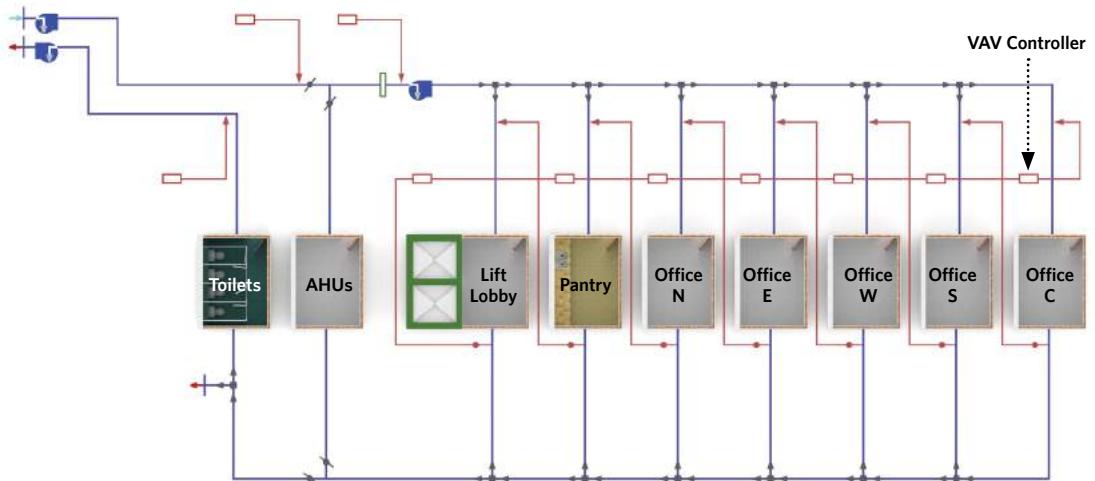
It should be noted that a typical energy simulation program requires two extra data values that were not collected by the Malaysian Meteorological Service, namely the direct and diffuse radiation. The missing radiation data was calculated for the TRY via Erbs' Estimation Model from the horizontal global solar radiation.

Although not perfect, the TRY is currently the only known set of weather data for energy simulation that was compiled based on statistical analysis and it has been used in many energy simulations of various buildings in Malaysia with satisfactory results.

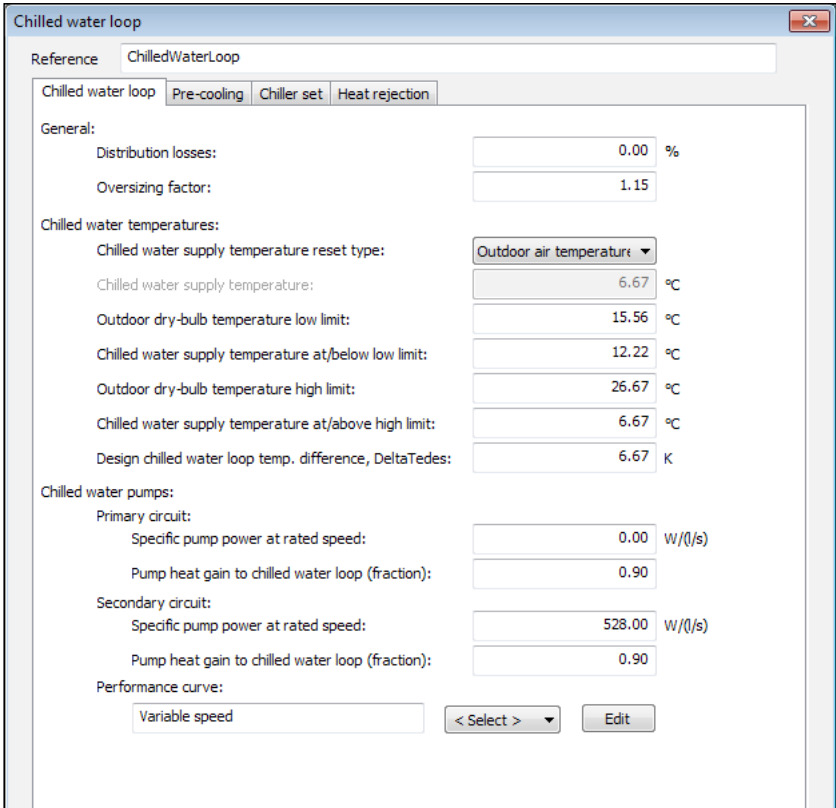
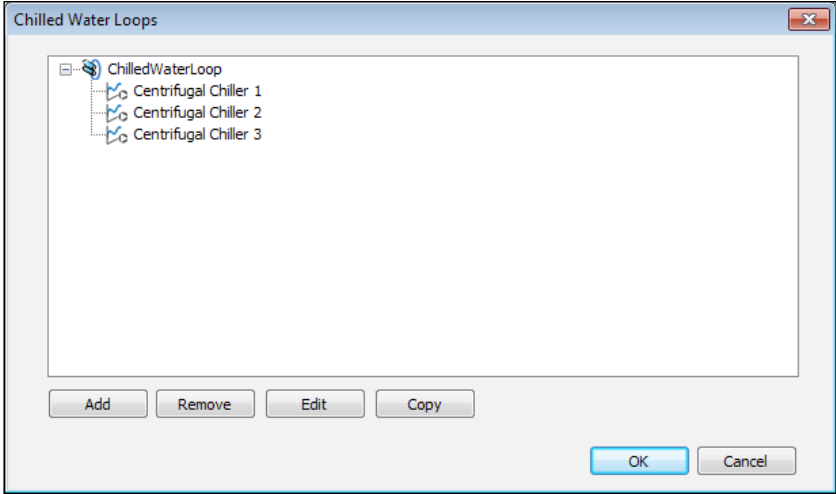
For more details please refer to Chapter 2, page 31.

# HVAC DETAILS OF CASE 0

**AIR SIDE DETAILS PER FLOOR**



WATER SIDE – 3 CHILLERS





**Electric water cooled chiller** ✕

Selected chiller definition

Generally: Reference:

Fuel:

**Chiller**

Operational model: Chiller model description

Rated condition is Design condition

Cooling capacity curve,  $f_{CAPtt}(T_{let}, T_{ect})$   
 < Select > Edit

EIR (water temp dependence) curve,  $f_{EIRtt}(T_{let}, T_{ect})$   
 < Select > Edit

EIR (part-load dependence) curve,  $f_{EIRpt}(p, T_{ect} - T_{let})$   
 < Select > Edit

Minimum part-load ratio for continuous operation:

Compressor heat gain to condenser water loop (fraction):

**Design condition** Rated condition

Chiller:	Cooling capacity, $Q_{des}$ :	<input type="text" value="2236.640"/> kW	A
	Coeff of performance, $COP_{des}$	<input type="text" value="5.70"/>	
Condenser water:			
Entering temp, $T_{ectdes}$ :	<input type="text" value="29.44"/> °C	$V_c/Q_{des}$ :	<input type="text" value="0.05"/> l/s/kW
Flow rate, $V_c$ :	<input type="text" value="113.14"/> l/s	$\Delta T_{cdes}$ :	<input type="text" value="5.56"/> K
Chilled water:			
Supply temp, $T_{letdes}$ :	<input type="text" value="6.67"/> °C	$V_e/Q_{des}$ :	<input type="text" value="0.04"/> l/s/kW
Flow rate, $V_e$ :	<input type="text" value="80.22"/> l/s	$\Delta T_{edes}$ :	<input type="text" value="6.67"/> K

---

END OF CHAPTER 3



CHAPTER

# 4

## DAYLIGHT HARVESTING





## 4

# DAYLIGHT HARVESTING

## INTRODUCTION

Daylight in buildings has been credited to improve the academic performance of students, lower staff sick leaves, shorten the period that in-house patients stay in hospital, increase retail stores sales and so much more.<sup>1</sup> Many studies on the improved performance of building occupants due to the availability of daylight have been performed and documented worldwide. In fact in many European countries today, it is illegal to provide office spaces without access to daylight.

Daylight harvesting in a building may seem to be a very simple task but it is a subject that needs to be mastered well in order to be successfully implemented in this climate zone. There are many design issues that need to be adequately addressed. An attempt is made in this chapter to address all the key issues related to daylight harvesting within the context of the Malaysian climate.

Unfortunately, harvesting daylight for its health benefits and energy efficiency in this climate is not as simple as providing large window areas on the building. Proper tropical climate daylight harvesting design skills need to be developed to gain the optimum benefits from daylight. Improper daylight harvesting design may cause glare discomfort, excessive heat gain, increased thermal discomfort and high energy consumption in buildings. The “quality” of the harvested daylight is as critical to be considered as the “quantity” of daylight harvested. Building occupants will benefit from having properly designed daylight harvesting features that provide a better working environment and increase the energy efficiency in the building.

<sup>1</sup> Peter Boyce, Claudia Hunter, Owen Howlett. The Benefits of Daylight through Windows, U.S. Dept of Energy, New York State Energy Research & Development Authority, California Energy Commission, 2003.

# DAYLIGHT AVAILABILITY

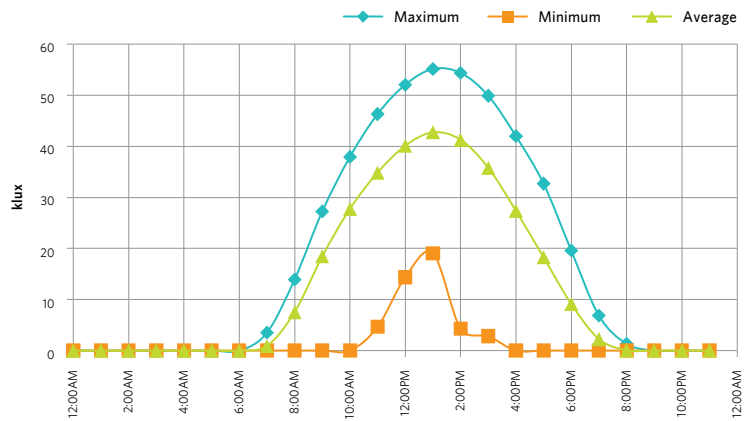
The tropical Malaysian climate is ideal for daylight harvesting to be practiced in office buildings because daylight is consistently available daily from the hours of 8am to 6pm. Since Malaysia is located near the equator, there is hardly any seasonal variation that changes the daily availability of daylight.

The daylight availability in lux level from diffuse light can be approximated using the average luminous efficacy of diffuse daylight of 120 lm/watt<sup>2</sup>. This luminous efficacy is then applied to the diffuse solar radiation data found in the Test Reference Year (TRY) weather data (Chapter 2) to provide **Chart 4.1**.

**Chart 4.1** shows that on average, the diffuse light available at 8am and 6pm is approximately 12,000 lux and 9,000 lux respectively. The average peak diffuse light available is 50,000 lux at noon. More interestingly, the average minimum daily light available is above 10,000 lux from the hours

of 10am to 4pm. Since the required lux level in office spaces is between 300 to 400 lux<sup>3</sup>, the chart below indicates that only a small fraction of the available outside light needs to be harvested for indoor use from the hours of 8am to 6pm.

**CHART 4.1 | DIFFUSE DAYLIGHT AVAILABILITY FROM THE TEST REFERENCE YEAR (TRY) WEATHER DATA**



# DAYLIGHT FACTOR

A daylight factor is a measure of a reference point of the available daylight indoor versus the available daylight outdoors during an overcast sky condition. For example, if the daylight factor at the center of a table is 2%, it means that if the outdoor horizontal surface (without obstructions) is measured to be 10,000 lux level, the center of the table will have 400 lux on it, during an overcast sky condition. The equation of daylight factor is shown below:

$$DF = \frac{E_{\text{internal}}}{E_{\text{external}}} \times 100\%$$

Where:

- DF** = Daylight Factor (%)
- E<sub>internal</sub>** = Horizontal Illumination of reference point indoor (Lux)
- E<sub>external</sub>** = Horizontal Illumination of unobstructed point outdoor in an overcast sky condition (Lux)

The daylight factor is described here because this is an indicator that is simple to understand, easy to use and offers reasonable accuracy for the Malaysian tropical climate.

<sup>2</sup> T.Muneer. Solar Radiation and Daylight Models. Napier University, Edinburgh. 1997  
<sup>3</sup> MS1525 (2007)

# ACCLIMATISATION OF THE DAYLIGHT FACTOR TO MALAYSIA

There have been recent discussions within the industry that the daylight factor is not an accurate way to measure the daylight availability for an indoor space. This issue was raised based on a paper published by Mardaljevic called Climate-Based Daylight Modelling.<sup>4</sup> The case put forward by this paper states that useful daylight illuminance based on the climate should be used as a replacement for the flat daylight factor requirement. This paper was presented as a critique of certain green guidelines that fixed a daylight factor of 2% as the minimum requirement for daylight harvesting without consideration of the local climate. In agreement with this paper, the minimum daylight factor requirement for Malaysia has to be acclimatised to the Malaysian climate, because a daylight factor of 2% can mean significantly different illumination levels for different climatic zones.

The tropical climate in Malaysia is typically cloudy during the daytime (Chapter 2), whereas in temperate climate zones, the sky is typically clear (blue sky). In a clear blue sky condition, the amount of daylight provided by the sky dome is skewed significantly according to the position of the sun, where the blue sky part (without sun) does not provide much daylight at all. Due to the fact that the daylight factor is computed based on an overcast sky condition (where daylight is distributed from all directions of

It is reasonably accurate to use the daylight factor as a measurement of daylight availability in this climate zone

the sky dome), a daylight factor of 2% is very different for an office space facing the sun and an office space facing the blue sky.

In a cloudy sky conditions such as Malaysia's, the direct sunlight is diffused by the clouds, causing the entire sky dome to be bright and thereby providing diffuse daylight from the entire sky dome. In this case, the tropical sky of Malaysia is similar to an overcast sky condition that is used to compute the daylight factor. Therefore, it is reasonably accurate to use the daylight factor as a measurement of daylight availability in this climate zone.

While it is true that more daylight can be harvested from the direction where the sun is positioned, it is not desirable to do so in this climate, because of the high heat gain associated with direct sunlight and other uncomfortable conditions caused by it.

The minimum daylight factor requirement for Malaysia has to be acclimatised to the Malaysian climate, because a daylight factor of 2% can mean significantly different illumination levels for different climatic zones

<sup>4</sup> 2006, Examples of Climate-Based Daylight Modelling by John Mardaljevic, Institute of Energy and Sustainable Development (IESD), De Montfort University, UK. CIBSE National Conference 2006: Engineering the Future.



The proposed method by Mardaljevic of conducting simulation studies based on a full year of climate data would provide a better estimate of daylight availability. However, it is both time consuming and requires design skills that are not known to many building designers in Malaysia at this point in time. Short of conducting such studies, the diffuse radiation data of Malaysia (Chapter 2) can be analysed (using an average diffuse daylight luminous efficacy of 120 lm/watt) to provide the percentage of hours in a year that will provide adequate illumination. This data is provided in **Charts 4.2 to 4.4**. The figure of 100 lux level is provided in **Chart 4.2** based on Mardaljevic's recommendation of useful daylight with an illumination level between 100 lux to 2,000 lux.

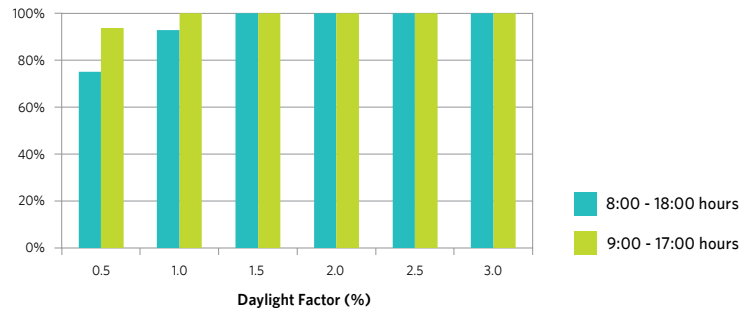
**Chart 4.2** shows that with a daylight factor of 0.5%, over 70% of the hours of 8am to 6pm will have an illuminance level higher than 100 lux. From the hours of 9am to 5pm, at a daylight factor of 0.5%, more than 90% of the hours are above the 100 lux level. In summary, only a small fraction of the outdoor light is required indoors to maintain an illumination level above 100 lux during the daytime in Malaysia.

For an office building, where the minimum of a 300 lux level is recommended by the Malaysian Standard MS1525, **Chart 4.3** is provided as a reference. It has been observed that in many situations where daylight harvesting is used, a lower lighting level below 300 lux is still found to be acceptable by Malaysian building occupants. Therefore, if the building's electrical lighting system requires manual intervention to switch the lights on, the percentage of daylight hours used will be significantly higher than the predicted hours in **Chart 4.3** for an office environment because most building occupants would allow the illumination level to drop below 200 lux before switching the electrical lights on.

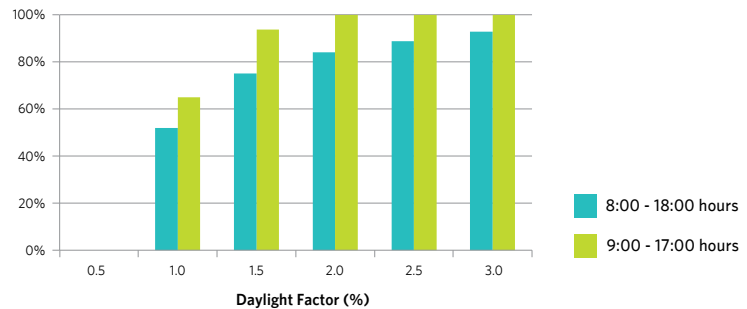
It is also useful to provide an estimate of percentage of hours where a certain daylight factor is above 2,000 lux, as in provided in **Chart 4.4** below. An illuminance level of 2,000 lux has been proposed by Mardaljevic as the upper limit of useful daylight. High illuminance levels may cause discomfort glare to sensitive people

reading from a white sheet of paper. It is shown from **Chart 4.4** that a space with a daylight factor of 4% will have less than 5% of the hours above 2,000 lux while a daylight factor of 6% and higher will provide an illumination level above 2,000 lux for more than 50% of the daytime hours.

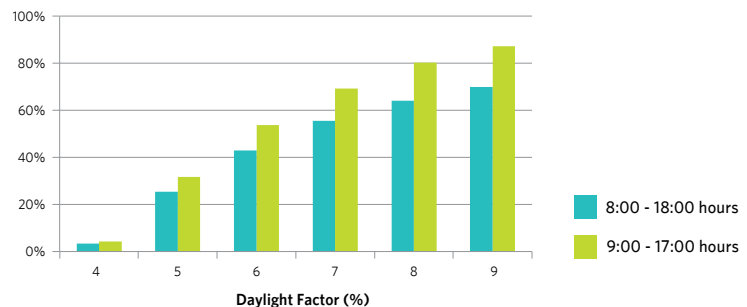
**CHART 4.2 | PERCENTAGE OF HOURS WHERE THE DAYLIGHT FACTOR OF DIFFUSE LIGHT EXCEEDS 100 LUX LEVEL**



**CHART 4.3 | PERCENTAGE OF HOURS WHERE THE DAYLIGHT FACTOR OF DIFFUSE LIGHT EXCEEDS 300 LUX LEVEL**



**CHART 4.4 | PERCENTAGE OF HOURS WHERE THE DAYLIGHT FACTOR OF DIFFUSE LIGHT EXCEEDS 2,000 LUX LEVEL**



# KEY PRINCIPLES OF DAYLIGHT HARVESTING

## 1 SOLAR HEAT GAIN MINIMISATION

It is a misconception that daylight harvesting requires direct sunlight. In fact, almost all well-designed daylight harvesting systems in the tropical climate utilise only diffuse light and is a testimony that direct sunlight is not the preferred choice for daylight harvesting in this climate.

There are many **DISADVANTAGES** with direct sunlight in the tropical climate. These are:

- Direct sunlight provides too much heat gain, causing discomfort to building occupants.
- Direct sunlight provides too much concentrated light that needs to be diffused well to get a uniform daylight distribution. This will increase the complexity of the design.
- Direct sunlight in the tropics could often appear in the sky one moment and then disappear behind the clouds in the next. These drastic changes are not welcome by building occupants.

The **ADVANTAGES** of using diffuse light for daylight harvesting in the tropical climate are:

- The cloudy skies of the tropics provide a uniform and high level of diffuse light distribution from all directions of the sky.
- Diffuse light is not much affected by the sun appearing in the sky and hiding behind the clouds.
- There is plenty of diffuse light available from a tropical cloudy sky. On a typical day, the outdoor diffuse lighting level in Malaysia exceeds 20,000 lux between 8:30am and 5pm.

## GLAZING TECHNOLOGIES, EXTERNAL AND INTERNAL SHADING

In addition to the advantages of using only diffuse daylight which reduces solar heat gain significantly, solar heat gain reduction can be further improved with any of these 3 options:

### 1 GLAZING TECHNOLOGIES

Glazing technologies are covered extensively in Chapter 5. For daylight harvesting purposes it is important to select glazing with a high Light-to-Solar Gain (LSG) ratio in a tropical climate zone. A high LSG ratio means that the glazing is spectrally selective and only allows the wavelength of cool visible daylight to be transmitted through the glazing and at the same time, rejects UV heat and infrared heat to the outside. Refer to Chapter 5 for details.

### 2 EXTERNAL SHADING DEVICES

External shades are covered extensively in Chapter 6. For daylight harvesting purposes, it is advantageous to use external shades to reduce heat gain for the vision window while at the same time to use them as light-shelves to reflect daylight deep into the building. Read the next section on "Technologies for Daylight Harvesting". In addition, refer to Chapter 6 for details on energy reduction due to the provision of external shades. Architects and engineers should also be mindful of the extra heat gain due to the deflection of daylight from to the use of external light shelves.

### 3 INTERNAL SHADING DEVICES

Internal shades are also covered extensively in Chapter 6. Even in a building where daylight is harvested, internal shades may still be required to reduce glare and provide privacy. The proper selection of internal shades can reduce solar heat gain in a building. Refer to Chapter 6 for details.

## 2 GLARE PREVENTION

One of the key issues of daylight harvesting in a tropical climate is the glare caused by the sky dome. The cloudy tropical sky is consistently bright during the daytime. The constant exposure of building occupants to glare will cause them to have headaches and reduce productivity and performance. Due to glare issues, almost all windows in Malaysia are covered with blinds or curtains. The prevention of glare from the windows can be made by limiting the exposure to direct views of the sky.

## 3 DEEP PENETRATION OF DAYLIGHT

It is also important to allow daylight to penetrate deep into the building. This will ensure that more building occupants have access to the benefits of daylight and at the same time, more electrical lights can be switched off for energy efficiency in the building. Daylight harvesting is one of the key features of some of the most energy efficient buildings in the tropical climate.

## 4 UNIFORM DAYLIGHT DISTRIBUTION

The ratio of the luminance at two points in the field of view is the brightness contrast. For visual comfort, the brightness contrast should not exceed the following values:

Between task and adjacent surroundings	3
Between task and more remote areas	10
Between window and adjacent surfaces	20
Anywhere in the field of view	40

## 6 INTERIOR DESIGN

The interior design of an office space has a significant influence on the final quantity of daylight harvested. Dark coloured interior fit-outs will absorb light, significantly reducing daylight levels in spaces by up to 50% or more, while light coloured interior fit-outs will deflect the harvested daylight deeper into the building.

It is also important to consider the placement of furniture and the partition height impact on the daylight harvested. Tall cabinets should be placed away from the windows to allow building occupants access to the daylight and view. High partitions can still be used if they are placed perpendicular to the direction of daylight harvested. Essentially, the interior design layout should ensure that furniture and partitions do not block the path of daylight into the building.

Finally, a *Radiance* simulation study made for this guideline shows that it is possible for the daylight illumination level to reduce by 30% when an office space is fully fitted with furniture as compared to an empty room, indicating that the interior design has a large influence on the quantity of daylight harvested.

## 5 ELECTRICAL LIGHT RESPONSE TO DAYLIGHT HARVESTED

It is equally important to ensure that the design of the electrical lighting circuitry would allow the electrical lights to be switched off at spaces where daylight is harvested. In places where building occupants are aware of energy efficiency and benefits of daylight, a manual switch that allows them to switch the electrical lights on and off will be adequate. This good operational behaviour is seen to be practiced in most, if not all, public schools in Malaysia.

However in Malaysia, this good operational practice in schools has not passed on to office buildings. In buildings where the occupants cannot be reliably depended on to switch electrical lights off when daylight is adequate, photosensors are required to be used. The most economical way of operating electrical lights with a photosensor in a daylight space is based on a strategy of 'auto-off' and 'manual-on'. This means that the electrical lights should be automatically switched off by the photosensor when daylight is adequate but have to be manually switched on by the building occupants when it gets dark.

### DIMMABLE LIGHTS

It will provide a better indoor environmental quality with the provision of dimmable lights that automatically adjust to provide a consistent brightness in lux value. However, it is not really required in this climate because the hours when dimming is required (hours where outdoor diffuse light is above 0 lux and below 10,000 lux) is very short. Refer to **Chart 4.1**.

### POSITION OF LIGHT SWITCHES

The position of the light switch for manual control of the electrical lights in response to daylight is an important factor that influences if it will happen in practice or not. The manual light switch should be positioned for easy access by building occupants, requiring minimum effort to switch the electric lights off when daylight is available.



## 7 DESIGN TOOLS

There are two (2) general categories of design tools for daylight harvesting. These are:

### 1 MANUAL TABLES AND CHARTS

There are many tables and charts available to manually estimate the daylight factor in buildings. One of the better known manual methods is a set of protractors provided by the Building Research Establishment (BRE). The BRE (formerly the Building Research Station BRS) developed a set of protractors which give a direct reading of the sky components in percentages.

However, these existing tables and charts available to estimate the daylight factor in buildings does not include glare protection devices in place. In climates such as Malaysia, where the cloud cover is high and the sky is always bright, it is nearly impossible to harvest daylight without glare protection devices in place.

The provision of glare protection devices will reduce the actual daylight factor provided by existing manual tables and charts. In this chapter, the section on “Daylight Harvesting from the Façade” is provided as a simple rule-of-thumb in buildings where horizontal blinds are used to provide glare protection, while harvesting daylight.

### 2 COMPUTER SIMULATION (Radiosity or Ray-trace)

There are many computer programs in the market that can predict the daylight factor in buildings. Many computer programs use the radiosity method to compute the daylight factor in buildings. Software such as *Dialux*, *Flucs* and *Relux* uses radiosity methods. Another well-known method of modelling the daylight factor in buildings is the ray-tracing method. The ray-tracing method is used by *Radiance* and *Relux* software.

Mardaljevic has recommended that complex daylight studies be conducted using the *Radiance* based computer program. An extract of his statement is provided below.

*“Radiance can model a wide range of material types e.g., specular and semi-specular reflectors, re-directing prisms, bidirectional reflection-transmission distribution functions, etc., all of which can be based on realistic physical models. There are of course a range of simpler modelling approaches available. These invariably contain fundamental restrictions e.g., small number of polygons for the building model, diffuse-only reflecting surfaces, uniform or overcast-only sky models without sun, etc. For demanding situations, simple tools may offer only partial solutions of questionable accuracy, or may not even work at all.” – Dr. John Mardaljevic*

*“RADIANCE is a highly accurate ray-tracing software system for UNIX computers that is licensed at no cost in source form. Radiance was developed with primary support from the U.S. Department Of Energy and additional support from the Swiss Federal Government. Copyright is held by the Regents of the University of California.” – <http://radsite.lbl.gov/radiance/>*

*Radiance* in its raw form is free and requires text input to conduct a simulation study. Fortunately, many software developers have developed a front-end (graphical input) to support inputs into *Radiance*. Some of the better known front-ends to *Radiance* are:

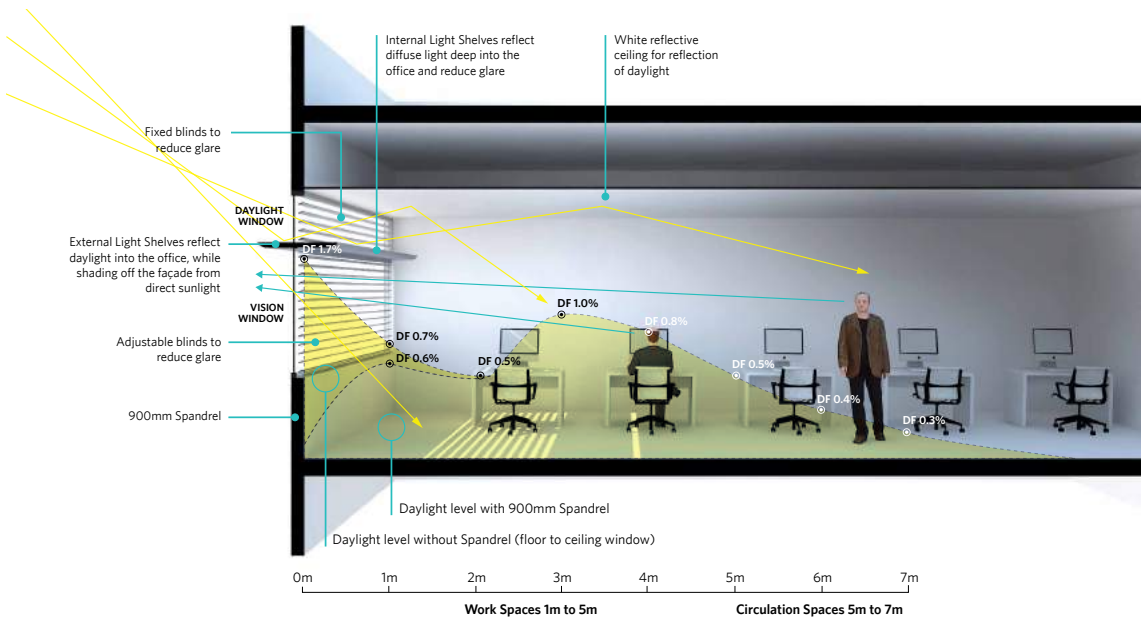
- IES-Radiance
- DesignBuilder
- Ecotect
- Diva for Rhino

# TECHNOLOGIES FOR DAYLIGHT HARVESTING

## 1 “CLASSIC” DAYLIGHT HARVESTING FOR THE TROPICAL CLIMATE

The split window design for daylight harvesting from the façade is the “classic” approach to daylight harvesting. This design consist of a lower ‘vision’ window and an upper ‘daylight’ window that is separated by external and/or internal light shelves as shown below.

**FIGURE 4.1 | CLASSIC DAYLIGHT HARVESTING STRATEGY FROM A VERTICAL FAÇADE**



The lower ‘vision’ window is provided for the view out by the building occupants. These windows should be provided with blinds to reduce the daylight level and to provide privacy near to the façade for the building occupants.

The upper ‘daylight’ window is required to have glare protection devices in place to prevent glare from the harvested daylight. The rule-of-thumb for glare protection from a daylight window is to ensure that building occupants have less than a 10% view of the outdoor sky, because the main source of glare in Malaysia is the bright sky dome. However, it is also possible that neighbouring buildings or landscape with reflective surfaces may be a source of glare as well. Architects are recommended to design the building to suit the conditions at the site.

Another critical source of glare is direct sunlight. Windows that are not directly facing north and south in Malaysia will definitely receive direct sunlight at some point in the day. In such cases, it is recommended that glare protection devices be provided on daylight windows to prevent a 100% view of

the direct sunlight. A fixed blind design in such cases would reduce the quantity of diffuse daylight harvested, while movable blinds would allow the gaps between the blinds to be adjusted when they are not exposed to direct sunlight to allow for a higher amount of daylight to be harvested.

The provision of glare protection devices will reduce the amount of daylight harvested. A balance between glare protection and daylight harvesting needs to be done carefully to ensure that the design of the daylight harvesting system will perform as intended. A detailed lighting simulation study is highly recommended whenever advanced daylight harvesting strategies are considered.

Finally, the external and internal light shelves provided should be specular and reflective on the top to deflect daylight deep into the building while the bottom part should be matte to diffuse any possible reflected light on it, to prevent it from becoming a source of glare to the building occupants.

## 2 EXTERNAL LIGHT SHELVES

External light shelves have the advantage of capturing more daylight from outside the building and deflecting it deeper into the required space. It also helps to reduce the light level near the façade to reduce the brightness contrast in the room.

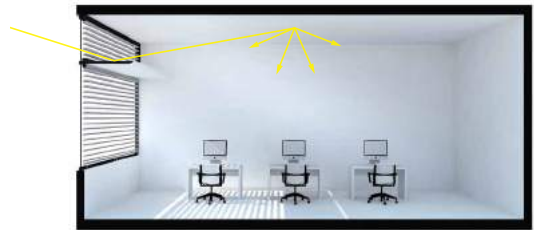
**FIGURE 4.2 | TYPICAL DIAGRAM OF EXTERNAL LIGHT SHELVES**



## 3 INTERNAL LIGHT SHELVES

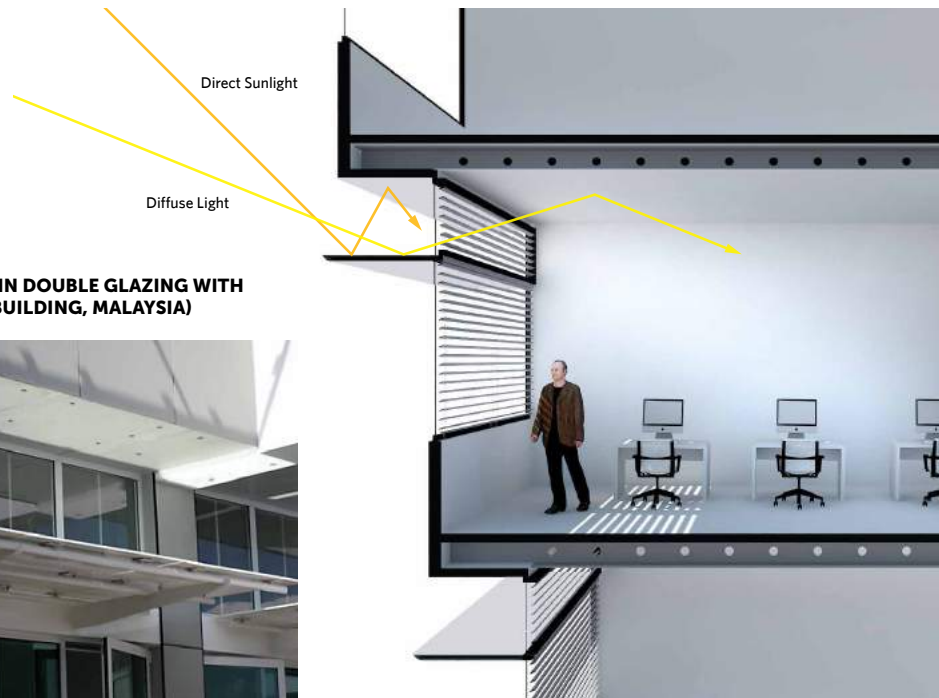
Internal light shelves help to reduce the light level near the façade to reduce the brightness contrast in the room, while providing a deeper throw of daylight into the room.

**FIGURE 4.3 | TYPICAL DIAGRAM OF AN INTERNAL LIGHT SHELF**

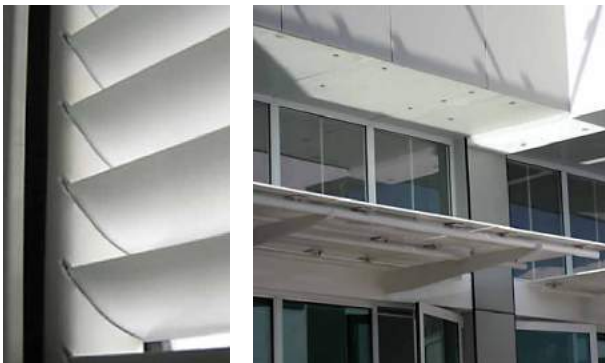


## 4 EMBEDDED BLINDS IN DOUBLE GLAZING WITH EXTERNAL LIGHT SHELVES

The embedded blinds in double glazing windows provide glare protection to the building occupants from the daylight harvesting windows. Another advantage is that these embedded blinds do not require any maintenance.



**FIGURE 4.4 | EMBEDDED BLINDS IN DOUBLE GLAZING WITH EXTERNAL LIGHT SHELVES (GEO BUILDING, MALAYSIA)**



# RULES FOR GOOD DAYLIGHT HARVESTING

For a good quality daylight harvesting system, ensure that these design principles are addressed:

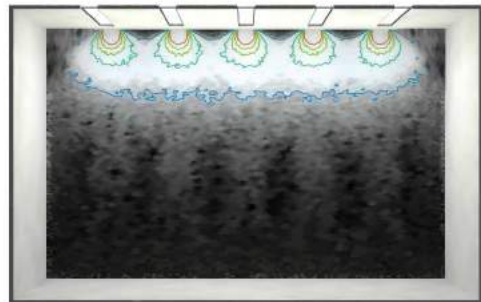
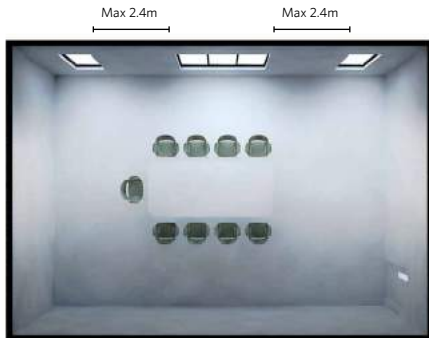
- Solar Heat Gain Minimisation
- Glare Protection
- Deep Daylight Penetration
- Uniform Daylight Distribution

## 1 RIGHT-SIZING THE WINDOW AREA ON THE FAÇADE

The provision of daylight would reduce a building’s energy consumption due the reason that electrical lights can be switched off for spaces that are illuminated by daylight, however at the same time, the higher solar heat gain would increase the building’s energy consumption due to higher air-conditioning energy used. A study was conducted to derive a clearer understanding of these relationships on the energy efficiency of a building for the Malaysian climate zone. In particular, this study was done to understand if it is a good concept to provide very large window areas to promote daylight harvesting in building.

The result of this study provided the following guidelines:

- 1 The maximum distance allowed between windows is 2.4 meters. Distances above 2.4 meters would cause the daylight distribution between the windows to have a contrast ratio higher than 3 times. This would cause visual discomfort and electrical lights would have to be switched on to maintain a comfortable contrast ratio in the building, negating the effect of daylight harvesting.
- 2 Keep the glazing area as small as possible while ensuring uniform daylight distribution. It was found in this study that more glazing area will increase the energy consumption in a building due to the increase in solar radiation heat gain. Even with the improvement of the penetration depth of daylight from the use of a larger glazing area, the heat gain due to solar radiation exceeds the savings from the additional daylight harvested. This statement still holds true when high-performance glazing with a high Light-to-Solar Gain ratio (LSG) is considered (refer to Chapter 5 for detailed definition of LSG). However, it should also be noted that this study did not consider advanced daylight harvesting strategies that can be used to distribute daylight deeper into the building.



- 3 Advanced methods of distributing of daylight deeper into the building are required to provide better energy efficiency in buildings where large window areas are provided. Otherwise, the extra daylight harvested from a larger window remains mostly near the window area and would not provide any increase in energy efficiency. Advanced daylight harvesting methods such as the use of external light shelves, light tubes, a higher ceiling height and other similar technologies, would help to distribute the daylight deeper into the building. These technologies should be considered when large window areas are used to achieve a balance between daylight harvested and solar heat gained.
- 4 Finally, the aesthetic look of a building may have a far higher commercial value than the energy efficiency of a building. In summary, keep the glazing area as small as possible, subject to the following minimum requirements:
  - a) Maintain the aesthetic look of the building for a high commercial value for your client.
  - b) Maintain a uniform daylight distribution to enable daylight harvesting in the building.

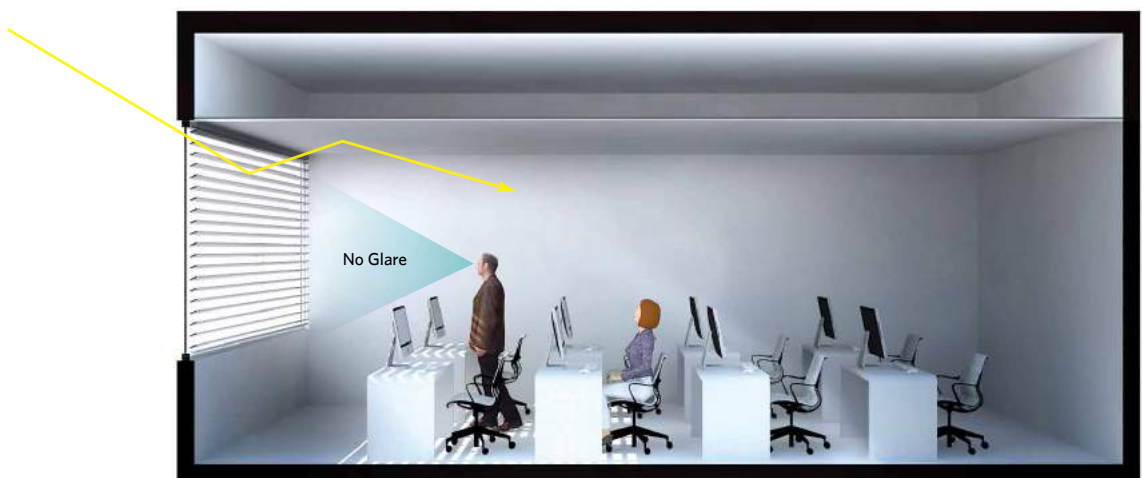
## 2 HARVESTING DAYLIGHT FROM THE FAÇADE

The key principle of harvesting daylight from the façade in Malaysia is to harvest daylight without glare for the building occupants. The simplest way to do this in a typical building design is by the use of horizontal blinds. These blinds can be tilted until they prevent glare to building occupants while allowing daylight to be deflected into the building as shown in **Figure 4.5.1** and **4.5.2**. The horizontal blinds would also help to deflect daylight onto the ceiling for better distribution of daylight deeper into the building.

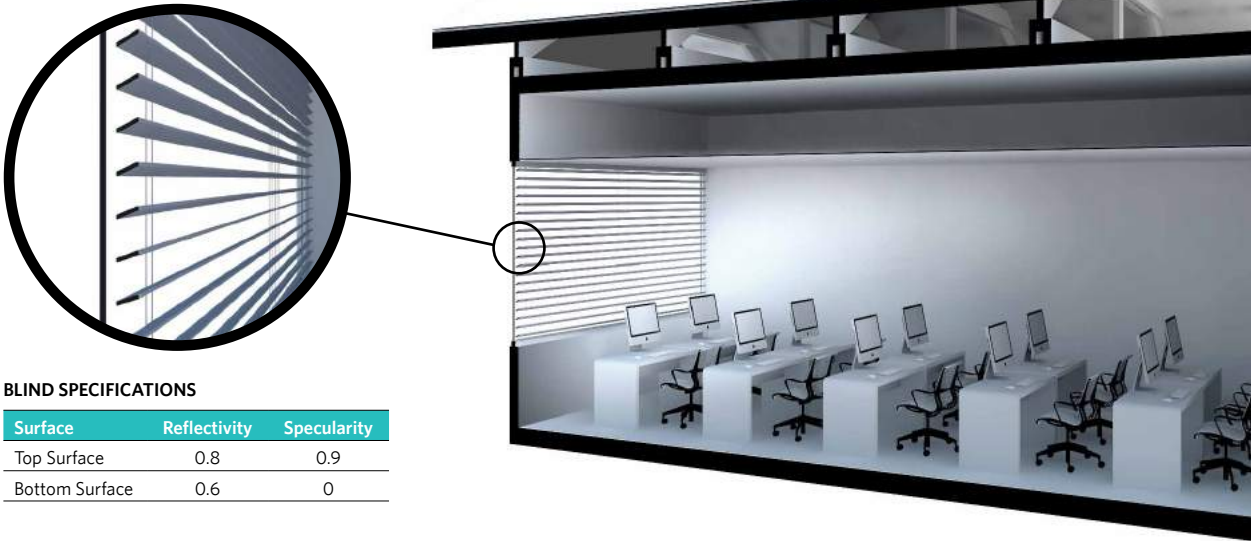
**FIGURE 4.5.1 | USE OF HORIZONTAL BLINDS IN OFFICES (TAKE NOTE OF THE BRIGHTER CEILING AND REFLECTIVE CEILING USED IN THIS PICTURE)**



**FIGURE 4.5.2 | CROSS-SECTION OF DAYLIGHT HARVESTING FROM FAÇADE USING HORIZONTAL VENETIAN BLINDS**



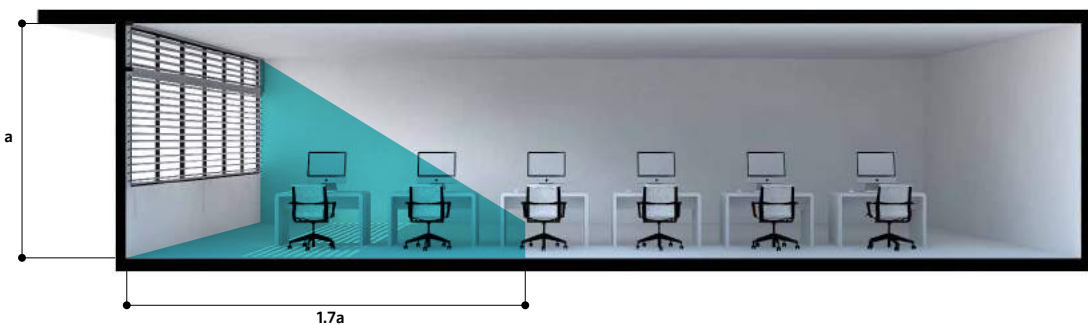
**FIGURE 4.5.3 | MODEL OF DAYLIGHT HARVESTING SIMULATION CONDUCTED USING RADIANCE**



**A study of daylight harvesting simulation using Radiance with horizontal blinds in place provided the following guidelines:**

- 1 The depth of a daylight factor of 1% (useful daylight) is approximately 1.7 times the height of the window as illustrated by the **Figure 4.5.4** below. The higher the window, the deeper the daylight will be distributed. The horizontal blinds were modelled to be tilted approximately 25° from horizontal to prevent glare to building occupants. The top surface is modelled to be specular and reflective to direct the received daylight to the ceiling to distribute it deep into the building, while the bottom surface is modelled to be matte to diffuse the daylight to prevent glare to the building occupants. It should also be noted as well that many daylight harvesting books proposed a typical depth of useful daylight as 2 to 3 times the height of the window. In this case the use of horizontal blinds reduces the depth of daylight distribution to an average of 1.7 times the height of the window.

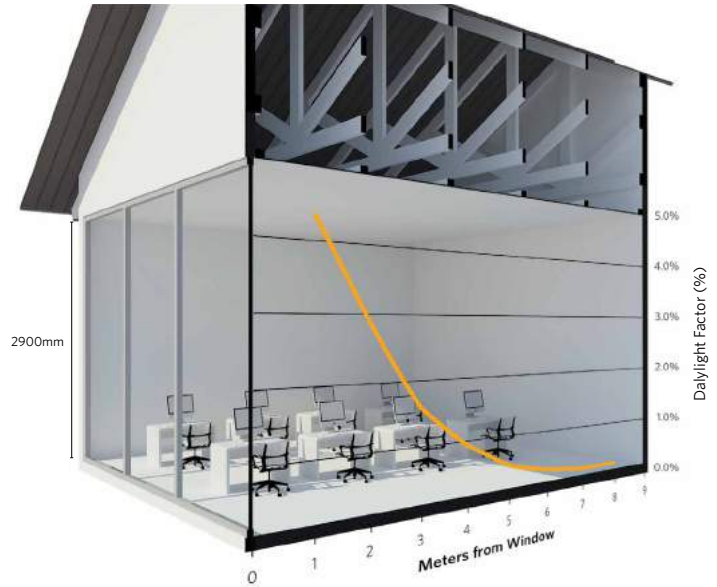
**FIGURE 4.5.4 | DAYLIGHT FACTOR OF 1% IS FOUND AT A DISTANCE OF APPROXIMATELY 1.7a WHEN HORIZONTAL BLINDS ARE USED TO PROVIDE GLARE PROTECTION**



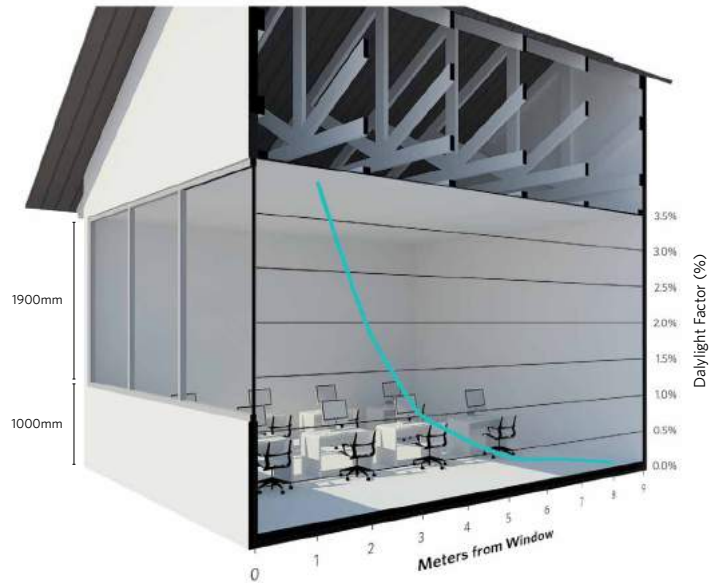


**2** The provision of full floor-to-ceiling height windows as shown in **Figure 4.5.5.1** does not provide additional depth of harvested daylight when compared to window with a sill height of 1 meter as shown in **Figure 4.5.5.2**. Radiance simulation results showed that the provision of full floor-to-ceiling height windows increased the contrast ratio of harvested daylight significantly. The simulated results showed a high daylight factor of 10% is found near the window for a full floor-to-ceiling height window, while the model with a sill height of 1 meter reduces the peak daylight factor near to the window to 6%. Meanwhile, both models provided a similar depth from the façade for a daylight factor of 1%. In summary, the provision of full floor-to-ceiling height windows does not increase the depth of daylight harvested but it increases heat gain in the building and at the same time, causes higher visual discomfort due to the higher contrast ratio.

**FIGURE 4.5.5.1 | SIMULATION RESULT OF FULL FLOOR-TO-CEILING HEIGHT WINDOW**



**FIGURE 4.5.5.2 | SIMULATION RESULT OF WINDOW WITH 1 METER SILL HEIGHT**



- 3 If full floor-to-ceiling height windows are used, the design should be made to reduce the harvested daylight near the façade while distributing the daylight deep into the building with the use of advanced daylight harvesting strategies such as external light shelves and other similar technologies.
- 4 An inefficient design practice that is commonly seen in a few existing buildings in Malaysia is the drop of the false ceiling level (less than 1 meter distance from the façade) below the top of the façade window height as shown in **Figure 4.5.6** below. The harvested daylight from the higher ceiling height near the façade is trapped by the dropped ceiling, preventing it from being distributed deep into the building. **Figure 4.5.7** shows how the ceiling can be improved for an increase of 28% daylight illumination in the room.

**FIGURE 4.5.6 | DAYLIGHT DISTRIBUTION BLOCKED BY DROP OF FALSE CEILING BELOW THE TOP OF WINDOW HEIGHT**



**FIGURE 4.5.7 | DAYLIGHT ILLUMINATION LEVEL IS 28% HIGHER THAN FIGURE 4.5.6**



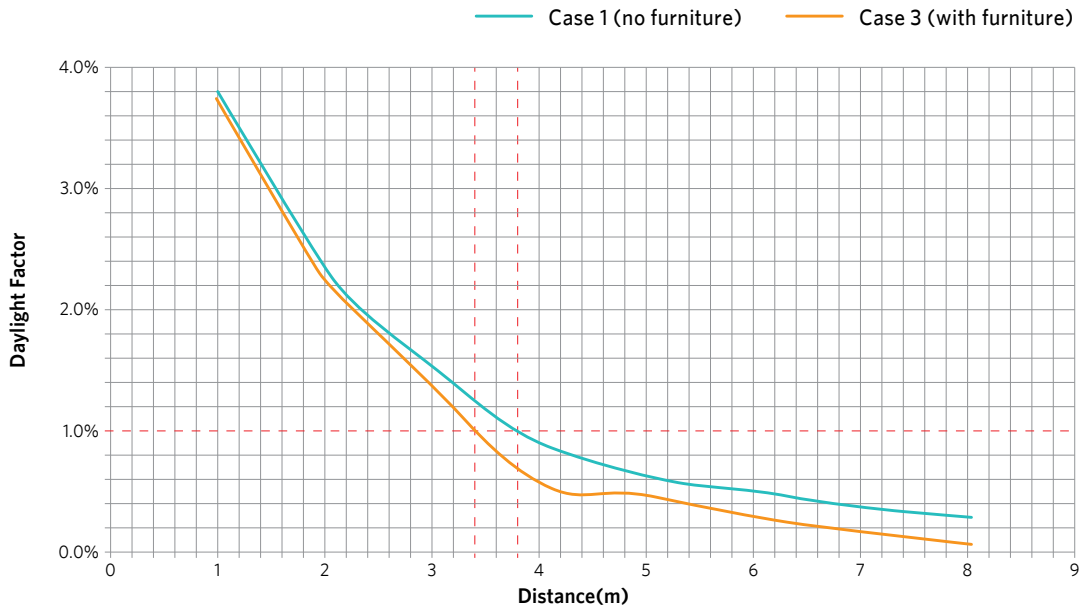


5 Finally, the provision of furniture reduces the daylight factor in the building. A simulation study made in Radiance showed that a typical layout of furniture reduces the depth of the daylight factor of 1% by a distance of 0.4 meters (or a 10% reduction in depth). Darker coloured furniture will cause a greater reduction of the daylight harvested, while lighter coloured furniture will have a smaller impact on the amount of daylight harvested. The simulation conducted for this study assumed that the tables are light brown, in combination with dark coloured chairs.

**FIGURE 4.5.8 | RADIANCE SIMULATION WITH FURNITURE IN OFFICES**



**CHART 4.5 | DAYLIGHT LIGHT CURVE WITH AND WITHOUT FURNITURE**



### 3 HARVESTING DAYLIGHT FROM THE ROOF

There are many options of harvesting daylight from the roof. A few of which are described here:

#### Skylights

Skylights are openings cut through the roof of a building. While skylights give excellent daylight levels, it is difficult to control the direct solar radiation from the sun when it is directly overhead. It is common to find such a design in public spaces of Malaysian buildings.

Such roof light designs are not recommended for office use because of the difficulty in controlling direct sunlight. However, in spaces where consistent daylight illumination is not required, such as public spaces and common areas, the use of skylights can bring a certain charm to the space below it. Unfortunately, the provision of too much skylight can lead to overheating issues in this climate zone. A carefully designed skylight should bring in the desired amount of daylight while minimising heat gain.



**FIGURE 4.6.1 | TYPICAL SKYLIGHT DAYLIGHT HARVESTING**

## Saw-Tooth Roof Light

Saw-tooth roof lights are a top-lighting technique formed from a vertical glass element and a sloping roof as shown in **Figure 4.6.2**. It is possible to design such roof lights to avoid direct sunlight in Malaysia by positioning the windows to face north and south. In addition to facing directly north or south, a short horizontal and vertical overhang is required to protect it from direct sun during summer solstice (north facing) and winter solstice (south facing). Such roof light designs would be ideal for office use because they only harvest diffuse daylight which is exceptionally consistent in this climate zone. In addition, the right-sizing of such roof lights will yield the desired amount of daylight without excessive heat gain.



**FIGURE 4.6.2 | TYPICAL SAW-TOOTH ROOF LIGHT DAYLIGHT HARVESTING**

## Roof Monitors

A roof monitor roof light is similar to the saw-tooth roof but has two opposing vertical glazed elements raised above the general roof line as shown in **Figure 4.6.3** below. It is also possible to design such roof monitors to avoid direct sun light in Malaysia by positioning the windows to face north and south. In addition, a short horizontal and vertical overhang is also required to protect it from direct sun during summer solstice (north facing) and winter solstice (south facing).



**FIGURE 4.6.3 | TYPICAL ROOF MONITOR DAYLIGHT HARVESTING**

## 4 HARVESTING DAYLIGHT FROM SKYLIGHT

Skylights in Malaysia are normally used in atrium spaces. However, lately it is becoming common to find the entire roof of a building converted to skylights to mimic designs found in countries with temperate climates. The over-provision of skylight in Malaysian buildings will cause high heat gain (greenhouse effect) that will be uncomfortable for the building occupants and also cause high energy use to cool down such spaces.

Simulation studies were done to optimise the skylight design for the Malaysian climate. Clear glazing with a Visible Light Transmission (VLT) of 80% was assumed for all these studies. Glazing with lower VLT may be used to reduce the daylight levels in atrium spaces if desired. The reduction of the daylight factor percentage is directly proportional to amount of reduction of the VLT.

The acceptable daylight factor in atrium spaces is recommended to be a minimum of 1% and a maximum of 6%. A daylight factor of 1% will be equivalent to the brightness of an office space, while a daylight factor higher than 6% means more than 50% of the daytime hours of 8am to 6pm to have an illumination level higher than 2,000 lux. In short, a daylight factor higher than 6% will bring in too much light and heat into the space. The lower the daylight factor, the cooler the space will be. Building designers need to strike a balance between the required brightness of an atrium space versus the heat gained in the space.

The simulation studies were conducted based on these criteria:

- |  |  |   |
|--|--|---|
| <p><b>A The roof and floor area was based on 3 options:</b></p> <ul style="list-style-type: none"> <li>• 8m x 8m (64 m<sup>2</sup>)</li> <li>• 12m x 12m (144 m<sup>2</sup>)</li> <li>• 16m x 16m (256 m<sup>2</sup>)</li> </ul> | <p><b>B The height of the skylight was based on 3 options:</b></p> <ul style="list-style-type: none"> <li>• 2 floors (8m height)</li> <li>• 5 floors (20m height)</li> <li>• 10 floors (40m height)</li> </ul> | <p><b>C Skylight aperture sizes were tested based on 4 options:</b></p> <ul style="list-style-type: none"> <li>• 5% of roof area</li> <li>• 10% of roof area</li> <li>• 15% of roof area</li> <li>• 20% of roof area</li> </ul> |
|--|--|---|

The vertical surfaces surrounding the atrium were assumed to be 50% glazing area and 50% white wall area.

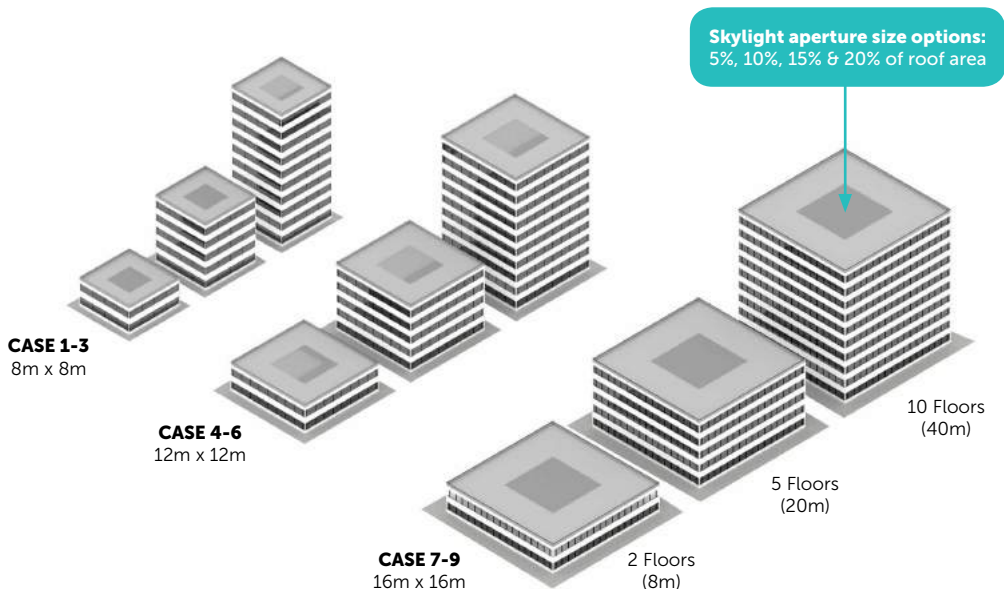
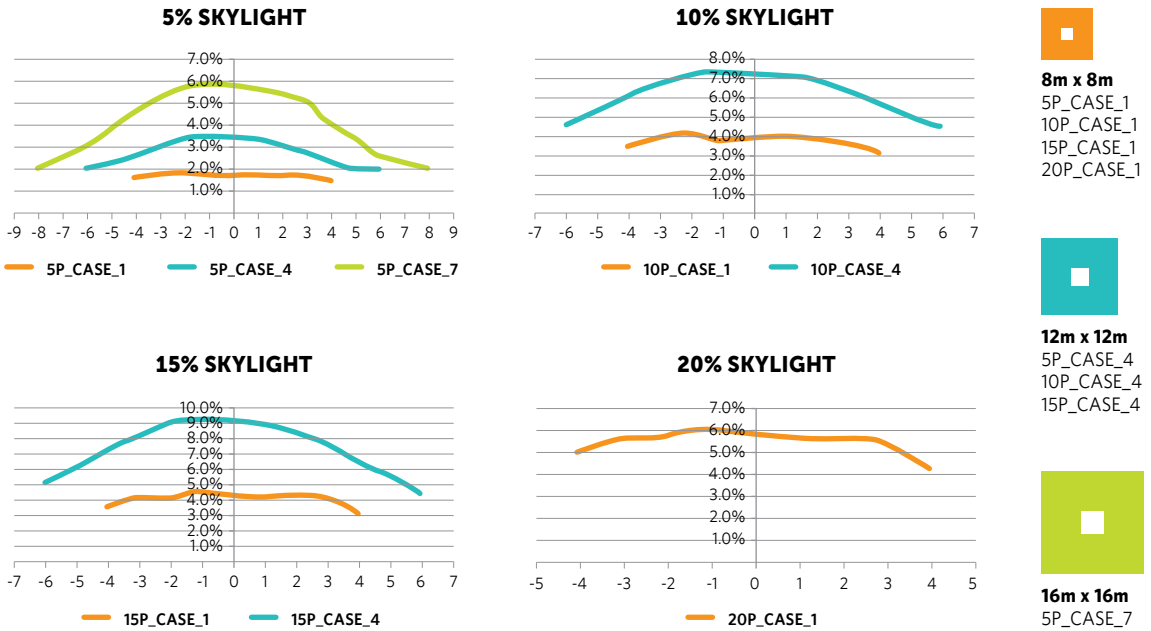


TABLE 4.1 | SIMULATION CASES

MODEL SPECIFICATION	SURFACE AREA			FLOORS			SKYLIGHT APERTURE SIZE (% OF ROOF AREA)			
	64m <sup>2</sup>	144m <sup>2</sup>	256m <sup>2</sup>	2	5	10	5%	10%	15%	20%
▶ 5P_CASE_1	Green			Green			Green			
▶ 5P_CASE_2					Green					
▶ 5P_CASE_3	Green					Green	Green			
▶ 5P_CASE_4		Green		Green			Green			
▶ 5P_CASE_5					Green		Green			
▶ 5P_CASE_6		Green				Green	Green			
▶ 5P_CASE_7			Green	Green			Green			
▶ 5P_CASE_8			Green		Green		Green			
▶ 5P_CASE_9			Green			Green	Green			
▶ 10P_CASE_1	Orange			Orange				Orange		
▶ 10P_CASE_2	Orange				Orange			Orange		
▶ 10P_CASE_3	Orange					Orange		Orange		
▶ 10P_CASE_4		Orange		Orange				Orange		
▶ 10P_CASE_5					Orange			Orange		
▶ 10P_CASE_6		Orange				Orange		Orange		
▶ 10P_CASE_7			Orange	Orange				Orange		
▶ 10P_CASE_8			Orange		Orange			Orange		
▶ 10P_CASE_9			Orange			Orange		Orange		
▶ 15P_CASE_1	Teal			Teal					Teal	
▶ 15P_CASE_2	Teal				Teal				Teal	
▶ 15P_CASE_3	Teal					Teal			Teal	
▶ 15P_CASE_4		Teal		Teal					Teal	
▶ 15P_CASE_5		Teal			Teal				Teal	
▶ 15P_CASE_6		Teal				Teal			Teal	
▶ 15P_CASE_7			Teal	Teal					Teal	
▶ 15P_CASE_8			Teal		Teal				Teal	
▶ 15P_CASE_9			Teal			Teal			Teal	
▶ 20P_CASE_1	Blue			Blue						Blue
▶ 20P_CASE_2	Blue				Blue					Blue
▶ 20P_CASE_3	Blue					Blue				Blue
▶ 20P_CASE_4		Blue		Blue						Blue
▶ 20P_CASE_5		Blue			Blue					Blue
▶ 20P_CASE_6		Blue				Blue				Blue
▶ 20P_CASE_7			Blue	Blue						Blue
▶ 20P_CASE_8			Blue		Blue					Blue
▶ 20P_CASE_9			Blue			Blue				Blue

## SKYLIGHT SIMULATION RESULTS

### 1 LOW-RISE ATRIUM : DOUBLE VOLUME HEIGHT (8 Meter Height)



#### When a roof area is large (16m x 16m or larger):

- The provision of 5% skylight on the roof would provide adequate daylight for the space below it (with an average daylight factor of 4%).
- The provision of 10% skylight on the roof will cause the daylight factor to increase beyond 10%.

#### When a roof area is small (8m x 8m or smaller):

- The provision of 5% skylight on the roof provides an average daylight factor of 2%.
- The provision of 20% skylight on the roof provides an average daylight factor of 6%.

These results indicate that for a double volume space, the skylight area requirement is only a small percentage of the roof area to provide adequate daylight for the space below it

## 2 MEDIUM-RISE ATRIUM : 5 FLOORS (20 Meter Height)

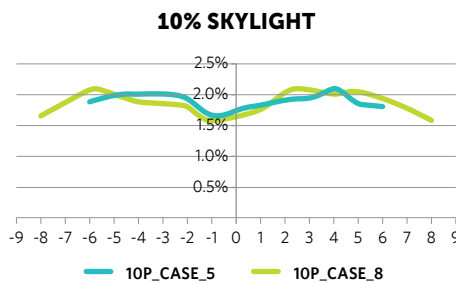
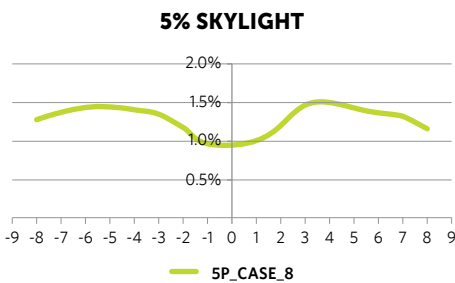
It was found that the daylight received at the floor level reduces as the atrium height increases. This is due to the surrounding walls absorbing the light before it reaches the floor below.

### When a roof area is large (16m x 16m or larger):

- The provision of 5% skylight on the roof would provide just adequate daylight for the space below it (with an average daylight factor of 1%).
- The provision of 20% skylight on the roof will cause the daylight factor to increase to 3.5%.

### When a roof area is small (8m x 8m or smaller):

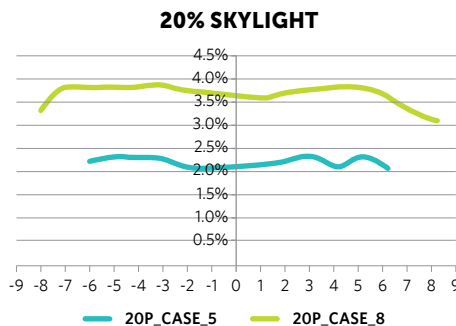
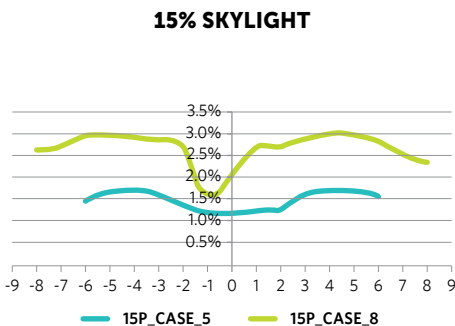
- The provision of 20% skylight does not provide adequate daylight for the space below it. Most of the daylight is absorbed by the surrounding walls.



8m x 8m



12m x 12m  
10P\_CASE\_5  
15P\_CASE\_5  
20P\_CASE\_5



16m x 16m  
5P\_CASE\_8  
10P\_CASE\_8  
15P\_CASE\_8  
20P\_CASE\_8

## 3 HIGH-RISE ATRIUM : 10 FLOORS (40 Meter Height)

The simulation studies showed that all cases would not meet the minimum daylight factor requirement of 1% .

Further studies indicate the following skylight roof percentages are required to provide a minimum of daylight factor of 1% for these 3 atrium sizes:

- 8m x 8m - 100% skylight, and yet the average daylight factor remains below 1%.
- 12m x 12m - 100% skylight, average daylight factor is 2%.
- 16m x 16m - 30% skylight, average daylight factor is 1%.

## SUMMARY

It is important to understand that good daylight harvesting in buildings is more than just providing a large glazing area. In fact the study conducted for this chapter showed that keeping the glazing area to a minimum is the recommended design option for the optimum balance between daylight and solar heat gain.

Well-designed daylight harvesting features will provide better indoor environmental quality, improve building occupant performance and reduce the building's energy consumption at the same time. Meanwhile, daylight harvested improperly will cause glare discomfort, too much heat gain and an will cause increase in energy consumption.

A well-designed daylight harvesting system in a tropical climate has to address all these issues:

- **Solar Heat Gain Minimisation**
- **Glare Protection**
- **Deep Daylight Penetration**
- **Uniform Daylight Distribution**

---

**END OF CHAPTER 4**



CHAPTER

# 5

## GLAZING PROPERTIES





## 5

# GLAZING PROPERTIES

## INTRODUCTION

In recent years, a number of local buildings in Malaysia have been built using simple, single clear glazing for a 'transparent' building look, clearly unaware (or not bothered) that the use of such a glazing selection increases the air-conditioning load of the building significantly, causing high energy use and an increased capital cost of the air-conditioning system. Such buildings indicate that there are architects who are not aware of the changes in glazing technology which allow such buildings to be constructed energy efficiently without compromising on the 'transparent' look of the building.

The correct selection of glazing properties can help to increase the energy efficiency in the building and yet provide the desired 'look' of the building. The right glazing selection can reduce the cooling load in the building, providing better comfort while allowing a smaller air-conditioning system to be used, thus reducing investment costs. In addition, the right selection of glazing also influences the potential of daylight harvesting in a building which will reduce the usage of electrical lights, saving a significant amount of energy in the building, while at the same time providing improved thermal and visual comfort for the building occupants.

Finally, many architects today understand the need to have a low Solar Heat Gain Coefficient (SHGC) to reduce the heat gain in buildings and high Visible Light Transmission (VLT) to promote daylight harvesting. However, not many understand the relationship between SHGC and VLT due to the different glazing technologies and mechanisms used. This, amongst other issues with regards to selection of glazing properties, is addressed in this chapter.

## KEY RECOMMENDATIONS

The most important factor to consider in this climate zone for glazing selection, in terms of energy efficiency, is the Solar Heat Gain Coefficient (SHGC). The lower the SHGC value, the better it is because it means that less solar heat would enter the building through the glazing.

Another important factor to consider in glazing selection for energy efficiency is the Visible Light Transmission (VLT) of the glazing. The VLT of the glazing will determine the amount of daylight that is possible to be harvested. In Chapter 4, it was shown that glazing with a VLT below 20% is too dark for daylight harvesting. In addition, a higher VLT does not necessarily mean more daylight can be harvested. It was also shown in Chapter 4 that glazing with higher VLT values will require better daylight reflection systems to be in place to distribute the daylight evenly for a better efficiency gain.

The ratio of VLT over SHGC provides a term called Light-to-Solar Gain ratio (LSG). Single glazing **without** low-e properties has LSG values of 0.5 to 1.0 depending on the colour of the glazing. Single glazing **with** low-e properties has typical LSG values of 1.05 to 1.25. High-performance double glazing with low-e properties has typical LSG values of 1.6 to 2.0.

It is recommended to not use double glazing with LSG values of less than 1.5, because the marginal increase in cost of using double glazing with LSG values above 1.5 is relatively low once double glazing is selected to be used in the first place.

## RECOMMENDED STRATEGY FOR GLAZING SELECTION

- 1 Choose the glazing with the colour, Visible Light Transmission (VLT) and reflectivity required for the desired architectural look for the building.
- 2 If daylight is being harvested, a minimum VLT of 20% is recommended. The higher the VLT, the more daylight can be harvested. However, daylight harvesting has to be done carefully to ensure that it will not cause glare discomfort and that the daylight will be distributed evenly. (Refer to Chapter 4)
- 3 Based on the colour, VLT and reflectivity of the glazing, ask for these 3 options to be provided with the cost estimate and SHGC value:
  - Single Tinted Glazing without Low-e
  - Single Tinted Glazing with Low-e
  - Double Glazing with Low-e and low SHGC value
- 4 Use the Malaysian Standard (MS) 1525 to estimate the Overall Thermal Transmission Value (OTTV) of each option (refer to page 107 for details on MS1525 and OTTV).
- 5 Compute the running energy cost due to the OTTV.
- 6 Conduct an extra cost vs. energy reduction estimate for the different OTTV options.
- 7 Suggestions:
  - a) If reduction of glazing area is not possible, consider the use of high-performance double low-e glazing to reduce SHGC values.
  - b) Compare the increased cost of double glazing with the option of providing external shades. (Chapter 6)
- 8 Finally, consider the use of reflective internal shades but be aware of the issues that have to be addressed for internal shades to reduce solar heat gain in buildings. (Chapter 6)

## ENERGY EFFICIENT GLAZING SELECTION IN A TRANSPARENT BUILDING

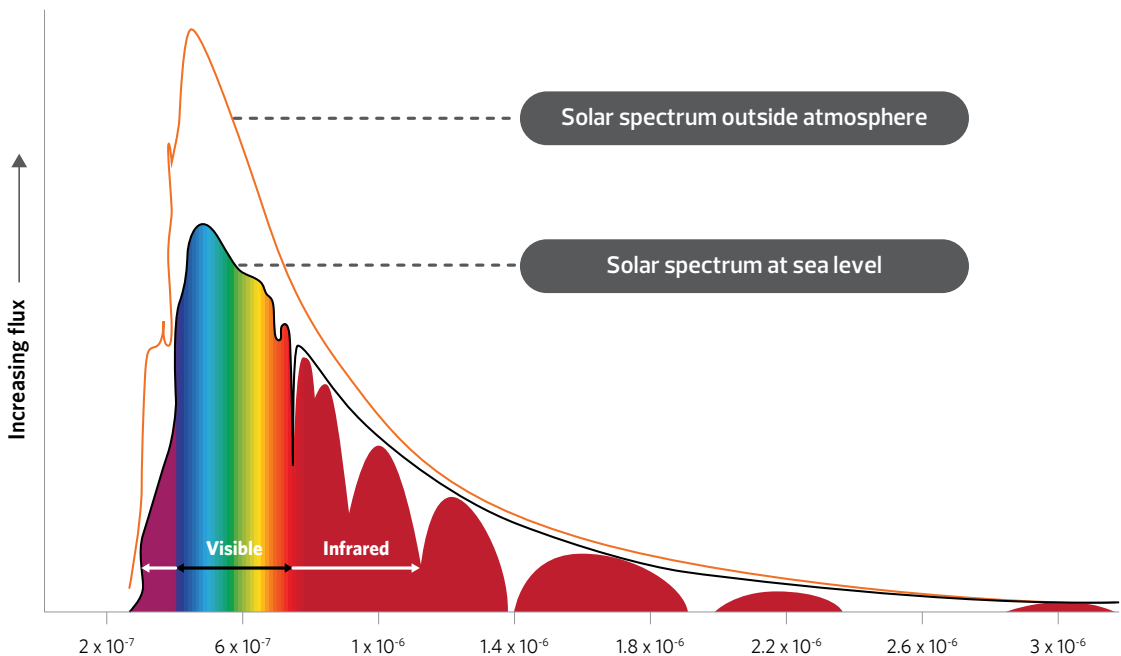
One option to achieve a 'transparent' building look while maintaining energy efficiency is to invest in glazing technology. It was observed that a few 'transparent' looking buildings in the Klang Valley have a VLT above 70%. If a typical single clear glazing is selected, the SHGC will be approximately 0.70 or higher. If a good low-e single glazing is used, the SHGC value can be as low as 0.52. However, if a high-performance low-e double glazing technology is selected (with LSG of 2.0), it is possible to get a SHGC value as low as 0.35.

Finally, it should also be highlighted that it could be difficult to keep a building 'transparent' during operation. Issues such as glare discomfort, occupant privacy, the look of unsightly offices and potential clashes of colour of internal shades (in a multi-tenanted building) needs to be addressed carefully to ensure that the building can remain 'transparent' and 'attractive' during use.

## THE SOLAR SPECTRUM

Solar spectrum from the sun consists of the short wave length (ultraviolet light), medium wave length (visible light), and long wave length (infrared). The ultraviolet and infrared are invisible to our eyes and therefore, it is 'pure' heat that is not useful for buildings located in this climate zone. There exists glazing technologies that can filter out the ultraviolet and infrared from the solar spectrum and only allow visible light to pass through the glazing. These glazing technologies will enable visible light to be harvested with a low heat gain in the building.

**FIGURE 5.1 | SOLAR SPECTRUM COMPONENTS**



# GLAZING TERMINOLOGIES

In the tropical climate, where daylight harvesting can improve the energy efficiency of the building significantly, the following terminologies are relevant:

## 1 Visible Light Transmission (VLT)

This is the total amount of visible light that passes through the glazing. Some parts of the light would also be reflected and absorbed by the glazing. The higher the VLT, the more daylight harvesting opportunity there is. It is recommended to match the daylight harvesting strategy to the selection of VLT of the glazing. In general, glazing with a VLT of less than 10% makes a building look dull from within due to the lack of daylight in the building itself.

## 2 Solar Heat Gain Coefficient (SHGC) or G-Value

This is the total amount of solar heat that passes through the glazing. The lower the value, the better it is in the tropical climate because less solar heat is transferred into the building. In single glazing, the lowest achievable SHGC is approximately 0.24 with VLT values less than 10%. Due to the low VLT, it may not be desirable to use such glazing. However, in high-performance low-e double glazing, it is possible to get a SHGC lower than 0.15 with a VLT of 25% or higher.

The term "SHGC" is relatively new and is intended to replace the term "Shading Coefficient (SC)". The Shading Coefficient (SC) of glass is defined as the ratio of the solar heat gain through a given glazing as compared to that of clear, 1/8 inch single pane glass. Since different manufacturers have different properties of a clear glass, the SC will be different depending on the manufacturer, whereas the SHGC is a simple and definite definition of the amount of solar heat that passes through the glazing. Where information is not provided, the SHGC can be approximated from the SC using this equation: **SHGC = 0.87 x SC**.

## 3 Light To Solar Gain Ratio (LSG)

LSG is the ratio between the Visible Light Transmission and the Solar Heat Gain Coefficient. The higher this number is, the better it is for buildings where daylight is harvested.

$$\text{LSG} = \frac{\text{VLT (\%)}}{\text{SHGC (\%)}}$$

Single glazing **without** low-e properties has typical LSG values of 0.5 to 1.0.

Single glazing **with** low-e properties has typical LSG values of 1.05 to 1.3.

High-performance double glazing **with** low-e properties has typical LSG values of 1.5 to 2.0.

## 4 U-value (W/m<sup>2</sup>K)

The U-value of a glazing is a measure of conduction heat gain through the glazing unit. The lower the value, the less heat is conducted through the glazing. However, the U-value of glazing has a comparatively small influence on the building energy consumption in a tropical climate compared to the VLT, SHGC and LSG properties of the glazing. For the tropical climate, it is recommended to select glazing based on VLT, SHGC and LSG values, while keeping the U-value as a by-product of the selection process because in this climate, a good glazing selection based on VLT, SHGC and LSG would typically improve the U-value of the glazing, except for normal, single tinted glazing. In this climate, it is not economically justifiable to select glazing based on U-values alone. However, if the selection of glazing based on VLT, SHGC and LSG gives a better U-value, then it is better for the building.

# GLAZING TECHNOLOGIES FOR ENERGY EFFICIENCY

A good glazing technology has an advantage over external shading because a good glazing will reduce solar heat gain from both direct and diffuse solar radiation, while external shading mainly reduces direct radiation and has only a small influence on heat gain from diffuse radiation (Chapter 6).

Glazing technology has improved significantly over the last 10 years. These are common technologies available in glazing today to help reduce energy consumption in buildings:

## 1 Types of Low-E

There are three generic low-e types in use in the market today:

1. **High Solar Gain Low-E**
2. **Low Solar Gain (Solar IR Absorbing) Pyrolytic Low-E**
3. **Low Solar Gain (Solar IR Reflecting) Sputtered Silver Low-E**

The 1<sup>st</sup> type of high solar gain low-e is not suitable for tropical climate use because it is meant to allow solar radiation to be transmitted into the building and then trapping it within the building to heat it up. This type of low-e glazing is suitable for cold climates where heating is the predominant energy used in a building.

The 2<sup>nd</sup> and 3<sup>rd</sup> type of low-e (Solar IR absorbing and reflecting) is perfect for a tropical climate such as Malaysia's because it stops the solar radiation on the glazing itself by absorbing it or reflecting and reradiating it back outside.

## 2 Single Glazing Low-E

These are hard coated metallic coatings on the surfaces of glazing that can be exposed to the indoor climate. The metallic coating on the inside surface reduces the emissivity of the glazing by 70% to 80%, thereby reducing the heat that is radiated into the internal spaces, while allowing heat to be radiated back outdoors. This glazing will provide better comfort conditions for the building occupants due to its lower radiant heat and will indirectly allow the air-conditioning temperature to be raised to maintain comfortable conditions. It is also important to note that adding low-e to single glazing only lowers the SHGC effectively if it is on a tinted glass or the coating has a heat absorbing layer. It is not difficult to find single glazing low-e products with a LSG between 1.0 and 1.3.

## 3 Double Glazing Low-E

These are soft coated metallic coatings on the surfaces of glazing that cannot be exposed. These coatings have to be protected in between the glazing. These metallic coatings on the inside surface reduces the emissivity of the glazing by 95% or more, thereby reducing the heat that is radiated to the internal spaces. It is not difficult to find double glazing low-e products with a LSG between 1.5 and 2.0.

# GLAZING PROPERTIES & ENERGY REDUCTION

An energy simulation was conducted to derive an approximate estimate of the energy and peak load reduction by reducing the window area together with the selection of good glazing properties for each orientation.

These estimates are provided as a guide for quick design checks by architects, engineers and building owners to estimate the cost savings by implementing these energy efficiency features. The simulation study model was based on Chapter 3, Case 1 of a Square Building, without any external shades.

## 1 REDUCTION OF GLAZING AREA

Chapter 4 showed that purely from an energy efficiency point of view, the glazing area should be reduced as long as it does not affect the uniformity of daylight distribution in a building. A table is provided below with the peak cooling load and energy reduction impact from the reduction of glazing area in the various orientations of the building. These values are derived from an assumption that single glazing with a SHGC value of 0.75 is used. Glazing with a lower SHGC value is not provided in this study because the glazing area in a building is normally decided without consideration of the properties of the glazing used. It is only after the design of the glazing area has been decided that the properties of the glazing would then be selected. Therefore, it is proposed to use this table below only as a reference for architects to decide to add or reduce the glazing area for different façade orientations of the building.

**TABLE 5.1 | ENERGY AND PEAK LOAD IMPACT OF REDUCING OF GLAZING AREA (SHGC 0.75)**

Orientation	North	South	East	West
*Energy Reduction (per year) Per Glazing Area Reduction (kWh/m <sup>2</sup> of glazing area reduction)	90	80	140	100
**RM Reduction (per year) Per Glazing Area Reduction (RM/m <sup>2</sup> of glazing area reduction)	31	28	48	36
***Peak Cooling Load Reduction Per Glazing Area Reduction (W/m <sup>2</sup> of glazing area reduction)	210	130	350	270

\* Average HVAC System COP: 3.1

\*\* A simplified energy tariff of RM0.35 per kWh is used.

\*\*\* Only applicable for buildings with glazing area distributed evenly on all orientation.

The peak cooling load reduction provided in **Table 5.1** above is only valid on the assumption that the building glazing areas are distributed rather evenly on all orientations. If, for example, the West orientation glazing area is 200% larger than the others, reducing the glazing area on the North, South and East will not reduce the peak cooling load of the building. This is because the West orientation is dominating the peak heat gain of the building.



**EXAMPLE 1 - USE OF TABLE 5.1**

Base Design of East Façade has a Glazing Area of 2,000 m<sup>2</sup>  
 Revised Design of East Façade has a Glazing Area of 1,700 m<sup>2</sup>

**Calculations:**

East Façade Glazing Area Reduction = 2,000 m<sup>2</sup> - 1,700 m<sup>2</sup> = 300 m<sup>2</sup>  
 Table 5.1, East Façade: Energy Reduction of 140 kWh/m<sup>2</sup> of glazing reduction

Energy Saved per year due to Reduction of Glazing Area on the East Façade:  
 300 m<sup>2</sup> x 140 kWh/m<sup>2</sup> = 42,000 kWh/year  
 Providing a saving of RM14,700 per year

**EXAMPLE 2 - USE OF TABLE 5.1**

Base Design of South Façade has a Glazing Area of 1,500 m<sup>2</sup>  
 Revised Design of South Façade has a Glazing Area of 1,950 m<sup>2</sup>

**Calculations:**

South Façade Glazing Area Addition = 1,950 m<sup>2</sup> - 1,500 m<sup>2</sup> = 450 m<sup>2</sup>  
 Table 5.1, South Façade: Energy Reduction of 80 kWh/m<sup>2</sup> of glazing reduction

Energy Increase per year due to Addition of Glazing Area on the South Façade:  
 450 m<sup>2</sup> x 80 kWh/m<sup>2</sup> = 36,000 kWh/year  
 Providing an increase of RM12,600 per year

**2 REDUCTION OF SOLAR HEAT GAIN COEFFICIENT (SHGC)**

The lower the value of the SHGC for the window, the less heat is transferred into the building. However, in a single glazing, the lowest achievable SHGC today is approximately 0.2 and it has to be a dark glazing with low VLT (less than 10%). Selection of such a dark glazing for a building today may make the building seem old-fashioned from the outside and not desirable on the inside due to the lack of daylight within the building. However, it is possible to find high-performance double glazing with low-e that achieves a SHGC of 0.15 or lower and yet has a VLT of 25% or higher. In short, it is possible to select a double glazing that is cooler (as compared to single glazing) and yet provides a decent daylight harvesting opportunity for the building. It should be noted that the actual performance will vary between glazing manufacturers and colour selections. A table is provided below to estimate the energy and peak load reduction of using glazing with a reduced SHGC value.

**TABLE 5.2.1 | ENERGY AND PEAK LOAD IMPACT OF REDUCING OF SHGC, IN SINGLE GLAZING**

Orientation	North	South	East	West
*Energy Reduction (per year) Per Glazing Area Per SHGC Reduction (kWh/m <sup>2</sup> of SHGC of glazing area reduction)	120	100	150	130
**RM Reduction (per year) Per Glazing Area Per SHGC Reduction (RM/m <sup>2</sup> of SHGC of glazing area reduction)	40	35	53	46
***Peak Cooling Load Reduction Per Glazing Area Per SHGC Reduction (W/m <sup>2</sup> of SHGC of glazing area reduction)	270	140	310	360

\* Average HVAC System COP: 3.1

\*\* A simplified energy tariff of RM0.35 per kWh is used.

\*\*\* Only applicable for buildings with glazing area distributed evenly on all orientations.

Again, the peak cooling load reduction provided in **Table 5.2.1** above is only achievable on the assumption that the building glazing areas are distributed rather evenly on all the orientations.

The energy reduction of SHGC in double glazing is higher than single glazing (where the base building is still assumed to be using a single glazing) and the table below provides the potential savings by using double glazing instead of single glazing.

**TABLE 5.2.2 | ENERGY AND PEAK LOAD IMPACT OF REDUCING OF SHGC, IN DOUBLE GLAZING**

Orientation	North	South	East	West
*Energy Reduction (per year) Per Glazing Area Per SHGC Reduction (kW/m <sup>2</sup> of SHGC of glazing area reduction)	160	140	210	170
**RM Reduction (per year) Per Glazing Area Per SHGC Reduction (RM/m <sup>2</sup> of SHGC of glazing area reduction)	56	50	75	60
***Peak Cooling Load Reduction Per Glazing Area Per SHGC Reduction (W/m <sup>2</sup> of SHGC of glazing area reduction)	440	290	560	480

\* Average HVAC System COP: 3.1

\*\* A simplified energy tariff of RM0.35 per kWh is used.

\*\*\* Only applicable for buildings with glazing area distributed evenly on all orientation.

### EXAMPLE 3 - USE OF TABLE 5.2.1 & TABLE 5.2.2

Base Design:

North Façade: 1,500 m<sup>2</sup>, Single Glazing, SHGC 0.75

East Façade: 1,200 m<sup>2</sup>, Single Glazing, SHGC 0.75

Revised Design:

North Façade: 1,500 m<sup>2</sup>, Single Glazing, SHGC 0.40, Additional Cost: RM30/m<sup>2</sup> of glazing area

East Façade: 1,200 m<sup>2</sup>, Double Glazing, SHGC 0.20, Additional Cost: RM250/m<sup>2</sup> of glazing area

#### Calculations:

##### North Façade:

SHGC Reduction = 0.75 - 0.40 = 0.35

Energy Reduction Table 5.2.1 for single glazing: 120 kWh/m<sup>2</sup>.SHGC

Energy Reduction per Year: 120 kWh/m<sup>2</sup>.SHGC x 0.35 x 1,500 m<sup>2</sup> = 63,000 kWh/year

Providing a saving of RM22,050/year

Total Additional Cost (RM): RM30/m<sup>2</sup> x 1,500 m<sup>2</sup> = RM45,000

Simple Payback = RM45,000 / RM22,050 = 2 years

##### East Façade:

SHGC Reduction = 0.75 - 0.20 = 0.55

Energy Reduction Table 5.2.2 for double glazing: 210 kWh/m<sup>2</sup>.SHGC

Energy Reduction per Year: 210 kWh/m<sup>2</sup>.SHGC x 0.55 x 1,200 m<sup>2</sup> = 138,600 kWh/year

Providing a saving of RM48,510/year

Total Additional Cost (RM): RM250/m<sup>2</sup> x 1,200 m<sup>2</sup> = RM300,000

Simple Payback = RM300,000 / RM48,510 = 6 years

### 3 REDUCTION OF U-VALUE IN GLAZING

The reduction of the glazing U-value by switching from single glazing to double glazing will also reduce the SHGC slightly because now two panes of glass are used instead of one. The additional pane of glass will reflect and absorb some of the solar radiation and has been considered in this study. The result of this study shows that the energy reduction due to the U-value reduction in glazing is extremely small compared to the reduction of glazing area and SHGC as shown in **Tables 5.1 to 5.3**.

**TABLE 5.3 | ENERGY AND PEAK LOAD IMPACT OF REDUCING U-VALUE IN GLAZING**

Orientation	Average of All Orientations
*Energy Reduction (per year) Per Glazing Area Per U-value Reduction (kWh/m <sup>2</sup> of U-value reduction)	4.2
**RM Reduction (per year) Per Glazing Area Per U-value Reduction (RM/m <sup>2</sup> of U-value reduction)	1.50
***Peak Cooling Load Reduction Per Glazing Area Per U-value Reduction (W/m <sup>2</sup> of U-value reduction)	13.9

\* Average HVAC System COP: 3.1

\*\* A simplified energy tariff of RM0.35 per kWh is used.

\*\*\* Only applicable for buildings with glazing area distributed evenly on all orientation.

## THE MS1525 OTTV

The Malaysian Standard available from SIRIM<sup>1</sup>, MS1525, provides a method to calculate the Overall Thermal Transmission Value (OTTV) of a building fabric.

The original form of OTTV was developed for ASHRAE Standard 90 in 1975<sup>2</sup> and refined again in 1980<sup>3</sup>. The OTTV constants were derived from energy simulation studies, where in the 1970s, is only in the domain of universities and research centres. The OTTV was developed as a means of estimating the cooling load of a building fabric system without requiring the use of energy simulation tools, enabling it to be used by any architect and engineer to make estimates of the average cooling load in a building due to building fabric choices.

The OTTV is defined by ASHRAE as the average chiller cooling load gained due to the choice of building fabric (excluding the roof) based on the conditions outside

(weather) and a 'typical' condition inside an office building.<sup>4</sup> Today, ASHRAE 90 has since discarded OTTV in favour of energy simulation. This is because energy simulation is now easily accessible by almost all architects and engineers compared to the 1980s. Moreover, the OTTV was found to be inaccurate for climates having different seasons (cold winter and warm summer) or different air-conditioning hours.<sup>5</sup> In addition, the OTTV conduction terms will not provide correct results for buildings where the internal load is high during non-air-conditioned hours, which is unfortunately rather common in buildings today, compared to the days when the OTTV was developed (in the 1970s to 1980s).

<sup>1</sup>SIRIM Berhad is Malaysia national standards development agency, SIRIM also plays an active role in international standards development

<sup>2</sup>ASHRAE Standard 90 Project Committee. 'Energy Conservation in New Building Design. ASHRAE Standard: 90-1975.' American Society of Heating, Refrigeration and Air Conditioning Engineers, Inc., Atlanta, GA, 1975

<sup>3</sup>ASHRAE Standard 90 Project Committee. 'Energy Conservation in New Building Design. ASHRAE Standard: 90A-1980, 90B-1975, 90C-1977.' American Society of Heating, Refrigeration and Air Conditioning Engineers, Inc., Atlanta, GA, 1980.

<sup>4</sup>JJ Deringer and JF Busch. Final Report of ASEAN-USAID Building Energy Conservation Project, 1992, pg. 8-7.

<sup>5</sup>S. Chirarattananon and J. Taveekun. 2004. "An OTTV-based energy estimation model for commercial buildings in Thailand. Energy and Building, Vol. 36, Issue 7, July, pp 680-689.

**FIGURE 5.4 | OTTV DEFINITION EXTRACTED FROM FINAL REPORT OF ASEAN-USAID BUILDING ENERGY CONSERVATION PROJECT**

**Chiller Load<sub>OTTV</sub> (W/m<sup>2</sup>) = Chiller Load<sub>DOE-2</sub> (Kwh) / (A<sub>o</sub> (ft<sup>2</sup>) x H<sub>∞</sub> (hours)) (Eq. 8-7)**

Where:  
**A<sub>o</sub>** = Gross area of exterior wall, A<sub>w</sub> + A<sub>p</sub>, m<sup>2</sup> (ft<sup>2</sup>), as defined in Eq. (7-1), for all orientations combined.  
**H<sub>∞</sub>** = Annual hours of chiller operation (hours), derived from the chiller schedule used in the DOE-2 simulation

Despite the disadvantages, the OTTV does offer a simple solution to give reasonably good estimates of heat gain in a building due to solar radiation through the windows, conduction through the walls and conduction through the windows. The OTTV formula in MS1525 (2007) is reproduced below as a reference.

$$OTTV_i (W/m^2) = 15\alpha (1 - WWR) U_w + 6 (WWR) U_f + (194 \times CF \times WWR \times SC)$$

Where:

- WWR is the window-to-gross exterior wall area ratio for the orientation under consideration
- $\alpha$  is the solar absorptivity of the opaque wall
- U<sub>w</sub> is the thermal transmittance of the opaque wall (W/m<sup>2</sup> K)
- U<sub>f</sub> is the thermal transmittance of the fenestration system (W/m<sup>2</sup> K)
- CF is the solar correction factor; as in MS1525 (2007) Table 4
- SC is the shading coefficient of the fenestration system

**TABLE 5.4 | MS1525, TABLE 4, SOLAR CORRECTION FACTORS**

Orientation	CF
North	0.90
Northeast	1.09
East	1.23
Southeast	1.13
South	0.92
Southwest	0.90
West	0.94
Northwest	0.90

Despite the disadvantages, OTTV does offer a simple solution to give reasonably good estimates of heat gain in a building

## 1 REPLACEMENT OF SC WITH SHGC IN OTTV

The term Shading Coefficient (SC) was proposed by the scientific communities in recent years to be discarded in favour of Solar Heat Gain Coefficient (SHGC), because the definition of SC is not sufficiently specific enough for industry use, while the definition of SHGC is simple and definite. In general, the SHGC can be approximated from the SC using this equation:  $SHGC = 0.87 \times SC$ . Replacing the SC with SHGC in the OTTV<sub>i</sub> equation in MS1525 will yield the new equation below.

$$OTTV_i \text{ (W/m}^2\text{)} = 15\alpha (1 - WWR) U_w + 6 (WWR) U_f + (222 \times CF \times WWR \times SHGC)$$

Where:

WWR	is the window-to-gross exterior wall area ratio for the orientation under consideration
$\alpha$	is the solar absorptivity of the opaque wall
$U_w$	is the thermal transmittance of the opaque wall (W/m <sup>2</sup> K)
$U_f$	is the thermal transmittance of the fenestration system (W/m <sup>2</sup> K)
CF	is the solar correction factor; as in MS1525 (2007) Table 4
SHGC	is the solar heat gain coefficient of the fenestration system

Interestingly, the solar factor of 222 W/m<sup>2</sup> in this equation was the original definition for the Malaysian OTTV. The solar factor was changed to 194 due to the common use of the Shading Coefficient term in the 1980s.<sup>6</sup>

## 2 USING OTTV TO ESTIMATE ENERGY REDUCTION

The OTTV equation itself can be used to estimate the annual energy reduction in an office building due to the differences in façade design. The definition of OTTV by ASHRAE 90, as the average chiller cooling load of a typical office building for the entire year, is the exact explanation on how OTTV can be used to estimate the cooling load reduction.

In summary, the energy saved due to the cooling load reduction (or addition) of a building in Malaysia due to a change in OTTV can be estimated using this equation below:

$$ER = \frac{(OTTV_1 - OTTV_2) A_w}{SCOP \times 1000} \times H_{ac}$$

Where:

ER	is the energy reduction per year (kWh/year)
OTTV <sub>1</sub>	is the computed OTTV based on option 1 (W/m <sup>2</sup> )
OTTV <sub>2</sub>	is the computed OTTV based on option 2 (W/m <sup>2</sup> )
$A_w$	is the area of the walls (inclusive of glazing areas) (m <sup>2</sup> )
SCOP	is the Air-Conditioning System Coefficient of Performance
$H_{ac}$	is the Hours of air-conditioning per year (approximately 2,700 hours)

The equation above is valid for buildings using a Constant Air Volume (CAV) system and is a good approximation for buildings using a Variable Air Volume (VAV) system. The SCOP can be approximated using these recommended values: 2.8 for a split-unit air-conditioning system, 4.0 for a centrifugal-based chilled water system. A more accurate SCOP can be approximated by the air-conditioning system designer based on the equipment used.

<sup>6</sup> JJ Deringer and JF Busch, Final Report of ASEAN-USAID Building Energy Conservation Project, 1992, pg. 8-7.

## CORRECT SOLAR FACTOR USED IN MS1525?

A study made in 2006 showed that the average solar factor of the Test Reference Year (TRY) weather data is significantly lower than the average solar factor used by the MS1525 (2007) OTTV formulation, 160 W/m<sup>2</sup> versus 194 W/m<sup>2</sup> respectively. These differences are due to the fact that the original MS1525 OTTV solar factor was derived from a few days of measurements made on a vertical surface in Penang in the 1980s, while the TRY is based on hourly analysis of solar radiation in Subang (refer to Chapter 2).

In addition, it was presented by the Malaysian Building Integrated PhotoVoltaic (MBIPV) project that Penang received a higher yearly solar irradiance (~1850 kWh/m<sup>2</sup>), approximately 23% more than the Klang Valley (~1500 kWh/m<sup>2</sup>) where Subang is located. Meanwhile, the measured solar factor of 194 W/m<sup>2</sup> in Penang is 21% higher than the solar factor of 160 W/m<sup>2</sup> in Subang derived from the TRY weather data. In summary, the information provided by the MBIPV project seems to indicate that both solar factors are correct, each for its own location. However, further studies are recommended to validate these observations and to make changes to the OTTV if necessary.

The correct solar factor will yield the correct computation of solar heat gain in building. It is recommended that further research be conducted to establish the correct solar factors to be used in the MS1525. In the meantime, please be aware that the values computed using the current version of OTTV (2007) will predict a higher solar heat gain for buildings located in Kuala Lumpur when compared to the TRY weather data used by energy simulation tools.

---

## SUMMARY

This chapter provides important tips on glazing properties and selection criteria for energy efficiency in buildings. Important glazing terminologies such as Visible Light Transmission (VLT), Solar Heat Gain Coefficient (SHGC) and Light-to-Solar Gain ratio (LSG) were presented as the key selection criteria for energy efficiency in buildings. In addition, important glazing technologies such as hard-coat and soft-coat low-emissivity (low-e) coatings and their relationship to the LSG were also presented to allow building designers to make quick design decisions based on the budget available for these technologies. Estimates of running cost and energy savings due to energy efficiency improvements from the use of glazing technologies for the Malaysian climate zone were also presented. Building designers are recommended to make use of such estimates to evaluate the feasibility of using better glazing technologies.

---

### END OF CHAPTER 5

---

<sup>2</sup>CK Tang, Dr. K.S. Kannan, Ole Blashev Olesen, Steve A. Lojuntin, Dr. BG Yeoh, A Review of the OTTV Formulation in the Support of Energy Efficiency Code for Non-domestic building, MS 1525, May 2006, Prepared for the Danida program in Malaysia (2004-2006).

<sup>3</sup>Ir. Ahmad Hadri Haris, MBIPV Project: Catalyzing Local PV Market, Finance & Investment Forum on PV Technology, 17th March 2008, Kuala Lumpur Tower

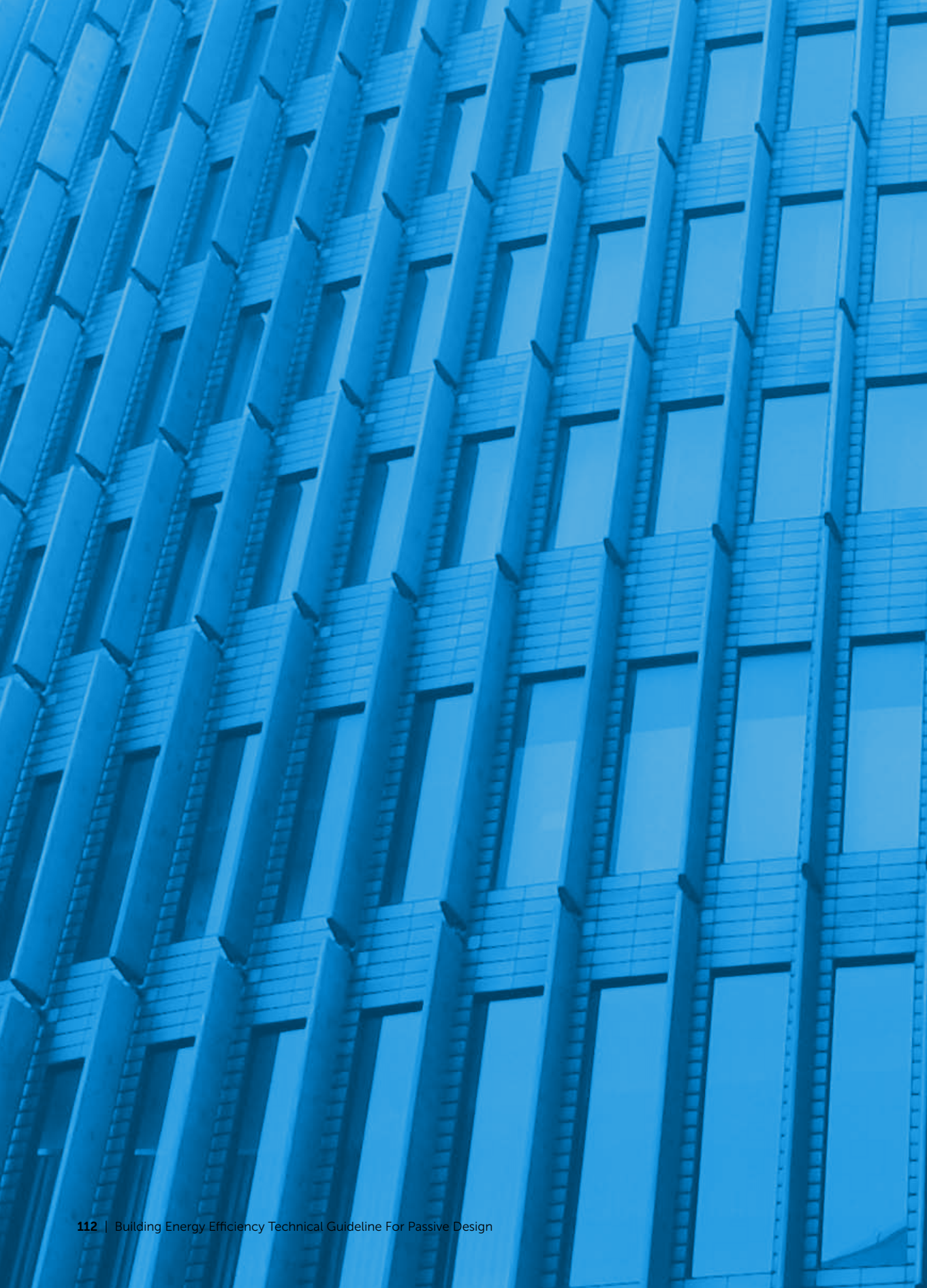
CHAPTER

# 6

## EXTERNAL & INTERNAL SHADES









## 6

EXTERNAL &  
INTERNAL SHADES

## INTRODUCTION

The use of external shades has been well promoted by many architectural books as essential solution to energy efficiency and thermal comfort in a tropical climate. Meanwhile, improvements in glazing technologies (refer to Chapter 5) has enabled buildings today to be built without the use of external shading devices while still complying with the respective country's energy codes. In addition, there exists internal shading devices in the market that claim to reduce solar heat gain in a building by 80% or more. This chapter explores whether it is beneficial to combine all these technologies together and how they should be combined to optimise the efficiency in a building.

## ECONOMIC JUSTIFICATION

High-performance double glazing technology that reduces solar heat gain significantly while maintaining high visible light transmission is significantly more expensive compared to the typical single glazing that is commonly used today by the building industry in Malaysia.

A high-performance double glazing unit has two pieces of glazing, low-e coating, spacer, sealant and a larger window frame as compared to a typical single glazing unit. Meanwhile, depending on the choice of material, the cost of external sun shading devices may be higher (or lower) than the cost of investing in high-performance double glazing units.

Finally, internal blinds may be the most economical solution initially, but it may need to be replaced at regular intervals and also has a number of issues that need to be addressed carefully to ensure that its energy efficiency performance is not compromised in practice.

LEGITIMATE USE OF INTERNAL SHADES  
TO REDUCE SOLAR HEAT GAIN

The use of internal shades as a primary solar heat reduction solution is not known to be practiced in the Malaysian building industry. This is largely due to the fact that internal shades are generally less effective in controlling solar heat gain than the use of external shades and glazing technologies. However, there exists real and practical solutions in the market where the use of internal shades can reduce the solar heat gain in a building significantly. In short, the consideration of internal shades to reduce solar heat gain in a building is a real and legitimate solution. However, the risk associated with internal shades should be addressed carefully by building designers and is highlighted in this chapter.

Finally, the reduction of energy and peak cooling load from the use of external and internal shades is not well-known in the Malaysian building industry. Chapter 6 offers a methodology derived from Chapter 5 to provide an estimate of the energy and peak load reduction due to the use of external and internal shades on windows. In addition, this chapter provides guidance on the use of internal shades to reduce energy consumption in buildings.

# KEY RECOMMENDATIONS

The total SHGC of any fenestration system can be estimated using the following equation:

$$SHGC_{total} = SHGC_{ext} \times SHGC_{glz} \times SHGC_{int}$$

Where:

SHGC<sub>total</sub> is the energy reduction per year (kWh/year)

SHGC<sub>ext</sub> is the Solar Heat Gain Coefficient of external shading devices (1, if no external shading device is used)

SHGC<sub>glz</sub> is the Solar Heat Gain Coefficient of the glazing

SHGC<sub>int</sub> is the Solar Heat Gain Coefficient of internal shading devices (1, if no internal shading devices is used)

The equation above signifies that the SHGC values of external shades, glazing and internal shades have equal weightage in its ability to reduce solar heat gain in buildings. In addition, since it is a multiplication of these three SHGC terms, as long as any one of the three SHGC terms is reduced to a significantly low value, the result will be a low solar heat gain for that fenestration unit. Alternatively, it is also possible to reduce the SHGC values marginally on all three SHGC terms to reach the same performance. The possible design variations are highlighted in **Table 6.1** below.

**TABLE 6.1 | SHGC TOTAL COMPUTED FROM VARIOUS POTENTIAL DESIGN COMBINATIONS**

Case	Description	SHGC ext shades	SHGC glazing	SHGC int shades	Computed SHGC total	% SHGC reduction	Potential VLT allowed into building*
1	Poorly designed façade	1.00	0.87	1.00	<b>0.87</b>	<b>0%</b>	<b>70% - 90%</b>
2	Only 1 item done well	1.00	<u>0.30</u>	1.00	<b>0.30</b>	<b>66%</b>	<b>10% - 60%</b>
3	Only 1 item done well	1.00	0.87	<u>0.30</u>	<b>0.87</b> (Open internal blind) <b>0.26</b> (Closed internal blind)	<b>70%</b> (Closed internal blind)	<b>70% - 90%</b> (Open internal blind) <b>0% - 10%</b> (Closed internal blind)
4	Two (2) items done moderately well	<u>0.70</u>	<u>0.50</u>	1.00	<b>0.35</b>	<b>60%</b>	<b>25% - 70%</b>
5	All 3 items done moderately well	<u>0.70</u>	<u>0.50</u>	<u>0.70</u>	<b>0.35</b> (Open internal blind) <b>0.25</b> (Closed internal blind)	<b>72%</b> (Closed internal blind)	<b>25% - 70%</b> (Open internal blind) <b>0% - 30%</b> (Closed internal blind)
6	All 3 items done well	<u>0.50</u>	<u>0.30</u>	<u>0.50</u>	<b>0.15</b> (Open internal blind) <b>0.08</b> (Closed internal blind)	<b>91%</b> (Closed internal blind)	<b>10% - 60%</b> (Open internal blind) <b>0% - 10%</b> (Closed internal blind)

\* Varies depending on the properties of glazing, external and internal shading devices selected.

There are many potential combinations to reduce the solar heat gain in a building by 60% or more. **Table 6.1** shows a range of potential design options to reduce solar heat gain from a façade by a minimum of 60% in comparison to Case 1. Case 1 is the base case of a single clear glazing without any external or internal shades. These potential solutions are summarised here:

<p><b>Case 1</b></p> <p><b>Poorly designed façade</b></p> <p>Base Case. Single clear glazing without external or internal shading provided.</p>	<p><b>Case 2</b></p> <p><b>Only 1 item done well</b></p> <p>Use of a high-performance double glazing.</p> <p><b>66% SHGC reduction compared to Case 1</b></p>	<p><b>Case 3</b></p> <p><b>Only 1 item done well</b></p> <p>Use of a highly reflective internal blind</p> <p><b>70% SHGC reduction compared to Case 1</b></p>
<p><b>Case 4</b></p> <p><b>Two (2) items done moderately well</b></p> <p>Use of an external horizontal shade with a R1<sup>1</sup> ratio of 0.35 or higher and a slightly tinted single low-e glazing.</p> <p><b>60% SHGC reduction compared to Case 1</b></p>	<p><b>Case 5</b></p> <p><b>All 3 items done moderately well</b></p> <p>Use of an external horizontal shade with R1 ratio of 0.35 or higher, a slightly tinted single low-e glazing and a light coloured reflective internal blind.</p> <p><b>72% SHGC reduction compared to Case 1</b></p>	<p><b>Case 6</b></p> <p><b>All 3 items done well</b></p> <p>Use of an external horizontal shade with a R1 ratio of 1.0 or higher, a high-performance double glazing and a highly reflective internal blind.</p> <p><b>91% SHGC reduction compared to Case 1</b></p>

An approximate estimate of the potential visible light transmitted into the building due to the use of these three (3) SHGC terms to reduce solar heat gain in a building is also provided in **Table 6.1** as an indication for architects to make a quick decision. It is also important to note that the visible light transmission value varies significantly depending on the properties (and design) of the glazing, external and internal shading devices used. However, it can be summarised that it is possible to allow as much as 70% visible light transmission into the building while still providing a solar heat gain reduction of 60% to 90%.

It can be summarised that it is possible to allow as much as 70% visible light transmission into the building while still providing a solar heat gain reduction of 60% to 90%

<sup>1</sup>Figure 6.31: Definition of R1 ratio for Horizontal Shades

## ESTIMATING SHGC VALUES

### SHGC OF GLAZING

A brief note on the estimation of the SHGC of glazing is provided below, however more details can be found in Chapter 5.

The SHGC of glazing is normally provided by glazing suppliers and it ranges from a high of 0.87 (a single clear glazing) to a typical low of 0.20. It is also possible to estimate the potential SHGC in the absence of supplier's information, based on the visible light transmission of glazing desired for the building and the Light to Solar Gain ratio (LSG) of different glazing technologies using the equation below.

$$\text{SHGC} = \frac{\text{VLT}}{\text{LSG}}$$

Where:

SHGC is the Solar Heat Gain Coefficient of the Glazing (%)

VLT is the Visible Light Transmission of the Glazing (%)

LSG is the Light to Solar Gain Ratio of the Glazing

**Depending on the glazing colour and technology used, LSG can be approximated by these numbers:**

- Single glazing **without** low-e properties has typical LSG values of 0.5 to 1.0
- Single glazing **with** low-e properties has typical LSG values of 0.95 to 1.3
- High-performance double glazing **with** low-e properties has typical LSG values of 1.5 to 2.0
- Colours such as Green, Clear or Blue usually have higher limits of LSG values; while
- Colours such as Bronze or Red usually have lower limits of LSG values.

### SHGC OF EXTERNAL SHADES

The SHGC of external shading devices is provided in this chapter in **Table 6.3.1.1** for horizontal shades, **Table 6.3.3** for vertical shades and **Table 6.3.4** for combined horizontal and vertical shades. SHGC of external shading devices range from 1.0 (no external shading devices used) to a potential low of 0.33 on the East façade using a combination of large horizontal and vertical shades.

### SHGC OF INTERNAL SHADES

The SHGC of internal shading devices is provided in **Table 6.4**. The SHGC of internal shading devices range from 1.0 (no internal shades) to a potential low of 0.20 using a reflective internal blind. It is important to note that the SHGC value of the same internal shading device is different depending on the type of glazing it is combined with. For example, the SHGC of an internal reflective white opaque roller blind is 0.32 for a single clear glazing, 0.46 for single green glazing and 0.68 for a bronze low-e double glazing unit.

## ESTIMATING ENERGY SAVED

Through an energy simulation study, it was found that the data from **Table 5.2.1** from **Chapter 5** offers a fairly good estimate of the energy saved from reduction of the SHGC. **Table 5.2.1** is reproduced below as **Table 6.2** with percentage improvement shown from the South orientation:

**TABLE 6.2 | ENERGY REDUCTION PER GLAZING AREA PER SHGC REDUCTION (EXTRACTED FROM TABLE 5.2.1 IN CHAPTER 5)**

Preference	Orientation	Energy Reduction (per year) Per Glazing Area Per SHGC Reduction (kWh/m <sup>2</sup> SHGC of glazing area)	% Improvement Compared to South Orientation
1	East	150	49%
2	West	130	30%
3	North	120	15%
4	South	100	0%

**Table 6.2** indicates that it is most energy efficient to reduce the SHGC in fenestration on the East façade. Provision of shading devices or glazing technologies that reduces SHGC values will provide the quickest payback for the East façade, followed by West, North and lastly South façades. This also indicates that it may be justifiable to use more expensive materials to reduce the SHGC on the Eastern façade than on the Southern façade.

### CALCULATION EXAMPLE 1 - USE OF TABLE 6.2

#### Base Design:

East Façade: 3,000 m<sup>2</sup>, Single Glazing, SHGC 0.87

#### Revised Design:

East Façade: 3,000 m<sup>2</sup>

- Single Glazing Green Tinted, SHGC<sub>glz</sub> = 0.60  
Additional Cost: RM30/m<sup>2</sup> of glazing area
- Horizontal External Concrete Shades, SHGC<sub>ext</sub> = 0.74 (R1=0.35 from Table 6.3.1.1)  
Additional Cost: RM80,000 for 3,000 m<sup>2</sup> glazing area
- Light Coloured Open Weaved Roller Shades, SHGC<sub>int</sub> = 0.71 (Table 6.4)  
Additional Cost: Zero (because it is already provided for in the base design)

#### Calculations:

##### East Façade:

Total Revised Design SHGC = 0.60 x 0.74 x 0.71 = 0.315

SHGC Reduction = 0.87 - 0.315 = 0.555

Energy Reduction for East Façade: 150 kWh/m<sup>2</sup>.SHGC (Table 6.2)

Energy Reduction per Year: 150 kWh/m<sup>2</sup>.SHGC x 0.555 x 3,000 m<sup>2</sup> = 249,750 kWh/year

Assuming Energy Tariff of RM0.35/kWh:

Energy Saved Per Year = 249,750 kWh/year x 0.35 RM/kWh = RM87,412/year

Total Additional Cost (RM):

- Glazing, RM30/m<sup>2</sup> x 3,000 m<sup>2</sup> = RM90,000
- External Shades = RM80,000
- Internal Shades = RM0
- Total Additional Cost = RM170,000

Simple Payback = RM170,000 / RM 87,412 = 2 years

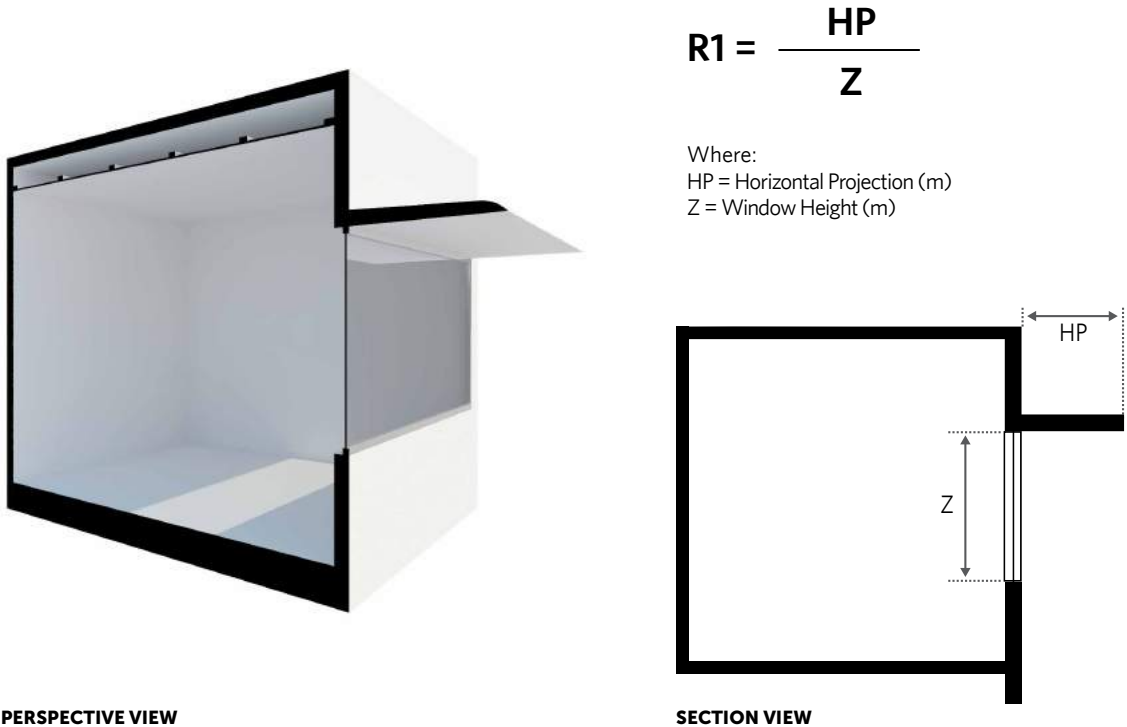
# EXTERNAL SHADING DEVICES

An energy simulation study was conducted to derive the average yearly SHGC of external blinds. These simulation studies accounted for the reduction of solar gain due to direct and diffuse shading on a window. The energy simulation study was based on a full year, 8,760 hours of weather data in the Test Reference Year of Malaysia (Chapter 2).

## HORIZONTAL SHADING DEVICES

The default MS1525 (2007) definition of horizontal shading device is used in this chapter and is shown in **Figure 6.3.1** below. In addition, it is quite common to find horizontal projections that are not placed immediately above the window, but at a distance offset from the top of the window. The SHGC computation for “offset” horizontal projection is provided in the next section.

**FIGURE 6.3.1 | DEFINITION OF R1 RATIO FOR HORIZONTAL SHADES**



The SHGC of using horizontal shades in this climate is provided in **Table 6.3.1.1**. These numbers are derived from energy simulation studies. It can be observed from the table that the difference of SHGC from the use of horizontal external shades for different façade orientations is relatively small. This could be due to the significantly higher diffuse solar radiation (as compared to the direct solar radiation) of the weather data in the Test Reference Year of Malaysia (Chapter 2).

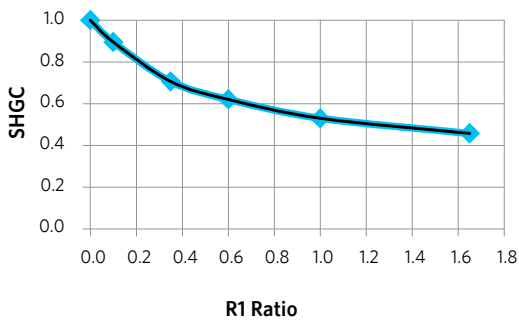
**TABLE 6.3.1.1 | SHGC OF HORIZONTAL SHADES BASED ON R1 RATIO**

R1	1.65	1.00	0.60	0.35	0.10	0.00
SHGC North	0.46	0.53	0.62	0.71	0.90	1.00
SHGC South	0.45	0.52	0.60	0.71	0.90	1.00
SHGC East	0.39	0.49	0.61	0.74	0.91	1.00
SHGC West	0.45	0.53	0.64	0.75	0.92	1.00

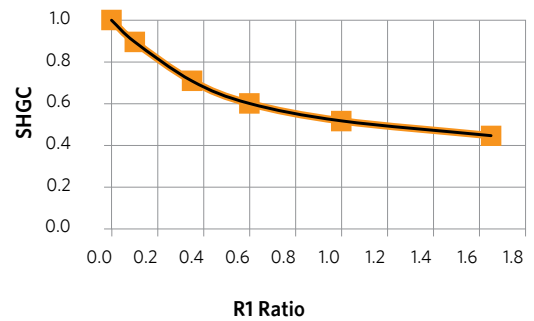
**Chart 6.3.1.1** and **Table 6.3.1.2** provides the curve fit equations for various R1 ratios for different orientations. This information is provided to give exact estimates of the SHGC value from any R1 value.

**CHART 6.3.1.1 | SHGC CURVE FITS FOR HORIZONTAL SHADES FOR NORTH, SOUTH, EAST & WEST ORIENTATIONS**

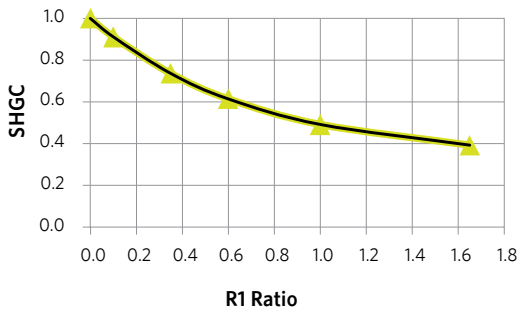
**Curve Fit for North Horizontal Shades**



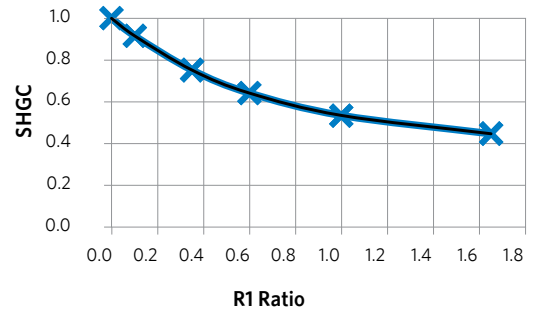
**Curve Fit for South Horizontal Shades**



**Curve Fit for East Horizontal Shades**



**Curve Fit for West Horizontal Shades**

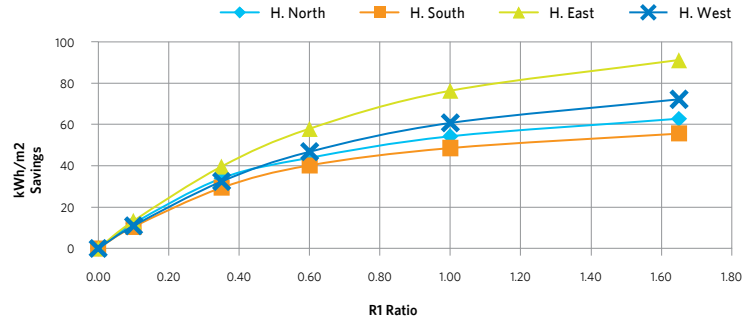


**TABLE 6.3.1.2 | SHGC CURVE FIT EQUATION, WHERE: X IS R1 RATIO**

Orientation	SHGC Curve Fit Equation	R <sup>2</sup>
North	SHGC = 0.2352x <sup>4</sup> - 0.9596x <sup>3</sup> + 1.4948x <sup>2</sup> - 1.2394x + 1	0.9997
South	SHGC = 0.0665x <sup>4</sup> - 0.4373x <sup>3</sup> + 1.0276x <sup>2</sup> - 1.139x + 1	1.0000
East	SHGC = -0.1238x <sup>3</sup> + 0.5428x <sup>2</sup> - 0.9267x + 1	1.0000
West	SHGC = -0.132x <sup>3</sup> + 0.5488x <sup>2</sup> - 0.8813x + 1	1.0000

Chart 6.3.1.2 provides the energy reduction for each orientation of the building, assuming a single clear glazing is used. The energy reduction can be estimated from this chart with information of the glazing area, orientation of the window and R1 ratio. This chart is created from the combination of Table 6.2 and Table 6.3.1.1. Although the SHGC value for all orientations of the building is similar for the same R1 ratio, the energy reduction is significantly higher on the East façade, followed by the West, then North and lastly South façade. Refer to Chapter 5 for more details on the influence different façade orientations on SHGC reduction.

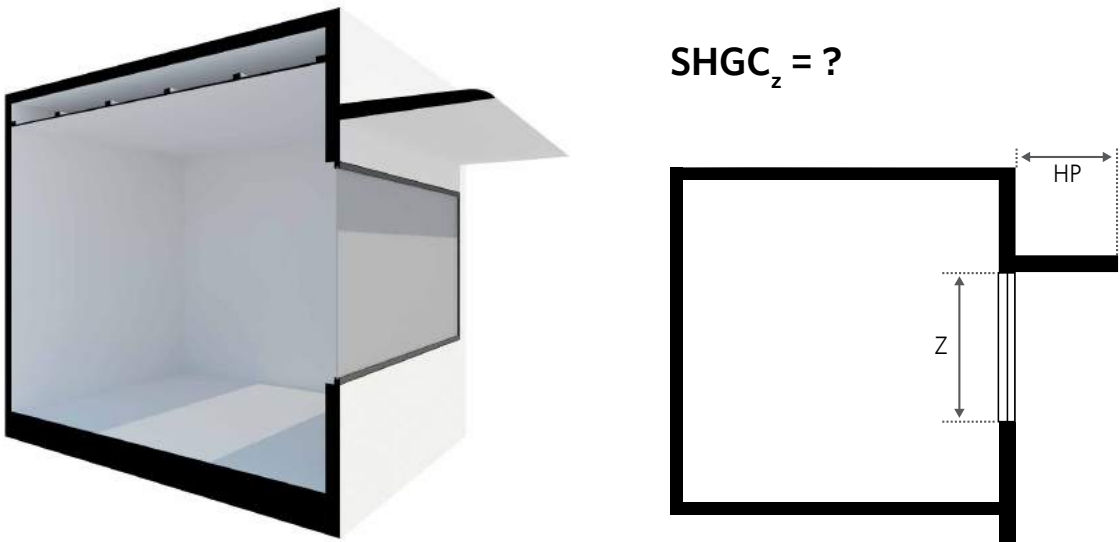
**CHART 6.3.1.2 | KWH OF ENERGY SAVINGS PER GLAZING AREA DUE TO THE PROVISION OF HORIZONTAL SHADING DEVICE**



## ESTIMATING THE SHGC OF HORIZONTAL SHADING DEVICES WITH OFFSET DISTANCE

Figure 6.3.2.1 below describes a very common scenario found in building design. It has been observed that many architects and engineers are using many different methods to estimate the SHGC of horizontal shading devices for the window. The appropriate method to estimate the SHGC for the window is provided in this section.

**FIGURE 6.3.2.1 | HORIZONTAL EXTERNAL SHADING DEVICES WITH OFFSET**



**PERSPECTIVE VIEW**

**SECTION VIEW**



The following assumptions can be made as shown from **Figure 6.3.2.2** and **Figure 6.3.2.3**:

$$Q_{solarT} = Q_{solarY} + Q_{solarZ}$$

Where,

$Q_{solarT}$  = Total solar radiation received by Window (T)

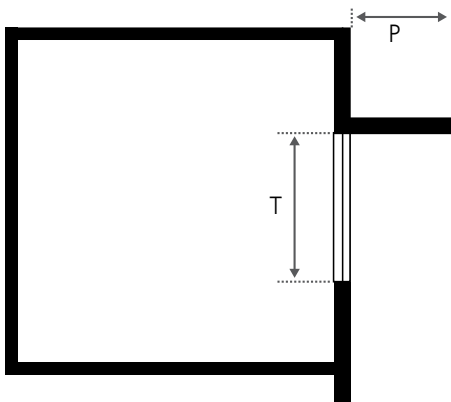
$Q_{solarY}$  = Total solar radiation received by Window (Y)

$Q_{solarZ}$  = Total solar radiation received by Window (Z)

**FIGURE 6.3.2.2 | SIMPLIFICATION 1**



**PERSPECTIVE VIEW**

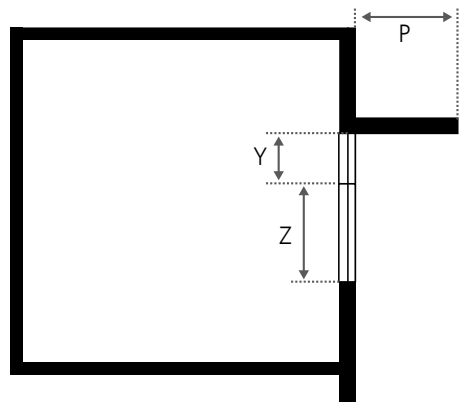


**SECTION VIEW**

**FIGURE 6.3.2.3 | SIMPLIFICATION 2**



**PERSPECTIVE VIEW**



**SECTION VIEW**

Based on the OTTV equation, the solar portion of the window can be written as:

$$Q_{\text{solarT}} = A_t \times 194 \times CF \times SHGC_t$$

$$Q_{\text{solarY}} = A_y \times 194 \times CF \times SHGC_y$$

$$Q_{\text{solarZ}} = A_z \times 194 \times CF \times SHGC_z$$

Where:

$A_t$  = Size of Window T = T x Depth

$A_y$  = Size of Window Y = Y x Depth

$A_z$  = Size of Window Z = Z x Depth

$SHGC_t$  = SHGC of Window T (available from Table 6.3.1.1 with R1 ratio of P/T)

$SHGC_y$  = SHGC of Window Y (available from Table 6.3.1.1 with R1 ratio of P/Y)

$SHGC_z$  = SHGC of Window Z

CF = Correction Factor = same for all 3 windows because they all face the same direction

The solar equation can be rewritten:

$$T \times \text{Depth} \times 194 \times CF \times SHGC_t = (Y \times \text{Depth} \times 194 \times CF \times SHGC_y) + (Z \times \text{Depth} \times 194 \times CF \times SHGC_z)$$

Rewritten as:

$$SHGC_z = \frac{(T \times SHGC_t) - (Y \times SHGC_y)}{Z}$$

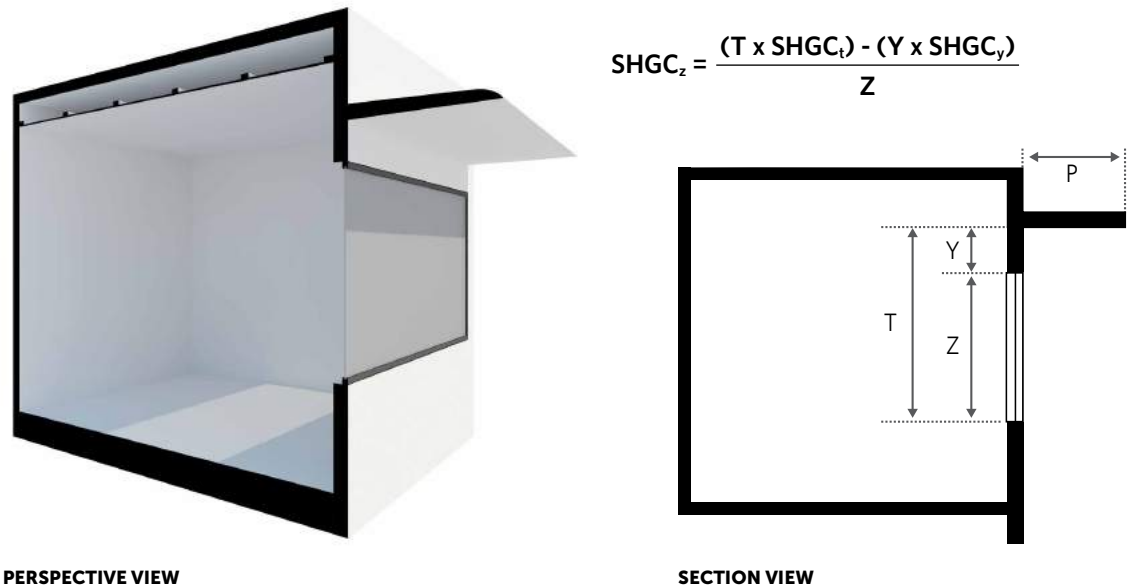
Where:

$SHGC_t$  = SHGC of Window T (available from Table 6.3.1.1 with R1 ratio of P/T)

$SHGC_y$  = SHGC of Window Y (available from Table 6.3.1.1 with R1 ratio of P/Y)

T, Y and Z = respective window height

**FIGURE 6.3.2.4 | SOLUTION TO CALCULATE THE SHGC OF FENESTRATION WITH OFFSET HORIZONTAL PROJECTIONS**



## VERTICAL SHADING DEVICES

The default MS1525 (2007) definition of vertical shading device is used in this chapter and is shown in **Figure 6.3.3**. The vertical shading device is assumed to be placed on both the right and left side of the window.

The SHGC of using vertical shades in this climate is provided in **Table 6.3.3**. These numbers are derived from energy simulation studies. It can be seen from the table that the differences of SHGC value from the use of vertical external shade for different orientations are split between the North/South and East/West façade orientation. The SHGC values of the North/South façade are notably lower than the East/West façade with the use of vertical shading devices.

**FIGURE 6.3.3 | DEFINITION OF R2 RATIO FOR VERTICAL SHADES**



$$R2 = \frac{VP}{L}$$

Where:  
 VP = Vertical Projection (m)  
 L = Window Width (m)

**TABLE 6.3.3 | SHGC VERTICAL SHADES, R2**

R2	1.65	1.00	0.60	0.35	0.10	0.00
SHGC North	0.70	0.73	0.77	0.82	0.93	1.00
SHGC South	0.70	0.73	0.77	0.82	0.93	1.00
SHGC East	0.75	0.78	0.82	0.87	0.95	1.00
SHGC West	0.74	0.77	0.81	0.86	0.95	1.00

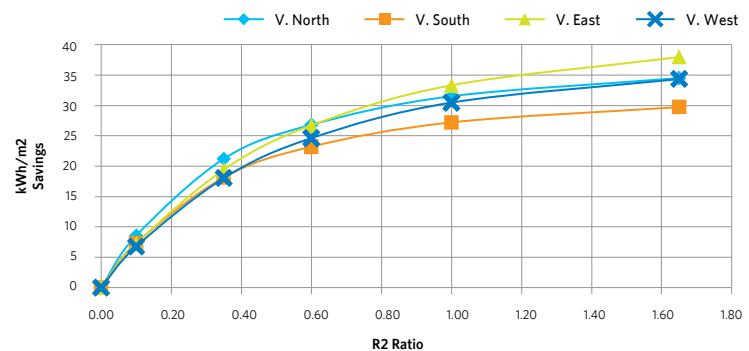
**Chart 6.3.3** provides the energy reduction for each orientation of the building, assuming a single clear glazing is used. The energy reduction can be estimated from this chart with information of the glazing area, orientation of the window and R2 ratio. This chart is created from the combination of **Table 6.2** and **Table 6.3.3**. Although the SHGC values are lower on the North/South façade when compared to the East/West façade, the energy reduction is similar for all façade orientations with the same R2 ratio. Refer to Chapter 5 for more details on the influence of SHGC reduction by different façade orientations.

In addition, vertical shades provide a maximum energy reduction of 38kWh/m<sup>2</sup> (m<sup>2</sup> of glazing area) per year as compared to horizontal shades which provide an energy reduction

of up to 91kWh/m<sup>2</sup> (m<sup>2</sup> of glazing area) per year. This indicates that horizontal shades are approximately 2.4 times more effective than the use of vertical shades for the same shading ratio used. Moreover, vertical shading devices require 2 pieces of

shades (one on the right side and one on the left side of the window), while horizontal shading devices require only 1 piece of shade (at the top of the window) to provide these potential energy reductions.

**CHART 6.3.3 | KWH OF ENERGY SAVINGS PER GLAZING AREA DUE TO THE PROVISION OF VERTICAL SHADING DEVICE**



## COMBINED HORIZONTAL AND VERTICAL SHADES

The default MS1525 (2007) definition of combined horizontal and vertical shading devices is used in this section.

The SHGC values of combined horizontal and vertical shades are provided in **Table 6.3.4** below.

**TABLE 6.3.4 | SHGC OF COMBINED HORIZONTAL AND VERTICAL SHADES, R1 & R2**

R1	1.50	1.00	1.00	1.00	0.80	0.80	0.60	0.60	0.40	0.40	0.40	0.20	0.20	0.20
R2	1.00	1.60	0.90	0.30	1.30	0.40	1.30	0.40	1.60	0.90	0.30	1.20	0.50	0.20
<b>North</b>	0.38	0.38	0.41	0.51	0.41	0.50	0.43	0.52	0.46	0.49	0.59	0.55	0.62	0.71
<b>South</b>	0.37	0.37	0.40	0.50	0.40	0.49	0.42	0.51	0.46	0.49	0.59	0.56	0.62	0.71
<b>East</b>	0.33	0.35	0.39	0.48	0.39	0.49	0.44	0.54	0.50	0.54	0.63	0.62	0.69	0.77
<b>West</b>	0.38	0.38	0.41	0.51	0.41	0.50	0.43	0.52	0.46	0.49	0.59	0.55	0.62	0.71

## ESTIMATING ENERGY REDUCTION

It was found from the simulation studies that the factors derived in Chapter 5 for the reduction of the SHGC in single glazing can be used to estimate the peak cooling load and energy reduction for the external shading devices. **Table 5.2.1** is reproduced below for ease of looking up the data. Refer to Chapter 5 for more details.

**TABLE 5.2.1 | ENERGY AND PEAK LOAD IMPACT OF REDUCING OF SHGC, IN SINGLE GLAZING**

Orientation	North	South	East	West
Energy Reduction (per year) Per Glazing Area Per SHGC Reduction (kWh/m <sup>2</sup> of SHGC of glazing area reduction)	120	100	150	130
*RM Reduction (per year) Per Glazing Area Per SHGC Reduction (RM/m <sup>2</sup> of SHGC of glazing area reduction)	40	35	53	46
**Peak Cooling Load Reduction Per Glazing Area Per SHGC Reduction (W/m <sup>2</sup> of SHGC of glazing area reduction)	270	140	310	360

\*A simplified energy tariff of RM0.35 per kWh is used.

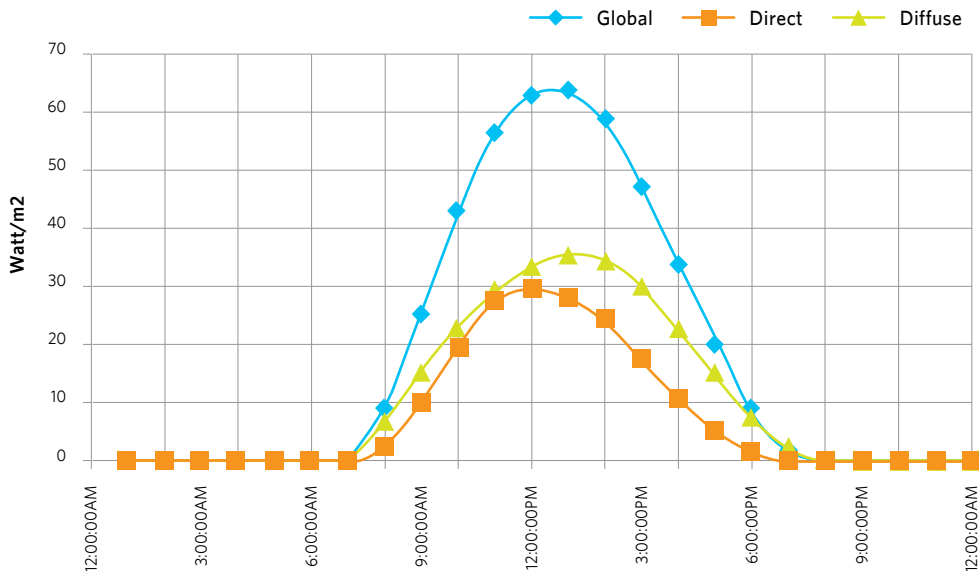
\*\*Only applicable for buildings with glazing area distributed evenly on all orientations.

# INTERNAL SHADING DEVICES

Both external and internal shades control heat gain. In general, external shades are more effective than internal shades because they block the solar radiation before it enters the building. When using an internal shade, such as blinds or a curtain, the short-wave radiation passes through the glass and hits the shade. Depending on the colour and reflectivity of the shade, some percentage will be reflected straight back out the window, but the rest will be absorbed by the shade itself, effectively heating it up.

The energy from the hot internal shade is then given off as long-wave radiation, half into the room space and half towards the window. Unfortunately, due to the greenhouse effect, long-wave radiation is trapped between the glass and the internal shade, heating the air within this space. This heated air will rise, exit at the top and draw in cooler air from below, creating a form of convection cycle that continually draws cool air from the bottom of the space, heats it up and pushes it out into the room.

**CHART 6.4 | AVERAGE DAILY RADIATION DATA FOR SUBANG TEST REFERENCE YEAR**



However, if the right type of internal shade is used in this tropical climate zone, it can outperform external shading devices. To understand this, it is useful to revisit the distribution of direct and diffuse solar radiation in the Malaysian climate.

The Malaysian Test Reference Year solar radiation data (Chapter 2) showed that the average daily diffuse radiation is higher than the direct radiation. Over the entire year, on a horizontal surface, the sum of diffuse radiation is 44% higher than the sum of direct radiation. The total solar

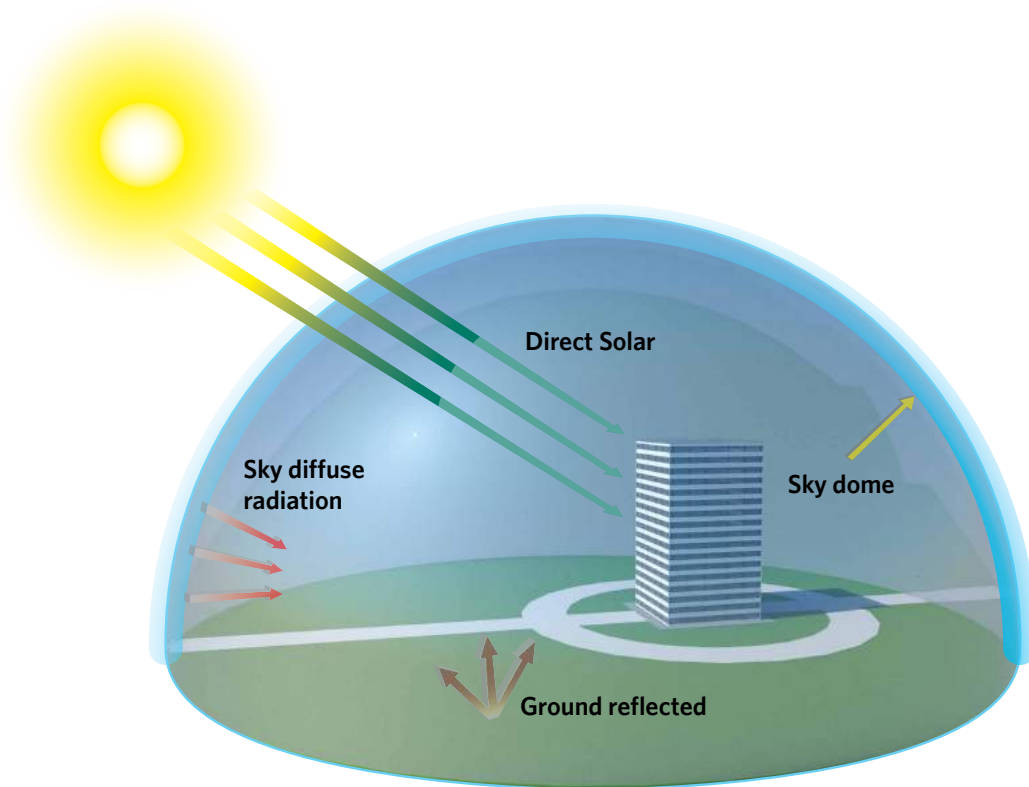
heat gain received by a window is the sum of both direct and diffuse radiation.

On any vertical surface, without any external shading devices, only 50% of diffuse solar radiation is captured by the window because it is only exposed to half the sky dome. If the same window is added with external shading devices, the percentage of diffuse solar radiation captured by the window is dependent on its view factor of the sky and ground reflected diffuse radiation. Due to the fact that typical external shading

devices are designed to prevent heat gain from direct solar radiation while maintaining a good view out of the building, the reduction of diffuse radiation will not be as significant.

Moreover, it is fairly easy to design external shading devices that will provide full (or nearly full) protection from direct radiation without affecting the view out of the building. However, it is almost impossible to design external shading devices to provide full (or nearly full) protection from diffuse radiation without significantly affecting the view out.

FIGURE 6.4 | PRINCIPLES OF DIRECT AND DIFFUSE RADIATION



## REFLECTIVE INTERNAL BLINDS

As mentioned earlier, the use of internal shading devices are, in general, less effective than the use of external shading devices. However, it was shown by R. McCluney and L. Mills that internal shading devices that reflect solar heat gain back out of the window provides a significant reduction of Solar Heat Gain Coefficient (SHGC)<sup>2</sup>. Internal blinds that are highly reflective towards the window will reject the solar radiation out of the window before it is absorbed by the interior furnishings or building materials. A SHGC value as low as 0.2 (with a blind surface

reflectance of 0.8) was reported by R. McCluney and L. Mills from the use of such internal blinds on a single clear glazing. In comparison, the lowest SHGC provided by external shades in this climate is 0.33 on the Eastern façade and it requires the use of significantly large combined horizontal and vertical shading devices to achieve it (which can be quite unsightly!).

It should also be noted that reflective internal blinds work best with single clear glazing that allows the reflected solar radiation from the

reflective blind to exit the interior space. In buildings with good glazing properties (those with low SHGC), the amount of heat that can be rejected out by reflective blinds are reduced due to the properties of the glazing that hinders the solar heat transmission, either by absorption or rejection of solar radiation. However, the use of good glazing properties would have reduced the heat gain into the building, reducing the need for a good reflective internal blind to be used.

<sup>2</sup>Effect of Interior Shades on Window Solar Gain, by R. McCluney and L.Mills, Proc. ASHRAE Transaction, Vol. 99, Pt. 2, 1993, pp. 565-570.

## SHGC OF INTERNAL SHADES

The SHGC of internal shades are available from some blind/curtain suppliers in Malaysia. However, the SHGC provided by these suppliers are normally applicable when the blind/curtain is combined with single clear glazing. It is very important to note that the SHGC of internal shades is dependent on the type of glazing it is combined with. One common method to obtain exact SHGC values of internal blinds with the glazing used is through the use of the calorimeter measurement methodology. This method is said to be both time consuming and economically unattractive.

An alternative to obtain the SHGC of internal shades is to use the tables provided by ASHRAE. The ASHRAE Fundamentals handbook provides a number of tables on the SHGC of various internal blinds based on the type of glazing it is combined with. A selection of SHGC of internal shading devices is provided in **Table 6.4**. A more comprehensive version is found in the ASHRAE handbook.

From **Table 6.4**, it can be summarised that dark coloured internal shades have higher SHGC values than lighter coloured internal shades, indicating that the solar heat gain of dark blinds/curtains are higher than lighter coloured ones. In addition, the same internal shade that provides a low SHGC internal blind value of 0.25 when it is used in combination with a single clear glazing (SHGC glazing of 0.81) has a different SHGC value of 0.64, when it is used in combination with a Bronze Low-e Double Glazing (SHGC glazing of 0.26). This indicates that the effectiveness of internal blinds is dependent on the type of glazing used. Users of **Table 6.4** should be aware of this and not use the 1st SHGC value found for type the internal shades used.

Again, it is also possible to use the factors found in **Table 5.2.1** to estimate the peak cooling load and energy reduction of the fenestration unit based on the total reduction of the SHGC.

**TABLE 6.4 | A SELECTION OF ASHRAE SHGC VALUES OF INTERNAL SHADES<sup>3</sup>**

6mm Single Glazing					SHGC of Draperies, Roller Shades and Insect Screens					
Ashrae ID	Description	VLT	SHGC glazing	LSG	Dark Closed Weave	Light Closed Weave	Dark Open Weave	Light Open Weave	Sheer	
1b	Clear	88%	0.81	1.09	0.71	0.46	0.80	0.65	0.73	
1d	Bronze	54%	0.62	0.87	0.74	0.55	0.82	0.71	0.77	
1f	Green	76%	0.6	1.27	0.74	0.56	0.83	0.71	0.78	
1h	Grey	46%	0.59	0.78	0.74	0.56	0.83	0.72	0.78	
6mm Single Glazing					SHGC of Roller Shades and Insect Screens					
Ashrae ID	Description	VLT	SHGC glazing	LSG	White Opaque	Dark Opaque	Light Gray Translucent	Dark Grey Translucent	Reflective White Opaque	Reflective White Translucent
1b	Clear	88%	0.81	1.09	0.35	0.65	0.62	0.72	0.32	0.25
1d	Bronze	54%	0.62	0.87	0.47	0.69	0.68	0.76	0.45	0.39
1f	Green	76%	0.60	1.27	0.48	0.70	0.68	0.76	0.46	0.40
1h	Grey	46%	0.59	0.78	0.49	0.70	0.69	0.76	0.47	0.41
Low-e Double Glazing, e=0.02 on surface 2					SHGC of Draperies, Roller Shades and Insect Screens					
Ashrae ID	Description	VLT	SHGC glazing	LSG	Dark Closed Weave	Light Closed Weave	Dark Open Weave	Light Open Weave	Sheer	
25b	Clear	70%	0.37	1.89	0.89	0.72	0.93	0.82	0.86	
25c	Bronze	42%	0.26	1.62	0.90	0.76	0.94	0.85	0.88	
25d	Green	60%	0.31	1.94	0.90	0.76	0.94	0.84	0.88	
25f	Blue	45%	0.27	1.67	0.90	0.76	0.94	0.84	0.88	
Low-e Double Glazing, e=0.02 on surface 2					SHGC of Roller Shades and Insect Screens					
Ashrae ID	Description	VLT	SHGC glazing	LSG	White Opaque	Dark Opaque	Light Gray Translucent	Dark Grey Translucent	Reflective White Opaque	Reflective White Translucent
25b	Clear	70%	0.37	1.89	0.66	0.86	0.83	0.89	0.61	0.57
25c	Bronze	42%	0.26	1.62	0.71	0.88	0.86	0.90	0.68	0.64
25d	Green	60%	0.31	1.94	0.70	0.88	0.85	0.90	0.67	0.62
25f	Blue	45%	0.27	1.67	0.72	0.87	0.85	0.90	0.66	0.62

<sup>3</sup>2009 ASHRAE Fundamentals, F15, Fenestration, Table 13.

## IMPORTANT CONSIDERATIONS FOR INTERNAL SHADES

The use of internal shades to reduce the solar heat gain in a building is a legitimate energy efficiency solution to a building with poor glazing properties. However, there are important considerations that need to be addressed when internal blinds are used for this purpose.

### 1 Dependability

It may not be 100% dependable that internal blinds will be used during peak solar gain hours.

a) Automatically operated internal blinds may provide good solar gain protection during peak solar gain hours but lack the flexibility often preferred by building occupants.

b) Manually operated internal blinds are subjected to a wide range of possibilities caused by the building occupants and this diversity in effective use should be considered when evaluating the performance.

### 2 Durability

External shading devices and glazing are normally built to last the lifetime of the building. However, internal blinds are normally less durable and need to be replaced when damaged by normal wear and tear or by accidental damage by building occupants.

### 3 View Out

Certain internal shading systems may affect the view out of the building. The view out of a building is a very important aspect of visual quality in buildings. A building that does not provide an adequate view out creates a very dull and trapped feeling for the building occupants.

### 4 Brightness Control

Blackout blinds, translucent blinds, perforated blinds are some features that can be used to control brightness in building. When daylight is harvested, it becomes more important to ensure that the internal blind selected allows the right amount of light into the space for daylight harvesting. Too little or too much light can cause a daylight harvesting feature for the building to fail during operation.

### 5 Glare Protection

Due to the bright cloudy skies found in tropical climates, internal shades are used in Malaysia for glare protection. It should also be highlighted that it is possible to provide glare protection while allowing daylight harvesting in a building because these are two different issues altogether (Refer to Chapter 4 for details).

### 6 Thermal Comfort

While the use of a dark coloured blind may bring instant thermal comfort temporarily, its dark colour properties will absorb solar heat and will eventually reach temperatures up to or above 35°C even in an air-conditioned space. This hot blind will then increase the mean radiant temperature of the space, increasing thermal discomfort for the building occupants. Alternatively, a light coloured blind will reject a part the solar heat out of the window again and have a lower eventual blind temperature. In addition, there are blinds with low-e (emissivity) properties that can be used to reduce the mean radiant temperature from windows, increasing the thermal comfort in the building.

### 7 Privacy

Blinds that are translucent may allow daylight into a space but may not meet the building occupant's privacy requirements. Careful considerations need to be made to ensure that the privacy needs of building occupants are met when using internal blinds to provide daylight into a space.

## SUMMARY

Both external and internal shades contribute to the reduction of solar heat gain in buildings. The relationship of solar heat gain reduction is a simple multiplication factor of Solar Heat Gain Coefficients (SHGC) of these three items - external shade, glazing properties and internal shade. The simulation study conducted based on the Malaysian climate zone showed that using a horizontal external shade is approximately two times more effective than using a vertical external shade. In addition, it was

also shown in this chapter that it is feasible to use internal shades with the right properties to reduce solar heat gain in buildings. However, careful considerations have to be made on the use of internal shades to reduce the solar heat gain in a building, or more specifically, to account for the dependability of shade being used, durability of the internal shades, the view out, brightness control, glare protection, thermal comfort and the privacy needs of the building occupants.

### END OF CHAPTER 6



CHAPTER

# 7

## WALL INSULATION





## 7

## WALL INSULATION

## INTRODUCTION

It is a common expectation that insulating the wall in a tropical climate reduces a significant amount of energy consumption in office buildings by reducing the peak cooling load in the building. While it is true that insulation of walls in office buildings has a good potential of reducing the peak cooling load, its impact on building energy reduction is less significant due to the mild Malaysian climate.

The annual average day and night dry bulb temperature in Malaysia is 26.9°C (refer to Chapter 2) and without any significant differences in temperature profiles between June and December. During the night time to the early morning hours, the outdoor air temperature reaches an average low of 24°C.

Meanwhile, in modern office buildings today, there exists a significant amount of office equipment that are still consuming energy even after office hours. Even after a computer operating system is shut down but not switched off at the power point, it may still be consuming 5 to 15 watts of electricity in older computers or 1 to 2 watts in newer energy-rated computers. This energy consumption will become heat in the room. In addition, there is equipment in office spaces that are usually not switched off at all, such as printers, fax machines, hot and cold water dispensers,

refrigerators, some of the common-area lighting, security systems, etc. This night time parasitic energy consumption will produce heat within the building itself, causing the temperature inside the building to be warmer than the outdoor temperature during the night time and early morning hours. In a building without insulation, the heat built up during night time will be conducted out due to the temperature differences. However, in a building with insulation, this heat will be trapped inside the building. When the air-conditioning system is switched on again in the morning, this heat is removed at a cost to the energy consumption of the building.

This chapter provides a guideline on the optimum insulation to be provided for a typical office building in the Malaysian climate. In addition, it also provides an indication of cooling energy required in a building where the equipment load is not well controlled during the night time as compared to the cooling energy reduction in a building where the equipment load is well controlled.

# KEY RECOMMENDATIONS

It should be noted that for the climate of Malaysia, the heat is both conducted from the outside into the building as well as from inside of the building to the outside. During the daytime, the outdoor air temperature reaches up to an average high of 32°C, while the indoor air temperature is set to 23°C or 24°C inside the building, heat will be conducted from the outside to into the building. However, during the night time and early morning hours, the outdoor air temperature reaches an average low of 24°C, while the indoor air temperature (when the air-conditioning system is not running) will be higher than the outdoor air temperature at around 26 to 29°C. Heat is then conducted from the inside of the building to the outside during such conditions.

Due to the condition mentioned above, insulation of the walls of a building where the internal heat load is not well controlled during non-occupancy hours will not reduce the energy consumption of the building as much as a building where the internal heat load is small during non-occupancy hours, because the insulated wall will trap the heat generated within the building during the night time and would require more cooling energy to remove this heat when the air-conditioning system is switched on again in the morning.

The cost of wall materials with insulation properties vary significantly in the market. It is proposed that the feasibility of wall insulation be conducted based on economic justification. A simple method to estimate economic feasibility of wall insulation is provided below.

## ESTIMATING ENERGY SAVED

An energy simulation was conducted to derive an approximate estimate of energy and peak load reduction of an insulated wall. These estimates are provided as a guide for quick design checks by architects, engineers and building owners to estimate the cost savings by implementing these energy efficiency features. The simulation study model was based on Chapter 3, Case 1 of a Square Building, without any external shades. A typical office air-conditioning scenario was assumed for these results presented.

The energy saved due to the use of insulated walls is dependent on the internal heat load during the night time (night time parasitic load). Three (3) scenarios

were created where the small power (equipment) night time parasitic load is set to 50% (high night time parasitic load), 35% (mid night time parasitic load) and 10% (low night time parasitic load). A "Wall Simplified Energy Index" is created for the ease of computing the energy reduction provided by wall insulation. The creation of the Wall Simplified Energy Index is to provide an easy method to estimate energy reduction due to wall U-value selection in the Malaysian climate zone and should not be used for any other purpose.

The computation of energy saved due to the provision of insulation can be computed from the Wall Simplified Energy Index provided in **Table 7.1** below:

**TABLE 7.1 | ENERGY (ELECTRICITY) REDUCTION PER WALL AREA PER U-VALUE REDUCTION FOR A RANGE OF BASE LOAD SCENARIOS**

Case	Description	Ashrae U-value (W/m <sup>2</sup> K)	Wall Simplified Energy Index (kWh/year of m <sup>2</sup> of wall area)		
			High Night Time Parasitic Load	Mid Night Time Parasitic Load	Low Night Time Parasitic Load
1	Steel Sheet, 10mm	6.68	77	55	53
2	Concrete Wall, 100mm	3.40	55	32	28
3	Brick Wall, 115mm	2.82	52	30	25
4	Brick Wall, 220mm	2.16	50	27	22
5	Double Brick Wall with 50mm cavity, 300mm	1.42	48	25	20
6	Autoclave Lightweight Concrete, 100mm	1.25	47	24	18
7	Autoclave Lightweight Concrete, 150mm	0.94	45	22	17
8	Autoclave Lightweight Concrete, 200mm	0.75	45	22	16
9	Steel/Aluminum Composite Wall with 75mm Insulation	0.38	45	21	15

## CALCULATION EXAMPLE 1 - USE OF TABLE 7.1

### How much energy will be saved per year and what is the simple payback?

- ❶ Building Wall Area is 15,000 m<sup>2</sup>
- ❷ Default Wall Material is 100mm Concrete Wall with U-value of 3.4 W/m<sup>2</sup>K
- ❸ Proposed Wall Material is 150mm ALC with U-value of 0.94 W/m<sup>2</sup>K
- ❹ The estimated additional cost for 150mm ALC instead of 100mm Concrete Wall is RM 60/m<sup>2</sup> of wall area

#### Calculations:

**Wall Area:** 15,000 m<sup>2</sup>

An assumption is made that the building will have a medium base load, **Table 7.1** provides the following Wall Simplified Energy Index:

100mm Concrete Wall with U-value of 3.4 W/m<sup>2</sup>K wall: **32 kWh/year/m<sup>2</sup> of wall area**

150mm ALC with U-value of 0.94 W/m<sup>2</sup>K: **22 kWh/year/m<sup>2</sup> of wall area**

#### Energy Reduction Per Wall Area

32 - 22 = 10 kWh/year/m<sup>2</sup> of wall area

#### Energy Saved (kWh/year)

10 x 15,000 = 150,000 kWh/year saved

#### Assuming Energy Tariff of RM0.35/kWh:

#### Energy Saved Per Year (RM)

50,000 kWh/year x RM0.35/kWh = RM52,500/year

#### Total Additional Cost (RM)

RM60/m<sup>2</sup> x 15,000 m<sup>2</sup> = RM900,000

#### Simple Payback (Years)

RM900,000 / RM52,500 = 17 years

**Since a building would typically have a lifetime of 20 to 30 years, it is shown here that it is financially feasible to use a 150mm ALC wall instead of a Concrete wall that costs an extra RM60/m<sup>2</sup> of wall area.**

In addition to the energy saved, the use of wall insulation also reduces the peak cooling load of a building allowing a reduced chiller size. **Table 7.2** was derived from the same simulation study of the test reference model as described earlier. This table displays the estimated peak cooling load reduction due to the use of wall insulation.

**TABLE 7.2 | PEAK COOLING LOAD INDEX**

Case	Description	Peak Cooling Load Index	
		kWcooling/m <sup>2</sup> wall	ton/m <sup>2</sup> wall
1	Steel Sheet, 10mm	1.67	0.476
2	Concrete Wall, 100mm	1.61	0.457
3	Brick Wall, 115mm	1.60	0.456
4	Brick Wall, 220mm	1.60	0.455
5	Double Brick Wall with 50mm cavity, 300mm	1.59	0.452
6	Autoclave Lightweight Concrete, 100mm	1.58	0.450
7	Autoclave Lightweight Concrete, 150mm	1.58	0.449
8	Autoclave Lightweight Concrete, 200mm	1.58	0.449
9	Steel/Aluminum Composite Wall with 75mm Insulation	1.57	0.447

## CALCULATION EXAMPLE 2 - USE OF TABLE 7.2

### How much can the chiller capacity be reduced by?

- ❶ Building Wall Area is 15,000 m<sup>2</sup>
- ❷ Default Wall Material is 100mm Concrete Wall with U-value of 3.4 W/m<sup>2</sup>K
- ❸ Proposed Wall Material is 150mm ALC with U-value of 0.94 W/m<sup>2</sup>K
- ❹ The estimated additional cost for 150mm ALC instead of 100mm Concrete Wall is RM60/m<sup>2</sup> of wall area

#### Calculations:

##### Wall Area

15,000 m<sup>2</sup>

An assumption is made that the building will have a medium base load, **Table 7.2** provides the following Peak Cooling Load Index:

100mm Concrete Wall with U-value of 3.4 W/m<sup>2</sup>K wall: **0.457 ton/m<sup>2</sup> of wall area**

150mm ALC with U-value of 0.94 W/m<sup>2</sup>K: **0.449 ton/m<sup>2</sup> of wall area**

##### Peak Cooling Load Reduction Per Wall Area

0.457 - 0.449 = 0.008 ton/m<sup>2</sup> of wall area

##### Peak Cooling Load Reduction

0.008 ton/m<sup>2</sup> x 15,000 m<sup>2</sup> = 120 ton reduction

#### Financial Feasibility Study:

Assuming that 1 ton of Chiller would cost approximately RM3,000

A reduction of 120 tons would provide a capital cost saving of RM360,000

#### From Example Calculation 1, the following numbers were available:

a) Energy Saved Per Year = 10 x 15,000 x 0.35 = RM52,500/year

b) Total Additional Cost (RM) of wall material: RM60/m<sup>2</sup> x 15,000m<sup>2</sup> = RM900,000

#### Net Additional Cost Due to the Use of 150mm ALC Wall

a) Additional Cost of Wall = RM900,000

b) Chiller Cost Saving = RM360,000

c) Net Additional Cost = RM900,000 - RM360,000 = RM540,000

#### Simple Payback with Energy Saved

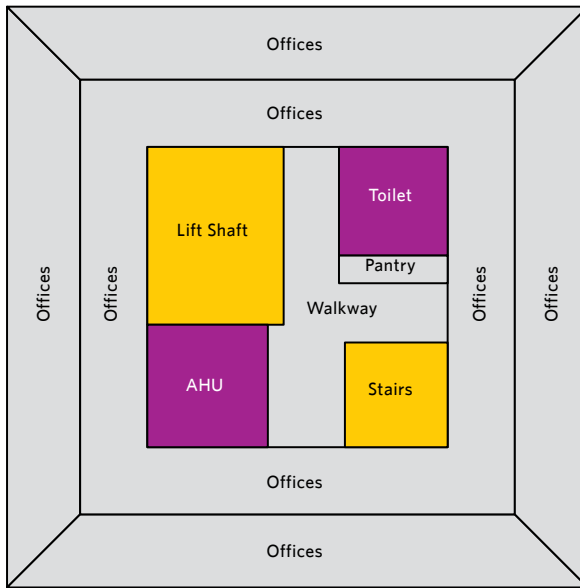
RM540,000 / RM52,500 = 10 years

**The simple payback reduces from 17 years to 10 years when the reduction of chiller capacity is accounted for together with the energy saved.**

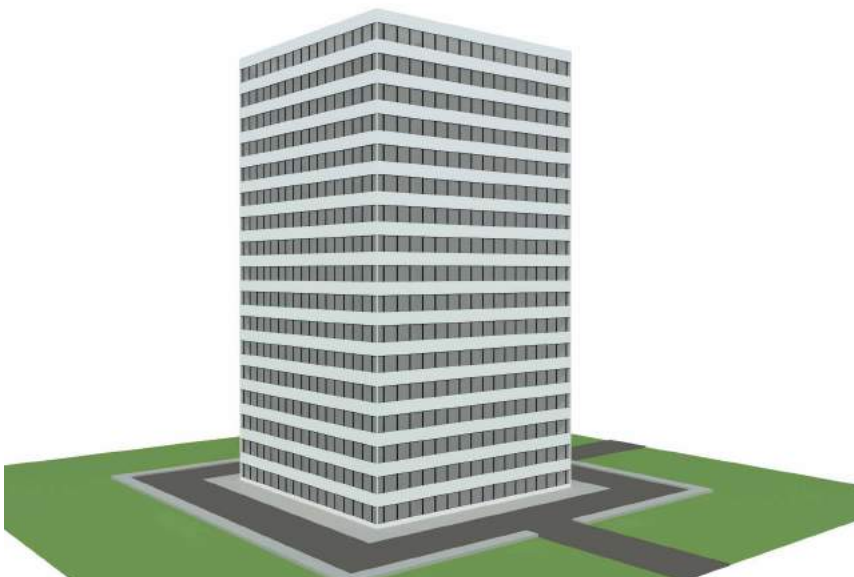
# SIMULATION MODEL

The standard center-cored, square box, 17 floor model of Case 1 from Chapter 3 was used in the case studies for this chapter. All the data used is identical to Chapter 3 unless specifically mentioned in this chapter.

## CASE 1 - SQUARE BUILDING CENTER CORE



- Actively Conditioned Spaces
- Passively Conditioned Spaces
- Non-Conditioned Spaces



## WALL PROPERTIES

### CASE 1: Steel Sheet, 10 mm

**TABLE 7.3.1 | STEEL SHEET WALL CONSTRUCTION PROPERTIES**

Description	Solar Absorptance	Emissivity	Resistance (m <sup>2</sup> K/W)
Outer Surface	0.7	0.9	0.0299
Inside Surface	0.55	0.9	0.1198

Layers	Material Description (outside to inside)	Thickness (mm)	Conductivity (W/m-K)	Density (kg/m <sup>3</sup> )	Specific Heat Capacity (J/kg-K)
1	Steel Sheet	10	50.000	7800	480.0

### CASE 2: Concrete Wall, 100mm

**TABLE 7.3.2 | CONCRETE WALL CONSTRUCTION PROPERTIES**

Description	Solar Absorptance	Emissivity	Resistance (m <sup>2</sup> K/W)
Outer Surface	0.7	0.9	0.0299
Inside Surface	0.55	0.9	0.1198

Layers	Material Description (outside to inside)	Thickness (mm)	Conductivity (W/m-K)	Density (kg/m <sup>3</sup> )	Specific Heat Capacity (J/kg-K)
1	Steel Sheet	10	50.000	7800	480.0
2	Cast Concrete	100	1.4000	2100	840.0
3	Screed	15	0.4100	1200	840.0

### CASE 3: Brick Wall, 115mm

**TABLE 7.3.3 | BRICK WALL CONSTRUCTION PROPERTIES**

Description	Solar Absorptance	Emissivity	Resistance (m <sup>2</sup> K/W)
Outer Surface	0.7	0.9	0.0299
Inside Surface	0.55	0.9	0.1198

Layers	Material Description (outside to inside)	Thickness (mm)	Conductivity (W/m-K)	Density (kg/m <sup>3</sup> )	Specific Heat Capacity (J/kg-K)
1	Plaster	17	0.5000	1300	1000.0
2	Brickwork	115	0.8400	1700	800.0
3	Plaster	17	0.5000	1300	1000.0



### CASE 4: Full Brick Wall, 220mm

**TABLE 7.3.4 | FULL BRICK WALL CONSTRUCTION PROPERTIES**

Description	Solar Absorptance	Emissivity	Resistance (m <sup>2</sup> K/W)
Outer Surface	0.7	0.9	0.0299
Inside Surface	0.55	0.9	0.1198

Layers	Material Description (outside to inside)	Thickness (mm)	Conductivity (W/m-K)	Density (kg/m <sup>3</sup> )	Specific Heat Capacity (J/kg-K)
1	Plaster	13	0.5000	1300	1000.0
2	Brickwork	220	0.8400	1700	800.0
3	Plaster	13	0.5000	1300	1000.0

### CASE 5: Double Brick Wall with 50mm Cavity, 300mm

**TABLE 7.3.5 | DOUBLE BRICK WALL WITH CAVITY CONSTRUCTION PROPERTIES**

Description	Solar Absorptance	Emissivity	Resistance (m <sup>2</sup> K/W)
Outer Surface	0.7	0.9	0.0299
Inside Surface	0.55	0.9	0.1198

Layers	Material Description (outside to inside)	Thickness (mm)	Conductivity (W/m-K)	Density (kg/m <sup>3</sup> )	Specific Heat Capacity (J/kg-K)
1	Plaster	13	0.5000	1300	1000.0
2	Brickwork	115	0.8400	1700	800.0
3	Air Cavity	50	0.18 Resistance (m <sup>2</sup> K/W)		
4	Brickwork	115	0.8400	1700	800.0
5	Plaster	13	0.5000	1300	1000.0

### CASE 6: Autoclave Lightweight Concrete, 100mm

**TABLE 7.3.6 | ALC 100MM CONSTRUCTION PROPERTIES**

Description	Solar Absorptance	Emissivity	Resistance (m <sup>2</sup> K/W)
Outer Surface	0.7	0.9	0.0299
Inside Surface	0.55	0.9	0.1198

Layers	Material Description (outside to inside)	Thickness (mm)	Conductivity (W/m-K)	Density (kg/m <sup>3</sup> )	Specific Heat Capacity (J/kg-K)
1	Plaster (Lightweight)	10	0.1600	600	1000.0
2	Lightweight Block	100	0.1900	600	1000.0
3	Plaster (Lightweight)	10	0.1600	600	1000.0

### CASE 7: Autoclave Lightweight Concrete, 150 mm

**TABLE 7.3.7 | ALC 150MM CONSTRUCTION PROPERTIES**

Description	Solar Absorptance	Emissivity	Resistance (m <sup>2</sup> K/W)
Outer Surface	0.7	0.9	0.0299
Inside Surface	0.55	0.9	0.1198

Layers	Material Description (outside to inside)	Thickness (mm)	Conductivity (W/m-K)	Density (kg/m <sup>3</sup> )	Specific Heat Capacity (J/kg-K)
1	Plaster (Lightweight)	10	0.1600	600	1000.0
2	Lightweight Block	150	0.1900	600	1000.0
3	Plaster (Lightweight)	10	0.1600	600	1000.0

### CASE 8: Autoclave Lightweight Concrete, 200 mm

**TABLE 7.3.8 | ALC 200MM CONSTRUCTION PROPERTIES**

Description	Solar Absorptance	Emissivity	Resistance (m <sup>2</sup> K/W)
Outer Surface	0.7	0.9	0.0299
Inside Surface	0.55	0.9	0.1198

Layers	Material Description (outside to inside)	Thickness (mm)	Conductivity (W/m-K)	Density (kg/m <sup>3</sup> )	Specific Heat Capacity (J/kg-K)
1	Plaster (Lightweight)	10	0.1600	600	1000.0
2	Lightweight Block	200	0.1900	600	1000.0
3	Plaster (Lightweight)	10	0.1600	600	1000.0

### CASE 9: Steel/Aluminum Composite with 75mm Insulation

**TABLE 7.3.9 | STEEL/ALUMINUM COMPOSITE WITH 75MM INSULATION CONSTRUCTION PROPERTIES**

Description	Solar Absorptance	Emissivity	Resistance (m <sup>2</sup> K/W)
Outer Surface	0.7	0.9	0.0299
Inside Surface	0.55	0.9	0.1198

Layers	Material Description (outside to inside)	Thickness (mm)	Conductivity (W/m-K)	Density (kg/m <sup>3</sup> )	Specific Heat Capacity (J/kg-K)
1	Steel/Aluminum	6	50.0000	7800	480.0
2	Polystyrene	75	0.0300	25	1380.0
3	Steel/Aluminum	6	50.0000	7800	480.0

## NIGHT TIME PARASITIC LOAD

Three (3) different night time parasitic loads were created for this simulation study to evaluate the relationship between wall insulation and the night time parasitic load of a building. The night time parasitic load is defined as the energy consumption (as well as heat produced) by the building equipment during non-occupancy hours (night time and weekends).

**1 Low Night Time Parasitic Load**

Small power night time parasitic load of 10% of daytime peak of 15W/m<sup>2</sup>

**2 Mid Night Time Parasitic Load**

Small power night time parasitic load of 35% of daytime peak of 15W/m<sup>2</sup>

**3 High Night Time Parasitic Load**

Small power night time parasitic load of 50% of daytime peak of 15W/m<sup>2</sup>

## SIMULATION RESULTS

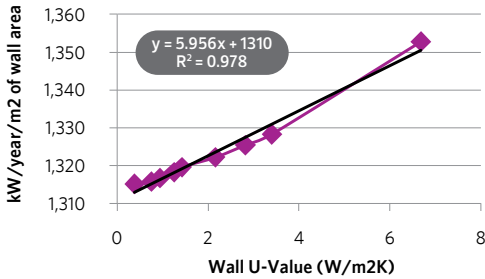
Total wall area in this simulation model is 3,876.00 m<sup>2</sup>

**TABLE 7.4 | SIMULATION RESULTS**

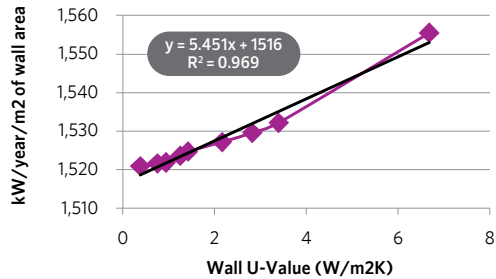
Case	Description	Ashrae U-value (W/m <sup>2</sup> K)	Total Energy (MWh/Year)			Peak Cooling Load	
			High Night Time Parasitic Load	Mid Night Time Parasitic Load	Low Night Time Parasitic Load	kW cooling	Ton
1	Steel Sheet, 10mm	6.68	6,500	6,029	5,243	6,484	1,844
2	Concrete Wall, 100mm	3.4	6,413	5,939	5,148	6,228	1,771
3	Brick Wall, 115mm	2.82	6,404	5,929	5,137	6,216	1,768
4	Brick Wall, 220mm	2.16	6,395	5,919	5,125	6,201	1,764
5	Double Brick Wall with 50mm cavity, 300mm	1.42	6,387	5,910	5,115	6,163	1,753
6	Autoclave Lightweight Concrete, 100mm	1.25	6,383	5,906	5,110	6,134	1,745
7	Autoclave Lightweight Concrete, 150mm	0.94	6,377	5,899	5,103	6,121	1,741
8	Autoclave Lightweight Concrete, 200mm	0.75	6,374	5,898	5,100	6,116	1,740
9	Steel/Aluminum Composite with 75mm Insulation	0.38	6,374	5,895	5,097.56	6,095	1,733

**CHART 7.4 | LINEAR CURVE FIT OF ENERGY CONSUMPTION AND PEAK COOLING LOAD IN BUILDING**

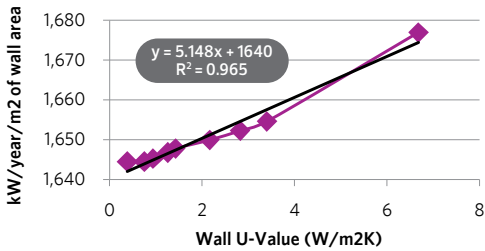
**Low Base Load**



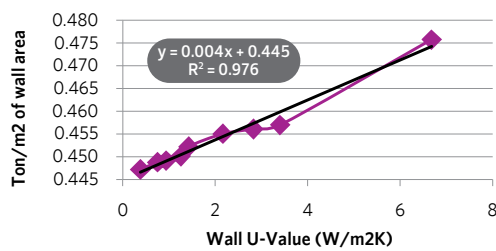
**Mid Base Load**



**High Base Load**



**Peak Cooling Load**



The results indicate that regardless of the thermal mass of the wall, the energy reduction by using an insulated wall is rather consistent as indicated by the U-value. Therefore, the energy and peak cooling load reduction estimation method described in this chapter will be fairly accurate using the U-value alone, regardless of the thermal mass of the wall construction.

## SUMMARY

The energy savings due to wall insulation is dependent on the internal heat produced by the building equipment such as lighting and computers during the night time (non-occupied hours). The higher the amount of heat produced indoors, the less energy savings are made from insulating the building walls. The reason is that insulated walls will trap the heat generated during the night time by the lights and equipment that are not switched off, increasing the air-conditioning load the next morning. Therefore, it is important to manage the heat produced inside a building during the night time in order to benefit from an insulated wall.

More importantly, insulated walls do provide a significant peak cooling load reduction that reduces the chiller peak capacity and helps to reduce the capital cost of an air-conditioning system. It is recommended for architects to check with air-conditioning system designers to explore the savings provided by an insulated wall. This chapter also provides an approximation of energy saved and peak load reduction due to the use of wall insulation. Again, this can be used by building designers as a quick approximation and guide to make design decisions.

**END OF CHAPTER 7**

CHAPTER

# 8

# ROOF INSULATION





## 8

## ROOF INSULATION

## INTRODUCTION

There are many different types of roofing systems in use in Malaysia. The three most commonly practiced roofing systems are concrete flat roofs, light-weight pitched roofs and light-weight pitched roofs over concrete flat roofs. The energy efficiency behaviour of insulation provided on these roof systems is slightly different for each type of roof system and is particularly affected by the different hours of air-conditioning operating hours in the space immediately below the roof.

A typical roof is fully exposed to the entire sky dome and is strongly influenced by the solar radiation received and the effective sky temperature. During the daytime, radiation heat transfer on the roof is being both received and rejected at the same time. The sun (solar radiation) heats up the external roof surface, while the rest of the sky dome (effective sky temperature during daytime averaging around 20°C) cools the external roof surface. The net radiation gain on the roof during the daytime will be positive due to the significantly higher radiation heat transfer from the sun and the hot external roof surface will transmit heat into the building via conduction through the roof. Insulation of the roof in this case will reduce the heat that is transmitted into the building, reducing the building cooling load.

However, during night time, where there is no solar radiation heat gain and the average effective sky temperature is 15°C (Chapter 2), heat is released by the roof surface into

the sky via the radiation heat transfer mechanism. Warmer temperature from the internal building space below the roof is conducted to the top surface of the roof and transferred to the cold night sky. The provision of insulation in the roof reduces the amount of heat that is released from the roof during the night time. Depending on the hours of operation of the air-conditioning system, the provision of insulation in the roofing system can either be beneficial or detrimental to the energy efficiency of the building.

In this climate zone, it will be ideal to

be able to provide insulation in the roof during daytime to prevent heat gain, and have the insulation removed during the night time to allow the sky to cool the building down naturally. Removable roofing systems, water-sprinkler systems during night time, etc. are some of the methods being explored by researchers worldwide to harness the 'cooling' abilities of the night sky. In addition, it is also possible to consider a night purge or stack ventilation effect on the roof, namely to assist in getting the heat out of the roof quickly, allowing the cooler night air and night sky to cool the building down.

**This chapter provides the potential energy reduction due to the use of insulation in roofing systems for these scenarios below the roof space:**

Air-Conditioning Hours	Weekday	Weekend	Location Example
8.00am to 5.30pm	On	Off	Office spaces
24 hours	On	On	Hotels, Hospitals, etc.
2.00pm to 10.00pm	On	On	Residential kids home from school
10.00pm to 6.00am	On	On	Residential houses

**The above air-conditioning hours are then applied to these 3 types of roofing system:**

Roof System	Insulation Material
1 Flat Roof	Polystyrene Foam
2 Pitch Roof with Plasterboard Ceiling	Mineral Wool
3 Pitch Roof with Concrete Ceiling	Mineral Wool

The third roof type was included in this study because it is becoming common for buildings with a concrete flat roof to have a pitch roof over it. This provides additional safety against rain water leakage and also provides additional insulation (2<sup>nd</sup> roof) for the building.



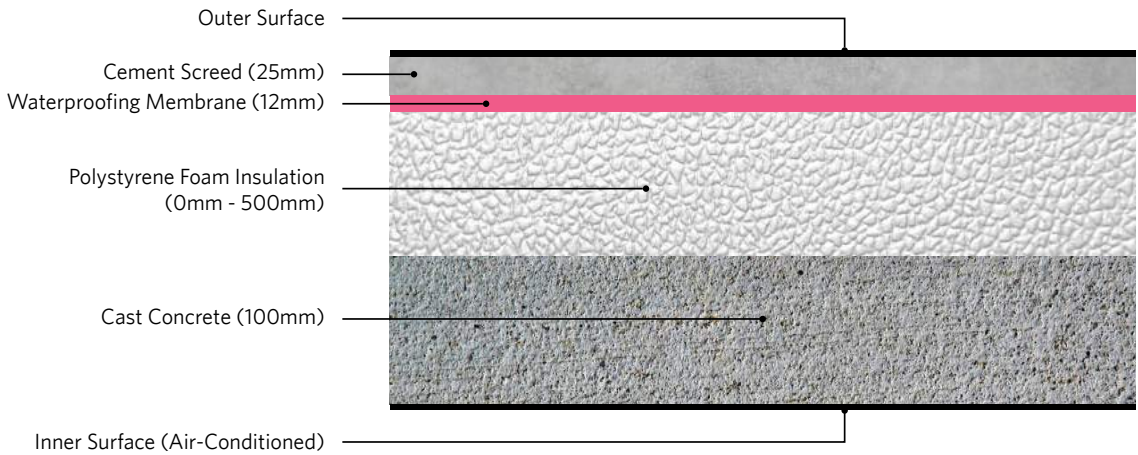
# KEY RECOMMENDATIONS

These recommendations were made assuming an electricity tariff of RM0.35 per kWh. Please compute again if the electricity tariff is different using the savings shown in kWh/year from the tables provided.

**In general, the maximum insulation thickness to be provided for buildings in the Malaysian climate zone is 100mm of polystyrene foam or mineral wool. Providing insulation thicker than 100mm does not yield much further energy reduction.**

## CONCRETE FLAT ROOF

**FIGURE 8.1 | CROSS-SECTION OF CONCRETE FLAT ROOF SCHEMATIC**



Concrete flat roofs were provided with Polystyrene foam as insulation material with a conductivity value (K-value) of 0.030 W/m-K (a lower K-value signifies better insulation properties. Many manufacturers will meet or surpass the K-value used for the polystyrene foam in this study). The total constructed roof U-values with and without insulation are provided in the **Table 8.1.1**.

**TABLE 8.1.1 | ASHRAE U-VALUE FOR FLAT ROOF USED IN THIS STUDY**

Flat Roof Description	Ashrae U-value (W/m <sup>2</sup> K)
Base Flat Roof	4.0604
Flat Roof with 25mm Insulation	0.8898
Flat Roof with 50mm Insulation	0.5109
Flat Roof with 75mm Insulation	0.3641
Flat Roof with 100mm Insulation	0.2794
Flat Roof with 200mm Insulation	0.1447
Flat Roof with 300mm Insulation	0.0972
Flat Roof with 400mm Insulation	0.0736
Flat Roof with 500mm Insulation	0.0591



Tables 8.1.2 to 8.1.5 below provide the budget for flat roof insulation depending on the hours of air-conditioning used. For example, from the table below, for an office building where the air-conditioning hours are 8am to 5.30pm weekdays, the available budget for a 100mm polystyrene insulation foam is RM67.92 per m<sup>2</sup> of roof area with a 15-year payback period. If the cost of 100mm polystyrene foam is less than RM67.92, then it is economically feasible to insulate the roof with 100mm insulation foam. Due to the reason that the electricity tariff will likely increase over the years, the actual payback period will definitely be shorter than 15 years as shown in the tables below. You are encouraged to create your own tables with the new electrical tariff assumptions as information becomes available.

**TABLE 8.1.2 | SIMULATION RESULTS FOR FLAT ROOF, AIR-CONDITIONING HOURS OF 8.00AM TO 5:30PM WEEKDAYS**

Case	Flat Roof Description	Energy Used kWh/m <sup>2</sup> of roof area per year	Electricity kWh/m <sup>2</sup> reduction per year	RM/m <sup>2</sup> reduction per year	Budget for Insulation with 15 years Payback (RM/m <sup>2</sup> of roof area)
1	Base Flat Roof	135.06	-	-	-
2	Flat Roof with 25mm Insulation	124.19	10.86	3.80	57
3	Flat Roof with 50mm Insulation	122.95	12.11	4.24	64
4	Flat Roof with 75mm Insulation	122.42	12.64	4.42	66
5	Flat Roof with 100mm Insulation	122.12	12.94	4.53	68
6	Flat Roof with 200mm Insulation	121.63	13.43	4.70	71
7	Flat Roof with 300mm Insulation	121.63	13.42	4.70	71
8	Flat Roof with 400mm Insulation	121.42	13.63	4.77	72
9	Flat Roof with 500mm Insulation	121.39	13.66	4.78	72

**TABLE 8.1.3 | SIMULATION RESULTS FOR FLAT ROOF, AIR-CONDITIONING HOURS OF 24 HOURS DAILY**

Case	Flat Roof Description	Energy Used kWh/m <sup>2</sup> of roof area per year	Electricity kWh/m <sup>2</sup> reduction per year	RM/m <sup>2</sup> reduction per year	Budget for Insulation with 15 years Payback (RM/m <sup>2</sup> of roof area)
1	Base Flat Roof	552.08	-	-	-
2	Flat Roof with 25mm Insulation	522.65	29.43	10.30	155
3	Flat Roof with 50mm Insulation	518.42	33.66	11.78	177
4	Flat Roof with 75mm Insulation	516.72	35.36	12.38	186
5	Flat Roof with 100mm Insulation	515.79	36.29	12.70	191
6	Flat Roof with 200mm Insulation	514.31	37.77	13.22	198
7	Flat Roof with 300mm Insulation	513.79	38.29	13.40	201
8	Flat Roof with 400mm Insulation	513.52	38.56	13.50	202
9	Flat Roof with 500mm Insulation	513.36	38.72	13.55	203

**TABLE 8.1.4 | SIMULATION RESULTS FOR FLAT ROOF, AIR-CONDITIONING HOURS OF 2.00PM TO 10.00PM DAILY**

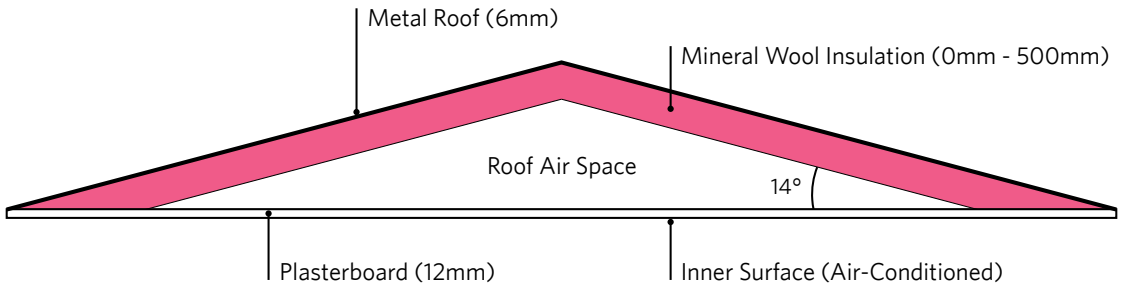
Case	Flat Roof Description	Energy Used kWh/m <sup>2</sup> of roof area per year	Electricity kWh/m <sup>2</sup> reduction per year	RM/m <sup>2</sup> reduction per year	Budget for Insulation with 15 years Payback (RM/m <sup>2</sup> of roof area)
1	Base Flat Roof	181.22	-	-	-
2	Flat Roof with 25mm Insulation	158.32	22.91	8.02	120
3	Flat Roof with 50mm Insulation	155.67	25.55	8.94	134
4	Flat Roof with 75mm Insulation	154.63	26.60	9.31	140
5	Flat Roof with 100mm Insulation	154.06	27.17	9.51	143
6	Flat Roof with 200mm Insulation	153.11	28.12	9.84	148
7	Flat Roof with 300mm Insulation	152.66	28.56	10.00	150
8	Flat Roof with 400mm Insulation	152.58	28.64	10.03	150
9	Flat Roof with 500mm Insulation	152.51	28.71	10.05	151

**TABLE 8.1.5 | SIMULATION RESULTS FOR FLAT ROOF, AIR-CONDITIONING HOURS OF 10.00PM TO 6.00AM DAILY**

Case	Flat Roof Description	Energy Used kWh/m <sup>2</sup> of roof area per year	Electricity kWh/m <sup>2</sup> reduction per year	RM/m <sup>2</sup> reduction per year	Budget for Insulation with 15 years Payback (RM/m <sup>2</sup> of roof area)
1	Base Flat Roof	152.03	-	-	-
2	Flat Roof with 25mm Insulation	148.23	3.81	1.33	20
3	Flat Roof with 50mm Insulation	146.76	5.28	1.85	28
4	Flat Roof with 75mm Insulation	146.13	5.90	2.07	31
5	Flat Roof with 100mm Insulation	145.79	6.24	2.18	33
6	Flat Roof with 200mm Insulation	145.25	6.79	2.38	36
7	Flat Roof with 300mm Insulation	144.76	7.28	2.55	38
8	Flat Roof with 400mm Insulation	144.89	7.15	2.50	38
9	Flat Roof with 500mm Insulation	144.79	7.25	2.54	38

# LIGHT WEIGHT PITCH ROOF WITH PLASTERBOARD CEILING

**FIGURE 8.2 | CROSS-SECTION OF PITCH ROOF CONSTRUCTION WITH PLASTERBOARD AS CEILING**



Pitch roofs were provided with mineral wool as insulation material with a conductivity value (K-value) of 0.035 W/m-K (a lower K-value signifies better insulation properties. Many manufacturers will meet or surpass the K-value used for the mineral wool in this study). The total constructed roof U-values of the pitch roof with and without insulation are provided in the table below.

**TABLE 8.2.1 | ASHRAE U-value FOR PITCH ROOF USED IN THIS STUDY**

Pitch Roof Description	Ashrae U-value (W/m <sup>2</sup> K) (excluding the roof space between the ceiling and pitch roof)	Ashrae U-value (W/m <sup>2</sup> K) (including the roof space between the ceiling and pitch roof, and plasterboard ceiling, roof space not ventilated)
Base Pitch Roof	7.2735	2.5479
Pitch Roof with 25mm Insulation	1.174	0.9035
Pitch Roof with 50mm Insulation	0.6385	0.5491
Pitch Roof with 75mm Insulation	0.4385	0.3944
Pitch Roof with 100mm Insulation	0.3339	0.3077
Pitch Roof with 200mm Insulation	0.1709	0.1638
Pitch Roof with 300mm Insulation	0.1148	0.1116
Pitch Roof with 400mm Insulation	0.0865	0.0846
Pitch Roof with 500mm Insulation	0.0693	0.0681

**TABLE 8.2.2 | SIMULATION RESULTS FOR PITCH ROOF, AIR-CONDITIONING HOURS OF 8.00AM TO 5:30PM WEEKDAYS**

Case	Pitch Roof Description	Energy Used kWh/m <sup>2</sup> of roof area per year	Electricity kWh/m <sup>2</sup> reduction per year	RM/m <sup>2</sup> reduction per year	Budget for Insulation with 15 years Payback (RM/m <sup>2</sup> of roof area)
1	Base Pitch Roof	137.40	-	-	-
2	Pitch Roof with 25mm Insulation	134.55	2.85	1.00	15
3	Pitch Roof with 50mm Insulation	133.85	3.55	1.24	19
4	Pitch Roof with 75mm Insulation	133.55	3.85	1.35	20
5	Pitch Roof with 100mm Insulation	133.37	4.03	1.41	21
6	Pitch Roof with 200mm Insulation	133.09	4.31	1.51	23
7	Pitch Roof with 300mm Insulation	132.99	4.41	1.54	23
8	Pitch Roof with 400mm Insulation	132.94	4.47	1.56	24
9	Pitch Roof with 500mm Insulation	132.90	4.50	1.58	24

**TABLE 8.2.3 | SIMULATION RESULTS FOR PITCH ROOF, AIR-CONDITIONING HOURS OF 24 HOURS DAILY**

Case	Pitch Roof Description	Energy Used kWh/m <sup>2</sup> of roof area per year	Electricity kWh/m <sup>2</sup> reduction per year	RM/m <sup>2</sup> reduction per year	Budget for Insulation with 15 years Payback (RM/m <sup>2</sup> of roof area)
1	Base Pitch Roof	520.70	-	-	-
2	Pitch Roof with 25mm Insulation	509.89	10.80	3.78	57
3	Pitch Roof with 50mm Insulation	507.24	13.46	4.71	71
4	Pitch Roof with 75mm Insulation	506.09	14.61	5.11	77
5	Pitch Roof with 100mm Insulation	505.44	15.26	5.34	80
6	Pitch Roof with 200mm Insulation	504.36	16.34	5.72	86
7	Pitch Roof with 300mm Insulation	503.97	16.72	5.85	88
8	Pitch Roof with 400mm Insulation	503.77	16.92	5.92	89
9	Pitch Roof with 500mm Insulation	503.64	17.06	5.97	90

**TABLE 8.2.4 | SIMULATION RESULTS FOR PITCH ROOF, AIR-CONDITIONING HOURS OF 2.00PM TO 10.00PM DAILY**

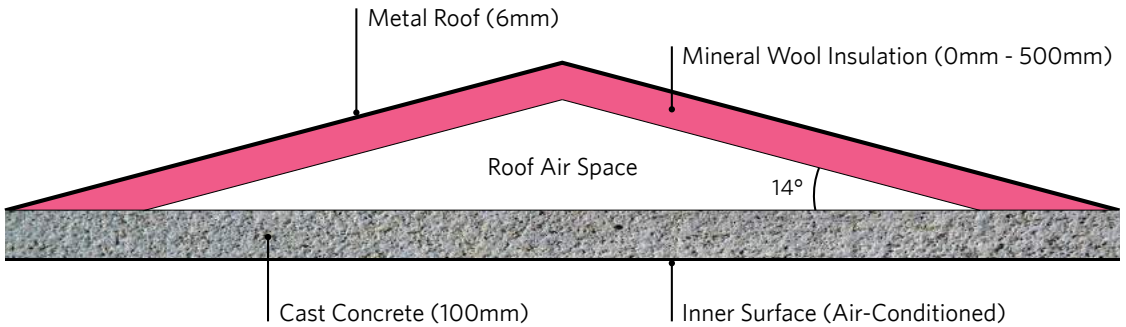
Case	Pitch Roof Description	Energy Used kWh/m <sup>2</sup> of roof area per year	Electricity kWh/m <sup>2</sup> reduction per year	RM/m <sup>2</sup> reduction per year	Budget for Insulation with 15 years Payback (RM/m <sup>2</sup> of roof area)
1	Base Pitch Roof	160.23	-	-	-
2	Pitch Roof with 25mm Insulation	153.75	6.48	2.27	34
3	Pitch Roof with 50mm Insulation	152.39	7.84	2.74	41
4	Pitch Roof with 75mm Insulation	151.58	8.65	3.03	45
5	Pitch Roof with 100mm Insulation	151.13	9.10	3.19	48
6	Pitch Roof with 200mm Insulation	150.38	9.86	3.45	52
7	Pitch Roof with 300mm Insulation	149.97	10.26	3.59	54
8	Pitch Roof with 400mm Insulation	149.65	10.58	3.70	56
9	Pitch Roof with 500mm Insulation	149.45	10.78	3.77	57

**TABLE 8.2.5 | SIMULATION RESULTS FOR PITCH ROOF, AIR-CONDITIONING HOURS OF 10.00PM TO 6.00AM DAILY**

Case	Pitch Roof Description	Energy Used kWh/m <sup>2</sup> of roof area per year	Electricity kWh/m <sup>2</sup> reduction per year	RM/m <sup>2</sup> reduction per year	Budget for Insulation with 15 years Payback (RM/m <sup>2</sup> of roof area)
1	Base Pitch Roof	136.03	-	-	-
2	Pitch Roof with 25mm Insulation	138.25	(2.22)	(0.78)	(12)
3	Pitch Roof with 50mm Insulation	138.97	(2.95)	(1.03)	(16)
4	Pitch Roof with 75mm Insulation	139.19	(3.16)	(1.11)	(17)
5	Pitch Roof with 100mm Insulation	139.32	(3.30)	(1.15)	(17)
6	Pitch Roof with 200mm Insulation	139.65	(3.63)	(1.27)	(19)
7	Pitch Roof with 300mm Insulation	139.88	(3.85)	(1.35)	(20)
8	Pitch Roof with 400mm Insulation	139.98	(3.95)	(1.38)	(21)
9	Pitch Roof with 500mm Insulation	139.96	(3.94)	(1.38)	(21)

# LIGHT WEIGHT PITCH ROOF WITH CONCRETE CEILING

FIGURE 8.3 | CROSS-SECTION OF PITCH ROOF CONSTRUCTION WITH CONCRETE AS CEILING



Pitch roofs were provided with mineral wool as insulation material with a conductivity value (K-value) of 0.035 W/m-K. The total constructed roof U-values of the pitch roof with and without insulation are provided in the table below.

TABLE 8.3.1 | ASHRAE U-VALUE FOR PITCH ROOF USED IN THIS STUDY

Pitch Roof Description	Ashrae U-value (W/m <sup>2</sup> K) (excluding the roof space between the ceiling and pitch roof)	Ashrae U-value (W/m <sup>2</sup> K) (including the roof space between the ceiling and pitch roof, and concrete ceiling, roof space not ventilated)
Base Pitch Roof with Concrete Slab	7.2735	2.5713
Pitch Roof with Concrete Slab & 25mm Insulation	1.174	0.9065
Pitch Roof with Concrete Slab & 50mm Insulation	0.6385	0.5502
Pitch Roof with Concrete Slab & 75mm Insulation	0.4385	0.3950
Pitch Roof with Concrete Slab & 100mm Insulation	0.3339	0.3081
Pitch Roof with Concrete Slab & 200mm Insulation	0.1709	0.1638
Pitch Roof with Concrete Slab & 300mm Insulation	0.1148	0.1116
Pitch Roof with Concrete Slab & 400mm Insulation	0.0865	0.0846
Pitch Roof with Concrete Slab & 500mm Insulation	0.0693	0.0681

**TABLE 8.3.2 | SIMULATION RESULTS FOR PITCH ROOF, AIR-CONDITIONING HOURS OF 8.00AM TO 5:30PM WEEKDAYS**

Case	Pitch Roof Description	Energy Used kWh/m <sup>2</sup> of roof area per year	Electricity kWh/m <sup>2</sup> reduction per year	RM/m <sup>2</sup> reduction per year	Budget for Insulation with 15 years Payback (RM/m <sup>2</sup> of roof area)
1	Base Pitch Roof with Concrete Slab	124.54	-	-	-
2	Pitch Roof with Concrete Slab & 25mm Insulation	121.07	3.47	1.21	18
3	Pitch Roof with Concrete Slab & 50mm Insulation	120.19	4.35	1.52	23
4	Pitch Roof with Concrete Slab & 75mm Insulation	119.90	4.64	1.62	24
5	Pitch Roof with Concrete Slab & 100mm Insulation	119.73	4.81	1.68	25
6	Pitch Roof with Concrete Slab & 200mm Insulation	119.44	5.10	1.78	27
7	Pitch Roof with Concrete Slab & 300mm Insulation	119.36	5.18	1.81	27
8	Pitch Roof with Concrete Slab & 400mm Insulation	119.34	5.21	1.82	27
9	Pitch Roof with Concrete Slab & 500mm Insulation	119.33	5.21	1.82	27

**TABLE 8.3.3 | SIMULATION RESULTS FOR PITCH ROOF, AIR-CONDITIONING HOURS OF 24 HOURS DAILY**

Case	Pitch Roof Description	Energy Used kWh/m <sup>2</sup> of roof area per year	Electricity kWh/m <sup>2</sup> reduction per year	RM/m <sup>2</sup> reduction per year	Budget for Insulation with 15 years Payback (RM/m <sup>2</sup> of roof area)
1	Base Pitch Roof with Concrete Slab	521.48	-	-	-
2	Pitch Roof with Concrete Slab & 25mm Insulation	510.12	11.36	3.98	60
3	Pitch Roof with Concrete Slab & 50mm Insulation	507.40	14.08	4.93	74
4	Pitch Roof with Concrete Slab & 75mm Insulation	506.22	15.26	5.34	80
5	Pitch Roof with Concrete Slab & 100mm Insulation	505.55	15.93	5.58	84
6	Pitch Roof with Concrete Slab & 200mm Insulation	504.43	17.05	5.97	90
7	Pitch Roof with Concrete Slab & 300mm Insulation	504.02	17.46	6.11	92
8	Pitch Roof with Concrete Slab & 400mm Insulation	503.81	17.67	6.18	93
9	Pitch Roof with Concrete Slab & 500mm Insulation	503.67	17.80	6.23	94

**TABLE 8.3.4 | SIMULATION RESULTS FOR PITCH ROOF, AIR-CONDITIONING HOURS OF 2.00PM TO 10.00PM DAILY**

Case	Pitch Roof Description	Energy Used kWh/m <sup>2</sup> of roof area per year	Electricity kWh/m <sup>2</sup> reduction per year	RM/m <sup>2</sup> reduction per year	Budget for Insulation with 15 years Payback (RM/m <sup>2</sup> of roof area)
1	Base Pitch Roof with Concrete Slab	163.26	-	-	-
2	Pitch Roof with Concrete Slab & 25mm Insulation	154.84	8.42	2.95	44
3	Pitch Roof with Concrete Slab & 50mm Insulation	152.97	10.30	3.60	54
4	Pitch Roof with Concrete Slab & 75mm Insulation	152.21	11.06	3.87	58
5	Pitch Roof with Concrete Slab & 100mm Insulation	151.78	11.49	4.02	60
6	Pitch Roof with Concrete Slab & 200mm Insulation	151.03	12.23	4.28	64
7	Pitch Roof with Concrete Slab & 300mm Insulation	150.72	12.54	4.39	66
8	Pitch Roof with Concrete Slab & 400mm Insulation	150.58	12.69	4.44	67
9	Pitch Roof with Concrete Slab & 500mm Insulation	150.52	12.75	4.46	67

**TABLE 8.3.5 | SIMULATION RESULTS FOR PITCH ROOF, AIR-CONDITIONING HOURS OF 10.00PM TO 6.00AM DAILY**

Case	Pitch Roof Description	Energy Used kWh/m <sup>2</sup> of roof area per year	Electricity kWh/m <sup>2</sup> reduction per year	RM/m <sup>2</sup> reduction per year	Budget for Insulation with 15 years Payback (RM/m <sup>2</sup> of roof area)
1	Base Pitch Roof with Concrete Slab	147.33	-	-	-
2	Pitch Roof with Concrete Slab & 25mm Insulation	144.98	2.35	0.82	12
3	Pitch Roof with Concrete Slab & 50mm Insulation	144.32	3.01	1.05	16
4	Pitch Roof with Concrete Slab & 75mm Insulation	143.94	3.39	1.19	18
5	Pitch Roof with Concrete Slab & 100mm Insulation	143.72	3.61	1.26	19
6	Pitch Roof with Concrete Slab & 200mm Insulation	143.37	3.97	1.39	21
7	Pitch Roof with Concrete Slab & 300mm Insulation	143.23	4.10	1.44	22
8	Pitch Roof with Concrete Slab & 400mm Insulation	143.12	4.21	1.47	22
9	Pitch Roof with Concrete Slab & 500mm Insulation	143.03	4.30	1.50	23

# SIMULATION MODELS

Three (3) types of roof were created for this study on roof insulation:

## CONCRETE FLAT ROOF MODEL



**FIGURE 8.4 | CROSS-SECTION OF CONCRETE FLAT ROOF**

**TABLE 8.4 | CONSTRUCTION PROPERTIES OF CONCRETE FLAT ROOF**

Description	Solar Absorptance	Emissivity	Resistance (m <sup>2</sup> K/W)
Outer Surface	0.5	0.9	0.040
Inside Surface	0.55	0.9	0.100

Layers	Material Description (outside to inside)	Thickness (mm)	Conductivity (W/m-K)	Density (kg/m <sup>3</sup> )	Specific Heat Capacity (J/kg-K)
1	Cement Screed	25	0.9600	1800	1000
2	Waterproofing Membrane	12	0.5000	1700	1000
3	Polystyrene Foam	0 to 500	0.0300	25	1380
4	Cast Concrete	100	1.1300	2000	1000

## PITCH ROOF WITH PLASTERBOARD CEILING MODEL



**FIGURE 8.5 | CROSS-SECTION OF PITCH ROOF CONSTRUCTION WITH PLASTERBOARD AS CEILING**

**TABLE 8.5.1 | CONSTRUCTION PROPERTIES OF PITCH ROOF SECTION**

Description	Solar Absorptance	Emissivity	Resistance (m <sup>2</sup> K/W)
Outer Surface	0.5	0.9	0.040
Inside Surface	0.55	0.9	0.100

Layers	Material Description (outside to inside)	Thickness (mm)	Conductivity (W/m-K)	Density (kg/m <sup>3</sup> )	Specific Heat Capacity (J/kg-K)
1	Metal Steel Sheet	6	50.000	7800	480
2	Mineral Wool	0 to 500	0.035	30	1000

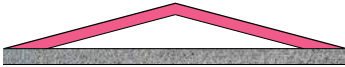
**TABLE 8.5.2 | CONSTRUCTION PROPERTIES OF CEILING SECTION**

Description	Solar Absorptance	Emissivity	Resistance (m <sup>2</sup> K/W)
Outer Surface	0.55	0.9	0.100
Inside Surface	0.55	0.9	0.100

Layers	Material Description (outside to inside)	Thickness (mm)	Conductivity (W/m-K)	Density (kg/m <sup>3</sup> )	Specific Heat Capacity (J/kg-K)
1	Plasterboard	12	0.1600	22	1000

Note: Roof air space was modelled with an infiltration rate of 1 air-change per hour.

## PITCH ROOF WITH CONCRETE CEILING MODEL



**FIGURE 8.6 | CROSS-SECTION OF PITCH ROOF CONSTRUCTION WITH CONCRETE AS CEILING**

**TABLE 8.6.1 | CONSTRUCTION PROPERTIES OF PITCH ROOF SECTION**

Description	Solar Absorptance	Emissivity	Resistance (m <sup>2</sup> K/W)
Outer Surface	0.5	0.9	0.040
Inside Surface	0.55	0.9	0.100

Layers	Material Description (outside to inside)	Thickness (mm)	Conductivity (W/m-K)	Density (kg/m <sup>3</sup> )	Specific Heat Capacity (J/kg-K)
1	Metal Steel Sheet	6	50.000	7800	480
2	Mineral Wool	0 to 500	0.035	30	1000

**TABLE 8.6.2 | CONSTRUCTION PROPERTIES OF CEILING SECTION**

Description	Solar Absorptance	Emissivity	Resistance (m <sup>2</sup> K/W)
Outer Surface	0.7	0.9	0.100
Inside Surface	0.55	0.9	0.100

Layers	Material Description (outside to inside)	Thickness (mm)	Conductivity (W/m-K)	Density (kg/m <sup>3</sup> )	Specific Heat Capacity (J/kg-K)
1	Cast Concrete	100	1.400	2100	840

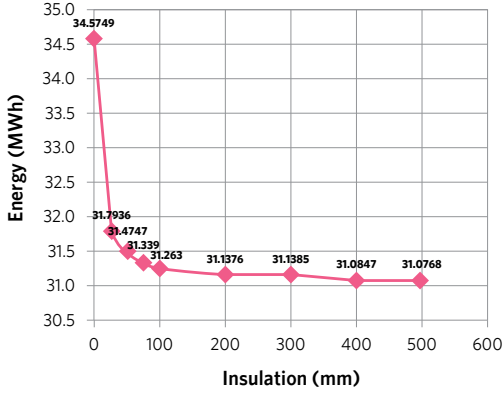
Note: Roof air space was modelled with an infiltration rate of 1 air-change per hour.

## AIR-CONDITIONING SYSTEM

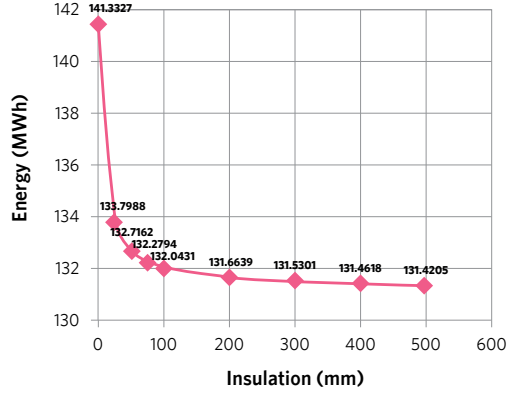
A simplified air-conditioning system was modelled assuming a fixed System Coefficient of Performance (SCOP) of 3.0. This efficiency is equivalent to typical new split-unit air-conditioning system used in residential homes today.

# DETAILED SIMULATION CHARTS

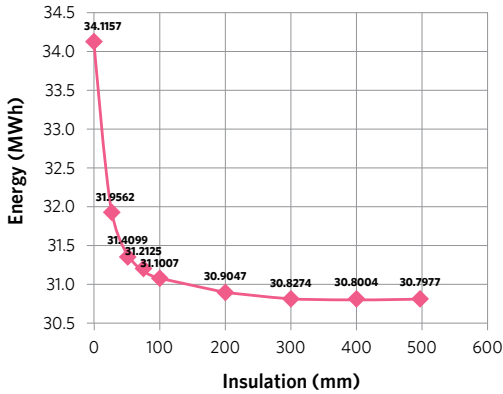
**FLAT ROOF (8AM - 5.30PM)**



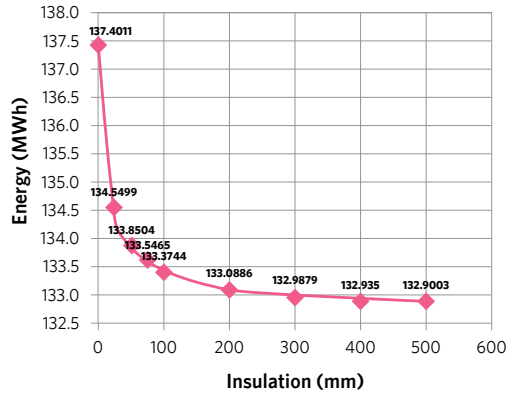
**FLAT ROOF (24HRS)**



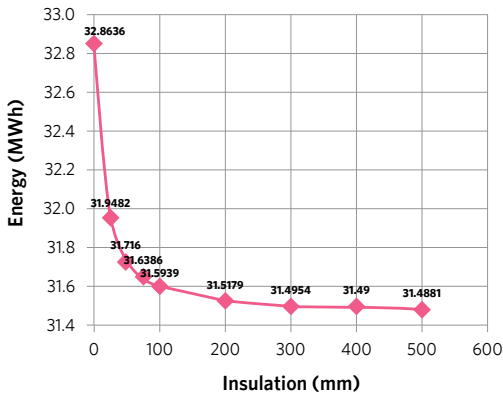
**PITCH ROOF (8AM - 5.30PM)**



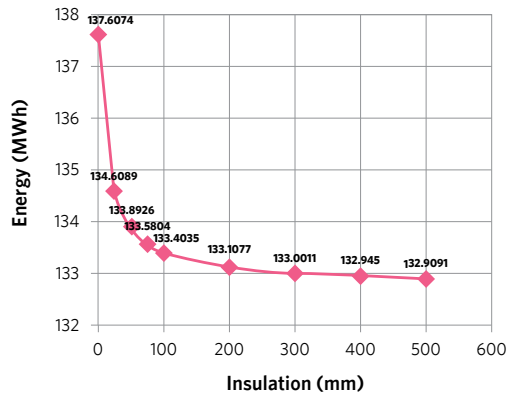
**PITCH ROOF (24HRS)**



**PITCH ROOF WITH CONCRETE SLAB (8AM - 5.30PM)**



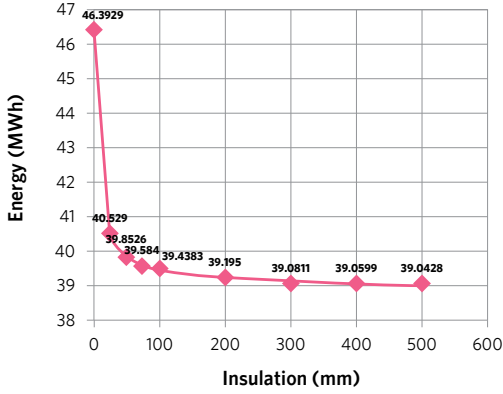
**PITCH ROOF WITH CONCRETE SLAB (24HRS)**



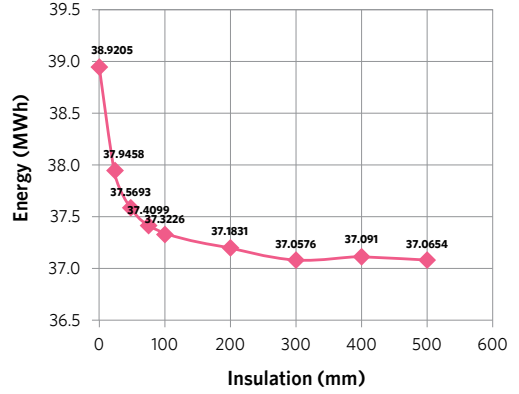


Flat Roofs are insulated using Polystyrene Foam with a K-value of 0.030 W/m-K  
 Pitch Roofs are insulated using Mineral Wool with a K-value of 0.035 W/m-K

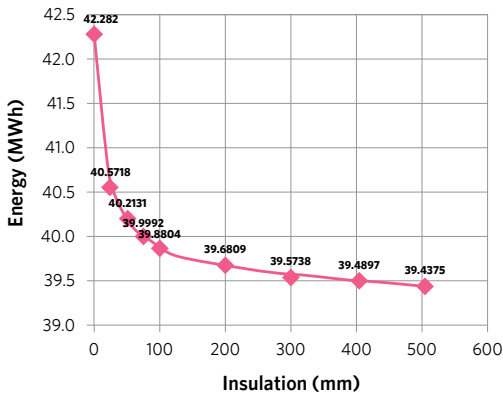
**FLAT ROOF (2PM - 10PM)**



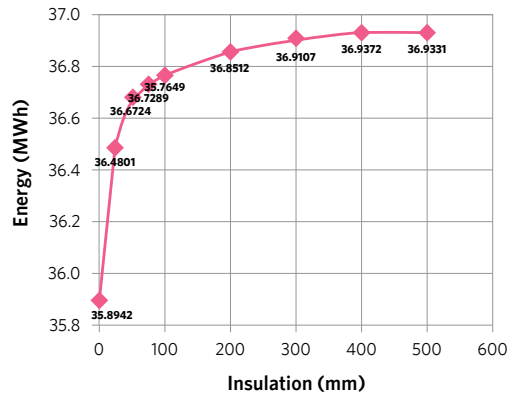
**FLAT ROOF (10PM - 6AM)**



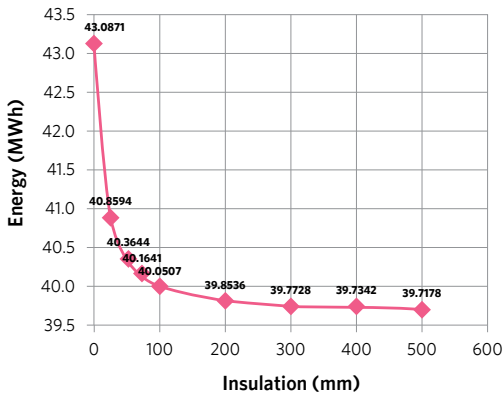
**PITCH ROOF (2PM - 10PM)**



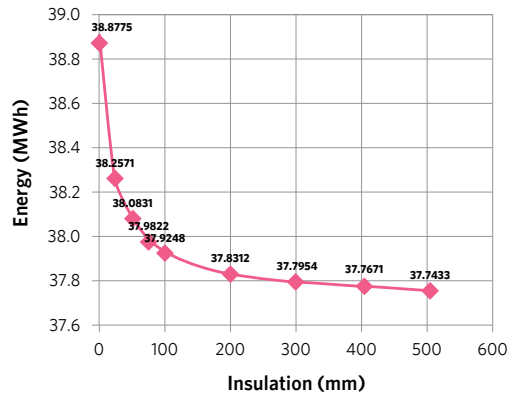
**PITCH ROOF (10PM - 6AM)**



**PITCH ROOF WITH CONCRETE SLAB (2PM - 10PM)**



**PITCH ROOF WITH CONCRETE SLAB (10PM - 6AM)**



## SIMULATION RESULTS

In almost all cases, providing insulation beyond 100mm thickness does not provide a much further benefit in terms of energy efficiency. Provision of the initial 25mm of insulation provided the highest incremental energy saving. As the insulation material becomes incrementally thicker, the incremental energy saved becomes smaller and smaller until it is almost insignificant, especially after an insulation thickness of 100mm onwards.

These results show that the Malaysian climate is not an extreme climatic zone and does not require very heavy roof insulation to provide it with adequate protection.

It is also very interesting to note that the provision of insulation for a pitch roof where the air-conditioning is switched on during the night time showed energy consumption increases with more insulation provided. This clearly reflects the effect of the insulation preventing heat transfer from the space below into the night sky above. The night sky in Malaysia has an average temperature of 15°C (refer to Chapter 2) and is a heat sink for objects on the ground such as building roofs. Objects on the ground that have a temperature above 15°C will radiate heat into the night sky, cooling the object down.

However, when concrete roofs were used instead, the thermal mass effect of the concrete roof changes this behaviour. The heavy thermal mass of concrete absorbs heat during the daytime and when the air-conditioning system is switched on during the night time, the heat from the concrete is released into the room causing higher energy use by the air-conditioning system. Therefore, when a heavy thermal mass roof is used, the provision of roof insulation will reduce the cooling energy of the building even when air-conditioning system is only switched on at night.

It is also interesting to note that although the computed U-value of the pitch roof with plasterboard ceiling and pitch roof with concrete ceiling is very similar, the energy consumption behaviour when air-conditioning is switched on at night is totally different with and without insulation.

Unless it is specifically known that the air-conditioning system will ONLY be switched on during the night time, it is recommended to provide insulation to a pitch roof with plasterboard ceiling because the savings gained when the air-conditioning system is turned on during the daytime far exceed the extra cost to cool the building during the night time.

---

## SUMMARY

This chapter provides the estimated energy savings by the usage of the three (3) basic, commonly used roof insulation types by the building industry. It is important to note that the benefit of roof insulation varies depending on the hours the air-conditioning system is switched on below the roof and the type of roof insulation used. For example, it was found in the study conducted that if the air-conditioning system is switched on only at night, increasing the insulation on a light-weight roof increases the energy consumption because it is insulating the building from the colder night sky above. However, if a heavy-weight roof is used, then there is a benefit from insulating the roof, even though the air-conditioning system is only used at night.

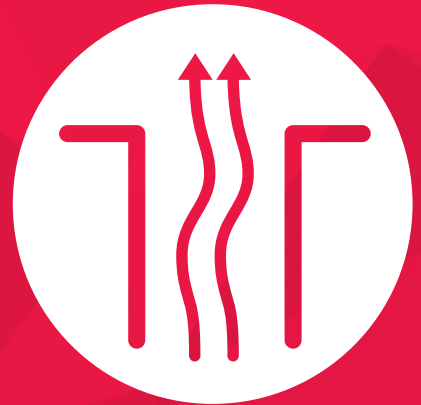
It is also important to note that the energy tariff in Malaysia will increase in time; therefore the computed available budget for roof insulation will also be higher in the coming years. In short, the actual payback for roof insulation computed in this chapter will actually be much shorter in reality.

Finally, roof insulation has been a contentious (and often confusing) subject in Malaysia for the last couple of years. The U-value of the roof system with and without the roof (attic) space in consideration is presented in this chapter with its relationship to energy saving. This is to help to ease the confusion in the marketplace. The use of low-emissivity surfaces as part of the roof insulation has not been conducted yet due to limitation of time for the completion of this guideline, however, it is highly recommended to be conducted upon the next revision of this guideline to draw a clear benefit of low-emissivity surfaces as part of roof insulation in this climate zone.

CHAPTER

# 9

## ATRIUM VENTILATION STRATEGIES



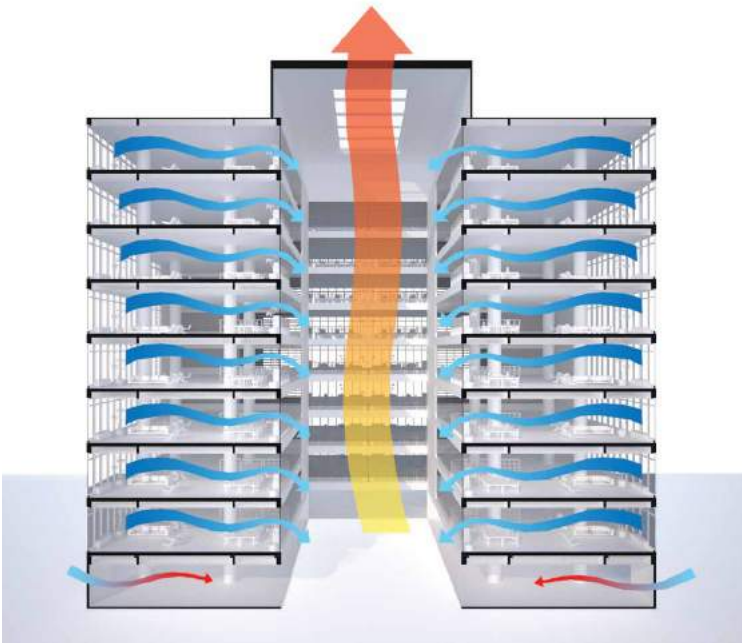


# 9

# ATRIUM VENTILATION STRATEGIES

## INTRODUCTION

It is commonly considered that natural ventilation in atrium spaces is an energy efficient feature in buildings. However, if the atrium space is surrounded by air-conditioned space, the exposure of the atrium space to outdoor air will introduce more surface area of the building to be in contact with outdoor air temperature and humidity. This type of exposure increases the risk of conduction heat and air leakages into the air-conditioned spaces increasing building energy consumption. At the same time, the possibility of air leakages between the conditioned office spaces into the atrium space due to cracks surrounding the partitioned windows (or worse, open windows) will help to cool the ground floor of the atrium space because cold and dry air is heavier than hot and humid air and will drop to the bottom of the atrium space. However, if natural ventilation is practiced for the atrium space, these cold air leakages from the office will be blown away without providing much benefit to the occupants at the atrium space.



**FIGURE 9.1 | CROSS-SECTION OF AN ATRIUM SPACE WITH NATURAL VENTILATION**

Due to these uncertainties of the benefit of using natural ventilation for atrium spaces, this study was conducted to obtain a clear cost and benefit of using natural ventilation versus air-conditioning in the atrium space.

# KEY RECOMMENDATIONS

After analysing the results of 10 simulation cases, the following recommendations were made:

1

It is not possible to provide natural ventilation in atrium spaces to the same comfort level as air-conditioning in the atrium space. At the best simulated scenario, natural ventilation will only provide comfortable conditions for 66% of the office hours. Therefore, if comfort is the utmost priority for the atrium space, it should be air-conditioned.

2

The conventional atrium natural ventilation strategy with permanent openings provided at both the low level and high level to promote the stack ventilation effect in an atrium space provided comfortable conditions for less than 50% of the office operating hours in the Malaysian climate. At the same time, the building's total energy reduction was only 1% in this simulated case scenario. Therefore, this conventional natural ventilation strategy is not recommended to be practiced in the Malaysian climate for an office building environment.

3

However, it was possible to improve on the conventional natural ventilation strategy by keeping the openings at the low level closed from the hours of 7am to 4pm (or have the openings controlled by a temperature sensor to close the openings whenever the indoor air temperature is lower than the outdoor air temperature) to improve the percentage of comfortable conditions to 66% of office operating hours. High level openings are recommended to be kept permanently open to allow hot air to escape from the atrium space. In this case study model, there was up to a 3.3% reduction in the building's total energy consumption.

4

In an air-conditioned atrium scenario, the simplest strategy is to keep the atrium space air-tight (no openings at low or high level of the atrium space) and then provide air-conditioning to the atrium ground floor level up to the height that is occupied. Further energy reductions can be made when the atrium space is naturally ventilated during the night time (or have the openings controlled by a temperature sensor to open the low and high openings whenever the indoor air temperature is higher than the outdoor air temperature). In this case study, a total building energy saving of up to 0.6% was shown to be achievable with the use of a night time natural ventilation strategy with air-conditioning switched on during the daytime. Basically, the cooler external air during the night time cooled down the building structures, requiring less active cooling during the daytime to maintain the air temperature in the atrium space.

# COMFORT

It is better to keep the atrium roof air-tight to reduce the building's total energy consumption as opposed to having a ventilated atrium roof space to exhaust hot air out

In the test reference building scenario, it was found that the most comfortable strategy is to provide air-conditioning to the atrium floor level. This strategy will ensure that comfortable conditions are provided during the entire building occupancy hours of 8am to 6pm.

With this air-conditioned atrium scenario, a test was also conducted with the top of the atrium space open to ventilation (i.e. to allow hot air to escape out of the top of building) while keeping the ground floor air-conditioned. The result of this test showed a total building energy consumption increase of 1.8%. This increase in energy consumption of the building is largely caused by a higher infiltration rate at the air-conditioned ground floor level when doors are opened for people to walk in and out of the building. In addition, the stack ventilation effect would provide a strong suction effect that pulls the outside air into the atrium space when the doors are opened. This condition may be solved by the installation of a revolving door system at the ground floor (however this situation was not tested due to the limited time available). In short, it was found in these simulation studies that keeping the atrium roof air-tight reduces the infiltration rate at the ground floor level when doors are opened and closed for occupant access.

Therefore, it is better to keep the atrium roof air-tight to reduce the building's total energy consumption as opposed to having a ventilated atrium roof space to exhaust hot air out from an air-conditioned atrium space. It is also possible to further improve energy efficiency by providing high U-value materials at the atrium rooftop level to allow heat to be easily conducted out of the building while keeping the atrium space air-tight because the simulation showed that the air temperature at the top of the atrium space is consistently higher than the outdoor air temperature.

It was simulated that the tested building's energy consumption reduced by 0.6% if a natural ventilation strategy is employed whenever the outdoor air temperature is lower than the atrium air temperature even when the ground floor atrium space is air-conditioned during the daytime. The outdoor air temperature will be lower than the indoor atrium air temperature during the night time.

However, if a lower comfort level is acceptable for the atrium space, it is possible to save more than 3% of total building energy consumption with the application of an optimised natural ventilation strategy for the atrium space.



# NATURAL VENTILATION

After a few attempts at optimising the natural ventilation in an atrium space, it was found that the optimum scenario of natural ventilation tested for this chapter would provide 66% of the building occupancy hours of 9am to 5pm with comfortable conditions (i.e. operative temperature below 29°C. Refer to Chapter 1 on thermal comfort of naturally ventilated spaces). This study also showed that on the hottest day scenario, where the outdoor temperature exceeds 35°C, the atrium ground floor operative temperature was able to be maintained 4°C lower than the outdoor air temperature. In addition, a total building energy reduction of 3.3% was achieved using the optimum natural ventilation strategy tested for this chapter.

The optimum natural ventilation strategy tested for this chapter is a type of hybrid ventilation system that opens the atrium space to natural ventilation whenever indoor air temperature is higher than the outdoor air temperature and closes the openings when the outdoor air temperature is higher than the indoor air temperature. This requires control over the openings at the atrium ground floor level. This hybrid ventilation strategy is as follows:

**1**

The ground floor atrium space should be air-tight from the hours of 7am to 4pm and open for natural (stack) ventilation effect from 4pm to 7am daily. The opening hours of 4pm to 7am daily allowed the cooler outdoor air to cool the atrium space down during the night time into the early morning hours. The closing of the ground floor atrium space openings from 7am to 4pm will keep the atrium space cooler for longer hours because it prevents the hot outdoor air from heating up the atrium space during the daytime. In addition, the leaked cooling from the offices is retained by the closed atrium space.

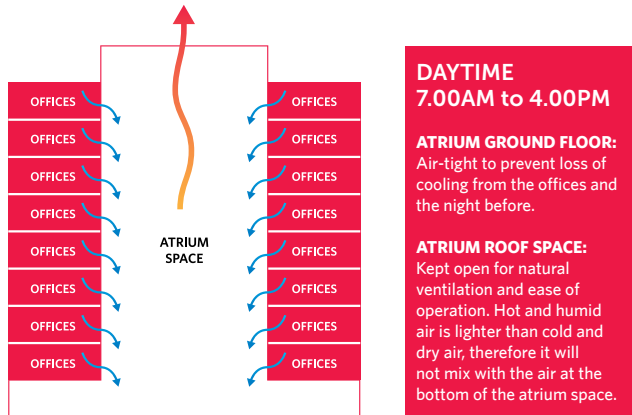
**2**

The atrium roof space is recommended to remain permanently open for natural ventilation. When the ground floor space is kept air-tight during the daytime, it is difficult for outdoor air to infiltrate into the atrium space. However, when the ground floor space is open for ventilation during the night hours, it will promote natural ventilation (due to stack ventilation effect), where the hot air rises up to exit the atrium space at the roof level and the cooler outdoor air will enter the atrium space from the ground floor openings below.

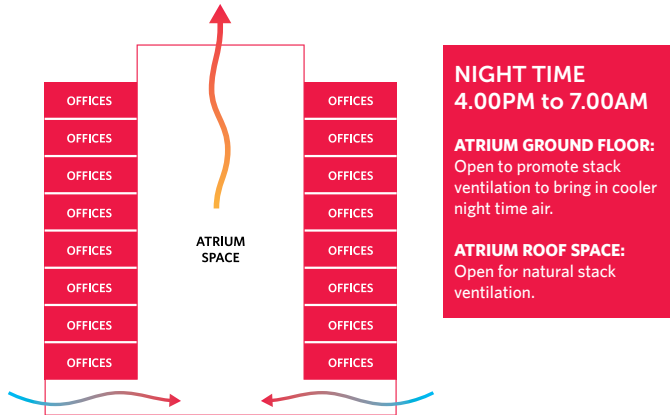
**3**

Further improvements can be obtained by having an automatic system that opens the ground floor and roof to natural ventilation whenever the measured indoor air temperature is higher than the outdoor air temperature. However, the advantage achieved from this form of automatic system may only be viable for larger buildings.

**FIGURE 9.2 | DAYTIME VENTILATION STRATEGY**



**FIGURE 9.3 | NIGHT TIME VENTILATION STRATEGY**





It was also found in these studies that natural ventilation using permanently fixed openings are not as effective as those strategies that allowed the openings at the ground floor level to be opened and closed according to the time or measured temperature.

The following permanently fixed strategies will cause the atrium space to have comfortable conditions for less than 50% of the time:

- 1 Permanently Closed Ground Floor Level and Closed Roof (38% comfortable hours)
- 2 Permanently Closed Ground Floor Level and Open Roof (40% comfortable hours)
- 3 Permanently Open Ground Floor Level and Open Roof (48% comfortable hours)

**TABLE 9.1 | SUMMARY RESULTS OF 11 SIMULATED CASES TESTED FOR CHAPTER 9**

Case	Description	Total Building Energy Saved (%)	Comfortable Hours/Year at Atrium Floor Level (8am to 6pm, Mon-Fri)	Comfortable Hours/Year (%)
<b>BASE</b>	Air-Conditioned Ground Floor Atrium Permanently Closed at Bottom and Top	0.0	2,600	100
<b>CASE 1</b>	Natural Ventilation Atrium Permanently Open at Bottom and Top	1.0	1,235	48
<b>CASE 2</b>	Natural Ventilation Permanently Closed at Bottom and Top	2.3	977	38
<b>CASE 3</b>	Natural Ventilation Permanently Closed at Bottom and Open at Top	2.3	1,040	40
<b>CASE 4</b>	Natural Ventilation Temperature Controlled Ventilation at Bottom and Top	3.3	1,713	66
<b>CASE 5</b>	Natural Ventilation Time Controlled Ventilation at Bottom and Top	3.0	1,666	64
<b>CASE 6</b>	Natural Ventilation Time Controlled Ventilation at Bottom and Permanently Open Top	3.0	1,669	64
<b>CASE 7</b>	Natural Ventilation Temperature Controlled Ventilation at Bottom and Permanently Open Top	3.3	1,713	66
<b>CASE 8</b>	Air-Conditioned Ground Floor Atrium Permanently Open at the Top	-0.9	2,600	100
<b>CASE 9</b>	Air-Conditioned Ground Floor Atrium Temperature Controlled at the Top	-0.4	2,600	100
<b>CASE 10</b>	Air-Conditioned Ground Floor Atrium Temperature Controlled at both Top and Bottom	0.6	2,600	100

# SIMULATION MODEL

An eight (8) floor office building was modelled for this study with the atrium located in the center of the building, surrounded by air-conditioned office space from the 1st floor level to 8th floor level. The entire ground floor was modelled as part of the atrium space and was air-conditioned or naturally ventilated depending on the case studies. The rest of the atrium spaces were not air-conditioned for all cases.

FIGURE 9.4 | VIEW OF ATRIUM SIMULATION MODEL

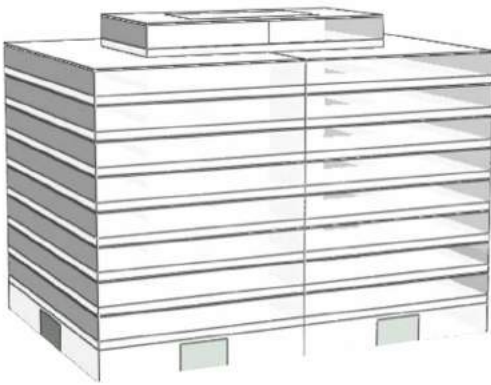
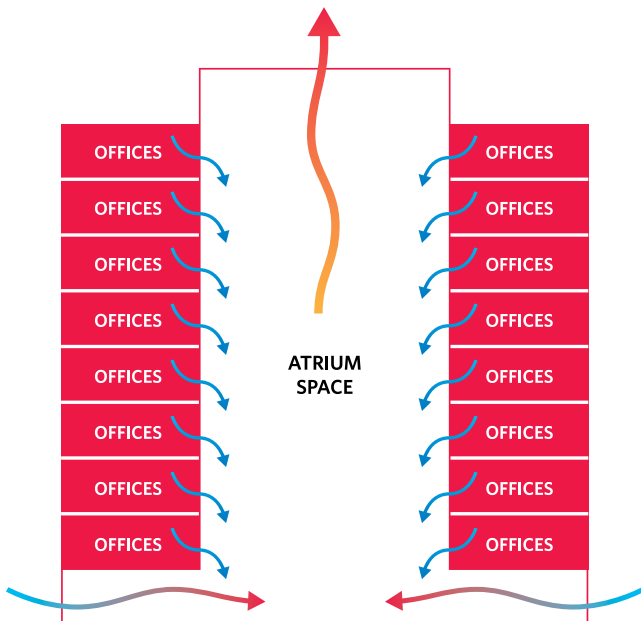


FIGURE 9.5 | CROSS-SECTION VIEW OF ATRIUM SIMULATION MODEL



The simulation model took these factors into consideration:

**1** Internal walls facing the atrium space had a window-to-wall ratio of 70%. These internal walls separate the air-conditioned offices from the atrium space. The internal glazing was assigned as single glazing clear glass. In addition, 1% of the internal glazing area was assumed to be permanently open to model air leakages between the offices and the atrium space. This assumption will be valid for most buildings where the internal windows are all kept closed to the atrium space. The 1% opening assumption made in this study represents the leakages due to the cracks between the window frames and the walls.

**2** Atrium roof top is modelled to be higher than the highest office floor level. The higher roof height of atrium spaces is typically designed for aesthetic reasons but in this case it is also to create a space for storage of hot air for it to be conducted or ventilated out of the building.

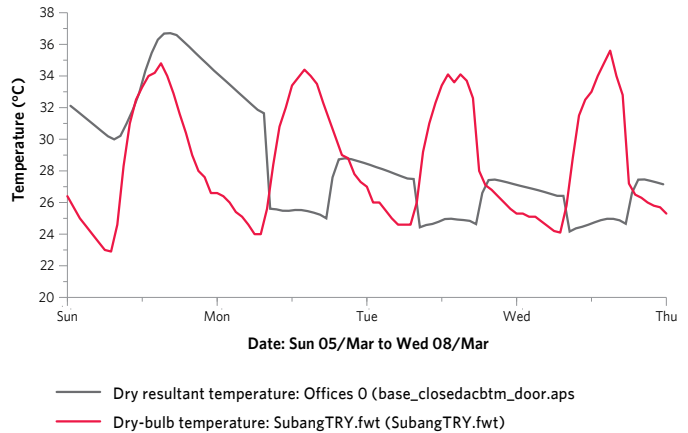
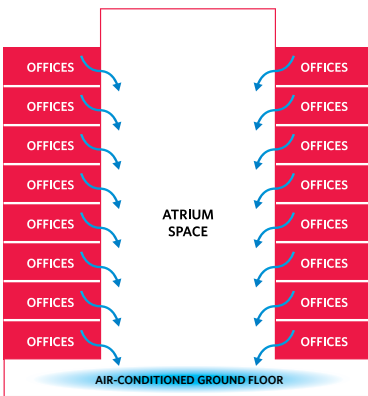
**3** 30% of the atrium roof was modelled as a skylight to allow natural daylight into the atrium space.

# AIR-CONDITIONED ATRIUM STRATEGIES

## BASE CASE: AIR-CONDITIONED, PERMANENTLY CLOSED ATRIUM SPACE

In a typical building scenario, the atrium space will remain closed day and night. Note that the temperature in the atrium space is significantly warmer than the outdoor air temperature during the night hours and weekends. This temperature measurement is taken at the ground floor of the atrium space where building occupants will pass through.

**FIGURE 9.6 | CROSS-SECTION VIEW OF ATRIUM SIMULATION MODEL**

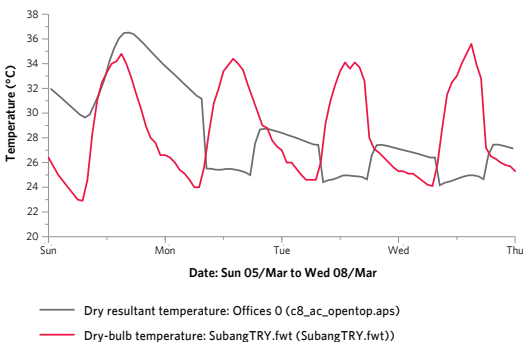
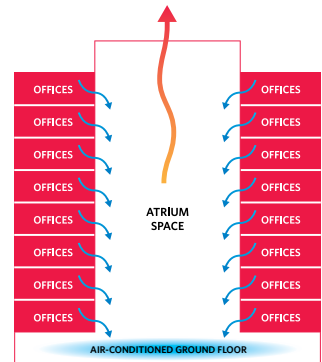


## CASE 8: AIR-CONDITIONED GROUND FLOOR, ATRIUM PERMANENTLY OPEN AT THE TOP

### THE IDEA

Since cold and dry air-conditioned air is heavier than hot and humid air, this strategy will attempt to allow hot and humid air to rise in the atrium space and allows it to escape at the top of the building space.

**FIGURE 9.7 | CROSS-SECTION VIEW OF ATRIUM SIMULATION MODEL**



### THE REALITY

Having the top of the atrium space open to ventilation increases the infiltration rate significantly at the ground floor level when the doors are opened and closed for occupant access. This increase in infiltration rate increases both the sensible and latent load for the air-conditioning system at the ground floor level. The total building energy consumption was increased by 0.9% in this test case scenario compared to the Base Case scenario. The atrium ground floor doors were modelled to be open 10% of the building air-conditioning hours.

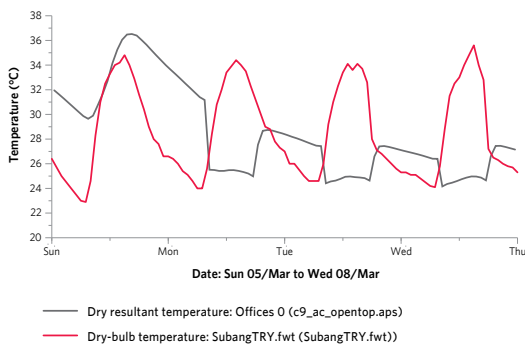
## CASE 9: AIR-CONDITIONED GROUND FLOOR, TEMPERATURE CONTROLLED OPENINGS AT THE TOP

### THE IDEA

Instead of keeping the top of the atrium roof permanently open to natural ventilation, an attempt is made to have the roof ventilation open to exhaust hot air out of the atrium space whenever the measured indoor air temperature at the roof space is warmer than the outdoor air temperature. Otherwise the atrium space is kept air-tight.

### THE REALITY

The simulation result was similar to Case 8 where the top of the atrium space was kept permanently open. Total building energy consumption increased by 0.4% in this test case scenario compared to the Base Case scenario where the atrium space was kept air-tight. Again, it was found that having the top of the atrium space opened to ventilation increases the infiltration rate significantly at the ground floor level when doors are opened and closed for occupant access. This increase in infiltration rate increases both the sensible and latent load for the air-conditioning system at the ground floor level. The atrium ground floor doors were modelled to be open 10% of the building air-conditioning hours.



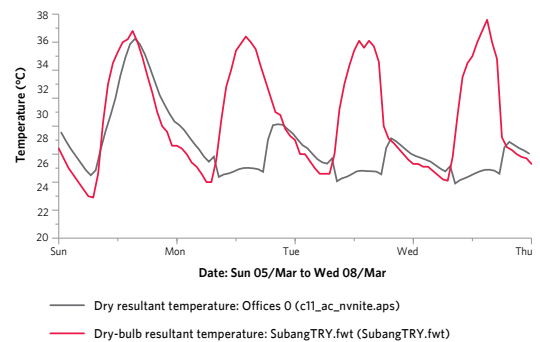
## CASE 10: AIR-CONDITIONED GROUND FLOOR, TEMPERATURE CONTROLLED OPENINGS AT THE TOP AND BOTTOM

### THE IDEA

It was observed that the ground floor atrium space air temperature is significantly higher than the outdoor air temperature whenever the air-conditioning system is switched off. In this case study, a temperature differential sensor is used to open the roof top louvres and ground floor doors whenever the indoor space is warmer than the outdoor air temperature. This will then allow natural cooling of the ground floor atrium space when air-conditioning system is switched off.

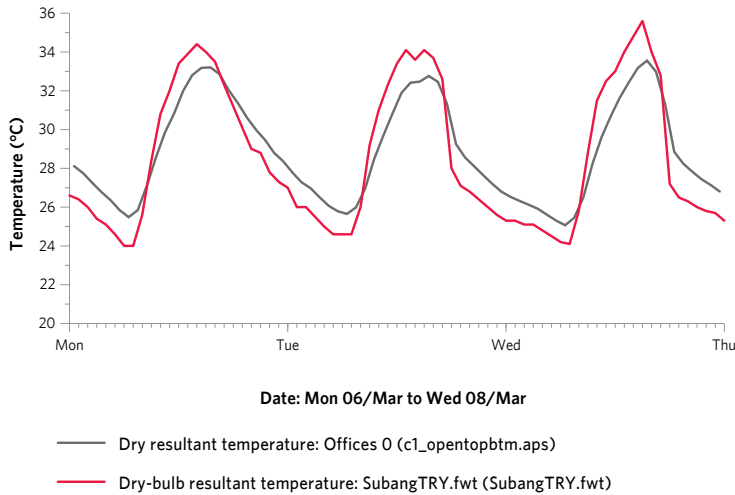
### THE REALITY

The simulation result was similar to Case 8 where the top of the atrium space was kept permanently open. Total building energy consumption increased by 0.4% in this test case scenario compared to the Base Case scenario where the atrium space was kept air-tight. Again, it was found that having the top of the atrium space opened to ventilation increases the infiltration rate significantly at the ground floor level when doors are opened and closed for occupant access. This increase in infiltration rate increases both the sensible and latent load for the air-conditioning system at the ground floor level. The atrium ground floor doors were modelled to be open 10% of the building air-conditioning hours.



# NATURAL VENTILATION STRATEGIES

## CASE 1: PERMANENTLY OPEN TOP AND BOTTOM



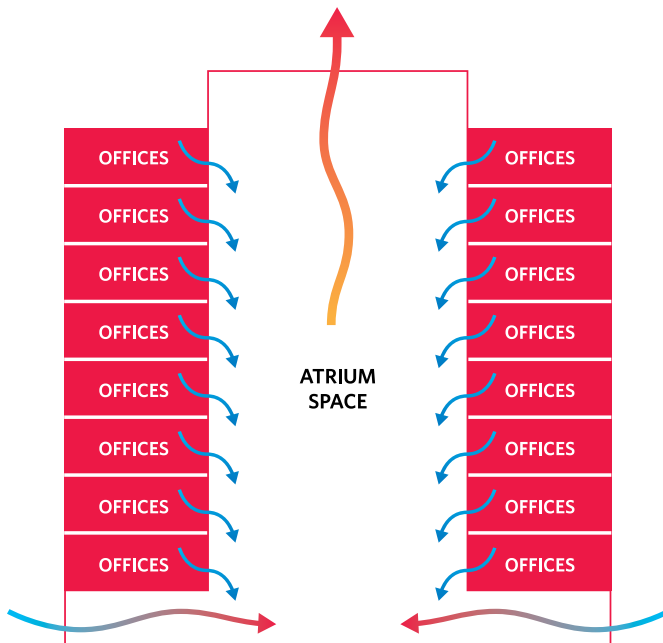
### THE IDEA

To allow natural stack ventilation to cool the atrium space the entire day.

### THE REALITY

The operating hours of the office building coincides with the hottest temperatures of the day. Allowing such natural ventilation strategy allowed hot outdoor air temperature to heat up the ground floor space during the daytime. However, during the night time, the colder outdoor air temperature does help to cool the space down.

FIGURE 9.8 | CROSS-SECTION VIEW OF ATRIUM SIMULATION MODEL



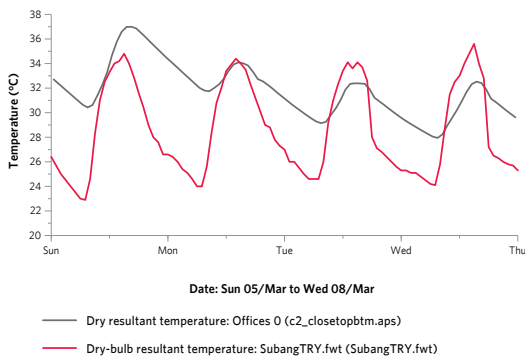
## CASE 2: PERMANENTLY CLOSED TOP AND BOTTOM

### THE IDEA

To try to capture all the cooling that is conducted and infiltrated from the offices into the atrium space.

### THE REALITY

Keeping the atrium sealed air-tight turns this space into a green-house, especially during the weekends. The simulated atrium space was hotter than the outdoor air temperature during weekends. During weekdays, with the air-conditioning running in the offices, the conduction and infiltration leakages into the atrium space reduces its daily peak operative temperature but it was not enough to keep it at comfortable level.



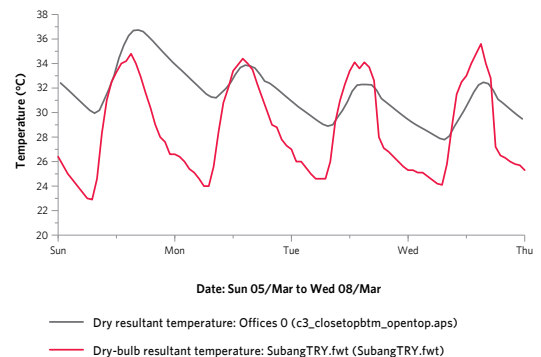
## CASE 3: PERMANENTLY CLOSED BOTTOM AND OPEN TOP

### THE IDEA

This case study attempts to capture all the cooling that is conducted and infiltrated from the offices into the atrium space, while allowing the hot air to escape via the top of the atrium roof.

### THE REALITY

Although it worked as planned, the amount of hot air escaping from the top of the atrium space is not significant enough to reduce the operative temperature of the ground floor level by much.



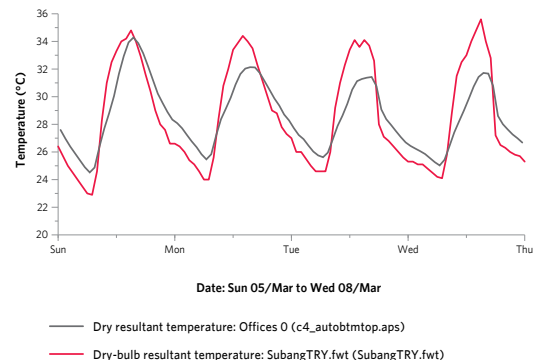
## CASE 4: TEMPERATURE CONTROLLED VENTILATION AT BOTTOM AND TOP

### THE IDEA

Open the ground floor and rooftop for natural ventilation whenever the air temperature of the indoor atrium space is higher than the outdoor air temperature. Close the natural ventilation whenever the outdoor air temperature is higher than the indoor atrium space air temperature. This will allow the cooler outdoor air to cool the atrium space down when the time is right and when the outdoor air is hot, keep the atrium space air-tight to prevent it from heating up the space.

### THE REALITY

Due to the captured cooling that was conducted and infiltrated from the offices to the atrium space, the peak operative temperature of the ground floor atrium space is approximately 4°C lower than the peak outdoor air temperature. In short, this strategy worked as planned and provided the best combination of comfort and energy reduction. Unfortunately, we were still unable to achieve comfortable conditions at all times at the atrium space. In this best-case scenario it was simulated that the operative temperature will be higher than 29°C (80% of the thermal adaptive comfort limit) for 887 hours a year, or an average of 3.4 hours per working day.



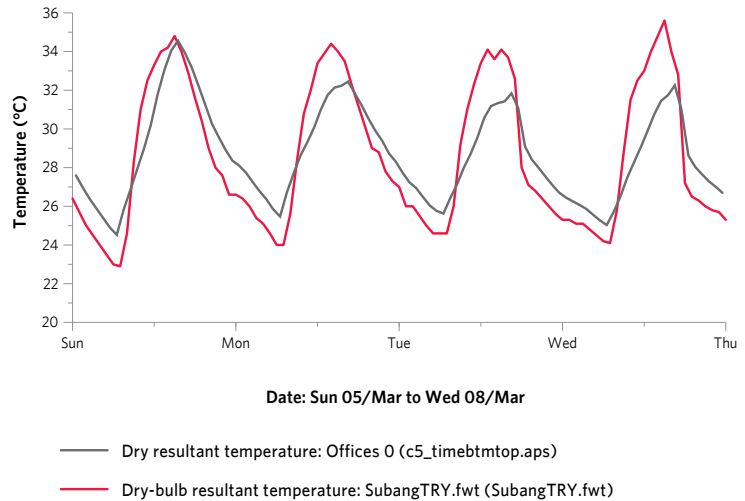
## CASE 5: TIME CONTROLLED VENTILATION AT BOTTOM AND TOP

### THE IDEA

Since the daily air temperature pattern in Malaysia is fairly consistent, what would be the impact of using a time controller instead of temperature differential controller? In this case study, the atrium openings are kept open from the hours of 7am to 4pm and closed from the hours of 4pm to 7am.

### THE REALITY

The number of uncomfortable hours increased by 2% as compared to Case 4. It can be concluded that the time controller is almost as effective as using a temperature differential controller.



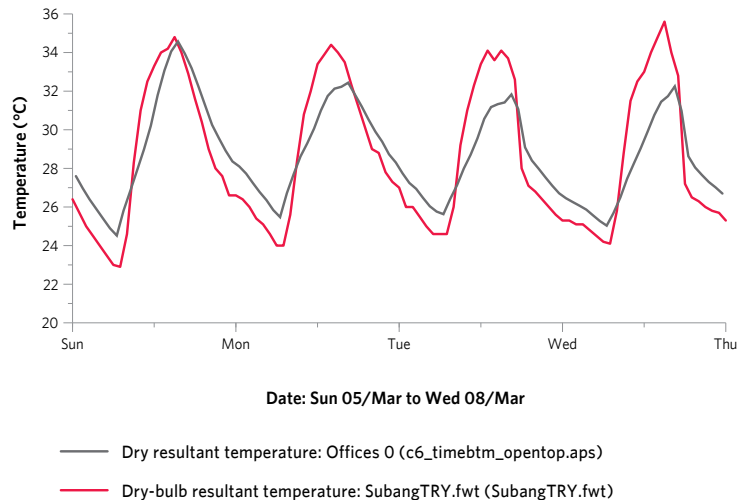
## CASE 6: TIME CONTROLLED VENTILATION AT THE BOTTOM AND PERMANENTLY OPEN AT THE TOP

### THE IDEA

Instead of having controls at both the top and bottom of the atrium space for natural ventilation, this simulation case study will test the option of leaving the top of the atrium space open without any controls to allow hot air to escape out. In the meantime, the bottom of the atrium space may be manually or automatically controlled to keep hot outdoor air out of the building during the daytime and allowing natural ventilation during the night time when the outdoor air is cooler than the atrium air temperature.

### THE REALITY

The number of uncomfortable hours increased by 2% as compared to Case 4 and matched the result for Case 5. It can therefore be concluded that it is not required to place any controls on the top floor of atrium space when the atrium is naturally ventilated. Controls are only required at the ground floor level to increase the comfort level in the building.



## SUMMARY

This chapter explored up to 10 different options on both naturally ventilated and air-conditioned scenarios for an atrium ground floor space, to maximise comfort while minimising the energy consumption of the building. All 10 different options explored were provided with a distinctive theory on how and why each strategy should work to increase comfort and reduce energy use. However, the results of the simulation studies conducted for this chapter showed that some of the theories worked and some did not.

In summary, providing permanent natural (stack) ventilation strategy to an atrium space reduces the building energy consumption by 1.0% in the simulated model. However, comfortable conditions on the ground floor atrium space was simulated to be achieved only about 48% of the office hours. It was not possible to provide comfortable conditions at all times during occupancy hours in the atrium space using natural ventilation strategies. It was possible to increase the number comfortable hours significantly in a naturally ventilated space by keeping the ground floor doors closed during the daytime to keep the hot air out, while opening them up for natural ventilation at night to cool the space down using cooler night time air temperature.

If it is necessary to provide 100% of the building occupancy hours with comfortable conditions, it is simplest to provide air-conditioning to the ground floor atrium space and to keep the atrium space air-tight. A further building energy reduction of 0.6% was simulated to be gained by ventilating the atrium space at night (i.e. open the atrium space at night for stack ventilation effect).

---

END OF CHAPTER 9

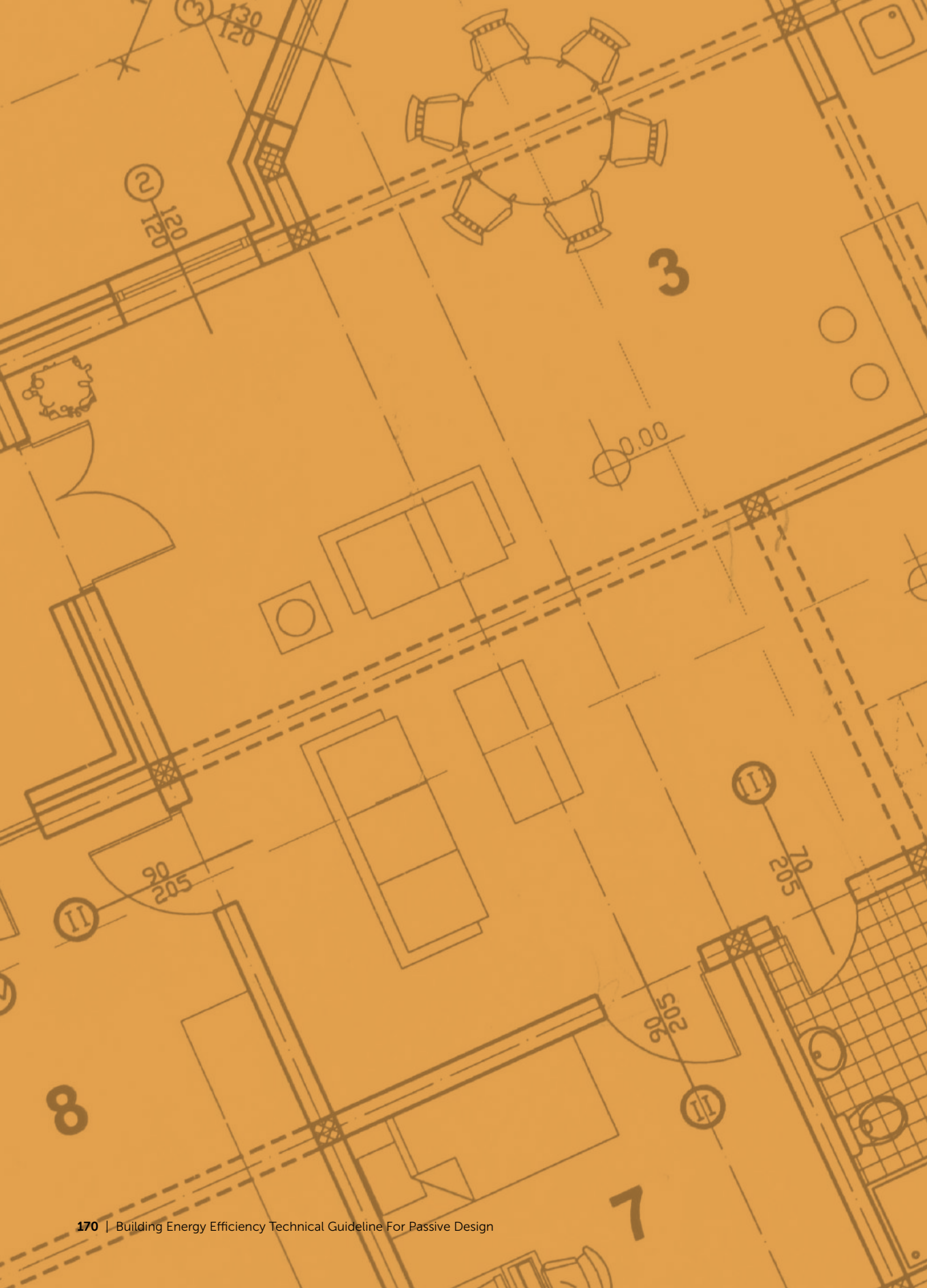


CHAPTER

# 10

## ZONING & INFILTRATION CONTROL





## 10

# ZONING & INFILTRATION CONTROL

## INTRODUCTION

### ZONING

It is known that there are practicing architects that practice energy efficiency zoning in buildings by locating rooms according to the flow of leakage of air-conditioned air from the coldest room towards the warmest room. This will ensure that leakage of cold air from the coldest room will benefit other spaces before it is allowed to escape out of the building. This assumption is tested in this chapter and the energy saving potential from such an implementation is also provided in this chapter.

### INFILTRATION

The infiltration of outdoor air into air-conditioned spaces has a significant impact on the energy efficiency and indoor environmental quality in a building. In the Malaysian climate, infiltration introduces both sensible and latent (moisture) heat into a building. The latent heat (moisture) presents a larger problem for the building because not only does moisture require a significant amount of energy to be removed by the air-conditioning system, but excessive moisture also leads to a higher risk of mold growth in the building.

Traditionally, most large Malaysian buildings are designed by the engineers to be positively pressured by the air-conditioning system. The positive pressure is achieved via the intake of fresh air by the air-conditioning system. The intake of fresh air is a requirement by Ashrae 62.1 to maintain the air quality in a

building. The fresh air requirement by Ashrae 62.1 (2007) is approximately 0.50 ACH (air-changes per hour) based on an occupant density of 10 m<sup>2</sup>/person. Therefore, typical buildings with mechanical fresh air intakes are positively pressured by exfiltrating approximately 0.5 ACH out of the building when toilets are naturally ventilated.

The positive pressure in a building reduces the risk of mold growth by reducing the possibility of infiltration. However, in buildings with large leakages, the exfiltration rate of 0.5 ACH may not be adequate. A study of 10 buildings in 2008 by JKR, found that the measured total fresh air change rates in buildings were as high as 2.0 ACH, with an average of 1.0 ACH per building.<sup>1</sup> This indicates that on average, Malaysian buildings have an infiltration of an additional 0.5 ACH of fresh air besides the 0.5 ACH fresh air intake by the air-conditioning system.

It is also important to note that an air-tight building would open up further opportunities to improve the energy efficiency in the building with the potential use of a heat recovery system to pre-cool and pre-dry the fresh air provided for the building. A heat recovery system is not a feasible energy efficiency option to be implemented in a leaky building because it may cause higher infiltration into the building (building is not positively pressured anymore), and this may lead to condensation and mold growth problems inside the building.

<sup>1</sup> Ezzuddin Ab Razad, CK Tang, Public Works Department (PWD), Kuala Lumpur, Malaysia. Control Of Moisture & Infiltration For Advanced Energy Efficient Buildings In The Tropics, Conference on Sustainable Building South East Asia, 4-6th May 2010, Malaysia

# KEY RECOMMENDATIONS

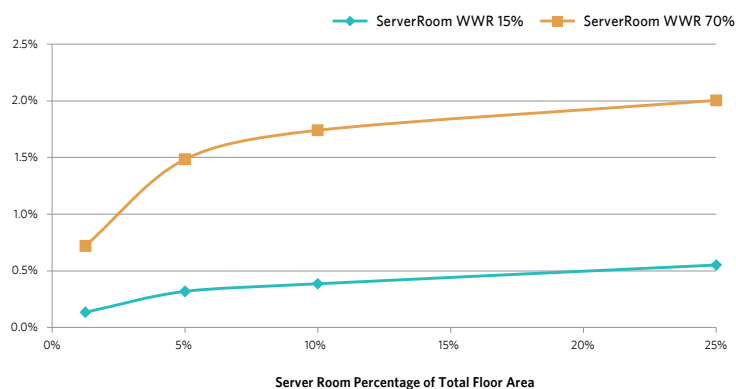
## ZONING REQUIREMENT

The simulation result of a single floor level indicates a clear advantage of placing a 24-hour air-conditioned room (such as a server room) in the center of a building surrounded by an 8-hour air-conditioned zone. In this study, it was shown that the energy saved due to the implementation of this feature is basically influenced by two (2) features; the size of the server room compared to the entire floor area and the window-to-wall ratio (WWR) of the server room.

Although not recommended, it is still possible to place 24-hour air-conditioned rooms with the external façade. To reduce the impact of increased energy consumption by the building, the 24-hour air-conditioned room located with the external façade needs to have a minimum window area. The larger the window area, the higher the increase in energy consumption of the building.

In existing building scenarios, it is more common to have the 24-hour air-conditioned zones located with the external façades, together with a high window-to-wall ratio (WWR). In cases such as these, it is recommended to convert the glazing area into opaque surfaces to prevent solar heat gain in the 24-hour air-conditioned spaces. It is also easier to insulate opaque surfaces with better insulation properties. This study shows that an energy saving increment of up to 2% per floor is possible when the glazing area remained at 70% WWR for the 24-hour air-conditioned zone. Refer to Chapters 5 and 6 for further details on preventing solar heat gain in buildings.

**CHART 10.1 | ENERGY INCREASE PER FLOOR BY LOCATING 24-HOUR AIR-CONDITIONED ROOMS WITH THE EXTERNAL FAÇADE INSTEAD OF AT THE CENTER (CORE) OF THE BUILDING (WWR = WINDOW-TO-WALL RATIO)**



## INFILTRATION CONTROL

The results of this study show that it is extremely important to keep the windows closed whenever the air-conditioning system is running. Reducing the percentage of opened windows from 1.6% to 0.8% of the window area reduces the building's energy consumption by 5%. Ensuring that all the windows were fully closed further reduces the building's energy consumption by another 4%. **Any building energy efficiency feature that provides more than 1% in total building energy savings should be considered as a significant saving that cannot and should not be ignored.** In this case, total building energy savings of up to 9% are possible just by ensuring that windows are kept closed, as compared to having 1.6% of the window area left open.

Moreover, ensuring that windows are closed is neither a complicated matter nor an expensive item to address. Finally, it is also recommended to minimise the number of operable windows in an office building to reduce the risk of these windows being left open by the building occupants.

In this study of a 17-floor building model, keeping the ground floor door open to infiltration when the air-conditioning system is running caused the building to consume an additional 0.2% energy. The reason for this limited loss of efficiency for the entire building is because only one air-handling unit (AHU) is exposed to the infiltration from the open door. The loss of efficiency is then limited to the maximum capacity of this single AHU.

In addition, keeping the main door closed 90% of the time instead of keeping it open all the time will provide a saving of approximately RM6,000 per year in energy bills based on the current electricity tariff rate. This amount saved would provide a budget of RM60,000 to be invested in a revolving door system or a double door system with a simple payback of 10 years.

**TABLE 10.1 | ENERGY REDUCTION OF A TEST CASE SCENARIO DUE TO IMPROVEMENTS MADE TO REDUCE THE INFILTRATION IN THE BUILDING**

Case	Description	BEI (kWh/m <sup>2</sup> /year)	% Reduction	% Reduction per Step	RM Saved/Year/Step	Max Infiltration Rate (ACH)	Mean Infiltration Rate (ACH)
Base	Worst Case Scenario, Entrance Door 100% Open	243.2	0.0%	0.0%	0	4.19	0.97
1	Entrance Door 50% Open, 1.6% of Windows Open	242.9	0.1%	0.1%	2,911	4.19	0.96
2	Entrance Door 10% Open, 1.6% of Windows Open	242.6	0.2%	0.1%	2,957	4.13	0.96
3	Entrance Door 10% Open, 0.8% of Windows Open	230.4	5.3%	5.0%	119,852	2.23	0.5
4	No Windows Open, Crack Flow Coefficient of 1.1	220.1	9.5%	4.3%	101,518	0.94	0.17
5	Crack Flow Coefficient of 0.74	218.2	10.3%	0.8%	18,237	0.64	0.11
6	Crack Flow Coefficient of 0.39	216.3	11.1%	0.8%	18,968	0.34	0.06
7	Crack Flow Coefficient of 0.13	214.6	11.8%	0.7%	16,633	0.12	0.02
8	Crack Flow Coefficient of 0.086	214.1	12.0%	0.2%	4,440	0.09	0.01

Finally, the simulation results also show a significant energy reduction potential by ensuring that the window frames are well sealed to prevent air leakages. From this study, it was shown that up to RM10 per meter run of window perimeter can be invested in window seals to reduce the Crack Flow Coefficient from 1.1 down to 0.086 (l s<sup>-1</sup> m<sup>-1</sup> Pa<sup>-0.6</sup>).

**TABLE 10.2 | BUDGET AVAILABLE FOR SEALING WINDOW FRAME FROM LEAKAGES**

Cases (l s <sup>-1</sup> m <sup>-1</sup> Pa <sup>-0.6</sup> )	RM/m saved per year per step	3 years payback Budget (RM/m run of window perimeter)
C5, Crack Flow Coefficient of 1.1 down to 0.74	1.04	3.12
C6, Crack Flow Coefficient of 0.74 down to 0.39	1.08	3.25
C7, Crack Flow Coefficient of 0.39 down to 0.13	0.95	2.85
C8, Crack Flow Coefficient of 0.13 down to 0.086	0.25	0.76
<b>Total</b>	<b>3.33</b>	<b>9.98</b>

# MODELLING OF ZONING CONTROL

A single floor model was created for this simulation study on the impact of the server room size and location in an office building.

**TABLE 10.3 | SIMULATION CASE MODELS**

Case	Total Floor Area (m <sup>2</sup> )	Office Area (m <sup>2</sup> )	Server Room Area (m <sup>2</sup> )	% of Total Floor Area	Base Plan Diagram (Server Room in center of building)	Alternative Plan Diagram (Server Room with external façade)
1	2,000	1,975	25	1.25%		
2	2,000	1,900	100	5.0%		
3	2,000	1,800	200	10.0%		
4	2,000	1,500	500	25.0%		

The base building windows were modelled with a window-to-wall ratio (WWR) of 70%. The server room with external façade was tested with two (2) types of WWR:

- 1 **WWR of 70%** - to model offices moving into an existing building and the server room has to be located with the external façade with WWR of 70%. In this case, the external window area is the same as the base case.
- 2 **WWR of 15%** - to model a building design with a low WWR applied to the server room because daylight is not required in these kinds of rooms. In this case, the external window area is less than the base case.

External infiltration is modelled for all the windows, assuming a Crack Flow Coefficient of 0.41 (l s<sup>-1</sup> m<sup>-1</sup> Pa<sup>-0.6</sup>), representing the higher quartile of a weather-stripped hinged window.<sup>2</sup>

Internal infiltration between the server room and office space was also modelled with a Crack Flow Coefficient of 0.13 (l s<sup>-1</sup> m<sup>-1</sup> Pa<sup>-0.6</sup>), representing the average of a weather-stripped hinged window and an access door that is open 10% of the time during occupancy hours. In addition, the door was modelled with a Crack Flow Coefficient of 2.0 (l s<sup>-1</sup> m<sup>-1</sup> Pa<sup>-0.6</sup>) as a leaky internal door that is usually used here in Malaysia. It was modelled this way to capture the effect of leakage of air-conditioned air from the server room into the offices.

<sup>2</sup> An Analysis and Data Summary of the AIVC's Numerical Database. Technical Note AIVC 44, March 1994. Air Infiltration and Ventilation Centre.

# THE SCIENCE OF ZONING CONTROL

The idea of reducing the leakage of cold air from the 24-hour air-conditioned room into the 8-hour air-conditioned room was not as significant as initially thought to be. The detailed analysis of the results showed that the exposure of a 24-hour air-conditioned room to the external façade has a significantly higher impact on the building energy consumption (due to solar and conduction heat gain) than the internal infiltration leakages from the 24-hour air-conditioned room into the 8-hour air-conditioned room.

The science of zoning control was found to be influenced by these factors:

- ❶ Solar Heat Gain
- ❷ Conduction Heat Gain
- ❸ Electrical Lighting Heat Gain and Energy Consumption
- ❹ Cooling System Coefficient of Performance (Efficiency of Air-Conditioning System) for:
  - a) 8-hour air-conditioned zone
  - b) 24-hour air-conditioned zone

**TABLE 10.4 | BREAKDOWN OF COOLING LOAD AND ENERGY CONSUMPTION WHERE THE SERVER ROOM OCCUPIES 25% OF THE FLOOR AREA**

Annual Energy Consumption	COOLING LOAD									ENERGY CONSUMPTION			
	Solar heat gain (MWh)	Conduction heat gain (MWh)	Infiltration heat gain (MWh)	Lighting heat gain (MWh)	Equipment heat gain (MWh)	People heat gain (MWh)	Infiltration latent gain (MWh)	People latent gain (MWh)	Total Cooling Load (MWh)	Total Cooling System Energy (MWh)	Total Equipment Energy (MWh)	Total Lighting Energy (MWh)	Total Building Energy (MWh)
Server at Center, Base WWR 70%	207	-29	11	41	517	30	75	20	872	321	517	41	880
<b>ServerRoom WWR 70%</b>	212	-17	11	45	517	30	74	20	891	334	517	45	897
Difference (MWh)	4.7	11.3	-0.4	4.3	0.0	0.0	-0.8	0.0	18.4	13.2	0.0	4.3	17.6
% Difference	2.2%	-39.4%	-3.2%	10.5%	0.0%	0.0%	-1.1%	0.0%	2.1%	4.1%	0.0%	10.5%	2.0%
Impact	0.5%	1.3%	0.0%	0.5%	0.0%	0.0%	-0.1%	0.0%	2.1%	1.5%	0.0%	0.5%	2.0%
Server at Center, Base WWR 70%	207	-29	11	41	517	30	75	20	873	321	517	41	880
<b>ServerRoom WWR 15%</b>	174	-7	10	45	517	30	72	20	862	322	517	45	884
Difference (MWh)	-33.4	21.8	-0.7	4.3	0.0	0.0	-2.4	0.0	-10.7	0.4	0.0	4.3	4.8
% Difference	-16.1%	-76.1%	-6.6%	10.5%	0.0%	0.0%	-3.2%	0.0%	-1.2%	0.1%	0.0%	10.5%	0.6%
Impact	-3.8%	2.5%	-0.1%	0.5%	0.0%	0.0%	-0.3%	0.0%	-1.2%	0.05%	0.0%	0.5%	0.6%

## SOLAR HEAT GAIN

Although the external glazing area and properties are the same for the building, locating the 24-hour air-conditioned room with the external façade captures marginally more solar heat gain than having it located at the center of the building.

More importantly, there was a significant reduction of solar heat gain when the external glazing window-to-wall ratio was reduced for the 24-hour air-conditioned room. For an office building, the server room (air-conditioned for 24-hours) would not benefit from daylight harvesting. Therefore, it is recommended to place the server room in a location without any windows. If it is not possible to do, so refer to Chapters 4 and 5 to reduce solar heat gain in the server room.

## CONDUCTION HEAT GAIN

Conduction heat gain increases significantly when the 24-hour air-conditioned room is located with the external façade. The reason is that because the internal temperature of the 24-hour air-conditioned room is always lower than the external air temperature, it causes a higher conduction heat gain, especially over the weekends, due to the exposure of colder room temperatures to the outdoor conditions.

Again, it is recommended to locate 24-hour air-conditioned rooms at the center of a building, away from the external façade to reduce conduction heat gain in these rooms.

## ELECTRICAL LIGHTING HEAT GAIN AND ENERGY CONSUMPTION

Locating server rooms with the external façade reduces the areas where daylight can be harvested for the office spaces. Therefore, more electrical lights will be switched on in the building to provide lighting for the office spaces. However, this increase is only marginal in all the simulated cases, with the largest light power consumption increase of 0.5% when the server room occupies 25% of the floor area. In summary, the energy increase of lighting is dependent on the amount of external façade used that deprives the office spaces of daylight.

## COOLING SYSTEM COEFFICIENT OF PERFORMANCE (EFFICIENCY OF AIR-CONDITIONING SYSTEM)

The cooling system coefficient of performance (COP) is an indication of the efficiency of the air-conditioning system. A higher COP number indicates better efficiency. Typical centralised air-conditioning systems for medium to large sized buildings have a higher COP than a small precision air-conditioning unit for a small server room. This means that a centralised air-conditioning system is typically more efficient than a smaller air-conditioning unit used for the server room. In this study model, the centralised air-conditioning system was modelled as a chilled water loop system with a chiller COP of 5.7 and a Variable Air Volume (VAV) was used. While the smaller precision air-conditioning unit was modelled as a direct expansion cooling system with a COP of 3.5 and a Constant Air Volume (CAV) was used.

Due to the reason that the centralised air-conditioning system is usually more efficient, it was used to cool the server room during building occupancy hours (when centralised air-conditioning system was in operation) and the smaller precision air-conditioning unit was used for the server room during the night hours (when centralised air-conditioning system was off).

It is important to note that running a centralised air-conditioning system at a very low load (such as using it to provide cooling for an office building's server room), is very inefficient. This is why server rooms are normally installed with precision air-conditioning systems that are set to run during the hours where the centralised system is not in operation.

The result of this study indicates that locating the server room with external façade increases the required capacity (size) of the smaller air-conditioning unit for the server room, while reducing the capacity (size) of the centralised air-conditioning system. Although the smaller air-conditioning unit for the server room is only in operation when the centralised system is not, the increase in capacity (size) of a less efficient air-conditioning system increases the overall building energy consumption.

It was also interesting to note that although the reduction of the window-to-wall ratio (WWR) to 15% for the server room reduces the floor's cooling load by 1.2% as compared to the base case with a WWR of 70% all-round the building, the cooling energy (electricity used) actually increased marginally (0.1%) due to the use of a higher capacity, less efficient precision cooling system as shown in **Table 10.4**. In short, the energy saved by the reduction of WWR is lost due to the use of a higher capacity, less efficient precision cooling system. A higher capacity precision system was required because the server room was moved from the center to the side, where 50% of the walls are exposed to the outdoor conditions.



# MODELLING OF INFILTRATION

The energy consumption of a building caused by the infiltration of outdoor air into air-conditioned spaces is strongly dependent on these factors:

- 1 Oversized Limit of Air-Conditioning System**

An oversized air-conditioning system would enable it to have large spare capacity to cool a space down even when the doors and windows are kept open for infiltration. This is a case that is easily observed in many Malaysian buildings where the temperature remains cold even with open doors and windows. In this study, an oversizing factor of 15% is applied to the model as per the design recommendations by Ashrae 90.1. However, in actual practice, oversizing by a factor of 2 to 3 is known to have occurred.<sup>3</sup>
- 2 Opening Hours of Ground Floor Doors**

It is also fairly common to find main entrance doors to buildings in Malaysia that are kept permanently open with the air-conditioned air leaking out all the time. Three (3) scenarios were tested for this feature. Main entrance doors are kept open for 100% of the air-conditioning hours, open for 50% of the air-conditioning hours, and open for 10% of the air-conditioning hours of 8am to 6pm.
- 3 Window Opening**

It is also easy to find office buildings in Malaysia with windows kept open all the time. Three (3) scenarios were tested for this feature as well. This situation was tested by an open window area of 4.32m<sup>2</sup> per floor (representing 1.6% of the windows in the model), 2.16m<sup>2</sup> (representing 0.8% of the windows in the model) and 0m<sup>2</sup> (all windows closed). The open windows were distributed evenly to all four façades of the simulated model.
- 4 Weather-Strips (Seals) on Windows**

The requirement of good window seals was tested with five Crack Flow Coefficient scenarios of 1.1, 0.74, 0.39, 0.13 and 0.086. These Crack Flow Coefficients were obtained from a study made by an international organization called Air Infiltration and Ventilation Centre in 1994.

**TABLE 10.5 | CRACK FLOW COEFFICIENTS (l s<sup>-1</sup> m<sup>-1</sup> Pa<sup>-0.6</sup>)<sup>4</sup>**

Description	Lower Quartile	Median	Higher Quartile
<b>Windows (Weather-stripped)</b>			
Hinged	0.086	0.13	0.41
Sliding	0.079	0.15	0.21
<b>Windows (Non-weather-stripped)</b>			
Hinged	0.39	0.74	1.1
Sliding	0.18	0.23	0.37

<sup>3</sup> CK Tang, Nic Chin: Detailed Study and Report on the Current Building Designs and EE Building Applications. BSEEP, UNDP-JKR, 2012, p 12.

<sup>4</sup> An Analysis and Data Summary of the AIVC's Numerical Database. Technical Note AIVC 44, March 1994. Air Infiltration and Ventilation Centre.

The simulation cases were created from the worst case scenario into the best air-tight building scenario.

**BASE CASE WORST CASE SCENARIO**

**Ground Floor Main Entrance Door:** Modelled to be 4m width and 2.2m height. In the base case it was modelled to be fully open when the air-conditioning system is running from the hours of 8am to 6pm.

**Window Opening:** 1.6% of the windows were kept open on all four (4) façades on every floor in this model. 1.6% opening area in this model is equivalent to two (2) units of 1.8m x 1.2m sized windows per floor.

**Window Weather Stripping:** A Crack Flow Coefficient of 1.1 ( $l\ s^{-1}\ m^{-1}\ Pa^{-0.6}$ ) was applied to all the windows. 258m of window perimeter was modelled for a window area of 133m<sup>2</sup> per floor per orientation. A Crack Flow Coefficient of 1.1 represents the higher quartile of leakages for a non-weather-stripped hinged window.

**CASE 1  
GROUND ENTRANCE DOOR OPEN 50% OF THE AIR-CONDITIONING HOURS**

**Ground Floor Main Entrance Door:** Modelled to be 4m width and 2.2m height. In this case it was modelled to be open 50% of the hours when the air-conditioning system is running from 8am to 6pm.

**Window Opening:** 1.6% of the windows were kept open on all four (4) façades on every floor in this model. 1.6% opening area in this model is equivalent to two (2) units of 1.8m x 1.2m sized windows per floor.

**Window Weather Stripping:** A Crack Flow Coefficient of 1.1 ( $l\ s^{-1}\ m^{-1}\ Pa^{-0.6}$ ) was applied to all the windows. 258m of window perimeter was modelled for a window area of 133m<sup>2</sup> per floor per orientation. A Crack Flow Coefficient of 1.1 represents the higher quartile of leakages for a non-weather-stripped hinged window.

**CASE 2  
GROUND ENTRANCE DOOR OPEN 10% OF THE AIR-CONDITIONING HOURS**

**Ground Floor Main Entrance Door:** Modelled to be 4m width and 2.2m height. In this case it was modelled to be open 10% of the hours when the air-conditioning system is running from 8am to 6pm.

**Window Opening:** 1.6% of the windows were kept open on all four (4) façades on every floor in this model. 1.6% opening area in this model is equivalent to two (2) units of 1.8m x 1.2m sized windows per floor.

**Window Weather Stripping:** A Crack Flow Coefficient of 1.1 ( $l\ s^{-1}\ m^{-1}\ Pa^{-0.6}$ ) was applied to all the windows. 258m of window perimeter was modelled for a window area of 133m<sup>2</sup> per floor per orientation. A Crack Flow Coefficient of 1.1 represents the higher quartile of leakages for a non-weather-stripped hinged window.

**CASE 3  
WINDOW OPENING REDUCED TO 0.8% OF WINDOW AREA**

**Ground Floor Main Entrance Door:** Modelled to be 4m width and 2.2m height. In this case it was modelled to be open 10% of the hours when the air-conditioning system is running from 8am to 6pm.

**Window Opening:** 0.8% of the windows were kept open on all four (4) façades on every floor in this model. 0.8% opening area in this model is equivalent to one (1) unit of 1.8m x 1.2m sized window per floor.

**Window Weather Stripping:** A Crack Flow Coefficient of 1.1 ( $l\ s^{-1}\ m^{-1}\ Pa^{-0.6}$ ) was applied to all the windows. 258m of window perimeter was modelled for a window area of 133m<sup>2</sup> per floor per orientation. A Crack Flow Coefficient of 1.1 represents the higher quartile of leakages for a non-weather-stripped hinged window.

**CASE 4  
WINDOW OPENING REDUCED TO 0.0% OF WINDOW AREA**

**Ground Floor Main Entrance Door:** Modelled to be 4m width and 2.2m height. In this case it was modelled to be open 10% of the hours when the air-conditioning system is running from 8am to 6pm.

**Window Opening:** All windows are kept closed in this case.

**Window Weather Stripping:** A Crack Flow Coefficient of 1.1 ( $l\ s^{-1}\ m^{-1}\ Pa^{-0.6}$ ) was applied to all the windows. 258m of window perimeter was modelled for a window area of 133m<sup>2</sup> per floor per orientation. A Crack Flow Coefficient of 1.1 represents the higher quartile of leakages for a non-weather-stripped hinged window.

**CASE 5**  
**WINDOW WEATHER STRIPPING WITH CRACK FLOW COEFFICIENT OF 0.74**  
 ( $l\ s^{-1}\ m^{-1}\ Pa^{-0.6}$ )

**Ground Floor Main Entrance Door:**

Modelled to be 4m width and 2.2m height. In this case it was modelled to be open 10% of the hours when the air-conditioning system is running from 8am to 6pm.

**Window Opening:**

All windows are kept closed in this case.

**Window Weather Stripping:** A Crack Flow Coefficient of 0.74 ( $l\ s^{-1}\ m^{-1}\ Pa^{-0.6}$ ) was applied to all the windows. 258m of window perimeter was modelled for a window area of 133m<sup>2</sup> per floor per orientation. A Crack Flow Coefficient of 0.74 represents the median of leakages for a non-weather-stripped hinged window.

**CASE 6**  
**WINDOW WEATHER STRIPPING WITH CRACK FLOW COEFFICIENT OF 0.39**  
 ( $l\ s^{-1}\ m^{-1}\ Pa^{-0.6}$ )

**Ground Floor Main Entrance Door:**

Modelled to be 4m width and 2.2m height. In this case it was modelled to be open 10% of the hours when the air-conditioning system is running from 8am to 6pm.

**Window Opening:**

All windows are kept closed in this case.

**Window Weather Stripping:** A Crack Flow Coefficient of 0.39 ( $l\ s^{-1}\ m^{-1}\ Pa^{-0.6}$ ) was applied to all the windows. 258m of window perimeter was modelled for a window area of 133m<sup>2</sup> per floor per orientation. A Crack Flow Coefficient of 0.39 represents the lower quartile of leakages for a non-weather-stripped hinged window.

**CASE 7**  
**WINDOW WEATHER STRIPPING WITH CRACK FLOW COEFFICIENT OF 0.13**  
 ( $l\ s^{-1}\ m^{-1}\ Pa^{-0.6}$ )

**Ground Floor Main Entrance Door:**

Modelled to be 4m width and 2.2m height. In this case it was modelled to be open 10% of the hours when the air-conditioning system is running from 8am to 6pm.

**Window Opening:**

All windows are kept closed in this case.

**Window Weather Stripping:** A Crack Flow Coefficient of 0.13 ( $l\ s^{-1}\ m^{-1}\ Pa^{-0.6}$ ) was applied to all the windows. 258m of window perimeter was modelled for a window area of 133m<sup>2</sup> per floor per orientation. A Crack Flow Coefficient of 0.13 represents the median of leakages for a weather-stripped hinged window. This is a well-sealed, moderately air-tight window frame.

**CASE 8**  
**WINDOW WEATHER STRIPPING WITH CRACK FLOW COEFFICIENT OF 0.086**  
 ( $l\ s^{-1}\ m^{-1}\ Pa^{-0.6}$ )

**Ground Floor Main Entrance Door:**

Modelled to be 4m width and 2.2m height. In this case it was modelled to be open 10% of the hours when the air-conditioning system is running from 8am to 6pm.

**Window Opening:**

All windows are kept closed in this case.

**Window Weather Stripping:** A Crack Flow Coefficient of 0.086 ( $l\ s^{-1}\ m^{-1}\ Pa^{-0.6}$ ) was applied to all the windows. 258m of window perimeter was modelled for a window area of 133m<sup>2</sup> per floor per orientation. A Crack Flow Coefficient of 0.086 represents the lower quartile of leakages for a weather-stripped hinged window. This is a well-sealed, very air-tight window frame.

# INFILTRATION CONTROL

The objectives regarding air-infiltration therefore are:

- To keep the air-infiltration through the façades and roof as low as possible
- To minimise air entry at doors and windows separating non-air-conditioned and air-conditioned zones

In order to achieve the required air-tightness of the overall building, it is especially important that the curtain walls and external doors and windows are air-tight. The above-mentioned objectives are therefore sought to be achieved by:

- Setting an upper limit of the building air-infiltration
- Prescriptive requirements for doors and windows separating non-air-conditioned and air-conditioned zones
- Performing on-site air-infiltration tests on the façade, external doors and windows for the entire building
- Providing examples of air-tight building construction methods and materials

Please note that the biggest air-infiltration often occurs where the curtain wall, door and window systems join the walls/floors/ceilings. In addition, infiltration has also been found to occur in areas such as utility shafts and false ceilings that penetrate air-conditioned and non-air-conditioned zones.

## INFILTRATION LIMITS

From the result of this study, it is proposed that targeting an infiltration rate of  $0.13 \text{ (l s}^{-1} \text{ m}^{-1} \text{ Pa}^{-0.6})$ , which represents the median of leakages for a weather-stripped hinged window will provide the quickest return on investment. Improving the infiltration rate of the window frame further down to  $0.086 \text{ (l s}^{-1} \text{ m}^{-1} \text{ Pa}^{-0.6})$  only yielded a marginal savings increment. This indicates that due to the average low wind speed of this climate zone, it is not necessary to provide extremely air-tight window frames.

## PRESCRIPTIVE REQUIREMENTS FOR DOORS SEPARATING NON-AIR-CONDITIONED AND AIR-CONDITIONED ZONES

The doors separating non-air-conditioned and air-conditioned zones such as toilet doors, fire escape staircase doors, main entrance doors should be provided with adequate weather sealing to minimise infiltration through the door frames. In addition, self-closing mechanisms and signage explaining why these doors should be kept closed is highly recommended to be implemented.

The windows separating non-air-conditioned and air-conditioned zones such as external windows in rooms and public areas should be weather-stripped accordingly.

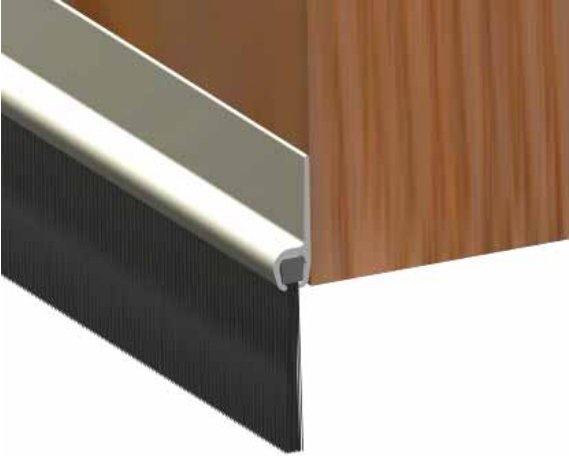
In order to minimise the air-infiltration through the above-mentioned doors and windows the following prescriptive requirements apply:

- The doors and windows must be fitted with air-tight seals around the four edges
- The bottoms of the doors are to be fitted with brush seals instead of rubber seals which pick up dirt easily. This is also to avoid damaging the floors when the doors are opened and closed (if rubber seals are used)
- The doors must be equipped with a door pump (door closer), so that they close automatically
- The cracks between frames and walls/floors/ceilings must be properly sealed
- To place signage on all doors and windows that are used by the occupants as an advisory to keep these doors and windows closed for energy efficiency

The biggest air-infiltration often occurs where the curtain wall, door and window systems join the walls/floors/ceilings

## EXAMPLES OF WINDOW AND DOOR SEAL INSTALLATION

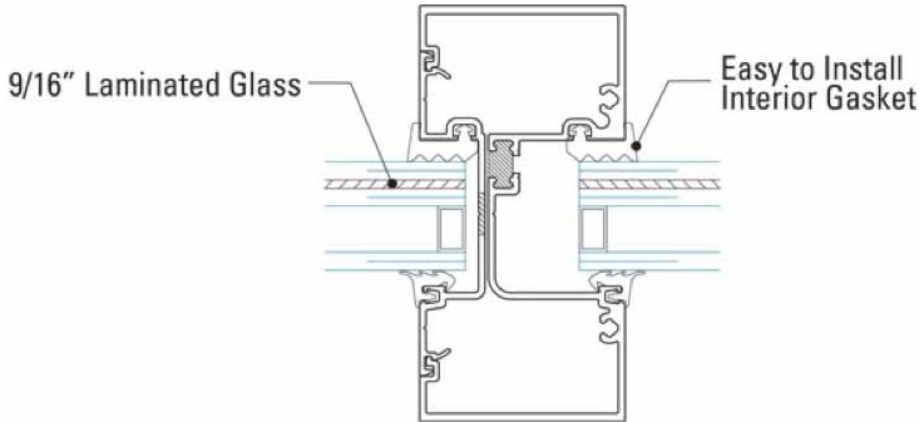
### SAMPLE BOTTOM DOOR SEAL



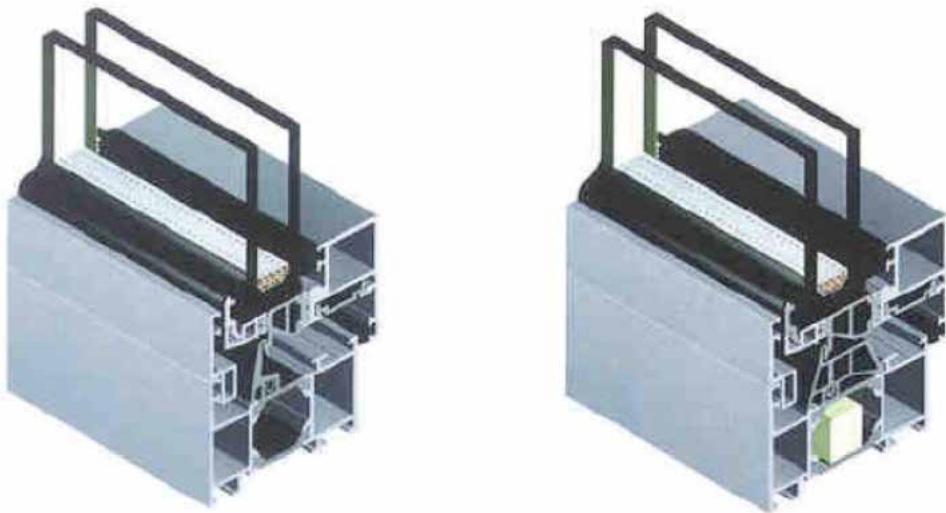
### SAMPLE TYPICAL DOOR SEAL



TYPICAL WINDOW SEAL



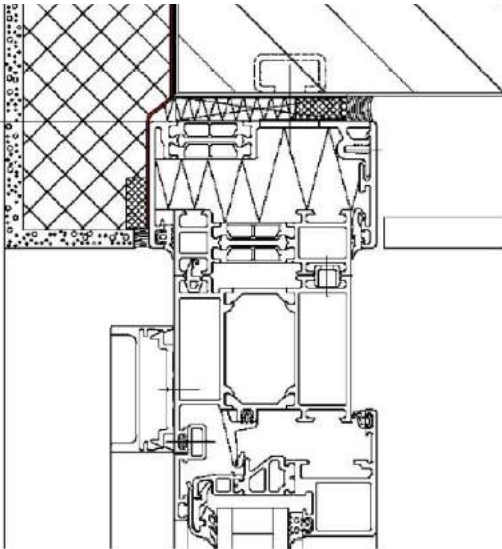
TYPICAL AIR-TIGHT WINDOW FRAME



The picture shows two frame constructions (Royal TS 70FF and Royal TS 75FF) which are both thermally insulated, rain proof and have an air tightness class 4, i.e. the tightest construction type available.

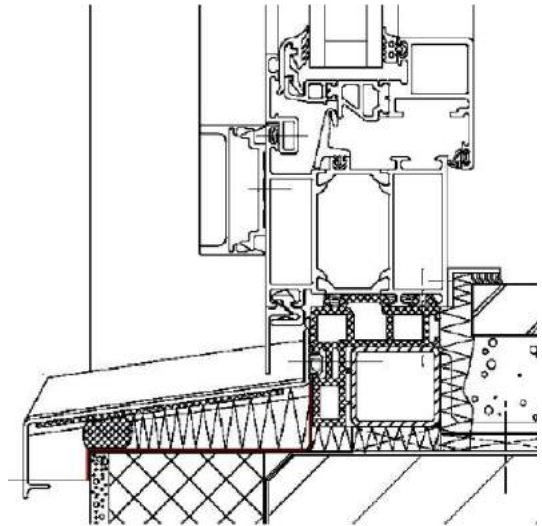
Image Source: Report on Construction Details for Airtight Building Envelope - ZEO Building, Kuala Lumpur  
© Prof. Dr. Ing. Lechner - University of Applied Sciences - FH Kaiserslautern, Germany

**CONNECTION BETWEEN WINDOW FRAME AND WALL**



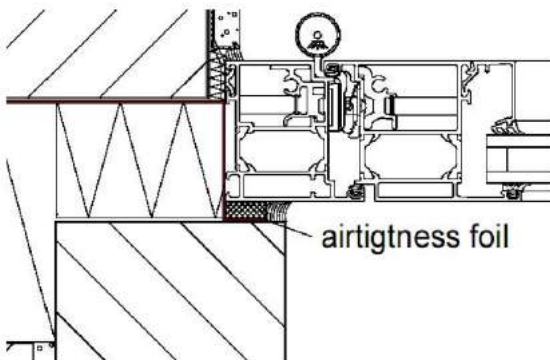
The air-tightness foil is marked in red in the section cut

**CONNECTION BETWEEN WINDOW SILL AND WALL**

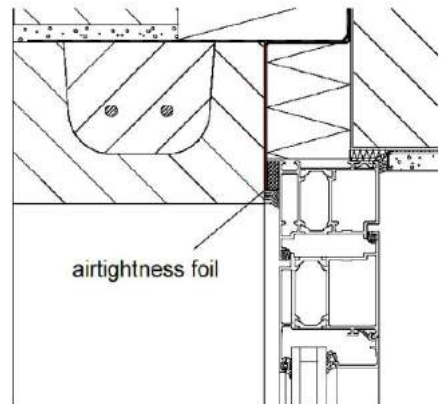


The air-tightness foil is marked in red in the section cut

**CONNECTION BETWEEN DOOR AND WALL**



Horizontal section (aluminium door), thermally separated, with air-tightness foil



Vertical section (aluminium door), thermally separated, with air-tightness foil

Image Source: Report on Construction Details for Airtight Building Envelope - ZEO Building, Kuala Lumpur © Prof. Dr. Ing. Lechner - University of Applied Sciences - FH Kaiserslautern, Germany

## SUMMARY

Placing 24-hour air-conditioned spaces with the external façade area will increase building energy consumption. Basically, this study indicates that 24-hour air-conditioned spaces in an office building are best located away from the external windows. Finally, it was also shown that it is possible to maintain a similar efficiency in the building when the external windows of 24-hour air-conditioned spaces are made opaque.

It was also shown in this chapter that infiltration (leakages of outdoor air) into a building is a major source of energy wastage. The simulation study conducted showed that by just ensuring all the windows are kept closed instead of having 1.6% of the windows open can yield close to 10% in total building energy savings. Further energy savings can then be obtained by ensuring that doors are kept closed between air-conditioned and non-air-conditioned spaces. Finally, the energy saved per meter run of window/door perimeter is provided in this chapter for the air-tightness ratings achieved on the window/door frames.

---

**END OF CHAPTER 10**

---



CHAPTER

# 11

## INTERIOR LAYOUT OF OFFICES





## 11

# INTERIOR LAYOUT OF OFFICES

## INTRODUCTION

The interior layout of office spaces influence the energy efficiency in buildings predominantly by maximising the benefits of daylight harvesting. In short, for buildings where daylight harvesting is practiced, the interior design of the office layout will have a significant impact on the energy consumption of the building. For buildings that do not practice daylight harvesting, the interior layout of the office space will have almost no influence in terms of energy efficiency.

Since daylight harvesting is one of the significant contributors to energy efficiency in buildings in the tropical climate, it is important that the interior layout is designed to complement the daylight harvested in the building.

In general the interior layout design in daylight harvested spaces should consider the following:

- ❶ **Rooms or spaces that rarely require lighting should be located away from daylight spaces**
- ❷ **Glare prevention should be given a priority to ensure that daylight can be harvested comfortably (refer to Chapter 4 for details)**

Individual rooms in offices are normally allocated to higher-ranking (senior) staff. These higher-ranked staff are typically busy people that attend a lot of meetings and conferences, spending much of their time outside of their own office room. Ironically, it is also common to allocate the best daylight office spaces to higher-ranking staff. This type of interior layout will then cause daylight to be provided to unoccupied rooms, while at the same time electrical lights are switched on for all open space offices that are typically located away from daylight spaces.

An energy efficient design alternative is to switch the position of open space offices with the individual offices. This will then ensure that daylight is provided to predominantly occupied open space offices, while individual offices will have its electrical lights switched off when it not in use. This strategy will reduce electrical lighting and air-conditioning energy consumption in the office building. It should also be noted that it is still possible to provide views to the outside from the individual offices by ensuring that the internal partitions have windows to look out.

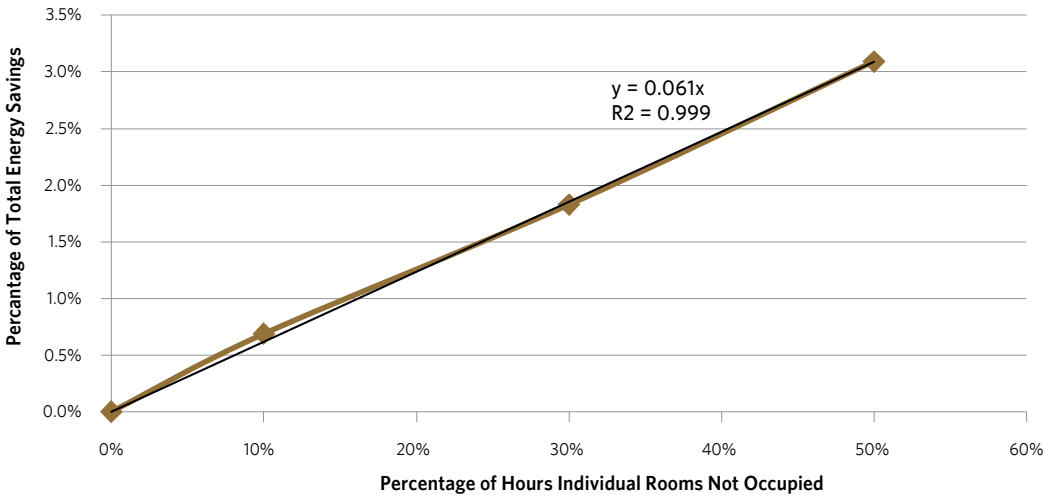
The energy impact from such an interior layout design strategy has not been documented for the Malaysian climate zone, but this chapter will attempt to provide an estimate on energy savings due to the implementation of such a strategy.

# KEY RECOMMENDATIONS

The key objective is to allow as many electrical lights as possible to be switched off for the longest possible time while maintaining the visual comfort in the office space. It was found from this study model that a potential total energy reduction of up to 3% is possible by switching the position of open space offices to the façade to benefit from harvested daylight and using electrical lighting for individual offices, based on the assumption that the individual offices are not occupied 50% of the working hours.

Chart 11.1 shows that there is a linear correlation between the percentage of hours the individual offices are unoccupied and the amount of energy saved due to the switching of the location of individual offices into non-daylight spaces, while using the harvested daylight for the more occupied spaces.

**CHART 11.1 | TOTAL BUILDING ENERGY SAVED BY PLACING INDIVIDUAL ROOMS AWAY FROM FAÇADE, LEAVING THE OPEN SPACE OFFICES TO BENEFIT FROM HARVESTED DAYLIGHT SPACES**



## ESTIMATING ENERGY SAVED

It is fairly reasonable to estimate the energy saved using the factors shown in Table 11.1 on the next page based on the area of individual office spaces moved away from the daylight spaces. This table assumes that the entire individual office space was daylight in the original scenario. These individual office spaces were then moved away from the daylight spaces, allowing the daylight spaces to be allocated instead for open space offices where the building occupants are working at their desk almost every working hour of every working day.

**TABLE 11.1 | ENERGY AND RUNNING COST SAVINGS PER M<sup>2</sup> OF MOVED INDIVIDUAL OFFICES FROM DAYLIGHT SPACE TO NON-DAYLIGHT SPACE. THE DAYLIGHT SPACE IS THEN PROVIDED FOR BUILDING OCCUPANTS THAT REGULARLY OCCUPY THE SPACE. LIGHTING POWER DENSITY IN THIS MODEL WAS SIMULATED AT 15 W/M<sup>2</sup>.**

% of working hours individual offices will be empty	Saving kWh/m <sup>2</sup> per year of moved individual offices	RM Saved per year per m <sup>2</sup> of moved individual offices
50%	12.6	4.40
30%	7.4	2.60
10%	2.8	0.98

### CALCULATION EXAMPLE - USE OF TABLE 11.1

#### Base Design

Total Individual Office Spaces in Building: 3,000 m<sup>2</sup>. All occupying daylight spaces.

#### Revised Design

Total Individual Office Spaces in Building: 3,000 m<sup>2</sup>

Individual Offices moved away from daylight spaces: 2,000 m<sup>2</sup>

Individual offices remaining at daylight spaces: 1,000 m<sup>2</sup>

Estimated % of working hours individual office room is empty: 50%

Estimated cost of renovation to move individual offices away from daylight space and move open offices to daylight space: RM20,000

#### Calculations:

From Table 11.1, for 50% of working hours individual office room is empty: 12.6 kWh/m<sup>2</sup> per year

Area of moved individual offices: 2,000 m<sup>2</sup>

Energy Saved per year: 2,000 m<sup>2</sup> x 12.6 kWh/m<sup>2</sup> per year = 25,200 kWh/year

Electricity Tariff assumed to be RM0.35 per kWh.

Running Cost Savings per year: 25,200 kWh/year x 0.35 RM/kWh = RM8,820 per year

Estimated Cost of renovation: RM 20,000

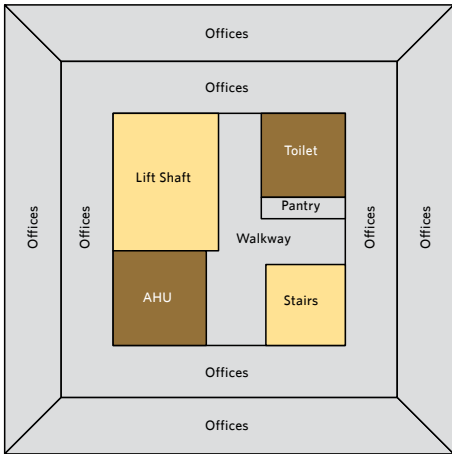
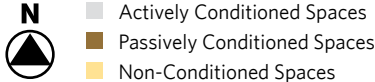
Simple Payback = RM20,000 / RM8,820 = 2.27 years

It should also be highlighted that this study also showed that if a senior staff individual office room size is 10m<sup>2</sup>, moving this office space away from the building façade saved only RM44 per year per staff or RM3.70 per month per senior staff.

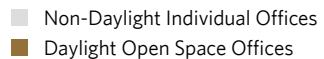
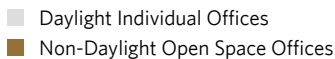
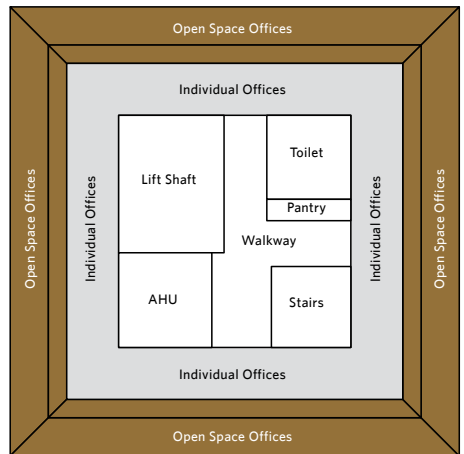
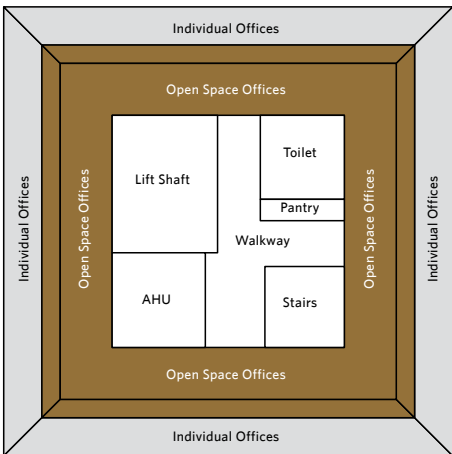
# SIMULATION MODEL

The standard center-cored, square box, 17 floor model of Case 1 from Chapter 3 was used as the case study for this chapter. All the data used is identical to Chapter 3 unless specifically mentioned in this chapter.

## CASE 1 - SQUARE BUILDING CENTER CORE



Individual office spaces of 3.7m depth from the façade were assumed. This assumption provided every floor an area of 650m<sup>2</sup> for individual offices, while the remaining 996m<sup>2</sup> was allocated as open space offices.



The assumption is that individual office spaces are usually allocated for higher-ranking office staff that are regularly out for meetings and will not spending 100% of the working hours in their own room, while the open office spaces are for lower ranking office staff that will be spending close to 100% of the working hours at their desk.

**The following scenarios were tested out:**

- Locating individual office spaces with external façade (taking up 3.7m depth from the façade) with full access to daylight harvesting
- Locating individual office spaces near the core without any access to daylight harvesting but may still have views to the outside by ensuring that windows are provided in partitions between office spaces
- Individual offices were modelled to be unoccupied 50%, 30% and 10% of the building occupancy hours
- Open space offices were modelled to be occupied 100% of the building occupancy hours

The assumption is that individual office spaces are usually allocated for high ranking office staff that are regularly out for meetings and will not spending 100% of the working hours in their own room

## CASE SCENARIOS

### Base Case

Individual office spaces located with external façade with full access to daylight harvesting. 50% of the building occupancy hours, these offices are empty and electrical lights will be switched off 50% of the time.

### Case ①

Individual office spaces located with external façade with full access to daylight harvesting. 30% of the building occupancy hours, these offices are empty and electrical lights will be switched off 30% of the time.

### Case ②

Individual office spaces located with external façade with full access to daylight harvesting. 10% of the building occupancy hours, these offices are empty and electrical lights will be switched off 10% of the time.

### Case ③

Individual office spaces located near the core of the building without any access to daylight harvesting. 50% of the building occupancy hours, these offices are empty and electrical lights will be switched off 50% of the time.

### Case ④

Individual office spaces located near the core of the building without any access to daylight harvesting. 30% of the building occupancy hours, these offices are empty and electrical lights will be switched off 30% of the time.

### Case ⑤

Individual office spaces located near the core of the building without any access to daylight harvesting. 10% of the building occupancy hours, these offices are empty and electrical lights will be switched off 10% of the time.

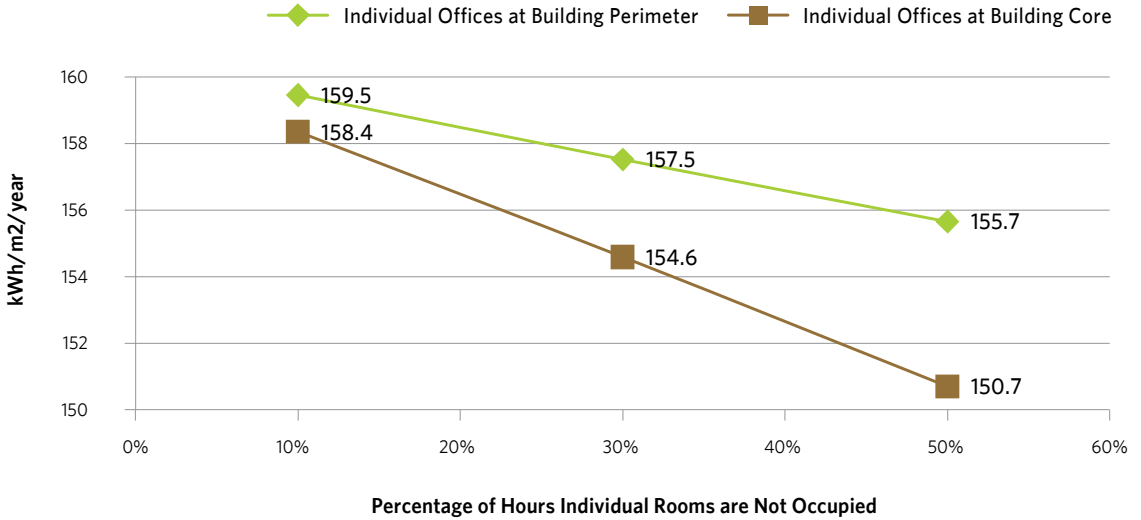
### Case ⑥

None of the building occupants leave their desk, therefore no electrical lights will be switched off during occupancy hours except during daylight harvesting.

# SIMULATION RESULTS

The results are shown in Chart 11.2 below.

**CHART 11.2 | BUILDING ENERGY INDEX OF VARIOUS CASE SCENARIOS**



The energy saved as a result of reduced hours of use of individual offices is clearly indicated in both cases of locating the individual offices at the building perimeter and the building core. These savings are the result of switching off electrical lights when the individual rooms are unoccupied. The simulation scenario included the switching off of electrical lights in the individual rooms when daylight was available.

However, for the same unoccupied hours of individual rooms, the energy reduction is higher in the cases where the individual offices are located at the core. This allows the daylight spaces be used by building occupants that are regularly at their desk and benefits from having the electrical lights switched off. This is an energy efficiency advantage over individual offices at the perimeter where the rooms may not be occupied but still use the harvested daylight.

**TABLE 11.2 | BEI OF SIMULATED CASES**

% hours individual offices are not occupied	BEI Individual Offices at Building Perimeter (kWh/m²/year)	BEI Individual Offices at Building Core (kWh/m²/year)	% difference
50%	155.7	150.7	3.2%
30%	157.5	154.6	1.9%
10%	159.5	158.4	0.7%

If the individual rooms are regularly unoccupied for less than 10% of the time, the potential total building energy savings provided by moving these rooms away from daylight spaces is low (0.7% or less). However, when these individual rooms are regularly unoccupied up to 50% of the working hours, the potential savings increased to 3.2%.



## SUMMARY

Most private (individual) office rooms are empty a significant part of the time because the people allocated the individual office rooms are normally higher-ranking office staff that are usually busy attending meetings. These meetings are normally carried out in a meeting room or outside the office building, away from their own individual office rooms. Individual office rooms located with access to harvested daylight are deemed as wasting an opportunity for energy saving because when the person is not in the room, light is not required in the first place. By locating individual office rooms away from daylight spaces and instead placing more permanent office staff in daylight spaces will enable energy to be saved in the building by having more electrical lights switched off when the individual rooms are empty.

This chapter shows that the energy saved by moving a building occupant with a individual office room away from the façade has the potential to save approximately RM4.40 per year per m<sup>2</sup> of office space, if the individual office room is empty 50% of the working hours. Assuming a typical individual office room size is 10m<sup>2</sup>, this would then provide an estimated energy saving of RM44 per year per person or RM3.70 per month per person. On an individual basis this saving may not worth the effort to have it implemented, however, in a large corporation with more than 1,000 private offices, this design option may possibly yield an energy saving of RM44,000 per year.

---

**END OF CHAPTER 11**

---

# GLOSSARY OF TERMS

<b>ACH</b>	Air Changes per Hour
<b>AHU</b>	Air Handling Unit
<b>BEI</b>	Building Energy Index
<b>BSEEP</b>	Building Sector Energy Efficiency Project
<b>CAV</b>	Constant Air Volume
<b>HVAC</b>	Heating, Ventilation and Air-Conditioning
<b>LSG</b>	Light-to-Solar Gain
<b>OTTV</b>	Overall Thermal Transmission Value
<b>PMV</b>	Predicted Mean Vote
<b>PPD</b>	Predicted Percentage Dissatisfied
<b>SC</b>	Shading Coefficient
<b>SHGC</b>	Solar Heat Gain Coefficient
<b>TRY</b>	Test Reference Year
<b>VAV</b>	Variable Air Volume
<b>VLT</b>	Visible Light Transmission
<b>WWR</b>	Wall to Window Ratio

## APPENDIX

Additional information and data for each of the chapters in this book is available on the BSEEP website:

<http://www.jkr.gov.my/bseep/>



