

# Window treatments



Different types of curtain arrangements serve both a functional and a visual purpose in your home. Visually they can enhance your style or change a room's proportions. Functionally, curtains and blinds block light, create privacy and absorb sound. They can also help to make your home cool or warm. Curtains and blinds also provide shade which protects furniture and creates a comfortable temperature for plants and animals. With layers of different types of curtains, you can transform your window into a cozy and constantly changing view. It's beauty with practical features. Let these solutions guide you to the everyday escape you want.

A high standard of accuracy has been sought in the preparation of this buying guide. We apologize for, but will not be bound by or responsible for, errors and omissions in this buying guide.

Not all products may be available in all stores. See what is available at your local store by visiting [IKEA-USA.com](http://IKEA-USA.com). For more detailed product information, see the price tag or visit [IKEA-USA.com](http://IKEA-USA.com). All products shown require assembly. All textiles shown are imported.



# GOOD TO KNOW

When it comes to windows, one size does not fit all. Windows are built in different ways. And we all have different needs regarding curtains. Part of the secret to creating truly beautiful, simple solutions in several layers is to measure your window properly.

## 1. Width of your window

It determines the width of your curtain rod or track rail. Add at least 6" on each side so that the curtains properly cover your window and can be opened completely. If you intend to set up blinds, you can either mount inside the window frame or over the window frame to block the light.

## 2. Length of your curtains

Measure from the upper part of the window frame and stop where you want the curtains to end. As a rule of thumb, add 6" to the size. Fit the curtain rod or track rail 6" above the window frame. Create a visual appearance that the ceilings are higher by mounting the curtain rod closer to the ceiling.

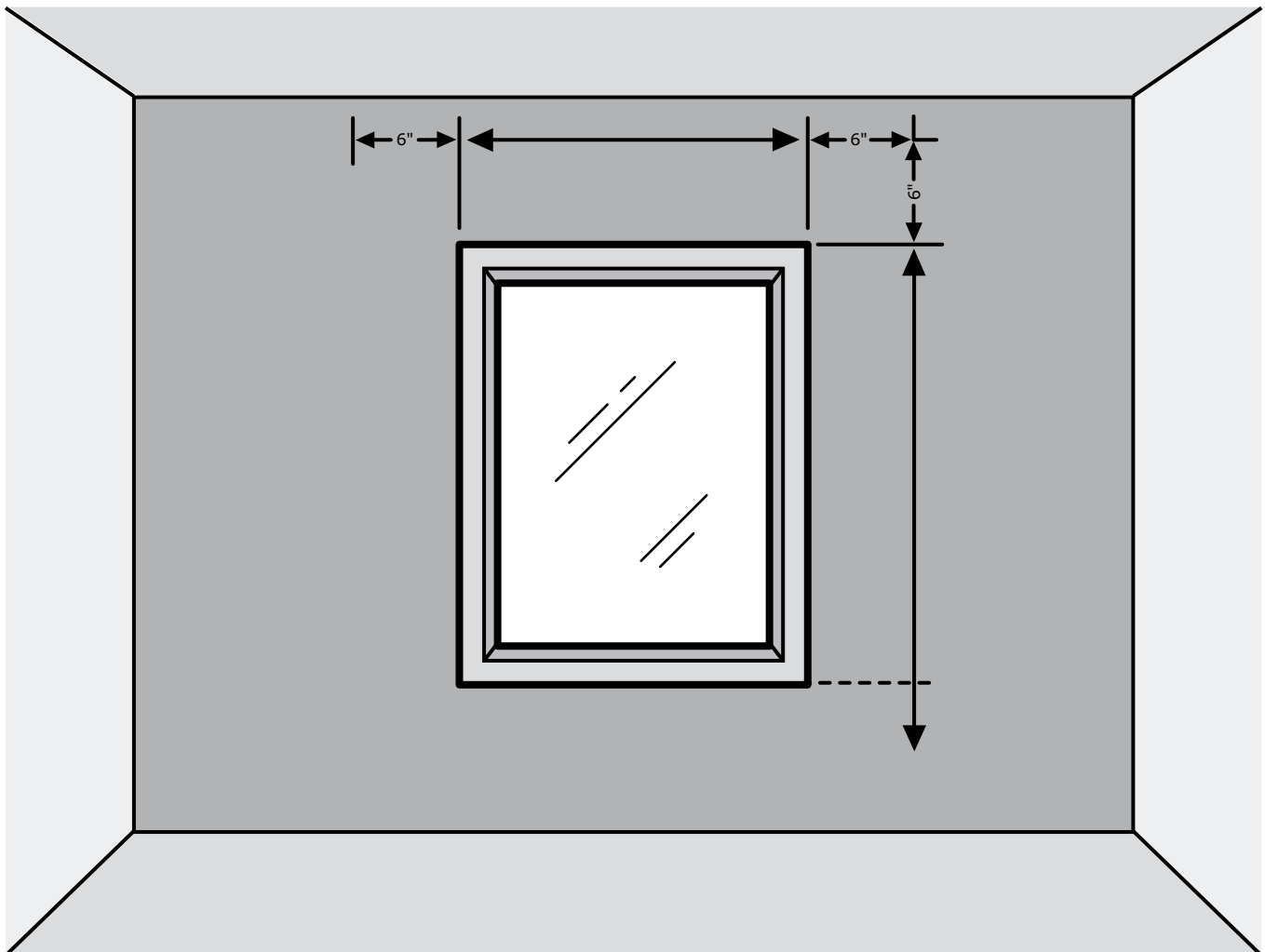

# PRIVACY

We love to see what's outside, but sometimes we want to shut out things like sunlight and curious eyes. With curtains and blinds you don't have to choose. They allow you to filter the

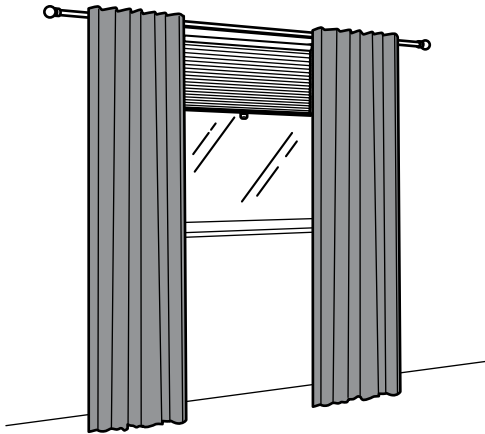

light, create privacy and reduce the glare on television and computer screens - while allowing you to enhance your style.

- The blind lowers the general light level and provides privacy by preventing people outside from seeing directly into the room.
- The honeycomb structure inside creates a layer of insulation which helps reduce heating costs.

### Parts used in this example

STORSLAGEN Curtain rod set, 47¼-82½", Black	602.686.42	1 pc
HOPPVALS Cellular blind, 34×64", Gray	803.864.42	1 pc
TIBAST Curtains, 1-pair, 57×98", Green	504.280.14	1 pc

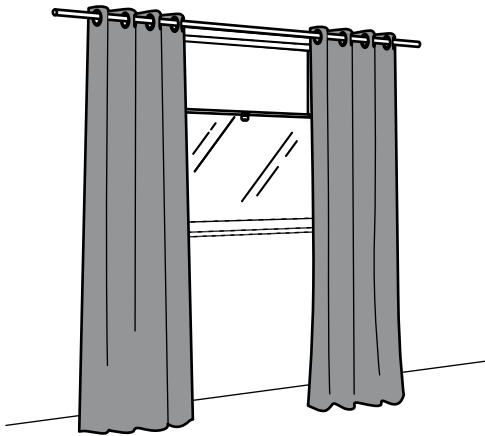

- The grommets allows you to hang the curtains directly on a curtain rod for easy gliding.
- Filters light and reduces reflections on TV and computer screens.
- The length of the curtain rod is adjustable.

### Parts used in this example

HUGAD Curtain rod, 47-83", White	102.171.41	1 pc
BETYDLIG Wall/ceiling bracket, White	302.198.89	2 pcs
RAFFIG Finial, 1-pair, White	502.171.82	1 pc
SKOGSKLÖVER Roller blind, 34×76¾", White	004.313.92	1 pc
MERETE Room darkening curtains, 1-pair, 57×98", Light brown-red	804.436.83	1 pc

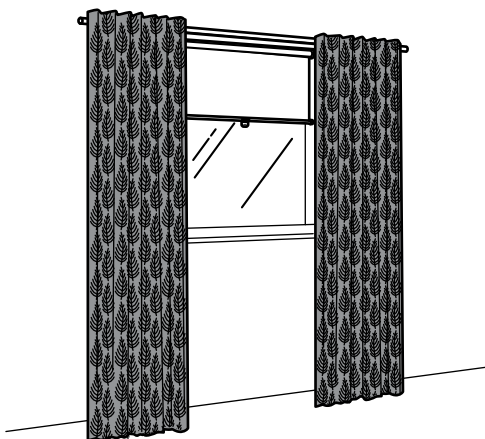

- The curtains block out the general light level and provide privacy by preventing people outside from seeing directly into the room.
- You can use the included connectors to extend the rail for a longer solution.

### Parts used in this example

VIDGA Single track rail, 55", White	702.991.53	1 pc
VIDGA Wall fitting, 4¾", White	702.991.48	2 pcs
VIDGA Glider with hook, White	702.607.68	1 pk
SKOGSKLÖVER Roller blind, 34×76¾", White	004.313.92	1 pc
ROSENMOTT Blackout curtains, 1-pair, 57×98", Black/floral patterned	904.630.05	1 pc

# SLEEP

We sleep one third of our lives, and a good night's sleep is important for us to feel well and rested. To make your choice

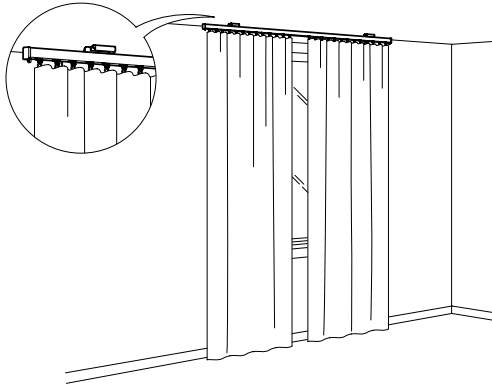

easier, we've gathered these combinations which can help you to reduce noise, block light and create a snug place to sleep.

- The room darkening blind has a special coating and does not let any light through.
- The curtain heading tape also has hidden tabs that allow you to hang the curtain directly on a curtain rod.
- You can easily change the expression of the curtain rod by changing to different finials from our range. The finials are sold separately.

### Parts used in this example

HUGAD Curtain rod, 47-83", Black	302.171.35	1 pc
BETYDLIG Wall/ceiling bracket, Black	602.172.28	2 pc
RAFFIG Finials, 1-pair, Black	202.199.36	1 pc
TRETUR Blackout roller blind, 38×76¾", Light gray	503.810.16	1 pc
VILBORG Curtains, 1-pair, 55×98", Beige	002.975.53	1 pc

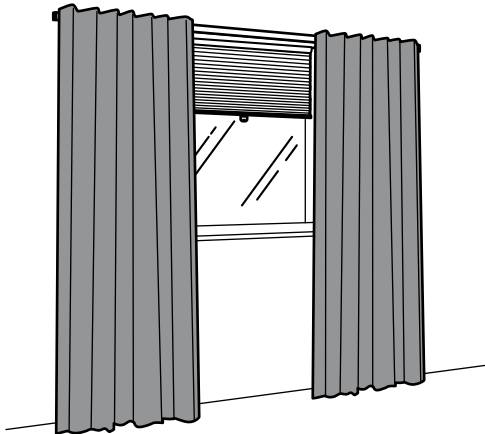

- The room darkening blind has a special coating and does not let any light through.
- May help you reduce heating costs as the air inside the honeycomb structure creates a layer of insulation.
- The rail can be cut to the desired length with a hacksaw.
- The ceiling fitting mounts VIDGA track rail to the ceiling with no visible screws.

### Parts used in this example

VIDGA Single track rail, 55", White	702.991.53	1 pc
VIDGA Ceiling fitting, White	902.990.91	2 pcs
VIDGA Glider with hook, White	702.607.68	1 pc
TRIPPEVALS Black-out cellular blind, 38×76¾", Light gray	204.450.05	1 pc
RITVA Curtains with tie-backs, 1-pair, Gray	301.564.86	1 pc

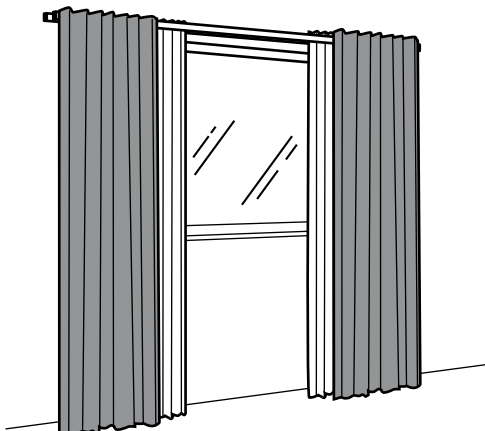

- With blackout curtains your sleep won't be disturbed by moonlight and street lights – or be woken by the sun when you want to sleep in late.
- The curtains can be used on a curtain rod or a curtain track.
- You can use the included connectors to extend the rail for a longer solution. The rail can also be cut to the desired length with a hacksaw.

### Parts used in this example

VIDGA Single track rail, 55", White	702.991.53	2 pcs
VIDGA Wall fitting, 4¾", White	702.991.48	3 pcs
VIDGA Glider with hook, White	702.607.68	2 pcs
MAJGULL Block-out curtains, 1-pair, 57×98", Dark-blue	703.410.34	1 pc
ANNALOUISA Curtains, 1-pair, 57×98", White	504.108.15	1 pc

\*Refer to VIDGA and RACKA/HUGAD/BETYDLIG buying guides for curtain rods and track system detail.

# MULTIFUNCTIONAL

During the day, the light changes and also the needs we have regarding our windows. With these solutions, you can block light or let it in, keep your room warm or cool, stop reflections

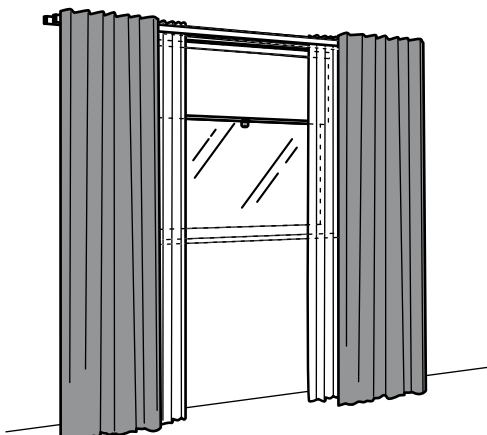
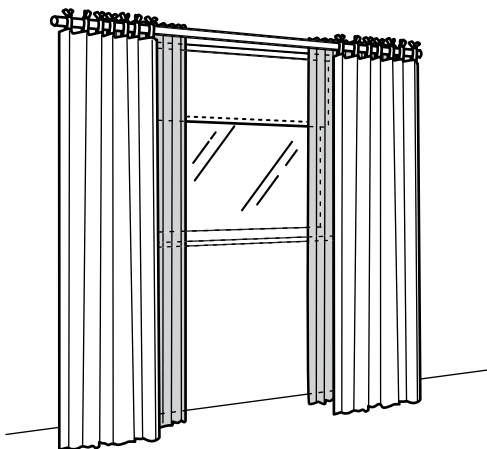
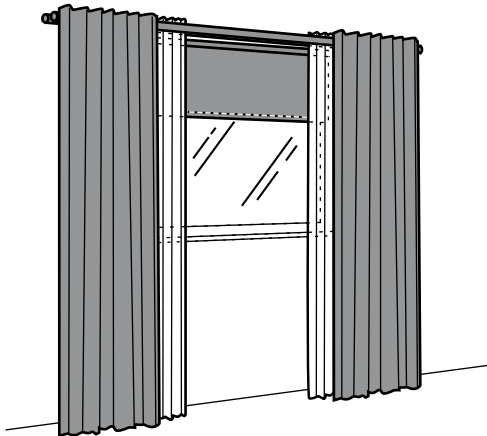

Complete your window solution with your own choice of curtains.

More curtains available in the store.

on screens, get both privacy and a view or just make your room more cozy. The different layers of textiles also provide you with insulation against the cold of winter and the heat of summer.

- With blackout curtains your sleep won't be disturbed by moonlight and street lights – or be woken by the sun when you want to sleep in late.
- The curtains can be used on a curtain rod or a curtain track.

### Parts used in this example

HUGAD Curtain rod, 47-83", Black	302.171.35	2 pcs
BETYDLIG Wall/ceiling bracket, Black	602.172.28	2 pc
BETYDLIG Curtain rod holder, Black	502.198.93	2 pcs
RAFFIG Finials, 1-pair, Black	202.199.36	1 pc
SKOGSKLÖVER Roller blind, 38×76¾", Gray	304.313.95	1 pc
MAJGULL Block-out curtains, 1-pair, 57×98", Dark-blue	703.410.34	1 pc
ANNALOUISA Curtains, 1-pair, 57×98", White	504.108.15	1 pc

- The curtains let the light through but provide privacy so they are perfect to use in a layered window solution.
- You can use the included connectors to extend the rail for a longer solution. The rail can also be cut to the desired length with a hacksaw.

### Parts used in this example

VIDGA Single track rail, 55", White	702.991.53	1 pcs
VIDGA Wall fitting, 4¾", White	702.991.48	2 pc
VIDGA Glider with hook, White	702.607.68	1 pk
VIDGA Curtain rod holder, White	403.050.75	2 pcs
HUGAD Curtain rod, 47-83", White	102.171.41	1 pc
RAFFIG Finials, 1-pair, White	502.171.82	1 pc
SKOGSKLÖVER Roller blind, 38×76¾", White	104.313.96	1 pc
MATILDA Sheer curtains, 1-pair, 55×98", White	101.119.84	1 pc

- With blackout curtains your sleep won't be disturbed by moonlight and street lights – or be woken by the sun when you want to sleep in late.
- The linen curtains let the light through but provide privacy so they are perfect to use in a layered window solution.
- You can use the included connectors to extend the rail for a longer solution. The rail can also be cut to the desired length with a hacksaw.

### Parts used in this example

VIDGA Single track rail, 55", White	702.991.53	2 pc
VIDGA Ceiling fitting, White	902.990.91	4 pcs
VIDGA Glider with hook, White	702.607.68	2 pk
SKOGSKLÖVER Roller blind, 38×76¾", White	104.313.96	1 pc
MAJGULL Blackout curtains, 1-pair, 57×98", Light gray	303.467.50	1 pc
DYTÅG Curtains, 1-pair, 57×98", White	004.667.15	1 pc

# VIDGA

VIDGA is the foundation of our range for windows and a good starting point for working with layered solutions that meet your needs and dreams. It's easy to install and has clean lines that fit both modern and traditional window solutions.

Explore all the possibilities when it comes to hanging your curtains with VIDGA curtain systems. Easy to use, buy and install.

## Single-layer

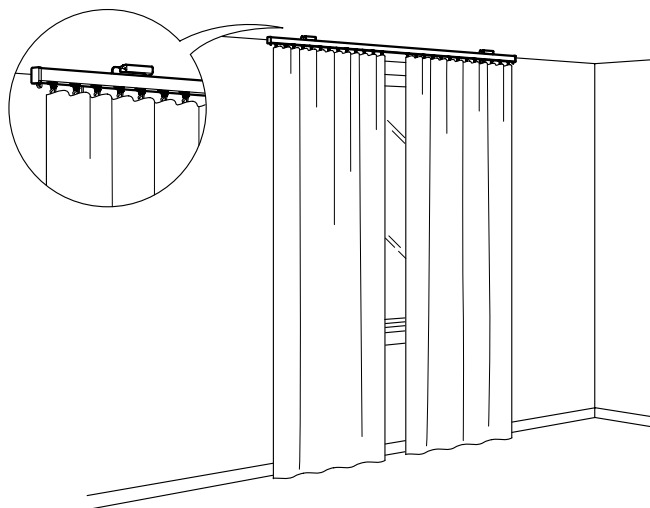

1. One VIDGA single track rail 55" mounted to the ceiling. The curtains are attached using VIDGA glider and hooks.

### Parts used in this example

VIDGA Ceiling bracket	902.990.91	<b>\$3/pc</b>	2 pcs
VIDGA Single track rail, 55"	702.991.53	<b>\$7/pc</b>	1 pc
VIDGA Glider/hooks, 24pk	702.607.68	<b>\$3/24pk</b>	1 pk

### This combination \$16

If you'd like to **double the width of the combination\***, follow the shopping list below:

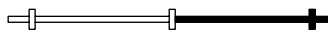

VIDGA Ceiling bracket	902.990.91	<b>\$3/pc</b>	3 pcs
VIDGA Single track rail, 55"	702.991.53	<b>\$7/pc</b>	2 pcs
VIDGA Glider/hooks, 24pk	702.607.68	<b>\$3/24pk</b>	2 pks

### This combination \$29

You can switch to short 2¼" or long 4¾" wall brackets for a wall-mounted solution.

## Double-layer

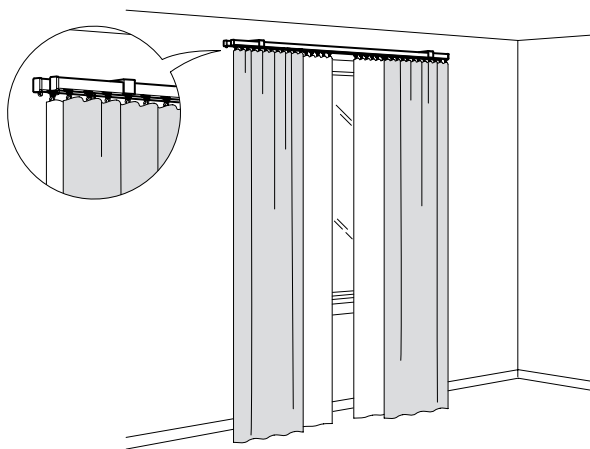

2. Two VIDGA single track rails, 55" each, mounted to the long wall brackets in parallel. By using two layers of curtains, you will have privacy day and night – close the sheer curtains in the day and the outer curtains for the night.

### Parts used in this example

VIDGA Wall bracket, 4¾"	702.991.48	<b>\$4/pc</b>	2 pcs
VIDGA Single track rail, 55"	702.991.53	<b>\$7/pc</b>	2 pcs
VIDGA Glider/hooks, 24pk	702.607.68	<b>\$3/24pk</b>	2 pks

### This combination \$28

If you'd like to **double the width of the combination\***, follow the shopping list below:



VIDGA Wall bracket, 4¾"	702.991.48	<b>\$4/pc</b>	3 pcs
VIDGA Single track rail, 55"	702.991.53	<b>\$7/pc</b>	4 pcs
VIDGA Glider/hooks, 24pk	702.607.68	<b>\$3/24pk</b>	4 pks

### This combination \$52

# VIDGA

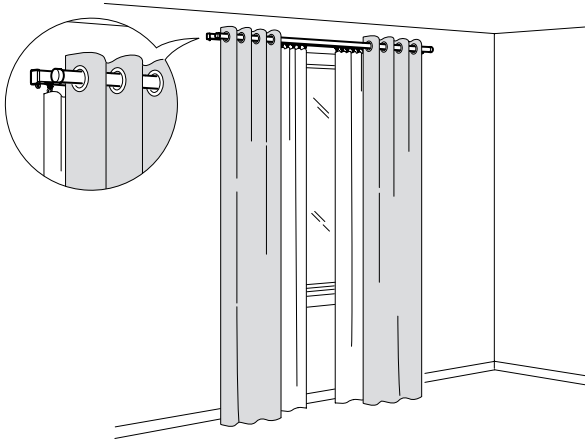

3. One VIDGA single track rail 55" mounted to the long wall brackets. Parallel to it, a HUGAD curtain rod is attached to it using VIDGA curtain rod holders. By using two layers of curtains, you will have privacy day and night – close the sheer curtains in the day and the outer curtains for the night. With a curtain rod, you can hang your curtains with grommets.

### Parts used in this example

VIDGA Wall bracket, 4¾"	702.991.48	<b>\$4/pc</b>	2 pcs
VIDGA Curtain rod holder	403.050.75	<b>\$3/pc</b>	2 pcs
HUGAD Curtain rod, 47-83"	102.171.41	<b>\$3.99/pc</b>	1 pc
VIDGA Single track rail, 55"	702.991.53	<b>\$7/pc</b>	1 pc
VIDGA Glider/hooks, 24pk	702.607.68	<b>\$3/24pk</b>	1 pk
RAFFIG Finial, 2pk	502.171.82	<b>\$2/2pk</b>	1 pk

### This combination \$30

If you'd like to **double the width of the combination\***, follow the shopping list below:



VIDGA Wall bracket, 4¾"	702.991.48	<b>\$4/pc</b>	3 pcs
VIDGA Curtain rod holder	403.050.75	<b>\$3/pc</b>	3 pcs
HUGAD Curtain rod, 83-152"	302.171.40	<b>\$5.99/pc</b>	1 pc
VIDGA Single track rail, 55"	702.991.53	<b>\$7/pc</b>	2 pcs
VIDGA Glider/hooks, 24pk	702.607.68	<b>\$3/24pk</b>	2 pks
RAFFIG Finial, 2pk	502.171.82	<b>\$2/2pk</b>	1 pk

### This combination \$49

## PARTS AND PRICES



<b>VIDGA Ceiling bracket</b>			
White	902.990.91	<b>\$3</b>	



<b>VIDGA Wall bracket</b>			
L2¼". White	102.991.51	<b>\$3</b>	

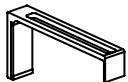

<b>VIDGA Wall bracket</b>			
L4¾". White	702.991.48	<b>\$4</b>	

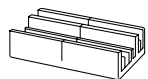

<b>VIDGA Miter box</b>			
W6¾"×H1½"	503.174.12	<b>\$3</b>	

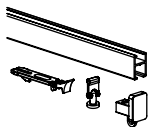

<b>VIDGA Single track rail</b>			
L55". White	702.991.53	<b>\$7</b>	

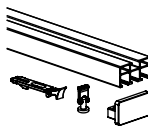

<b>VIDGA Triple track rail</b>			
L55". White	202.991.55	<b>\$15</b>	



<b>VIDGA Corner piece, single track</b>			
L4¾". White	402.990.98	<b>\$4</b>	



<b>VIDGA Panel curtain holder</b>			
L23½". White	802.991.57	<b>\$6</b>	



<b>VIDGA Draw rod</b>			
L43¾". White	002.991.18	<b>\$4</b>	



<b>VIDGA Gliders and hooks</b>			
White	702.607.68	<b>\$3/24pk</b>	



<b>RIKTIG Curtain hooks</b>			
	402.122.03	<b>\$3.99/20pk</b>	



<b>VIDGA Curtain rod holder</b> To be utilized when adding a HUGAD curtain rod.			
L2". White	403.050.75	<b>\$3</b>	

# WIRELESS MOTORIZED BLINDS

With our roller blind FYRTUR, you can control the light from your bed, or somewhere else. Thanks to the included remote control or the IKEA TRÅDFRI app, several wireless blinds can be controlled at the same time or individually.

It's convenient and great for all generations. Let them help you get just the right amount of light and set the best conditions for a good night's sleep, or gentle waking up!

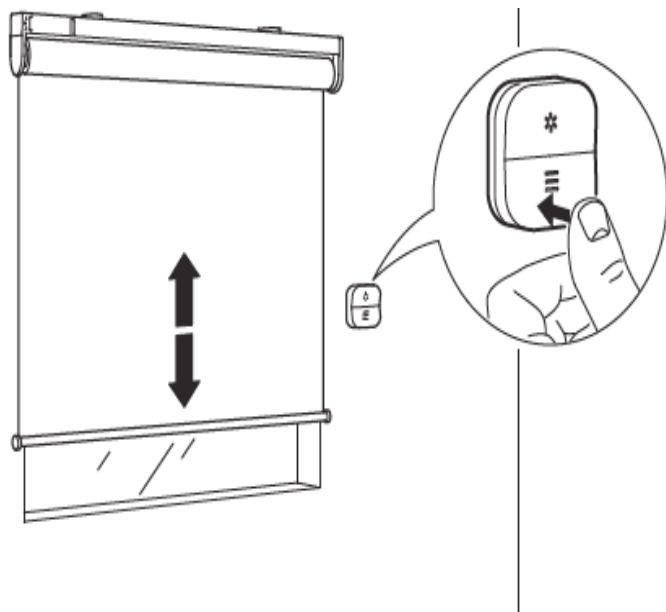

- You can control your blinds wirelessly to adapt the light or create privacy depending on the activity taking place in the room.
- You can use TRÅDFRI gateway and app to create several groups of wireless blinds and control them in different ways.
- When you add TRÅDFRI gateway and app, you can set your wireless blinds to go up and down with a timer.
- FYRTUR blocks light from shining through and completely darkens your room.

## Parts used in this example

FYRTUR Blackout roller blind, wireless/ battery operated, 30×76¾"	904.174.62	<b>\$149</b>
--	------------	--------------

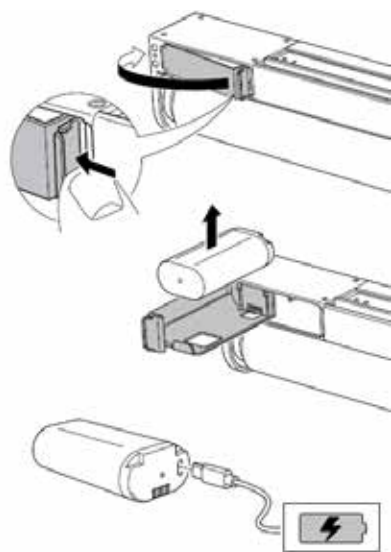

- Remote control included.
- One rechargeable battery included.
- Battery charger included.
- For the blinds wireless functions to work, the zigbee repeater (included in the package) needs to be plugged in to a power socket within 32 feet of the blind.
- The blind comes pre-paired with the remote control and the zigbee repeater.
- You need the TRÅDFRI gateway to use the TRÅDFRI app. Download the app for free via Google Play or App Store, depending on which mobile device you have.
- We continuously update the TRÅDFRI app with more functions and possibilities.
- BRAUNIT extra battery available.

## PARTS AND PRICES



**FYRTUR Motorized blackout roller blind** With blackout blinds you won't get your sleep disturbed by moonlight and street lights - or be woken by the sun when you want to sleep in late. Soft closing function. Can be mounted inside or outside the window frame, or on the ceiling. The blind is cordless for increased child safety.

Light gray		
23×76¾"	304.174.60	<b>\$129</b>
27×76¾"	104.174.61	<b>\$139</b>
30×76¾"	904.174.62	<b>\$149</b>
32×76¾"	704.174.63	<b>\$154</b>
34×76¾"	504.174.64	<b>\$159</b>
36×76¾"	204.174.65	<b>\$164</b>
38×76¾"	004.174.66	<b>\$169</b>
48×76¾"	504.174.59	<b>\$179</b>

## ADDITIONAL OPTIONS



**BRAUNIT Battery pack** Back-up power when you need it. Powerful and rechargeable, you always have a safe power supply close at hand for your products.

3×1¼×1"	104.497.54	<b>\$15</b>
---------	------------	-------------

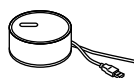

**TRÅDFRI Gateway** You can use the TRADRI gateway and IKEA Home Smart app to create several groups of wireless blinds and control them in different ways. You can also set them to go up and down with a timer.

White	003.378.13	<b>\$35</b>
-------	------------	-------------



# BLINDS

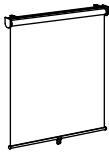

**SKOGSKLÖVER Roller blind** Filters the outside light and creates a comfortable feeling in the room. Soft closing function. Can be mounted inside or outside the window frame, or on the ceiling.

White		
23×76¾"	704.313.84	<b>\$19.99</b>
27×76¾"	204.313.86	<b>\$24.99</b>
30×76¾"	804.313.88	<b>\$27.99</b>
32×76¾"	404.313.90	<b>\$29.99</b>
34×76¾"	004.313.92	<b>\$32.99</b>
36×76¾"	604.313.94	<b>\$37.99</b>
38×76¾"	104.313.96	<b>\$42.99</b>
48×76¾"	104.313.82	<b>\$44.99</b>

Gray		
23×76¾"	904.313.83	<b>\$19.99</b>
27×76¾"	404.313.85	<b>\$24.99</b>
30×76¾"	004.313.87	<b>\$27.99</b>
32×76¾"	604.313.89	<b>\$29.99</b>
34×76¾"	204.313.91	<b>\$32.99</b>
36×76¾"	804.313.93	<b>\$37.99</b>
38×76¾"	304.313.95	<b>\$42.99</b>
48×76¾"	304.313.81	<b>\$44.99</b>

Green		
23×76¾"	304.537.97	<b>\$19.99</b>
27×76¾"	104.537.98	<b>\$24.99</b>
30×76¾"	904.537.99	<b>\$27.99</b>
32×76¾"	004.538.07	<b>\$29.99</b>
34×76¾"	504.538.00	<b>\$32.99</b>
36×76¾"	304.538.01	<b>\$37.99</b>
38×76¾"	604.538.09	<b>\$42.99</b>
48×76¾"	804.538.08	<b>\$44.99</b>



**BLEKING Roller blind** Filters the outside light and creates a comfortable feeling in the room. Can be mounted inside or outside the window frame, or on the ceiling.

Red-brown		
22×76¾"	704.598.82	<b>\$19.99</b>
26×76¾"	604.598.87	<b>\$24.99</b>
29×76¾"	804.598.86	<b>\$27.99</b>
31×76¾"	004.598.85	<b>\$29.99</b>
33×76¾"	304.598.84	<b>\$32.99</b>
35×76¾"	504.598.83	<b>\$37.99</b>
37×76¾"	404.598.88	<b>\$42.99</b>
47×76¾"	204.598.89	<b>\$44.99</b>

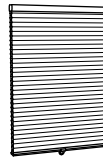

**HOPPVALS Cellular blind** The honeycomb structure inside creates a layer of insulation which helps reduce heating costs. Can be mounted inside or outside the window frame, or on the ceiling.

White		
23×64"	704.313.98	<b>\$19.99</b>
27×64"	504.313.99	<b>\$24.99</b>
30×64"	104.314.00	<b>\$27.99</b>
32×64"	904.314.01	<b>\$29.99</b>
34×64"	704.314.02	<b>\$32.99</b>
36×64"	504.314.03	<b>\$37.99</b>
38×64"	304.314.04	<b>\$42.99</b>
48×64"	904.313.97	<b>\$44.99</b>

Gray		
23×64"	303.864.30	<b>\$19.99</b>
27×64"	503.864.34	<b>\$24.99</b>
30×64"	003.864.36	<b>\$27.99</b>
32×64"	203.864.40	<b>\$29.99</b>
34×64"	803.864.42	<b>\$32.99</b>
36×64"	403.864.44	<b>\$37.99</b>
38×64"	903.864.46	<b>\$42.99</b>
48×64"	103.864.26	<b>\$44.99</b>

Blue		
23×64"	304.538.96	<b>\$19.99</b>
27×64"	104.538.97	<b>\$24.99</b>
30×64"	904.538.98	<b>\$27.99</b>
32×64"	704.538.99	<b>\$29.99</b>
34×64"	304.539.00	<b>\$32.99</b>
36×64"	004.539.11	<b>\$37.99</b>
38×64"	204.539.10	<b>\$42.99</b>
48×64"	504.538.95	<b>\$44.99</b>



**TRETUR Blackout roller blind** With block-out blinds you won't get your sleep disturbed by moonlight and street lights - or be woken by the sun when you want to sleep in late. Soft closing function. Can be mounted inside or outside the window frame, or on the ceiling. The blind is cordless for increased child safety.

Light gray		
23×76¾"	503.804.70	<b>\$39.99</b>
27×76¾"	403.804.75	<b>\$42.99</b>
30×76¾"	203.804.76	<b>\$44.99</b>
32×76¾"	603.804.79	<b>\$47.99</b>
34×76¾"	003.810.14	<b>\$49.99</b>
36×76¾"	703.810.15	<b>\$52.99</b>
38×76¾"	503.810.16	<b>\$54.99</b>
48×76¾"	803.804.64	<b>\$57.99</b>

Light blue		
23×76¾"	403.810.69	<b>\$39.99</b>
27×76¾"	403.810.74	<b>\$42.99</b>
30×76¾"	903.810.76	<b>\$44.99</b>
32×76¾"	903.810.81	<b>\$47.99</b>
34×76¾"	503.810.83	<b>\$49.99</b>
36×76¾"	803.810.86	<b>\$52.99</b>
38×76¾"	603.810.87	<b>\$54.99</b>
48×76¾"	503.810.64	<b>\$57.99</b>

# BLINDS

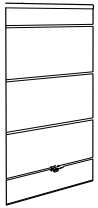

**RINGBLOMMA Roman blind** The length of the blind can be adjusted from 63" to 46½", 28¾" or 12¾". Can be used in all rooms and on all types of surfaces, even in damp areas such as bathrooms.

White		
34×63"	704.385.16	<b>\$24.99</b>
48×63"	904.385.15	<b>\$29.99</b>

White/blue		
34×63"	304.411.82	<b>\$24.99</b>
48×63"	704.411.80	<b>\$29.99</b>

Green		
34×63"	904.537.42	<b>\$24.99</b>
48×63"	804.537.33	<b>\$29.99</b>

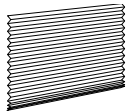

**SCHOTTIS Blackout pleated blind** Dark gray. Easy to attach to your window frame. No drilling needed. The blackout blind has a surface that blocks light from shining through. Can be easily cut to the desired size.

39¼×74¾"	104.313.77	<b>\$5.99</b>
----------	------------	---------------

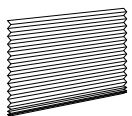

**SCHOTTIS Pleated shade** White. Easy to attach to your window frame. No drilling needed. Can be easily cut to the desired size.

35½×74¾"	904.313.78	<b>\$2.99</b>
----------	------------	---------------

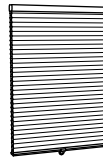

**TRIPPEVALS Blackout cellular blind** The honeycomb structure inside creates a layer of insulation which helps reduce heating costs. The room darkening blind has a special coating and does not let any light through. Can be mounted inside or outside the window frame, or on the ceiling.

Gray		
23×76¾"	004.450.06	<b>\$39.99</b>
27×76¾"	003.814.86	<b>\$42.99</b>
30×76¾"	203.814.85	<b>\$44.99</b>
32×76¾"	503.814.84	<b>\$47.99</b>
34×76¾"	903.814.82	<b>\$49.99</b>
36×76¾"	804.450.07	<b>\$52.99</b>
38×76¾"	204.450.05	<b>\$54.99</b>
48×76¾"	803.814.87	<b>\$57.99</b>



**RIKTIG Draw rod** Makes it easy to pull down or push up a cordless roller blind.

28¾-52¼"	303.162.96	<b>\$3.99</b>
----------	------------	---------------

# CURTAIN RODS AND SYSTEMS

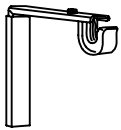

**BETYDLIG Wall/ceiling bracket** Max load 22 lbs.

Black	602.172.28	<b>\$1</b>
Silver-color	102.198.90	<b>\$1</b>
White	302.198.89	<b>\$1</b>



**BETYDLIG Curtain rod holder** L2¾".

Needed for a double or triple curtain rod solution.

Black	502.198.93	<b>50¢</b>
Silver-color	002.198.95	<b>50¢</b>
White	602.198.97	<b>50¢</b>



**RÄCKA Curtain rod** L28-47, Ø¾". Max load 11 lbs.

Black	002.171.65	<b>\$1.99</b>
Silver-color	002.213.94	<b>\$1.99</b>
White	702.213.95	<b>\$1.99</b>



**RÄCKA Curtain rod** L47-83, Ø¾". To be completed with BETYDLIG wall/ceiling brackets. Two brackets needed for lengths up to 55" and three brackets for lengths 55-83". Max load 11 lbs.

Black	302.171.59	<b>\$2.99</b>
Silver-color	102.171.60	<b>\$2.99</b>
White	902.171.61	<b>\$2.99</b>



**RÄCKA Curtain rod** L83-152, Ø¾". To be completed with BETYDLIG wall/ceiling brackets. Three brackets needed for lengths up to 110" and four brackets for lengths 110-152". Max load 11 lbs.

Black	702.171.57	<b>\$4.99</b>
Silver-color	702.171.62	<b>\$4.99</b>
White	402.171.49	<b>\$4.99</b>



**HUGAD Curtain rod** L47-83, Ø1½". To be completed with BETYDLIG wall/ceiling brackets. Two brackets needed for lengths up to 55" and three brackets for lengths 55-83". Max load 22 lbs.

Black	302.171.35	<b>\$3.99</b>
Silver-color	902.171.37	<b>\$3.99</b>
White	102.171.41	<b>\$3.99</b>



**HUGAD Curtain rod** L83-152, Ø1½". To be completed with BETYDLIG wall/ceiling brackets. Three brackets needed for lengths up to 110" and four brackets for lengths 110-152". Max load 22 lbs.

Black	502.171.39	<b>\$5.99</b>
Silver-color	702.171.38	<b>\$5.99</b>
White	302.171.40	<b>\$5.99</b>



**RAFFIG Finials** L1".

Black	202.199.36	<b>\$2/2pk</b>
Silver-color	002.199.37	<b>\$2/2pk</b>
White	502.171.82	<b>\$2/2pk</b>

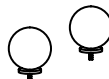

**VÄSENTLIG Finials** L2½".

White	002.171.94	<b>\$5/2pk</b>
-------	------------	----------------



**FÖRRÄTT Finials** L1¾".

White	003.005.98	<b>\$8/2pk</b>
-------	------------	----------------

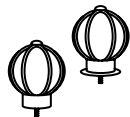

**BLÅST Finials**

Black	402.172.48	<b>\$10/2pk</b>
White/glass	303.331.87	<b>\$10/2pk</b>



**SYRLIG Curtain rings with clip and hook** Max load 7 lbs. Ø1". To be paired with RÄCKA curtain rods.

Black	102.172.40	<b>\$3.99/10pk</b>
Silver-color	202.172.25	<b>\$3.99/10pk</b>
White	402.240.98	<b>\$3.99/10pk</b>
Nickel plated	103.057.98	<b>\$3.99/10pk</b>

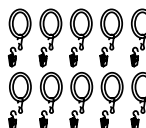

**SYRLIG Curtain rings with clip and hook** Max load 7 lbs. Ø1½". To be paired with HUGAD curtain rod.

Black	802.240.96	<b>\$4.99/10pk</b>
Silver-color	502.199.54	<b>\$4.99/10pk</b>
White	502.172.38	<b>\$4.99/10pk</b>

# SAFETY

## **How safe are your windows?**

The truth is that the area around your window can be a threat, especially for young children. Did you know that blinds and curtains with hanging strings are actually a strangulation risk for children?

For us, children are the most important people in the world, so we work hard to make homes safer. For us, it's not enough to minimize the risk. We want to remove it completely. So we decided to change our range of blinds and curtains by developing alternative solutions that completely eliminate the risk of strangulation.

To prevent children from getting stuck in loose strings, we've removed the drawstring from all of our blinds. They are still easy to roll up and pull down – just grab the plastic tab in the middle and pull. For high windows, you easily complete with RIKTIG draw rod. The blinds can be adjusted to any height.

And our curtains have no drawstring, which means children stay safe around them.

# SERVICES

IKEA products are designed to be taken home and assembled by you. That way, you'll save the most money. But if you would like some help, we can offer a range of services. Assembly and delivery services fulfilled by an Independent Service Provider. Contact your local IKEA store or visit the IKEA website for details: [IKEA-USA.com/services](https://www.IKEA-USA.com/services)

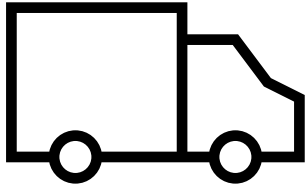

## DELIVERY SERVICE

Most of our products are designed and packaged so that you can take them home yourself. If you prefer, we can arrange for delivery of your purchases directly to your home or business. Same day, next day or same week deliveries are available. We can also arrange for delivery at a later date if you would like.

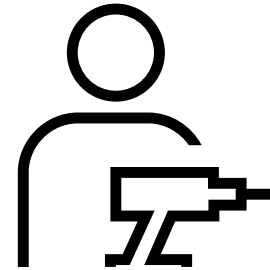

## ASSEMBLY SERVICE

For online and in-store purchases, TaskRabbit offers quick and convenient assembly and mounting for your IKEA purchases made online and in select stores.

## PICKING WITH DELIVERY SERVICE

We'll collect the products on your shopping list from throughout the store and deliver everything to your home or office. See an IKEA co-worker and tell them what you're looking for and they will book and print your items on a customer order. Take this order to the check-outs and pay for your purchases of both goods and services. And you're on your way!

Services and prices may vary, please see [IKEA-USA.com/services](https://www.IKEA-USA.com/services) or talk to us in your local IKEA store.