

B U Z Z

S E A T I N G A T I T S B E S T

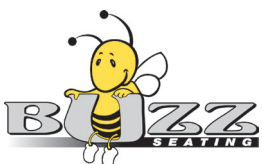

PRICE LIST

US EDITION

JULY 2022

Have you
heard the
Buzz?.....www.buzzseating.com



INDEX

SIDE CHAIRS

Flite.....	5
Start.....	6
Jem.....	7
Caboodle.....	12
Melo Side.....	22

SPECIALITY STOOLS/URETHANE

Jem.....	7
Polyurethane.....	17
General Purpose.....	18
Medical.....	18
Dental.....	19
Pronto Sit Stand.....	37

EXECUTIVE TASK

Leather On Demand.....	14
Bailey.....	16
Rika.....	26

MESH BACK TASK

Dandy.....	20
Nifty.....	21
Melo Task.....	23
Rika.....	26
Pronto Mesh Heavy Duty.....	36

PRONTO SERIES

Sit/Stand.....	37
Bantam.....	38
Petite.....	42
Mid Back.....	46
High Back.....	50
24/7 Heavy Duty.....	54

HEAVY DUTY TASK

Big & Tall.....	32
Shield.....	34
Pronto 24/7.....	54

SMALL FOOT PRINT TASK

Snap.....	29
Dandy.....	20

MISCELLANEOUS PARTS/ACCESSORIES

Arm Options.....	58
Caster Options.....	58
Arm Pad Options.....	59
Accessories.....	59
Parts List.....	60

STOOLS

Nifty.....	21
Melo Task.....	24
Rika.....	26
Snap.....	29
Pronto Mesh Heavy Duty.....	36
Pronto.....	42



BUSINESS DONE RIGHT!

Prices

All prices are suggested manufacturer's list and are subject to change without notice. Prices in effect at the time of the order acceptance shall apply.

Shipping Cartons/Blanket Wrap

All products are delivered in a box and assembly may be required. Blanket wrapped shipments can be prearranged with Customer Service for full truckload quantities only. Additional fees may apply.

Freight Terms & Claims

All shipments are subject to the standard freight program which requires a minimum of twelve (12) chairs for free freight in the contiguous 48 United States. Prepaid freight is based upon standard ground shipments. Shipping charges may apply for any special delivery requests such as inside or residential delivery or liftgate service. A \$40 charge applies for all "Call Before Delivery" requests. Buzz Seating reserves the right to determine the most economical shipment method and is not responsible for delays that may occur during transit. If any delivered product arrives damaged or missing parts, Buzz Seating must be notified within fourteen (14) calendar days of receipt of product. Purchaser waives any right to claim damage or missing parts and incurred charges will be the responsibility of the receiver for claims received after fourteen (14) calendar days.

Product Design

Buzz Seating reserves the right to make changes in design or material to discontinue products and/or change components at its discretion. Chair dimensions are often interpreted differently depending upon the manner in which measured. Actual dimensions can vary slightly depending on model and options selected.

To Order

Specify model number and all other applicable information on a purchase order. Orders will be immediately acknowledged identifying the products ordered, price and scheduled ship date. Customers are responsible to review order acknowledgments for accuracy. Please note that verbal orders cannot be accepted.

Changes and Cancellations

Orders that have entered any stage of production cannot be canceled without penalty. Order changes must be in writing and, upon review, a decision will be made if the change can be accepted and/or calculation of applicable or additional costs or fees due to change(s).

Returns

Authorization for return must be requested and approved by Buzz Seating prior to the return of the product. Returns are subject to a 35% restocking charge of the net sale and applicable shipping costs. Unauthorized returns will not be accepted.

Shipping Terms

Orders are shipped as soon as possible or as requested by the purchaser. Factors such as quantity or fabric selection can affect shipping schedules. Buzz Seating is not responsible or liable for any financial consequences resulting from production, shipping or delivery delays.

CAL 117-2013 and CAL 133

Buzz Seating's entire line meets CAL 117-2013 fire standards. CAL 133 is available on most models. Burn certificates available upon request. Check with Customer Service for additional information.

Authorized Dealer Requirement

To become an authorized Buzz Seating dealer, a dealer must be willing and able to provide full dealer services to the end user, including, but not limited to, design, product demonstrations, on-site installation, delivery, repairs, service, and warranty work. Additionally, Buzz Seating reserves the right to designate and authorize a dealer of record of its choice as it relates to a specific project, order or contract.

E-Commerce

Buzz Seating does not permit the marketing or sale of its products via e-commerce websites without the express written consent of the company.

Credit Terms and Policy

Where credit has been established, terms are net 30 days. A service charge of 1-1/2% per month or the maximum allowed by law will be imposed on all past due accounts. New accounts are required to submit a dealer application before an order can be processed. A minimum 50% deposit is required with the first order. Initial orders of \$1,000 or less require full prepayment. Once credit has been established, deposits are only required based upon payment history, unusual circumstances, or large orders. Payments made by credit card are subject to a 4% fee.

Warranty

Buzz Seating warrants to the original purchaser that components and workmanship will be free from defects under normal use from the date of original purchase as described below. As the sole remedy under this warranty, the company will repair or replace, at its discretion, without charge to original purchaser only the defective products or parts as follows:

Components

LIFETIME WARRANTY which is the entire time owned by the original end user for all chair components including pneumatic cylinder, mechanism, base, and casters.

Upholstery and Foam

5 year warranty on upholstery and foam; 10 year warranty on mesh. COM is not covered under the Buzz Seating warranty.

Normal use is defined under this warranty as standard commercial use based upon the product being properly utilized in a typical office environment, 8 hours per day, 5 days per week, with a weight limit not to exceed specified chair model weight. See specific chair series price book pages for weight limits and/or amended warranty information.

Normal wear and tear is not warrantied. Damages from misuse, abuse, alterations, accident or negligence are not covered. Buzz Seating is not responsible for incidental or consequential damages. Any labor or travel cost regarding installation, service, or repairs are the full responsibility of the dealer. Orders processed by Buzz Seating are done so with unconditional and full acceptance by the purchaser of Buzz Seating's published terms, conditions, and warranties. Absent Buzz Seating's willful misconduct or gross negligence, Buzz Seating shall not be liable for any damages or loss arising from the products, including personal injury or damage to property.

Except for the express representations and warranties set forth herein, Buzz Seating expressly disclaims and makes no warranties or representations, either express or implied on the products, including, but not limited to, any warranty of quality, design, condition, merchantability, or fitness for any purpose, or any warranty against patent infringement or latent defects. Except as expressly contained herein, all products are acquired as is, where is, with all faults, and without express or implied warranty of any kind.

Force Majeure

Buzz Seating shall not be liable for delay or failure to perform due to any event reasonably beyond its control, including but not limited to: fire, flood, strike, act of God, act of any governmental authority or of customer, riot, embargo, fuel or energy shortage, wrecks or delay in transportation, inability to obtain necessary labor, materials or manufacturing facilities from usual sources or failure of suppliers to meet their contractual obligations. In the event of a delay due to any such cause, Buzz Seating, at its sole discretion, may extend the date of delivery or time from completion as reasonably necessary to overcome the effect of such delay, to allocate any available supply of goods in a manner it deems reasonable, or to cancel any order. Should a qualifying event occur, Buzz Seating will immediately notify the customer's authorized representative by phone and email.

Buzz Seating strives to utilize North American manufactured components and labor whenever possible.

NAFTA Compliant / TAA Compliant

All products meet or exceed ANSI/BIFMA Standards

©2003-2022 Buzz Seating, Inc. All rights reserved.

COM (Customer's Own Material)

COM Approval

All COM fabric must be approved for use by Buzz Seating. It is recommended that a full yard of sample upholstery be submitted for testing and approval prior to processing an order. Many upholsteries are already pre-approved and do not require sampling. Please check with Customer Service for direction.

Yardage Requirements

For plain, non-directional, solid color or non-patterned upholstery, please follow the yardage requirements printed in this price book for each chair; however orders of 10 chairs or more usually require less yardage due to upholstery yield. Some repeat or patterned upholstery may require additional yardage. Contact Customer Service for exact yardage requirements.

Production Scheduling and Shipping

COM fabrics will be scheduled immediately into production upon receipt of the fabric at our plant location.

Submitting COM Upholstery

For identification purposes, it is important to reference the dealer's name and purchase order number on all upholstery rolls. Upholstery that requires special application or direction must be clearly explained by completion and submission of the form below. It is very important to follow all instructions listed regarding submission of COM upholstery.

Please Note

COM fabric will be inspected at our plant for quality issues. Buzz Seating will not be held responsible for defects, color, dye lot variations, or material flaws regarding COM fabric. Buzz Seating does not provide warranty for COM fabrics. Excess yardage will not be returned unless requested. A written request must be received at the time of order for return of excess COM yardage. Shipping charges are applicable.

Custom Upholstery Requests

Buzz Seating offers a graded-in program for many upholstery suppliers that is published on the website. For any COM not listed, contact Customer Service for direction. Buzz Seating assumes no liability or warranty for any COM material. Only upholstery specifically carded within the Buzz Seating program will retain the published warranty.

COM Form

Please Check One: Upholstery and form for pre-testing and approval only
 Upholstery and form for actual order

Name _____ Phone _____
 Contact Person _____ Fax _____
 Address _____ Email _____

 Purchase Order Number _____
 Chair Model _____
 Qty Ordered _____
 Yardage Required Per Chair _____
 COM Mill Supplier _____
 COM Upholstery Name/Number _____
 COM Upholstery Color _____
 Total Yardage Shipped _____

PLEASE CONTACT CUSTOMER SERVICE FOR ADDRESS TO SHIP COM UPHOLSTERY

*Please circle
for correct upholstery
direction application*

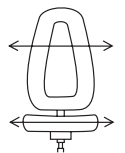

Horizontal

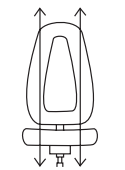

Vertical

NOTE

*Be sure to follow
COM instructions above*

Top of Chair

Attach Upholstery Here

(Place upholstery in the direction it should be applied to the chair.

If not returned with upholstery direction specified, factory will make judgment.)

Bottom of Chair



GSA Contract No. GS-28F-0040U
 TIN# 03-053-1579
 SIN# 33721
 Schedule MAS Office Furniture
 Contract Period: September 01, 2008 – August 31, 2023
 Business Size: Small

- 1a. Special Item Numbers Awarded:
 33721 Multipurpose Seating
 33721 Stacking Chairs
- 1b. Lowest Priced Item:
 33721 PRB01 \$535.00
 33721 FL00 \$395.00
- 1c. Hourly rates:
 Not Applicable
- 2. Maximum order:
 \$200,000.00
- 3. Minimum order:
 \$100.00
- 4. Geographic coverage:
 The 48 contiguous states and the District of Columbia, Alaska, Hawaii, Puerto Rico, and the Virgin Islands
- 5. Point of production:
 Cincinnati, OH and Cambridge, ON
- 6. Discount from list:
 60%
- 7. Quantity discounts:
 \$50,000.00-\$99,999.00 extra 1% off net
 \$100,000.00-\$149,000.00 extra 2% off net
 \$150,000.00-\$200,000.00 extra 3% off net
- 8. Prompt payment terms:
 Net 30 Days
- 9a. Notification that government purchase cards are accepted or not accepted above the micro-purchase threshold
 Yes-Credit Cards accepted-Visa and Mastercard
- 9b. Notification whether government purchase cards are accepted or not accepted above the micro-purchase threshold
 Yes-Credit Cards accepted-Visa and Mastercard
- 10. Foreign items:
 None
- 11a. Time of delivery:
 14 days after receipt of order
- 11b. Expedited delivery:
 Available on all products-Contact Factory
- 11c. Overnight and 2-day delivery:
 Available on all products-Contact Factory
- 11d. Urgent requirements:
 As per clause I-FSS-100 A, to effect a faster delivery, please contact the local dealer or factory
- 12. F.O.B. points:
 Destination/CONUS, within the 48 contiguous states and the District of Columbia. Port of embarkation for delivery to Alaska, Hawaii, Puerto Rico and the Virgin Islands

- 13a. Ordering address:
 Buzz Seating, Inc.
 4774 Interstate Drive
 Cincinnati, OH 45246
 Tel: (877) 263-5737
 Fax: (513) 772-7328
 Email: customerservice@buzzseating.com
 Authorized dealer should be noted on order
- 13b. Ordering procedures:
 For supplies and services, the ordering procedures, information on Blanket Purchase Agreements (BPA's) are found in Federal Acquisition Regulation (FAR) 8.405-3
- 14. Payment address:
 Buzz Seating, Inc.
 PO Box 31379
 Cincinnati, OH 45231
 Tel: (877) 263-5737
 Fax: (513) 772-7328
- 15. Warranty provisions:
 Buzz Seating offers a lifetime warranty against manufacturer's defects on components and 5 years on fabric and foam
- 16. Export packing charges:
 Quoted on request
- 17. Terms and conditions of government purchase card acceptance:
 A. Credit card number
 B. Credit card expiration date
 C. Individual's name as it appears on credit card & CVC code
 D. Telephone number to whom credit card is issued
- 18. Terms and conditions of rental, maintenance and repair:
 Not applicable
- 19. Terms and conditions of installation:
 Contact Factory
- 20. Terms and conditions of repair parts:
 Contact Factory
- 20a. Terms and conditions for any other services:
 Contact Factory
- 21. Servicing Dealers:
 Available upon request
- 22. List of participating dealers:
 Available upon request
- 23. Preventive maintenance:
 Contact Factory
- 24a. Special attributes such as environmental attributes:
 Not Applicable
- 24b. Not Applicable:
- 25. Data Universal Number System Number (DUNS):
 14-298-7200
- 26. Central Contractor Registration:
 Buzz Seating, Inc. is registered with the Central Contractor Registration (CCR) database
 Cage Code 51S38

Flite® Stacking Series

Perfect meeting room chair

- 7/8" steel frame
- 14 gauge steel
- Arm or armless
- Black frame
- Stackable 3-4 high
- Multiple options
- Ships fully assembled



SQUARE BACK
ARMLESS VERSION



RADIUS BACK
ARM VERSION

300 lb. Capacity All prices are LIST

Model	Arm Options	1	COM 2	Upholstery Grade			
				3	4	5	6
FLS00	armless	395	425	455	490	535	590
FLS10	with arms	450	480	510	545	590	645

300 lb. Capacity All prices are LIST

Model	Arm Options	1	COM 2	Upholstery Grade			
				3	4	5	6
FLR00	armless	395	425	455	490	535	590
FLR10	with arms	450	480	510	545	590	645

Options

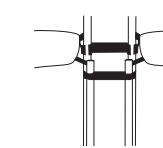

Adjustable Width
Ganging Brackets

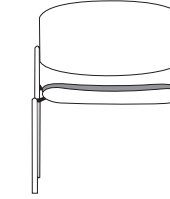

1" Extra Seat Foam

Back Panel Options

- SB** Standard upholstered back panel. **(DEFAULT)**
 - BB** Ballistic nylon back – recommended *(no upcharge)*
 - BP** Bumper back trim – recommended *(no upcharge)*
 Choose from 6 colors. Refer to web site for selection.
- Buzz Seating is not responsible for back panel wear or tear regardless of option chosen. For additional back wear protection, **BB** or **BP** is recommended. One option is provided without an additional upcharge. If both options are ordered, a **45** list upcharge applies. Refer to web site for **BP** color selections.
- DEFAULT IS SB UNLESS SPECIFIED OTHERWISE**

Additional Options

MODEL#		ADD
CAL133	California Technical Bulletin 133	115
MF	Memory foam 1" layered seat	105
EF	1" Extra seat foam	46
GB	Adjustable width ganging brackets	35 / pair
GLSLG2	Self leveling chrome glides (set of 4)	29
CF/CFC	Chrome and custom color frame finishes available. Minimum order quantity and extended lead time applies. Contact Customer Service for further information.	

Actual dimensions will vary depending on model and options selected.

Dimensions: seat width 19.5" seat height from floor 18" back width 19.5" back height 16"
 overall outside width 19.75" armless
 overall outside width 23.5" with arms
 overall outside depth 21.25"
 overall outside height 31.5"

COM Requirements: 1.25 yards per chair

TO ORDER, please specify:	model	back panel	options	fabric pattern	fabric color	price
EXAMPLE	FLR00	SB	GLSLG2	MOGULS	FLARE 2188	424



FREIGHT PROGRAM
 11 or fewer \$25 net per chair
 12 or more free shipping

Strong and solid lobby or side chair



14 gauge steel tube frame
20" wide seat (actual seat)

- 7/8" steel frame
- 14 gauge steel
- Arm or armless
- Black frame
- Sled base
- Easy mobility
- Timeless design
- Ships fully assembled

300 lb. Capacity All prices are LIST

Model	Arm Options	Upholstery Grade					
		1	2	3	4	5	6
ST00	armless	465	495	525	560	605	660
ST10	urethane arm pads	510	540	570	605	650	705

Arm Options



Options

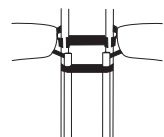

Adjustable Width Ganging Brackets



1" Extra Seat Foam

Back Panel Options

- SB** Standard upholstered back panel. **(DEFAULT)**
- BB** Ballistic nylon back – recommended *(no upcharge)*
- BP** Bumper back trim – recommended *(no upcharge)*
Choose from 6 colors. Refer to web site for selection.

Buzz Seating is not responsible for back panel wear or tear regardless of option chosen. For additional back wear protection, **BB** or **BP** is recommended. One option is provided without an additional upcharge. If both options are ordered, a 35 list upcharge applies. Refer to web site for **BP** color selections.

DEFAULT IS SB UNLESS SPECIFIED OTHERWISE

Additional Options

MODEL#		ADD
CAL133	California Technical Bulletin 133	115
MF	Memory foam 1" layered seat	105
EF	1" Extra seat foam	46
GB	Adjustable width ganging brackets	35 / pair
CF/CFC	Chrome and custom color frame finishes available. Minimum order quantity and extended lead time applies. Contact Customer Service for further information.	

Actual dimensions will vary depending on model and options selected.

Dimensions: seat width 20" seat height from floor 17" back width 20" back height 17.5" overall outside width 22"
Weight: 25 lbs.
COM Requirements: 1.50 yards per chair

TO ORDER, please specify:	model	back panel	options	fabric pattern	fabric color	price
EXAMPLE	ST10	BB	MF	MOGULS	FLARE 2188	615



The chair that sits like a gem.

- 1" oval steel frame tubing for added strength
- Arm or armless
- Black or gray frame
- Black or gray arms
- Stack 3-4 high
- Full sized back
- Compound double curved back for extreme comfort
- Optional casters
- Waterfall seat front
- Wall saver legs
- Nylon black glides (standard)
- Ships fully assembled

750 lb. Capacity All prices are LIST

Model	Frame Color	Description	Upholstery Grade					
			1	2	3	4	5	6
JEM00BK	black	armless	455	495	545	595	655	725
JEM00GR	gray	armless	455	495	545	595	655	725



Shown with **CC09** carpet casters



Polyurethane Version

- Polyurethane Version:**
- Extended lead time
 - Minimum order quantity
 - Grade 4 pricing

Actual dimensions will vary depending on model and options selected.

Dimensions: seat width 19.5" seat height from floor 17.5" back width 19.5" back height 16" overall outside width 21.5" armless overall outside width 25" with arms overall outside depth 24" overall outside height 33.5" overall height at arm 27"
Weight:
 JEM00 18 lbs.
 JEM10 21 lbs.
COM Requirements: 1.25 yards per chair

750 lb. Capacity All prices are LIST

Model	Frame Color	Description	Upholstery Grade					
			1	2	3	4	5	6
JEM10BK	black	with arms	520	560	610	660	720	790
JEM10GR	gray	with arms	520	560	610	660	720	790

Black arms are default unless gray arms are specified.

Additional Options

MODEL#		ADD
CAL133	California Technical Bulletin 133	115
CC09	Black carpet casters (set of 4)	46
HC09	Black hard floor casters (set of 4)	46
EF	1" Extra seat foam	46
GB	Adjustable width ganging brackets	35 / pair
CF/CFC	Chrome and custom color frame finishes available. Minimum order quantity and extended lead time applies. Contact Customer Service for further information.	

Back Panel Options

- SB** Standard upholstered back panel. **(DEFAULT)**
 - BB** Ballistic nylon back – recommended *(no upcharge)*
- Buzz Seating is not responsible for back panel wear or tear regardless of option chosen. For additional back wear protection, **BB** is recommended. **BP** is not available on Jem chairs.

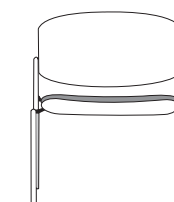

1" Extra Seat Foam

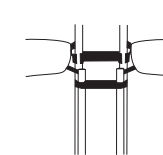

Adjustable Width Ganging Brackets

TO ORDER, please specify:	model	options	fabric pattern	fabric color	price
EXAMPLE	JEM10BK	EF	MOGULS	FLARE 2188	566



The chair that sits like a gem.

- 1" oval steel frame tubing for added strength
- Arm or armless
- Black or gray frame
- Black or gray arms
- Stackable 3-4 high

- Full sized back
- Compound double curved back for extreme comfort
- Optional casters

- Waterfall seat front
- Wall saver legs
- Nylon black glides (standard)
- Ships fully assembled



Shown with **CC09** black carpet casters

750 lb. Capacity All prices are LIST

Model	Frame Color	Description	Upholstery Grade					
			1	COM 2	3	4	5	6
JEM00+3BK	black	armless	695	745	825	935	1045	1170
JEM00+3GR	gray	armless	695	745	825	935	1045	1170

750 lb. Capacity All prices are LIST

Model	Frame Color	Description	Upholstery Grade					
			1	COM 2	3	4	5	6
JEM10+3BK	black	with arms	760	810	890	1000	1110	1235
JEM10+3GR	gray	with arms	760	810	890	1000	1110	1235

Black arms are default unless gray arms are specified.

Additional Options		
MODEL#		ADD
CAL133	California Technical Bulletin 133	130
CC09	Black carpet casters (set of 4)	46
HC09	Black hard floor casters (set of 4)	46
EF	1" Extra seat foam	52
GB	Adjustable width ganging brackets	35 / pair
CF/CFC	Chrome and custom color frame finishes available. Minimum order quantity and extended lead time applies. Contact Customer Service for further information.	

Back Panel Options	
SB	Standard upholstered back panel. (DEFAULT)
BB	Ballistic nylon back – recommended <i>(no upcharge)</i>
Buzz Seating is not responsible for back panel wear or tear regardless of option chosen. For additional back wear protection, BB is recommended. BP is not available on Jem chairs.	



1" Extra Seat Foam

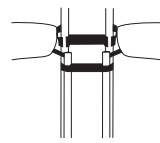

Adjustable Width Ganging Brackets

Actual dimensions will vary depending on model and options selected.

Dimensions:	seat width 22.5"	seat height from floor 17.5"	back width 22.5"	back height 16"
	seat depth 18.5"		overall outside width 24.5" armless	overall outside width 28" with arms
Weight:	JEM00+3 24 lbs.		overall outside depth 24"	overall outside height 33.5"
	JEM10+3 28 lbs.		overall outside height 33.5"	overall height at arm 27"
COM Requirements:	2.25 yards per chair			

TO ORDER, please specify:	model	options	fabric pattern	fabric color	price
EXAMPLE	JEM10+3BK	-	MOGULS	FLARE 2188	760



FREIGHT PROGRAM
11 or fewer \$25 net per chair
12 or more free shipping

The chair that sits like a gem.

- 1" oval steel frame tubing for added strength
- Arm or armless
- Black or gray frame
- Black or gray arms

- Stackable 3-4 high
- Full sized back
- Compound double curved back for extreme comfort

- Waterfall seat front
- Wall saver legs
- Nylon black glides
- Ships fully assembled



750 lb. Capacity All prices are LIST

Model	Frame Color	Description	Upholstery Grade					
			1	COM 2	3	4	5	6
JEM00+6BK	black	armless	800	850	930	1040	1150	1275
JEM00+6GR	gray	armless	800	850	930	1040	1150	1275

750 lb. Capacity All prices are LIST

Model	Frame Color	Description	Upholstery Grade					
			1	COM 2	3	4	5	6
JEM10+6BK	black	with arms	865	915	995	1105	1215	1340
JEM10+6GR	gray	with arms	865	915	995	1105	1215	1340

Black arms are default unless gray arms are specified.

Additional Options		
MODEL#		ADD
CAL133	California Technical Bulletin 133	145
EF	1" Extra seat foam	64
GB	Adjustable width ganging brackets	35 / pair
CF/CFC	Chrome and custom color frame finishes available. Minimum order quantity and extended lead time applies. Contact Customer Service for further information.	

Back Panel Options	
SB	Standard upholstered back panel. (DEFAULT)
BB	Ballistic nylon back – recommended <i>(no upcharge)</i>
Buzz Seating is not responsible for back panel wear or tear regardless of option chosen. For additional back wear protection, BB is recommended. BP is not available on Jem chairs.	



1" Extra Seat Foam

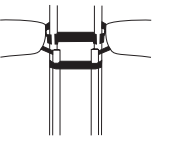

Adjustable Width Ganging Brackets

Actual dimensions will vary depending on model and options selected.

Dimensions:	seat width 25.5"	seat height from floor 17.5"	back width 25.5"	back height 16"
	seat depth 18.5"		overall outside width 27.5" armless	overall outside width 31" with arms
Weight:	JEM00+6 30 lbs.		overall outside depth 24"	overall outside height 33.5"
	JEM10+6 34 lbs.		overall outside height 33.5"	overall height at arm 27"
COM Requirements:	3 yards per chair			

TO ORDER, please specify:	model	options	fabric pattern	fabric color	price
EXAMPLE	JEM10+6BK	-	MOGULS	FLARE 2188	865



FREIGHT PROGRAM
11 or fewer \$25 net per chair
12 or more free shipping

Jem® Counter Stool

- 1" oval steel frame tubing for added strength
- Arm or armless
- Black or gray frame
- Black or gray arms
- Stackable 3-4 high
- Full sized back
- Compound double curved back for extreme comfort
- Waterfall seat front
- Wall saver legs
- Soft black multi surface glides (standard)
- Ships fully assembled



24" seat height



27" seat height

Use for work surfaces up to 36" high

350 lb. Capacity All prices are LIST

Model	Frame Color	Description	Upholstery Grade					
			1	COM 2	3	4	5	6
JEM24S00BK	black	armless	650	690	740	785	845	915
JEM24S00GR	gray	armless	650	690	740	785	845	915
JEM24S10BK	black	with arms	715	755	805	850	910	980
JEM24S10GR	gray	with arms	715	755	805	850	910	980

350 lb. Capacity All prices are LIST

Model	Frame Color	Description	Upholstery Grade					
			1	COM 2	3	4	5	6
JEM27S00BK	black	armless	650	690	740	785	845	915
JEM27S00GR	gray	armless	650	690	740	785	845	915
JEM27S10BK	black	with arms	715	755	805	850	910	980
JEM27S10GR	gray	with arms	715	755	805	850	910	980

Black arms are default unless gray arms are specified.

Additional Options		
MODEL#		ADD
CAL133	California Technical Bulletin 133	115
EF	1" Extra seat foam	46
GB	Adjustable width ganging brackets	35 / pair
CF/CFC	Chrome and custom color frame finishes available. Minimum order quantity and extended lead time applies. Contact Customer Service for further information.	

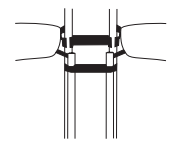
Back Panel Options	
SB	Standard upholstered back panel. (DEFAULT)
BB	Ballistic nylon back – recommended <i>(no upcharge)</i>
Buzz Seating is not responsible for back panel wear or tear regardless of option chosen. For additional back wear protection, BB is recommended. BP is not available on Jem chairs.	
	
1" Extra Seat Foam	Adjustable Width Ganging Brackets

Actual dimensions will vary depending on model and options selected.

Dimensions:	seat width 19.5"	back width 19.5"	overall outside width 21.5" armless
	seat depth 18.5"	back height 16"	overall outside width 25" with arms
Weight:	JEM24S 25 lbs.	seat height from floor 24"	overall outside height 40"
	JEM27S 27 lbs.	seat height from floor 27"	overall outside height 43"

COM Requirements: 1.25 yards per chair

TO ORDER, please specify:	model	options	fabric pattern	fabric color	price
EXAMPLE	JEM24S00BK	EF	MOGULS	FLARE 2188	696



Jem® Bar Stool

- 1" oval steel frame tubing for added strength
- Arm or armless
- Black or gray frame
- Black or gray arms
- Stackable 3-4 high
- Full sized back
- Compound double curved back for extreme comfort
- Waterfall seat front
- Wall saver legs
- Soft black multisurface glides (standard)
- Ships fully assembled



30" seat height

Use for work surfaces up to 42" high

350 lb. Capacity All prices are LIST

Model	Frame Color	Description	Upholstery Grade					
			1	COM 2	3	4	5	6
JEM30S00BK	black	armless	650	690	740	785	845	915
JEM30S00GR	gray	armless	650	690	740	785	845	915
JEM30S10BK	black	with arms	715	755	805	850	910	980
JEM30S10GR	gray	with arms	715	755	805	850	910	980

Black arms are default unless gray arms are specified.

Additional Options		
MODEL#		ADD
CAL133	California Technical Bulletin 133	115
EF	1" Extra seat foam	46
GB	Adjustable width ganging brackets	35 / pair
CF/CFC	Chrome and custom color frame finishes available. Minimum order quantity and extended lead time applies. Contact Customer Service for further information.	

Back Panel Options	
SB	Standard upholstered back panel. (DEFAULT)
BB	Ballistic nylon back – recommended <i>(no upcharge)</i>
Buzz Seating is not responsible for back panel wear or tear regardless of option chosen. For additional back wear protection, BB is recommended. BP is not available on Jem chairs.	

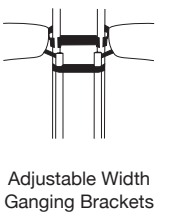

Actual dimensions will vary depending on model and options selected.

Dimensions:	seat width 19.5"	back width 19.5"	overall outside width 21.5" armless
	seat depth 18.5"	back height 16"	overall outside width 25" with arms
Weight:	JEM30S 30 lbs.	seat height from floor 30"	overall outside height 46"

COM Requirements: 1.25 yards per chair

TO ORDER, please specify:	model	options	fabric pattern	fabric color	price
EXAMPLE	JEM30S00BK	EF	MOGULS	FLARE 2188	696



Stock Black Only



Extreme comfort, quality construction, value priced.

- Solid overall construction
- Arm or armless
- Black or silver frame
- Durable poly mesh back
- Ships KD with assembly required

300 lb. Capacity All prices are LIST

Model	Frame Color	Description	Stock Black	Upholstery Grade					
				1	2	3	4	5	6
CA00BK	black	armless	420	470	495	520	545	570	600
CA00SR	silver	armless	420	470	495	520	545	570	600

Ships with CC02 hooded carpet casters

300 lb. Capacity All prices are LIST

Model	Frame Color	Description	Stock Black	Upholstery Grade					
				1	2	3	4	5	6
CA10BK	black	with arms	440	490	515	540	565	590	620
CA10SR	silver	with arms	440	490	515	540	565	590	620

Ships with CC02 hooded carpet casters

Additional Options

MODEL#		ADD
CAL133	California Technical Bulletin 133 (not available with stock black mesh seat)	58
HC02	Black hard floor casters (set of 4)	46

Actual dimensions will vary depending on model and options selected.

Dimensions: seat width 18.5" seat height from floor 18.25" back width 18.25" back height 17" seat depth 18" 19"

Weight: CA00 18 lbs. CA10 21 lbs.

COM Requirements: .5 yard per chair

overall outside width 22.75" armless
 overall outside width 24.75" with arms
 overall outside depth 24"
 overall outside height 34"
 overall height at arm 25.25"

TO ORDER, please specify:	model	options	fabric pattern	fabric color	price
EXAMPLE	CA10BK	CAL133	MOGULS	FLARE 2188	498



LOD68



LOD48



LOD20



LOD85



LOD151



LOD157



LOD189BK BLACK



LOD45BK BLACK
LOD45GR2T GRAY
LOD45LA2T LATTE
midback



LOD48BK BLACK
LOD48GR2T GRAY
LOD48LA2T LATTE
highback



LOD75BK BLACK
LOD75GR GRAY
midback



LOD78BK BLACK
LOD78GR GRAY
highback



LOD50BK BLACK
side chair



LOD55BK BLACK
midback



LOD58BK BLACK
highback



LOD85BK BLACK
LOD85BN BROWN
LOD85AL ALMOND
LOD85WH WHITE
midback



LOD88BK BLACK
LOD88BN BROWN
LOD88AL ALMOND
LOD88WH WHITE
highback



LOD65BK BLACK
LOD65BN BROWN
LOD65WH WHITE
midback



LOD68BK BLACK
LOD68BN BROWN
LOD68WH WHITE
highback



LOD151BK BLACK
LOD151AL ALMOND
ottoman
LOD157BK BLACK
LOD157AL ALMOND
highback



LOD20BK BLACK
LOD20TP TAUPE
LOD20BN BROWN
lobby



LOD28BK BLACK

FREIGHT PROGRAM
11 or fewer \$25 net per chair
12 or more **free** shipping 

See www.leatherondemand.com
for actual leather colors

Ships KD with assembly required

Note: Ships with all purpose casters.

Model	List
LOD20BK BLACK lobby	690
LOD20TP TAUPE lobby	690
LOD20BN BROWN lobby	690
LOD28BK BLACK	1190
LOD45BK BLACK midback	1185
LOD45GR2T GRAY midback	1185
LOD45LA2T LATTE midback	1185
LOD48BK BLACK highback	1290
LOD48GR2T GRAY highback	1290
LOD48LA2T LATTE highback	1290
LOD50BK BLACK side chair	895
LOD55BK BLACK midback	895
LOD58BK BLACK highback	1010
LOD65BK BLACK midback	1185
LOD65BN BROWN midback	1185
LOD65WH WHITE midback	1185
LOD68BK BLACK highback	1290
LOD68BN BROWN highback	1290
LOD68WH WHITE highback	1290
LOD75BK BLACK midback	1185
LOD75GR GRAY midback	1185
LOD78BK BLACK highback	1290
LOD78GR GRAY highback	1290
LOD85BK BLACK midback	1245
LOD85BN BROWN midback	1245
LOD85AL ALMOND midback	1245
LOD85WH WHITE midback	1245
LOD88BK BLACK highback	1385
LOD88BN BROWN highback	1385
LOD88AL ALMOND midback	1385
LOD88WH WHITE highback	1385
LOD151BK BLACK ottoman	395
LOD151AL ALMOND ottoman	395
LOD157BK BLACK highback	1495
LOD157AL ALMOND highback	1495
LOD189BK BLACK	1495

Additional Options

MODEL#	ADD
BACO Base collar (adds 3/4" to seat height)	6





- Simple synchro tilt
- Optional drop-away or height-adjustable arms
- Molded foam seat
- Convex back
- Back and seat upholstered in same or contrasting fabrics
- Ships KD with assembly required

300 lb. Capacity All prices are LIST

Model	Arm Options	Arm Pad Options (default pad in bold)	Upholstery Grade						
			1	2	3	4	5	6	
BA02	swivel synchro	armless	-	795	820	845	870	895	920
Great for mid management, conference room and meeting applications. Simple adjustments.	DA drop away	BAP , BT	920	945	970	995	1020	1045	1060
	VF fixed	-	900	925	950	975	1000	1025	1045
	ATS adj. T	BAP, BT	920	945	970	995	1020	1045	1060
	ATS/AW adj. T	BAP, BT	935	960	985	1010	1035	1060	1060

Ships with **CC07-SL** black & silver non-hooded carpet casters and **CY06** height cylinder

Mechanism Functions	Arm Pad Options	Additional Options											
<p>Synchro Tilter (1 paddle) Swivels 360°, pneumatic cylinder seat height adjustment, synchronized tilt between seat and back, locks in upright position, tilt tension control.</p>	 BT bullet arm pad (default pad if none specified)  BAP Buzz arm pad	<table border="1"> <thead> <tr> <th>MODEL#</th> <th>ADD</th> </tr> </thead> <tbody> <tr> <td>GLBG</td> <td>Stationary bell glides (set of 5)</td> <td>41</td> </tr> <tr> <td>HC07</td> <td>Hard floor casters (set of 5) Black only</td> <td>46</td> </tr> <tr> <td>ALUM PKG</td> <td>Includes: Base25-THA, Cylinder (CY02-CH), Casters (CCCH or HCCH)</td> <td>175</td> </tr> </tbody> </table>	MODEL#	ADD	GLBG	Stationary bell glides (set of 5)	41	HC07	Hard floor casters (set of 5) Black only	46	ALUM PKG	Includes: Base25-THA, Cylinder (CY02-CH), Casters (CCCH or HCCH)	175
MODEL#	ADD												
GLBG	Stationary bell glides (set of 5)	41											
HC07	Hard floor casters (set of 5) Black only	46											
ALUM PKG	Includes: Base25-THA, Cylinder (CY02-CH), Casters (CCCH or HCCH)	175											

Arm Options

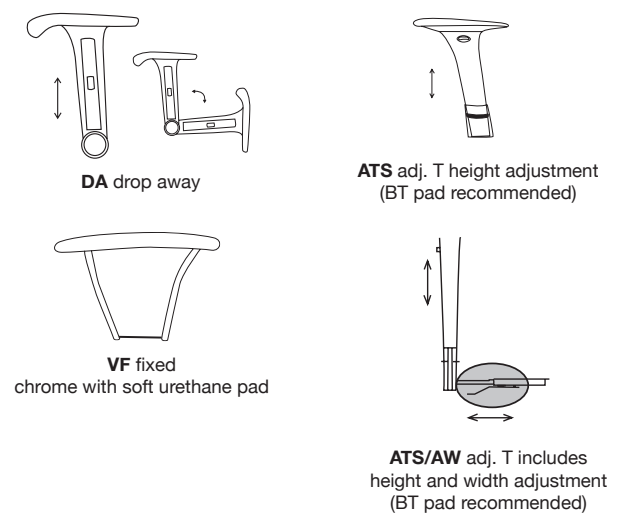

Actual dimensions will vary depending on model and options selected.
Dimensions:
 seat width 20.5" back width 20.5"
 seat depth 18" back height 22"
 seat height from floor 16"-215"
Weight: 38 lbs.
COM Requirements: 2.25 yards per chair

Option 2 use pricing for highest fabric grade selected

TO ORDER, please specify:	model	arm	arm pad	options	fabric pattern	fabric color	back faux color	price
EXAMPLE	BA02	ATS	BT	-	MOGULS	FLARE 2188	BLACK	920



FREIGHT PROGRAM
 11 or fewer \$25 net per chair
 12 or more free shipping

- Self-skinned polyurethane
- Chair or stool version
- Hard floor soft wheel casters
- Industrial, medical or lab applications
- Easy cleaning
- Ships KD with assembly required

Chair Version 300 lb. Capacity All prices are LIST

Model	Description	Chair
UR4001	Basic Task (1 paddle) Swivels 360°, pneumatic cylinder seat height adjustment	345
UR4003	Posture Back (2 paddles) Swivels 360°, pneumatic cylinder seat height adjustment, infinite back angle adjustment, back height adjustment	455

Ships with **CY02** height cylinder and includes **HC01** hard floor casters.



Chair
24" base

Stool Version 300 lb. Capacity All prices are LIST

Model	Description	Chair
UR4001-XSP	Basic Task (1 paddle) Swivels 360°, pneumatic cylinder seat height adjustment	510
UR4003-XSP	Posture Back (2 paddles) Swivels 360°, pneumatic cylinder seat height adjustment, infinite back angle adjustment, back height adjustment	620

Ships with **CY05** 10" cylinder, footring and **HC01** hard floor casters.



Stool
26" base

MODEL#	ADD	
GLBG	Stationary bell glides (set of 5)	41
MSLC	Self-braking hard floor casters brake when unoccupied (set of 5)	69
MSRLC	Self-braking hard floor casters brake when occupied (set of 5)	75
CC01	Carpet casters-black only (set of 5)	N/C

Actual dimensions will vary depending on model and options selected.
Dimensions: seat width 18" seat height from floor chair 15.5"-20.5" back width 16"
 seat depth 17" seat height from floor stool 21"-31" back height 18"-20"
Weight: approx. 30 lbs. chair
 approx. 33 lbs. stool

TO ORDER, please specify:	model	options	price
EXAMPLE	UR4001-XSP	MSLC	579



FREIGHT PROGRAM
 11 or fewer \$25 net per chair
 12 or more free shipping

General Purpose/Medical/Dental Series

- 3" Back height adjustment
- 16" diameter seat
- Dual seat height adjustment handles
- Self pivoting spring back

- Coordinating colors back bar, control & handles, base and casters
- Partial assembly required

Only available in medical grade high performance upholstery.

300 lb. Capacity

All prices are LIST



General Purpose Stool			Medical High Gr Vinyl		
			2	3	5
MDS26	Basic unit, 22" base	18-23" seat height	320	340	380
MDS26-CY04	Stool height, 24" base	21-29" seat height	361	381	421
MDS26-CY05	Extended stool height, 24" base	24-34" seat height	384	404	444

Ships with matching color **HC01** soft wheel hard floor casters.

300 lb. Capacity

All prices are LIST



General Purpose Stool With Back			Medical High Gr Vinyl		
			2	3	5
MDS36	Basic unit, 22" base	18-23" seat height	475	505	565
MDS36-CY04	Stool height, 24" base	21-29" seat height	516	546	606
MDS36-CY05	Extended stool height, 24" base	24-34" seat height	539	569	629
MDS36-SP	Stool height with 18" adjustable footring, 24" base	21-29" seat height	608	638	698
MDS36-XSP	Extended stool height with 18" adjustable footring, 24" base	24-34" seat height	631	661	721

Ships with matching color **HC01** soft wheel hard floor casters.

300 lb. Capacity

All prices are LIST



Assistant Stool			Medical High Gr Vinyl		
			2	3	5
MDS16	Basic unit, 24" base	17-22" seat height	695	720	770
MDS16-CY04	Stool height, 24" base	20-28" seat height	736	761	811

Ships with matching color **HC01** soft wheel hard floor casters.



3" back height adjustment view



18" footring

TO ORDER, please specify:	model	color combo	options	fabric pattern	fabric color	price
EXAMPLE	MDS26	BLACK	-	SPIRIT	413 DOVE	320



FREIGHT PROGRAM
11 or fewer \$25 net per chair
12 or more **free** shipping



Black base/casters
Not available on MDS16



Lt Gray base/casters



Dk Gray base/casters



Sand base/casters

REQUIRED Specify the following:

- Black Combo:** Black mechanism, base, casters and cylinder
- Lt Gray Combo:** Lt Gray mechanism, base, casters and chrome cylinder
- *Dk Gray Combo:** Dk Gray mechanism, base, casters and chrome cylinder
- *Sand Combo:** Sand mechanism, base, casters and chrome cylinder

* limited stock - discontinuing. Call customer service



Basic unit seat height



Stool seat height



Extended stool seat height

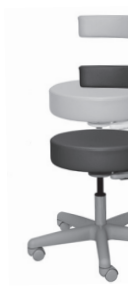

Basic unit seat height



Stool seat height



Extended stool seat height

Actual dimensions will vary depending on model and options selected.

Dimensions:
MDS36 back width 15.5"
MDS36 back height 11.5"
Seat width 16"
COM Requirements: Seat: .75 yards
Back: 1.25 yards

Actual dimensions will vary depending on model and options selected.

Dimensions:
MDS16 back width 15.5"
MDS16 back height 11.5"
Seat width 16"
COM Requirements: Seat: .75 yards
Arm: .5 yards

Additional Options

MODEL#		ADD
CAL133	California Technical Bulletin 133 Seat Unit Seat and Back Unit	60 120
BASE22-A	Medical aluminum base (not available on stools)	130
CCCH	Chrome hooded carpet casters (set of 5)	52
HCCH	Chrome hooded hard floor casters (set of 5)	52
CC01	Carpet casters-black only (set of 5)	N/C
FR18	Sure Grip Footring 18"	92

Back Panel Options

BP Ships with black bumper trim unless another color is specified. Choose from 6 colors. Refer to web site for selection.

Buzz Seating is not responsible for back panel wear or tear.



- Upholstered seat and black mesh back
- Simple synchro tilt
- Tilt tension adjustment
- Height adjustable arms
- Ships KD with assembly required



300 lb. Capacity All prices are LIST

Model	Stock Black
DANDY	575

Ships with **CC07** hooded carpet casters and **CY10** height cylinder

Additional Option		
MODEL#		ADD
HC07	Hard floor casters (set of 5)	46



Actual dimensions will vary depending on model and options selected.

Dimensions:
 seat width 21" back width 19.5"
 seat depth 20.5" back height 20"
 seat height from floor 19"-23"
Weight: 34 lbs.
COM Requirements: 1 yard per chair

TO ORDER, please specify:	model	options	fabric pattern	fabric color	price
EXAMPLE	DANDY	-	MOGULS	FLARE 2188	575



FREIGHT PROGRAM
 11 or fewer \$25 net per chair
 12 or more free shipping



- Upholstered seat and black mesh back
- Synchro tilt with 4 position lock
- Tilt tension adjustment
- Seat slider
- Height and width adjustable arms
- Lumbar adjustment
- Ships KD with assembly required



300 lb. Capacity All prices are LIST

Model	Stock Black	Upholstery Grade						
		1	2	3	4	5	6	
NIFTY-L	synchro tilt	850	960	990	1020	1055	1110	1170

Ships with **CC07** non-hooded carpet casters and **CY07** height cylinder



300 lb. Capacity All prices are LIST

Model	Stock Black	Upholstery Grade						
		1	2	3	4	5	6	
NIFTY-L-SP	seat height from floor 23"-31"	983	1093	1123	1153	1188	1243	1303
NIFTY-L-XSP	seat height from floor 25"-35"	1006	1116	1146	1176	1211	1266	1326

Ships with **CC07** non-hooded carpet casters and **CY04** or **CY05** height cylinder

Stool version non-tilting. Seat height adjustment only.

Additional Option		
MODEL#		ADD
HC07	Hard floor casters (set of 5)	46

Actual dimensions will vary depending on model and options selected.

Dimensions:
 seat width 20.5" back width 19.75"
 seat depth 19"-21.5" (stool 19") back height 23"
 seat height from floor 19"-21.5" (chair)
 seat height from floor 23"-31" (stool)
 seat height from floor 25"-35" (extended stool)
Weight: 43 lbs.
COM Requirements: 1 yard per chair

TO ORDER, please specify:	model	options	fabric pattern	fabric color	price
EXAMPLE	NIFTY-L	HC07	MOGULS	FLARE 2188	896



FREIGHT PROGRAM
 11 or fewer \$25 net per chair
 12 or more free shipping

Mesh back companion chair

- 7/8" steel frame
- 14 gauge steel
- Arm or armless
- Black frame
- Stackable
- Durable mesh back
- Deep waterfall front seat edge
- Multiple mesh colors

Ships fully assembled.



300 lb. Capacity All prices are LIST

Model	Frame Color	Description	Upholstery Grade					
			1	COM 2	3	4	5	6
ME00BK	black	armless	380	400	420	440	460	480



300 lb. Capacity All prices are LIST

Model	Frame Color	Description	Upholstery Grade					
			1	COM 2	3	4	5	6
ME10BK	black	with arms	435	455	475	495	515	535



Additional Options		
MODEL#		ADD
CAL133	California Technical Bulletin 133	60
CC09	Black carpet casters (set of 4)	46
HC09	Black hard floor casters (set of 4)	46
GB	Adjustable width ganging brackets	35 / pair
CF/CFC	Chrome and custom color frame finishes available. Minimum order quantity and extended lead time applies. Contact Customer Service for further information.	

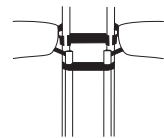

Adjustable Width Ganging Brackets

Colored Mesh		
MODEL#	COLOR	ADD
MM001	Red	65
MM002	Blue	65
MM003	Green	65
MM004	Lt Gray	65
MM005	Dk Gray	65
MM000	Black mesh is default	0

See www.melochair.com for actual mesh colors

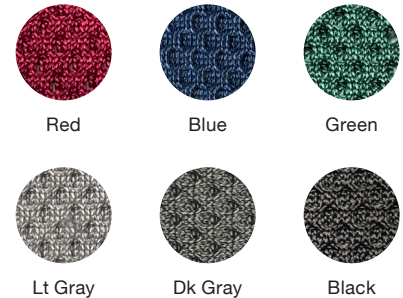

Actual dimensions will vary depending on model and options selected.

Dimensions:	seat width 18"	seat height from floor 18"	back width 17.5"	back height 17"	overall outside width 18.5"	armless
Weight:	ME00 15 lbs.	ME10 17 lbs.	overall outside width 22.25"	overall outside depth 24"	overall outside height 33.5"	with arms
COM Requirements:	1 yard per chair					

TO ORDER, please specify:	model	options	fabric pattern	fabric color	back mesh color	price
EXAMPLE	ME10BK	-	MOGULS	FLARE 2188	MM001	500



- Poly mesh back
- Upholstered seat
- Free floats in unlocked position
- Tilt tension adjustment
- Ships KD with assembly required

275 lb. Capacity All prices are LIST

Model	Arm Options	Upholstery Grade					
		1	COM 2	3	4	5	6
MEHB02 swivel tilt	armless	525	540	555	570	595	630
	ZH fixed conference room	555	570	585	600	625	660
	FH fixed with pad	560	575	590	605	630	665
	AT adj. T with pad	650	665	680	695	720	755



HIGHBACK

Ships with CC01 hooded carpet casters and CY14 height cylinder

Swivel Tilter

(1 paddle)
Swivels 360°, pneumatic cylinder seat height adjustment, seat and back tilt as unit, tilt tension control, tilt free floats or locks in upright position.

Arm Options



ZH fixed conference room



FH fixed with pad



AT adj. T height adjustment w/BAP

Additional Options

MELO BASIC		
MODEL#		ADD
CAL133	California Technical Bulletin 133	60
HC01	Hard floor casters (set of 5)	41

Colored Mesh

MODEL#	COLOR	ADD
MM001	Red	65
MM002	Blue	65
MM003	Green	65
MM004	Lt Gray	65
MM005	Dk Gray	65
MM000	Black mesh is default	0

See www.melochair.com for actual mesh colors

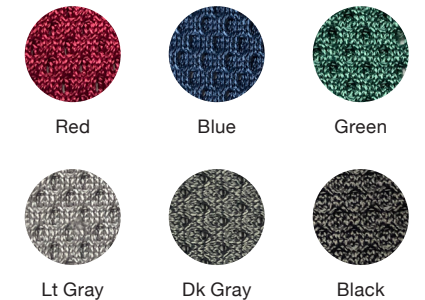

Actual dimensions will vary depending on model and options selected.

Dimensions:	seat width 21"	back width 20.5"
	seat depth 21"	back height 22" highback
Weight:	approx. 36-38 lbs.	
COM Requirements:	1 yard per chair	

TO ORDER, please specify:	model	arm	options	fabric pattern	fabric color	back mesh color	price
EXAMPLE	MEHB02	ZH	HC01	MOGULS	FLARE 2188	MM000	596



Ships partially assembled.

Poly Mesh Back

300 lb. Capacity All prices are LIST

Model	Arm Options	Arm Pad Options (default pad in bold)	Upholstery Grade					
			1	2	3	4	5	6

	MEMB04 <i>synchro tilt</i>	armless	-	625	640	655	670	695	730
		DA drop away	BAP, BT	750	765	780	795	820	855
		VF fixed	-	730	745	760	775	800	835
		ATS adj. T	BAP, BT	750	765	780	795	820	855
		ATS/AW adj. T	BAP, BT	765	780	795	810	835	870

MIDBACK

Ships with **CC07-SL** black & silver non-hooded carpet casters and **CY06** height cylinder

	MEHB04 <i>synchro tilt</i>	armless	-	650	665	680	695	720	755
		DA drop away	BAP, BT	775	790	805	820	845	880
		VF fixed	-	755	770	785	800	825	860
		ATS adj. T	BAP, BT	775	790	805	820	845	880
		ATS/AW adj. T	BAP, BT	790	805	820	835	860	895

HIGHBACK

Most popular

Ships with **CC07-SL** non-hooded carpet casters and **CY06** height cylinder

Weight activated automatically adapts to the users weight for optimal chair tilting balance

	MEHBWA <i>weight activated tension control</i>	armless	-	745	760	775	790	815	850
		DA drop away	BAP, BT	870	885	900	915	940	975
		VF fixed	-	850	865	880	895	920	955
		ATS adj. T	BAP, BT	870	885	900	915	940	975
		ATS/AW adj. T	BAP, BT	885	900	915	930	955	990

MAT/AW multi-function - 945 960 975 990 1015 1050



Stool version non-tilting. Seat height adjustment only.

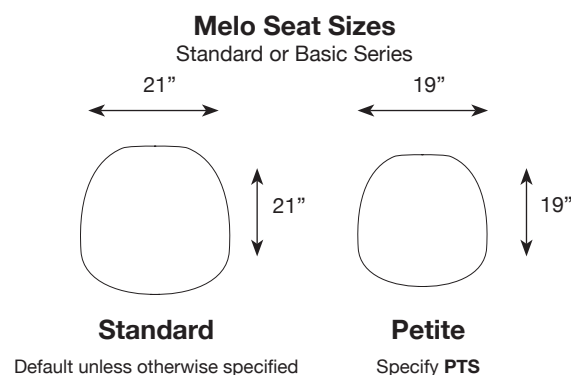

TO ORDER, please specify:

EXAMPLE	MEMB04	ATS	BT	SS	MOGULS	FLARE 2188	MM000	837
---------	--------	-----	----	----	--------	------------	-------	-----

Mechanism Functions

Synchro Tilter

(2 paddles)
Swivels 360°, pneumatic cylinder seat height adjustment, synchronized tilt between seat and back, free floats in unlocked position, 4 position tilt lock, tilt tension control.

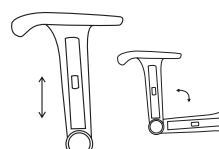

DA drop away

Arm Pad Options



BT bullet arm pad (default pad if none specified)

Additional Options

MODEL#		ADD
CAL133	California Technical Bulletin 133	60
MF	Memory foam 1" top added to seat	105
EF	1" extra seat foam	46
SS (MESH)	Sliding seat depth adjustment (not available on stools)	87
GLBG	Stationary bell glides (set of 5) all black only	45
HC07	Hard floor casters (set of 5) all black only	46
*SP	Stool package includes 8" cylinder and "Sure Grip" footing. Seat height extends from 24"-32".	133
FR20	"Sure Grip" footing only	92
ALUM PKG	Includes: Base (BASE25-THA), Cylinder (CY02-CH), Casters (CCCH or HCCH)	175
PETITE	Petite sized seat	N/C
RATCHET	Back height adjustment (MEHB04 only)	N/C
PRMB SEAT	Pronto seat upgrade	60
PRP SEAT	Pronto petite seat upgrade	60

*When converting to a stool, the tilt feature is disengaged by the factory before shipping.

Synchro Tilter

(2 paddles)
Swivels 360°, pneumatic cylinder seat height adjustment, synchronized tilt between seat and back, free floats in unlocked position, 4 position tilt lock, tilt tension control.

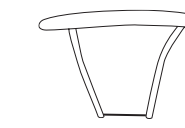

VF fixed chrome with soft urethane pad



BAP Buzz arm pad

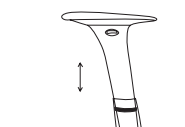

ATS adj. T height adjustment (BT pad recommended)

Weight Activated Tension Control

(2 paddles)
Swivels 360°, pneumatic cylinder height adjustment, synchro tilt self-adjusting user weight balance, tilt tension control, tilt travel limiter.

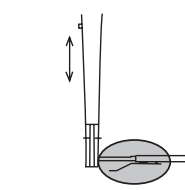

ATS/AW adj. T includes height and width adjustment (BT pad recommended)

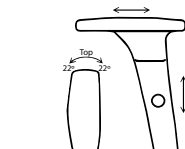

MAT/AW multi-function (no arm pad option)

Colored Mesh

MODEL#	COLOR	ADD
MM001	Red	65
MM002	Blue	65
MM003	Green	65
MM004	Lt Gray	65
MM005	Dk Gray	65
MM000	Black mesh is default	0

See www.melochair.com for actual mesh colors

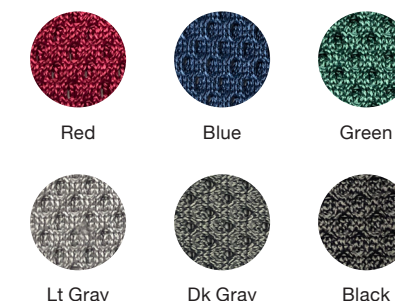

Actual dimensions will vary depending on model and options selected.

Dimensions: seat width 21" back width 20.5"
 seat depth 21" seat height Highback 22"
 Petite (PTS) seat width 19" seat depth 19" Midback 18"

seat height from floor 16"-23" (chair)
 seat height from floor 24"-32" (stool)
 approx. 36-38 lbs.

Weight:

COM Requirements: 1 yard per chair

Rika Chair® Upholstered Seat Mesh Back



- Upholstered seat and black mesh back
- Synchro tilt with 4 position lock
- Free floats in unlocked position
- Tilt tension adjustment
- Seat slider
- Adjustable lumbar support
- Multifunction arms on chair
- Height and width adjustable arms on stool
- Ships KD with assembly required



300 lb. Capacity All prices are LIST

Model	Stock Black	COM			Upholstery Grade		
		1	2	3	4	5	6
RIK-FAB	995	1105	1135	1165	1200	1255	1315

Ships with CC07 non-hooded carpet casters and CY08 height cylinder



300 lb. Capacity All prices are LIST

Model	Stock Black	COM			Upholstery Grade		
		1	2	3	4	5	6
RIK-FAB-SP seat height from floor 23"-31"	1128	1238	1268	1298	1333	1388	1448
RIK-FAB-XSP seat height from floor 25"-35"	1151	1261	1291	1321	1356	1411	1471

Ships with CC07 non-hooded carpet casters and CY04 or CY05 height cylinder

Stool version non-tilting. Seat height adjustment only.



Optional Headrest

Additional Options		
MODEL#		ADD
RAHR	Adj. headrest black mesh	130
BASE-PAB	Polished aluminum base (raises seat height)	130
HC07	Hard floor casters (set of 5)	46

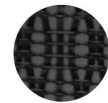

Stock Black Mesh Back



Stock Black Seat



Actual dimensions will vary depending on model and options selected.

Dimensions:
 seat width 20" back width 21"
 seat depth 20"-22.25" back height 23.5"
 seat height from floor 17"-20" with short cylinder (CY07)
 18"-22" with standard cylinder
 19"-24" with tall cylinder (CY09)
If upgrading to PAB please add 1" to seat height.
Please specify if CY07 or CY09 is needed.

seat height from floor 23"-31" (stool) seat height from floor 25"-35" (extended stool)
Weight: 45 lbs. **COM Requirements:** 1 yard per chair

TO ORDER, please specify:	model	options	fabric pattern	fabric color	price
EXAMPLE	RIK-FAB	RAHR	MOGULS	FLARE 2188	1125



FREIGHT PROGRAM
 11 or fewer \$25 net per chair
 12 or more **free** shipping

Rika Chair® All Mesh



- Mesh seat and back
- 2 mesh colors
- Synchro tilt with 4 position lock
- Free floats in unlocked position
- Tilt tension adjustment
- Seat slider
- Adjustable lumbar support
- Multifunction arms on chair
- Height and width adjustable arms on stool
- Ships KD with assembly required



300 lb. Capacity All prices are LIST

Model	Mesh Color	List
RIK-B	Black	1140
RIK-G	Gray	1140

Ships with CC07 non-hooded carpet casters and CY08 height cylinder



300 lb. Capacity All prices are LIST

Model	Mesh Color	List
RIK-B-SP seat height from floor 23"-31"	Black	1273
RIK-B-XSP seat height from floor 25"-35"	Black	1296

Ships with CC07 non-hooded carpet casters and CY04 or CY05 height cylinder

Stool version non-tilting. Seat height adjustment only.



Optional Headrest

Additional Options		
MODEL#		ADD
RAHR	Adj. headrest black or gray mesh	130
BASE-PAB	Polished aluminum base (raises seat height)	130
HC07	Hard floor casters (set of 5)	46

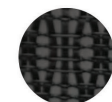

Black Mesh

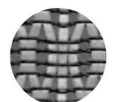

Gray Mesh

See www.rikachair.com for actual mesh colors



Actual dimensions will vary depending on model and options selected.

Dimensions:
 seat width 21.5" back width 21"
 seat depth 20"-22.25" back height 23.5"
 seat height from floor 16"-19" with short cylinder (CY07)
 17"-21" with standard cylinder
 18"-23" with tall cylinder (CY09)
If upgrading to PAB please add 1" to seat height.
Please specify if CY07 or CY09 is needed.

seat height from floor 23"-31" (stool) seat height from floor 25"-35" (extended stool)

TO ORDER, please specify:	model	options	Price
EXAMPLE	RIK-B	RAHR	1270



FREIGHT PROGRAM
 11 or fewer \$25 net per chair
 12 or more **free** shipping

Rika Chair® Leather Seat Mesh Back



- Leather seat and black mesh back
- Aluminum package
- 3 leather colors
- Synchro tilt with 4 position lock
- Free floats in unlocked position
- Tilt tension adjustment
- Seat slider
- Adjustable lumbar support
- Multifunction arms
- Ships KD with assembly required



300 lb. Capacity All prices are LIST

Model	Leather Color	List
RIK-BL	Black	1270
RIK-GL	Gray	1270
RIK-RL	Red	1270

Ships with CC07 non-hooded carpet casters and CY08 height cylinder



Optional Headrest

Additional Options		
MODEL#		ADD
RAHR	Adj. headrest black mesh	130
BASE-PBB	Poly black base (reduces seat height)	NC
HC07	Hard floor casters (set of 5)	46

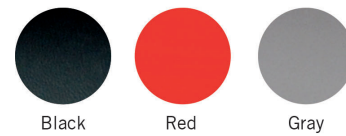

See www.rikachair.com for actual leather colors

Actual dimensions will vary depending on model and options selected.

Dimensions:
 seat width 20" back width 21"
 seat depth 20"-22.25" back height 23.5"
 seat height from floor 18"-21" with short cylinder (CY07)
 19"-23" with standard cylinder
 20"-25" with tall cylinder (CY09)

If upgrading to RIK-PBB please subtract 1" from seat height.

Please specify if CY07 or CY09 is needed.

Weight: 46 lbs.

TO ORDER, please specify:
EXAMPLE

model	options	Price
RIK-BL	RAHR	1400



FREIGHT PROGRAM
 11 or fewer \$25 net per chair
 12 or more free shipping

Snap™ Series

Ships partially assembled.

275 lb. Capacity All prices are LIST



Model	Arm Options	Upholstery Grade					
		1	2	3	4	5	6
SN	base chair includes armless chair, plastic back	495	515	535	555	575	595
	FA cantilevered fixed arms	525	545	565	585	605	625

Ships with CC01 hooded carpet casters and CY13 height cylinder



Model	Arm Options	Upholstery Grade					
		1	2	3	4	5	6
SN-UPB	armless chair, upholstered back	590	610	630	650	670	690
	FA upholstered back, fixed arms	620	640	660	680	700	720

Ships with CC01 hooded carpet casters and CY13 height cylinder

Low back chair without armrest

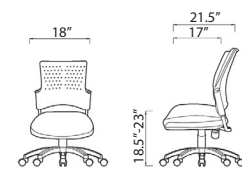

Low back chair with fixed armrest

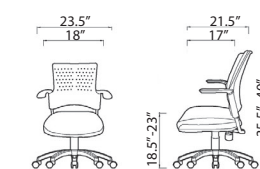

Powder coated steel back rest support



Perforated plastic back shell



URSEAT Urethane seat option



XSP Extended Stool Package
 Seat height 22.5"-33"



UPB Upholstered Back



FA Cantilevered Fixed Arms



BASE22-A Aluminum Base (not available on stools)

Weight: approx. 24 lbs.

COM Requirements: Seat .75 yards per chair
 Back .75 yards per chair

TO ORDER, please specify:
EXAMPLE

model	arm	options	fabric pattern	fabric color	price
SN	FA	MSLC	MOGULS	FLARE 2188	594



FREIGHT PROGRAM
 11 or fewer \$25 net per chair
 12 or more free shipping

Big & Tall 350 lb. Series

Heavy Duty 24/7 Multi-Shift



- Heavy duty components
- Basic or full function mechanism
- 5 prong 27" nylon base
- Heavy duty CC01-HD casters
- CY02-HD2 height cylinder
- Built to last
- Partial assembly required

350 lb. Capacity All prices are LIST

Model	Arm Options	Arm Pad Options (default pad in bold)	COM			Upholstery Grade		
			1	2	3	4	5	6
BC01 <i>basic task ratchet back</i>	armless	-	1135	1175	1215	1275	1335	1395
	DA drop away	BAP, BT	1260	1300	1340	1400	1460	1520
	AT/AW adj. T	BAP, BT	1260	1300	1340	1400	1460	1520
	AL adj. loop	-	1320	1360	1400	1460	1520	1580

BC08 <i>multi tilter ratchet back</i>	armless	-	1265	1305	1345	1405	1465	1525
	DA drop away	BAP, BT	1390	1430	1470	1530	1590	1650
	AT/AW adj. T	BAP, BT	1390	1430	1470	1530	1590	1650
	AL adj. loop	-	1450	1490	1530	1590	1650	1710

Most popular (recommended)

BC09 <i>multi tilt ratchet back integrated seat slider</i>	armless	-	1300	1340	1380	1440	1500	1560
	DA drop away	BAP, BT	1425	1465	1505	1565	1625	1685
	AT/AW adj. T	BAP, BT	1425	1465	1505	1565	1625	1685
	AL adj. loop	-	1485	1525	1565	1625	1685	1745

Actual dimensions will vary depending on model and options selected.

Dimensions: seat width 25" seat height from floor chair 19"-24" back width 22"
 seat depth 23" back height 23"-25.5"
Weight: approx. 49 lbs. chair

COM Requirements: 2 yards per chair



TO ORDER, please specify: EXAMPLE	model	arm	arm pad	back panel	options	fabric pattern	fabric color	price
	BC08	AL	-	BB	-	MOGULS	FLARE 2188	1450

Mechanism Functions	Arm Options	Arm Pad Options	Back Panel Options
---------------------	-------------	-----------------	--------------------

Basic Task - Heavy Duty Version
 (1 paddle)
 Swivels 360°, pneumatic cylinder seat height adjustment, back depth adjustment, internal ratchet back height adjustment.

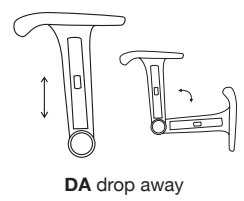

SB Standard upholstered back panel. **(DEFAULT)**
BB Ballistic nylon back – recommended *(no upcharge)*
BP Bumper back trim – recommended *(no upcharge)*
 Choose from 6 colors. Refer to web site for selection.

Buzz Seating is not responsible for back panel wear or tear regardless of option chosen. For additional back wear protection, **BB** or **BP** is recommended. One option is provided without an additional upcharge. If both options are ordered a **45** list upcharge applies. Refer to web site for **BP** color selections.

DEFAULT IS SB UNLESS SPECIFIED OTHERWISE

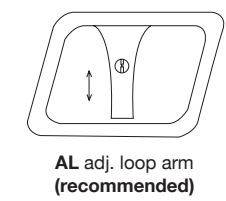

Multi Tilter - Heavy Duty Version
 (3 paddles)
 Swivels 360°, pneumatic cylinder seat height adjustment, seat and back tilt as unit, free floats in unlocked position, infinite position tilt lock, tilt tension control, internal ratchet back height adjustment, infinite back angle adjustment.

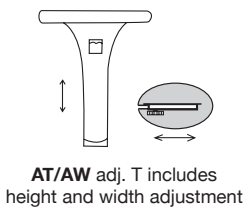

Multi Tilt w/Integrated Seat Slider - Heavy Duty Version
 (4 paddles)
 Swivels 360°, pneumatic cylinder seat height adjustment, seat and back tilt as unit, free floats in unlocked position, infinite position tilt lock, tilt tension control, internal ratchet back height adjustment, infinite back angle adjustment, side activated sliding seat pan.

Additional Options

MODEL#		ADD
CAL133	California Technical Bulletin 133	140
GLBG	Stationary bell glides (set of 5)	41
HC01-HD	Hard floor casters (set of 5)	75
MSLC	Self-braking hard floor casters brake when unoccupied (set of 5)	69
MSRLC	Self-braking hard floor casters brake when occupied (set of 5)	75
FR20	"Sure Grip" footing only	92
ESD	Electrostatic dissipation. Dissipates static electricity from chair. Includes: conductive fabric, conductive casters. *Specify hard floor or carpet casters	Gr 6 + 144

Warranty: Big & Tall Series

Standard published warranty terms and conditions apply with the following changes: 10 years on all components, 5 years on fabric and foam. If chairs are to be used for multi-shift applications which is defined as use exceeding 8 hours per day, 5 days per week, then multi-shift warranty applies: 5 years on components and 2 years on fabric and foam.



- Heavy duty components
- Basic or full function mechanism
- 6 prong 27" steel base
- Chair or stool
- Heavy duty MSSHD casters
- CY02-SHD height cylinder
- Built to last
- Partial assembly required

Extended shipping time required.

*Ships in 2 boxes on a skid via LTL.

500 lb. Capacity

All prices are LIST

Model	Arm Options	Arm Pad Options (default pad in bold)	1	2	COM 3	Upholstery Grade 4	5	6
BC01HD <i>basic task ratchet back</i>	armless	-	1570	1610	1650	1710	1770	1830
Stool package available 350 lb. capacity	DA drop away	BAP , BT	1695	1735	1775	1835	1895	1955
	AT/AW adj. T	BAP , BT	1695	1735	1775	1835	1895	1955
	AL adj. loop	-	1755	1795	1835	1895	1955	2015

BC08HD <i>multi tilter ratchet back</i>	armless	-	1700	1740	1780	1840	1900	1960
	DA drop away	BAP , BT	1825	1865	1905	1965	2025	2085
	AT/AW adj. T	BAP , BT	1825	1865	1905	1965	2025	2085
	AL adj. loop	-	1885	1925	1965	2025	2085	2145

Most popular (recommended)

BC09HD <i>multi tilt ratchet back integrated seat slider</i>	armless	-	1735	1775	1815	1875	1935	1995
	DA drop away	BAP , BT	1860	1900	1940	2000	2060	2120
	AT/AW adj. T	BAP , BT	1860	1900	1940	2000	2060	2120
	AL adj. loop	-	1920	1960	2000	2060	2120	2180

Actual dimensions will vary depending on model and options selected.

Dimensions: seat width 25" seat height from floor chair 19"-24" back width 22"
seat depth 23" back height 23"-25.5"

Weight: approx. 79 lbs. heavy duty chair

COM Requirements: 2 yards per chair



FREIGHT PROGRAM
11 or fewer \$25 net per chair
12 or more free shipping

TO ORDER, please specify:	model	arm	arm pad	back panel	options	fabric pattern	fabric color	price
EXAMPLE	BC08HD	AL	-	BB	-	MOGULS	FLARE 2188	1885

Mechanism Functions

Basic Task - Heavy Duty Version

(1 paddle)
Swivels 360°, pneumatic cylinder seat height adjustment, back depth adjustment, internal ratchet back height adjustment.

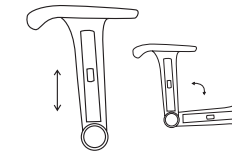

DA drop away

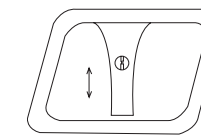

AL adj. loop arm (recommended)

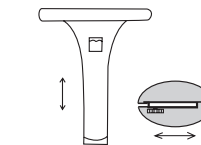

AT/AW adj. T includes height and width adjustment

Multi Tilter - Heavy Duty Version

(3 paddles)
Swivels 360°, pneumatic cylinder seat height adjustment, seat and back tilt as unit, free floats in unlocked position, infinite position tilt lock, tilt tension control, internal ratchet back height adjustment, infinite back angle adjustment.

Multi Tilt w/Integrated Seat Slider - Heavy Duty Version

(4 paddles)
Swivels 360°, pneumatic cylinder seat height adjustment, seat and back tilt as unit, free floats in unlocked position, infinite position tilt lock, tilt tension control, internal ratchet back height adjustment, infinite back angle adjustment, side activated sliding seat pan.

Arm Options

Arm Pad Options



BAP Buzz arm pad (default pad if none specified except for ATS)



BT bullet arm pad

Back Panel Options

- SB** Standard upholstered back panel. **(DEFAULT)**
- BB** Ballistic nylon back – recommended *(no upcharge)*
- BP** Bumper back trim – recommended *(no upcharge)*
Choose from 6 colors. Refer to web site for selection.

Buzz Seating is not responsible for back panel wear or tear regardless of option chosen. For additional back wear protection, **BB** or **BP** is recommended. One option is provided without an additional upcharge. If both options are ordered a **45** list upcharge applies. Refer to web site for **BP** color selections.

DEFAULT IS SB UNLESS SPECIFIED OTHERWISE

Additional Options

MODEL#		ADD
CAL133	California Technical Bulletin 133	140
GLBG	Stationary bell glides (set of 5)	41
FR20	"Sure Grip" footring only	92
SP-HD	Stool package (350 lb. capacity) (Available on BC01HD only)	196

Warranty: Big & Tall Series

Standard published warranty terms and conditions apply with the following changes: 10 years on all components, 5 years on fabric and foam. If chairs are to be used for multi-shift applications which is defined as use exceeding 8 hours per day, 5 days per week, then multi-shift warranty applies: 5 years on components and 2 years on fabric and foam.

- Provides freedom of movement
- Heavy duty components
- Synchro mechanism
- Standard and heavy duty version
- Ballistic nylon
- Built to last
- Drop away arms
- Partial assembly required

Extended shipping time required.
*Ships in 2 boxes on a skid via LTL.



Chair Version
350 lb. capacity

350 lb. Capacity *All prices are LIST*

Model	Arm Options	Ballistic Nylon 3
SH04	<i>synchro/seat slider ratchet back</i> armless	1635
19-23.5" seat height range.		
	DA drop away	1760
	AL adj. loop	1825

Ships with 5 prong 27" nylon base, heavy duty CC01-HD hooded carpet casters and CY02-HD2 height cylinder



Chair Version
500 lb. capacity

500 lb. Capacity *All prices are LIST*

Model	Arm Options	Ballistic Nylon 3
SH04HD	<i>synchro/seat slider ratchet back</i> armless	2085
19-23.5" seat height range.		
	DA drop away	2210
	AL adj. loop	2275

Ships with 6 prong 27" steel base, MSSHD non-hooded multipurpose casters and CY02-SHD height cylinder

Ballistic Colors

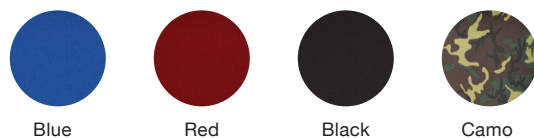

Actual dimensions will vary depending on model and options selected.

Dimensions:	seat width 22"	back width 22"
	seat depth 21"-23.5"	back height range 24"-29"
Weight:	approx. 59 lbs. chair	seat height range 19.5"-24"
	approx. 90 lbs. heavy duty chair	

TO ORDER , please specify:	model	arm	options	fabric color	price
EXAMPLE	SH04HD	DA	-	BLUE	2210

Mechanism Functions	Arm Options	Arm Pad	Back Panel Options																					
<p>Synchro Tilter - Heavy Duty Version (2 paddles) Swivels 360°, pneumatic cylinder seat height adjustment, synchronized tilt between seat and back, free floats in unlocked position, 4 position tilt lock, tilt tension control, internal 5" ratchet back height adjustment, integrated seat slider.</p>	<p>DA drop away</p> <p>AL adj. loop arm</p>	<p>BAP Buzz arm pad</p>	<p>BB Ballistic nylon back standard</p> <p>Buzz Seating is not responsible for back panel wear or tear.</p>																					
<p>Additional Options</p> <table border="1"> <thead> <tr> <th>MODEL#</th> <th></th> <th>ADD</th> </tr> </thead> <tbody> <tr> <td>CAL133</td> <td>California Technical Bulletin 133</td> <td>140</td> </tr> <tr> <td>GLBG</td> <td>Stationary bell glides (set of 5)</td> <td>41</td> </tr> <tr> <td>HC01-HD</td> <td>Hard floor heavy duty casters (set of 5) (SH04 only)</td> <td>75</td> </tr> <tr> <td>MSLC</td> <td>Self-braking hard floor casters brake when unoccupied (set of 5) (SH04 only)</td> <td>69</td> </tr> <tr> <td>MSRLC</td> <td>Self-braking hard floor casters brake when occupied (set of 5) (SH04 only)</td> <td>75</td> </tr> <tr> <td>PILLOW</td> <td>Lumbar Pillow</td> <td>175</td> </tr> </tbody> </table>				MODEL#		ADD	CAL133	California Technical Bulletin 133	140	GLBG	Stationary bell glides (set of 5)	41	HC01-HD	Hard floor heavy duty casters (set of 5) (SH04 only)	75	MSLC	Self-braking hard floor casters brake when unoccupied (set of 5) (SH04 only)	69	MSRLC	Self-braking hard floor casters brake when occupied (set of 5) (SH04 only)	75	PILLOW	Lumbar Pillow	175
MODEL#		ADD																						
CAL133	California Technical Bulletin 133	140																						
GLBG	Stationary bell glides (set of 5)	41																						
HC01-HD	Hard floor heavy duty casters (set of 5) (SH04 only)	75																						
MSLC	Self-braking hard floor casters brake when unoccupied (set of 5) (SH04 only)	69																						
MSRLC	Self-braking hard floor casters brake when occupied (set of 5) (SH04 only)	75																						
PILLOW	Lumbar Pillow	175																						

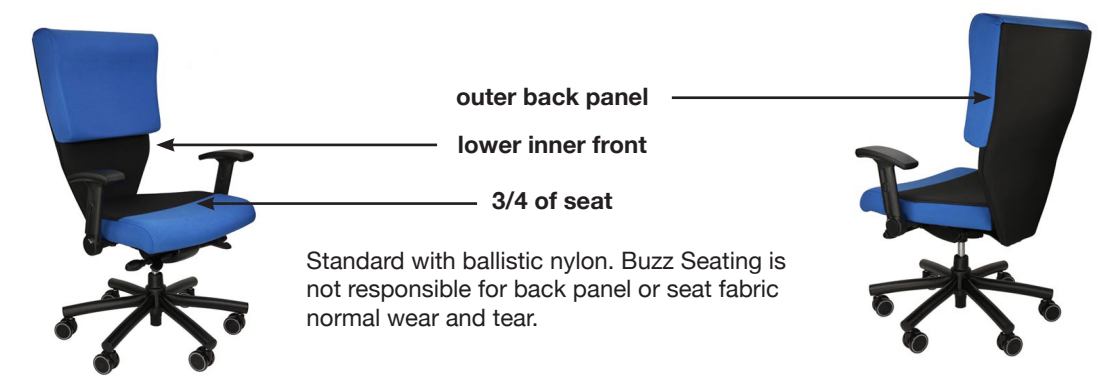

Warranty: Shield Series

Standard published warranty terms and conditions apply with the following changes: 10 years on all components, 5 years on fabric and foam. If chairs are to be used for multi-shift applications which is defined as use exceeding 8 hours per day, 5 days per week, then multi-shift warranty applies: 5 years on components and 2 years on fabric and foam.

Ships partially assembled.

Poly Mesh Back

350 lb. Capacity *All prices are LIST*

Model	Arm Options	Arm Pad Options (default pad in bold)	COM					
			1	2	3	4	5	6
PRM04HD <i>synchro tilt fixed back</i>	armless	-	855	875	895	915	945	985
	DA drop away	BAP , BT	980	1000	1020	1040	1070	1110
	VF fixed	-	960	980	1000	1020	1050	1090
	ATS adj. T	BAP , BT	980	1000	1020	1040	1070	1110
	ATS/AW adj. T	BAP , BT	995	1015	1035	1055	1085	1125
	MAT/AW multi-function	-	1055	1075	1095	1115	1145	1185

HIGHBACK



Upgrades include: Heavy duty mechanism
Heavy density seat foam with memory foam topper
Heavy duty pneumatic height cylinder

Ships with **CC07-SL** non-hooded carpet casters and **CY02-HD** height

Mechanism Functions

Synchro Tilter

(2 paddles)
Swivels 360°, pneumatic cylinder seat height adjustment, synchronized tilt between seat and back, free floats in unlocked position, 4 position tilt lock, tilt tension control.

Arm Pad Options



BAP Buzz arm pad (default pad if none specified except for ATS)



BT bullet arm pad (recommended & default for ATS)

Additional Options

MODEL#		ADD
CAL133	California Technical Bulletin 133	60
MF	Memory foam 1" top added to seat	105
EF	1" extra seat foam	46
SS (MESH)	Sliding seat depth adjustment (Not available on stools. AW (adj. width arm brackets) cannot be included if SS (sliding seat depth adjustment) is ordered)	87
GLBG	Stationary bell glides (set of 5)	41
HC07	Hard floor casters (set of 5)	46
*SP	Stool package includes 8" cylinder and "Sure Grip" footring. Seat height extends from 24"-32".	133
FR20	"Sure Grip" footring	92

*When converting to a stool, the tilt feature is disengaged by the factory before shipping.

Warranty: 24/7 Multi-Shift Series

Standard published warranty terms and conditions apply with the following changes: 5 years on all components and 2 years on fabric and foam.

Actual dimensions will vary depending on model and options selected.

Dimensions: seat width 21" back width 20.5"
seat depth 21" back height 22"
seat height from floor 16"-23"

Weight: approx. 40 lbs.

COM Requirements: 1 yard per chair

TO ORDER, please specify:

model	arm	arm pad	options	fabric pattern	fabric color	price
PRM04HD	ATS	BT	EF	ANCHORAGE	ONYX	1026



- Upholstered seat
- Infinite angle lock
- Tension adjustment

- Weight activated locking casters
- Partial assembly required



300 lb. Capacity *All prices are LIST*

Model		COM					
		1	2	3	4	5	6
PR00-CY05	10" cylinder only	885	900	915	930	950	980
PR00-XSP	10" cylinder and foot ring	980	995	1010	1025	1045	1075

Ships with **MSRLC** hooded multipurpose casters

Additional Options

MODEL#		ADD
CAL133	California Technical Bulletin 133	60
GLBG	Stationary bell glides (set of 5)	N/C



20" Footring

Actual dimensions will vary depending on model and options selected.

Dimensions: seat width 18"
seat depth 16"
seat height from floor 26"-36"

Weight: approx. 29 lbs.

COM Requirements: 1 yard per chair

TO ORDER, please specify:

model	options	fabric pattern	fabric color	price
PR00-XSP	GLBG	MOGULS	FLARE 2188	980





- For the person 4'10" or smaller
- Proportionally scaled seat and back
- Convex back
- 4" seat foam
- Soft and supple sit
- Partial assembly required

300 lb. Capacity All prices are LIST

Model	Arm Options	Arm Pad Options (default pad in bold)	COM					
			1	2	3	4	5	6
PRB01 <i>basic task fixed back</i>	armless	-	535	575	615	670	725	780
Use for basic task and minimal use situations. Simple adjustments.	DA drop away	BAP , BT	660	700	740	795	850	905
	VF fixed	-	640	680	720	775	830	885
	AT/AW adj. T	BAP , BT	660	700	740	795	850	905
	ATS adj. T	BAP , BT	660	700	740	795	850	905
	ATS/AW adj. T	BAP , BT	680	720	760	815	870	925
	MAT/AW multi-function	-	735	775	815	870	925	980

Ships with CC01 hooded carpet casters and CY01 height cylinder

PRB02 <i>swivel tilter ratchet back</i>	armless	-	580	620	660	715	770	825
Great for mid management, conference room and meeting applications. Simple adjustments.	DA drop away	BAP , BT	705	745	785	840	895	950
	VF fixed	-	685	725	765	820	875	930
	AT/AW adj. T	BAP , BT	705	745	785	840	895	950
	ATS adj. T	BAP , BT	705	745	785	840	895	950
	ATS/AW adj. T	BAP , BT	725	765	805	860	915	970
	MAT/AW multi-function	-	780	820	860	915	970	1025

Ships with CC01 hooded carpet casters and CY01 height cylinder

PRB03 <i>posture back ratchet back</i>	armless	-	645	685	725	780	835	890
Perfect for clerical use and tasking situations that require some adjustability. Ideal control for stools.	DA drop away	BAP , BT	770	810	850	905	960	1015
	VF fixed	-	750	790	830	885	940	995
	AT/AW adj. T	BAP , BT	770	810	850	905	960	1015
	ATS adj. T	BAP , BT	770	810	850	905	960	1015
	ATS/AW adj. T	BAP , BT	790	830	870	925	980	1035
	MAT/AW multi-function	-	845	885	925	980	1035	1090

Ships with CC01 hooded carpet casters and CY01 height cylinder

Actual dimensions will vary depending on model and options selected.
Dimensions: seat width 16" seat height from floor 16" back width 16"
 seat depth 14" 14"-17" back height 19"-22"
Weight: 45 lbs.
COM Requirements: 2 yards per chair



TO ORDER, please specify:	model	arm	arm pad	back panel	options	fabric pattern	fabric color	price
EXAMPLE	PRB03	AT/AW	BAP	SB	MF	MOGULS	FLARE 2188	875

NOTE: *Pronto Bantam ships standard with a CY01 lower seat height 3" travel cylinder. Optional 5" travel CY02 available without upcharge and must be specified.*

Mechanism Functions

Basic Task
(1 paddle)
Swivels 360°, pneumatic cylinder seat height adjustment, back depth adjustment.

Swivel Tilter
(1 paddle)
Swivels 360°, pneumatic cylinder seat height adjustment, seat and back tilt as unit, tilt tension control, tilt free floats or locks in upright position, internal ratchet back height adjustment.

Posture Back
(2 paddles)
Swivels 360°, pneumatic cylinder seat height adjustment, infinite back angle adjustment, internal ratchet back height adjustment.

Arm Options

DA drop away

VF fixed
chrome with soft urethane pad

AT/AW adj. T includes height and width adjustment

ATS adj. T height adjustment

ATS/AW adj. T includes height and width adjustment

MAT/AW multi-function (no arm pad option)

Arm Pad Options

BAP Buzz arm pad (default pad if none specified except for ATS)

BT bullet arm pad

Back Panel Options

SB Standard upholstered back panel. **(DEFAULT)**

BB Ballistic nylon back – recommended *(no upcharge)*

BP Bumper back trim – recommended *(no upcharge)*
Choose from 6 colors. Refer to web site for selection.

Buzz Seating is not responsible for back panel wear or tear regardless of option chosen. For additional back wear protection, **BB** or **BP** is recommended. One option is provided without an additional upcharge. If both options are ordered a 45 list upcharge applies. Refer to web site for **BP** color selections.

DEFAULT IS SB UNLESS SPECIFIED OTHERWISE

Additional Options

MODEL#		ADD
CAL133	California Technical Bulletin 133	115
MF	1" layer memory foam over upgraded high density foam seat	105
EF	1" extra seat foam	46
SS	Sliding seat depth adjustment (not available with PRB01 , PRB02 and stools)	98
GLBG	Stationary bell glides (set of 5)	41
HC01	Hard floor/multisurface casters (set of 5)	41
MSLC	Self-braking hard floor casters brake when unoccupied (set of 5)	69
MSRLC	Self-braking hard floor casters brake when occupied (set of 5)	75
FR20	"Sure Grip" footring	92
ESD	Electrostatic dissipation. Dissipates static electricity from chair. Includes conductive fabric, conductive casters. *Specify hard floor or carpet casters	Gr 6 +144

FOOTNOTE:
****AW** (adj. width arm brackets) cannot be included with **PRB03** series if **SS** (sliding seat depth adjustment) is ordered.



- For the person 4'10" or smaller
- Proportionally scaled seat and back
- Convex back
- 4" seat foam
- Soft and supple sit
- Partial assembly required

300 lb. Capacity All prices are LIST

Model	Arm Options	Arm Pad Options (default pad in bold)	COM						Upholstery Grade
			1	2	3	4	5	6	
PRB04 <i>synchro tilter ratchet back</i>	armless	-	645	685	725	780	835	890	
Smooth and simple ride. Synchronized movement between seat and back. Any application. **AW (adj. width arm brackets) cannot be included with PRB24 series if SS (sliding seat depth adjustment) is ordered.	DA drop away	BAP, BT	770	810	850	905	960	1015	
	VF fixed	-	750	790	830	885	940	995	
	AT/AW adj. T	BAP, BT	770	810	850	905	960	1015	
	ATS adj. T	BAP, BT	770	810	850	905	960	1015	
	ATS/AW adj. T	BAP, BT	790	830	870	925	980	1035	
	MAT/AW multi-function	-	845	885	925	980	1035	1090	

Ships with CC01 hooded carpet casters and CY01 height cylinder

PRB08 <i>multi tilter ratchet back</i>	armless	-	785	825	865	920	975	1030	
Use in applications that require maximum adjustability. Multipurpose full 6 function ergonomic control. Recommended for its infinite range and ease of adjustments.	DA drop away	BAP, BT	910	950	990	1045	1100	1155	
	VF fixed	-	890	930	970	1025	1080	1135	
	AT/AW adj. T	BAP, BT	910	950	990	1045	1100	1155	
	ATS adj. T	BAP, BT	910	950	990	1045	1100	1155	
	ATS/AW adj. T	BAP, BT	930	970	1010	1065	1120	1175	
	MAT/AW multi-function	-	985	1025	1065	1120	1175	1230	

Ships with CC01 hooded carpet casters and CY01 height cylinder

Most popular (recommended)

PRB09 <i>multi tilt ratchet back integrated seat slider</i>	armless	-	810	850	890	945	1000	1055	
Perfect for any application. An all inclusive control at a value price. Includes an internal ratchet back height adjustment and seat slider.	DA drop away	BAP, BT	935	975	1015	1070	1125	1180	
	VF fixed	-	915	955	995	1050	1105	1160	
	AT adj. T	BAP, BT	935	975	1015	1070	1125	1180	
	ATS adj. T	BAP, BT	935	975	1015	1070	1125	1180	
	MAT multi-function	-	1010	1050	1090	1145	1200	1255	

Ships with CC01 hooded carpet casters and CY01 height cylinder

Actual dimensions will vary depending on model and options selected.
Dimensions: seat width 16" seat height from floor 14"-17" back width 16" back height 19"-22"
 seat depth 14" back height 19"-22"
Weight: 45 lbs.
COM Requirements: 2 yards per chair



TO ORDER, please specify:	model	arm	arm pad	back panel	options	fabric pattern	fabric color	price
EXAMPLE	PRB08	DA	BAP	BB	-	MOGULS	FLARE 2188	910

NOTE: Pronto Bantam ships standard with a CY01 lower seat height 3" travel cylinder. Optional 5" travel CY02 available without upcharge and must be specified.

Mechanism Functions

Synchro Tilter
(2 paddles)
Swivels 360°, pneumatic cylinder seat height adjustment, synchronized tilt between seat and back, free floats in unlocked position, 3 position tilt lock, tilt tension control, internal ratchet back height adjustment.

DA drop away

VF fixed
chrome with soft urethane pad

AT/AW adj. T includes height and width adjustment

ATS adj. T height adjustment

ATS/AW adj. T includes height and width adjustment

MAT/AW multi-function
(no arm pad option)

Arm Options

Arm Pad Options

BAP Buzz arm pad (default pad if none specified except for ATS)

BT bullet arm pad

Back Panel Options

SB Standard upholstered back panel. **(DEFAULT)**

BB Ballistic nylon back – recommended *(no upcharge)*

BP Bumper back trim – recommended *(no upcharge)*
Choose from 6 colors. Refer to web site for selection.

Buzz Seating is not responsible for back panel wear or tear regardless of option chosen. For additional back wear protection, **BB** or **BP** is recommended. One option is provided without an additional upcharge. If both options are ordered a 45 list upcharge applies. Refer to web site for **BP** color selections.

DEFAULT IS SB UNLESS SPECIFIED OTHERWISE

Additional Options

MODEL#		ADD
CAL133	California Technical Bulletin 133	115
MF	1" layer memory foam over upgraded high density foam seat	105
EF	1" extra seat foam	46
SS	Sliding seat depth adjustment (not available with PRB08 & stools)	98
GLBG	Stationary bell glides (set of 5)	41
HC01	Hard floor/multisurface casters (set of 5)	41
MSLC	Self-braking hard floor casters brake when unoccupied (set of 5)	69
MSRLC	Self-braking hard floor casters brake when occupied (set of 5)	75
FR20	"Sure Grip" footing	92
ESD	Electrostatic dissipation. Dissipates static electricity from chair. Includes conductive fabric, conductive casters. *Specify hard floor or carpet casters	Gr 6 +144

FOOTNOTE:
**** AW** (adj. width arm brackets) cannot be included with **PRB08** series if SS (sliding seat depth adjustment) is ordered.



- Sized for the petite individual
- Proportionally scaled seat and back
- Convex back
- 4" seat foam
- Soft and supple sit
- Partial assembly required

300 lb. Capacity All prices are LIST

Model	Arm Options	Arm Pad Options (default pad in bold)	COM Upholstery Grade					
			1	2	3	4	5	6
PRP01 <i>basic task fixed back</i>	armless	-	545	585	625	680	735	790
Use for basic task and minimal use situations. Simple adjustments.	DA drop away	BAP , BT	670	710	750	805	860	915
	VF fixed	-	650	690	730	785	840	895
Stool options available on PRP01	AT/AW adj. T	BAP , BT	670	710	750	805	860	915
	ATS adj. T	BAP , BT	670	710	750	805	860	915
	ATS/AW adj. T	BAP , BT	690	730	770	825	880	935
	MAT/AW multi-function	-	745	785	825	880	935	990

Ships with CC01 hooded carpet casters and CY01 height cylinder

PRP02 <i>swivel tilter ratchet back</i>	armless	-	590	630	670	725	780	835
Great for mid management, conference room and meeting applications. Simple adjustments.	DA drop away	BAP , BT	715	755	795	850	905	960
	VF fixed	-	695	735	775	830	885	940
Stool options available on PRP02	AT/AW adj. T	BAP , BT	715	755	795	850	905	960
	ATS adj. T	BAP , BT	715	755	795	850	905	960
	ATS/AW adj. T	BAP , BT	735	775	815	870	925	980
	MAT/AW multi-function	-	790	830	870	925	980	1035

Ships with CC01 hooded carpet casters and CY01 height cylinder

PRP03 <i>posture back ratchet back</i>	armless	-	655	695	735	790	845	900
Perfect for clerical use and tasking situations that require some adjustability. Ideal control for stools.	DA drop away	BAP , BT	780	820	860	915	970	1025
	VF fixed	-	760	800	840	895	950	1005
Stool options available on PRP03	AT/AW adj. T	BAP , BT	780	820	860	915	970	1025
	ATS adj. T	BAP , BT	780	820	860	915	970	1025
	ATS/AW adj. T	BAP , BT	800	840	880	935	990	1045
MAT/AW multi-function	-	855	895	935	990	1045	1100	

Ships with CC01 hooded carpet casters and CY01 height cylinder

Actual dimensions will vary depending on model and options selected.

Dimensions: seat width 18" seat height from floor back width 17"
 seat depth 16" 15.5"-19" back height 19"-22"

Weight: 47 lbs.

COM Requirements: 2 yards per chair



TO ORDER, please specify:	model	arm	arm pad	back panel	options	fabric pattern	fabric color	price
EXAMPLE	PRP01	AT/AW	BAP	SB	SP	MOGULS	FLARE 2188	803

NOTE: Pronto Petite ships standard with a CY01 lower seat height 3" travel cylinder. Optional 5" travel CY02 available without upcharge and must be specified.

Mechanism Functions	Arm Options	Arm Pad Options	Back Panel Options																																							
<p>Basic Task (1 paddle) Swivels 360°, pneumatic cylinder seat height adjustment, back depth adjustment.</p> <p>DA drop away</p>	<p>DA drop away</p>	<p>BAP Buzz arm pad (default pad if none specified except for ATS)</p>	<p>SB Standard upholstered back panel. (DEFAULT)</p> <p>BB Ballistic nylon back – recommended <i>(no upcharge)</i></p> <p>BP Bumper back trim – recommended <i>(no upcharge)</i> Choose from 6 colors. Refer to web site for selection.</p> <p>Buzz Seating is not responsible for back panel wear or tear regardless of option chosen. For additional back wear protection, BB or BP is recommended. One option is provided without an additional upcharge. If both options are ordered a 45 list upcharge applies. Refer to web site for BP color selections.</p> <p>DEFAULT IS SB UNLESS SPECIFIED OTHERWISE</p>																																							
<p>Swivel Tilter (1 paddle) Swivels 360°, pneumatic cylinder seat height adjustment, seat and back tilt as unit, tilt tension control, tilt free floats or locks in upright position, internal ratchet back height adjustment.</p> <p>AT/AW adj. T includes height and width adjustment</p>	<p>VF fixed chrome with soft urethane pad</p>	<p>BT bullet arm pad</p>	<p>Additional Options</p> <table border="1"> <thead> <tr> <th>MODEL#</th> <th></th> <th>ADD</th> </tr> </thead> <tbody> <tr> <td>CAL133</td> <td>California Technical Bulletin 133</td> <td>115</td> </tr> <tr> <td>MF</td> <td>1" layer memory foam over upgraded high density foam seat</td> <td>105</td> </tr> <tr> <td>EF</td> <td>1" extra seat foam</td> <td>46</td> </tr> <tr> <td>SS</td> <td>Sliding seat depth adjustment (not available with PRP01, PRP02 & stools)</td> <td>98</td> </tr> <tr> <td>GLBG</td> <td>Stationary bell glides (set of 5)</td> <td>41</td> </tr> <tr> <td>HC01</td> <td>Hard floor/multisurface casters (set of 5)</td> <td>41</td> </tr> <tr> <td>MSLC</td> <td>Self-braking hard floor casters brake when unoccupied (set of 5)</td> <td>69</td> </tr> <tr> <td>MSRLC</td> <td>Self-braking hard floor casters brake when occupied (set of 5)</td> <td>75</td> </tr> <tr> <td>SP</td> <td>Stool package (with PRP01, PRP03 controls only). Includes 8" cylinder and "Sure Grip" footring. Seat height extends from 20"-28".</td> <td>133</td> </tr> <tr> <td>XSP</td> <td>Ext. stool package (with PRP01, PRP03 controls only). Includes 10" cylinder and "Sure Grip" footring. Seat height extends from 22"-32".</td> <td>156</td> </tr> <tr> <td>FR20</td> <td>"Sure Grip" footring</td> <td>92</td> </tr> <tr> <td>ESD</td> <td>Electrostatic dissipation. Dissipates static electricity from chair. Includes conductive fabric, conductive casters. *Specify hard floor or carpet casters</td> <td>Gr 6 +144</td> </tr> </tbody> </table>	MODEL#		ADD	CAL133	California Technical Bulletin 133	115	MF	1" layer memory foam over upgraded high density foam seat	105	EF	1" extra seat foam	46	SS	Sliding seat depth adjustment (not available with PRP01 , PRP02 & stools)	98	GLBG	Stationary bell glides (set of 5)	41	HC01	Hard floor/multisurface casters (set of 5)	41	MSLC	Self-braking hard floor casters brake when unoccupied (set of 5)	69	MSRLC	Self-braking hard floor casters brake when occupied (set of 5)	75	SP	Stool package (with PRP01 , PRP03 controls only). Includes 8" cylinder and "Sure Grip" footring. Seat height extends from 20"-28".	133	XSP	Ext. stool package (with PRP01 , PRP03 controls only). Includes 10" cylinder and "Sure Grip" footring. Seat height extends from 22"-32".	156	FR20	"Sure Grip" footring	92	ESD	Electrostatic dissipation. Dissipates static electricity from chair. Includes conductive fabric, conductive casters. *Specify hard floor or carpet casters	Gr 6 +144
MODEL#		ADD																																								
CAL133	California Technical Bulletin 133	115																																								
MF	1" layer memory foam over upgraded high density foam seat	105																																								
EF	1" extra seat foam	46																																								
SS	Sliding seat depth adjustment (not available with PRP01 , PRP02 & stools)	98																																								
GLBG	Stationary bell glides (set of 5)	41																																								
HC01	Hard floor/multisurface casters (set of 5)	41																																								
MSLC	Self-braking hard floor casters brake when unoccupied (set of 5)	69																																								
MSRLC	Self-braking hard floor casters brake when occupied (set of 5)	75																																								
SP	Stool package (with PRP01 , PRP03 controls only). Includes 8" cylinder and "Sure Grip" footring. Seat height extends from 20"-28".	133																																								
XSP	Ext. stool package (with PRP01 , PRP03 controls only). Includes 10" cylinder and "Sure Grip" footring. Seat height extends from 22"-32".	156																																								
FR20	"Sure Grip" footring	92																																								
ESD	Electrostatic dissipation. Dissipates static electricity from chair. Includes conductive fabric, conductive casters. *Specify hard floor or carpet casters	Gr 6 +144																																								
<p>Posture Back (2 paddles) Swivels 360°, pneumatic cylinder seat height adjustment, infinite back angle adjustment, internal ratchet back height adjustment.</p> <p>ATS adj. T height adjustment</p> <p>ATS/AW adj. T includes height and width adjustment</p> <p>MAT/AW multi-function (no arm pad option)</p>	<p>AT/AW adj. T includes height and width adjustment</p>	<p>MAT/AW multi-function (no arm pad option)</p>	<p>FOOTNOTE: ** AW (adj. width arm brackets) cannot be included with PRP03 series if SS (sliding seat depth adjustment) is ordered.</p>																																							



- Sized for the petite individual
- Proportionally scaled seat and back
- Convex back
- 4" seat foam
- Soft and supple sit
- Partial assembly required

300 lb. Capacity All prices are LIST

Model	Arm Options	Arm Pad Options (default pad in bold)	COM						Upholstery Grade
			1	2	3	4	5	6	
PRP04 <i>synchro tilter ratchet back</i>	armless	-	655	695	735	790	845	900	
Smooth and simple ride. Synchronized movement between seat and back. Any application. **AW (adj. width arm brackets) cannot be included with PRP04 series if SS (sliding seat depth adjustment) is ordered.	DA drop away	BAP, BT	780	820	860	915	970	1025	
	VF fixed	-	760	800	840	895	950	1005	
	AT/AW adj. T	BAP, BT	780	820	860	915	970	1025	
	ATS adj. T	BAP, BT	780	820	860	915	970	1025	
	ATS/AW adj. T	BAP, BT	800	840	880	935	990	1045	
	MAT/AW multi-function	-	855	895	935	990	1045	1100	

Ships with CC01 hooded carpet casters and CY01 height cylinder

Model	Arm Options	Arm Pad Options (default pad in bold)	COM					
			1	2	3	4	5	6
PRP08 <i>multi tilter ratchet back</i>	armless	-	795	835	875	930	985	1040
Use in applications that require maximum adjustability. Multipurpose full 6 function ergonomic control. Recommended for its infinite range and ease of adjustments.	DA drop away	BAP, BT	920	960	1000	1055	1110	1165
	VF fixed	-	900	940	980	1035	1090	1145
	AT/AW adj. T	BAP, BT	920	960	1000	1055	1110	1165
	ATS adj. T	BAP, BT	920	960	1000	1055	1110	1165
	ATS/AW adj. T	BAP, BT	940	980	1020	1075	1130	1185
	MAT/AW multi-function	-	995	1035	1075	1130	1185	1240

Ships with CC01 hooded carpet casters and CY01 height cylinder

Most popular (recommended)

Model	Arm Options	Arm Pad Options (default pad in bold)	COM					
			1	2	3	4	5	6
PRP09 <i>multi tilt ratchet back integrated seat slider</i>	armless	-	820	860	900	955	1010	1065
Perfect for any application. An all inclusive control at a value price. Includes an internal ratchet back height adjustment and seat slider.	DA drop away	BAP, BT	945	985	1025	1080	1135	1190
	VF fixed	-	925	965	1005	1060	1115	1170
	AT adj. T	BAP, BT	945	985	1025	1080	1135	1190
	ATS adj. T	BAP, BT	945	985	1025	1080	1135	1190
	MAT multi-function	-	1020	1060	1100	1155	1210	1265

Ships with CC01 hooded carpet casters and CY01 height cylinder

Actual dimensions will vary depending on model and options selected.
Dimensions: seat width 18" seat height from floor back width 17"
 seat depth 16" 15.5"-19" back height 19"-22"
Weight: 47 lbs.
COM Requirements: 2 yards per chair



TO ORDER , please specify:	model	arm	arm pad	back panel	options	fabric pattern	fabric color	price
EXAMPLE	PRP08	DA	BAP	SB	EF	MOGULS	FLARE 2188	966

NOTE: Pronto Petite ships standard with a CY01 lower seat height 3" travel cylinder. Optional 5" travel CY02 available without upcharge and must be specified.

Mechanism Functions	Arm Options	Arm Pad Options	Back Panel Options
---------------------	-------------	-----------------	--------------------

Synchro Tilter
(2 paddles)
Swivels 360°, pneumatic cylinder seat height adjustment, synchronized tilt between seat and back, free floats in unlocked position, 3 position tilt lock, tilt tension control, internal ratchet back height adjustment.



Multi Tilter
(3 paddles)
Swivels 360°, pneumatic cylinder seat height adjustment, seat and back tilt as unit, free floats in unlocked position, infinite position tilt lock, tilt tension control, internal ratchet back height adjustment, infinite back angle adjustment.

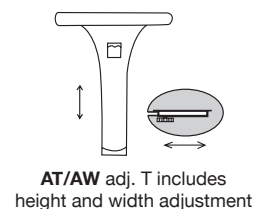

Multi Tilt w/Integrated Seat Slider
(4 paddles)
Swivels 360°, pneumatic cylinder seat height adjustment, seat and back tilt as unit, free floats in unlocked position, infinite position tilt lock, tilt tension control, internal ratchet back height adjustment, infinite back angle adjustment, side activated sliding seat pan.

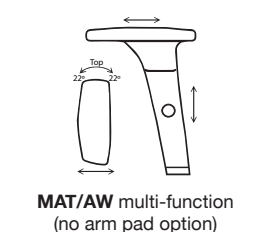
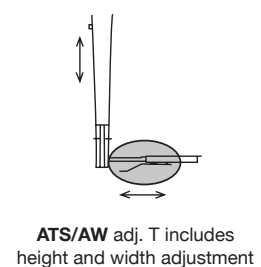
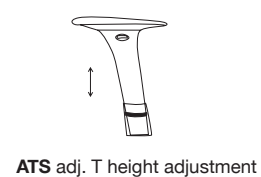

SB Standard upholstered back panel. **(DEFAULT)**
BB Ballistic nylon back – recommended (no upcharge)
BP Bumper back trim – recommended (no upcharge) Choose from 6 colors. Refer to web site for selection.
 Buzz Seating is not responsible for back panel wear or tear regardless of option chosen. For additional back wear protection, **BB** or **BP** is recommended. One option is provided without an additional upcharge. If both options are ordered a 45 list upcharge applies. Refer to web site for **BP** color selections.

DEFAULT IS SB UNLESS SPECIFIED OTHERWISE

Additional Options

MODEL#	ADD
CAL133 California Technical Bulletin 133	115
MF 1" layer memory foam over upgraded high density foam seat	105
EF 1" extra seat foam	46
SS Sliding seat depth adjustment (not available with PRP08 & stools)	98
GLBG Stationary bell glides (set of 5)	41
HC01 Hard floor/multisurface casters (set of 5)	41
MSLC Self-braking hard floor casters brake when unoccupied (set of 5)	69
MSRLC Self-braking hard floor casters brake when occupied (set of 5)	75
FR20 "Sure Grip" footing	92
ESD Electrostatic dissipation. Dissipates static electricity from chair. Includes conductive fabric, conductive casters. *Specify hard floor or carpet casters	Gr 6 +144

FOOTNOTE:
 ** AW (adj. width arm brackets) cannot be included with PRP04 series if SS (sliding seat depth adjustment) is ordered.



- Accommodates most individuals as a mid-sized chair
- Proportionally scaled seat and back
- Convex back
- 4" seat foam
- Soft and supple sit
- Partial assembly required

300 lb. Capacity All prices are LIST

Model	Arm Options	Arm Pad Options (default pad in bold)	COM					
			1	2	3	4	5	6
PRMB01 <i>basic task fixed back</i>	armless	-	565	605	645	700	755	810
Use for basic task and minimal use situations. Simple adjustments.	DA drop away	BAP , BT	690	730	770	825	880	935
	VF fixed	-	670	710	750	805	860	915
Stool options available on PRMB01	AT/AW adj. T	BAP , BT	690	730	770	825	880	935
	ATS adj. T	BAP , BT	690	730	770	825	880	935
	ATS/AW adj. T	BAP , BT	710	750	790	845	900	955
	MAT/AW multi-function	-	765	805	845	900	955	1010

Ships with CC01 hooded carpet casters and CY02 height cylinder

PRMB02 <i>swivel tilter ratchet back</i>	armless	-	610	650	690	745	800	855
Great for mid management, conference room and meeting applications. Simple adjustments.	DA drop away	BAP , BT	735	775	815	870	925	980
	VF fixed	-	715	755	795	850	905	960
Stool options available on PRMB02	AT/AW adj. T	BAP , BT	735	775	815	870	925	980
	ATS adj. T	BAP , BT	735	775	815	870	925	980
	ATS/AW adj. T	BAP , BT	755	795	835	890	945	1000
	MAT/AW multi-function	-	810	850	890	945	1000	1055

Ships with CC01 hooded carpet casters and CY02 height cylinder

PRMB03 <i>posture back ratchet back</i>	armless	-	675	715	755	810	865	920
Perfect for clerical use and tasking situations that require some adjustability. Ideal control for stools.	DA drop away	BAP , BT	800	840	880	935	990	1045
	VF fixed	-	780	820	860	915	970	1025
Stool options available on PRMB03	AT/AW adj. T	BAP , BT	800	840	880	935	990	1045
	ATS adj. T	BAP , BT	800	840	880	935	990	1045
	ATS/AW adj. T	BAP , BT	820	860	900	955	1010	1065
MAT/AW multi-function	-	875	915	955	1010	1065	1120	

Ships with CC01 hooded carpet casters and CY02 height cylinder

Actual dimensions will vary depending on model and options selected.

Dimensions: seat width 21" seat height from floor 16"-21" back width 20" back height 20.5"-23.5"

Weight: 49 lbs.

COM Requirements: 2 yards per chair



TO ORDER, please specify:	model	arm	arm pad	back panel	options	fabric pattern	fabric color	price
EXAMPLE	PRMB02	VF	-	SB	-	MOGULS	FLARE 2188	715

Mechanism Functions

Basic Task
(1 paddle)
Swivels 360°, pneumatic cylinder seat height adjustment, back depth adjustment.

Swivel Tilter
(1 paddle)
Swivels 360°, pneumatic cylinder seat height adjustment, seat and back tilt as unit, tilt tension control, tilt free floats or locks in upright position, internal ratchet back height adjustment.

Posture Back
(2 paddles)
Swivels 360°, pneumatic cylinder seat height adjustment, infinite back angle adjustment, internal ratchet back height adjustment.

Arm Options

DA drop away

VF fixed
chrome with soft urethane pad

AT/AW adj. T includes height and width adjustment

ATS adj. T height adjustment

ATS/AW adj. T includes height and width adjustment

MAT/AW multi-function
(no arm pad option)

Arm Pad Options

BAP Buzz arm pad
(default pad if none specified except for ATS)

BT bullet arm pad

Back Panel Options

SB Standard upholstered back panel. **(DEFAULT)**

BB Ballistic nylon back – recommended *(no upcharge)*

BP Bumper back trim – recommended *(no upcharge)*
Choose from 6 colors. Refer to web site for selection.

Buzz Seating is not responsible for back panel wear or tear regardless of option chosen. For additional back wear protection, **BB** or **BP** is recommended. One option is provided without an additional upcharge. If both options are ordered a 45 list upcharge applies. Refer to web site for **BP** color selections.

DEFAULT IS SB UNLESS SPECIFIED OTHERWISE

Additional Options

MODEL#		ADD
CAL133	California Technical Bulletin 133	115
MF	1" layer memory foam over upgraded high density foam seat	105
EF	1" extra seat foam	46
SS	Sliding seat depth adjustment (not available with PRMB01 , PRMB02 & stools)	98
GLBG	Stationary bell glides (set of 5)	41
HC01	Hard floor/multisurface casters (set of 5)	41
MSLC	Self-braking hard floor casters brake when unoccupied (set of 5)	69
MSRLC	Self-braking hard floor casters brake when occupied (set of 5)	75
SP	Stool package (with PRMB01 , PRMB03 controls only). Includes 8" cylinder and "Sure Grip" footing. Seat height extends from 20"-28".	133
XSP	Ext. stool package (with PRMB01 , PRMB03 controls only). Includes 10" cylinder and "Sure Grip" footing. Seat height extends from 22"-32".	156
FR20	"Sure Grip" footing	92
ESD	Electrostatic dissipation. Dissipates static electricity from chair. Includes conductive fabric, conductive casters. *Specify hard floor or carpet casters	Gr 6 +144
THORBACK	Thoracic back (with PRMB03 only)	105



- Accommodates most individuals as a mid-sized chair
- Proportionally scaled seat and back
- Convex back
- 4" seat foam
- Soft and supple sit
- Partial assembly required

300 lb. Capacity All prices are LIST

Model	Arm Options	Arm Pad Options (default pad in bold)	COM						Upholstery Grade
			1	2	3	4	5	6	
PRMB04 <i>synchro tilter ratchet back</i>	armless	-	675	715	755	810	865	920	
Smooth and simple ride. Synchronized movement between seat and back. Any application. **AW (adj. width arm brackets) cannot be included with PRMB04 series if SS (sliding seat depth adjustment) is ordered.	DA drop away	BAP , BT	800	840	880	935	990	1045	
	VF fixed	-	780	820	860	915	970	1025	
	AT/AW adj. T	BAP , BT	800	840	880	935	990	1045	
	ATS adj. T	BAP , BT	800	840	880	935	990	1045	
	ATS/AW adj. T	BAP , BT	820	860	900	955	1010	1065	
	MAT/AW multi-function	-	875	915	955	1010	1065	1120	

Ships with CC01 hooded carpet casters and CY02 height cylinder

Model	Arm Options	Arm Pad Options (default pad in bold)	COM					
			1	2	3	4	5	6
PRMB08 <i>multi tilter ratchet back</i>	armless	-	815	855	895	950	1005	1060
Use in applications that require maximum adjustability. Multipurpose full 6 function ergonomic control. Recommended for its infinite range and ease of adjustments.	DA drop away	BAP , BT	940	980	1020	1075	1130	1185
	VF fixed	-	920	960	1000	1055	1110	1165
	AT/AW adj. T	BAP , BT	940	980	1020	1075	1130	1185
	ATS adj. T	BAP , BT	940	980	1020	1075	1130	1185
	ATS/AW adj. T	BAP , BT	960	1000	1040	1095	1150	1205
	MAT/AW multi-function	-	1015	1055	1095	1150	1205	1260

Ships with CC01 hooded carpet casters and CY02 height cylinder

Most popular (recommended)

Model	Arm Options	Arm Pad Options (default pad in bold)	COM					
			1	2	3	4	5	6
PRMB09 <i>multi tilt ratchet back integrated seat slider</i>	armless	-	840	880	920	975	1030	1085
Perfect for any application. An all inclusive control at a value price. Includes an internal ratchet back height adjustment and seat slider.	DA drop away	BAP , BT	965	1005	1045	1100	1155	1210
	VF fixed	-	945	985	1025	1080	1135	1190
	AT/AW adj. T	BAP , BT	965	1005	1045	1100	1155	1210
	ATS adj. T	BAP , BT	965	1005	1045	1100	1155	1210
	ATS/AW adj. T	BAP , BT	985	1025	1065	1120	1175	1230
	MAT/AW multi-function	-	1040	1080	1120	1175	1230	1285

Ships with CC01 hooded carpet casters and CY02 height cylinder

Actual dimensions will vary depending on model and options selected.

Dimensions: seat width 21" seat height from floor 16"-21" back width 20" back height 20.5"-23.5"

Weight: 49 lbs.

COM Requirements: 2 yards per chair



TO ORDER , please specify:	model	arm	arm pad	back panel	options	fabric pattern	fabric color	price
EXAMPLE	PRMB09	ATS	BT	SB	MF	MOGULS	FLARE 2188	1070

Mechanism Functions

Synchro Tilter
(2 paddles)
Swivels 360°, pneumatic cylinder seat height adjustment, synchronized tilt between seat and back, free floats in unlocked position, 3 position tilt lock, tilt tension control, internal ratchet back height adjustment.

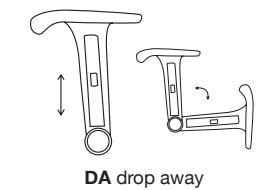

DA drop away

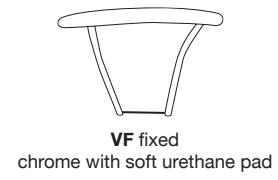

VF fixed chrome with soft urethane pad

Multi Tilter
(3 paddles)
Swivels 360°, pneumatic cylinder seat height adjustment, seat and back tilt as unit, free floats in unlocked position, infinite position tilt lock, tilt tension control, internal ratchet back height adjustment, infinite back angle adjustment.

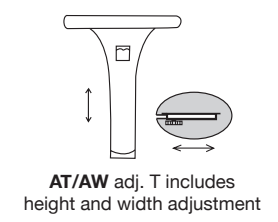

AT/AW adj. T includes height and width adjustment

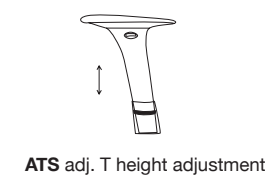

ATS adj. T height adjustment

Multi Tilt w/Integrated Seat Slider
(4 paddles)
Swivels 360°, pneumatic cylinder seat height adjustment, seat and back tilt as unit, free floats in unlocked position, infinite position tilt lock, tilt tension control, internal ratchet back height adjustment, infinite back angle adjustment, side activated sliding seat pan.

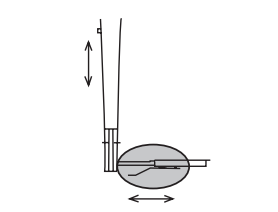

AT/AW adj. T includes height and width adjustment

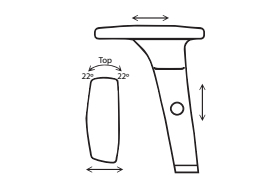

MAT/AW multi-function (no arm pad option)

Arm Options

Arm Pad Options



BAP Buzz arm pad (default pad if none specified except for ATS)



BT bullet arm pad

Back Panel Options

- SB** Standard upholstered back panel. **(DEFAULT)**
 - BB** Ballistic nylon back – recommended *(no upcharge)*
 - BP** Bumper back trim – recommended *(no upcharge)* Choose from 6 colors. Refer to web site for selection.
- Buzz Seating is not responsible for back panel wear or tear regardless of option chosen. For additional back wear protection, **BB** or **BP** is recommended. One option is provided without an additional upcharge. If both options are ordered a 45 list upcharge applies. Refer to web site for **BP** color selections.
- DEFAULT IS SB UNLESS SPECIFIED OTHERWISE**

Additional Options

MODEL#	ADD
CAL133 California Technical Bulletin 133	115
MF 1" layer memory foam over upgraded high density foam seat	105
EF 1" extra seat foam	46
SS Sliding seat depth adjustment (not available with PRMB08 & stools)	98
GLBG Stationary bell glides (set of 5)	41
HC01 Hard floor/multisurface casters (set of 5)	41
MSLC Self-braking hard floor casters brake when unoccupied (set of 5)	69
MSRLC Self-braking hard floor casters brake when occupied (set of 5)	75
FR20 "Sure Grip" footing	92
ESD Electrostatic dissipation. Dissipates static electricity from chair. Includes conductive fabric, conductive casters. *Specify hard floor or carpet casters	Gr 6 +144
LINBACK Linear back shape width 20"/height 20.5"-23.5" (PRMB04 Only)	N/C
THORBACK Thoracic back (with PRMB09 only)	105

Pronto Highback Series



- Designed for the larger sized individual as a high back chair
- Proportionally scaled seat and back
- Convex back
- 4" seat foam
- Soft and supple sit
- Partial assembly required

300 lb. Capacity All prices are LIST

Model	Arm Options	Arm Pad Options (default pad in bold)	COM						Upholstery Grade
			1	2	3	4	5	6	
PRHB01 <i>basic task fixed back</i>	armless	-	645	685	725	780	835	890	
Use for basic task and minimal use situations. Simple adjustments.	DA drop away	BAP, BT	770	810	850	905	960	1015	
	VF fixed	-	750	790	830	885	940	995	
Stool options available on PRHB01	AT/AW adj. T	BAP, BT	770	810	850	905	960	1015	
	ATS adj. T	BAP, BT	770	810	850	905	960	1015	
	ATS/AW adj. T	BAP, BT	790	830	870	925	980	1035	
	MAT/AW multi-function	-	845	885	925	980	1035	1090	

Ships with CC01 hooded carpet casters and CY02 height cylinder

PRHB02 <i>swivel tilter ratchet back</i>	armless	-	690	730	770	825	880	935	
Great for mid management, conference room and meeting applications. Simple adjustments.	DA drop away	BAP, BT	815	855	895	950	1005	1060	
	VF fixed	-	795	835	875	930	985	1040	
Stool options available on PRHB02	AT/AW adj. T	BAP, BT	815	855	895	950	1005	1060	
	ATS adj. T	BAP, BT	815	855	895	950	1005	1060	
	ATS/AW adj. T	BAP, BT	835	875	915	970	1025	1080	
	MAT/AW multi-function	-	890	930	970	1025	1080	1135	

Ships with CC01 hooded carpet casters and CY02 height cylinder

PRHB03 <i>posture back ratchet back</i>	armless	-	755	795	835	890	945	1000	
Perfect for clerical use and tasking situations that require some adjustability. Ideal control for stools.	DA drop away	BAP, BT	880	920	960	1015	1070	1125	
	VF fixed	-	860	900	940	995	1050	1105	
Stool options available on PRHB03	AT/AW adj. T	BAP, BT	880	920	960	1015	1070	1125	
	ATS adj. T	BAP, BT	880	920	960	1015	1070	1125	
	ATS/AW adj. T	BAP, BT	900	940	980	1035	1090	1145	
	MAT/AW multi-function	-	955	995	1035	1090	1145	1200	

Ships with CC01 hooded carpet casters and CY02 height cylinder

Actual dimensions will vary depending on model and options selected.

Dimensions: seat width 22" seat height from floor 16"-21" back width 21" back height 25.5"-28.5"

Weight: 52 lbs.

COM Requirements: 2 yards per chair

TO ORDER, please specify:	model	arm	arm pad	back panel	options	fabric pattern	fabric color	price
EXAMPLE	PRHB03	AT/AW	BT	BB	MSLC	MOGULS	FLARE 2188	949

Mechanism Functions

Basic Task

(1 paddle)
Swivels 360°, pneumatic cylinder seat height adjustment, back depth adjustment.

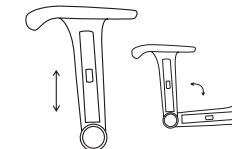

DA drop away

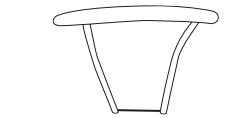

VF fixed
chrome with soft urethane pad

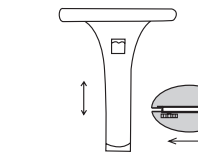

AT/AW adj. T includes
height and width adjustment

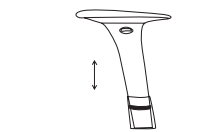

ATS adj. T height adjustment

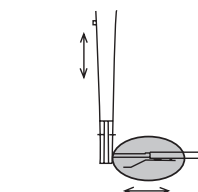

ATS/AW adj. T includes
height and width adjustment

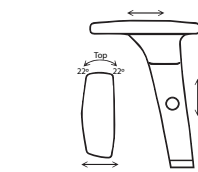

MAT/AW multi-function
(no arm pad option)

Arm Options

Arm Pad Options

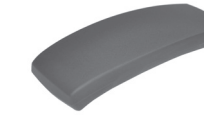

BAP Buzz arm pad
(default pad if none specified except for ATS)



BT bullet arm pad

Back Panel Options

- SB** Standard upholstered back panel. **(DEFAULT)**
- BB** Ballistic nylon back – recommended *(no upcharge)*
- BP** Bumper back trim – recommended *(no upcharge)*
Choose from 6 colors. Refer to web site for selection.

Buzz Seating is not responsible for back panel wear or tear regardless of option chosen. For additional back wear protection, **BB** or **BP** is recommended. One option is provided without an additional upcharge. If both options are ordered a 45 list upcharge applies. Refer to web site for **BP** color selections.

DEFAULT IS SB UNLESS SPECIFIED OTHERWISE

Additional Options

MODEL#	ADD
CAL133	California Technical Bulletin 133 115
MF	1" layer memory foam over upgraded high density foam seat 105
EF	1" extra seat foam 46
SS	Sliding seat depth adjustment (not available with PRHB01, PRHB02 & stools) 98
GLBG	Stationary bell glides (set of 5) 41
HC01	Hard floor/multisurface casters (set of 5) 41
MSLC	Self-braking hard floor casters brake when unoccupied (set of 5) 69
MSRLC	Self-braking hard floor casters brake when occupied (set of 5) 75
SP	Stool package (with PRHB01, PRHB03 controls only). Includes 8" cylinder and "Sure Grip" footing. Seat height extends from 20"-28". 133
XSP	Ext. stool package (with PRHB01, PRHB03 controls only). Includes 10" cylinder and "Sure Grip" footing. Seat height extends from 22"-32". 156
FR20	"Sure Grip" footing 92
ESD	Electrostatic dissipation. Dissipates static electricity from chair. Includes conductive fabric, conductive casters. *Specify hard floor or carpet casters Gr 6 +144

Pronto Highback Series



- Designed for the larger sized individual as a high back chair
- Proportionally scaled seat and back
- Convex back
- 4" seat foam
- Soft and supple sit
- Partial assembly required

300 lb. Capacity All prices are LIST

Model	Arm Options	Arm Pad Options (default pad in bold)	COM						Upholstery Grade
			1	2	3	4	5	6	
PRHB04 <i>synchro tilter ratchet back</i>	armless	-	755	795	835	890	945	1000	
Smooth and simple ride. Synchronized movement between seat and back. Any application.	DA drop away	BAP, BT	880	920	960	1015	1070	1125	
	VF fixed	-	860	900	940	995	1050	1105	
	AT/AW adj. T	BAP, BT	880	920	960	1015	1070	1125	
	ATS adj. T	BAP, BT	880	920	960	1015	1070	1125	
	ATS/AW adj. T	BAP, BT	900	940	980	1035	1090	1145	
	MAT/AW multi-function	-	955	995	1035	1090	1145	1200	

Ships with CC01 hooded carpet casters and CY02 height cylinder

PRHB08 <i>multi tilter ratchet back</i>	armless	-	895	935	975	1030	1085	1140
Use in applications that require maximum adjustability. Multipurpose full 6 function ergonomic control. Recommended for its infinite range and ease of adjustments.	DA drop away	BAP, BT	1020	1060	1100	1155	1210	1265
	VF fixed	-	1000	1040	1080	1135	1190	1245
	AT/AW adj. T	BAP, BT	1020	1060	1100	1155	1210	1265
	ATS adj. T	BAP, BT	1020	1060	1100	1155	1210	1265
	ATS/AW adj. T	BAP, BT	1040	1080	1120	1175	1230	1285
	MAT/AW multi-function	-	1095	1135	1175	1230	1285	1340

Ships with CC01 hooded carpet casters and CY02 height cylinder

Most popular (recommended)

PRHB09 <i>multi tilt ratchet back integrated seat slider</i>	armless	-	920	960	1000	1055	1110	1165
Perfect for any application. An all inclusive control at a value price. Includes an internal ratchet back height adjustment and seat slider.	DA drop away	BAP, BT	1045	1085	1125	1180	1235	1290
	VF fixed	-	1025	1065	1105	1160	1215	1270
	AT/AW adj. T	BAP, BT	1045	1085	1125	1180	1235	1290
	ATS adj. T	BAP, BT	1045	1085	1125	1180	1235	1290
	ATS/AW adj. T	BAP, BT	1065	1105	1145	1200	1255	1310
	MAT/AW multi-function	-	1120	1160	1200	1255	1310	1365

Ships with CC01 hooded carpet casters and CY02 height cylinder

Actual dimensions will vary depending on model and options selected.

Dimensions: seat width 22" seat height from floor 16"-21" back width 21" back height 25.5"-28.5"

Weight: 52 lbs.

COM Requirements: 2 yards per chair



TO ORDER, please specify:	model	arm	arm pad	back panel	options	fabric pattern	fabric color	price
EXAMPLE	PRHB08	MAT/AW	-	SB/BP06	-	MOGULS	FLARE 2188	1095

Mechanism Functions

Synchro Tilter

(2 paddles)
Swivels 360°, pneumatic cylinder seat height adjustment, synchronized tilt between seat and back, free floats in unlocked position, 3 position tilt lock, tilt tension control, internal ratchet back height adjustment.

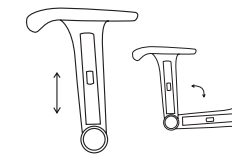

DA drop away



VF fixed
chrome with soft urethane pad

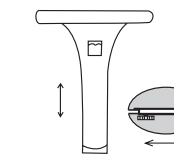

AT/AW adj. T includes
height and width adjustment

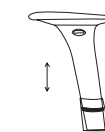

ATS adj. T height adjustment

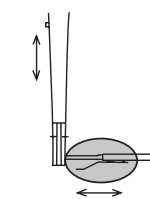

ATS/AW adj. T includes
height and width adjustment

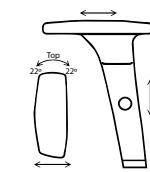

MAT/AW multi-function
(no arm pad option)

Arm Options

Arm Pad Options



BAP Buzz arm pad
(default pad if none specified except for ATS)



BT bullet arm pad

Back Panel Options

- SB** Standard upholstered back panel. **(DEFAULT)**
- BB** Ballistic nylon back – recommended *(no upcharge)*
- BP** Bumper back trim – recommended *(no upcharge)*
Choose from 6 colors. Refer to web site for selection.

Buzz Seating is not responsible for back panel wear or tear regardless of option chosen. For additional back wear protection, **BB** or **BP** is recommended. One option is provided without an additional upcharge. If both options are ordered a 45 list upcharge applies. Refer to web site for **BP** color selections.

DEFAULT IS SB UNLESS SPECIFIED OTHERWISE

Additional Options

MODEL#		ADD
CAL133	California Technical Bulletin 133	115
MF	1" layer memory foam over upgraded high density foam seat	105
EF	1" extra seat foam	46
SS	Sliding seat depth adjustment (not available with PRHB08 & stools)	98
GLBG	Stationary bell glides (set of 5)	41
HC01	Hard floor/multisurface casters (set of 5)	41
MSLC	Self-braking hard floor casters brake when unoccupied (set of 5)	69
MSRLC	Self-braking hard floor casters brake when occupied (set of 5)	75
FR20	"Sure Grip" footing	92
ESD	Electrostatic dissipation. Dissipates static electricity from chair. Includes conductive fabric, conductive casters. *Specify hard floor or carpet casters	Gr 6 + 144

Chair Version



- 24/7 Multi-shift intensive use environments
- Heavy duty components
- Accommodates most individuals as a mid-sized chair
- Proportionally scaled seat and back
- Built for extreme conditions
- Partial assembly required
- Memory foam seat

350 lb. Capacity All prices are LIST

Model	Arm Options	Arm Pad Options (default pad in bold)	COM					
			1	2	3	4	5	6
PRMB01HD <i>basic task fixed back</i>	armless	-	885	925	965	1020	1075	1130
Basic task situations that require minimal adjustments. Stool options available on PRMB01HD	DA drop away	BAP , BT	1010	1050	1090	1145	1200	1255
	VF fixed	-	990	1030	1070	1125	1180	1235
	AT/AW adj. T	BAP , BT	1010	1050	1090	1145	1200	1255
	ATS adj. T	BAP , BT	1010	1050	1090	1145	1200	1255
	ATS/AW adj. T	BAP , BT	1025	1065	1105	1160	1215	1270
	MAT/AW multi-function	-	1085	1125	1165	1220	1275	1330

Ships with **CC01-HD** hooded carpet casters and **CY02-HD** height cylinder

350 lb. Capacity

PRMB08HD <i>multi tilter ratchet back</i>	armless	-	1015	1055	1095	1150	1205	1260
Use in applications that require maximum adjustability. Multipurpose full 6 function ergonomic control. Recommended for its infinite range and ease of adjustments.	DA drop away	BAP , BT	1140	1180	1220	1275	1330	1385
	VF fixed	-	1120	1160	1200	1255	1310	1365
	AT/AW adj. T	BAP , BT	1140	1180	1220	1275	1330	1385
	ATS adj. T	BAP , BT	1140	1180	1220	1275	1330	1385
	ATS/AW adj. T	BAP , BT	1155	1195	1235	1290	1345	1400
	MAT/AW multi-function	-	1215	1255	1295	1350	1405	1460

Ships with **CC01-HD** hooded carpet casters and **CY02-HD** height cylinder

Most popular (recommended)

350 lb. Capacity

PRMB09HD <i>multi tilter ratchet back integrated seat slider</i>	armless	-	1035	1075	1115	1170	1225	1280
Perfect for any application. An all inclusive control at a value price. Includes an internal ratchet back height adjustment and seat slider.	DA drop away	BAP , BT	1160	1200	1240	1295	1350	1405
	VF fixed	-	1140	1180	1220	1275	1330	1385
	AT/AW adj. T	BAP , BT	1160	1200	1240	1295	1350	1405
	ATS adj. T	BAP , BT	1160	1200	1240	1295	1350	1405
	ATS/AW adj. T	BAP , BT	1175	1215	1255	1310	1365	1420
	MAT/AW multi-function	-	1235	1275	1315	1370	1425	1480

Ships with **CC01-HD** hooded carpet casters and **CY02-HD** height cylinder

Actual dimensions will vary depending on model and options selected.

Dimensions: seat width 20.5" seat height from floor 18" back width 18"
 seat depth 17.5" chair version 16.5"-20.5" back height 20.5"-23.5"

Weight: approx. 54-58 lbs. stool version 23"-31"

COM Requirements: 2 yards per chair



FREIGHT PROGRAM
 11 or fewer \$25 net per chair
 12 or more free shipping

TO ORDER, please specify:	model	arm	arm pad	back panel	options	fabric pattern	fabric color	price
EXAMPLE	PRMB01HD	DA	BAP	BB	HC01-HD	ANCHORAGE	ONYX	1085

Mechanism Functions

Basic Task - Heavy Duty Version
 (1 paddle)
 Swivels 360°, pneumatic cylinder seat height adjustment, back depth adjustment.

Multi Tilter - Heavy Duty Version
 (3 paddles)
 Swivels 360°, pneumatic cylinder seat height adjustment, seat and back tilt as unit, free floats in unlocked position, infinite position tilt lock, tilt tension control, internal ratchet back height adjustment, infinite back angle adjustment.

Multi Tilt w/Integrated Seat Slider - Heavy Duty Version
 (4 paddles)
 Swivels 360°, pneumatic cylinder seat height adjustment, seat and back tilt as unit, free floats in unlocked position, infinite position tilt lock, tilt tension control, internal ratchet back height adjustment, infinite back angle adjustment, side activated sliding seat pan.

Arm Options

DA drop away

VF fixed
chrome with soft urethane pad

AT/AW adj. T includes height and width adjustment

ATS adj. T height adjustment

ATS/AW adj. T includes height and width adjustment

MAT/AW multi-function
(no arm pad option)

Arm Pad Options

BAP Buzz arm pad
(default pad if none specified except for ATS)

BT bullet arm pad

Back Panel Options

SB Standard upholstered back panel. **(DEFAULT)**

BB Ballistic nylon back – recommended *(no upcharge)*

BP Bumper back trim – recommended *(no upcharge)*
 Choose from 6 colors. Refer to web site for selection.

Buzz Seating is not responsible for back panel wear or tear regardless of option chosen. For additional back wear protection, **BB** or **BP** is recommended. One option is provided without an additional upcharge. If both options are ordered a 45 list upcharge applies. Refer to web site for **BP** color selections.

DEFAULT IS SB UNLESS SPECIFIED OTHERWISE

Additional Options

MODEL#		ADD
CAL133	California Technical Bulletin 133	115
EF	1" extra seat foam	46
GLBG	Stationary bell glides (set of 5)	41
HC01-HD	Hard floor casters (set of 5)	75
MSLC	Self-braking hard floor casters brake when unoccupied (set of 5)	69
MSRLC	Self-braking hard floor casters brake when occupied (set of 5)	75
SP-HD	Stool package (with PRMB01HD controls only). Includes 8" cylinder and "Sure Grip" footring. Seat height extends from 20"-28".	196
XSP-HD	Ext. stool package (with PRMB01HD controls only). Includes 10" cylinder and "Sure Grip" footring. Seat height extends from 22"-32".	219
FR20	"Sure Grip" footring	92
ESD	Electrostatic dissipation. Dissipates static electricity from chair. Includes conductive fabric, conductive casters. *Specify hard floor or carpet casters	Gr 6 + 144

Warranty: 24/7 Multi-Shift Series

Standard published warranty terms and conditions apply with the following changes: 5 years on all components and 2 years on fabric and foam.

Chair Version



- 24/7 Multi-shift intensive use environments
- Heavy duty components
- Accommodates most individuals as a high-back chair
- Proportionally scaled seat and back
- Built for extreme conditions
- Partial assembly required
- Memory foam seat

350 lb. Capacity All prices are LIST

Model	Arm Options	Arm Pad Options (default pad in bold)	Upholstery Grade					
			1	2	3	4	5	6
PRHB01HD <small>basic task fixed back</small>	armless	-	965	1005	1045	1100	1155	1210
<small>Basic task situations that require minimal adjustments.</small> Stool options available on PRHB01HD	DA drop away	BAP , BT	1090	1130	1170	1225	1280	1335
	VF fixed	-	1065	1105	1145	1200	1255	1310
	AT/AW adj. T	BAP , BT	1090	1130	1170	1225	1280	1335
	ATS adj. T	BAP , BT	1090	1130	1170	1225	1280	1335
	ATS/AW adj. T	BAP , BT	1105	1145	1185	1240	1295	1350
	MAT/AW multi-function	-	1165	1205	1245	1300	1355	1410

Ships with heavy duty **CC01-HD** hooded carpet casters and **CY02-HD** height cylinder

350 lb. Capacity

PRHB08HD <small>multi tilter ratchet back</small>	armless	-	1095	1135	1175	1230	1285	1340
<small>Use in applications that require maximum adjustability. Multipurpose full 6 function ergonomic control. Recommended for its infinite range and ease of adjustments.</small>	DA drop away	BAP , BT	1220	1260	1300	1355	1410	1465
	VF fixed	-	1195	1235	1275	1330	1385	1440
	AT/AW adj. T	BAP , BT	1220	1260	1300	1355	1410	1465
	ATS adj. T	BAP , BT	1220	1260	1300	1355	1410	1465
	ATS/AW adj. T	BAP , BT	1235	1275	1315	1370	1425	1480
	MAT/AW multi-function	-	1295	1335	1375	1430	1485	1540

Ships with heavy duty **CC01-HD** hooded carpet casters and **CY02-HD** height cylinder

Most popular (recommended)

350 lb. Capacity

PRHB09HD <small>multi tilter ratchet back integrated seat slider</small>	armless	-	1115	1155	1195	1250	1305	1360
<small>Perfect for any application. An all inclusive control at a value price. Includes an internal ratchet back height adjustment and seat slider.</small>	DA drop away	BAP , BT	1240	1280	1320	1375	1430	1485
	VF fixed	-	1215	1255	1295	1350	1405	1460
	AT/AW adj. T	BAP , BT	1240	1280	1320	1375	1430	1485
	ATS adj. T	BAP , BT	1240	1280	1320	1375	1430	1485
	ATS/AW adj. T	BAP , BT	1255	1295	1335	1390	1445	1500
	MAT/AW multi-function	-	1315	1355	1395	1450	1505	1560

Ships with heavy duty **CC01-HD** hooded carpet casters and **CY02-HD** height cylinder

Actual dimensions will vary depending on model and options selected.

Dimensions: seat width 22" seat height from floor chair version 16.5"-20.5" back width 20" back height 23.5"-26.5"
 seat depth 20" stool version 23"-31"

Weight: approx. 56-60 lbs.

COM Requirements: 2 yards per chair



TO ORDER, please specify:
EXAMPLE

model	arm	arm pad	back panel	options	fabric pattern	fabric color	price
PRHB01HD	VF	-	BB	HC01-HD	ANCHORAGE	ONYX	1140

Mechanism Functions

Basic Task - Heavy Duty Version
 (1 paddle)
 Swivels 360°, pneumatic cylinder seat height adjustment, back depth adjustment.



Multi Tilter - Heavy Duty Version
 (3 paddles)
 Swivels 360°, pneumatic cylinder seat height adjustment, seat and back tilt as unit, free floats in unlocked position, infinite position tilt lock, tilt tension control, internal ratchet back height adjustment, infinite back angle adjustment.

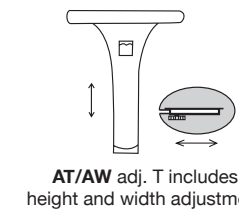

Multi Tilt w/Integrated Seat Slider - Heavy Duty Version
 (4 paddles)
 Swivels 360°, pneumatic cylinder seat height adjustment, seat and back tilt as unit, free floats in unlocked position, infinite position tilt lock, tilt tension control, internal ratchet back height adjustment, infinite back angle adjustment, side activated sliding seat pan.

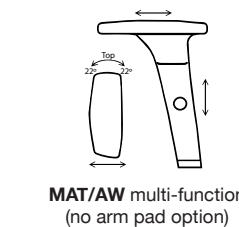
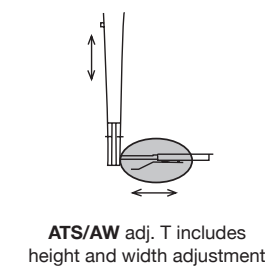
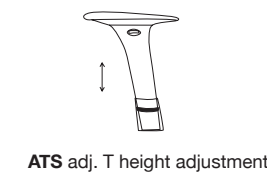

Arm Options

Arm Pad Options



Back Panel Options

- SB** Standard upholstered back panel. **(DEFAULT)**
- BB** Ballistic nylon back – recommended *(no upcharge)*
- BP** Bumper back trim – recommended *(no upcharge)*
Choose from 6 colors. Refer to web site for selection.

Buzz Seating is not responsible for back panel wear or tear regardless of option chosen. For additional back wear protection, **BB** or **BP** is recommended. One option is provided without an additional upcharge. If both options are ordered a 45 list upcharge applies. Refer to web site for **BP** color selections.

DEFAULT IS SB UNLESS SPECIFIED OTHERWISE

Additional Options

MODEL#		ADD
CAL133	California Technical Bulletin 133	115
EF	1" extra seat foam	46
GLBG	Stationary bell glides (set of 5)	41
HC01-HD	Hard floor casters (set of 5)	75
MSLC	Self-braking hard floor casters brake when unoccupied (set of 5)	69
MSRLC	Self-braking hard floor casters brake when occupied (set of 5)	75
SP-HD	Stool package (with PRHB01HD controls only). Includes 8" cylinder and "Sure Grip" footring. Seat height extends from 20"-28".	196
XSP-HD	Ext. stool package (with PRHB01HD controls only). Includes 10" cylinder and "Sure Grip" footring. Seat height extends from 22"-32".	219
FR20	"Sure Grip" footring	92
ESD	Electrostatic dissipation. Dissipates static electricity from chair. Includes conductive fabric, conductive casters. <small>*Specify hard floor or carpet casters</small>	Gr 6 + 144

Warranty: 24/7 Multi-Shift Series

Standard published warranty terms and conditions apply with the following changes: 5 years on all components and 2 years on fabric and foam.

Arm Options

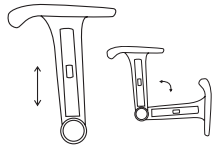

DA Drop Away Adjustable T-Arm
Adjustable 2.5" in height and can be dropped completely rearward with tension adjustment. Available with any arm pad option.
DA add 125 list

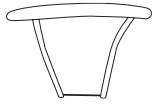

VF Fixed Arm
Non-adjustable. Urethane pad with chromed uprights. Front sloped for under desk or table access.
VF add 105 list

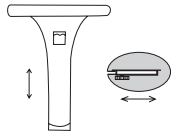

AT/AW Adjustable T-Arm
Traditional style. Adjustable 2.5" in height. Arms can be adjusted out from the seat an additional 2" on each side. Available with any arm pad option.
AT/AW add 125 list

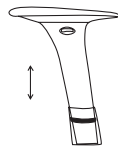

ATS Adjustable T-Arm
Contemporary style. Adjustable 2.5" in height. Available with any arm pad option.
ATS add 125 list

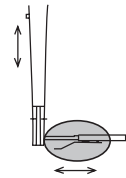

ATS/AW Adjustable T-Arm including Width Adjustment Brackets
ATS contemporary style adjustable T-Arm includes AW adjustable width brackets. Adjustable 2.5" in height. Arms can be adjusted out from the seat an additional 2" on each side. Available with any arm pad option.
ATS/AW add 140 list

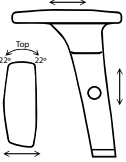

MAT/AW Multi-Function Arm
Adjusts 2.5" in height. Pads have center pivot point and rotate 22" in and out (2 separate directions). Additionally, pads slide forward and rearward with 2" of travel. Width adjustable brackets included.
MAT/AW add 200 list

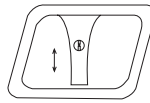

AL Adjustable Loop Arm
Urethane. Adjust 2.5" in height
Use with Big & Tall, Shield, Pronto 24/7.
AL add 185 list

Casters

Definitions

Carpet Caster – Hard wheel for use on soft surfaces such as carpet

Hard Floor Caster – Soft wheel for use on tile, wood, vinyl, concrete or any other hard surface

Multi-Surface Caster – Hard wheel for use on all floor types

Locking Caster – Casters do not allow the chair to roll when nobody is seated in chair

Reverse Locking Caster – Casters do not allow the chair to roll when someone is seated in chair

Hooded Caster – Wheels are covered by a "Hood"

Non-Hooded Caster – Casters are exposed

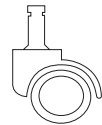

Hooded Caster



Non-Hooded Caster

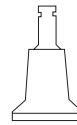

Bell Glide

Pronto/Snap/Melo Basic & Medical Stool

Black hooded caster
CC01 – Carpet casters add 41 list / set of 5
HC01 – Hard floor casters add 41 list / set of 5

Jem/Caboodle

Large wheel black hooded caster
CC02 – Carpet casters add 46 list / set of 4
HC02 – Hard floor casters add 46 list / set of 4

Rika/Melo/Pronto Mesh/Dandy/Nifty

Black non-hooded caster
CC07 – Black carpet casters add 46 list / set of 5
CC07-SL – Black & silver carpet casters add 46 list / set of 5
HC07 – Hard floor casters add 46 list / set of 5

Jem/Melo Side

Small wheel black caster
CC09 – Black carpet casters add 46 list / set of 4
HC09 – Hard floor casters add 46 list / set of 4

Pronto HD/Shield/Big & Tall

Black non-hooded caster
CC01-HD – Carpet casters add 75 list / set of 5
HC01-HD – Hard floor casters add 75 list / set of 5

Shield HD/Big & Tall HD

Black non-hooded caster
MSSHD – Multi-surface add 75 list / set of 6

Universal Chrome Caster

Chrome hooded caster
CCCH – Carpet casters add 52 list / set of 5
HCCH – Hard floor casters add 52 list / set of 5

Universal Electrostatic Dissipation Caster

Black hooded caster
CCESD – Carpet casters add 144 list / set of 5
HCESD – Hard floor casters add 144 list / set of 5

Universal Locking Caster

Black hooded caster
MSLC – Multi-surface add 69 list / set of 5

Universal Reverse Locking Caster

Black hooded caster
MSRLC – Multi-surface casters add 75 list / set of 5

Flite

Black nylon glide caster
GL01 add 12 list / set of 4

Jem/Melo Side

Black nylon caster
GL07 add 29 list / set of 4

Start

Black nylon glide caster
GL04 add 12 list / set of 4

Universal Bell Glide

Black nylon glide caster
GLBG add 41 list / set of 5

Arm Pad Options



BAP Buzz arm pad profile (default pad if none specified except for ATS)
add 35 list per pair



BT bullet arm pad profile (recommended and default for ATS)
add 35 list per pair

Accessories



Ballistic nylon back

Can be applied for added strength. Prevents scratching or tearing of fabric. Black in color. Used in place of plastic backs.

BB No upcharge

*ordered in conjunction with **BP** bumper guard
add 45 list



Bumper back trim

Vinyl strip attached to the outer perimeter of the rear back panel of chair to protect against edge back wear. Available in 6 colors that can be color coordinated with fabric or vinyl. Refer to web site for color selections.

BP No upcharge

*ordered in conjunction with **BB** ballistic nylon
add 45 list



Thoracic back

Provides additional pronounced support throughout the thoracic area of the back. (On PRMB03, 09 only)

THORBACK add 105 list

Ordered separately contact **customer service**

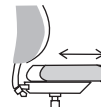

Sliding seat pan

Allows the seat to be adjusted to different depth settings. Permits 2.5" of travel at multiple lock-in points.

SS (MESH) add 87 list

SS add 98 list

*Not available on stools



1" Additional seat foam

Add for increased seat comfort.

EF standard foam add 46-64 list depending on model

MF 1" layer memory foam over upgraded high density foam seat add 105 list



Standard stool package

Seat height from floor ranges from 20" to 28". Actual seat heights can vary depending upon model. Footring and 8" travel cylinder included.

SP add 133 list

SP-HD add 196 list

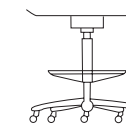

Extended stool package

Seat height from floor ranges from 22" to 32". Actual seat heights can vary depending upon model. Footring and 10" travel cylinder included.

XSP add 156 list

XSP-HD add 219 list



CAL 133

Fire blocker is upholstered over seat and back foam.
CAL133 add 60-140 list depending on model



ELECTROSTATIC DISSIPATION

Electrostatic dissipation

Dissipates static electricity from chair, includes conductive fabric, conductive casters. For ESD applications see "Additional Options" as applicable to chair models.



Headrest

Rika series

RAHR add 130 list

Please refer to specific chair models for available accessory options.

Parts List Customer is responsible for shipping cost for parts and upholstery.

MODEL#	ITEM	LIST PRICE
ARMS		
DA	Drop away (complete) - specify pad	125 pair
VF	V shaped fixed	105 pair
AT/AW	Adjustable height & width (complete) - specify pad	125 pair
ATS	Contemporary adjustable height (complete) - specify pad	125 pair
ATS/AW	Contemporary adjustable height & width (complete) - specify pad	140 pair
MAT/AW	Multi-Function height & weight (complete)	200 pair
AW	Adjustable width brackets *when purchased separately	29 pair
AL	Adjustable height loop	185 pair
BAP	Buzz Arm Pad (replaced Diamond Pad)	35 pair
BT	Bullet Pad	35 pair
RMFA	Rika multi function height adjustable	115 pair
CYLINDER		
CY00	Specialty - 2.5" Travel	35 ea
CY01	Bantam/Petite - 3" Travel	35 ea
CY02	Pronto MB & HB - 5" Travel	41 ea
CY02-CH	Pronto MB & HB/Pronto Mesh/Melo/Medical Chrome - 5" Travel	52 ea
CY02-HD	Pronto Heavy Duty - 5" Travel	58 ea
CY02-HD2	Shield/Big & Tall - 5" Travel	58 ea
CY02-SHD	Shield/Big & Tall Super Heavy Duty - 5" Travel	127 ea
CY03	Chair/Stool - 7.5" Travel	46 ea
CY04	Stool - 8" Travel	41 ea
CY04-CH	Stool Chrome - 8" Travel	58 ea
CY04-HD	Stool Heavy Duty - 8" Travel	104 ea
CY05	Extended Stool - 10" Travel	64 ea
CY05-CH	Extended Stool Chrome - 10" Travel	81 ea
CY05-HD	Extended Stool Heavy Duty - 10" Travel	127 ea
CY06	Melo/Pronto Mesh - 4" Travel	46 ea
CY06-CH	Melo/Pronto Mesh Chrome - 4" Travel	46 ea
CY06-HD	Melo/Pronto Mesh Heavy Duty - 4" Travel	58 ea
CY07	Rika Short - 3" Travel	46 ea
CY08	Rika Standard - 4" Travel	46 ea
CY09	Rika Tall - 5" Travel	46 ea
CY10	Dandy - 5" Travel	46 ea
CY13	Medical/Snap - 5" Travel	41 ea
CY14	Melo Basic - 5" Travel	41 ea
CY16	LOD20 - Auto Return	46 ea
CY17	LOD40 - 2.5" Travel	46 ea
CY18	Nifty - 4" Travel	46 ea
CY19	LOD50/60/70 - 5" Travel	46 ea
CY20	LOD80 - 2.75" Travel	46 ea
CY22	Rika Short Leather - 3.5" Travel	46 ea
COVER	Cylinder Cover Can	35 ea

MODEL#	ITEM	LIST PRICE
BASE		
BASE22	22" Poly Base in Blk, Dk Gray, Lt Gray, Sand Medical	52 ea
BASE22-A	22" Polished Aluminum Base Medical/Snap (not available on stools)	115 ea
BASE23	23" Poly Black Base Snap	52 ea
BASE24	24" Poly Black Base Bantam/Petite/Urethane	52 ea
BASE24-M	24" Poly Base in Blk, Dk Gray, Lt Gray, Sand Medical/Snap	52 ea
BASE25-TH	25" Thunder Poly Black Base Melo/Pronto Mesh	52 ea
BASE25-THA	25" Thunder Polished Aluminum Base Melo/Pronto Mesh	115 ea
BASE26	26" Poly Black Base Pronto MB/HB	52 ea
BASE26-A	26" Polished Aluminum Base Pronto MB/HB	115 ea
BASE27.5-HD	27.5" Poly Black Base Big & Tall/Shield	75 ea
BASE27.5-SHD	27.5" Steel Black Base Big & Tall HD/Shield HD	219 ea
BASE-PAB	Rika Polished Aluminum Base	115 ea
BASE-PBB	Rika Poly Black Base	52 ea
BACO	Base Collar (adds 3/4" to seat height)	6 ea
MISCELLANEOUS		
FR18	18" Sure Grip Foot Ring Medical Stool Only	92 ea
FR20	20" Sure Grip Foot Ring	92 ea

Contact Customer Service for parts not shown.



Customer is responsible for shipping cost for parts and upholstery.

Parts List Customer is responsible for shipping cost for parts and upholstery.

MODEL#	ITEM	LIST PRICE
CARPET CASTERS		
CC01	Hooded Carpet Caster (Black) Pronto/Urethane/Snap/Melo Basic	41 set of 5
CC01-HD	Carpet Heavy Duty Caster (Black) Pronto HD/Big & Tall/ Shield	75 set of 5
CC02	Hooded Carpet Caster (Black) Large Wheel Caboodle/Jem	46 set of 5
CC07	Carpet Caster (Black) Dandy/Nifty/Melo/Pronto Mesh/Rika	46 set of 5
CC07-SL	Carpet Caster (Black & Silver) Melo/Pronto Mesh	46 set of 5
CC09	Carpet Caster (Black) Small Wheel Jem/Melo Side	46 set of 5
CCCH	Carpet Caster (Chrome)	52 set of 5
CCESD	ESD Carpet Caster (Black)	144 set of 5
HARD FLOOR CASTERS		
HC01	Hooded Hard Floor Caster (Black) Pronto/Urethane/Snap/Melo Basic	41 set of 5
HC01-HD	Hard Floor Heavy Duty Caster (Black) Pronto HD/Big & Tall/Shield	75 set of 5
HC02	Hooded Hard Floor Caster (Black) Large Wheel Caboodle/Jem	46 set of 5
HC07	Hard Floor Caster (Black) Dandy/Nifty/Melo/Pronto Mesh/Rika	46 set of 5
HC09	Hard Floor Caster (Black) Small Wheel Jem/Melo Side	46 set of 5
HCCH	Hard Floor Caster (Chrome)	52 set of 5
HCESD	ESD Hard Floor Caster (Black)	144 set of 5
GLIDES		
GL01	Glide (Black Nylon) Flite	12 set of 4
GL02	Glide (Black Nylon) Jem (short)/Jem Arm Hole Covers	12 set of 4
GL03	Glide (Black Nylon) Melo Side (short)	12 set of 4
GL04	Glide (Black Nylon) Start	12 set of 4
GL05	Glide (Black Nylon) LOD20	12 set of 4
GL06	Glide (White Nylon) LOD151/157	12 set of 4
GL07	Glide (Black Nylon) Jem/Melo Side (tall)	29 set of 4
GLBG	Stationary Bell Glide	41 set of 5
GLRF	Rubber Feet	35 set of 4

MODEL#	ITEM	LIST PRICE
MULTI-SURFACE CASTERS		
MS02	Multi-Surface Caster (Black) LOD40/LOD50	46 set of 5
MS03	Multi-Surface Caster (Black) LOD60/LOD70/LOD80	46 set of 5
MSLC	Multi-Surface Locking Caster (Black) *Breaks when not seated	69 set of 5
MSRLC	Multi-Surface Reverse Locking Caster (Black) *Breaks when seated	75 set of 5
MSSHD	Multi-Surface Super Heavy Duty Caster (Black) Big & Tall HD/Shield HD	75 set of 6
UPHOLSTERY		Net Price
Grade 1	Specify Pattern/Color	35 per yd
Grade 2	Specify Pattern/Color	45 per yd
Grade 3	Specify Pattern/Color	50 per yd
Grade 4	Specify Pattern/Color	60 per yd
Grade 5	Specify Pattern/Color	75 per yd
Grade 6	Specify Pattern/Color	95 per yd
Ballistic Nylon	Specify Color	50 per yd

Contact Customer Service for parts not shown.

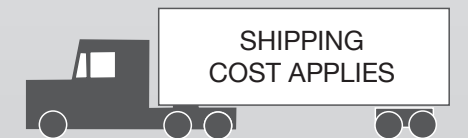

Customer is responsible for shipping cost for parts and upholstery.



1.877.263.5737



1.513.772.7328



www.buzzseating.com

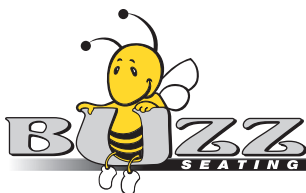

Buzz Seating Inc.

PO Box 31379, Cincinnati, OH 45231

www.buzzseating.com