

C-DSP 8x12

8-IN 12-OUT ADVANCED IN-CAR AUDIO PROCESSOR

User Manual





Revision history

Revision	Description	Date
V0.1	Preliminary version	15 February 2017
V0.2	Corrected specifications	16 February 2017
V0.3	REW at 192 kHz info	20 February 2017
V0.4	Revised preliminary based on 1.0 plugin	14 May 2107
V1.0	First release version for 1.0 plugin	22 May 2017
V1.1	Updated support links	6 July 2020
V1.2	Updated wired remote	1 August 2020
V1.4	Updates for OLED wired remote	16 December 2020
V1.5	Adobe Air and Flash no longer needed	1 February 2021

CONTENTS

Important Information.....	5
System Requirements	5
Disclaimer/Warning	5
Warranty Terms.....	6
FCC Class B Statement.....	6
CE Mark Statement.....	6
A note on this manual.....	6
1 Product overview.....	7
1.1 Typical usage.....	7
1.2 The miniDSP concept.....	8
1.3 Plugin feature summary	8
2 The miniDSP workflow.....	9
3 Software installation	11
3.1 Windows	11
3.2 Mac.....	12
4 Hardware connectivity.....	13
4.1 Analog inputs	13
4.1.1 Low-level inputs.....	13
4.1.2 High-level inputs.....	14
4.2 Digital input.....	15
4.3 Analog outputs.....	15
4.4 DC power	16
4.4.1 Powered on power (position 1).....	16
4.4.2 Remote trigger (position 2).....	16
4.5 Wired remote.....	17
4.6 USB	17
5 Configuring the processor.....	18
5.1 Synchronizing with the processor	18
5.2 Master mute	19
5.3 Subwoofer and Master volume.....	20
5.3.1 To select the channels controlled in Subwoofer Volume mode	20
5.3.2 To change the volume control mode.....	20
5.4 Inputs tab.....	21
5.4.1 Digital input selection	21
5.4.2 Input channel strips	22
5.5 Routing tab.....	23
5.5.1 Mixing channels.....	23
5.5.2 Routing to multiple outputs	24
5.5.3 Cross-point gain and inversion	25

5.6	Output tabs	26
5.6.1	Channel strip layout.....	27
5.6.2	Channel label.....	27
5.6.3	Level meter and gain control	27
5.6.4	Parametric EQ.....	28
5.6.5	Crossover.....	30
5.6.6	Compressor	32
5.6.7	Time delay.....	33
5.6.8	Invert and mute.....	33
5.7	Custom biquad programming	34
5.7.1	What’s a “biquad?	34
5.7.2	Using custom biquad programming	34
5.7.3	Biquad design software.....	36
5.8	Working with configurations	37
5.8.1	Online and offline mode	37
5.8.2	Selecting a configuration	37
5.8.3	Saving and loading configurations.....	38
5.8.4	Loading configurations from microSD card.....	38
5.8.5	Restoring to defaults.....	39
5.9	Keyboard shortcuts	39
5.10	Remote trigger timing	40
6	Remote Control	41
6.1	Status indicators.....	41
6.2	Operation of the OLED wired remote	41
6.3	Using the miniDSP remote.....	42
6.4	Infrared remote control.....	43
7	Additional information	44
7.1	Specifications	44
7.2	Input sensitivity setting	45
7.3	4-button wired remote (legacy).....	46
7.4	Troubleshooting	47
7.5	Firmware upgrade – main board and wired remote.....	48
7.6	Obtaining support	48



IMPORTANT INFORMATION

Please read the following information before use. In case of any questions, please contact miniDSP via the support portal at support.minidsp.com.

SYSTEM REQUIREMENTS

To configure the miniDSP audio processor, you will require a Windows PC or Apple Mac OS X computer with the following minimum specification:

Windows

- PC with 1GHz or higher processor clock speed. Intel® Pentium®/Celeron® family, or AMD K6®/AMD Athlon®/AMD Duron® family, or compatible processor recommended.
- 512 megabytes (MB) of RAM or higher
- Keyboard and mouse or compatible pointing device
- USB 2.0 port
- Microsoft® Windows® Vista® SP1/ XP pro SP2/Win7/Win8.1/Win10
- Microsoft® .NET framework v3.5 or later

Mac OS X

- Intel-based Mac with 1 GHz or higher processor clock speed
- 512 megabytes (MB) of RAM or higher
- Keyboard and mouse or compatible pointing device
- USB 2.0 port
- OS X 10.8 or higher, macOS 10.12 or higher

DISCLAIMER/WARNING

miniDSP cannot be held responsible for any damage that may result from the improper use of this product or incorrect configuration of its settings. As with any other product, we recommend that you carefully read this manual and other technical notes to ensure that you fully understand how to operate this product. The miniDSP audio processor is a powerful tool, and misuse or misconfiguration, such as incorrectly set gains or excessive boost, can produce signals that may damage your audio system.

As a general guideline, you should perform the initial configuration of the miniDSP audio processor before enabling audio through any connected output device or amplification. Doing so will help ensure that the software is correctly configured.

Finally, note that the miniDSP audio processor is a very flexible device, and many of the questions we receive at the tech support department are already answered in this user manual and in the online [application notes](#) on the miniDSP.com website. So please take the time to carefully read this user manual and the online technical support. Thanks for your understanding!



WARRANTY TERMS

miniDSP Ltd warrants this product to be free from defects in materials and workmanship for a period of one year from the invoice date. Our warranty does not cover failure of the product due to incorrect connection or installation, improper or undocumented use, unauthorized servicing, modification or alteration of the unit in any way, or any usage outside of that recommended in this manual. If in doubt, contact miniDSP prior to use.

FCC CLASS B STATEMENT

This device complies with Part 15 of the FCC Rules. Operation is subject to the following two conditions:

- This device may not cause harmful interference.
- This device must accept any interference received, including interference that may cause undesired operation.

Warning: This equipment has been tested and found to comply with the limits for a Class B digital device, pursuant to Part 15 of the FCC Rules. These limits are designed to provide reasonable protection. This equipment generates, uses and can radiate radio frequency energy and, if not installed and used in accordance with the instructions, may cause interference to radio communications. However, there is no guarantee that interference will not occur in a particular installation. If this equipment does cause harmful interference to radio or television reception, which can be determined by turning the equipment off and on, the user is encouraged to try to correct the interference by one or more of the following measures:

- Reorient or relocate the receiving antenna.
- Increase the separation between the equipment and receiver.
- Connect the equipment into an outlet on a circuit different from that to which the receiver is connected.
- Consult the dealer or an experienced radio/TV technician for help.

Notice: Shielded interface cable must be used in order to comply with emission limits.

Notice: Changes or modification not expressly approved by the party responsible for compliance could void the user's authority to operate the equipment.

CE MARK STATEMENT

The C-DSP 8x12 has passed the test performed according to European Standard EN 55022 Class B.

A NOTE ON THIS MANUAL

This User Manual is designed for reading in both print and on the computer. If printing the manual, please print double-sided. The embedded page size is 8 ½" x 11". Printing on A4 paper will result in a slightly reduced size.

1 PRODUCT OVERVIEW

Thank you for choosing the miniDSP C-DSP 8x12 advanced in-car audio processor. The C-DSP 8x12 features an onboard isolated power supply, stereo digital inputs (x2), 6 analog inputs, 12 analog outputs, and miniDSP's powerful but easy-to-use audio processing:

- Butterworth and Linkwitz-Riley crossovers up to 48 dB/octave
- Ten bands of parametric EQ (peaking/high shelf/low shelf/all pass) on every input and output channel
- Advanced biquad programming for an unlimited range of filters and crossover types
- An advanced matrix mixer for routing and mixing of any input to any output, with individual gain control and inversion at every mixing cross-point
- Compression, time delay and level adjustment on every output channel

Four complete processing configurations are stored on-board and can be selected from the wired remote or by infrared remote control.

1.1 TYPICAL USAGE

The C-DSP 8x12 typically connects to a head unit with up to six output channels and directly drives power amplifiers for multiple loudspeakers or drivers.

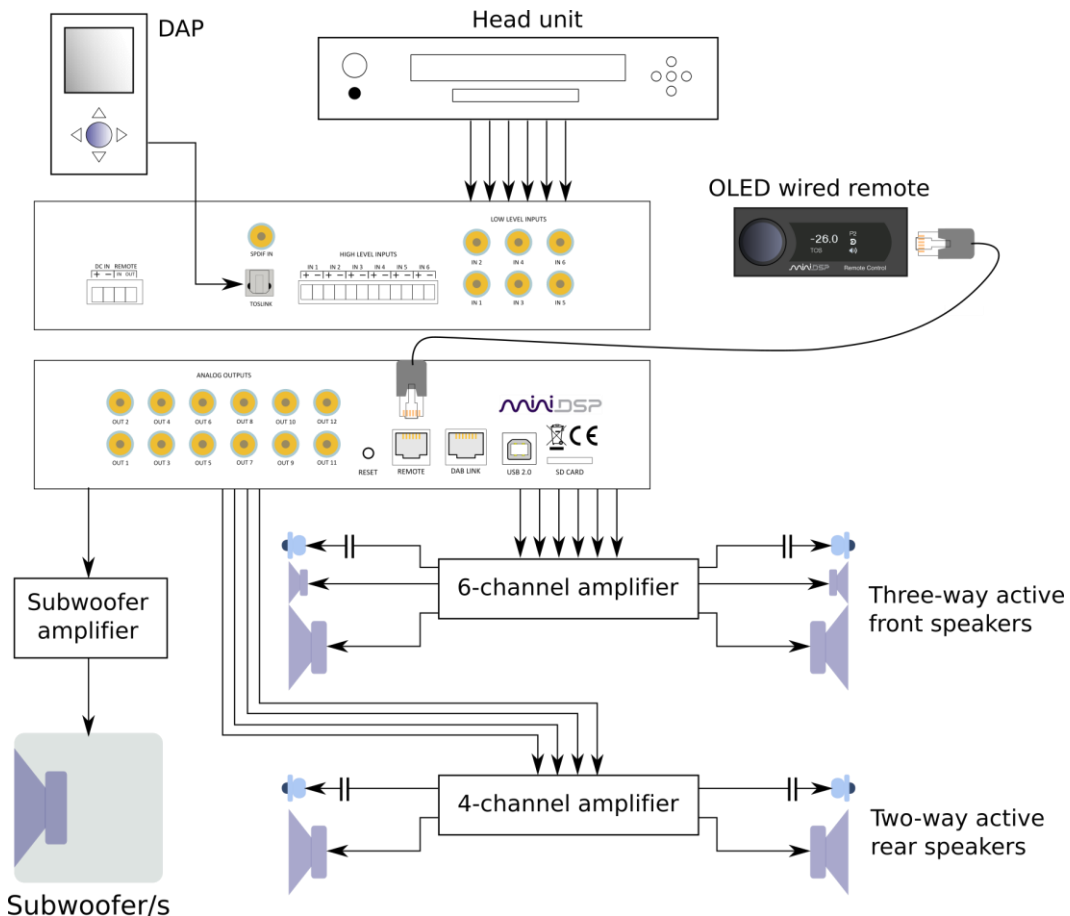

1.2 THE MINIDSP CONCEPT

The miniDSP concept is “one hardware unit + one software plugin = audio processing solution.” This concept leverages the inherent flexibility of DSP (digital signal processing) to deliver a range of flexible but cost-effective solutions.

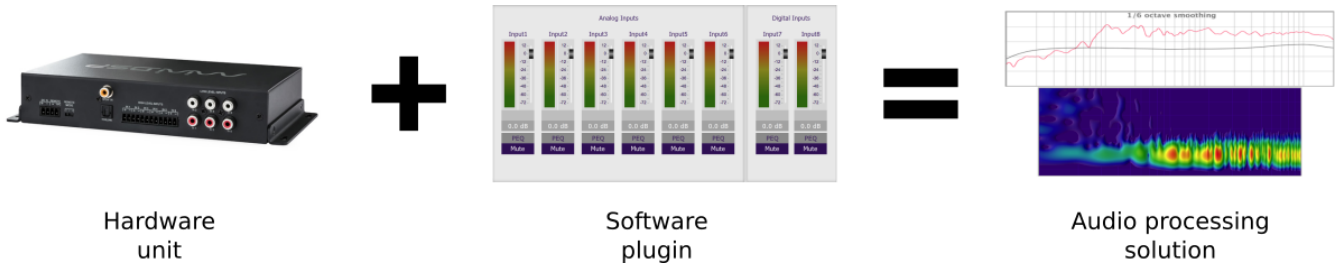

Hardware unit

In this case, the hardware unit is the miniDSP C-DSP 8x12.

Software plugin

The software plugin is installed on your PC or Mac, and determines the processing that the DSP will perform. It provides a friendly user interface, and downloads instructions into the miniDSP hardware unit that tell it how to process the audio signal. Currently, the C-DSP 8x12 supports a single plugin (see below).

Other platforms

miniDSP makes many other boxed and kit hardware units with analog, stereo digital, and multichannel digital (HDMI) connections. Some units feature inbuilt Class D amplification. See the [full range of miniDSP products](#).

1.3 PLUGIN FEATURE SUMMARY

The table below summarizes the key features of the **C-DSP 8x12** plugin:

	C-DSP 8x12 plugin
Number of digital input channels*	2
Number of analog input channels	6
Number of analog output channels	12
Digital input sample rate	44.1 to 192 kHz
Internal sample rate	192 kHz
PEQ bands per input channel	10
PEQ bands per output channel	10
Crossover order	6 to 48 dB/octave
Compressor on each output channel	Yes
Maximum per-channel time delay	25 ms

(*) Two selectable stereo digital inputs, 1 x RCA and 1 x TOSLINK.

2 THE MINIDSP WORKFLOW

We strongly recommend taking a methodical approach to your new miniDSP audio processor. Remember that the audio processor is a powerful tool, and incorrect settings can potentially cause damage to your system. *Please follow the steps below carefully.*

1. Download and install the plugin

Download and install your plugin, as described in Software installation starting on page 11.

2. Synchronize and reset

Don't connect any audio hardware to the processor yet. Connect the processor to the computer via USB and apply power (see [DC power](#) on page 16). Start the plugin and click on the **Connect** button near the top right. When the synchronization dialog comes up, click the **Restore Config** button.

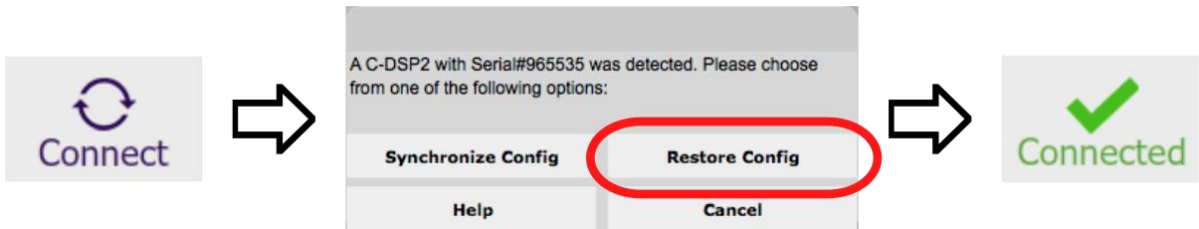

3. Upgrade the DSP program

Drop down the **Restore** menu and select **Upgrade DSP program**. This ensures that the DSP processor in the C-DSP 8x12 is running the latest software that matches your installed plugin.

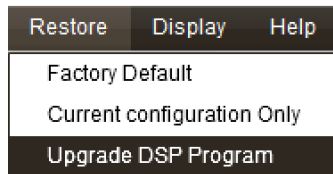

4. Familiarize yourself with the plugin

At this point, the plugin is online – that is, any changes made in the computer user interface will be immediately downloaded to the C-DSP. Familiarize yourself with the user interface presented by the plugin. Click on and explore each of the tabs (**Inputs**, **Routing**, and **Outputs**). Feel free to experiment.

After you are done exploring, drop down the **Restore** menu and select the **Factory Default** option. This will reset all processing parameters back to the defaults.

5. Perform initial configuration

Use the plugin to set up an initial audio processing configuration as intended for your application. Typical things that can be done at this point are to:

- Set the labels of input and output channels
- Mute unused input and output channels
- Set routing, crossover frequencies and slopes
- Set up any essential equalization

6. Save your configuration

Save your initial configuration to a file. A *configuration* is the set of all audio processing parameters. For more information on configurations, see [Working with configurations](#) starting on page 37.

7. Make audio connections

Remove power from the processor.

Now connect the miniDSP C-DSP 8x12 into your system. See [Hardware connectivity](#) starting on page 13 for details. *Ensure that all power is turned off when making audio connections.*

8. Go online

Apply power to the processor. (Leave other equipment turned off at this stage.) Connect the USB cable to your computer, click on the **Connect** button, and select the **Synchronize Config** option. If all goes well, you are now in *online mode* – any changes that you make in the plugin user interface will be immediately sent to the processor.



Before proceeding, click on each Configuration preset button (Config 1, 2, etc.) to ensure that all presets have been synchronized.

9. Initial audio check

1. Power on your connected equipment, first on the input side (e.g. head unit), then on the output side (e.g. power amps).
2. Turn the volume on your C-DSP 8x12 down low (view the Master Volume display in the plugin while turning the knob on the wired remote counter-clockwise) and start playing music or a pink noise test signal.
3. Gradually increase the volume until you hear audio quietly coming from the speakers.
4. Verify that the plugin is performing the intended function. (For example, for a two-way crossover, confirm that the tweeter plays high frequencies and the woofer plays low frequencies.)

10. Fine-tune your configuration

With your initial setup running, you can now proceed to fine-tune and optimize your system. You will need to perform acoustic measurements and use the configuration screens to adjust processing parameters.



Save your configuration on a regular basis while working on fine-tuning it. Configurations can be saved to different files to archive different versions and to enable auditioning of alternative configurations. Regular saving will also help ensure that you do not lose your work if you inadvertently reset the processor to default settings.

11. Continue to operate offline

With the processor configured, you can continue to operate in *offline mode*—that is, without the computer connected. To do so, quit the plugin or disconnect the USB cable. The processor will continue to operate without the computer.

Note: you can still change settings in the plugin user interface while in offline mode – these will be synchronized back to the processor next time you connect and select the **Synchronize Config** option.

3 SOFTWARE INSTALLATION

If you purchased your product directly from miniDSP, your software will be available from the [User Downloads](#) section of the miniDSP website when your order ships.

If you purchased your product from a miniDSP dealer, you will receive a coupon together with the product. Redeem this coupon and select the Plugin Group “CDSP 8x12” at the link below:

- <https://www.minidsp.com/support/redeem-coupon>

To access the download, you will need to be logged into the miniDSP.com website with the account you created when purchasing. The User Downloads link is visible from the dropdown menu at the top right of the website page:

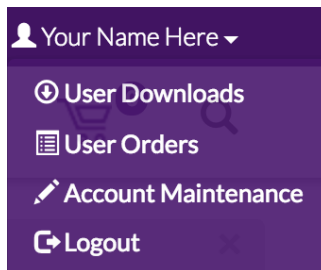

Navigate to the **C-DSP plug-ins** section and download the zip file under the heading **C-DSP 8x12 plugin**. Unzip the downloaded file: on Windows, right-click and select “Extract All...”; on Mac, double-click.

3.1 WINDOWS

The miniDSP software requires that other frameworks are installed for it to work. For Windows 7 and later, these packages should be installed automatically by the miniDSP installer.

For Windows XP and Vista, please download and install the following frameworks before attempting to install any miniDSP software:

- [Microsoft .NET framework](#) (version 3.5 or later)
- Microsoft Visual C++ 2010 Redistributable Package: for [x86](#) (32-bit operating system) or [x64](#) (64-bit operating system)

To install the plugin:

1. Navigate to the **Windows** folder of the software download.
2. Double-click on the **C-DSP-8x12.exe** installer program to run it. We recommend that you accept the default installation settings.
3. The plugin will start automatically if you accepted the default installation settings. To make it quicker to run in future, right-click on its icon in the taskbar and select “Pin to taskbar.”

Note 1: The plugin may need to connect to the Internet the first time you run the plugin.

Note 2: The first time you run the plugin, you may see a warning from Windows Firewall asking whether the software should be allowed network access. If you do, ensure that “Private networks...” is checked and “Public networks...” is not checked. Then click on “Allow access.”

3.2 MAC

To install the plugin:

1. Navigate to the **Mac** folder of the software download.
2. The installer program is named **C-DSP-8x12.pkg**. To run it, double-click on it, or right-click and open as described below. We recommend that you accept the default installation settings.
3. To run the plugin, locate **C-DSP-8x12.app** in the Applications -> miniDSP folder and double-click on it. To make it easier to run in future, right-click on its dock icon and select Options -> Keep in Dock.

Note 1: If double-clicking on an installer brings up a message that the installer cannot run, use this alternate method (note that the name of the plugin will be **C-DSP-8x12.pkg**, not **MiniDSP_Plugin.pkg** as shown in the screenshots):

1. Right-click on the installer (or click while holding the Control key).
2. On the menu that pops up, move the mouse over the “Open With” item and then click on “Installer (default).”

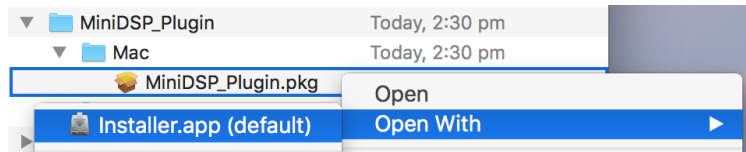

3. The following window will appear. Click on “Open.”



Note 2: The plugin may need to connect to the Internet the first time you run the plugin.

4 HARDWARE CONNECTIVITY

Connections to the C-DSP 8x12 are made on the front and rear panels.

4.1 ANALOG INPUTS

4.1.1 Low-level inputs

Low-level analog connections are made directly to the RCA jacks on the front panel. Be sure to take careful note of the channel numbering shown in this diagram and on the front panel. These inputs accept a maximum input voltage of either 2 or 4 VRMS, depending on the input sensitivity switch setting (see page 45).

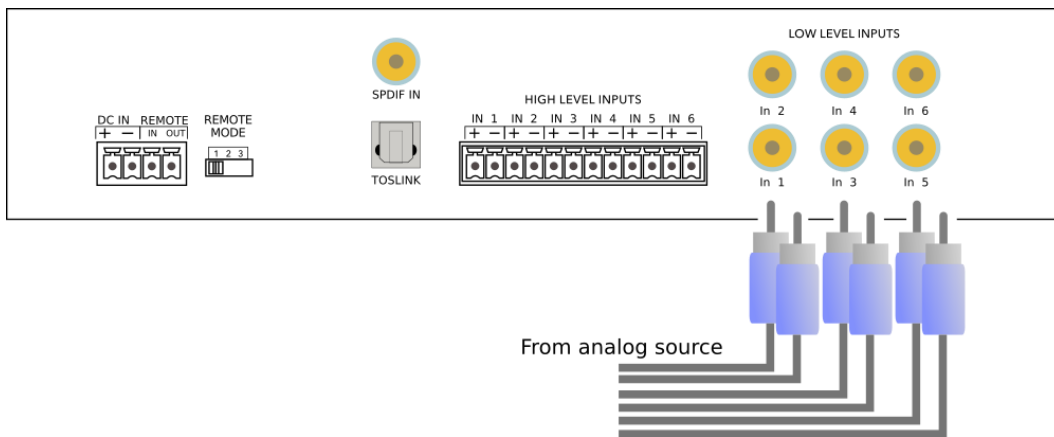

Note that these are fully differential inputs. A regular RCA-RCA cable be used to connect from equipment with single-ended outputs, as shown in Figure 1.



Figure 1. Single-ended RCA connection

If connecting to equipment with balanced output, connect the negative or “cold” leg to the RCA shield and the positive or “hot” leg to the RCA tip, as shown in Figure 2.



Figure 2. Connecting a balanced source to the C-DSP 8x12.

4.1.2 High-level inputs

High-level (speaker-level) connections can be made by connecting bare wire ends to the push-in terminal block. Remove the terminal block and connect individual positive and negative wires to each screw terminal. After all connections are secure, firmly re-insert the terminal block.

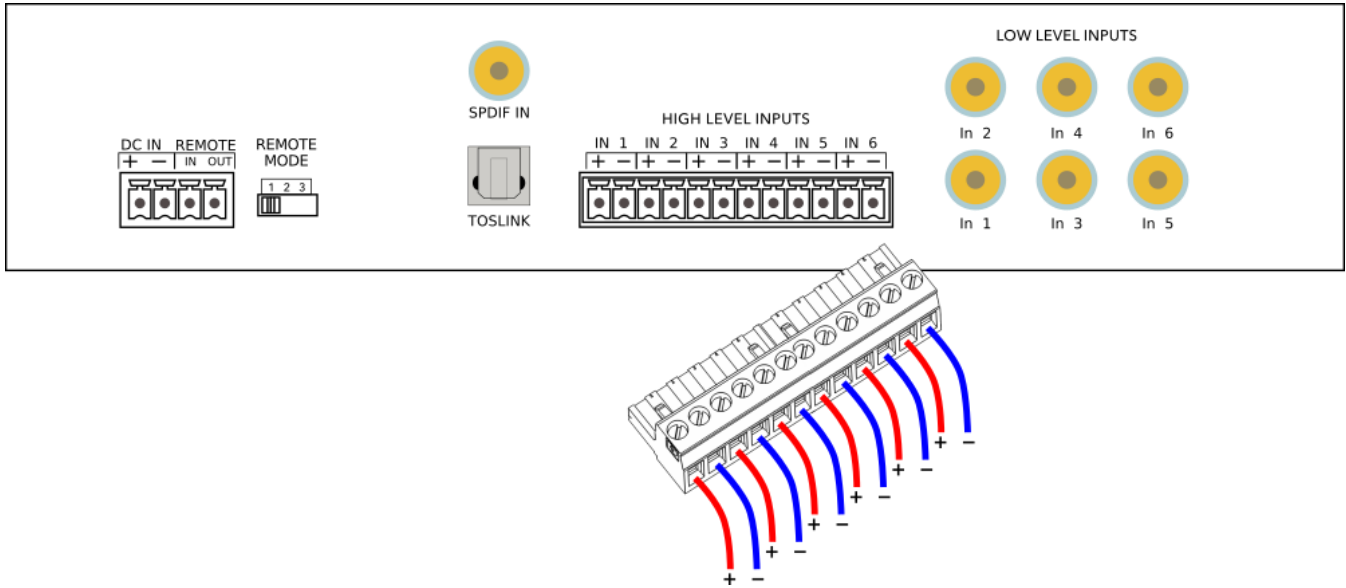

The high-level inputs have an input impedance of 68 Ω and are designed for connection to power amplifier outputs. The inputs are fully differential, therefore:

- Amplifiers with bridged outputs can be used.
- Do **not** connect the “-” outputs together. This can potentially damage amplifiers.

The maximum (differential) input voltage is either 8 or 12 V RMS, depending on the input sensitivity switch setting (see page 45). The 8 V RMS setting corresponds to a maximum amplifier power of 16 Watts into 4 ohms. The 12 V RMS setting corresponds to a maximum amplifier power of 36 Watts into 4 ohms.

4.2 DIGITAL INPUT

Two digital sources can be connected via the S/PDIF coax (RCA) connector and the TOSLINK (optical) connector. Switching between sources can be done from within the plugin or with a remote control.

The left and right channels of the selected digital input are mixed with the analog inputs as specified by the cross-points on the **Routing** tab (page 23).

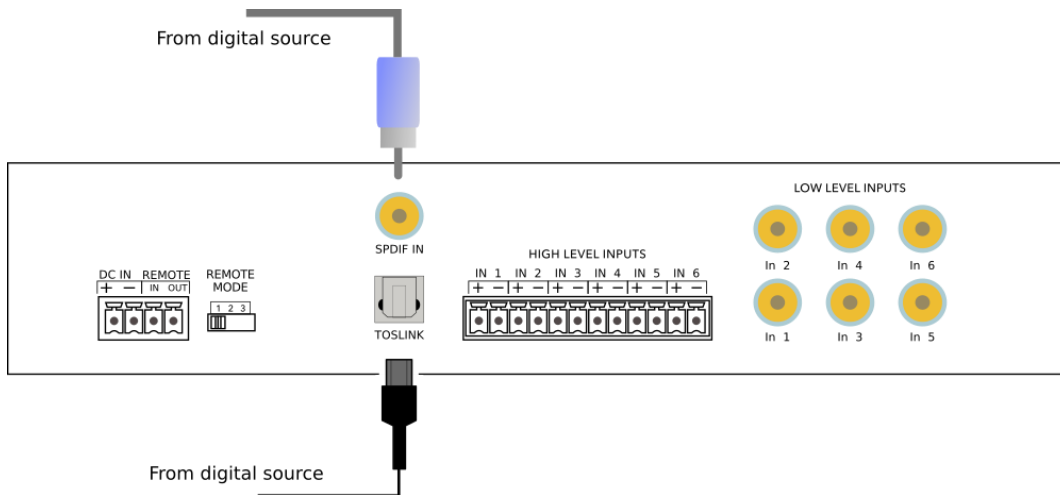

Note: the digital inputs accept only a stereo PCM digital signal. They do not accept encoded or multichannel digital audio.

4.3 ANALOG OUTPUTS

There are twelve analog output channels. Unbalanced connections are made from the RCA jacks on the rear panel to the power amplifiers. Be sure to take careful note of the channel numbering shown in this diagram and on the rear panel.

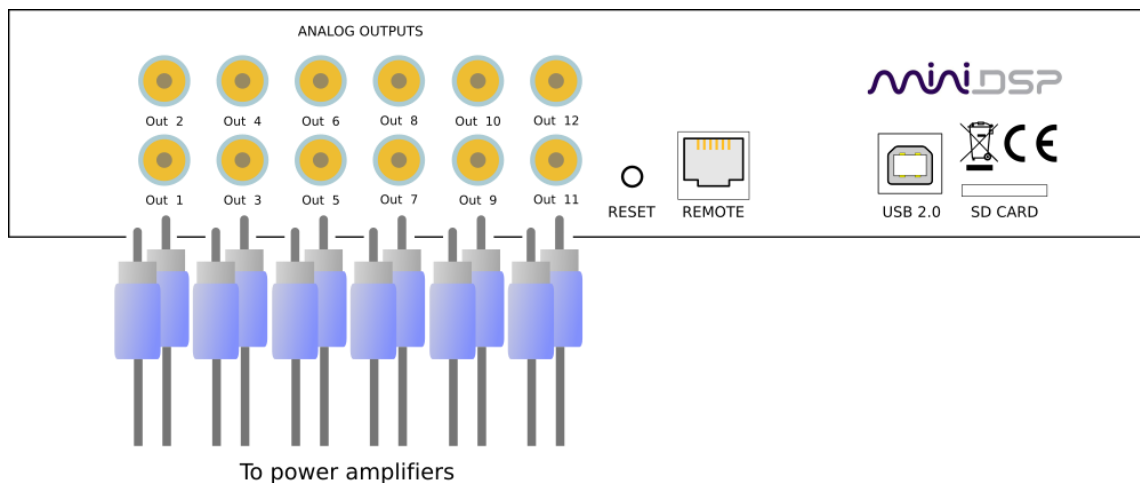

4.4 DC POWER

The C-DSP 8x12 incorporates an isolated DC-DC power convertor and is designed for direct connection to the vehicle's power supply (nominally 12 V DC). Power is connected via a four-way terminal block. There are two modes of operation, described below.

4.4.1 Powered on power (position 1)

To power on the C-DSP 8x12 whenever 12 V DC is applied to the **DC IN** terminals, set the **REMOTE MODE** switch to position 1. Typically, power is provided from the main vehicle supply (always on).

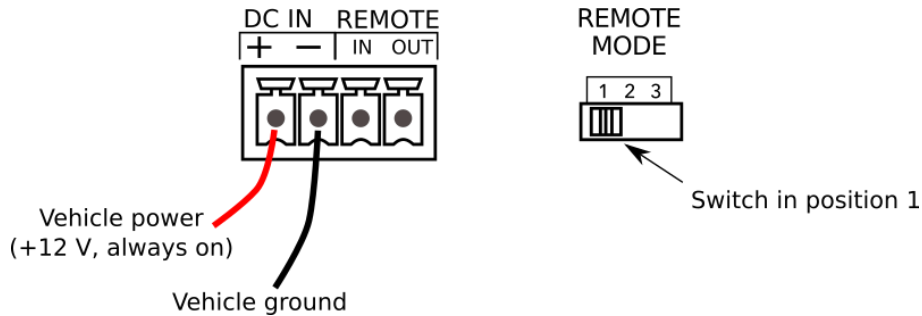

4.4.2 Remote trigger (position 2)

To reduce battery drain, the remote trigger option should be used. To enable remote trigger, set the **REMOTE MODE** switch to position 2. In this case, the C-DSP 8x12 is powered on when the voltage on the **REMOTE IN** terminal exceeds 4 V DC. Typically, **REMOTE IN** is connected to the remote trigger output from the head unit.

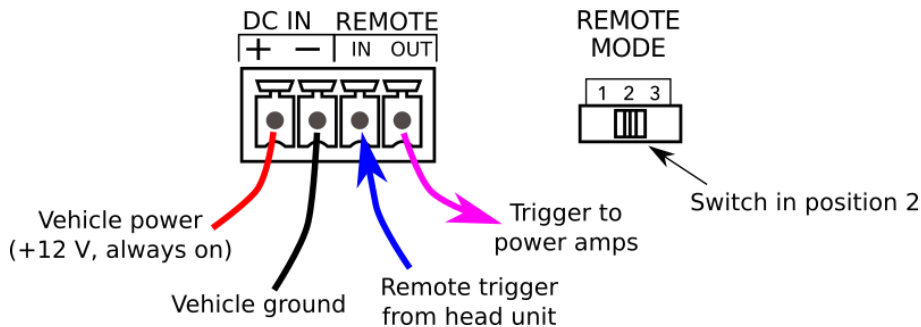

In this mode, the **REMOTE OUT** terminal should be used to turn on the power amplifier(s). There is a time delay between **REMOTE IN** going positive and **REMOTE OUT** going positive. This can be configured in the plugin – see page 40.



Position 3 of the **REMOTE MODE** switch is reserved for future use. Do not set the switch to position 3.

4.5 WIRED REMOTE

The wired remote can be positioned anywhere in the vehicle and is connected via the supplied RJ11 phone cable. The plugs on each end simply plug into the base of the remote and into the rear panel of the C-DSP 8x12. The wired remote also contains the receiver for infrared remote control.

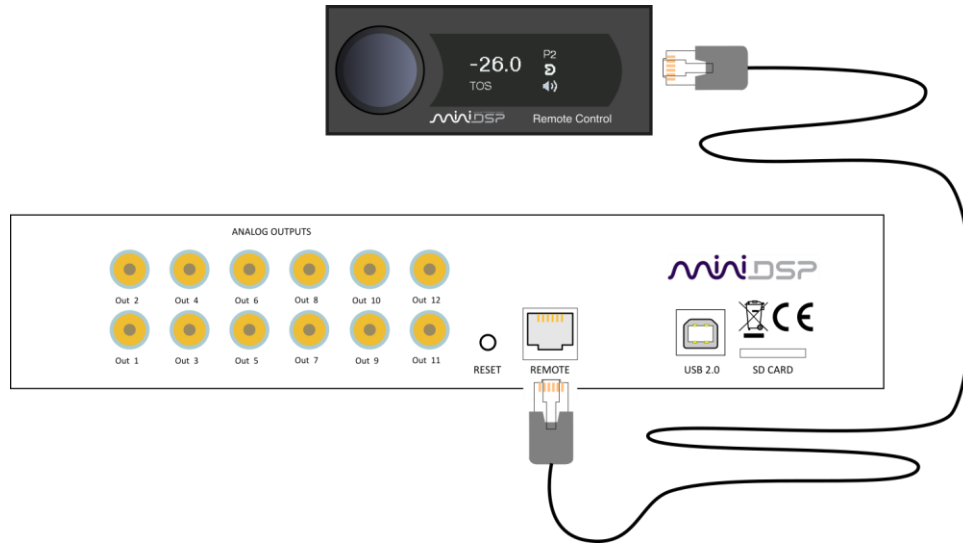

4.6 USB

To configure the processor, connect its USB port to a USB 2.0 port on your computer using the supplied cable. Note that USB is used only for configuration — audio data cannot be streamed to the processor over USB.

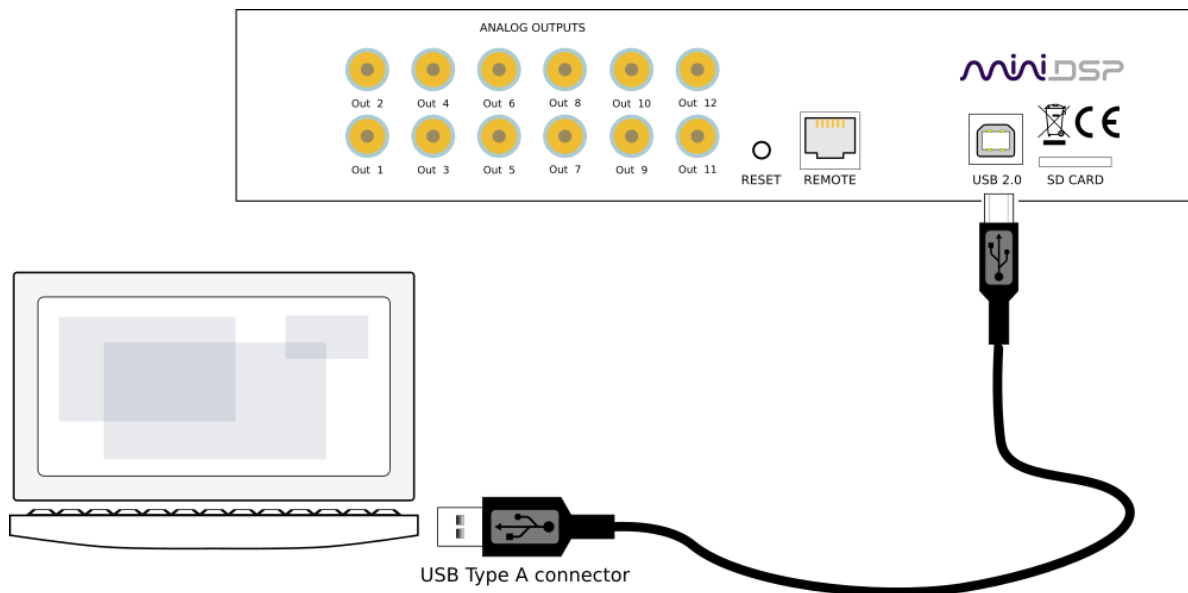

5 CONFIGURING THE PROCESSOR

The C-DSP 8x12 processor is configured with the **C-DSP 8x12** plugin / user interface program. Once fully configured, the computer is no longer required and the unit can be controlled with the wired remote or an infrared remote control. If desired, however, the plugin can remain connected during use for real-time (“live”) control of all audio processing.

This screenshot shows the **C-DSP 8x12** plugin with the key areas highlighted:

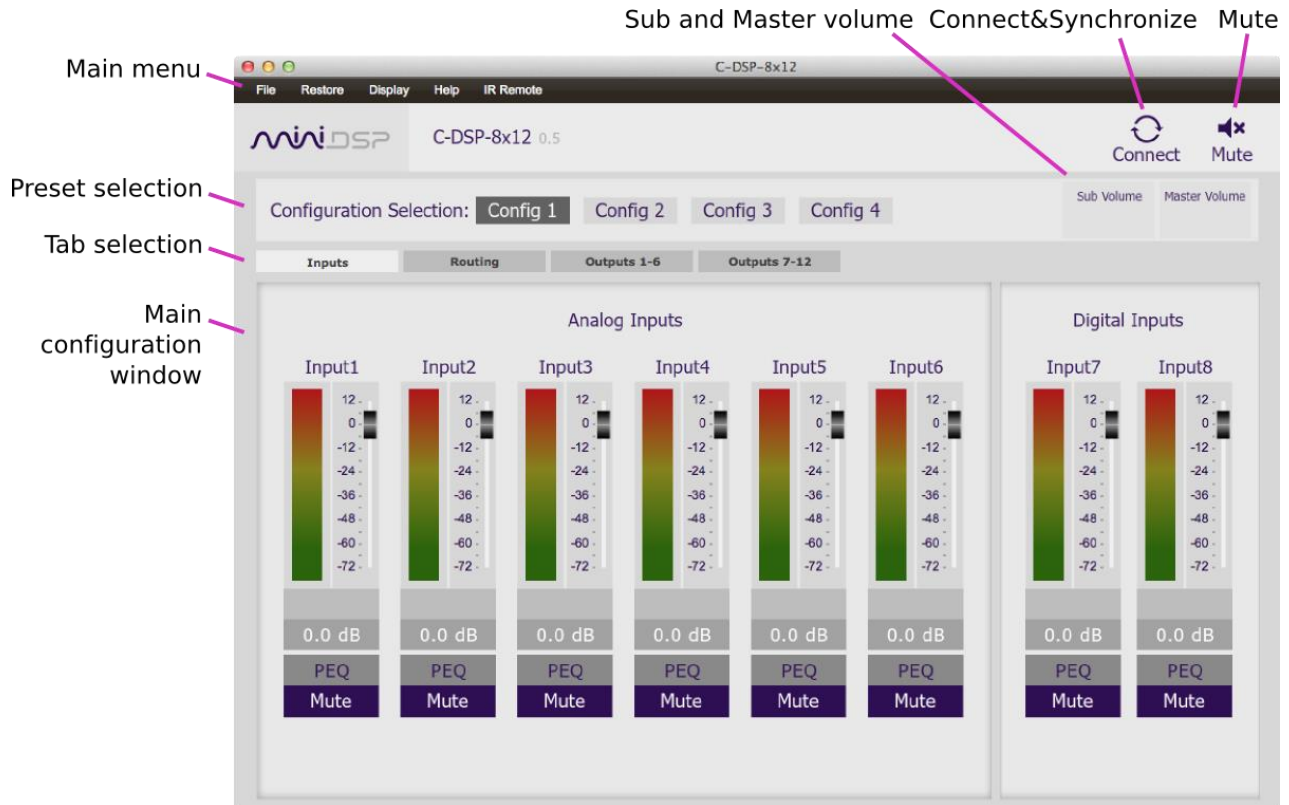

During *initial* configuration of the processor, it is strongly recommended that any connected amplification be muted or powered off.

5.1 SYNCHRONIZING WITH THE PROCESSOR

Communication with the C-DSP takes place over USB. Note that USB is used for control purposes only. Audio data cannot be streamed to the processor over USB.

Ensure that the computer is connected to the processor via a USB 2.0 port. Then click on the **Connect** button:



The first time you connect, or if you have made any changes to any data in the user interface, the following dialog box will appear:

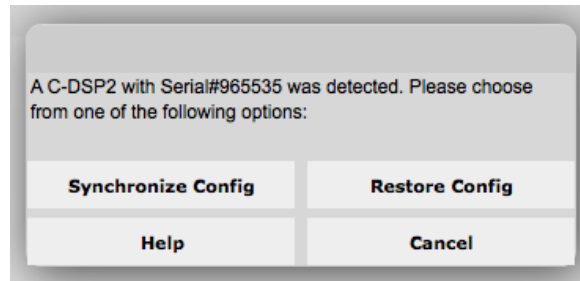

The options are:

Synchronize Config

Download the currently selected configuration into the corresponding configuration preset of the processor. After downloading the configuration data, the plugin is in *online* mode and any changes to processing parameters will be downloaded immediately in real time. That is, the user interface is now “live.”

Synchronize and Upgrade

This is similar to Synchronize Config, but also upgrades the internal data of the processor. This option may appear after downloading and installing an updated version of the plugin.

Restore Config

Restore the data in the currently selected configuration to the factory defaults. When using this option, any connected output equipment should be muted or powered off until you have set the configuration to a working state. *Note that the configuration data currently stored in the processor will be deleted.*

Cancel

This option cancels the attempt to connect to the processor. The plugin will remain in offline mode.

5.2 MASTER MUTE

The **Mute** button disables all audio output:



5.3 SUBWOOFER AND MASTER VOLUME

The C-DSP 8x12 has two modes of volume control operation:

- **Master volume mode.** In this mode, the wired remote and infrared remote control the master volume i.e. all output channels.
- **Subwoofer volume mode.** In this mode, the wired remote and infrared remote control the volume of just a selected set of channels. This is typically used to control subwoofer volume but can also be used in other ways – for example, to control rear channel speaker level.

The current values for master and subwoofer volume are displayed in the plugin while connected:



5.3.1 To select the channels controlled in Subwoofer Volume mode

Drop down the **Display** menu and select **Subwoofer Channels Selection**. In the dialog box, check the channels to be controlled. Note that any number of channels can be selected.

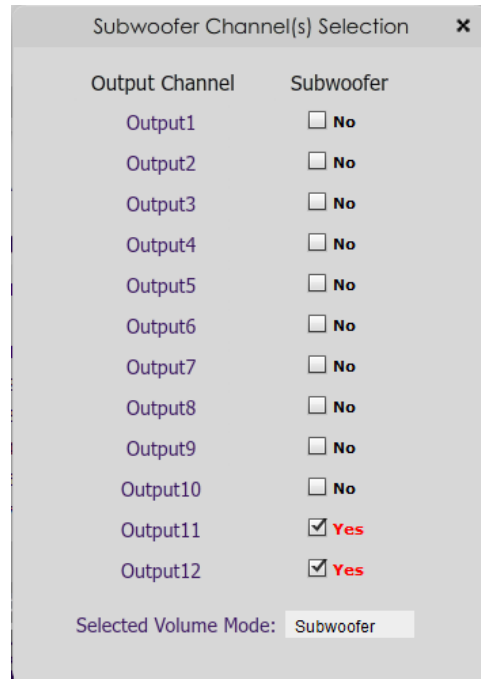
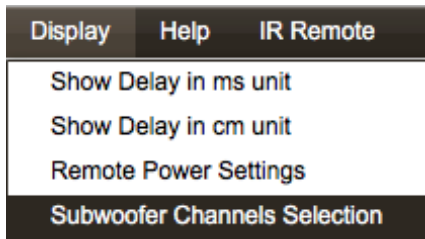

5.3.2 To change the volume control mode

Open the **Subwoofer Channels Selection** dialog box. Use the dropdown labeled **Selected Volume Mode** to select the desired mode.

The volume control mode can also be changed with the wired remote.

5.4 INPUTS TAB

The **Inputs** tab displays a row of input channel control strips:

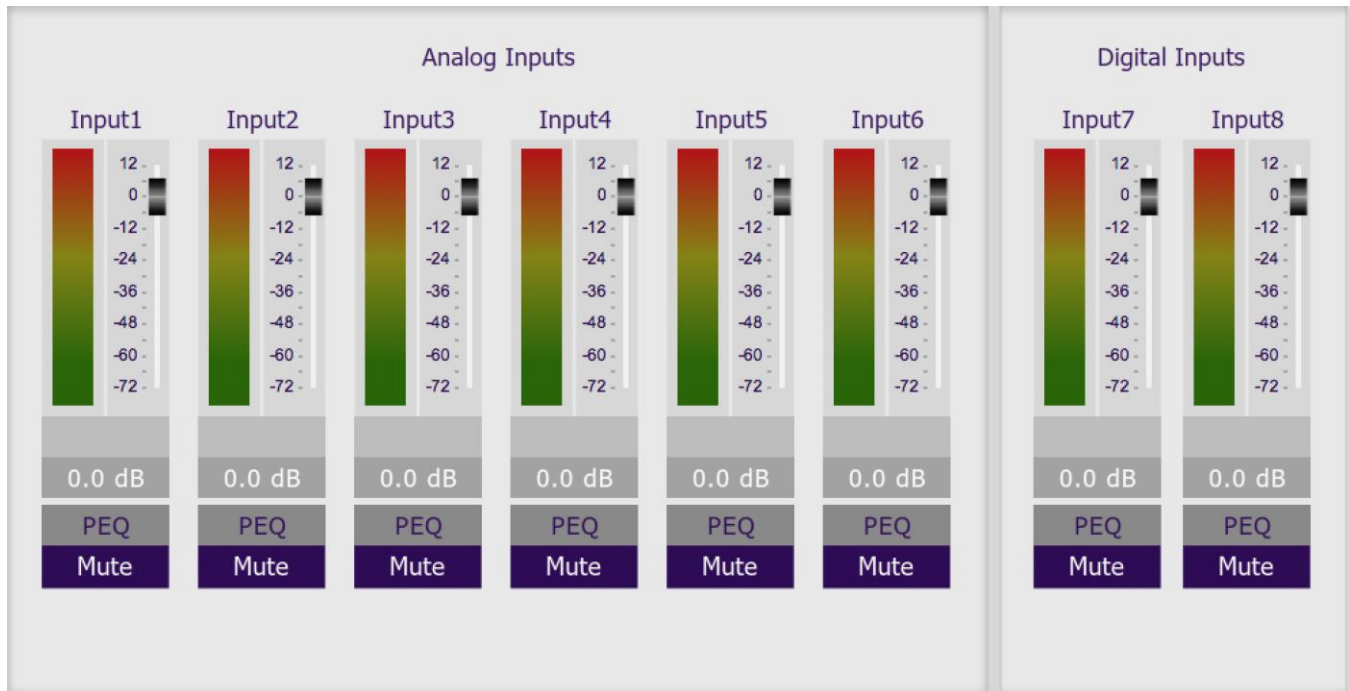

5.4.1 Digital input selection

When the plugin is connected to the C-DSP 8x12, the currently selected digital input appears above input channel strips 7 and 8. Click on the current input name to drop down a selector menu, from which you can select the input. (You can also select the digital input with an infrared remote control.)

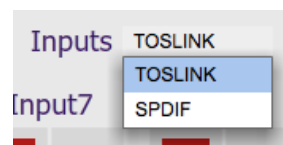

TOSLINK

Selects the stereo optical digital input.

SPDIF

Selects the stereo coax (RCA) digital input.

The left and right channels of the selected digital input are mixed with the analog inputs as specified by the cross-points on the **Routing** tab (page 23).

5.4.2 Input channel strips

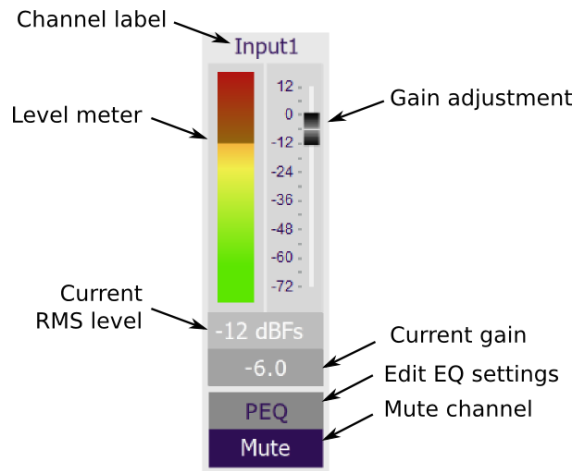

Channel label

Each input channel has a customizable label, which is shown at the top of the channel strip. This label also appears on the **Routing** matrix. To change the label, click on it, type a new label (up to eight characters), and press the Return key.

Level meter, Current RMS level

Displays the current signal level in real time. (The plugin must be in online mode to display signal levels.)

Gain adjustment

The gain of each channel can be adjusted by moving the Gain Adjustment slider, or by typing the desired gain into the Current Gain text box. The maximum gain setting is 12 dB and the minimum gain setting is -72 dB. (0 dB, the default, is unity gain or no change in level.)

PEQ settings

Click on this button to open the parametric EQ settings window for that channel. There are ten parametric EQ filters on each input channel. For more details, see Parametric EQ on page 28.

Mute

Press this button to mute that input channel. The button color and label changes to show that the channel is muted.



5.5 ROUTING TAB

The **Routing** tab displays the matrix mixer, which sets up routing and mixing from input channels to output channels. The input channels are labeled along the left and the output channels along the top. The labels that appear along the left and the top can be changed on the **Inputs** and **Outputs** tabs.

The routing tab is the key to the extraordinary flexibility of the miniDSP C-DSP 8x12. This is the default routing tab:

	Output1	Output2	Output3	Output4	Output5	Output6	Output7	Output8	Output9	Output10	Output11	Output12
Input1	0dB	Off	Off	Off	Off	Off	Off	Off	Off	Off	Off	Off
Input2	Off	0dB	Off	Off	Off	Off	Off	Off	Off	Off	Off	Off
Input3	Off	Off	0dB	Off	Off	Off	Off	Off	Off	Off	Off	Off
Input4	Off	Off	Off	0dB	Off	Off	Off	Off	Off	Off	Off	Off
Input5	Off	Off	Off	Off	0dB	Off	Off	Off	Off	Off	Off	Off
Input6	Off	Off	Off	Off	Off	0dB	Off	Off	Off	Off	Off	Off
Input7	Off	Off	Off	Off	Off	Off	0dB	Off	Off	Off	Off	Off
Input8	Off	Off	Off	Off	Off	Off	Off	0dB	Off	Off	Off	Off

When a cross-point is turned on, the input signal (at the left) is routed to the output channel (at the top). In the default routing, Input1 is routed to Output1, Input2 to Output2, and so on.

5.5.1 Mixing channels

If more than one input channel is routed to the same output channel, the input channels are mixed (summed together). This can be used, for example, to mix multiple inputs to create a subwoofer feed. Here is a simple example, with left and right input channels, left and right output channels, and one mono (mixed) subwoofer output channel:

	Left Out	Rght Out	Sub Out
Left In	0dB	Off	0dB
Right In	Off	0dB	0dB

(This screenshot and the others in the rest of this section show just part of the routing matrix, with informative labels set in the **Inputs** and **Outputs** tabs. The examples are simplified for the purposes of explanation.)

Typically, for an example like this, the left and right output channels will have a high pass filter set at around 80 Hz. The subwoofer output channel will have a low pass filter also set at around 80 Hz.

5.5.2 Routing to multiple outputs

Each input channel can be routed to multiple outputs. There is no limit – an input signal could be sent to all twelve outputs if desired, with no effect on signal quality.

Example 1 – additional subwoofers

A simple example is shown on the previous page, where both inputs are sent both to the corresponding left or right speaker channel and to the subwoofer channel. This example can easily be expanded by adding additional subwoofer output channels.

	Left Out	Rght Out	Left Sub	Rght Sub	Rear Sub
Left In	0dB	Off	0dB	Off	0dB
Right In	Off	0dB	Off	0dB	0dB

Example 2 – active speakers

The C-DSP 8x12 can create complex active speaker systems. Each audio channel is routed to two or more output channels. Here is an example for three-way speakers:

	Woof L	Mid L	Tweet L	Woof R	Mid R	Tweet R
Left In	0dB	0dB	0dB	Off	Off	Off
Right In	Off	Off	Off	0dB	0dB	0dB

On the output channels, crossovers must be set up on the **Xover** screen (see page 30 for details):

- Woofer: low pass filter enabled
- Midrange: low pass and high filters enabled
- Tweeter: high pass filter enabled

To illustrate, this is the **Xover** screen for the midrange channel:

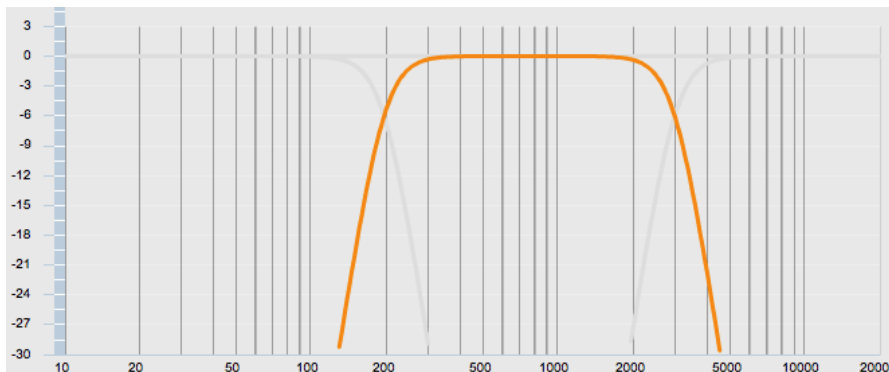

Usually, you will also link the crossover settings for the corresponding left and right channels: Woof L linked to Woof R, Mid L to Mid R and so on.

5.5.3 Cross-point gain and inversion

At each cross-point, the gain of each signal being mixed can be set to a value between -72 and +12 dB. To set the gain, right-click on the cross-point and a gain control will appear. Set the gain by moving the slider, or alternatively, type the value in directly into the entry box, *press the Enter key*, then click the **close** button.

Each cross-point can also have the signal inverted by clicking on the **Invert** button. When the mixed signal is inverted, the button will be displayed in green and its label will change to “Inverted”.

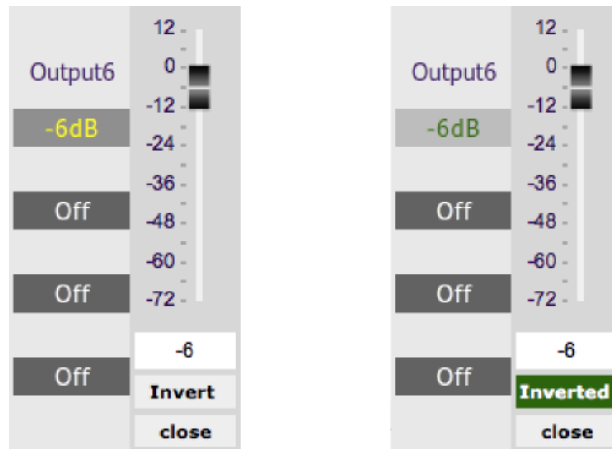

The **Invert** button is useful in applications such as generating a difference signal for rear fill. If you want to try this, experiment as follows:

1. Create L–R and R–L signals as shown in the matrix below.
2. Add a delay of about 20 ms to the rear channel outputs.
3. Add high pass and low pass filters to the rear channels to limit bandwidth (experiment to see what sounds best).

	Front L	Front R	Rear L	Rear R
Left In	0dB	Off	-6dB	-6dB
Right In	Off	0dB	-6dB	-6dB

5.6 OUTPUT TABS

There are two output tabs: one for channels 1 to 6 and one for channels 7 to 12. Each displays a row of output channel control strips. All output channels are identical.

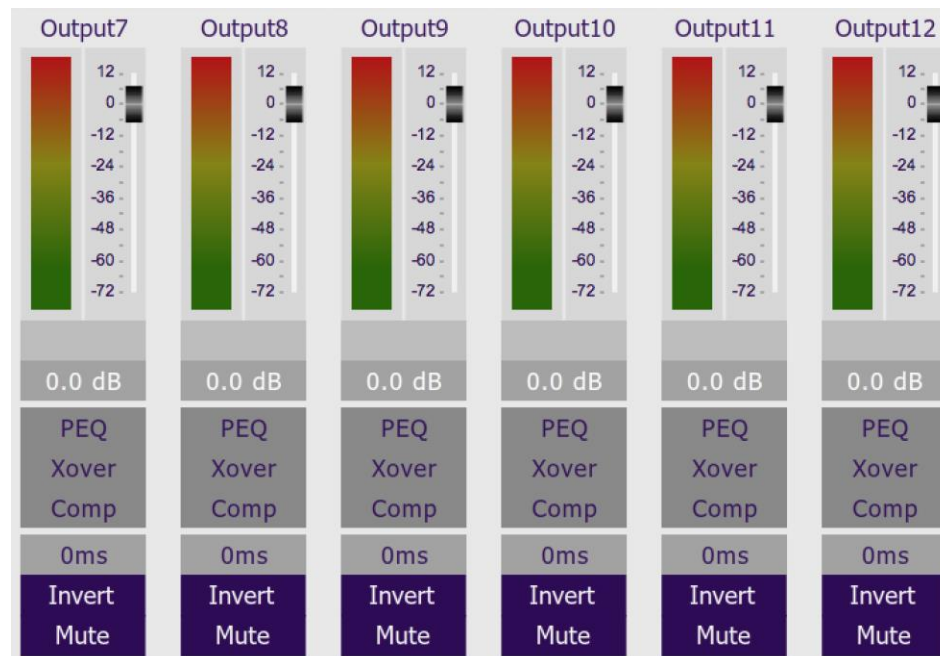
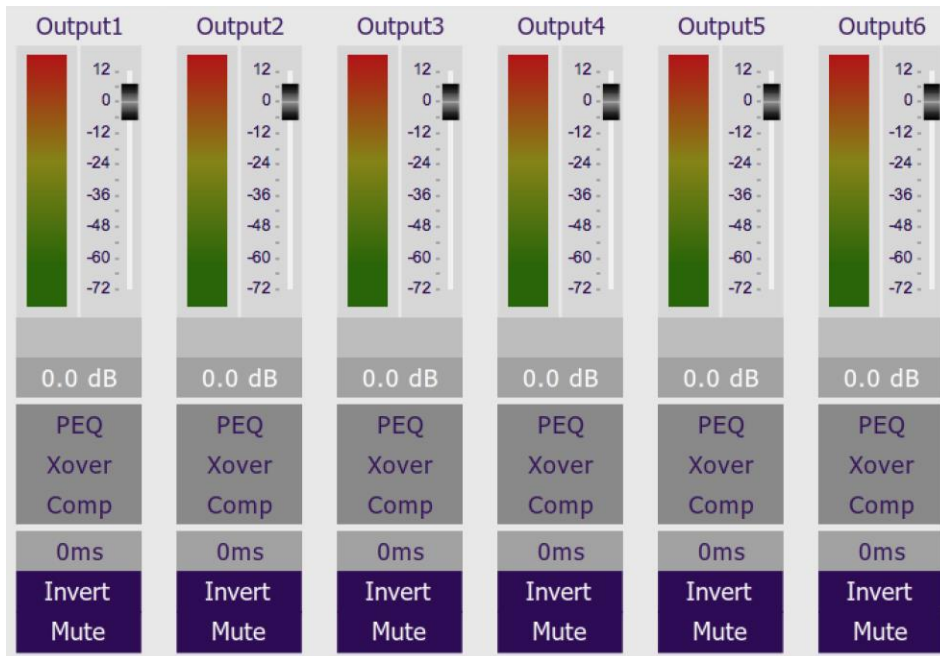

5.6.1 Channel strip layout

Each output channel has a complete "strip" of controls.

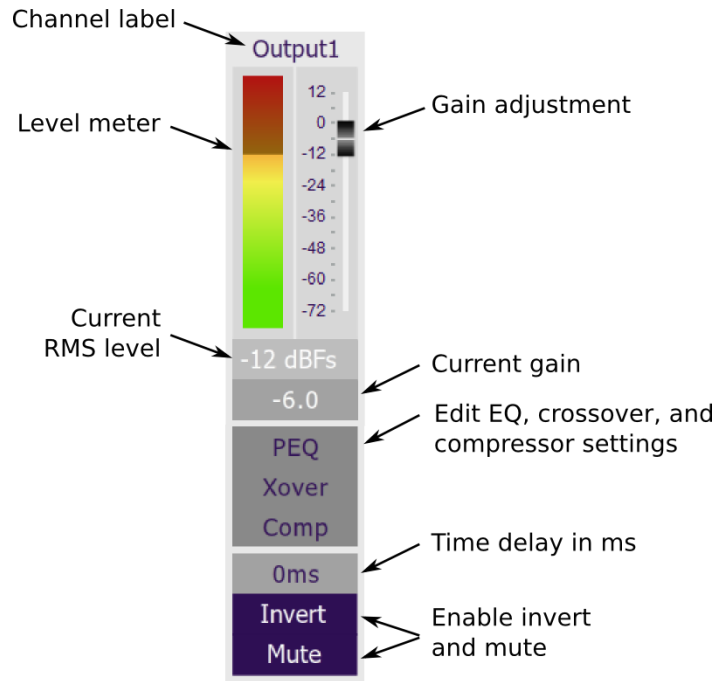

5.6.2 Channel label

Each output channel has a customizable label, which is shown at the top of the channel strip. This label also appears on the **Routing** tab. To change the label, click on it, type a new label (up to eight characters), and press the Return key.

5.6.3 Level meter and gain control

Level meter, current RMS level

Displays the current signal level in real time. (The plugin must be in online mode to display signal levels.)

Gain adjustment

The gain of each channel can be adjusted by moving the Gain Adjustment slider, or by typing the desired gain into the Current Gain text box. The maximum gain setting is 12 dB, and the minimum gain setting is -72 dB. (0 dB, the default, is unity gain or no change in level.)

The level meters are useful in many situations. For example, when adding filters with boost, monitor the level meters with typical signals and maximum levels to ensure that there is no clipping. The meters can also be used during normal operation to monitor for or to help locate level or gain structure problems.

5.6.4 Parametric EQ

Parametric equalization (PEQ) is a flexible type of equalization filter. It can be used to correct for errors in loudspeaker output, to compensate for acoustic room/cabin effects, and to tailor the overall system response for best sound. Click on the PEQ button to open the parametric equalizer settings window:

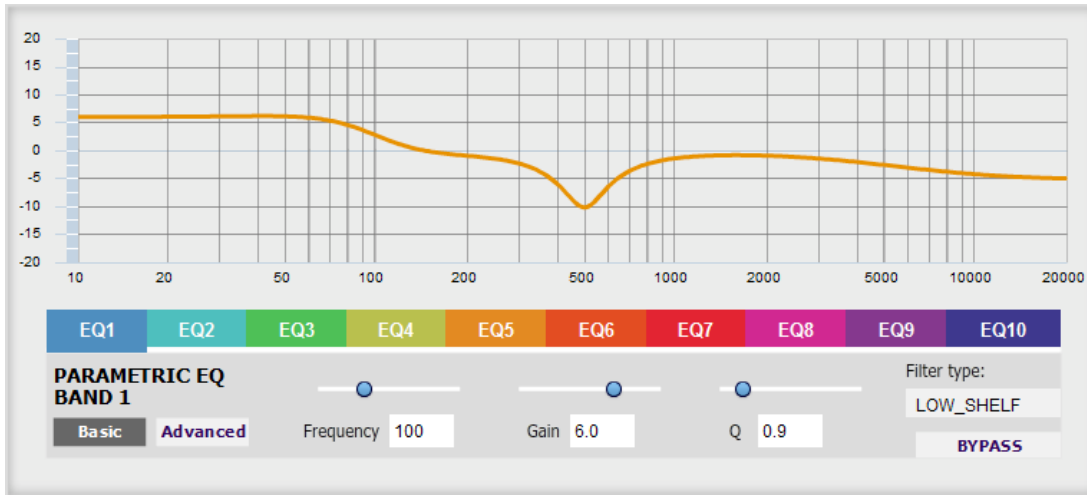

There are 10 parametric EQ filters on each input and output channel. The window displays a frequency response graph showing the combined response of all enabled filters on that channel. For example, the screenshot above shows a response curve created with a low-shelf boost filter at 100 Hz, a dip at 500 Hz, and a high-shelf cut filter at 5000 Hz.

Hovering the mouse over the curve brings up an overlay showing the frequency and the gain at that frequency.

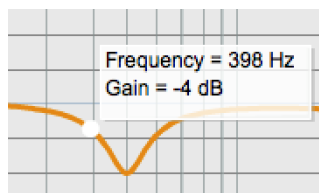

Each channel can be linked to one other channel. When a channel is linked to another, the PEQ settings of that channel are mirrored to the other. Typically, the corresponding drivers on the left and right channels are linked: left and right tweeter, left and right woofer, and so on. To link a channel, select the other channel from the drop-down menu at the top left of the **PEQ** screen, and click the **Link** checkbox.

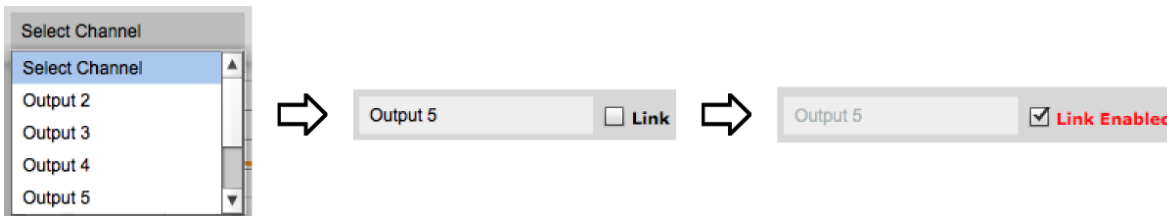

EQ band selection

Click on the tabs **EQ1**, **EQ2**, etc. to display the parameters for that filter.

Basic/Advanced

By default, each filter is in basic mode and shows the controls described below. Advanced mode enables custom biquad programming for almost infinite flexibility in filter implementation. This is described in [Custom biquad programming](#) on page 34.

Filter type

Selects the type of filter:

- PEAK** Create a dip or a peak in the frequency response.
- LOW_SHELF** Reduce or increase part of the frequency spectrum *below* a given frequency.
- HIGH_SHELF** Reduce or increase part of the frequency spectrum *above* a given frequency.
- ALL_PASS** Create a phase shift across the frequency band. This can be useful for correcting phase issues and for simulating analog crossovers.

Frequency

For the PEAK filter type, this is the center frequency of the peak or dip. For the HIGH_SHELF and LOW_SHELF filter types, this is the frequency at which the gain is half of the set value. For the ALL_PASS filter type, this is the center frequency of the phase shift.

Gain

For the PEAK filter type, this is the gain in dB at the center frequency. For the HIGH_SHELF and LOW_SHELF filter types, this is the gain in dB reached at high or low frequencies respectively. A filter has no effect if its gain is set to 0 dB. Gain can be adjusted in increments of 0.1 dB up to +/- 16 dB. This item is not present for the ALL_PASS filter type.

Q

Q controls the “sharpness” of the filter. For the PEAK filter type, lower Q gives a broader peak or dip, while higher Q gives a narrower peak or dip. For the HIGH_SHELF and LOW_SHELF filter types, Q controls how quickly the filter transitions from no gain to maximum gain. For the ALL_PASS filter type, higher Q gives a steeper phase transition.

Bypass

The **Bypass** button enables or disables a filter. The filter is enabled if the button says “BYPASS” and disabled if the button says “BYPASSED” (see screenshot below). Note that this button only enables and bypasses a single filter; all other filters must be bypassed or enabled individually.



5.6.5 Crossover

Each output channel has independent high pass and low pass crossover filters. Click on the **Xover** button to open the crossover settings window:

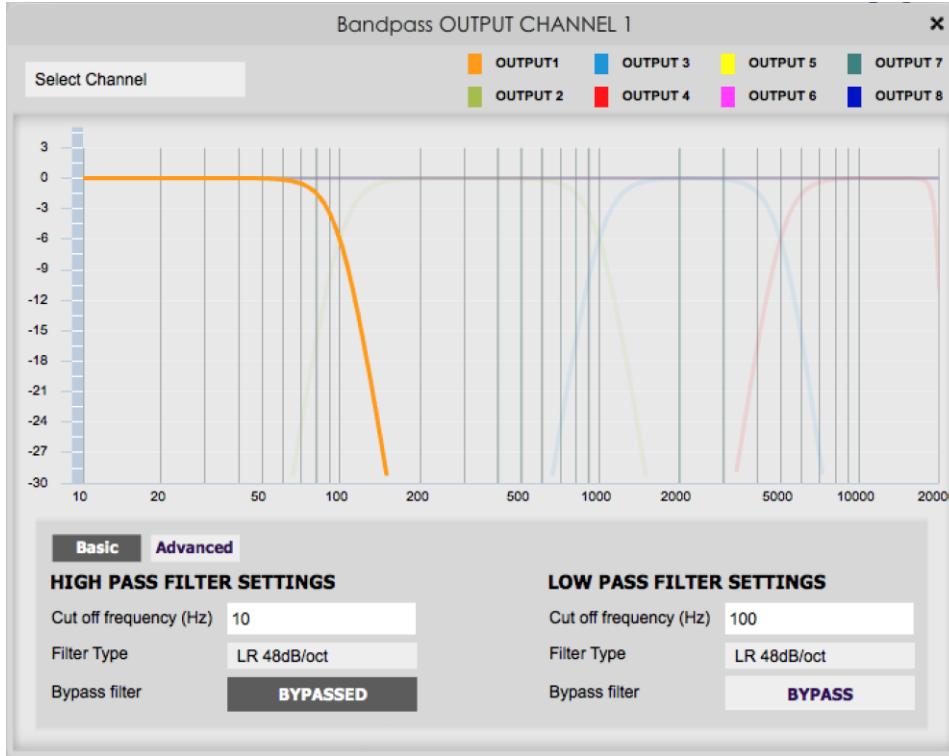

Crossovers “split” the frequency band to send to different drivers. In a two-way loudspeaker, for example, a *low pass* filter is used to remove high frequencies from the signal sent to the woofer, and a *high pass* filter is used to remove low frequencies from the signal sent to the tweeter. In a three-way speaker, the midrange driver will use both the high pass and low pass filters. Crossover filters can also be used to limit low frequency content delivered to a speaker or subwoofer, to help protect it from over-excursion.

Unlike conventional analog crossovers, the flexibility of DSP allows a completely arbitrary mix of different filter slopes and types. Filters can be set at any frequency or disabled completely. This allows maximum flexibility in matching your crossover to the acoustic characteristics of the loudspeaker drivers.

Hovering the mouse over the curve brings up an overlay showing the frequency and the attenuation at that frequency.

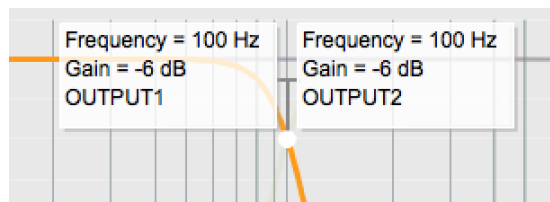

Basic/Advanced

By default, the crossover is in basic mode and shows the controls described below. Advanced mode enables custom biquad programming for almost infinite flexibility in crossover filter implementation. This is described in [Custom biquad programming](#) on page 34.

Cutoff Frequency

Sets the nominal cutoff frequency of the crossover. In actual fact, the crossover has a more or less gradual transition from “full on” to “full off,” as determined by the filter slope.

Filter type

Selects the type and slope of the filter. The steeper the slope, the more quickly frequencies above or below the cutoff frequency are attenuated. There are three types of filter:

Butterworth (BW)

Available in 6, 12, 18, 24, 30, 36, 42, and 48 dB/octave, Butterworth crossover filters are 3 dB down at the cutoff frequency.

Linkwitz-Riley (LR)

Available in 12, 24, and 48 dB/octave, Linkwitz-Riley crossover filters are 6 dB down at the cutoff frequency.

Bessel

Available in 12 dB/octave only, a Bessel filter gives a more gradual roll-off through the crossover region.

Bypass

The **Bypass** button enables or disables a crossover filter. The filter is enabled if the button says “BYPASS” and disabled if the button says “BYPASSED” (see screenshot below).



Each channel can be linked to one other channel. When a channel is linked to another, the crossover settings of that channel are mirrored to the other. Typically, the corresponding drivers on the left and right channels are linked: left and right tweeter, left and right woofer, and so on. To link a channel, select the other channel from the drop-down menu at the top left of the **Xover** screen, and click the **Link** checkbox.



5.6.6 Compressor

The compressor reduces the gain of an output channel when the audio signal exceeds the level specified by the **Threshold** parameter. The gain of the channel will be progressively reduced as the signal increases above the threshold, as specified by the **Ratio** parameter. This can be used to limit the power delivered to speakers and thus reduce the risk of damage from overdriving.

This screenshot shows an example Compressor setting:

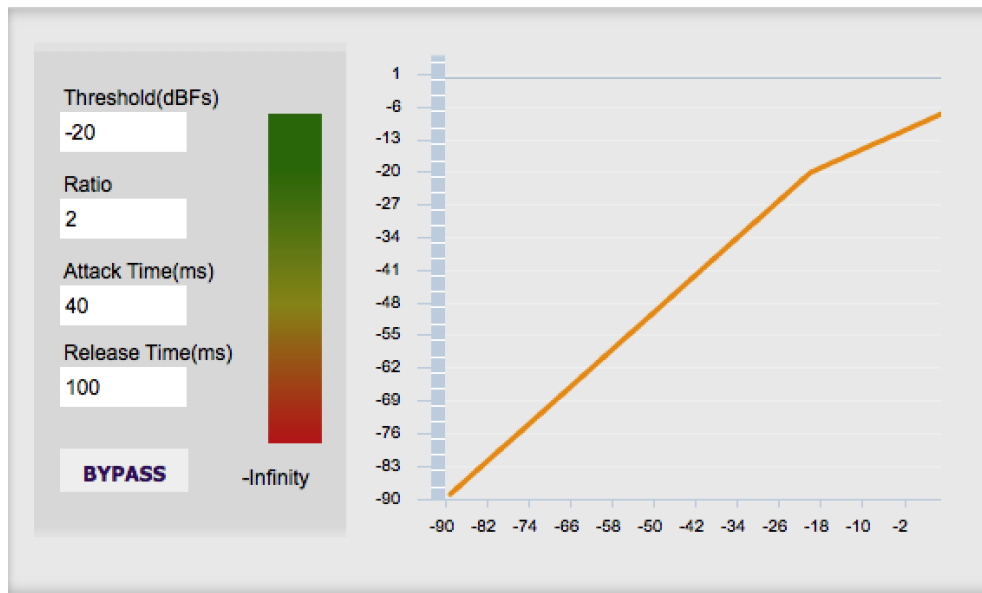

(Note that the compressor algorithm is bypassed by default, so click on the **Bypass** button to see the curve as shown here.)

In this example, the threshold is set to -20 dB, so the compressor will activate when the signal on that channel reaches -20 dB (relative to full output). The ratio is set to 2, so if the input signal level to the compressor then increases by 10 dB, the output level will increase by only 5 dB. If the input signal level to the compressor is at full scale (0 dB), then the output level will be limited to -10 dB.

Two additional parameters control the action of the compressor: the attack time and the release time. These two parameters govern how quickly the compressor activates when the signal level exceeds the threshold, and how quickly it deactivates when the signal level reduces. The optimum settings may need to be tuned by ear.

For more information, see the Wikipedia article [Dynamic range compression](https://en.wikipedia.org/wiki/Dynamic_range_compression).

5.6.7 Time delay

A delay of up to 25 ms can be applied to each output channel. To set the delay, click in the delay entry box for a channel. The delay value can be entered numerically by typing in the entry box. The up and down arrows can be used to change the delay in small increments.

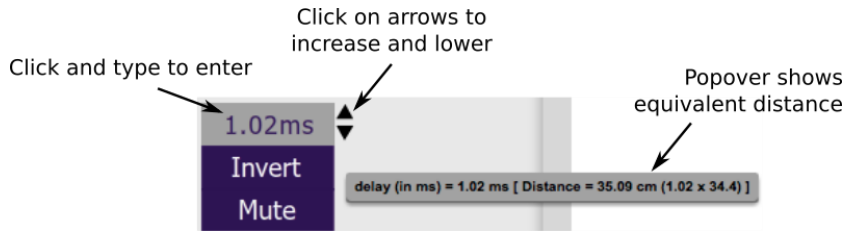

The time delay corresponds to a distance. This distance is shown in cm when the cursor is hovered over the time delay box. The maximum time delay of 25 ms corresponds to a distance of approximately 8.6 meters (about 28 feet).

The delay can also be displayed and entered directly in terms of its equivalent distance in cm. To do so, drop down the **Display** menu and select **Show Delay in cm unit**.

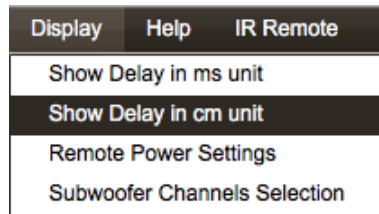

In this case, hovering the cursor over the entry box will display the actual time delay:

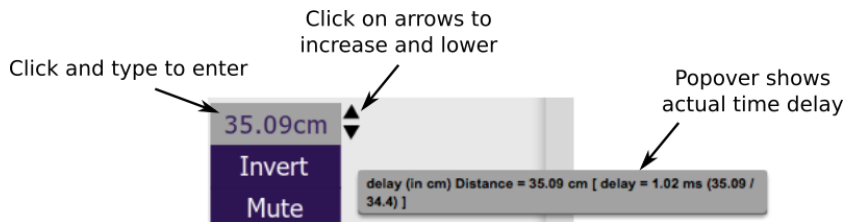

5.6.8 Invert and mute

Each output channel can be inverted in polarity, and individually muted. When either of these options is selected, the display changes color and the label of the button reflects the current state.

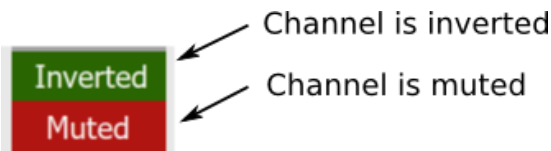

5.7 CUSTOM BIQUAD PROGRAMMING

Custom biquad programming is available in the **PEQ** and **Xover** (crossover) blocks. Its purpose is to allow you to directly provide the low-level parameters aka *biquad coefficients* that control the digital filters of the processor, thus providing an almost infinite degree of flexibility.

For example, you can create hybrid crossovers with staggered cutoff frequencies, create parametric EQ filters beyond those provided in the easy-to-use “basic” interface, implement a Linkwitz transform, or mix crossover and EQ biquads in the same block.

5.7.1 What’s a “biquad”?

A biquad is the basic unit of processing that is used to create digital filters. It can be described either with an equation or with a signal flow diagram, as shown here:

$$H(z) = \frac{b_0 + b_1z^{-1} + b_2z^{-2}}{1 + a_1z^{-1} + a_2z^{-2}}$$

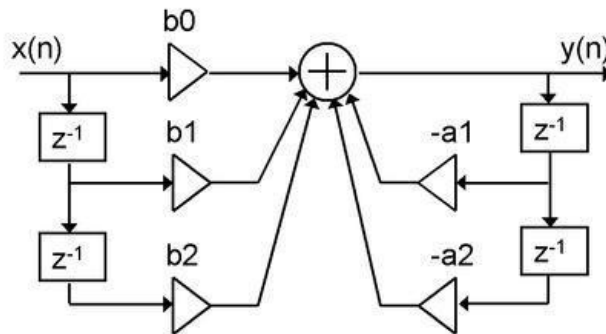

A single biquad like this can perform a great many functions, including all of the functions of a single parametric EQ filter, one 6 or 12 dB/octave high pass or low pass filter, and more. Biquads are combined in series (cascaded) to create more complex filters. The function that each biquad performs is determined by just five numbers: a_1 , a_2 , b_0 , b_1 , and b_2 . These numbers are called the *coefficients*.

5.7.2 Using custom biquad programming

Each crossover block and PEQ filter has a selector that switches it to advanced mode:



In advanced mode, the biquad coefficients can be pasted directly into the user interface. These coefficients must be calculated using a design program – see [Biquad design software](#) below for suggestions.

Parametric EQ advanced mode

In the PEQ blocks, advanced mode allows each individual filter to be specified by its biquad coefficients. After pasting in the coefficients, click on the **Process** button for them to take effect.

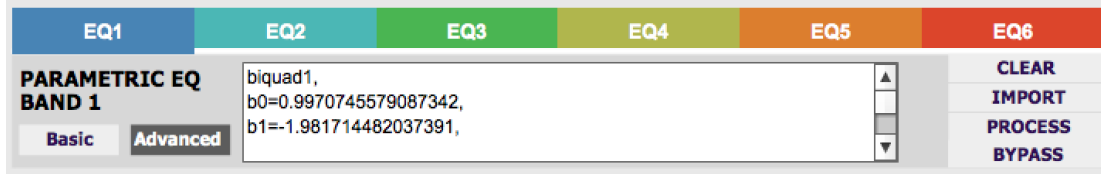

Parametric EQ file import (REW integration)

Multiple biquads in the PEQ block can be set at once by importing a coefficient file. (Click on the **IMPORT** button.) This file can be generated by Room EQ Wizard (REW) or by other programs. The design program must be set for a **192 kHz** sample rate for the **C-DSP 8x12** plugin. The number of filters is limited to a maximum of ten.

This example illustrates the correct file format:

```
biquad1,
b0=0.998191200483864,
b1=-1.9950521500467384,
b2=0.996920046761057,
a1=1.9950521500467384,
a2=-0.9951112472449212,
biquad2,
b0=0.999640139948623,
b1=-1.9981670485581222,
b2=0.9985489719847982,
a1=1.9981670485581222,
a2=-0.9981891119334211,
biquad3,
...
biquad4,
...
biquad5,
b0=1.0010192374642126,
b1=-1.9950555192569264,
b2=0.9940580112181501,
a1=1.995060938714333,
a2=-0.9950718292249559
```

Note that the last line must not have a comma at the end. If the file has less than ten biquads, then only that number of biquads will be imported. For example, if importing a file with six biquads, the first six filters will be set, and the last four will not be changed. (Be careful: if the last line ends with a comma, that counts as an extra biquad.)

If the file contains more than ten biquads, then an error will be reported and no filters will be changed.

Crossover advanced mode

The **Xover** (crossover) blocks have eight biquads on each output channel. In **Advanced** mode, all eight biquads need to be specified. After pasting in the coefficients, click on the **Process** button for them to take effect.

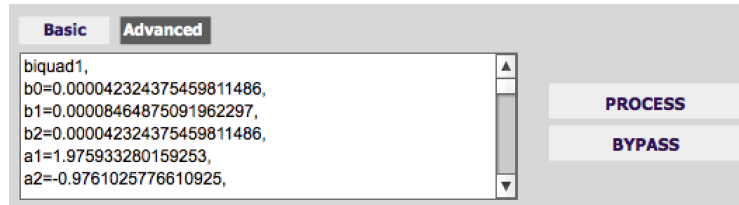

5.7.3 Biquad design software

Following are programs that can be used to design your biquad coefficients.

5.7.3.1 Biquad calculation spreadsheet

The community-developed biquad calculation spreadsheet allows many filter types to be calculated, including notch filters, Linkwitz transforms, and filters with arbitrary Q-factor. Access this spreadsheet here (requires Microsoft Excel):

- http://www.minidsp.com/images/fbfiles/files/All_digital_coefs_v1-20101026.zip

Be sure to set the sample rate to **192 kHz** on any worksheet that you use.

5.7.3.2 Room EQ Wizard (REW)

Room EQ Wizard (REW) is a free acoustic measurement and analysis tool, available for Windows, Mac and Linux platforms. It includes the ability to automatically generate a bank of parametric EQ biquads based on a measurement. These coefficients can be saved to a file from REW and loaded directly into a PEQ bank in a miniDSP plugin. Room EQ Wizard can be downloaded here:

- <http://www.roomeqwizard.com/#downloads>

For guidance on using this feature, please refer to the app note [Auto EQ with Room EQ Wizard](#). When calculating the EQ in REW, choose “C-DSP 8x12” in the Equaliser section of the EQ window. (Be sure not to choose “C-DSP 8x12 DL,” as that has a different internal sample rate.)

5.8 WORKING WITH CONFIGURATIONS

The data that controls the audio processing C-DSP 8x12 is called a *configuration*. Four configuration presets are stored in internal memory. Presets can be selected with the wired remote panel or with an infrared remote.

5.8.1 Online and offline mode

Initially, the plugin is in *offline* mode. When the **Connect&Synchronize** button is used, the plugin downloads configuration data into the processor and goes into *online* mode. Changes made in the plugin user interface therefore fall into two categories:

The plugin is in online mode

The plugin user interface is “live” – that is, any changes made to the audio processing parameters in the user interface are immediately downloaded to the processor. The effect of these changes will thus be audible as the changes are made.

The plugin is in offline mode

Changes made to audio processing parameters in the plugin user interface will be made on your computer only. The next time the plugin is synchronized to the processor, the parameters will be downloaded to the processor (provided the **Synchronize Config** button is selected).



The configuration contained in the miniDSP hardware unit cannot be uploaded back to the computer. Therefore, you **must** save your configuration to a file if you wish to recover from any changes you make while in offline mode.

5.8.2 Selecting a configuration

The active configuration is selected by one of the four buttons in the Configuration Selection area. By default, configuration 1 is selected:



To switch to a different configuration, click on a different button. There are two cases:

The plugin is in online mode

Audio processing will switch to the parameters contained in the selected configuration. If, however, parameters of the newly selected configuration have been changed since the last time that configuration was synchronized to the processor, then a dialog will appear asking you if you want to synchronize the configuration.

The plugin is in offline mode

The user interface will update to show the parameters of the newly selected configuration. If this configuration is changed in the user interface, it will be downloaded to the processor the next time it is synchronized.

5.8.3 Saving and loading configurations

Configurations can be saved to and loaded from files. Each configuration is stored in a separate file. It is *very* strongly recommended that each configuration programmed into the processor be saved to a file, to ensure that the configuration is not lost if the processor is inadvertently reset to defaults.

To save the currently selected configuration to a file, drop down the File menu, then select **Save** and then **Save current configuration to computer**. In the file box, select a location and name of the file, and save it.

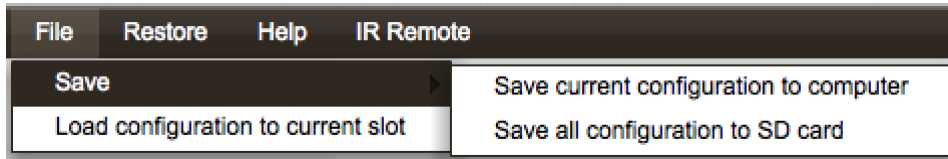

To load a configuration from a saved file, first select the configuration preset that you wish to load into ("Config 1", "Config 2" etc). Drop down the **File** menu and select **Load configuration to current slot**.

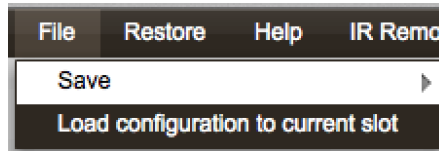

If the plugin is in online mode, the new configuration data will be downloaded to the processor immediately. If the plugin is in offline mode, the configuration will be loaded into the user interface only, and will be downloaded to the processor the next time it is synchronized.



To copy a configuration from one preset to another, save the configuration to a file, then select a different configuration preset and load the file.

5.8.4 Loading configurations from microSD card

The **C-DSP 8x12** can load a set of configurations from a microSD card. This can be used to load new configuration sets without requiring a computer connection.

1. Connect a microSD card to the computer. If the computer has an SD card slot, you can use a microSD card adapter. Or, use an external card reader connected via USB. If the card hasn't previously been formatted, format in FAT format.
2. Start the plugin. Don't connect or synchronize to the C-DSP 8x12. From the **File** menu, select **Save** and then **Save all configuration to SD card**.

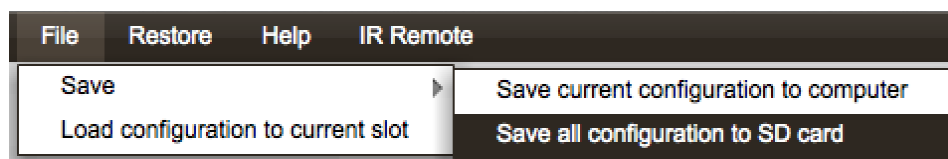

3. From the file save dialog box that opens, type in a file name, navigate to the SD card and click on Save. This saves all four configurations to a special file on the SD card.
4. Eject the (micro) SD card from the computer.
5. Power off the **C-DSP 8x12** if it is on. Insert the microSD card into the slot on the C-DSP 8x12 rear panel. (It pushes in and latches.) Power on the **C-DSP 8x12**.
6. The C-DSP will load all four configurations. Each button on the wired remote will light as that configuration is loaded.
7. Eject the microSD card. (Push it in gently to unlatch it, then pull it out.) The C-DSP 8x12 is ready for use with a new configuration set.

5.8.5 Restoring to defaults

Configurations can be reset to the factory defaults from the Restore menu. There are two options:

Factory Default

Reset all four configuration presets to the factory default settings.

Current Configuration Only

Reset only the currently selected configuration preset to the factory default settings.

If the plugin is in online mode, the configuration data on the processor (all or just one configuration, as selected) will also be reset to factory defaults. Otherwise, the reset will take place in the user interface only, and the new configuration data will be downloaded to the processor next time it is synchronized.

5.9 KEYBOARD SHORTCUTS

The **C-DSP 8x12** plugin supports the use of the keyboard for many operations.

Tab

The Tab key moves the focus from the current user interface element to the next. A blue-grey surrounding box usually indicates the user interface element with the focus. Shift-Tab moves the focus in the opposite direction.

Up/down arrows

The up/down arrow keys (and in some cases, the left/right arrow keys) adjust the value of many parameters, if they have the focus:

- Output channel gain
- Crossover frequency and filter type
- PEQ filter frequency, gain, and Q

Space

The Space bar toggles buttons that have two states, such as **Bypass**, **Invert**, and **Mute**, if they have the focus.

5.10 REMOTE TRIGGER TIMING

When the REMOTE MODE switch (see page 16) is set to position 2, the REMOTE OUT terminal can be used to enable and disable power amplification.

The relevant delays can be configured from within the plugin. To do so, drop down the **Display** menu and select **Remote Power Settings**.

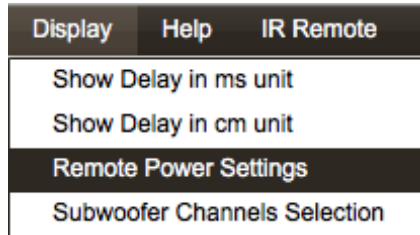

On the screen, enter the desired value for each time delay parameter and press the Enter key. When finished, click the close “X” icon at the top right, and the settings will be downloaded to the C-DSP 8x12.

(Note that the default settings are suitable 90% of installations. So there’s no need to change from the defaults if it’s working fine for you.)

REM out delay

This value controls the delay from REMOTE IN going high to REMOTE OUT going high.

C-DSP turn off delay

This value controls the delay from REMOTE IN going low until the C-DSP 8x12 turns off.

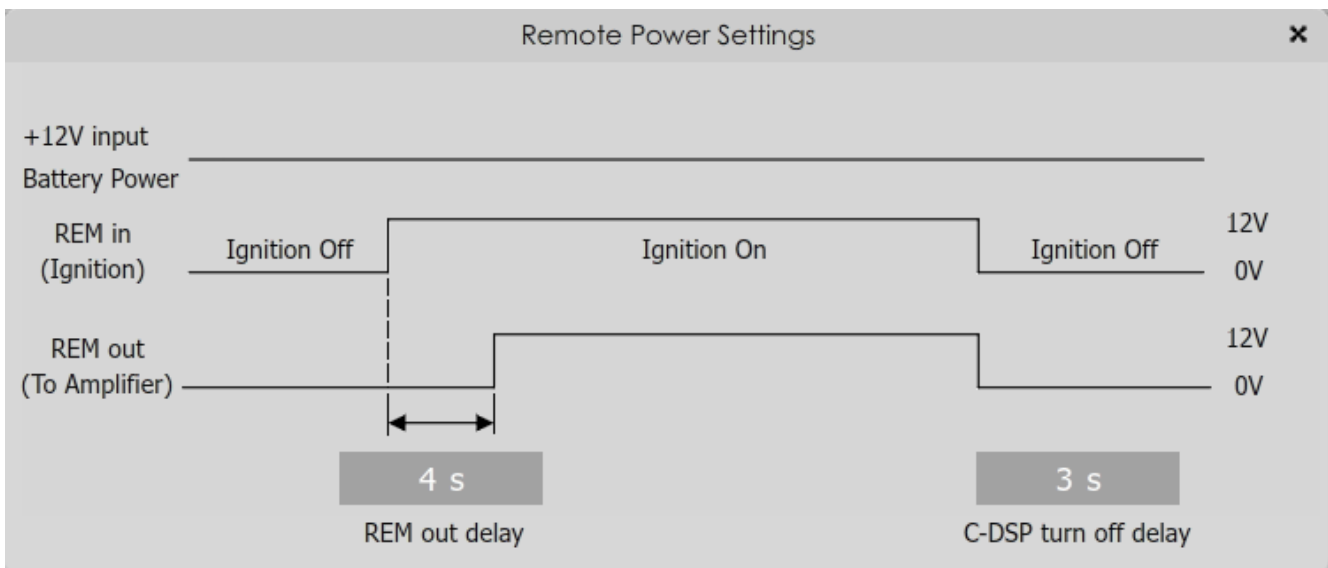

6 REMOTE CONTROL

The OLED wired remote can be used to control:

- Master volume
- Subwoofer volume
- Master mute
- Volume mode selection (master/subwoofer)
- Digital input source selection
- Preset selection

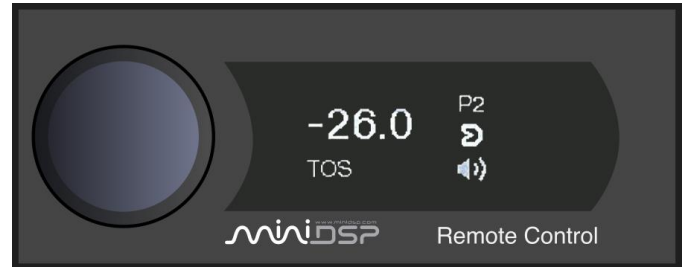

6.1 STATUS INDICATORS

The OLED display shows the currently selected preset, master volume, digital input source, and the status of mute and Dirac Live.

6.2 OPERATION OF THE OLED WIRED REMOTE

To change the volume

Rotate the control knob clockwise to increase the volume, and counterclockwise to decrease it. Either the master or subwoofer channel volume will change, depending on the current volume control mode.

To mute and unmute

Press and hold the control knob.

To change the volume control mode

Quickly press the control knob, then rotate until either “Master” or “Sub” is displayed. Either press the control knob again or wait for a second. The displayed volume will either be the master volume, or the additional gain/attenuation applied to the designated subwoofer channels.

To change the preset

Quickly press the control knob twice, then rotate until the desired preset number is displayed. Either press the control knob again or wait for a second. The display will show “Pls wait...” while the new preset is being loaded.

6.3 USING THE MINIDSP REMOTE

The miniDSP remote control (v2) controls the following runtime functions. The infrared receiver for the remote is located in the OLED wired remote.



Standby

Has no effect with the C-DSP 8x12.



Mute

Mute and unmute audio output.



Volume



Reduce or increase the volume. Each press changes the volume in 0.5 dB steps. Holding down a button will accelerate the rate of volume change.

Media control



Has no effect with the C-DSP 8x12.



Dirac Live

Has no effect with the C-DSP 8x12.



Source selection

Selects between TOSLINK and SPDIF digital inputs.



Preset (1 through 4)

Switch to the selected preset. It takes a short time for the preset selection to complete, while the processor loads the new filters from its flash memory into the DSP.

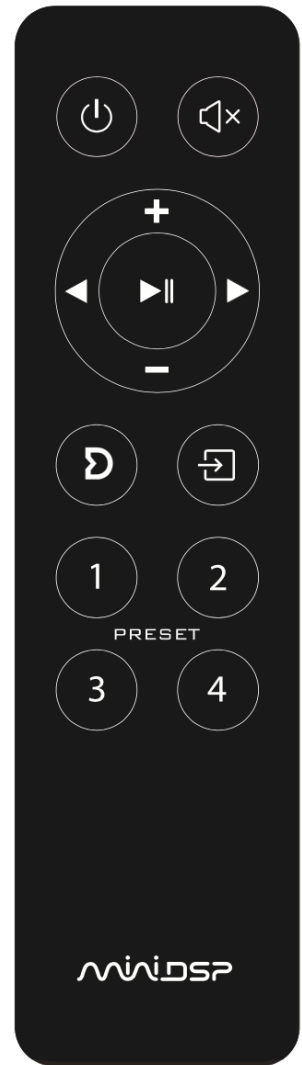

6.4 INFRARED REMOTE CONTROL

The C-DSP 8x12 can “learn” the control codes of a third-party remote if it supports one of the following remote control codes:

- NEC
- Sony
- Philips RC6

To initiate the learning process, start the C-DSP 8x12 plugin and click on the Connect button. Once connected, drop down the IR Remote menu and select **IR learning**. Click on the **Learn** button for an operation, and then press the desired button on the remote control. If the code is accepted, the status will change to show a tick. Repeat for all commands:

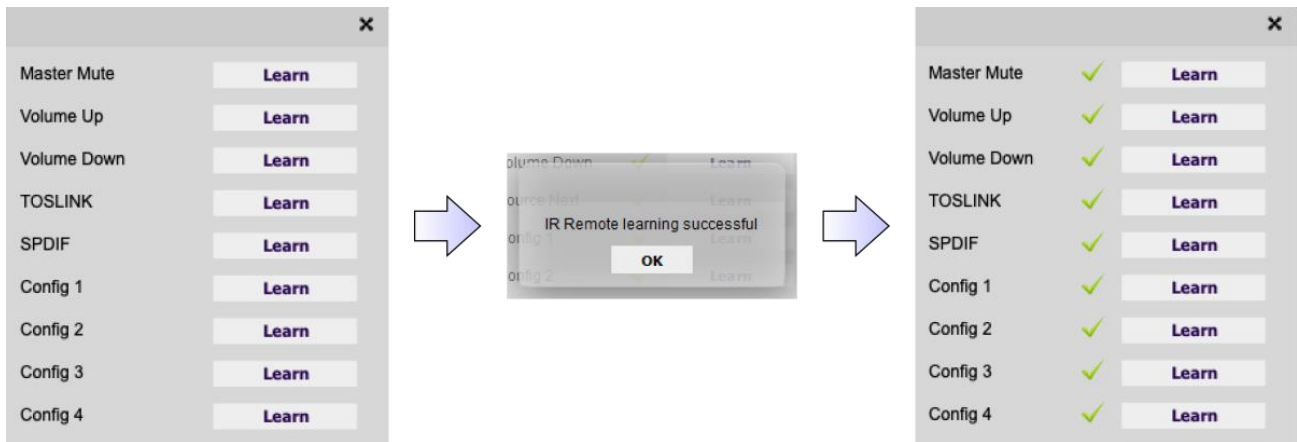

To “unlearn” a command, press the **Learn** button and wait for the plugin to time out. Note that you cannot “learn” the miniDSP remote – it will always work, even if you learn another remote’s codes.

7 ADDITIONAL INFORMATION

7.1 SPECIFICATIONS

Computer connectivity	Driverless USB 2.0 control interface for Windows and Mac OS X
Analog audio inputs	<ul style="list-style-type: none"> • 6 x high-level differential on terminal Block, max 8/12 VRMS (switch-selectable) • 6 x low-level differential on RCA connectors, max 2/4 VRMS (switch-selectable)
Input impedance	<p>Low-level inputs: 10 kΩ (4V setting) or 5 kΩ (2V setting)</p> <p>High-level inputs: 68 Ω</p>
Digital audio Input	<ul style="list-style-type: none"> • S/PDIF on RCA connector / Isolated with digital audio transformer • TOSLINK optical <p>A high quality onboard Asynchronous Sample Rate Converter ensures compatibility with most sample rates, from 44.1 up to 192 kHz.</p>
Analog audio outputs	12 x unbalanced on RCA connectors, 6.0V RMS full scale output
Output impedance	560 Ω
Audio resolution	24-bit input and output, 192 kHz internal sample rate
Audio processing	400 MHz 32-bit Floating Point SHARC Digital Signal Processor, ADSP21489
Storage/presets	<p>All settings controllable in real time from software user interface.</p> <p>Up to 4 presets stored in local flash memory.</p>
Wired external remote	External remote for control of active preset, master volume, subwoofer volume and master mute. LED indication of active preset.
microSD Card	Allows setup without a laptop: a configuration can be built offline and loaded automatically to the unit in the car via a microSD Card.
Infrared remote	“Learning remote” (NEC, Philips, Sony) controls master volume, mute, preset selection.
Remote trigger	<p>REMOTE IN: 4 V DC trigger level</p> <p>REMOTE OUT: 12 V DC @ 100mA max current out</p>
Power supply	Isolated DC-DC conversion, 10 to 14 V DC compliant for car audio environment
Dimensions (H x W x D)	47 x 246 x 120 mm

7.2 INPUT SENSITIVITY SETTING

The sensitivity of all inputs can be changed with a set of DIP switches internal to the unit. All inputs can have the sensitivity set independently. To change input sensitivity settings, remove the top cover. Referring to Figure 3 below, move **both** switches for each input to the desired setting.



The switches are very small, so you will need a small device like the end of a paperclip to move them. Don't use force, just push the switch in the desired direction and it will "click" into the new position.

Table 1. Input sensitivity switch settings

Input type	Low level inputs		High level inputs	
Switch setting	Off (default)	On	Off	On (default)
Full scale input voltage (RMS)	4V	2V	12V	8V
Input impedance	10 k Ω	5 k Ω	68 Ω	68 Ω

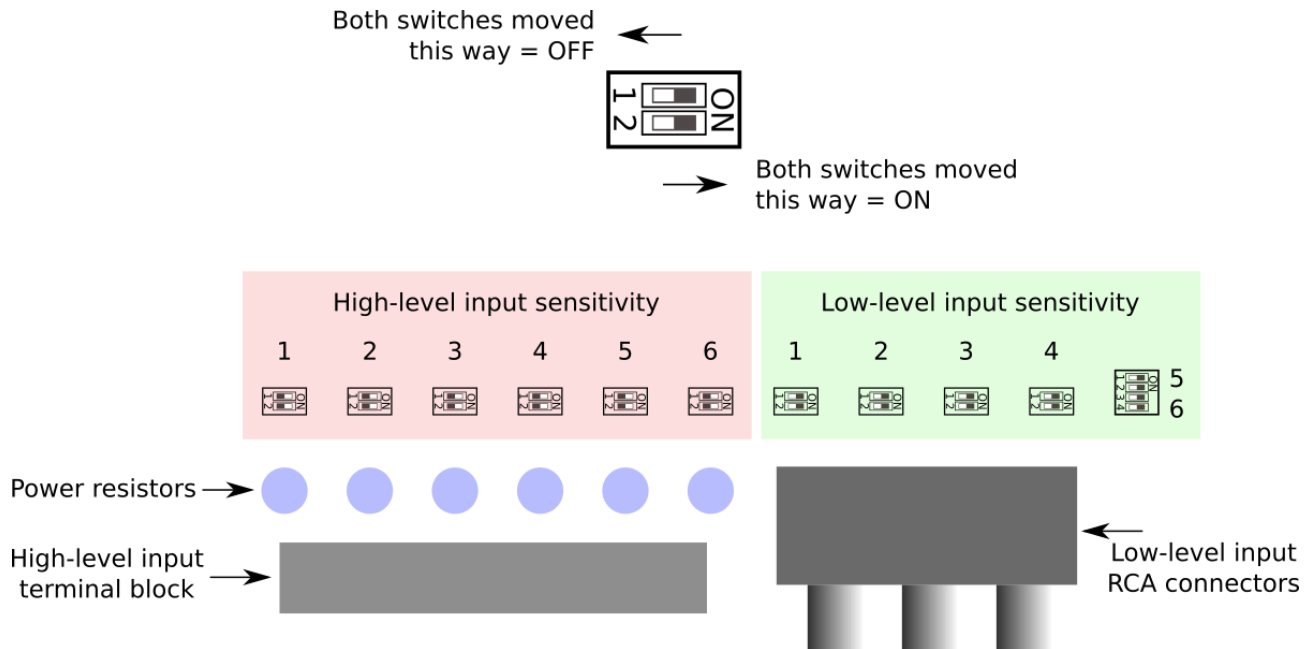

Figure 3. Input sensitivity switch locations

7.3 4-BUTTON WIRED REMOTE (LEGACY)

Note: The 4-button wired remote shipped with C-DSP 8x12 units up until December 2020. From January 2021, all units ship with the new OLED wired remote.

The 4-button wired remote and/or an infrared remote can be used to control:

- Master volume
- Subwoofer volume
- Master mute
- Preset selection
- Volume mode selection

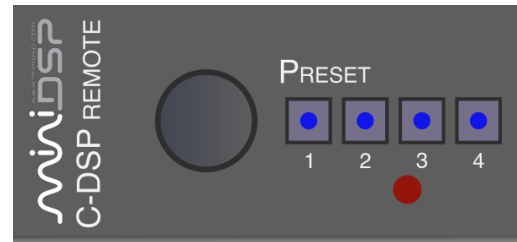

Status indicators

The currently selected preset is indicated by a blue LED in one of the selection buttons.

Operation of the 4-button wired remote

To change the volume

Rotate the control knob clockwise to increase the volume, and counterclockwise to decrease it. Either the master or subwoofer channel volume will change, depending on the current volume control mode.

To mute and unmute

Press on the control knob.

To change the preset

Press one of the four buttons. The LED of the selected preset will flash several times. When it stays lit, the selected preset is now in operation.

To change the volume control mode

Press buttons 1 and 2. LEDs 1 and 2 will light either solid or blinking, depending on the current mode:

- LEDs 1 and 2 are solid (not blinking): **Master Volume** mode
- LEDs 1 and 2 are blinking: **Subwoofer Volume** mode

Press button 4 to change the mode. Press buttons 1 and 2 to return to normal operation.



To quickly adjust subwoofer volume while in Master Volume mode:

4. Press buttons 1 and 2, then button 4 to switch to Subwoofer Volume mode.
5. Adjust the rotary control until the subwoofer level sounds right.
6. Press button 4 to switch back to Master Volume mode.
7. Press buttons 1 and 2 to return to normal operation (for preset selection).

7.4 TROUBLESHOOTING

The following table lists the most common causes of issues. If following this table does not provide a solution, see Obtaining support below.

Item#	Symptoms	Troubleshooting recommendation
1	Cannot install software	a. (Windows) Confirm that required frameworks are installed (see Software installation).
2	Software running in background but not showing	a. The plugin may need a network connection the first time you run it. Close the plugin program, ensure that your computer has a network connection, and restart the plugin.
3	Cannot connect to the board by USB	a. Reset the processor by power-cycling the unit. b. Make sure the processor is seen in the device manager as a HID device.
4	No audio or low audio on outputs	a. Check the cabling from the processor to your amplifiers. b. Check that your amplifiers are turned on and that any volume controls are turned up. c. Check that the input meters and output meters are showing adequate signal (if not, see item 5). d. Check that master mute is not enabled. e. Check that the mute buttons in the output control blocks are not enabled. f. Check that your crossover frequencies are correct e.g. that you don't have high pass and low pass frequencies incorrectly set. g. Check that the matrix mixer is sending the correct inputs to the correct outputs.
5	No signal showing on input meters	a. Check the cabling from your source/s. b. Check that your source is playing audio and that it is not muted or have volume control turned down. c. Check that the plugin is synchronized with the hardware unit.
6	Audio sounds distorted	a. Check the input meters and ensure that you are not overloading the inputs. If necessary, reduce the signal level from the source or change the input sensitivity switches. b. Check the output meter and ensure that you are not overloading the outputs. If necessary, reduce the output gain and/or the amount of boost in the EQ blocks.
6	Audio is coming through	a. Check the cabling from the processor to your amplifiers.

	the wrong outputs	<ul style="list-style-type: none"> b. Check the cabling from your source/s. c. Check that you have correctly set up the matrix mixer to send the correct inputs to the correct outputs.
7	Other audio-related issues, or issues not resolved.	<ul style="list-style-type: none"> a. Check that you have downloaded the latest version of the plugin. b. Check that your processor has the latest firmware installed (About menu).
8	Cannot reload a configuration	<ul style="list-style-type: none"> a. Confirm the file format of your file (.xml). b. Confirm the version of the file.

7.5 FIRMWARE UPGRADE – MAIN BOARD AND WIRED REMOTE

See “Upgrade instructions for C-DSP2.txt” in the **firmware** folder of the software download.

7.6 OBTAINING SUPPORT

1. Work through the Troubleshooting checklists starting on the previous page.
2. Check the forums on miniDSP.com to see if your issue has already been raised and a solution provided.
3. Contact miniDSP via the support portal at support.minidsp.com with:
 - a. The specific product you are having an issue with (in this case, C-DSP 8x12).
 - b. A clear explanation of the symptoms you are seeing.
 - c. A description of the troubleshooting steps performed and your results.