

Ultra High Performance Liquid Chromatograph Method Scouting System

# Nexera Method Scouting



# Maximizing Efficiency for Method Development

The Nexera Method Scouting System design is based on the Nexera next-generation ultra high performance liquid chromatograph. It uses special Method Scouting Solution control software and a robust, high-pressure resistant column switching system to switch mobile phases and columns automatically, achieving a quick and accurate method scouting workflow. As a result, this system provides strong support for efficient HPLC method development.

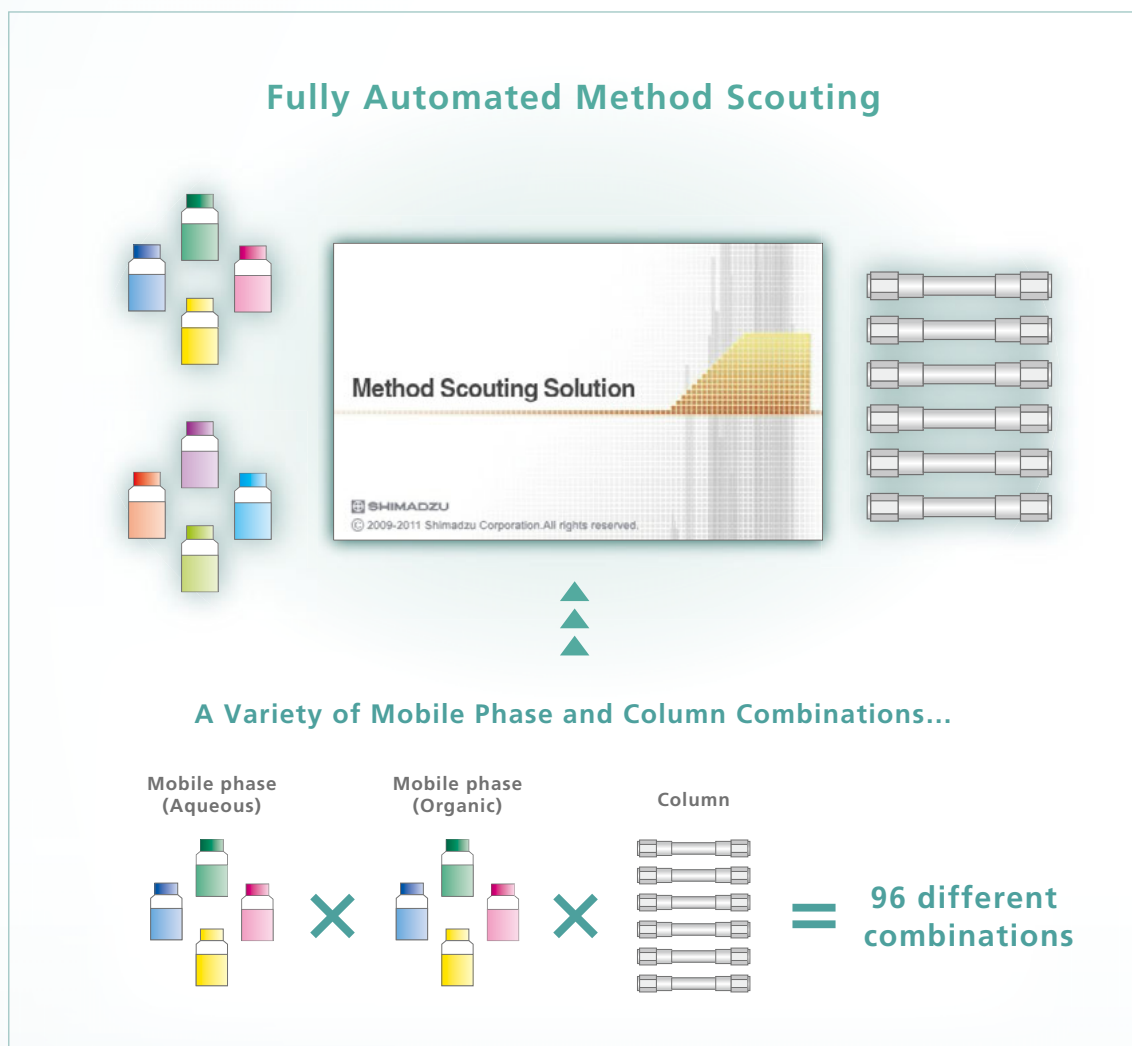

## Contents

Enhancing Method Development Efficiency by Nexera Method Scouting	P.4
Method Scouting Workflow	P.6
Method Scouting Solution: Supporting Fast, Secure Operation	P.8
Nexera System: Providing Highly Reliable Data	P.10
Sample Application	P.11



The solution from Shimadzu to  
troublesome method development  
**Nexera Method Scouting**

Special Method Scouting  
Software  
Method Scouting Solution

The software interface displays a complex flow diagram for method development. It includes several key components:

- Flow Diagram:** A central schematic showing the flow of reagents and samples through various components like pumps, valves, and detectors.
- Chromatograms:** Multiple plots showing detector response over time, with peaks identified and labeled.
- Mobile Phase Database:** A table listing various mobile phases with their respective compositions and pH values.
- Method Configuration:** A panel for setting parameters such as flow rate, temperature, and detection wavelength.

Mobile Phase Name	Mobile Phase Name
Water	Water
Acetonitrile	Acetonitrile
Methanol	Methanol
10 mM/L (Sodium) Phosphate Buffer pH 2.5	10 mM/L (Sodium) Phosphate Buffer pH 2.5
10 mM/L (Sodium) Citrate Buffer pH 3.1	10 mM/L (Sodium) Citrate Buffer pH 3.1
10 mM/L (Ammonium) Acetate Buffer pH 4.7	10 mM/L (Ammonium) Acetate Buffer pH 4.7
10 mM/L (Ammonium) Acetate Solution pH 5.5	10 mM/L (Ammonium) Acetate Solution pH 5.5

# Enhancing Method Development Efficiency by Nexera Method Scouting

In a typical method scouting procedure, data is collected using a number of mobile phase and column combinations. Analyzers switching manually between these combinations are limited by the number of work hours in a single day, making it impossible to perform method scouting efficiently. The Nexera Method Scouting System is

capable of automatically investigating up to 96 combinations of mobile phases and columns, without such time restrictions, thereby significantly improving method development productivity.

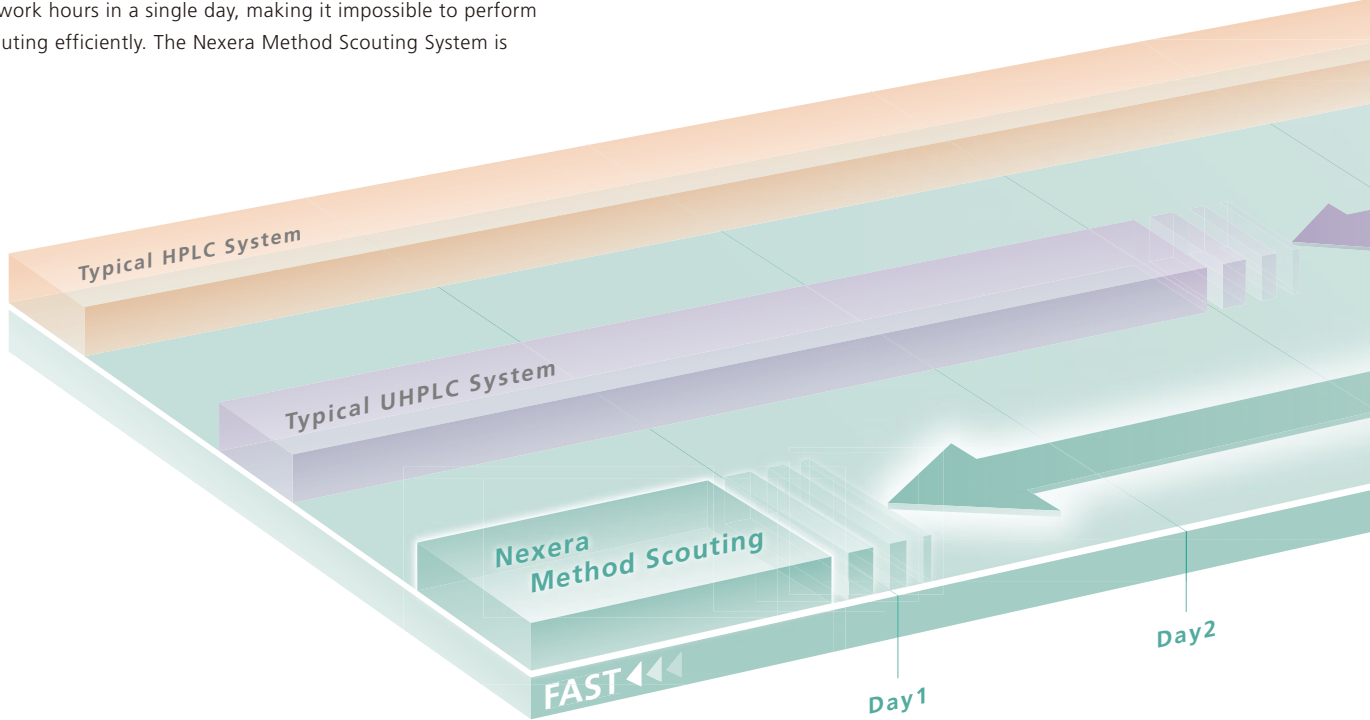

## Typical HPLC/UHPLC System

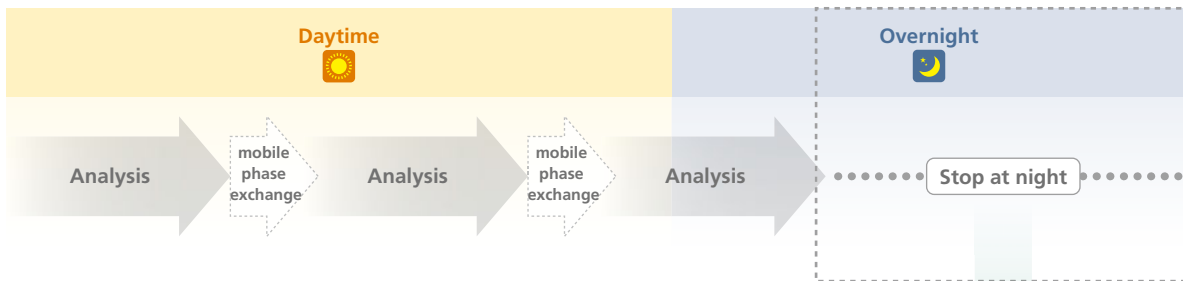

## Nexera Method Scouting

Analysis can be performed while mobile phases and columns are switched automatically overnight.

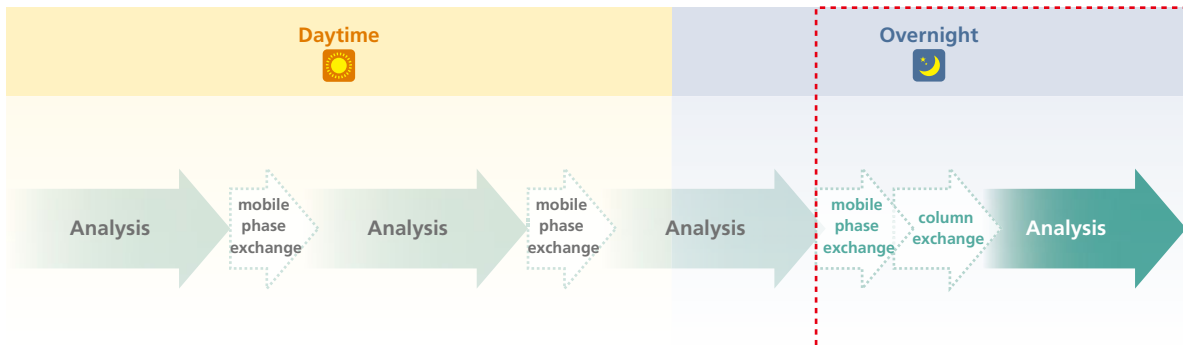

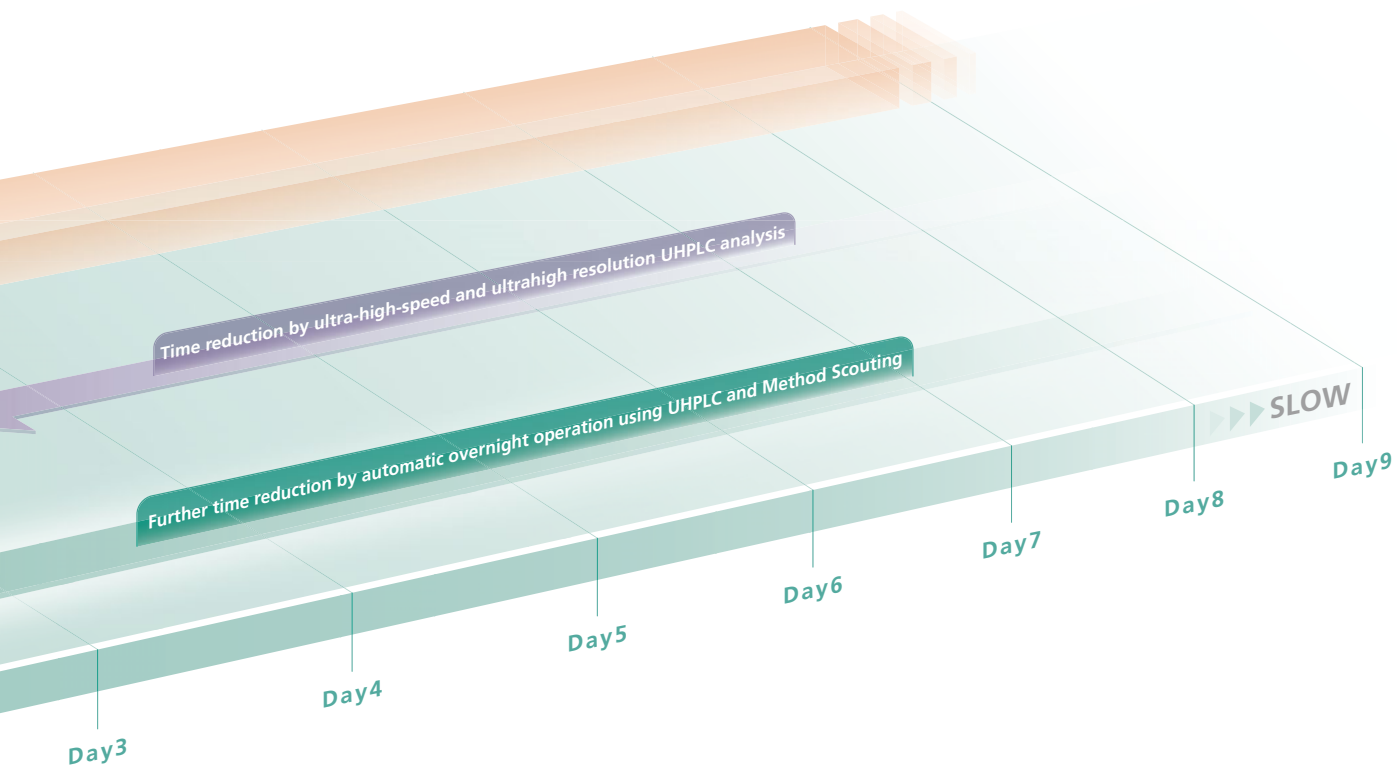

## Method scouting performed by UHPLC, followed by transfer to conventional conditions

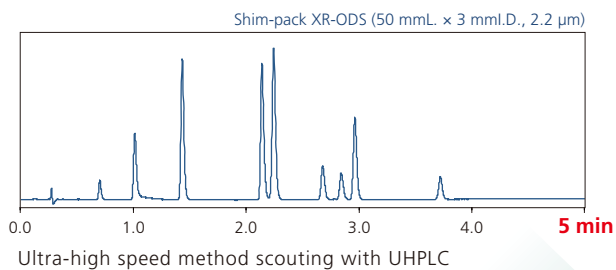
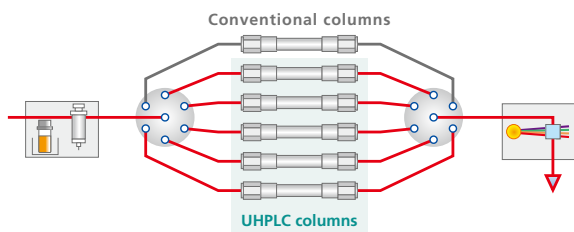

If the transfer program is used, the ultra-high speed conditions obtained with the Nexera Method Scouting System can be easily transferred to conventional conditions. Furthermore, this software can be used to investigate the robustness of methods under conventional conditions. The Nexera Method Scouting System is an all-round LC that enables the collection of ultra-high speed data and conventional data using a single system.

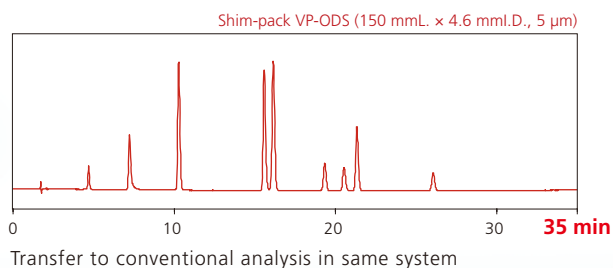
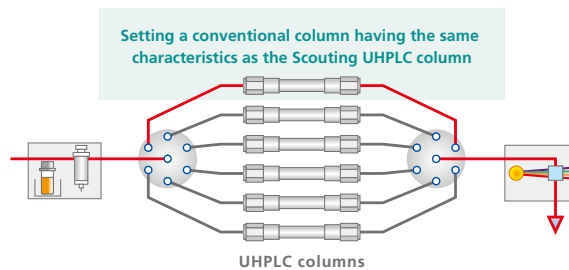

All Round LC  
**Nexera**

## Method Scouting Workflow

With Method Scouting Solution, just set the required conditions to create a scouting batch automatically. This saves time with respect to method creation, management, and batch creation, issues in method development to date. In addition, by combining this system with the Shimadzu's HPLC workstation, LabSolutions, and utilizing

its browser functions, as well as CLASS-Agent and Agent Report, the numerous chromatograms obtained from method scouting can be quickly evaluated, thereby enhancing method development efficiency.

Startup of equipment and special software

Analysis conditions settings (Mobile phase and column selection)

Analysis (Performed)

## Nexera

Scouting is performed automatically when the mobile phase is switched, from flow line purging to baseline stability confirmation (Time Wait, noise/drift checks), not to mention valve switching.



## LabSolutions / CLASS-Agent / Agent Report

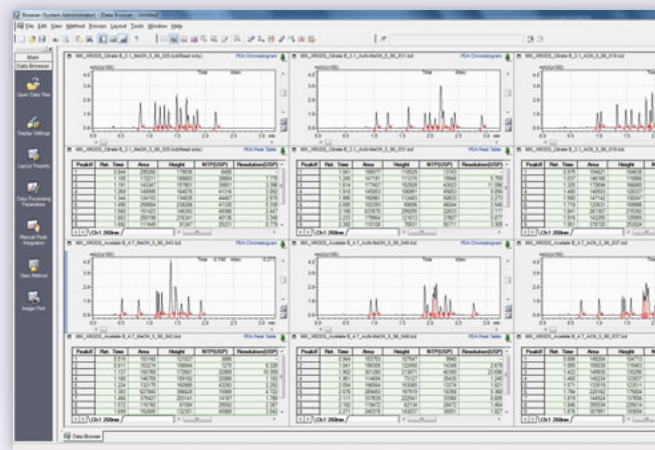
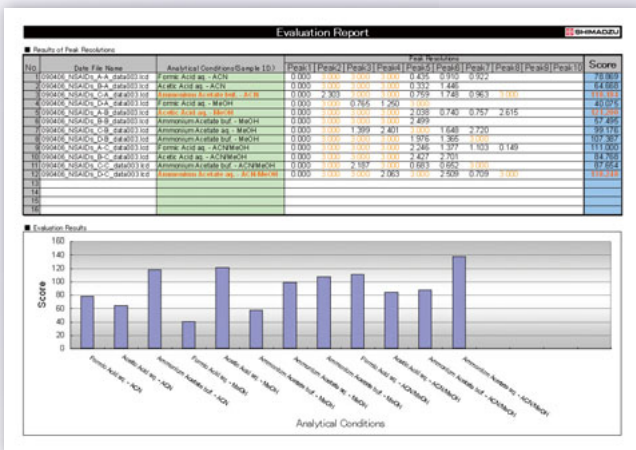

Numerical comparisons\* of chromatograms can be performed using CLASS-Agent and Agent Report  
 \* For evaluation methods using Agent Report, refer to the technical reports listed later.

Easy comparisons of multiple chromatograms in the browser window

# Nexera Method Scouting Software Method Scouting Solution

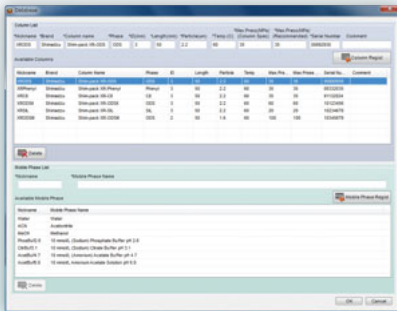

Easy selection of mobile phases and columns from libraries

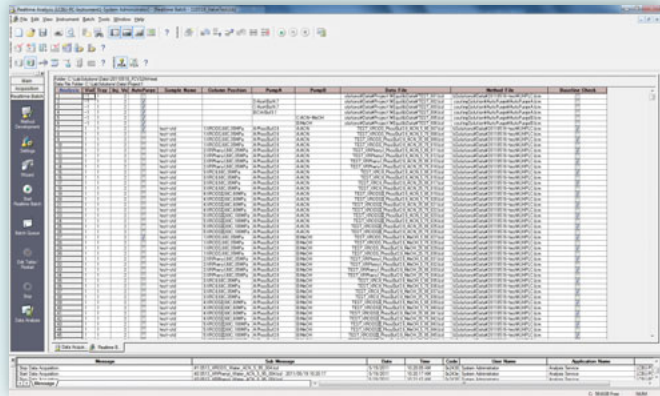

automatically)

Comparison and evaluation of chromatograms

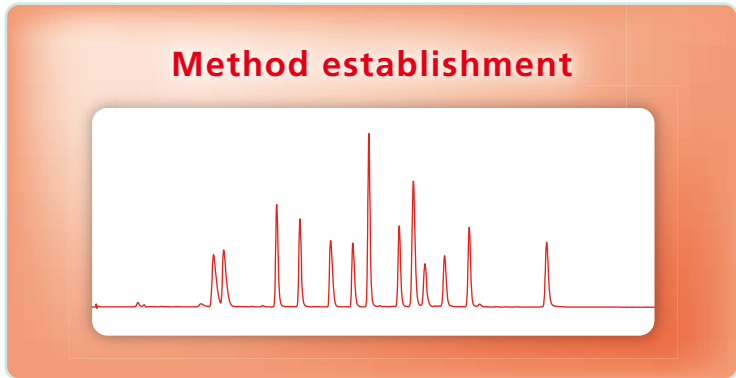

# Method Scouting Solution: Supporting Fast, Secure Operation

Method scouting results are important data for determining analysis conditions, so obtaining highly reliable data is essential. Method Scouting Solution provides the data required for analysis

via a graphical user interface, as well as automated controls conforming to laboratory operations configured in the system settings, thereby providing data reliably.

## Achieving automation of laboratory operations

Mobile phase purge conditions and equilibration when automatically switching mobile phases and columns are key issues in method scouting. With Method Scouting Solution, scouting

reflects laboratory operations, thanks to automatic control of mobile phase purging and equilibration based on preset system configurations.

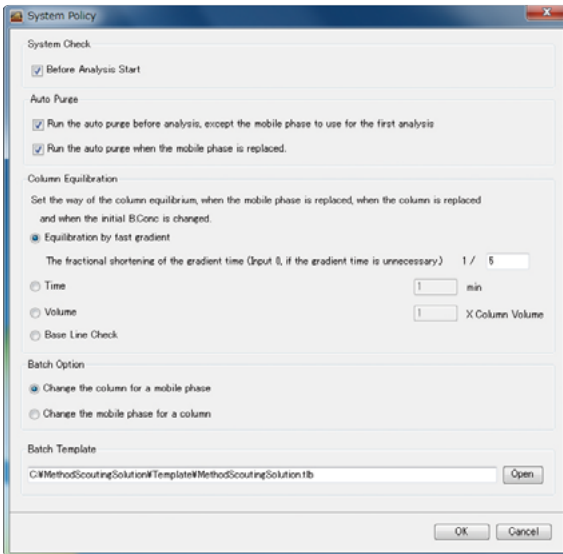

### System confirmation and recording

Data is recorded on system maintenance status prior to scouting, which is useful for reviews if problems with data occur.

### Mobile phase purging

Auto-purge timing is configured. The system performs mobile phase purging automatically based on the conditions configured here, achieving fast mobile phase switching.

### System equilibration determination

Auto-purge timing is configured. The system performs mobile phase purging automatically based on the conditions configured here, supporting reliable data acquisition.

### Scouting scheme

Scouting schemes can be set to give priority to columns or mobile phases based on laboratory policy.

## Integrated settings via column and mobile phase databases

The columns and mobile phases used for method scouting are controlled in a database. During analysis, they are easily selected via a graphical user interface. The names of the selected columns and mobile phases can be reflected in analysis reports.

This consolidates notation for the names of the columns and mobile phases used in the laboratory, preventing mistakes with respect to important column and mobile phase conditions when reviewing scouting results.

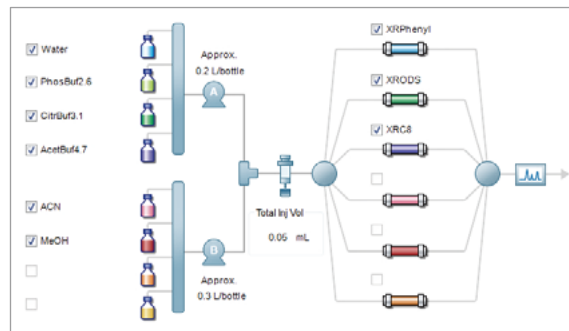
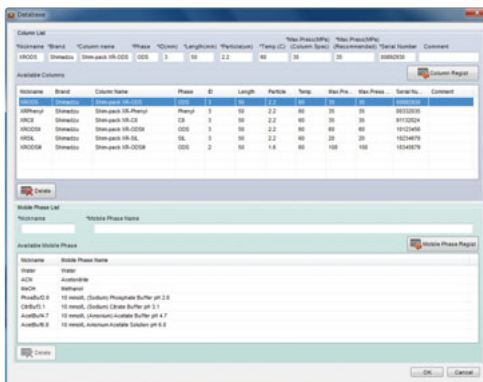

Column and mobile phase database settings window

Column and mobile phase selection window

Basic column data can be registered, so it can be checked during analysis.

During analysis, columns and mobile phases can be set simply by selecting them in the graphical user interface.



## Graphical data provided to support reliable analysis

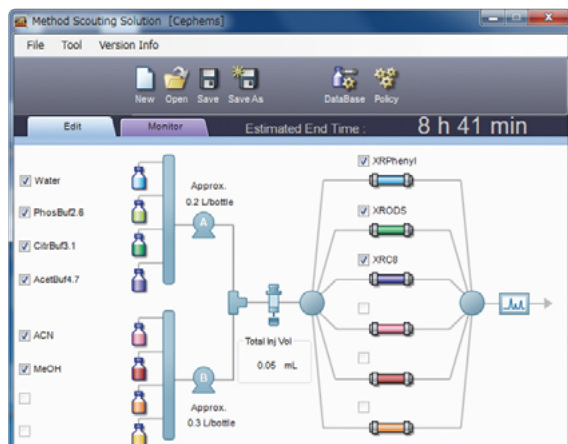

Display of the required amounts of mobile phases and samples, and the estimated completion time

Method scouting uses a variety of mobile phase and column combinations. Method Scouting Solution calculates the required amounts of these mobile phases and samples in advance, and provides this data to avoid shortages. Furthermore, upper pressure limits are automatically controlled based on column pressure resistance data registered in the column database, thereby avoiding degradation of precious columns. In addition, the system provides estimates of completion time, with consideration to the time required between analyses for processes such as mobile phase auto-purging and column equilibration. As a result, scouting can be configured to suit your work schedule.

## Fast data browsing

The ability to quickly search the large quantity of data obtained from method scouting for suitable conditions is important. The data browser function provided with LabSolutions meets this need by displaying a list of these chromatograms and analysis results. In addition to retention time, area, and height, analysis results include the degree of separation, separation coefficients, theoretical plate numbers, symmetry coefficients and other indices for chromatogram evaluation, supporting the process of checking the large amount of data for optimal conditions.

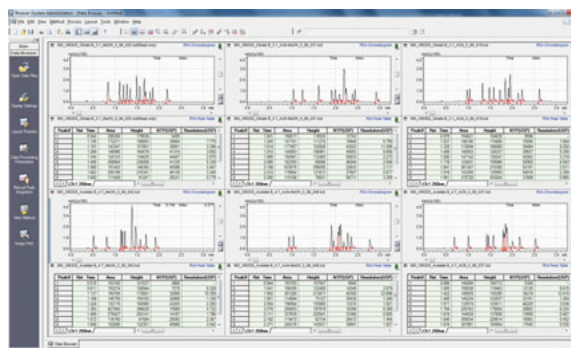

## Quantitation of scouting results via CLASS-Agent Report

CLASS-Agent Report enables quantitation in order to search the data obtained from method scouting for optimal data. With CLASS-Agent Report, numerical data and graphs can be created, utilizing Microsoft Excel, from

calculations based on the degree of separation and the number of peaks\*. As a result, in addition to visual comparison of chromatograms, determinations can be made based on quantitation of determination standards.

\* For evaluation methods using Agent Report, refer to the technical reports listed later.

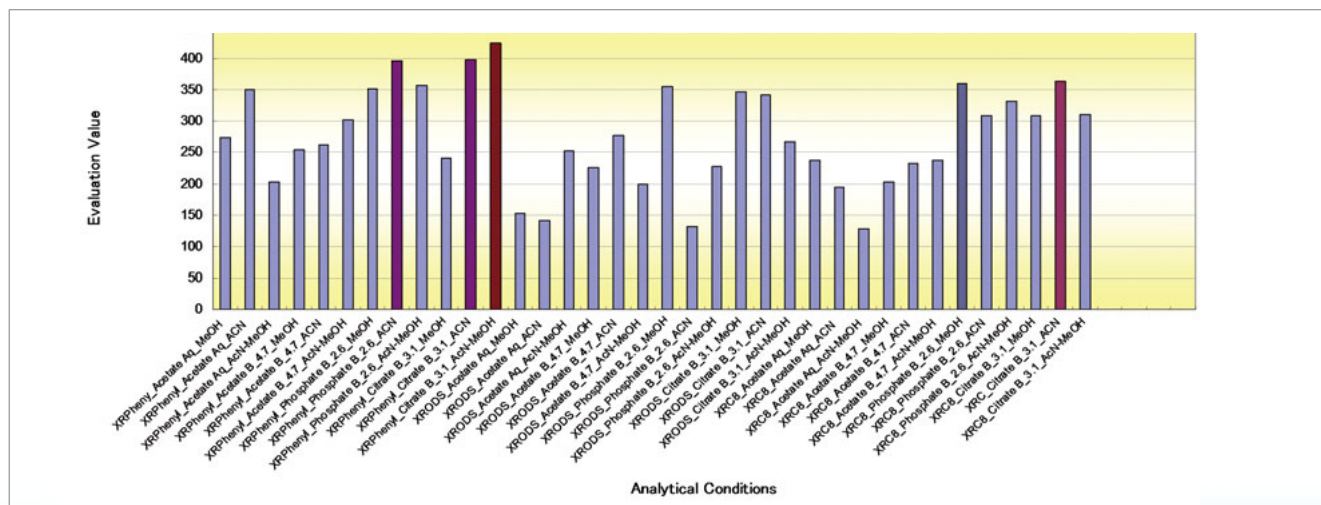

## Nexera System: Providing Highly Reliable Data

The Nexera Method Scouting System is based on the Nexera UHPLC, which has its established reputation for ultra-high speed analysis. As a result, highly reliable method scouting results are provided using

ultra-high speed analysis featuring stable solvent delivery at ultra-high pressures, excellent injection repeatability from low injection quantities, and ultra-low carryover.

### Basic configuration of the Nexera Method Scouting System

The Nexera Method Scouting System achieves stable data acquisition by adopting the newly developed FCV-34AH (100 MPa pressure resistance) high-pressure-resistant column switching valve and

manifold. In addition, with auto-purging, mobile phase equilibration times are reduced by purging the mobile phase inside the autosampler, which means a faster method scouting workflow.

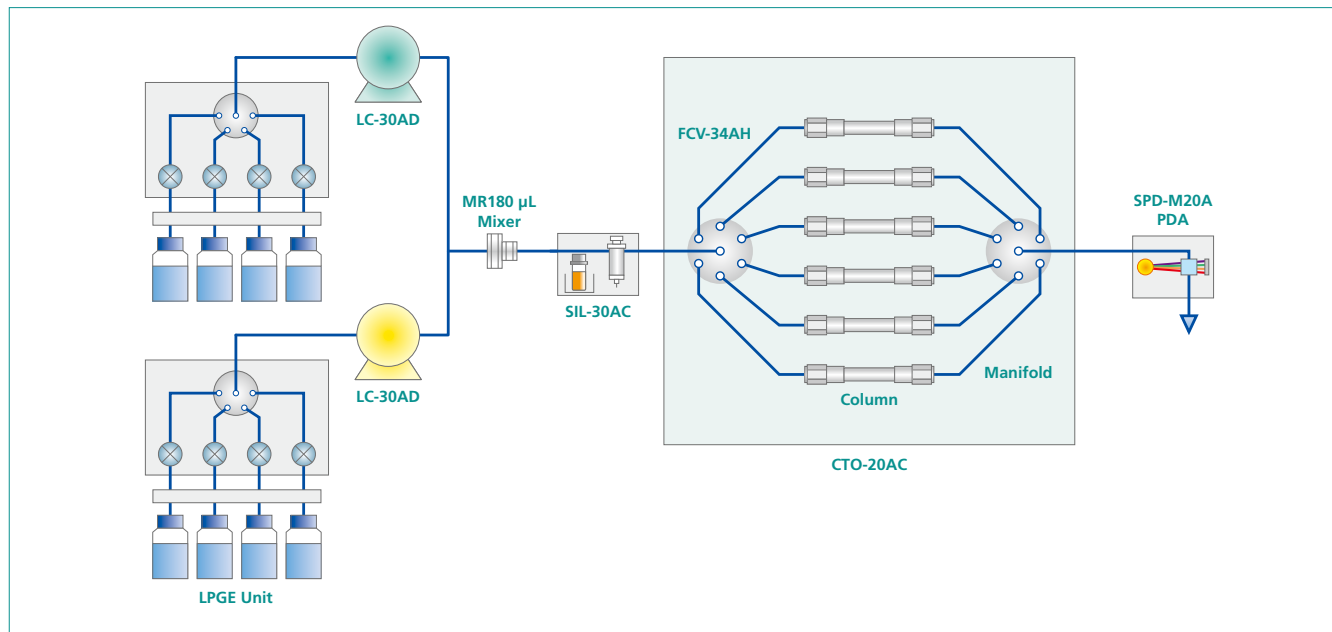

Basic configuration of the Nexera Method Scouting System

### Enabling graphical display of column connections

The piping for 6 columns is color coded and interlinked with the graphical user interface, an approach that enables reliable settings. This makes it possible to reduce the risk of column setting mistakes during analysis.

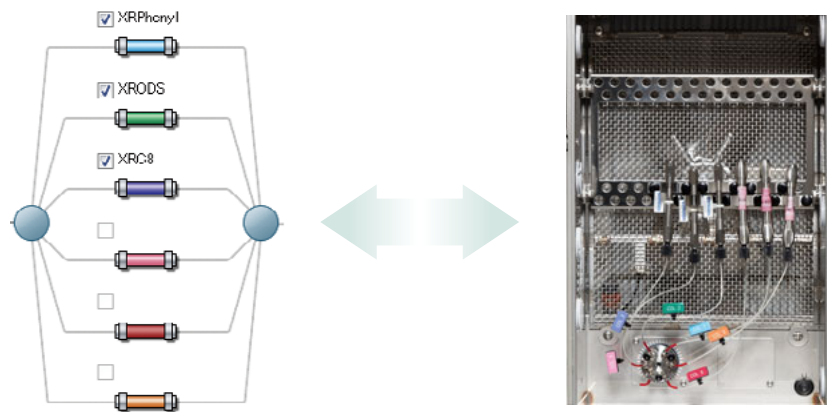

Column connections interlinked with the graphical user interface

## Sample Application

### Peak tracking via interlink with LC/MS

An LC/MS can be used as the Nexera Method Scouting System detector. Mass spectral data from LC/MS systems support peak component specification. As a result, peaks can be identified without re-analyzing individual components.

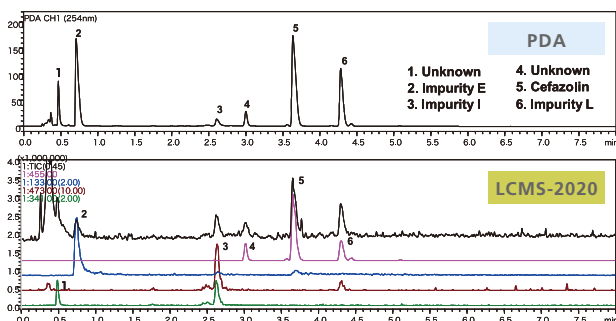

### Scouting for preparative conditions

The Nexera Method Scouting System is also effective for the selection of columns and mobile phases in the investigation of preparative conditions. Results scouted with these conditions can then be transferred to the Prominence preparative system, enabling the fractionation of intended components.

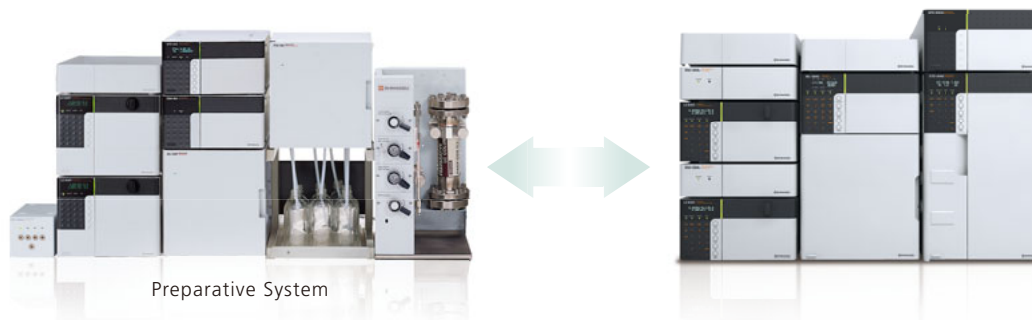

### Standard System Configuration

System Controller	CBM-20Alite
Solvent Delivery Unit	LC-30AD × 2, low-pressure gradient unit × 2
Degasser	DGU-20A series
High-Pressure Flow-Line Selection	FCV-34AH (100MPa 7-port/ 6-position valve)
Gradient Mixer	Gradient mixer MR180 µL
Autosampler	SIL-30AC
Column Oven	CTO-20AC
Detector	SPD-M20A (semi-micro temperature control cell)
Software	LabSolutions Multi-PDA / CLASS-Agent Report
Other	Reservoir tray
Startup Kit (including piping and special software)	Nexera Method Scouting System Startup Kit



Technical reports are provided as reference materials. Download them from the following URL, or contact our sales department or your local Shimadzu representative.

- Technical Report Vol. 33. Improved R&D Efficiency Through Speedier Method Development (1)  
<http://www.shimadzu.com/an/literature/hplc/jpl211001.html>
- Technical Report Vol. 34. Improved R&D Efficiency Through Speedier Method Development (2)  
<http://www.shimadzu.com/an/literature/hplc/jpl211002.html>



Shimadzu Corporation  
[www.shimadzu.com/an/](http://www.shimadzu.com/an/)

Company names, product/service names and logos used in this publication are trademarks and trade names of Shimadzu Corporation or its affiliates, whether or not they are used with trademark symbol "TM" or "®". Third-party trademarks and trade names may be used in this publication to refer to either the entities or their products/services. Shimadzu disclaims any proprietary interest in trademarks and trade names other than its own.

For Research Use Only. Not for use in diagnostic procedures.  
 The contents of this publication are provided to you "as is" without warranty of any kind, and are subject to change without notice. Shimadzu does not assume any responsibility or liability for any damage, whether direct or indirect, relating to the use of this publication.