

# ***Cabin Air Filtration Product***

## ***WIX No. 24687***

**The cabin air filter is under the cowl screens and they must be removed.**

- 1.**
  - Remove the two wiper pivot arms and then remove the windshield wipers.
- 2.**
  - Remove the four cowl vent screen retainers (pin-type retainers)
- 3.**
  - The right hand cowl overlaps the left hand cowl and must be removed first.
- 4.**
  - Remove both cowl vent screens.
- 5.**
  - Locate the cabin air filter cover and remove.
- 6.**
  - Replace the cabin air filter and reverse steps 1 through 5.

# Cabin Air Filtration Product

## WIX No. 24771

Estimated installation time (minutes): 20

1

**Tools:** Phillips screw driver & Standard screw driver

- Stop the windshield wipers in the up position.
- Open the hood.



2

- Remove the 3 screw caps from the left, middle & right side of passenger cowl cover.
- Remove the screws.
- Remove the weather stripping.



3

- Lift off the passenger cowl cover.
- Unsnap clip on left side of filter housing.



# Cabin Air Filtration Product

## WIX No. 24771 (cont.)

4

- Remove filter frame.



5

- Remove dirty filter from frame and replace with clean Cabin Air Filter.
- Replace frame in housing and fasten clip.
- Replace weather stripping, screws & screw caps.
- Close hood.



# Cabin Air Filtration Product

## WIX No. 24772

Estimated installation time (minutes): 10

1

- Lift hood.

2

- Locate panel on passenger side by windshield. A label on the panel identifies it as housing the filter.

3

- Remove (2) screws and remove cover.

4

- Lift out old filter from its housing.

5

- Fit new filter in housing and replace the cover.

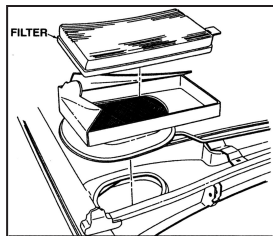

# Cabin Air Filtration Product

## WIX No. 24773

Estimated installation time (minutes): 15

1

- Open hood.
- Unhook clip on left of passenger side cowl cover & remove.



2

- Unclip vacuum hose from left & center of cowl cover.
- Remove passenger side cowl cover.



3

- Remove dirty filter & replace with a clean Cabin Air Filter.
- Replace the cowl cover.
- Reclip vacuum hose.
- Rehook clip on passenger side cowl cover.
- Close hood.



# Cabin Air Filtration Product

## WIX No. 24774

Estimated installation time (minutes): 5

1.

**Tools:** Phillips screw driver

- Open Hood
- Notice the cover for the Cabin Air Filter is on the cowl on the passenger side.
- Remove the screw from cover.



2.

- Remove cover by pulling toward the front of the vehicle. The filter is now visible.



3.

- Remove by pushing up on the filter to loosen from housing & then pulling out toward the front of the vehicle.



# ***Cabin Air Filtration Product***

## ***WIX No. 24774 (cont.)***

**4.**

- Replace with clean Cabin Air Filter.
- Replace cover by lining up the notches on either side of the cover plate to the grooves in the filter housing.
- Replace the screw in the cover plate.



# ***Cabin Air Filtration Product WIX No. 24775***

**1**

- The cabin air filter is under the hood in the cowl.

**2**

- Open hood

**3**

- Pull up the cowl seal.

**4**

- Disconnect the vacuum hoses from the main air flap actuators.

**5**

- Lift up the cabin air plenum housing.



# ***Cabin Air Filtration Product WIX No. 24775 (cont.)***

**6**

- Turn the windshield heating thermostalve counter clockwise to disengage.

**7**

- Lift the outside temperature sensor upward + position out of the way.

**8**

- Remove the cabin air housing cover.

**9**

- Replace the cabin air.

**10**

- Reinstall components using steps 7 thru 3 in reverse order.

# ***Cabin Air Filtration Product WIX No. 24776***

**1**

- The cabin air filter is under the hood in the cowl.

**2**

- Open hood

**3**

- Pull up the cowl seal.

**4**

- Disconnect the vacuum hoses from the main air flap actuators.

**5**

- Lift up the cabin air plenum housing.

# ***Cabin Air Filtration Product WIX No. 24776 (cont.)***

**6**

- Turn the windshield heating thermostatic valve counter clockwise to disengage.

**7**

- Lift the outside temperature sensor upward + position out of the way.

**8**

- Remove the cabin air housing cover.

**9**

- Replace the cabin air.

**10**

- Reinstall components using steps 7 thru 3 in reverse order.

# Cabin Air Filtration Product

## WIX No. 24777

Estimated installation time (minutes): 30

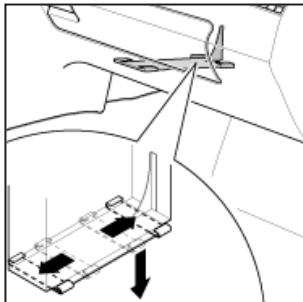
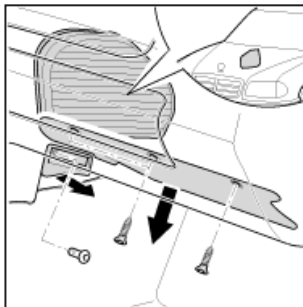

# *Cabin Air Filtration Product*

## *WIX No. 24777 (cont.)*

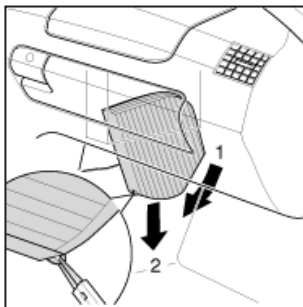

# ***Cabin Air Filtration Product***

## ***WIX No. 24778***

**1**

- The cabin air filter is behind the glove box and it must be removed.

**2**

- Obtain the radio anti-theft code before disconnecting the battery cable

**3**

- Disconnect the battery ground cable

**4**

- Remove the glove box by removing the retaining screws.

**5**

- Through the opening, remove the cabin air filter cover.

# ***Cabin Air Filtration Product WIX No. 24778 (cont.)***

**6**

- Remove the cabin air filter and replace with a new one.

**7**

- Reverse steps 5 through 3.

**8**

- After reconnecting the battery cable, enter the radio anti-theft code.

# ***Cabin Air Filtration Product***

## ***WIX No. 24779***

**Estimated installation time (minutes): 10**

**1**

- The cabin air filter is under the hood near the cowl.

**2**

- Open hood.

**3**

- Unsnap the cabin air housing retainers + remove the housing and filter.

**4**

- Install a new filter.

**5**

- Reattach the housing and snap retainers back in place.



# Cabin Air Filtration Product

## WIX No. 24780

Estimated installation time (minutes): 10

1.

**Tools:** Standard screw driver.

- Put windshield wipers in up position.
- Open hood.
- Remove weather stripping from passenger side of cowl.



2.

- Unclip wiper fluid hose in three places and remove.



3

- Unscrew & remove fittings on either side of cowl.
- Remove center screw cap.
- Take out cowl cover.



# ***Cabin Air Filtration Product***

## ***WIX No. 24780 (cont.)***

**4**

- Remove filter & replace with clean Cabin Air Filter.
- Reattach the cowl cover.
- Snap wiper fluid hose in place.
- Replace weather stripping.



# ***Cabin Air Filtration Product***

## ***WIX No. 24781***

**1**

- The cabin air filter is under the hood near the cowl.

**2**

- Open hood.

**3**

- Pull back the sealing strip located on the right air inlet grille.

**4**

- Open the right air inlet grille flap.

**5**

- Push inward on the cabin air retaining tabs, then lift upward and out of cowl filter housing.

# ***Cabin Air Filtration Product WIX No. 24781 (cont.)***

**6**

- Install a new cabin air filter into the housing. Make sure the retaining tabs are properly engaged.

**7**

- Reverse steps 4 through 2.

# Cabin Air Filtration Product

## WIX No. 24782

Estimated installation time  
(minutes): 45-60

1.

- Tools:** Standard screw driver & Phillips screw driver
- Open glove compartment.
  - Remove two locking tabs from either side of compartment.
  - Remove three screws on left, center & right of compartment.
  - Close compartment.



2.

- Remove access panel from right side of compartment.
- Remove two screws under access panel.
- Remove access panel in center of console under radio.
- Remove screw on right side under this panel.



3.

- Remove access panel under glove compartment.
- Remove two screws on underside of glove compartment & one screw on metal bar.
- Remove glove compartment disconnecting light wire on left side.



# Cabin Air Filtration Product

## WIX No. 24782 (cont.)

4.

- Remove remaining two screw on either side of metal bar. Remove bar.
- The access door to the filters is now visible.
- Pull up on access door to release & remove.



5.

- Pull out first filter in housing & slide second into opening to remove.
- Replace with clean Cabin Air Filters.
- Reverse steps to complete filter changeout.



# *Cabin Air Filtration Product*

## *WIX No. 24783*

Estimated installation time (minutes): 30

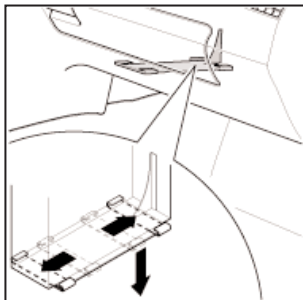
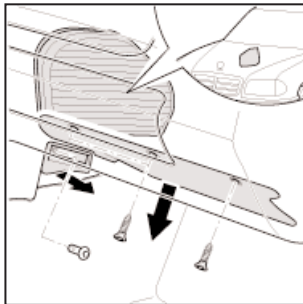

**CABIN AIR FILTER 24783**

# *Cabin Air Filtration Product*

## *WIX No. 24783 (cont.)*

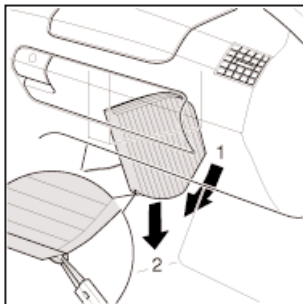



# ***Cabin Air Filtration Product***

## ***WIX No. 24784***

**Estimated installation time (minutes): 45-60**

**1**

- The cabin air filter is under the hood just in front of the windshield.

**2**

- Open hood.

**3**

- Turn the three cabin air housing retainers one quarter a turn.

**4**

- Remove the cabin air filter cover.

**5**

- Rotate the cabin air cover retainer 45 degrees, then remove the cover.

# ***Cabin Air Filtration Product WIX No. 24784 (cont.)***

**6**

- Replace the cabin air filter.

**7**

- Reinstall the cover, then turn the retainers a quarter of a turn to lock into place.

# Cabin Air Filtration Product

## WIX No. 24805

Estimated installation time (minutes): 15

1.

**Tools:** 7mm socket & 9mm Socket

- Open door to passenger side of vehicle.



2.

- Under glove compartment is a kick plate cover held in place by four screws. Remove the screws and take off cover.



3.

- The door to the Cabin Air Filter is now visible.
- Remove screw in door and unhinge.



# ***Cabin Air Filtration Product***

## ***WIX No. 24805 (cont.)***

**4.**

- Remove the first filter by pulling straight down.
- Remove the second filter by sliding forward and pulling down.
- Replace with clean Cabin Air Filters.
- Reattach door.
- Reattach kick plate cover.



# Cabin Air Filtration Product

## WIX No. 24806

Estimated installation time (minutes): 15

1.

**Tools:** Phillips screw driver. Standard screw driver.

- Open the hood.
- Remove the weather stripping from the passenger side of the cowl.

2.

- Remove the passenger side cowl cover by lifting straight up to release the four spring clips.

3.

- Remove the water shield now visible in the cowl cavity by disengaging the two locking tabs on either side of the shield.

4.

- The Cabin Air Filter is now visible. Remove and replace with a clean filter.

5.

- Reattach the water shield.
- Replace the cowl cover.
- Reattach the weather stripping.
- Close the hood.

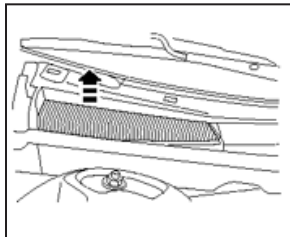

# Cabin Air Filtration Product

## WIX No. 24807

Estimated installation time (minutes): 10

1

- Open hood.
- The cover for the Cabin Air Filter is located on the passenger side of the cowl.



2

- Remove the filter from the housing.



3

- Install a clean Cabin Air Filter in the housing.



# *Cabin Air Filtration Product*

## *WIX No. 24807 (cont.)*

4

- Push the filter down until it is firmly sitting in the housing.
- Reattach the cover.



# Cabin Air Filtration Product

## WIX No. 24808

Estimated installation time (minutes): 15

1.

**Tools:** Phillips screw driver & Standard screw driver

- Stop windshield wipers in up position.
- Open hood.



2.

- Remove the cap on screw in center of cowl cover.
- Unscrew half way & pull out fitting.
- Unsnap three clips on front edge of cover & remove cover.

3.

- Either a filter or screen is visible under louver. Flip out front edge of housing & remove the filter or plate.





# *Cabin Air Filtration Product*

## *WIX No. 24808 (cont.)*

4.

- Replace with a clean Cabin Air Filter. Make sure the arrows on the filter are facing up.
- Reclip front of housing in place & replace the cowl cover.



# *Cabin Air Filtration Product*

## *WIX No. 24811*

**Estimated installation time (minutes): 20**

**1**

- Open glove compartment.
- At the rear of the compartment is a cover panel. Lift up & remove.



**2**

- Open the access door to the filter by swinging it open to the right.



**3**

- Remove first filter. Slide second filter from the left into the opening & remove.



# ***Cabin Air Filtration Product***

## ***WIX No. 24811 (cont.)***

**4**

- Replace with 2 clean Cabin Air Filters.
- Close the access door.
- Reattach the cover panel.
- Close glove compartment.



# Cabin Air Filtration Product

## WIX No. 24812, 24813

Estimated installation time (minutes): 10

1

**Tools:** Phillips screw driver.

- Open hood.
- The cover for the Cabin Air Filter is located on the passenger side in the cowl.



2

- Unsnap the cover and the filter is visible.
- Locate the lever on the left side of the housing. Push the lever out and remove the filter.



3

- Replace with a clean Cabin Air Filter by depressing the lever in the housing & sliding the filter into the double track.
- Replace cover.



# Cabin Air Filtration Product

## WIX No. 24812, 24813

Estimated installation time (minutes): 10

1

**Tools:** Phillips screw driver.

- Open hood.
- The cover for the Cabin Air Filter is located on the passenger side in the cowl.



2

- Unsnap the cover and the filter is visible.
- Locate the lever on the left side of the housing. Push the lever out and remove the filter.



3

- Replace with a clean Cabin Air Filter by depressing the lever in the housing & sliding the filter into the double track.
- Replace cover.



# ***Cabin Air Filtration Product***

## ***WIX No. 24815***

**Estimated installation time (minutes): 30**

**The cabin air filter is behind the glove box and it must be removed.**

- 1.**
  - Open the glove box
- 2.**
  - Remove the damper from the glove box then let the glove box hang down.
- 3.**
  - Slide out the cabin air cover + assembly from the evaporator case.
- 4.**
  - Remove the old filter from the housing + install a new cabin air filter + make sure it is properly seated.
- 5.**
  - Slide the assembly back into position + make sure there is no air leaking out of the evaporator.
- 6.**
  - Reinstall the glove box.

# Cabin Air Filtration Product

## WIX No. 24816

Estimated installation time (minutes): 10

1

**Tools:** Phillips screw driver & Standard screw driver

- Open Hood.
- On the passenger side of the cowl is the cover plate for the Cabin Air Filter.
- Remove four caps from windshield side of cover plate.



2

- Remove four screws.
- Remove 4 fittings from opposite side of cover plate.
- Remove cover plate.



3

- The rain shield is now visible. Remove the rain shield by pulling up & out.



# ***Cabin Air Filtration Product***

## ***WIX No. 24816 (cont.)***

**4**

- Lift the filter from the housing & replace with a clean Cabin Air Filter.
- Reinsert the rain shield, matching 3 clips on top of shield to indentations in top of sheet metal & rear tach cover plate.





# **Cabin Air Filtration Product**

## **WIX No. 24817**

**Estimated installation time (minutes): 10**

**1.**

- Open glove compartment.



**2.**

- Remove hinge tabs on either side of glove compartment.



**3.**

- Flip down the glove compartment and the access door is visible.



# ***Cabin Air Filtration Product***

## ***WIX No. 24817 (cont.)***

**4.**

- Open access door to the right & remove.
- Pull out the first filter & frame.
- Slide the second filter & frame to the left and pull out.

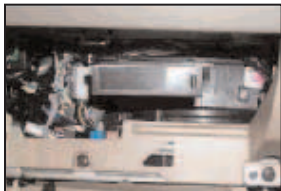

**5.**

- Remove dirty filters from each frame and replace with clean Cabin Air Filter.
- Reinstall both filters in housing.
- Reattach the access door.
- Replace the hinge tabs.
- Close the glove compartment.



# Cabin Air Filtration Product

## WIX No. 24818

Estimated installation time (minutes): 15

1

**Tools:** Torque screw driver.

- Locate trim panel beneath glove box.



2

- Remove 2 T-25 torque screws and snap out the trim panel.
- Remove 4 T-25 torque screws now visible on the cabin air filter cover panel.

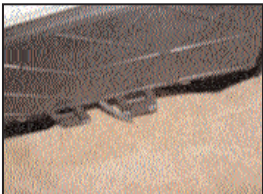

3

- Slide filter out and replace with a clean Wix<sup>®</sup> Cabin Air Filter.
- Orient the filter with the smaller edge up and the protruding plastic tab towards the back.
- Replace filter cover
- Replace trim panel.

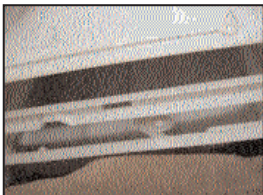

# Cabin Air Filtration Product

## WIX No. 24821

Estimated installation time (minutes): 15

1

- The cabin air filter is under the hood on the left side of the engine compartment close to the windshield.

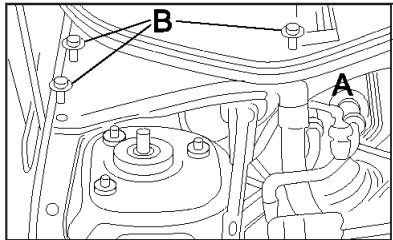

2

- Lift hood.

3

- Remove the drain hose to the right of the cabin air compartment.

4

- Remove the three screws on top of the cabin air compartment.

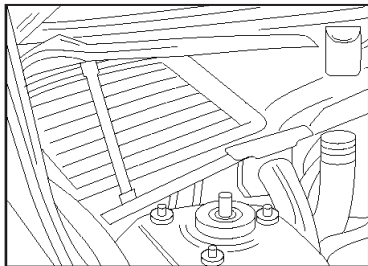

# Cabin Air Filtration Product

## WIX No. 24821 (cont.)

5

- Open the cabin air filter cover

6

- Remove the cabin air filter + replace with a new one.

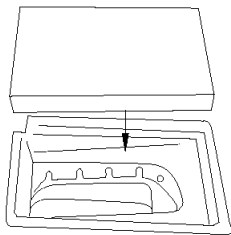

7

- Lower cover + replace the screws and drain hose.

# Cabin Air Filtration Product

## WIX No. 24822

Estimated installation time (minutes): 15

1.

**Tools:** Phillips screw driver

- Open hood.
- Remove weather stripping from passenger side.
- Remove four screws from cover to Cabin Air Filter.



2.

- Remove cover by pulling towards front of vehicle.



3.

- Remove filter & top filter housing plate by depressing the two tabs on the top housing plate.
- Lift filter & pull out.



# ***Cabin Air Filtration Product***

## ***WIX No. 24822 (cont.)***

**4.**

- Remove used filter from top housing plate & replace with clean Cabin Air Filter.
- Make sure to line up the four notches on the top side of the filter with the ribs on the top housing plate.
- Replace filter & top housing plate by sliding into place & pushing down until the two tabs click into place.
- Reattach cover.



## 1998-2005 New Beetle

The Cabin Air Filter should be replaced every 10,000 miles.

1. Disconnect and isolate the battery ground cable.
2. Push the instrument panel center cover forward and lift up to remove **Fig. 316**.
3. Remove the right-hand plenum panel cover attaching screws, **Fig. 317**, then lift the cover up and disengage from the clips at the front and rear edge.
4. Pull the right-hand plenum panel cover toward the center of the vehicle to disengage it from the A-pillar retainer.
5. Remove the right-hand close-out panel attaching screws, **Fig. 318**, then the panel.
6. Remove the rubber grommet.
7. Press the filter housing tabs, then remove the filter frame and element, **Fig. 319**.
8. Install the cabin air filter element and the frame into the filter housing, **Fig. 320**.
9. Install the rubber grommet.
10. Install the right-hand close-out panel.
11. Install the plenum panel cover.
12. Install the instrument panel center cover.
13. Connect the battery ground cable.

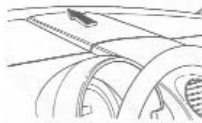

Fig. 316 Instrument panel center cover removal. 1998-2005 Volkswagen New Beetle



Fig. 317 righthand plenum panel cover retaining screw locations. 1998-2005 Volkswagen New Beetle

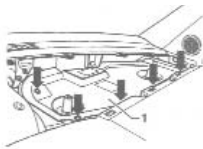

Fig. 318 Righthand close-out panel attaching screw locations. 1998-2004 Volkswagen New Beetle

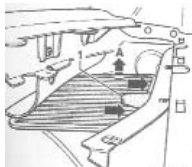
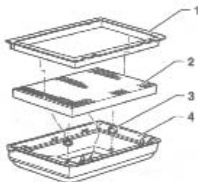

Fig. 319 Cabin air filter removal. 1998-2005 Volkswagen New Beetle



- 1 - Frame
- 3 - Filter element
- 4 - Plastic nut, 2.5 Nm (20 in lb)
- 5 - Filter housing with seal

Fig. 320 Cabin air filter assembly. 1998-2005 Volkswagen New Beetle



# Cabin Air Filtration Product

## WIX No. 24823

Estimated installation time (minutes): 30

The cabin air filter is behind the glove box and you must remove the glove box as well as the panel below the glove box called the lower glove box finisher.

1.
  - Remove the lower glove box finisher under the glove box - 3 clips hold it in place.
2.
  - Open the glove box + remove the glove box latch - 2 screws secure it.
3.
  - Remove the glove box - 4 screws to remove.
4.
  - Remove the glove box light.
5.
  - Carefully remove the yellow airbag connector by releasing the 2 push-in fasteners. The push-in fasteners are released by squeezing the side prongs together with needle nose pliers and slipping the fasteners out of the holes in the glove box.

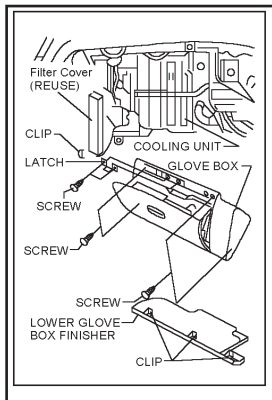

# Cabin Air Filtration Product

## WIX No. 24823 (cont.)

6.

- CAUTION! Do not disconnect the yellow airbag connectors from each other - also, do not allow the glove box to hang by the yellow airbag harness wires.

7.

- Remove the lower cabin air filter cover by removing 1 clip.

8.

- Remove the old cabin air filters from the cooling unit.

9.

- Insert the new filters into the cooling unit - NOTE - the filters are marked "UP" with an arrow - the end of the filter with the arrow should face the rear of the vehicle.

10.

- Reinstall the cover and the clip.

11.

- Attach the airbag connector on the glove box - make sure the 2 push-in fasteners are properly secured. Snap the glove box flap for the connector back in the locked position.

12.

- Replace the glove box light, the glove box, the latch and lower finisher.

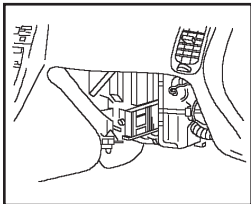

# ***Cabin Air Filtration Product***

## ***WIX No. 24853***

**Estimated installation time (minutes): 30**

**The cabin air filter is behind the glove box and it must be removed.**

- 1.**
  - Open the glove box
- 2.**
  - Push in the sides of the glove box to disengage the retainers then lower the glove box downward.
- 3.**
  - Remove the lower side instrument panel crash trim pad to the right of the glove compartment opening.
- 4.**
  - Remove the 4 glove compartment upper cover retaining screws, then the cover.
- 5.**
  - Remove the 2 glove compartment retaining bolts then remove the entire glove compartment.
- 6.**
  - Press on the cabin air filter cover tab, then remove the cover.

# ***Cabin Air Filtration Product***

## ***WIX No. 24853 (cont.)***

7.
  - Remove the cabin air filter from the blower unit.
8.
  - Install a new cabin air filter unit - make sure the air-flow arrows are facing the proper direction.
9.
  - Reverse steps 6 through 1.

# ***Cabin Air Filtration Product***

## ***WIX No. 24854***

**The cabin air filter is behind the glove box and the glove box assembly must be removed**

- 1.**
  - Remove the two glove box assembly screws at the left and right corners under the glove box.
- 2.**
  - Open the glove box and remove the four retaining screws at the upper left and right corners (it is not necessary to remove the four striker screws in the middle around the retaining latch).
- 3.**
  - Remove the glove box assembly from the dash.
- 4.**
  - You can now see the cabin air filter cover – remove the retaining screw and then remove the cabin air filter cover.
- 5.**
  - Remove the two cabin air filters – slide the first one out, then reach in and slide the other one to the opening and remove it.
- 6.**
  - Slide the first new filter into position then slide it to the right, then insert the second filter – make sure the air flow arrows are pointing downward.
- 7.**
  - Reinstall the cover and the glove box assembly.

# Cabin Air Filtration Product

## WIX No. 24856

Estimated installation time (minutes): 30

The cabin air filter is behind the glove box and it must be removed.

1.
  - Before installation, remove the negative battery cable.
2.
  - Remove the pivot pins from the glove box, then remove the glove box.
3.
  - Remove the 7 screws + 1 clip from the reinforcement panel and remove it.
4.
  - CAUTION! Do not disconnect the yellow airbag connector or disturb the front of the air bag module.
5.
  - Note: Your vehicle may or may not need to be modified depending on the model year - for vehicles built before 9/1/02, cut out the plastic section indicated by the shaded area above the tab with a utility knife - for vehicles after 9/1/02, remove the plastic access plate from the cooling unit.

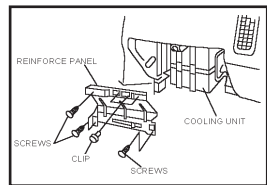
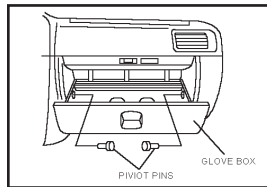
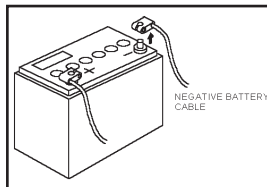

# Cabin Air Filtration Product

## WIX No. 24856 (cont.)

6.
  - Remove the old cabin air filters - keep in mind that some models do not have a factory installed cabin air filter so the cabin air filter housing may be vacant.
7.
  - Install the new cabin air filters by aligning with the plastic hook at the bottom. Insert the first filter then slide it up to the top position, then insert the second filter into the bottom position.
8.
  - Secure the filter clip - replace the glove box - reconnect the negative battery cable.

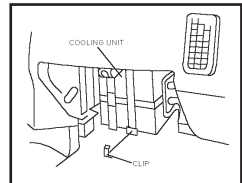
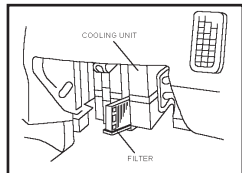
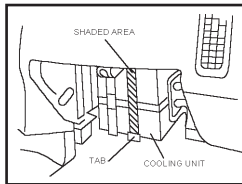

# Cabin Air Filtration Product

## WIX No. 24857

Estimated installation time (minutes): 30

The cabin air filter is behind the glove box and it must be removed.

1.
  - Remove the glove box door by removing the 2 hinge pins.
2.
  - CAUTION! Do not disconnect the yellow airbag connector.
3.
  - For the **Sentra models only**, follow these instructions: a) unsnap the retainer cord from the glove box door; b) Remove the 2 glove box latch screws and remove the latch; c) Remove the 4 glove box screws securing the glove box frame; d) Remove the side kick panel plastic nut - pull off the door seal adjacent to the side kick panel then unsnap + lift the front of the door sill finisher; e) Remove the hex nut + screw securing the lower finisher panel - do not remove the panel; f) Carefully remove the glove box frame so the metal bracket on the back clears the lower finisher panel. The flap with the yellow airbag connector at the top of the glove box frame must clear the finisher panel.

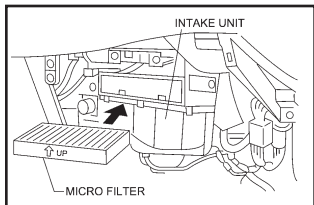
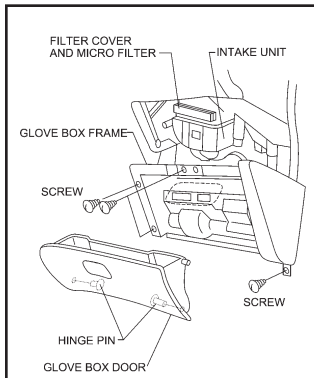



# Cabin Air Filtration Product

## WIX No. 24857 (cont.)

4. For all models, including the Sentra, remove the filter cover from the intake unit by disengaging the 2 hook tabs at the bottom of the cover - to disengage the hook tabs, pull the horizontal flange of the hooks from the lip of the housing.
5. Slide the cabin air filter out of the slot.

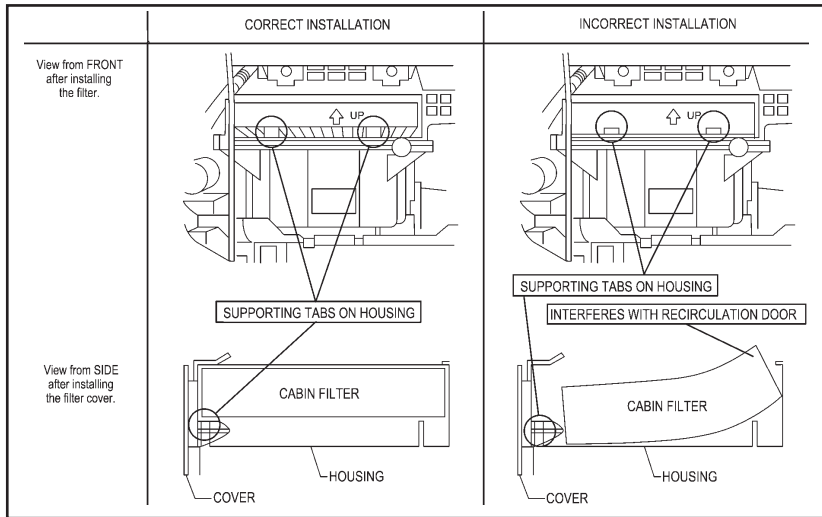

# ***Cabin Air Filtration Product***

## ***WIX No. 24857 (cont.)***

6.
  - When installing the new cabin air filter, make sure the filter sits on the top of the 2 supporting tabs on the housing.
7.
  - Replace the cover by inserting the 3 upper tabs inside the housing slot + pushing the hook tabs until they snap onto the housing lip.
8.
  - Reinstall the glove box frame + door.

# Cabin Air Filtration Product

## WIX No. 24863

Estimated installation time (minutes): 30

The cabin air filter is located behind the glove box and it must be removed.

1.
  - Before installation, disconnect the negative battery cable.
2.
  - Remove the 2 hinge pins from underneath the glove box.
3.
  - Remove the 6 screws surrounding the glove box perimeter and then remove the glove box.
4.
  - CAUTION! Do not disconnect the yellow airbag connector or disturb the front of the air bag module.

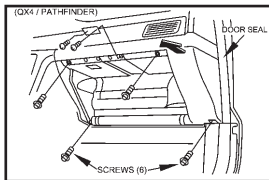
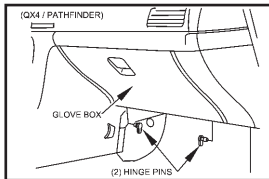
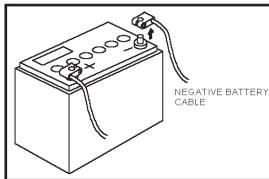

# Cabin Air Filtration Product

## WIX No. 24863 (cont.)

5.

- On the G20 + Altima models only, the glove box door does not need to be removed from the glove box assembly + lower finisher. a) Remove the door seal adjacent to the glove box assembly + lower finisher; b) Remove the lower finisher plastic nut + metal clip on the side (G20 only); c) Remove the 2 screws securing the metal latch and the 2 screws at the top of the glove box; d) Remove the 2 screws at the bottom corners; e) Disengage the clip securing the upper right corner of the box assembly.

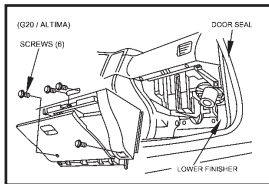

6.

- Cut out the plastic section indicated by the shaded area above the tab using a utility knife - make sure not to drop the plastic section into the housing opening.

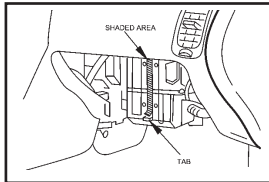

7.

- Remove the 2 cabin air filter elements from the housing.

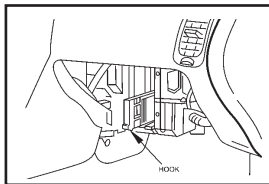

# Cabin Air Filtration Product

## WIX No. 24863 (cont.)

8.
  - The two new filters must be aligned with the plastic hook at the bottom - insert the first filter in the bottom position - then slide it up to the top position - then insert the second filter into the bottom position.
9.
  - Secure the filter with the clip.
10.
  - Replace the glove box + housing.
11.
  - Reconnect the negative battery cable.

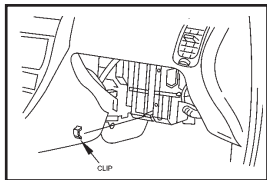

# Cabin Air Filtration Product

## WIX No. 24864

Estimated installation time (minutes): 5

1

- The cabin air filter is located under the passenger side dashboard.

2

- Find the cabin air filter housing cover, then slide the housing cover clip to the left to remove.

3

- Locate the cabin air filter - pull downward to remove.

4

- Install a new cabin air filter - this filter has a pivot that allows it to fold to assist with the installation.

5

- Reinstall the cover + the retaining clip.

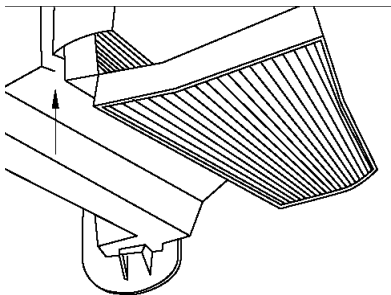
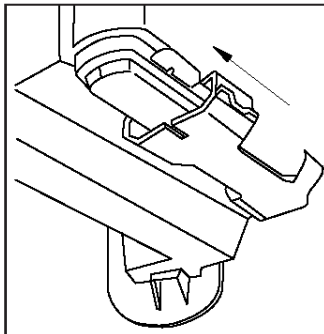

# Cabin Air Filtration Product

## WIX No. 24865

Estimated installation time (minutes): 10

1

- Open the glove box and remove cover at the back of the glove box.

2

- Unlatch door to vent filters.

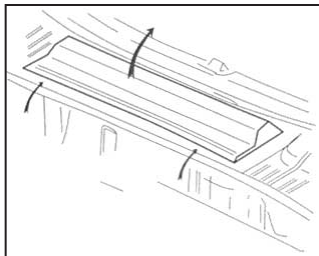

3

- Remove filter that is visible. Another filter is located along side (left) the one just removed. Slide it to the opening and remove.

4

- Slide in (2) new filters and close door. Replace cover at the back of the glovebox.

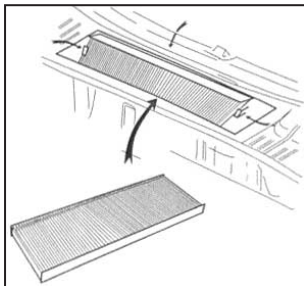

# Cabin Air Filtration Product

## WIX No. 24866

Estimated installation time (minutes): 5

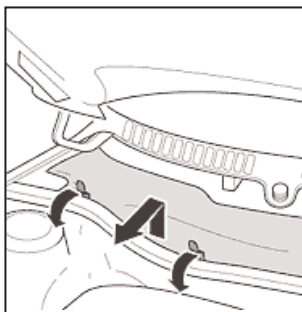
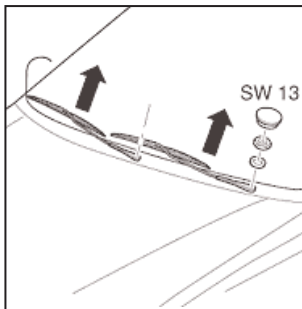

CABIN AIR FILTER 24866



# Cabin Air Filtration Product WIX No. 24866 (cont.)

CABIN AIR FILTER 24866

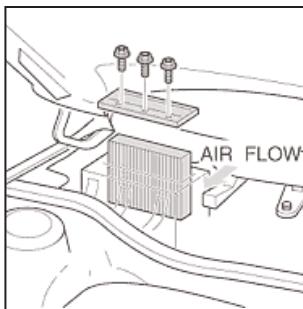
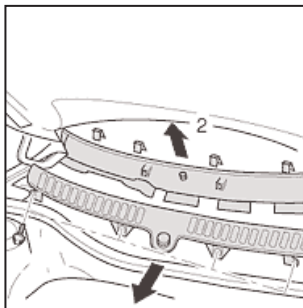

# ***Cabin Air Filtration Product*** ***WIX No. 24867***

**CABIN AIR FILTER 24867**

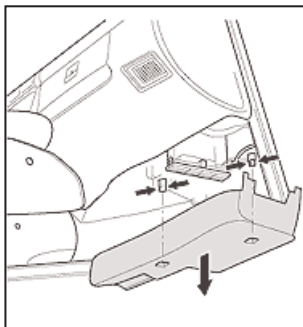
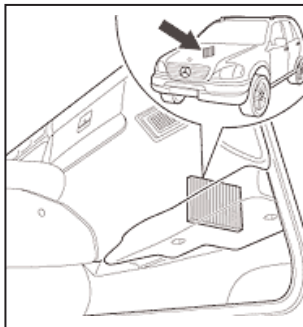

# Cabin Air Filtration Product

## WIX No. 24867 (cont.)

CABIN AIR FILTER 24867

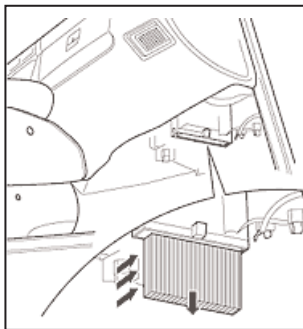
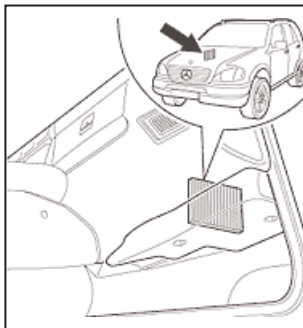

# ***Cabin Air Filtration Product***

## ***WIX No. 24868***

**Estimated installation time (minutes): 10**

**1**

- Open the glove box and remove cover at the back of the glove box.

**2**

- Unlatch door to vent filters.

**3**

- Remove filter that is visible. Another filter is located along side (left) the one just removed. Slide it to the opening and remove.

**4**

- Slide in (2) new filters and close door. Replace cover at the back of the glovebox.

# Cabin Air Filtration Product

## WIX No. 24869

1

**Tools:** Phillips screw driver

- Open hood.
- Remove weather stripping from the passenger side of the cowl.
- Unscrew and remove the 4 screws in passenger side cowl cover.



2

- Lift our passenger side cowl cover.

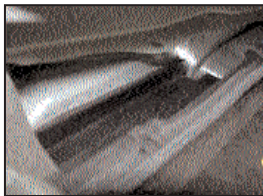

3

- Unsnap hinges on both sides of the cabin air filter cover and remove.

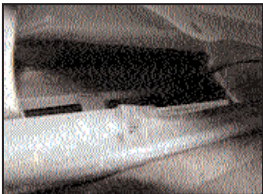

# ***Cabin Air Filtration Product***

## ***WIX No. 24869 (cont.)***

**4**

- Pull-out filter and replace with a clean Wix® Cabin Air Filter.
- Replace cabin air filter cover
- Reattach cowl cover.
- Replace weather stripping.

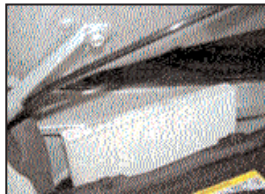

# Cabin Air Filtration Product

## WIX No. 24871

Estimated installation time (minutes): 10

1

- Open the glove box.
- Push in the sides of the glove box and rotate down.



2

- Remove the filter cover by lifting up on the two levers on the top edge of the cover.

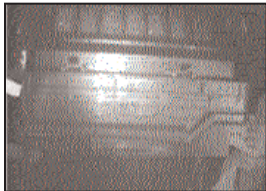

3

- Slide the dirty filter out.

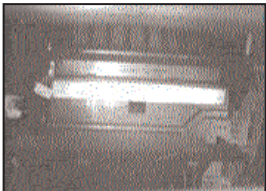

# *Cabin Air Filtration Product*

## *WIX No. 24871 (cont.)*

4

- Replace with a clean Wix<sup>®</sup> Cabin Air Filter.
- Replace filter cover. Depress sides of glove box and rotate back into place.





# Cabin Air Filtration Product

## WIX No. 24872

Estimated installation time (minutes): 10

1

**Tools:** Standard screw driver.

- Stop windshield wipers in upright position.
- Open Hood



2

- Remove the four push pins in the passenger side cowl cover.
- Remove cowl cover



3

- Pull out filter and replace with a clean Wix<sup>®</sup> Cabin Air Filter.
- Replace cowl cover



# Cabin Air Filtration Product

## WIX No. 24873

Estimated installation time (minutes): 10

1

- Open the glove box.
- Push in the side of the glove box and rotate down.



2

- Remove the filter cover.



3

- Slide the dirty filter out
- Replace with a clean Wix® Cabin Air Filter.
- Replace filter cover. Depress sides of glove box and rotate back into place.



# Cabin Air Filtration Product

## WIX No. 24874

Estimated installation time (minutes): 45-60

1

- Locate the filter door. Pull door down to open.

2

- The filter is removed in three parts. The filter opening allows only one part of the filter to be removed at a time (see illustration).

3

- Pull a section of the filter out. Repeat until all three sections are removed (see illustration).

4

- Install filters in reverse order of removal. Make sure to engage each filter to the previous one using the rails built into the filters (see inset).

5

- Close filter door

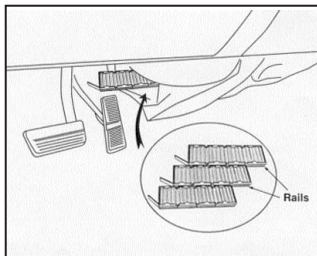

# Cabin Air Filtration Product

## WIX No. 24875

Estimated installation time (minutes): 15

- 1
  - The cabin air filter is located behind the glove box + it must be removed.
- 2
  - Open the glove compartment.
- 3
  - Remove the two glove compartment pins on each side of the glove compartment door.
- 4
  - Lower the glove compartment door.

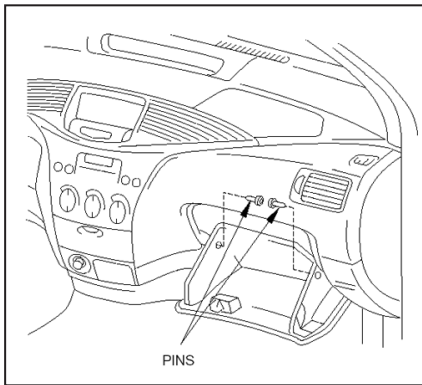

# Cabin Air Filtration Product

## WIX No. 24875 (cont.)

5

- Slide out the cabin air housing which contains the cabin air filter.

6

- Remove the cabin air element and replace with a new cabin air filter.

7

- Slide the housing back into housing opening.

8

- Lift the glove compartment upward and reinstall the pins.

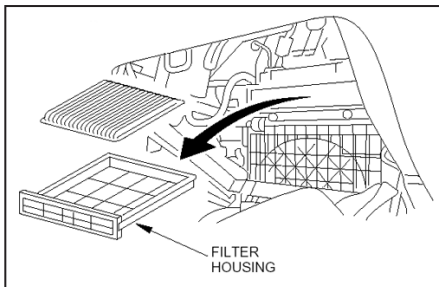

# Cabin Air Filtration Product

## WIX No. 24876

Estimated installation time (minutes): 10

1

- The cabin air filter is underneath the glove compartment. You do not have to remove the glove box.

2

- On the passenger side, under the glove box, remove the cabin air filter cover from the AC/heater assembly by removing the screws.

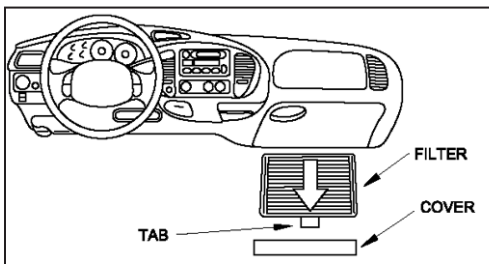

3

- Once the cover is removed, pull down the cabin air filter tab to remove the filter.

4

- Install a new filter making sure it is properly seated.

5

- Reinstall the cabin air filter cover.

# Cabin Air Filtration Product

## WIX No. 24877

Estimated installation time (minutes): 45-60

1

- The cabin air filter is behind the glove box + the glove box must be removed.

2

- Open the glove box and remove the stays at the back of the top of the glove box door.

3

- Remove the two retaining screws underneath the glove box.

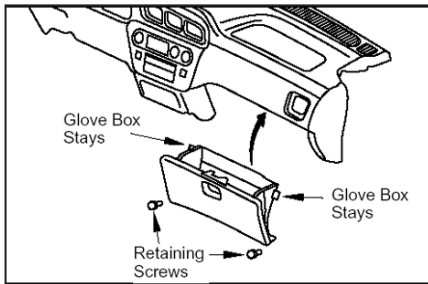

4

- Remove the glove box.

5

- Remove the glove box frame bolt + screws + remove the glove box frame.

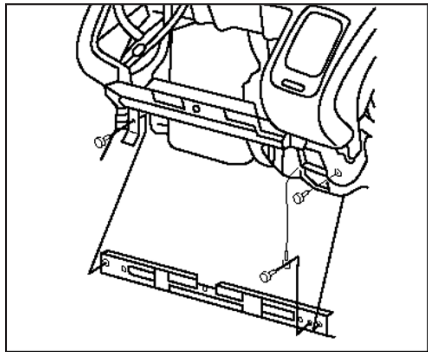

# Cabin Air Filtration Product

## WIX No. 24877 (cont.)

6

- A horizontal section of the dash blocks the cabin air door. This section can be cut away and discarded.

7

- Remove the filter cover + then remove the cabin air filter.

8

- On the CR-V models, the filter is in a retaining frame. Other models do not use a frame.

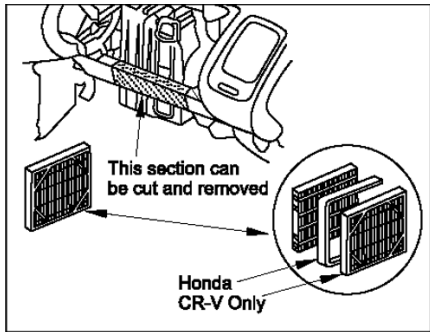

9

- Install a new cabin air filter + insert back in the housing.

10

- Reinstall the filter cover, the frame and the glove box.



# Cabin Air Filtration Product

## WIX No. 24878

Estimated installation time (minutes): 30

1

- The cabin air filter is behind the glove box and it must be removed.

2

- Disengage the 3 instrument panel retaining clips on the lower right-hand cover + remove the cover.

3

- Remove the stops on each side of the glove box. Air bag components are in this area, use extreme caution.

4

- Disconnect the truck lid release switch electrical connector.

5

- Remove the two bolts securing the glove box to the instrument panel.

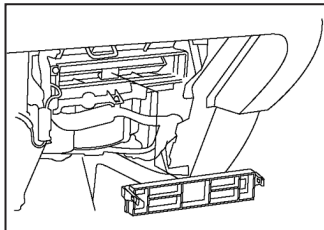

# ***Cabin Air Filtration Product WIX No. 24878 (cont.)***

**6**

- Remove the 3 glove box rear cover retaining screws.

**7**

- Disengage the 4 clips + remove the cover.

**8**

- Remove the filter cover from the recirculation housing.

**9**

- Turn the ignition switch to "on" + place the recirculation control switch to recirculate.

**10**

- Remove the cabin air filter housings from the recirculation housings (there are two).

# Cabin Air Filtration Product

## WIX No. 24878 (cont.)

11

- Separate the first filter housing from the second filter housing.

12

- Remove the second filter housing from the recirculation housing.

13

- Remove the cabin filters from the housings + replace - make sure the directions arrows on the filters + housings are pointing in the same direction.

14

- Position the second filter to the recirculation housing.

15

- Connect the first cabin air to the second - then install the cabin air filters into the recirculation housng.

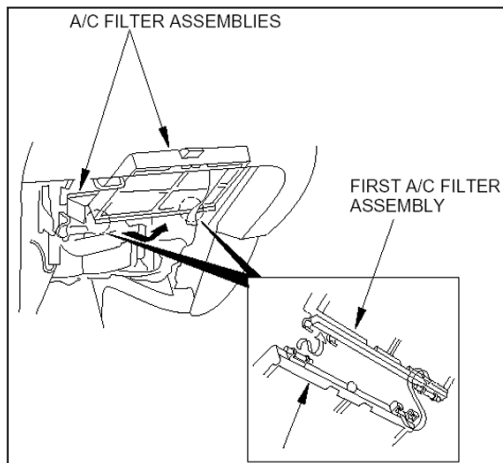

# ***Cabin Air Filtration Product WIX No. 24878 (cont.)***

**16**

- Reinstall the housing cover.

**17**

- Reattach the rear glove compartment cover to the instrument panel then engage the retaining clips and install the retaining screws.

**18**

- Reinstall the glove box using the two securing screws.

**19**

- Reconnect the truck lid release switch connector.

**20**

- Install the stops on each side of the glove box.

**21**

- Install the instrument panel lower right-hand cover. Make sure the three retaining clips are properly engaged.

# Cabin Air Filtration Product

## WIX No. 24879

Estimated installation time (minutes): 20

1

- The cabin air filter is behind the glove box + it must be removed.

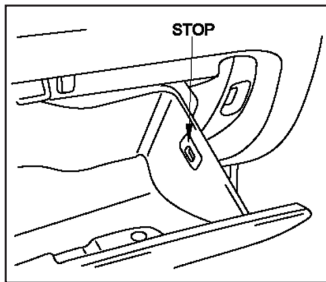

2

- Open the glove box and remove the stop on the right-hand side of the glove box and lower the glove compartment.

3

- Disconnect the control cable from the blower motor unit to gain access to the cabin air cover.

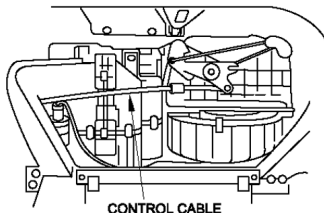

# Cabin Air Filtration Product

## WIX No. 24879 (cont.)

4

- Press on the cabin air cover tab + remove the cover

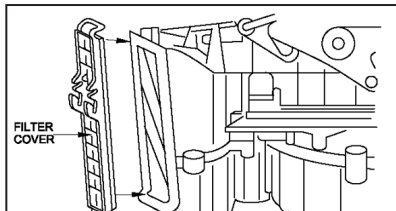

5

- Remove the two cabin air filters + replace with two new filters. Make sure the air flow arrows are pointing correctly.

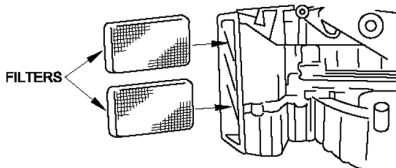

6

- Reinstall the cover, reconnect the cable and reinstall the glove box.

# ***Cabin Air Filtration Product***

## ***WIX No. 24881***

**Estimated installation time (minutes): 30**

**1**

- The cabin air filter is behind the glove box + it must be removed.

**2**

- Open the glove box.

**3**

- Press inward on both sides of the glove compartment, then lower the compartment.

**4**

- Remove the lower instrument panel crash trim pad.

# ***Cabin Air Filtration Product WIX No. 24881 (cont)***

**5**

- Remove the four glove box upper cover retaining screws, then the cover.

**6**

- Remove the two glove box retaining bolts and remove the glove box.

**7**

- Press on the cabin air cover tab and remove the cover.

**8**

- Pull out the cabin filter + replace with a new one.



# ***Cabin Air Filtration Product WIX No. 24881 (cont)***

**9**

- Reinstall the cover.

**10**

- Position the glove compartment to the instrument panel then install the two retaining bolts.

**11**

- Install the glove compartment upper cover

**12**

- Reinstall the lower side crash pad.

**13**

- Lift the glove compartment into position and close.

# Cabin Air Filtration Product

## WIX No. 24882

Estimated installation time (minutes): 5

1

- The cabin air filter is behind the glove box + it must be removed.

2

- Open the glove box.

3

- Push inwards on both sides of the glove box to disengage the stops from the tracks.

4

- Lower the glove box after disengaging.

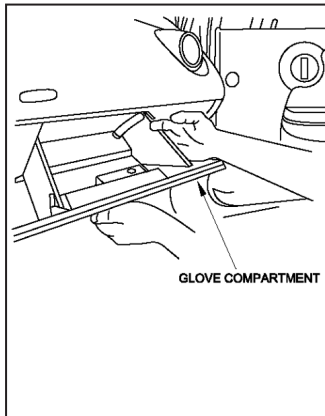

# Cabin Air Filtration Product

## WIX No. 24882 (cont.)

5

- Through this opening, lift the tab on the cabin air access door, then lower the door.

6

- Remove the filter from the housing and replace with a new cabin air filter.

7

- Close the cabin air compartment door + reinstall the glove box.

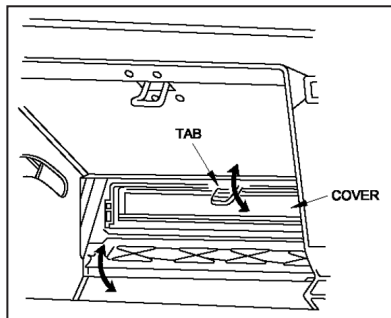

# Cabin Air Filtration Product

## WIX No. 24883

Estimated installation time (minutes): 10

### Camry Instructions

1

- The cabin air filter is located behind the glove box + the glove box must be removed.

2

- Open the glove box door.

3

- Remove the Phillips screw on the right side of the outside of the glove box door.

4

- Slide out the connecting rod.

5

- Push in each side of the glove box to release the tabs.

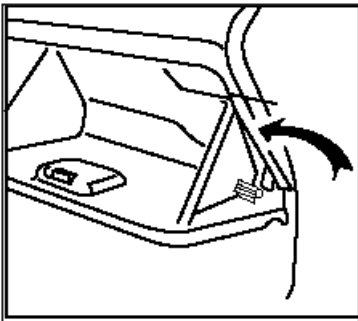
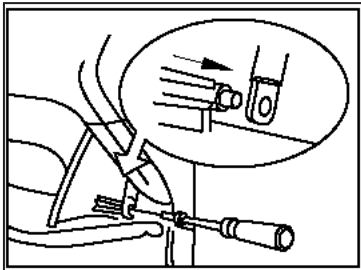

# Cabin Air Filtration Product

## WIX No. 24883 (cont.)

### Camry Instructions (cont.)

6

- Swing the glove box door downward.

7

- Slide out the cabin air filter housing.

8

- Remove the old filter and replace with a new cabin air filter - make sure the filter is properly seated in the housing.

9

- Slide the housing back into position.

10

- Reinstall the glove box.

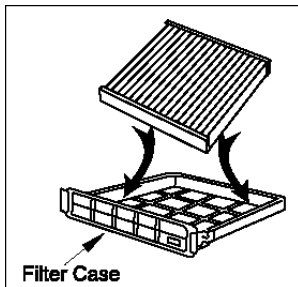
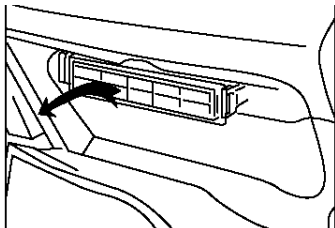

# Cabin Air Filtration Product

## WIX No. 24883 (cont.)

Estimated installation time (minutes): 10

### Avalon Instructions

1

- The cabin air filter is located behind the glove box + the glove box must be removed.

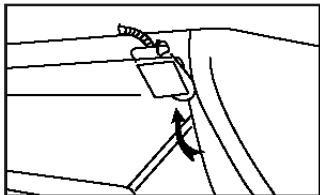

2

- Remove the cover under the glove compartment

3

- Open the glove box door.

4

- Using a flathead screwdriver, remove the airbag harness cover + pass the cover through the opening - **Important: Do not disconnect the airbag harness.**

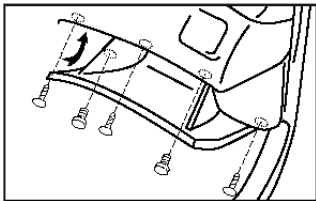

5

- Remove three screws + four bolts to remove the glove box door.

# Cabin Air Filtration Product

## WIX No. 24883 (cont.)

### Avalon Instructions (cont.)

6

- Pull out two tabs on each side of the cabin air housing + slide out the housing.

7

- Replace the cabin air filter - make sure it is seated properly in the housing.

8.

- Slide the housing back into its proper position.

9

- Reinstall the glove box + the airbag harness cover.

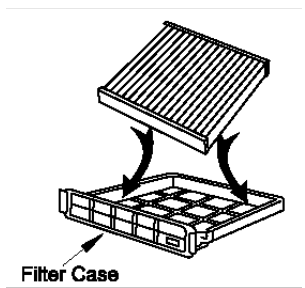
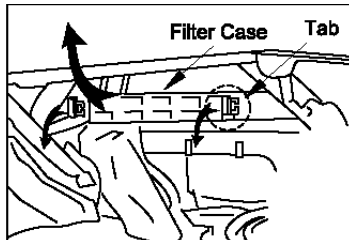

# Cabin Air Filtration Product

## WIX No. 24884

Estimated installation time (minutes): 10

1

- The cabin air filter is located under the passenger side cowl cover.

2

- Turn the ignition to the on position.

3

- Turn the windshield wipers on, when they are pointing up, turn off the ignition.

4

- Open the hood.

5

- Remove the five retaining screws from the passenger side cowl cover + remove cover.

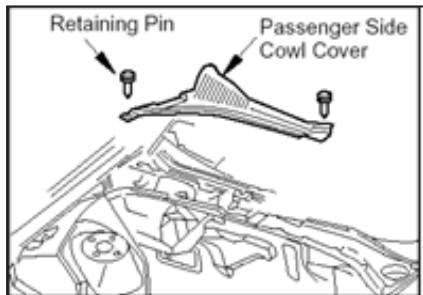



# ***Cabin Air Filtration Product WIX No. 24884 (cont.)***

**6**

- Remove the cabin air filter by sliding the filter upward.

**7**

- Install a new cabin air filter + replace the cowl cover.

# **Cabin Air Filtration Product**

## **WIX No. 24893**

**Estimated installation time (minutes): 10**

**1**

- The cabin air filter is located behind the glove box + it must be removed.

**2**

- Open the glove box.

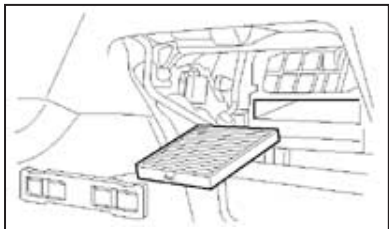

**3**

- Using a pair of pliers, remove the two retaining pins from the upper inside part of the glove box and lower the compartment.

**4**

- Through this opening, disengage the cabin air filter retainers.

**5**

- Remove the cover and the cabin air filter housing.

# ***Cabin Air Filtration Product***

## ***WIX No. 24893 (cont.)***

**6**

- Replace the cabin air filter element + reinstall the housing + cover.

**7**

- Reinstall the glove box.

# Cabin Air Filtration Product

## WIX No. 24894

Estimated installation time (minutes): 30-45

- 1
  - The cabin air filter is located inside the glove compartment. You do not have to remove the glove box door.
- 2
  - Open the glove box door.
- 3
  - Remove the plastic strip in the rear of the glove box.
- 4
  - Pull out the filter housing cover.

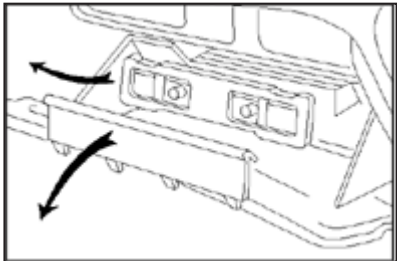

# ***Cabin Air Filtration Product WIX No. 24894 (cont.)***

**5**

- Slide out the filter element.

**6**

- Install a new cabin air filter.

**7**

- Reinstall the housing cover + plastic strip in the back of the glove box.

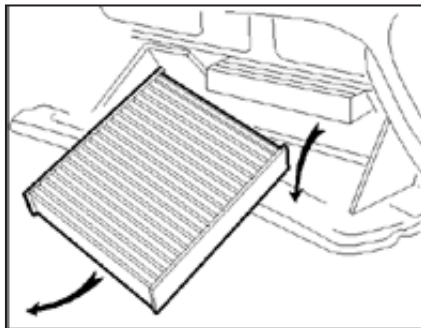

# Cabin Air Filtration Product

## WIX No. 24895

1

- The cabin air filter is located under the dashboard to the right of the accelerator.

2

- Disconnect the negative battery cable

3

- Pull back the carpet on the right side of the gas pedal + find the cabin air filter door cover.

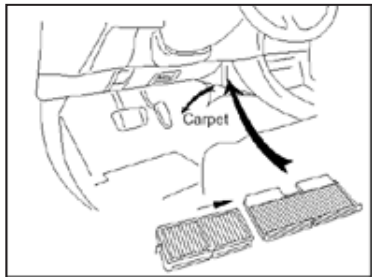

4

- Press in the plastic tab on top of the filter cover + open the door by pulling up and then out.

# Cabin Air Filtration Product

## WIX No. 24895 (cont.)

5

- The cabin air filters are removed in two parts. The filter opening only allows one filter to be removed at a time.

6

- Pull the first section out. To remove the second section, reach in and then up then remove the second filter section.

7

- Install the new filters in reverse order making sure they are installed in the correct order.

8

- Reinstall the filter cover.

9

- Reconnect the negative battery cable.

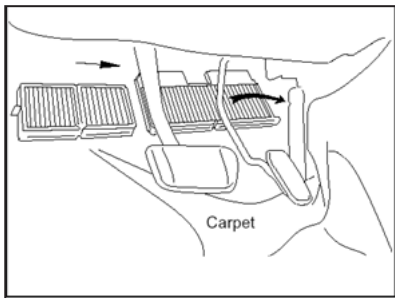

# **Cabin Air Filtration Product**

## **WIX No. 24896**

**Estimated installation time (minutes): 15**

- 1
  - The cabin air filter is under the hood under the passenger side cowl. Both windshield wiper arms must be removed to change out the cabin air filter.

- 2
  - Pull the wipers away from the windshield so they point away from the windshield.

- 3
  - Rotate each retaining clip at the base of the wiper arm counter clock-wise. Hold in this position while removing the wiper arm.

- 4
  - Remove the six screws from the cowl shield.

- 5
  - Open the hood.

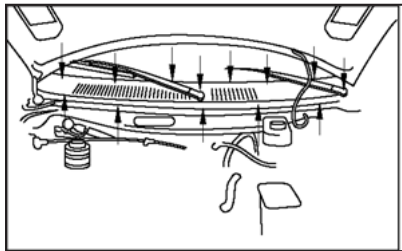



# Cabin Air Filtration Product

## WIX No. 24896 (cont.)

6

- Remove the four plastic screws from the forward section of the cowl shield.

7

- Disconnect the windshield washer hose from the Y-connector at the rear passenger side corner of the engine compartment.

8

- Remove the cowl shield.

9

- Remove the four screws from the cabin air vent cover.

10

- Remove the cabin air filter by pulling forward.

11

- Install a new cabin air filter.

12

- Reinstall the vent cover, cowl shield, washer hose and wiper arms.

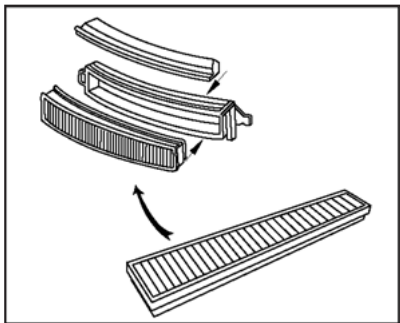

# Cabin Air Filtration Product

## WIX No. 24897

Estimated installation time (minutes): 30-45

- On models with radio anti-theft feature, prior to disconnecting the battery ground cable, make sure you have the radio anti-theft code.
- On all models, disconnect and isolate the battery ground cable. **After disconnecting the battery ground cable wait at least 3 minutes to allow the air bag system backup power capacitor to discharge.**
- Remove the stops located at each side of the glove compartment. **Air bag system components are located in this area, use extreme caution.**
- Remove the two bolts securing the glove compartment to the instrument panel.
- Using suitable diagonal cutters, cut the plastic cross brace located at the glove compartment opening at each end, then discard the plastic brace.

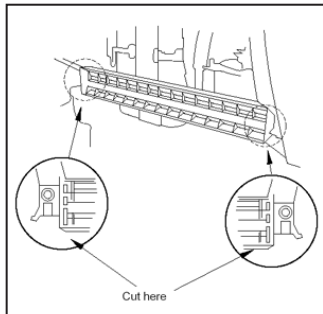
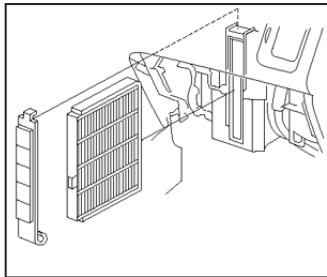

# *Cabin Air Filtration Product*

## *WIX No. 24897 (cont.)*

6

- Remove the glove compartment frame retaining bolts and screws, then the frame.

7

- Remove the filter cover from the evaporator housing.

8

- Remove the cabin air filter from the evaporator housing.

9

- Install the cabin air filter into the evaporator housing.

10

- Install the evaporator housing filter cover. Ensure the filter cover is securely seated.

# *Cabin Air Filtration Product*

## *WIX No. 24897 (cont.)*

11

- Position the glove compartment frame, then install the attaching bolts and screws.

12

- Install the glove compartment and secure with the two attaching bolts.

13

- Install the stops at each side of the glove compartment.

14

- Connect the battery ground cable.

15

- **On models with radio anti-theft feature**, enter the radio anti-theft code using the radio push buttons.

16

- **On all models**, ensure no air leaks are present at the evaporator cabin air filter cover.

# Cabin Air Filtration Product

## WIX No. 24899

Estimated installation time (minutes): 30

The cabin air filter is located behind the glove box and it must be removed.

1.
  - Open glove box.
2.
  - Push in the sides of the glove box and lower it until it hangs down.
3.
  - Remove the cabin air filter cover by pulling it from the top.
4.
  - There are two filters, remove the top then the bottom.
5.
  - Replace the filters and reinstall the cover + glove box.

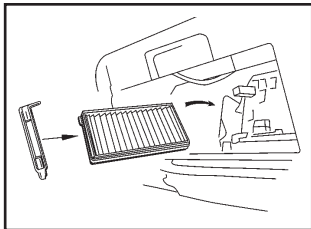
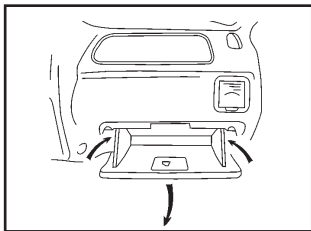

# Cabin Air Filtration Product

## WIX No. 24900

Estimated installation time (minutes): 30

1.
  - Open glove box.
2.
  - Push in the sides of the glove box and lower it until it hangs down.
3.
  - Release the two retaining tabs from the cabin air housing and pull out the housing cover.
4.
  - Replace the cabin air filter, reinstall cover + glove box.

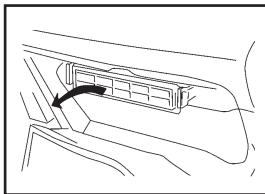
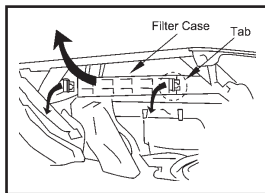
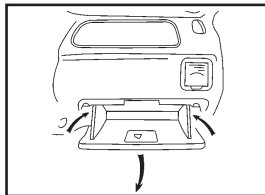

# Cabin Air Filtration Product

## WIX No. 24901

Estimated installation time (minutes): 30

The cabin air filter is located behind the glove box and it must be removed.

1.
  - Open glove box.
2.
  - Remove the two pins that hold the glove box to the instrument panel, then remove the glove box.
3.
  - Remove the cabin air housing cover, then cabin air filter.
4.
  - Replace the cabin air filter, then the cover and glove box.

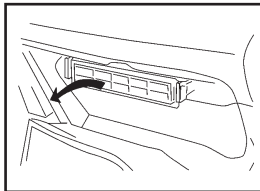
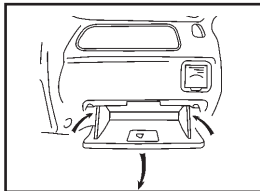
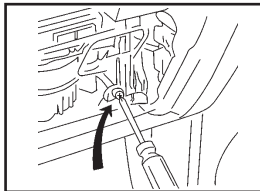

# Cabin Air Filtration Product

## WIX No. 24903

Estimated installation time (minutes): 30

The Jeep Grand Cherokee does not come from the factory with a cabin air filter. You must install a special order kit that you can order from your Jeep dealer. We do not offer this kit, only the replaceable element. The kit number is Mopar #82208300, which includes the kit and the filter. Once this kit is installed, then you can use our cabin air filter shown here. These instructions show the complete installation of the kit and the filter.

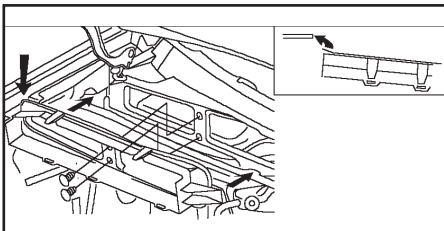
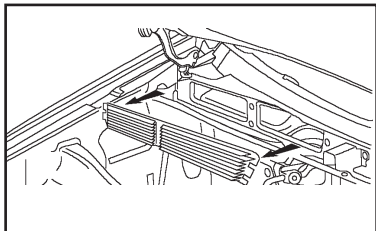
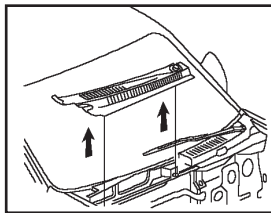
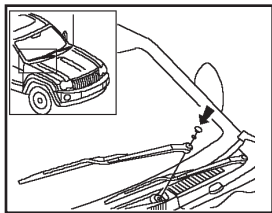



# Cabin Air Filtration Product WIX No. 24903 (cont.)

CABIN AIR FILTER 24903

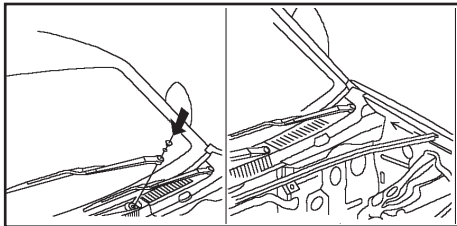
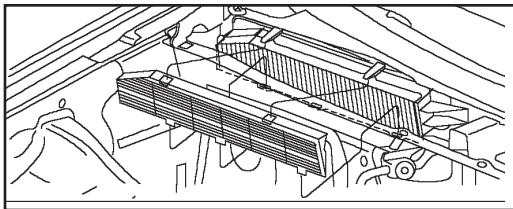
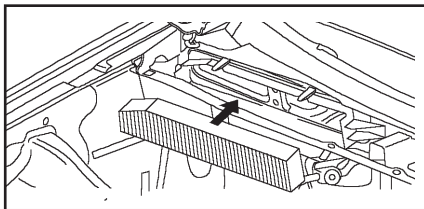

# Cabin Air Filtration Product

## WIX No. 24904

Estimated installation time (minutes): 30

The cabin air filter is located under the glove box. You must remove the sound proofing panel underneath the glove box to access the cabin air filter.

1.
  - Remove the sound proofing panel under the glove box.
2.
  - Release the cabin air holder shown in figure A.

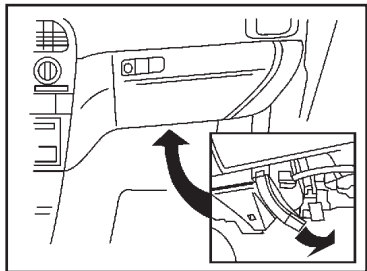
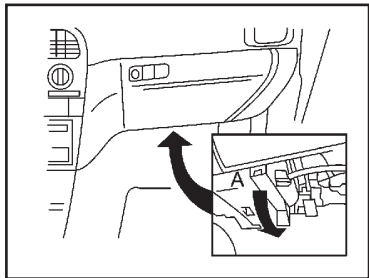

# Cabin Air Filtration Product

## WIX No. 24904 (cont.)

3.
  - Remove the cabin air filter by pulling downward.
4.
  - Install the new cabin air filter, re-secure the holder and re-install the panel.

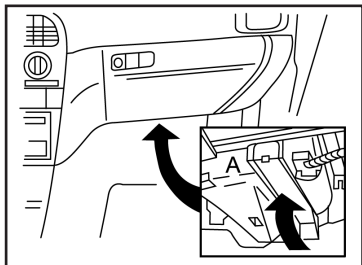
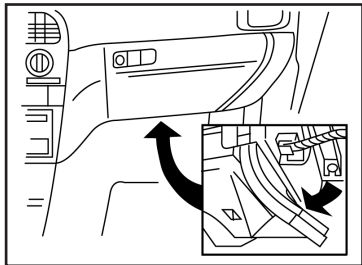

# ***Cabin Air Filtration Product***

## ***WIX No. 24905***

**Estimated installation time (minutes): 30**

**The cabin air filter is behind the glove box and it must be removed.**

- 1.**
  - Open the glove box.
- 2.**
  - Unhook the clip that holds the stop cable to the glove box.
- 3.**
  - Push in the sides of the glove box to disengage the retainers then lower the glove box downward.
- 4.**
  - Through the compartment opening, remove the cabin air housing.
- 5.**
  - Remove the cabin air filter from the housing and install a new element. Make sure the arrows face upward.
- 6.**
  - Reinstall the housing making sure it is properly seated.
- 7.**
  - Reinstall the glove box + stop cable.

# **Cabin Air Filtration Product**

## **WIX No. 24906**

Estimated installation time (minutes): 30

The cabin air filter is located under the hood in the passenger side cowl.

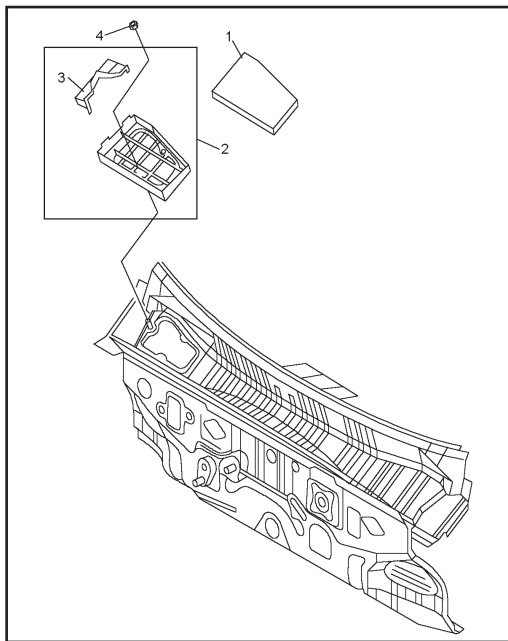

# Cabin Air Filtration Product

## WIX No. 24907

Estimated installation time (minutes): 30

The cabin air filter is behind the glove box and it must be removed.

1.
  - Open the glove box.
2.
  - Remove the damper clip string from the right hand side of the glove box.
3.
  - Press both sides of the glove box until it releases from the dash.
4.
  - Hold the glove box level, not fully lowered. Gently pull the glove box towards you until the hinges release. CAUTION: Do not force the glove box loose because the hinge could break. The hinge will not release unless the glove box is at the correct angle.
5.
  - Remove the cabin air cover.
6.
  - Remove the old cabin air filter and replace with the new one.
7.
  - Replace cover, glove box + string clip.

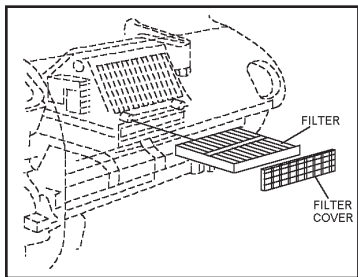

# ***Cabin Air Filtration Product***

## ***WIX No. 24908***

**Estimated installation time (minutes): 30**

**The cabin air filter is behind the glove box and it must be removed.**

- 1.**
  - Remove the 2 screws from the lower portion of the glove box compartment door and then remove the door.
- 2.**
  - Remove the 3 right lower instrument panel trim panel screws, then the panel.
- 3.**
  - Through the glove box opening, disengage the filter cover retainers, then the cover.
- 4.**
  - Remove the 2 cabin air filters which are stacked vertically.
- 5.**
  - Install the lower cabin air filter + move downward, then install the upper element.
- 6.**
  - Reinstall the cover, the trim panel and the glove box.