



DESIGNER
SERIES



Cabinet Specification Guide

Special Order Vendor #60008081
SOM290677 Effective Date: 08/06/18

D29K49964-100



Frameless Cabinet Construction..... 3, 6

Door Styles and Finishes..... 4-5

Cabinet Reveals and Case Dimensions..... 7

Wall Cabinets..... 8-10

Base Cabinets..... 11-14

Tall Cabinets..... 15

Oven Cabinets..... 15

Vanity Cabinets..... 16

Accessories..... 17-19

Customer Care..... 20-21

Warranty..... 22

Wall Construction

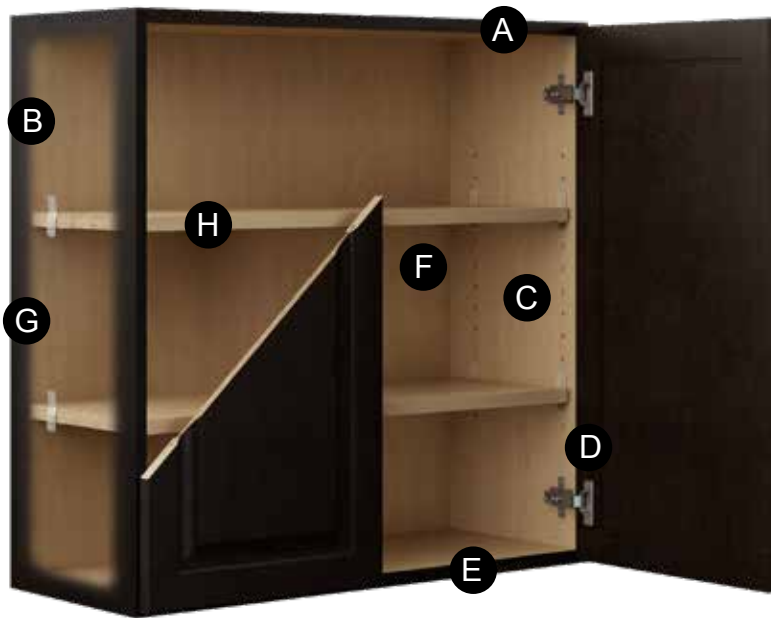

- A** 3/4" top panel*
- B** 1/4" back dadoed into end panel with concealed 4" mounting rail
- C** Self locking shelf clips
- D** Soft-close 6-way adjustable clip on 110 degree opening hinge
- E** 3/4" bottom panel*
- F** White or Natural Laminate interiors based on door style
- G** 5/8" side panels
- H** 3/4" full-depth adjustable shelves*
- I** Center shelf pin on cabinets 36" and wider

****Note: Any cabinet with a matching interior will be constructed (tops, bottom, back, shelves and sides) from 5/8" material.***

Base Construction

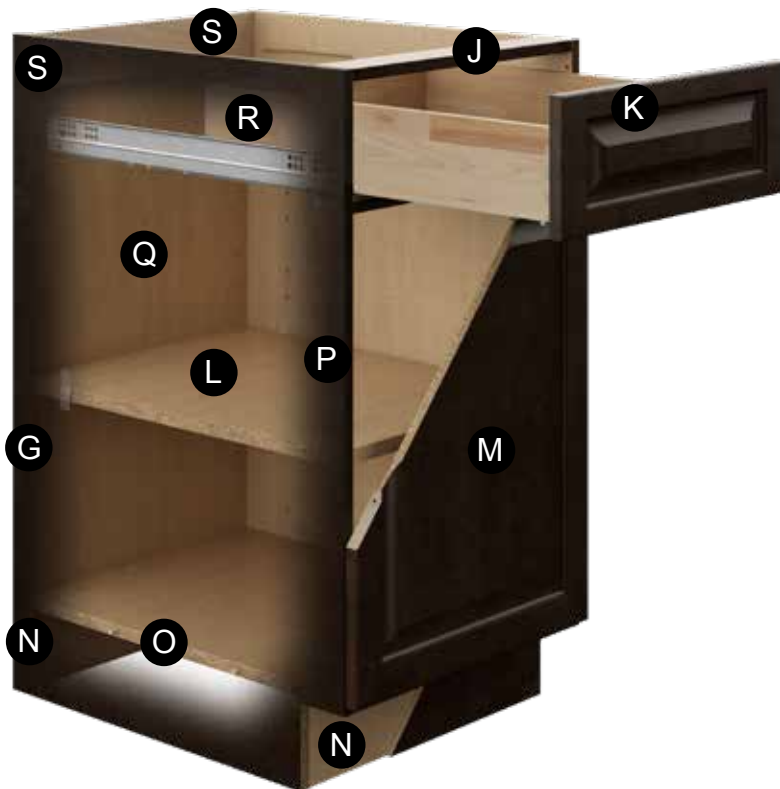

- J** 5/8" plywood rails doweled and glued into end panels
- K** Five piece drawer fronts on all styles except Edgeley
- L** 3/4" full depth, adjustable shelves
- M** All doors are full overlay design with 6 way adjustable clip on 110 degree hinge opening
- N** 5/8" bottom rails and toe kicks
- O** 5/8" bottom panel
- P** Doweled engineered panel and rail joinery
- Q** Full backs on bases (except sinks)
- R** Hardwood dovetail drawer with full extension under-mount soft close glide
- S** 1/4" laminated furniture board back panel with 4" x 5/8" plywood mounting rail

DOOR STYLES AND FINISHES

Edgeley White (EDWH)
Thermofoil



Edgeley Glacier (EDGL)
Thermofoil



Edgeley Thunder (EDTH)
Thermofoil



Edgeley Driftwood (EDDW)
Thermofoil



Elgin White (ELWH)
Thermofoil

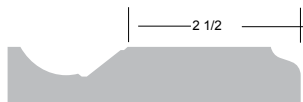

Elgin Heron Gray (ELGR)
Thermofoil

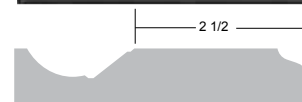

Melvern White (MLWH)
Thermofoil

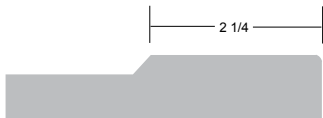

Melvern Heron Gray (MLGR)
Thermofoil

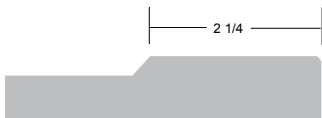

Soleste Spice (SHSP)

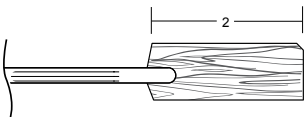

Grenta Espresso (GRES)

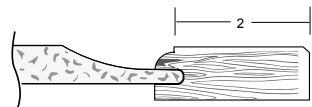

General Construction

Cabinets are frameless "European style" design with full access and full overlay styling. All panels and rail components are joined with engineered dowels, glue, screws, staples or a combination of those components appropriate to the typical use of the cabinet.

All frameless case construction is made from commercial grade furniture board with laminated, water resistant (not waterproof) surfaces.

Soft Close Hinge

All cabinets come with 6 way adjustable clip on 110° hinge opening with Soft Close (except where noted)



Shelf Clip

Self locking shelf clips



Drawer Construction

Dovetail Drawer

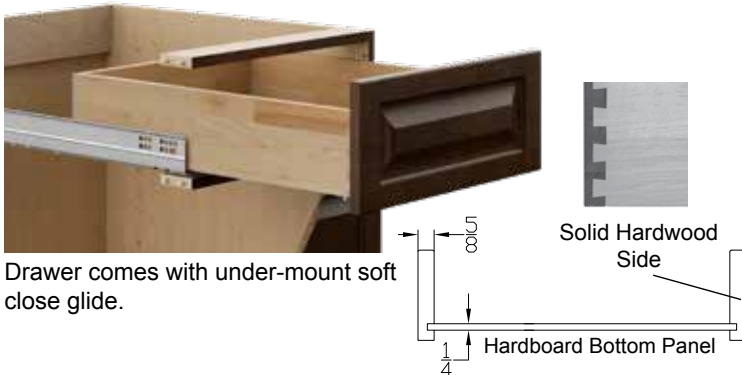

Larger drawers, such as pot and pan drawers, file drawers etc. come standard with a special heavy duty, full extension, 100 lb drawer glide. Note: This glide does not have the self closing feature

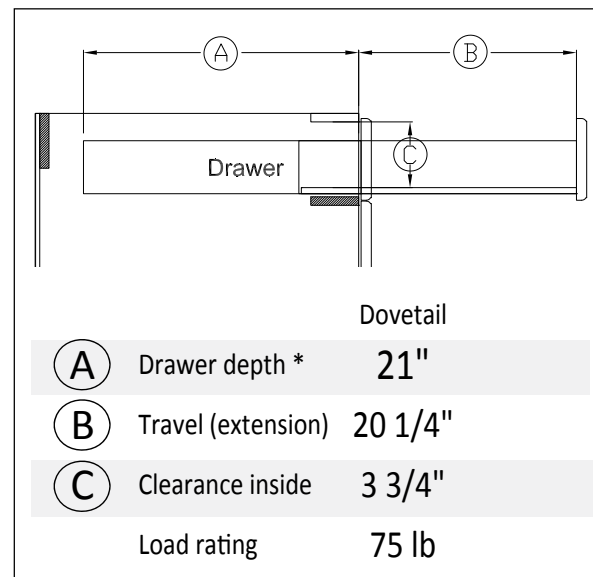

Stained and Heron Gray Door Styles

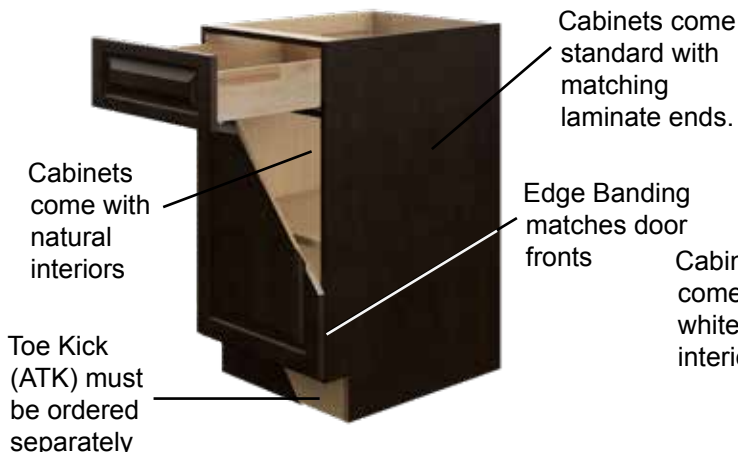

Thermofoil Door Styles (Except Heron Gray)

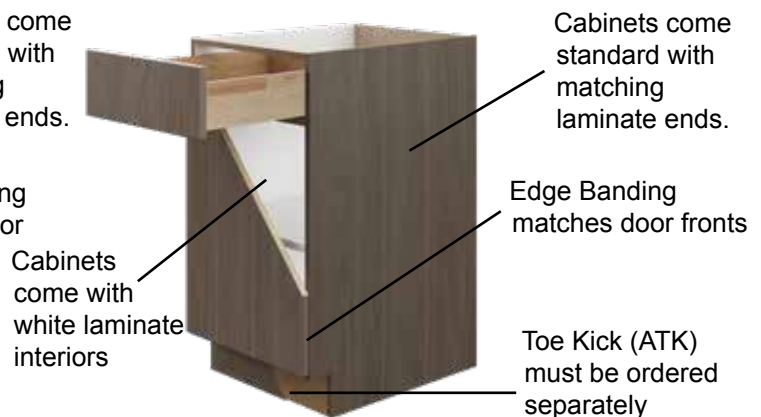

Wall Cabinets

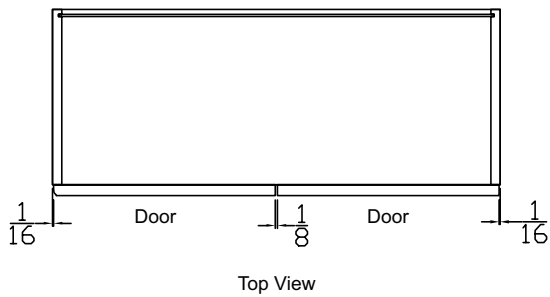
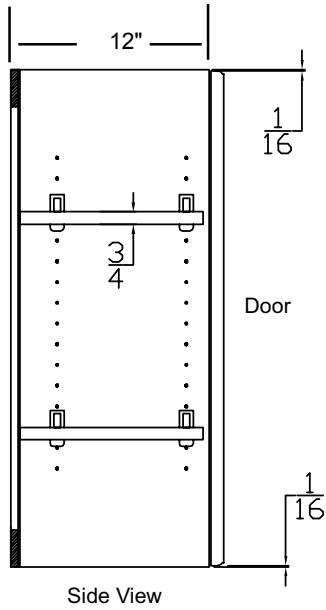

Base/Vanity Cabinets

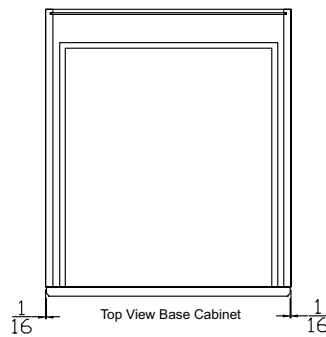
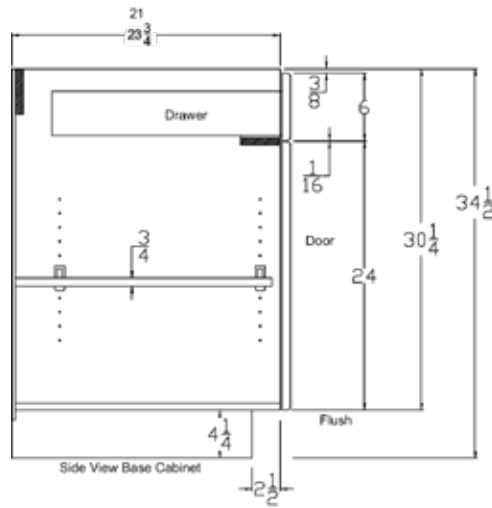

Tall Cabinets

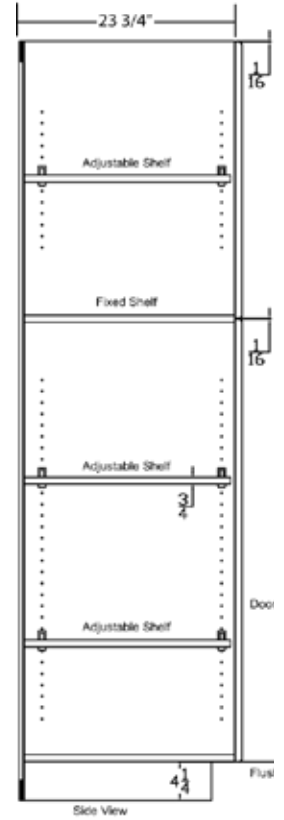

- 84" & 90" have 3 shelves, 96" has 4 shelves
- Upper doors align with 30", 36", and 42" wall cabinet
- Integrated Toe Kick

Single Door Wall Cabinet 12" Deep (W)



- 30" and 36" tall cabinet includes 2 adjustable shelves
- 42" tall cabinet includes 3 adjustable shelves

WIDTH INCHES	30" HEIGHT	36" HEIGHT	42" HEIGHT
9	W930	W936	W942
12	W1230	W1236	W1242
15	W1530	W1536	W1542
18	W1830	W1836	W1842
21	W2130	W2136	W2142

Double Door Wall Cabinet 12" Deep (W)

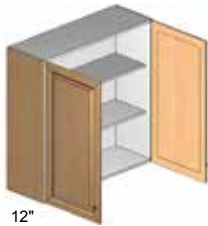

- 30" and 36" tall cabinet includes 2 adjustable shelves
- 42" tall cabinet includes 3 adjustable shelves

WIDTH INCHES	30" HEIGHT	36" HEIGHT	42" HEIGHT
24	W2430	W2436	W2442
27	W2730	W2736	W2742
30	W3030	W3036	W3042
33	W3330	W3336	W3342
36	W3630	W3636	W3642

Glass Door Cabinet w/ Matching Interior 12" Deep (WGD)



- Clear Glass Only
- Cabinets come standard with a matching laminate interior
- All components tops, bottoms, backs and shelves are made with 5/8" laminate furniture board
- Glass is NOT tempered. Certain building codes may prohibit the use of non-tempered glass installed below a minimum height
- 30" and 36" tall cabinet includes 2 adjustable shelves
- 42" tall cabinet includes 3 adjustable shelves

WIDTH INCHES	30" HEIGHT	36" HEIGHT	42" HEIGHT
15	WGD1530	WGD1536	WGD1542
18	WGD1830	WGD1836	WGD1842

Glass Door Cabinet with Matching Interior 12" Deep (WGD)

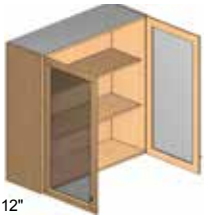

- Clear Glass Only
- Cabinets come standard with a matching laminate interior
- All components tops, bottoms, backs and shelves are made with 5/8" laminate furniture board
- Glass is NOT tempered. Certain building codes may prohibit the use of non-tempered glass installed below a minimum height
- 30" and 36" tall cabinet includes 2 adjustable shelves
- 42" tall cabinet includes 3 adjustable shelves

WIDTH INCHES	30" HEIGHT	36" HEIGHT	42" HEIGHT
30	WGD3030	WGD3036	WGD3042
36	WGD3630	WGD3636	WGD3642

Wall Diagonal Corner Cabinet (WC)



- 30" and 36" tall come with 2 adjustable shelves
- 42" tall comes with 3 adjustable shelves

12" x 24"

WIDTH INCHES	30" HEIGHT	36" HEIGHT	42" HEIGHT
24	WC2430	WC2436	WC2442

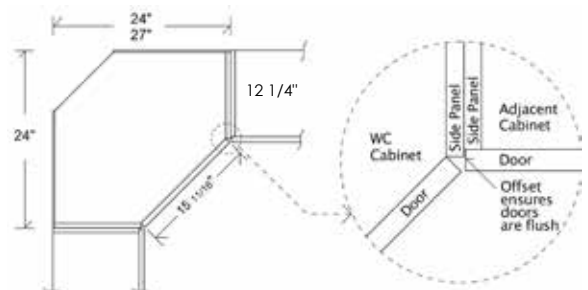

Wall Bridge Cabinet 12" Deep (W)

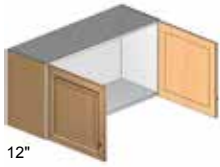

- 24" tall cabinet includes 1 adjustable shelf

WIDTH INCHES	12" HEIGHT	15" HEIGHT	18" HEIGHT	24" HEIGHT
24				W2424
27				W2724
30	W3012	W3015	W3018	W3024
33	W3312		W3318	W3324
36	W3612	W3615	W3618	W3624

Wall Bridge Cabinet 15" Deep (W)

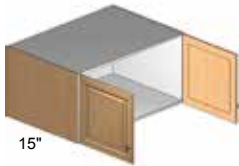

- 24" tall cabinet includes 1 adjustable shelf

WIDTH INCHES	12" HEIGHT	15" HEIGHT	18" HEIGHT	24" HEIGHT
30	W301215		W301815	W302415
33	W331215		W331815	W332415
36	W361215		W361815	W362415

Wall Bridge Cabinet 24" Deep (W)



- 24" tall cabinet includes 1 adjustable shelf

WIDTH INCHES	12" HEIGHT	15" HEIGHT	18" HEIGHT	24" HEIGHT
33			W331824	W332424
36			W361824	W362424

Wall Lift Up Cabinet (WLU)



- 24" tall cabinet includes 1 adjustable shelf

WIDTH INCHES	12" HEIGHT	15" HEIGHT	18" HEIGHT	24" HEIGHT
30			WLU3018	
36			WLU3618	

Wall Lift Up Aluminum Cabinet (WLUA)



- Aluminum Door comes with frosted glass only
- Interior will be white or natural based on finish selected

WIDTH INCHES	12" HEIGHT	15" HEIGHT	18" HEIGHT	24" HEIGHT
30			WLUA3018	
36			WLUA3618	

Framed Open Wall Cabinet 12" Deep (WOS)



- Wood frames are 1 1/2" wide
- Thermofoil frames are 2" wide
- Cabinets come with a matching laminate interior. All components tops, bottoms, backs and shelves are made with 5/8" laminate furniture board.
- 30" and 36" tall come with 2 adjustable shelves
- 42" tall comes with 3 adjustable shelves

WIDTH INCHES	30" HEIGHT	36" HEIGHT	42" HEIGHT
15	WOS1530	WOS1536	WOS1542
18	WOS1830	WOS1836	WOS1842
30	WOS3030	WOS3036	WOS3042
36	WOS3630	WOS3636	WOS3642

Decorative End Panels for Wall Cabinets



- Must be field installed.
- Can be fastened to the side of any standard size cabinet.
- Actual size of end panels 1/8" smaller in both width and height than the dimension code.

WIDTH INCHES	30" HEIGHT	36" HEIGHT	42" HEIGHT
12	D1230	D1236	D1242
15	D1530		
18	D1830		

Base Cabinet w/ Full Door (BF)



- Includes 1 full depth, adjustable shelf

WIDTH INCHES	MODEL NUMBER
9	BF9
12	BF12
15	BF15
18	BF18
21	BF21

Base Cabinet w/ 2 Full Doors (BF)



- Includes 1 full depth, adjustable shelf

WIDTH INCHES	MODEL NUMBER
24	BF24
27	BF27
30	BF30
33	BF33
36	BF36

Base Cabinet w/ 1 Drawer (B)



- Includes 1 full depth, adjustable shelf

WIDTH INCHES	MODEL NUMBER
12	B12
15	B15
18	B18
21	B21

Base Cabinet w/ 1 Drawer (B)



- Includes 1 full depth, adjustable shelf

WIDTH INCHES	MODEL NUMBER
24	B24
27	B27
30	B30
33	B33
36	B36

Sink Base Cabinet/Accessible Sink Base Cabinet (BS/BSH)



- 6" tall header
- Partial back eliminates need to cut out
- BSH36 ADA adaptable version has a removable bottom and toe kick

WIDTH INCHES	STANDARD	ADA
30	BS30	
33	BS33	
36	BS36	BSH36

Apron Sink Base (BSA)

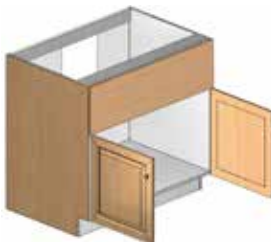

- 12" tall trimmable slab header
- Partial back eliminates need to cut out
- Accommodates most apron sinks and professional cooktops

WIDTH INCHES	MODEL NUMBER
36	BSA36

Base Cabinet w/ 3 Drawers (B3D)

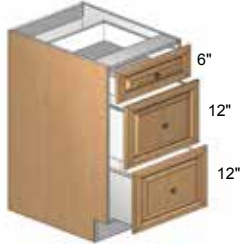

WIDTH INCHES	MODEL NUMBER
12	B3D12
15	B3D15
18	B3D18
21	B3D21
24	B3D24

Base Pot & Pan Cabinet w/ 3 Drawers (B3PP)

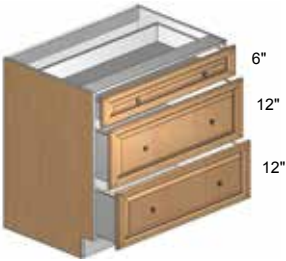

- Top drawer is dovetail with soft-close drawer guides. Bottom 2 drawer boxes are made of hardwood with full extension, side-mounted, heavy duty, soft close ball bearing glides

WIDTH INCHES	MODEL NUMBER
30	B3PP30
33	B3PP33
36	B3PP36

Base Cabinet w/ Single Waste Bin (BWS)



- Full extension heavy duty ball bearing glide system
- Includes one 12 gallon waste bin
- Soft close glide on top drawer
- Pull-Out Waste unit has full extension, side-mounted, heavy duty, soft close ball bearing glides

WIDTH INCHES	MODEL NUMBER
15	BWS15

Base Cabinet w/ Dual Waste Bins (BWD)



- Full extension heavy duty ball bearing glide system
- Includes two 12 gallon waste bins
- Soft close glide on top drawer
- Pull-Out Waste unit has full extension, side-mounted, heavy duty, soft close ball bearing glides

WIDTH INCHES	MODEL NUMBER
18	BWD18

Base Blind Corner Cabinet w/ Drawer (BB)



Shown as right

- Hinges mount to blind panel
- Includes 1 full depth, adjustable shelf
- Hinging specifications also indicate the position of the blind side (i.e., left hinge means blind is on the left)
- Not available with soft close hinge
- Filler must be ordered separately - minimum 1 3" AF330

WIDTH INCHES	MODEL NUMBER
39	BB39L
39	BB39R
42	BB42L
42	BB42R

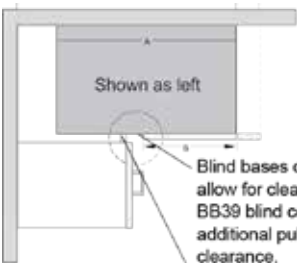

Blind bases do not require additional pull to allow for clearances. Example: Installing a BB39 blind corner at 39 will not require additional pull. It will set at 39" with a 3" clearance.

A Minimum of 1" filler must be used to clear adjacent cabinet. A larger filler will be required to clear the hardware of the blind corner has drawer. We recommend a 3" filler.

MODEL NUMBER	A BOX WIDTH	B DOOR AND DRAWER WIDTH	MINIMUM PULL	MAXIMUM PULL
BB39/BBF39	30"	12"	37"	41"
BB42/BBF42	33"	15"	40"	44"

Left = Door hinged Left
Right = Door hinged Right

* Warning - pulling a cabinet less than it's specified code size will not allow drawer hardware clearance.

Base Lazy Susan Corner Cabinet (BLS)

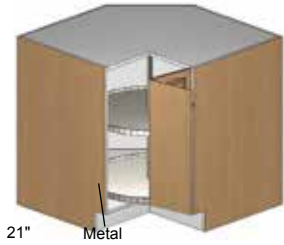

- See illustrations below for size requirements
- Fits through 32" door opening
- Includes 2 independently spinning steel wire baskets
- 3" gap at back
- Not available with soft close hinge
- 165 degree side hinges and knuckle hinges in center

WIDTH INCHES	MODEL NUMBER
36	BLS36

Base EZ Reach Corner Cabinet (BEZ)



- See illustrations above for size requirements
- Fits through 32" door opening
- 165 degree side hinges and knuckle hinges in center
- Includes 1 full depth, adjustable shelf
- Not available with soft close hinge

WIDTH INCHES	MODEL NUMBER
33	BEZ33
36	BEZ36

Base EZ and Lazy Susan Clearance

Note: If either side of the BEZ/BLS is exposed, then order AP2435 side panel to cover 3" gap

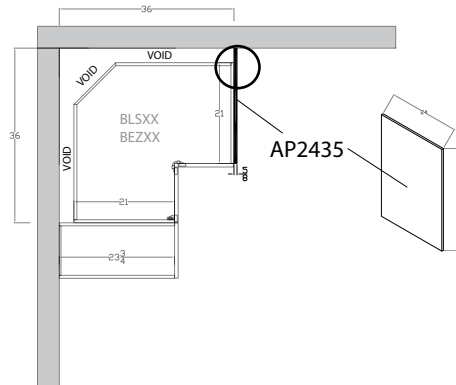

Corner Sink Base Kit (BSCK)



- Requires adjacent cabinet end panel or BDE
- Requires 42" x 42" space
- Cabinet includes two 12" x 30" doors
- Floor has parts sub-assembled with pocket screws for quick installation
- Back corner clipped for out of square corners
- Uses Standard Hinges
- Cleat required to support countertop (not included)

WIDTH INCHES	MODEL NUMBER
24	BSCK42

Dishwasher Return (BDE/BDEC)

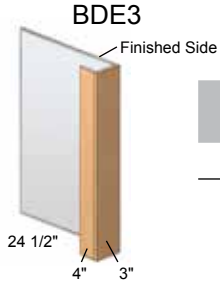

WIDTH INCHES	MODEL NUMBER
3	BDE3

- Side panel is same depth as standard cabinet, fascia flush with doors
- Finished on 1 side only
- Use 3" if end requires electrical outlet

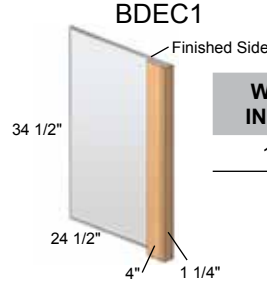

WIDTH INCHES	MODEL NUMBER
1 1/4	BDEC1

Base Column (BCB)



WIDTH INCHES	MODEL NUMBER
3	BCB3

- Side panels are same depth as standard cabinet, fascia flush with doors
- Finished ends standard
- Both sides are Finished

Roll-Outs Standard Kit (AROSTD) - Required for ARO's

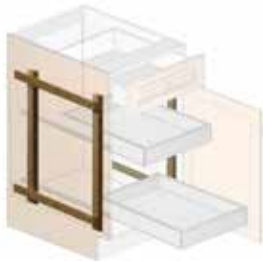

- Kit includes:
Two side mounts, screws and installation instructions
- For Tall Cabinets, 2 kits required
- Holes are pre-drilled for easy roll-out installation
- Required for ARO's

MODEL NUMBER
AROSTD

Roll-Outs (Loose) for Cabinets (ARO)

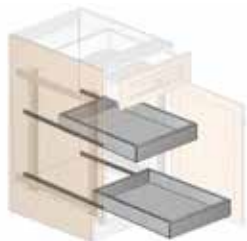

- Must be Field Installed
- Must order AROSTD (above) for installation
- Hardwood, dovetail drawer; soft-close glide

SINGLE DOOR WIDTH INCHES	MODEL NUMBER	DOUBLE DOOR WIDTH INCHES	MODEL NUMBER
12	ARO12	24	ARO24
15	ARO15	27	ARO27
18	ARO18	30	ARO30
21	ARO21	33	ARO33
		36	ARO36

Decorative End Panels for Base Cabinets

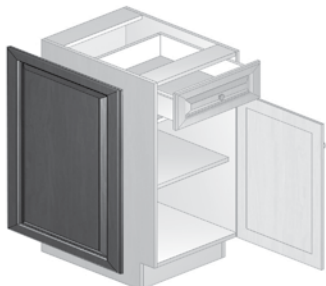

- Must be field installed.
- Can be fastened to the side of any standard size cabinet.
- Actual size of end panels 1/8" smaller in both width and height than the dimension code (Example: D2430 actual size is 23 7/8" x 29 7/8").

WIDTH INCHES	MODEL NUMBER
24	D2430

Tall Pantry 24" Deep (T)

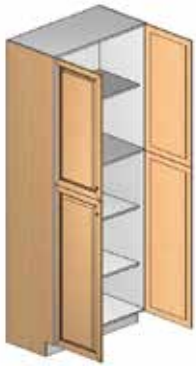

- 84"H and 90"H comes with 3 adjustable shelves
- 96"H comes with 4 adjustable shelves
- 18"W has two doors
- 24"W has four doors
- Integrated Toe Kick

WIDTH INCHES	84" HEIGHT	90" HEIGHT	96" HEIGHT
18	T1884	T1890	T1896
24	T2484	T2490	T2496

Tall Built-In Refrigerator Panel (TREC)



WIDTH INCHES	DEPTH INCHES	MODEL NUMBER
1 1/2	24 1/2	TREC196

- Side panel is same depth as standard cabinet, fascia flush with doors
- Finished on 1 side only
- Use 3" if end requires electrical outlet



WIDTH INCHES	DEPTH INCHES	MODEL NUMBER
5/8	24	AP2496B

- Both sides are finished

Oven Cabinet - Double (OVD)

Use for standard double ovens or split combo



WIDTH INCHES	OPENING MINIMUM	OPENING MAXIMUM	84" HEIGHT	90" HEIGHT	96" HEIGHT
33	See Chart	See Chart	OVD3384	OVD3390	OVD3396

- Divider for split ovens included
- Drawer front is 6" tall, interior clearance is 4 1/4"
- 90" and 96" cabinets include 1 full depth, adjustable shelf in upper section
- Includes plywood oven support panel
- Drawer is dovetail, soft-close
- Doors are soft-close

Cut-Out Opening Chart

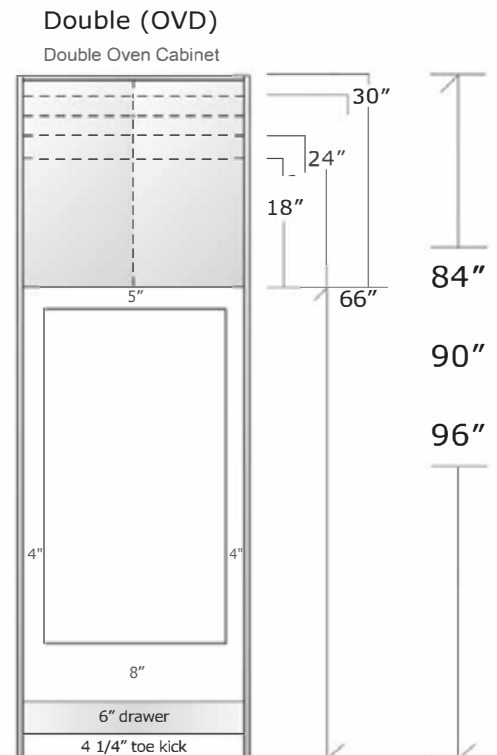

OVD33

Min.	Max.	Width
24 7/8"	29 7/8"	
Min.	Max.	Height
42 3/4"	52 3/4"	

Vanity Tall Base Cabinet w/ 2 Full Doors (VTF)

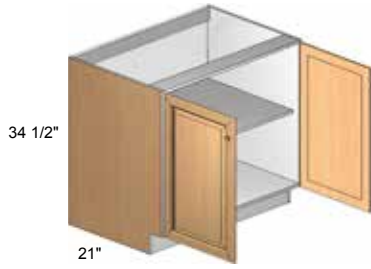

- Includes 1 full depth, adjustable shelf

WIDTH INCHES	MODEL NUMBER
24	VTF24
27	VTF27
30	VTF30
33	VTF33
36	VTF36

Vanity Tall Base Cabinet w/ 3 Drawers (VT3D)

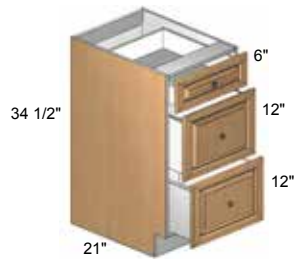

WIDTH INCHES	MODEL NUMBER
12	VT3D12
15	VT3D15
18	VT3D18
21	VT3D21
24	VT3D24

MOLDING

AMC4
Shaker
96" Length



AMS
Scribe Molding (3/4")
96" Length



AMC5
Traditional
96" Length



AMB
Batten Molding (3/4")
96" Length



Available in White, Heron Gray, and Espresso Only

AMC10
Transitional
96" Length



AMOC
Outside Corner Molding
96" Length



Not Available in Glacier, Thunder & Driftwood

AMLR1
Economy
3/4" Thickness
96" Length



AMSH
Base Shoe (3/4")
96" Length x (3/4")



AMBB
Base Board (4 1/2")

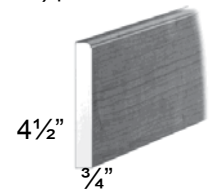

ATK
Toe Kick Skins (4 1/4")
96" Length x 5/8" (Thermofoil)
96" Length x 1/4" (Wood)

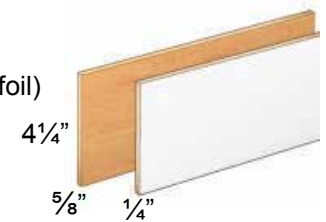

FILLERS

Furniture Board Filler (5/8")

DIMENSION	3" CODE	6" CODE
30 1/4"	AF330	
36"	AF336	
42"	AF342	
96"	AF396*	AF696

*Edgebanded 1 Long Edge

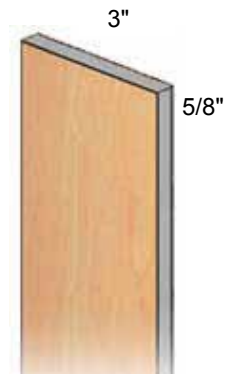

PANELS

Panels/Ends (5/8")

USES	THICKNESS	W X H	1-SIDED FINISH	2-SIDED FINISH
Base	5/8"	24"X35"	AP2435	
Tall				AP2496B
Island Back	5/8"	48"X35"	AP4835	
Refrigerator End	1 1/4"	24 1/2"X96"	TREC196	

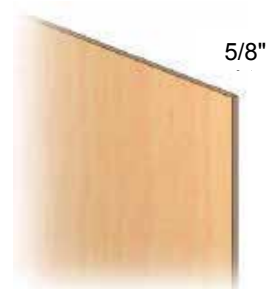

- Grain runs with second dimension of model number
- Cut down AP2435 for vanities
- Island Back edgebanded on two sides
- AP2496B Finished on Both Sides

HEAT DEFLECTOR

AKHD

Universal Heat Deflector Kit

- 2 Steel heat deflectors
- 1.75" x 30" x 1mm
- 8 Screws

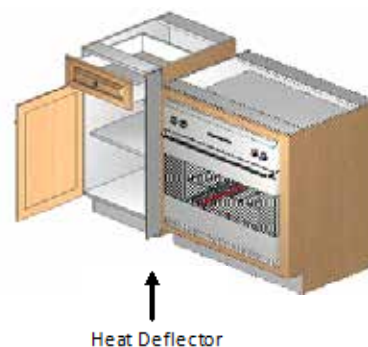
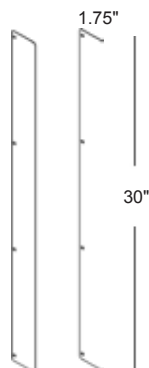

METAL CORBEL

ACBM9

- Use with overhang up to 12"



HARDWARE

Standard (AHK1)



DESCRIPTION	MODEL NUMBER
Brushed Nickel	AHK1-BN

Gallery (AHP13)



DESCRIPTION	WIDTH INCHES	CENTER INCHES	MODEL NUMBER
Brushed Nickel	6	3	AHP13.5-BN
Brushed Nickel	12	9	AHP13.12-BN

Square D (AHP14)



DESCRIPTION	WIDTH INCHES	CENTER INCHES	MODEL NUMBER
Brushed Nickel	5 3/4	5	AHP14-BN

TOUCH UP



DESCRIPTION	MODEL NUMBER
Fill Stick	FS230-xx
Touch Up Pen	FS281-xx

XX = Finish Code
 WH = White
 GR = Heron Gray
 GL = Glacier
 TH = Thunder
 DW = Driftwood
 SP = Spice
 ES = Espresso

About Us

Vendor Information:

Special Order Vendor #: 60008081

Customer Service #: 800-230-5661

Fax # for Order Processing: 844-554-0636

Email: HBDesignerseries@rsipcs.com

Address: 11350 Riverside Dr. Mira Loma, CA 91752

Customer Service Hours: Monday – Friday 6am – 5pm PST.

20/20 Catalog

HBDSXP

HBDSXP2

Website

Visit the Hampton Bay Designer Series website at www.hamptonbaykitchens.com for more product information and design ideas.

Order Processing and Lead-Time

Special order Hampton Bay Designer Series cabinet orders ship in 2 weeks. Some orders and store locations, including those outside the Continental U.S., may require more delivery time.

- Orders placed before 12pm PST M-F will be recognized at the end of the same business day
- Orders placed after 12pm PST M-F will not be recognized until the next business day
- Orders placed after 12pm PST F-Sun will be recognized on Monday (if not a holiday)

RTV Procedures

For any questions, please contact Customer Service at (800) 230-5661.

- If product was misshipped or there was an order entry error, contact customer service for disposition.

Damage and Shortage

- Reorder products or parts for consumer without delay. Replacements will be expedited as quickly as possible.
- If damage occurred during transit, have store receiving file a freight claim.
- All shortages must be reported to carrier within 30 days.

Manufacturing or Product Defect

- If the product has a manufacturing product defect process RTV for credit

Cancellations or Customer Return Requests: CANCELLATIONS OR CHANGES TO ORDERS ARE NOT ALLOWED AFTER 48 HOURS FROM RECEIPT OF THE STORE PURCHASE ORDER.

Care & Cleaning

- For normal spills, a damp cloth is sufficient. Remember to dry the surface immediately.
- Thermofoil doors can be cleaned with most general purpose household kitchen or bath cleaners.
- Wood doors can be cleaned with most general purpose household cleaners and polished with most furniture care products, not containing wax, petroleum solvents or silicones.
- Do not use caustic agents and/or abrasive scrubbers, or oven cleaners.
- Nicks and dings can be repaired with touch-up kits
- For stains that persist, flakes of Ivory soap diluted in warm water may be used. Remember to dry the surface immediately.
- Cabinets can be cleaned with a damp sponge, a cloth using soapy water, or most general purpose household cleaners. Do not use any type of abrasive cleaner or scrubbers.
- Do not let liquids stay on the surface for a long period of time. The surface is water resistant, not waterproof.

Disclaimers

Wood: Wood species in all finishes will exhibit color changes when exposed to different types of light and environments over time. Such color changes are expected in Hampton Bay Designer Series cabinets, and are not defects. Graining differences, mineral streaks and color variations are expected in wood cabinetry. Hampton Bay Designer Series door styles often exhibit these characteristics and such graining differences, mineral streaks or color variations are not defects.

Maple: Maple wood inherently has a characteristic known as "birdseye" or "fiddleback" pattern in the wood. When finished, it can have the appearance of a varied sheen, a splotchy appearance, or satiny look. This is the beauty of real maple and not a defect. In most cases it takes on a very pleasant look. Mineral streaks are common and may appear darker when stained.

Preventing Heat and/or Humidity Damage

Various cooking ovens, ranges, cook tops, cooking pots, toasters and other small appliances produce high heat and/or humidity. It is very important to make sure these products are positioned so rising heat is not trapped or confined, otherwise, you risk damage to cabinets or moldings that are not covered under the warranty. In addition, if higher temperature settings are used for extended periods of time, the radiant heat may be excessive and the doors and drawer fronts should be shielded or removed. This is particularly important on Thermofoil doors, which cannot be exposed to extended temperatures beyond 160 degrees without risking permanent damage. We recommend the use of a heat deflector (AKHD-page 18) for Thermofoil kitchen installations.

WARNING: This product can expose you to chemicals including wood dust, which are known to the State of California to cause cancer. For more information go to www.P65Warnings.ca.gov

Limited Lifetime Warranty

This warranty covers substantial defects in materials and workmanship in your Hampton Bay Designer Series Kitchen products under normal home use. This warranty is offered only to the original consumer purchaser and may not be transferred.

The coverage of this warranty lasts for the lifetime of the original purchaser, so long as he or she owns the home in which the product was first installed.

What This Warranty Covers: RSI Home Products, Inc. ("RSI") warrants its parts and products to be free of substantial defects in materials and workmanship from the original date of purchase under normal home use. This warranty is offered to the original consumer purchaser only and may not be transferred.

How Long The Warranty Lasts: Coverage for all Kitchen Cabinets and Accessories lasts for the life of the product.

What RSI Home Products Will Do Under The Warranty: During the warranty period, RSI, at its option, will repair or replace any part or product that proves to have substantial defects in materials or workmanship, or RSI will provide an equivalent replacement product. In keeping with our policy of continuous product improvement, RSI reserves the right to change specifications in design and materials without notice and with no obligation to retrofit products we previously manufactured.

How State Law Applies: This warranty gives you specific legal rights, and you may also have other rights that vary from state to state.

Implied Warranties: RSI disclaims any implied warranty of merchantability, and there are no warranties that extend beyond the descriptions on the face hereof. To the extent that such disclaimer is not valid under applicable law, any implied warranty shall be coextensive in duration with this warranty.

Hand Carving, Wood, Aging And Printing Limitations: Because of the varying natural characteristics of wood and the effects of aging, product shown in displays and/or printed materials will not be an exact match to new cabinetry you will receive. Depending on the wood characteristics, the age of a sample and the environment of the showroom, samples will show some degree of variation from new product. In addition, you should not expect all doors, drawer fronts, trim or molding to match exactly in either finish or grain. Variation in wood is normal and unavoidable. In addition, it is not possible to match our colors exactly in printed materials. Therefore, you should view the actual samples when making your color selection. Slight variation in size and design is also characteristic of individually hand carved items. This variation can occur from carving to carving, which only adds to their uniqueness and beauty.

What This Warranty Does Not Cover: This warranty does not cover any problems or damage which result from improper transportation, improper installation, mishandling, misuse, abuse, neglect, abnormal use, commercial use, improper maintenance, non-RSI repairs, accidents, or acts of God, such as hurricanes, fire, earthquakes or floods. This warranty, and any applicable implied warranties, does not cover incidental or consequential damages arising from any defects in the product, such as labor charges for installation or removal of the product or any associated products. This warranty does not cover defects or damage caused by normal wear and tear, alterations, environmental conditions, humidity absorption, or mold. In addition, variations in hand carved items, wood grain, finish color, aging or other natural wood and stain characteristics are not considered defects and are not covered by this warranty. Some states do not allow the exclusion or limitation of incidental or consequential damages, so the above limitation or exclusion may not apply to you.



Rev5_0818



800-230-5661
www.hamptonbaykitchens.com
Email: HBDesignerseries@rsipcs.com