

PANDUIT™

Cable Cleats For Short Circuit Protection



PANDUIT CABLE CLEAT SOLUTIONS FOR SHORT CIRCUIT PROTECTION

Available in a variety of sizes, [Panduit's extensive line of cable cleat solutions](#) ensures cables remain contained in the event of a short circuit fault, minimizing disruption and damage to personnel and property. Panduit's Cable Cleats are uniquely engineered for ease of installation in a range of applications and harsh environments. With a variety of cable cleats, Panduit has the right product to fit your needs while providing on the job productivity, reliability and safety.

REDUCE PROJECT COSTS AND REDUCE INSTALLATION TIME



Simple and intuitive design leads to increased productivity



Tested to IEC 61914:2015, the latest and most globally recognized cable cleat testing standard



Compatible with a variety of ladder racks and cables



Collaborative and consultative approach to cable cleat specification, supported by a team



Industry-unique mounting brackets and installation tool



Applications:
Oil and Gas, Petrochemical, Shipbuilding, Rail, Utilities and Data Centers

IEC 61914:2015 is the latest, most comprehensive and globally accepted cable cleat testing standard. It provides requirements for:

- Temperature rating
- Adequate resistance to flame propagation
- Lateral load testing
- Axial load testing
- Impact resistance
- UV resistance
- Resistance to electromechanical forces
- Corrosion resistance

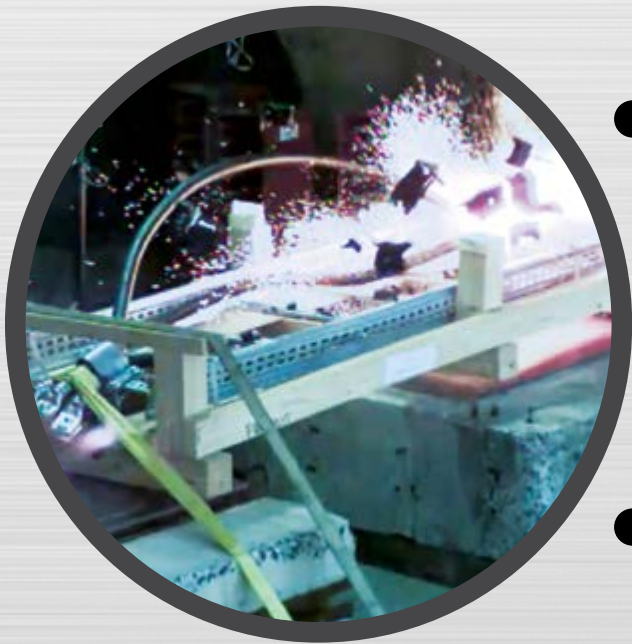

During a short circuit fault, maximum electromechanical stress between conductors occurs at or before 0.005 second

Typical circuit breakers and other protection devices trip and interrupt a fault between 0.06 to 0.1 second

Cable cleats perform their function within those first 0.005 second (i.e. at peak kA) before a circuit breaker trips and interrupts a fault

Panduit Research & Development has created a state-of-the-art ANSYS award-winning program that simulates the material composition of our cable cleats and the electromechanical forces present in a short circuit fault, preparing our cable cleats for testing to IEC 61914:2015.

The cleats are then subjected to a live short circuit fault at a testing laboratory to validate compliance with this standard. The simulation program is a powerful tool that helps us select the most appropriate materials for our cleats, so they perform to their tested kA rating during a short circuit fault.



Selecting the right Cable Cleat has never been so easy

Prevent damages resulting from a short circuit fault by specifying and installing Panduit Cable Cleats

SELECT cable layout
INPUT peak short circuit current
INPUT cable diameter

App provides part recommendations and IEC 61914:2015 short circuit test compliant cleat spacing.

Cleat kAlculator™ is available for download in the Apple Store or Google Play, and Panduit.com/cablecleat.



TABLE OF CONTENTS

PANDUIT CLEAT OVERVIEW6-7

STAINLESS STEEL CABLE CLEATS AND ACCESSORIES

Trefoil Cleat8-9

Buckle Strap Cleat10-11

Locking Strap Cleat12-13

CABLE CLEAT INSTALLATION TOOLS

BT2HTI14

BT75SDT14

PBTMT/E15

RT2HT15

Mounting Brackets16-17

Cushion Sleeve17

ALUMINUM CABLE CLEATS

Trefoil Cleat18-19

Two-Hole Cleat20-21

One-Hole Cleat22-23

POLYMER CABLE CLEATS

Trefoil Cleat24-25

Two-Hole Cleat26-27

One-Hole Cleat28-29

PANDUIT SOLUTIONS FOR ELECTRICAL AND NETWORKING INSTALLATIONS30-31

CABLE LAYOUT LEGEND



Flat



Trefoil

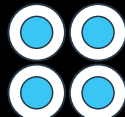

Quad



Multicore



Product	Trefoil Cleat	
Material	Stainless Steel	
Parts	12 Parts	
Diameter Ranges	20 - 25 mm 23 - 28 mm 26 - 32 mm 30 - 36 mm 34 - 40 mm 38 - 44 mm 42 - 48 mm 46 - 52 mm	50 - 57 mm 54 - 61 mm 58 - 65 mm 62 - 69 mm



PANDUIT CLEAT OVERVIEW



Buckle Strap Cleat	Locking Strap Cleat	Trefoil Cleat		Two-Hole Cleat	One-Hole Cleat	
Stainless Steel	Stainless Steel	Aluminum		Aluminum	Aluminum	
6 Parts	13 Parts	14 Parts		7 Parts	10 Parts	
12 - 45 mm 45 - 70 mm 70 - 95 mm 95 - 120 mm 120 - 150 mm 150 - 170 mm	12 - 95 mm (5) 95 - 120 mm (1) 95 - 150 mm (3) 120 - 150 mm (1) 150 - 195 mm (3)	23 - 26 mm 25 - 28 mm 27 - 30 mm 29 - 32 mm 31 - 35 mm 34 - 38 mm 37 - 41 mm 40 - 44 mm	43 - 47 mm 46 - 51 mm 50 - 56 mm 50 - 56 mm 55 - 61 mm 60 - 67 mm 66 - 75 mm	38 - 46 mm 46 - 58 mm 58 - 70 mm 70 - 83 mm 83 - 97 mm 97 - 109 mm 109 - 120 mm	10 - 13 mm 13 - 16 mm 16 - 19 mm 19 - 23 mm 23 - 27 mm 27 - 32 mm 32 - 38 mm 38 - 46 mm	46 - 51 mm 51 - 57 mm



CUSTOM CLEAT SOLUTIONS AVAILABLE
 For global engineered custom solutions and technical support, reach out to your local Panduit Sales Representative.
 To learn more visit: www.panduit.com/cablecleat

Trefoil Cleat	Two-Hole Cleat		One-Hole Cleat	
Polymer	Polymer		Polymer	
6 Parts	10 Parts		10 Parts	
22 - 28 mm 26 - 33 mm 31 - 39 mm 37 - 45 mm 43 - 52 mm 50 - 60 mm	38 - 46 mm 46 - 58 mm 58 - 70 mm 70 - 83 mm 83 - 97 mm 97 - 109 mm	109 - 120 mm 120 - 135 mm 135 - 150 mm 150 - 165 mm	10 - 13 mm 13 - 16 mm 16 - 19 mm 19 - 23 mm 23 - 27 mm 27 - 32 mm	32 - 38 mm 38 - 46 mm 46 - 51 mm 51 - 57 mm

STAINLESS STEEL TREFOIL CLEAT



The Stainless Steel Trefoil Cable Cleat offers protection against extreme environments and high short circuit current faults. It is made of 316L stainless steel, available in multiple sizes with cable range taking capability, and suitable for trefoil cable arrangements.

The cleat can be installed after running cable using a Panduit mounting bracket or before running cable by installing direct to the cable tray rung through a fixing hole using an M8 bolt.

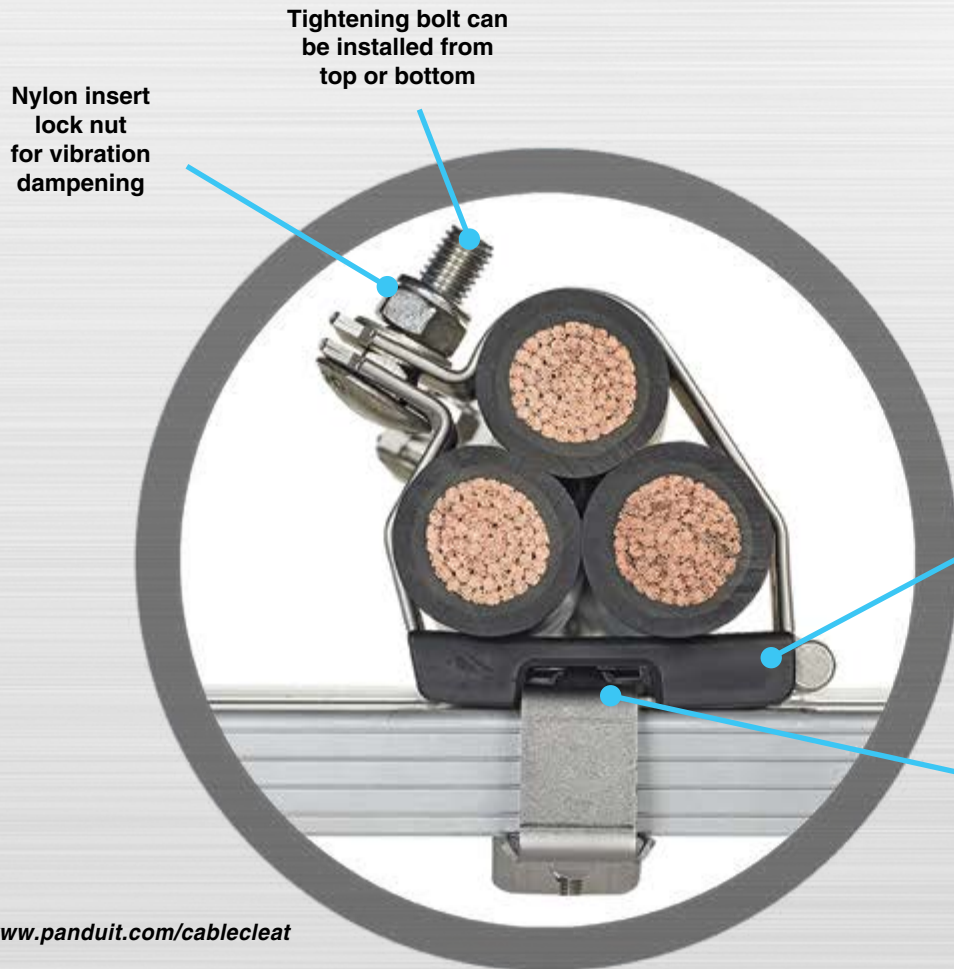
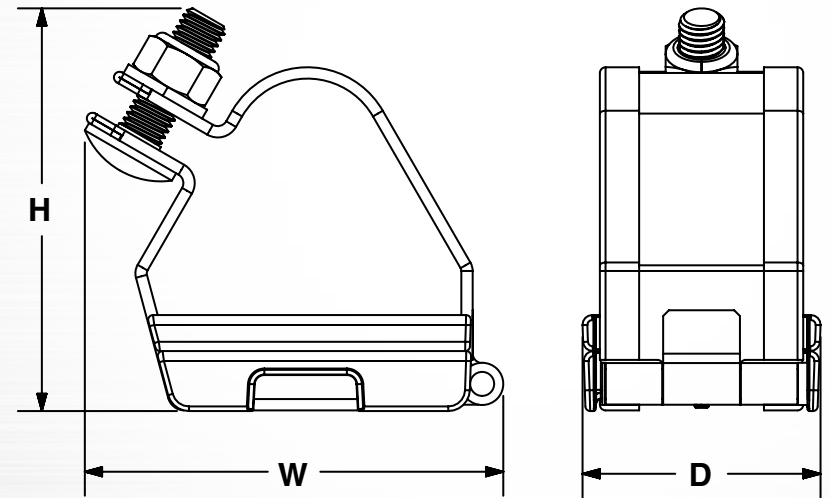

Part Number	Description	Cable Diameter Range		H		W		D		Weight		Mounting Holes
		In.	mm	In.	mm	In.	mm	In.	mm	Lb.	g	
CCSSTR2025-X	Cable cleat, stainless steel, trefoil configuration with a cable diameter of 20 - 25 mm.	0.79 - 0.98	20 - 25	3.43	87	3.39	86	2.48	63	0.92	417	1 X M8
CCSSTR2328-X	Cable cleat, stainless steel, trefoil configuration with a cable diameter of 23 - 28 mm.	0.91 - 1.10	23 - 28	3.58	91	3.54	90	2.48	63	0.97	439	1 X M8
CCSSTR2632-X	Cable cleat, stainless steel, trefoil configuration with a cable diameter of 26 - 32 mm.	1.02 - 1.26	26 - 32	3.74	95	3.82	97	2.48	63	1.06	480	1 X M8
CCSSTR3036-X	Cable cleat, stainless steel, trefoil configuration with a cable diameter of 30 - 36 mm.	1.18 - 1.42	30 - 36	3.94	100	4.13	105	2.48	63	1.14	518	1 X M8
CCSSTR3440-X	Cable cleat, stainless steel, trefoil configuration with a cable diameter of 34 - 40 mm.	1.34 - 1.58	34 - 40	4.25	108	4.37	111	2.48	63	1.21	547	1 X M8
CCSSTR3844-X	Cable cleat, stainless steel, trefoil configuration with a cable diameter of 38 - 44 mm.	1.50 - 1.73	38 - 44	4.25	108	4.69	119	2.48	63	1.28	581	1 X M8
CCSSTR4248-X	Cable cleat, stainless steel, trefoil configuration with a cable diameter of 42 - 48 mm.	1.65 - 1.89	42 - 48	4.41	112	4.96	126	2.48	63	1.35	613	1 X M8
CCSSTR4652-X	Cable cleat, stainless steel, trefoil configuration with a cable diameter of 46 - 52 mm.	1.81 - 2.05	46 - 52	4.61	117	5.24	133	2.48	63	1.43	647	1 X M8
CCSSTR5057-X	Cable cleat, stainless steel, trefoil configuration with a cable diameter of 50 - 57 mm.	1.97 - 2.24	50 - 57	4.84	123	5.63	143	2.48	63	1.51	686	1 X M8
CCSSTR5461-X	Cable cleat, stainless steel, trefoil configuration with a cable diameter of 54 - 61 mm.	2.13 - 2.40	54 - 61	5.12	130	5.91	150	2.48	63	1.59	720	1 X M8
CCSSTR5865-X	Cable cleat, stainless steel, trefoil configuration with a cable diameter of 58 - 65 mm.	2.28 - 2.56	58 - 65	5.43	138	6.18	157	2.48	63	1.66	754	1 X M8
CCSSTR6269-X	Cable cleat, stainless steel, trefoil configuration with a cable diameter of 62 - 69 mm.	2.44 - 2.72	62 - 69	5.71	145	6.50	165	2.48	63	1.72	782	1 X M8

Short Circuit Testing Summary¹

Trefoil Formation 38 mm Cable Diameter	Trefoil Formation 38 mm Cable Diameter	Trefoil Formation 35 mm Cable Diameter	Trefoil Formation 38 mm Cable Diameter
One Short Circuit Event (Clause 6.4.4) 300 mm spacing	Two Short Circuit Events (Clause 6.4.5) 300 mm spacing	One Short Circuit Event (Clause 6.4.4) 600 mm spacing	Two Short Circuit Events (Clause 6.4.5) 600 mm spacing
0.1 sec	0.1 sec	0.1 sec	0.1 sec
172 kA Peak	167 kA Peak	143 kA Peak	125 kA Peak
8926 lbs force (39.77 kN)	8415 lbs force (37.4 kN)	13398 lbs force (59.5 kN)	9429 lbs force (41.9 kN)

¹Test compliance to IEC 61914:2015 utilizing KEMA facility; Independent, ISO 17025 accredited testing, inspection, and certification services (IEEE, IEC, UL, and ANSI) for electric power equipment.

STAINLESS STEEL BUCKLE STRAP CLEAT



The **Stainless Steel Buckle Strap Cleat** is an effective option for protecting against high short circuit fault current requirements in harsh environments. The strap is made of 316L stainless steel, has inherent cable range-taking, and is compatible with quad, trefoil, and multicore cables.

The cleat is installed after running the cable via a unique in the industry mounting bracket. It is tensioned and cut using a manually-operated, ratchet-style installation tool or a tension screw drive installation tool. The straps have rounded edges to protect from damaging the cable and are often used in combination with a cushion sleeve inserted between the strap and cable for added protection.

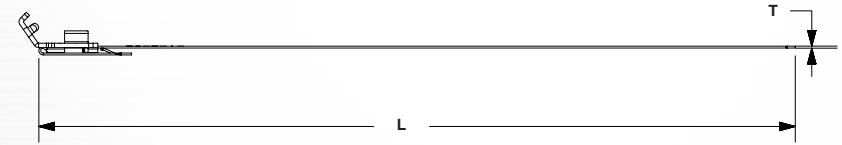
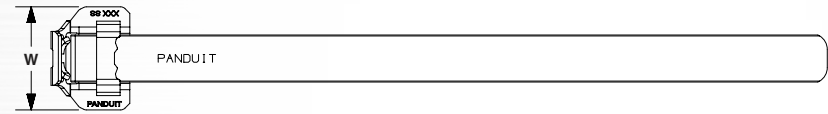

Buckle design provides low finished profile

Smooth surfaces and rounded edges reduce risk of cable insulation damage

Compatible with a variety of cable trays and cables

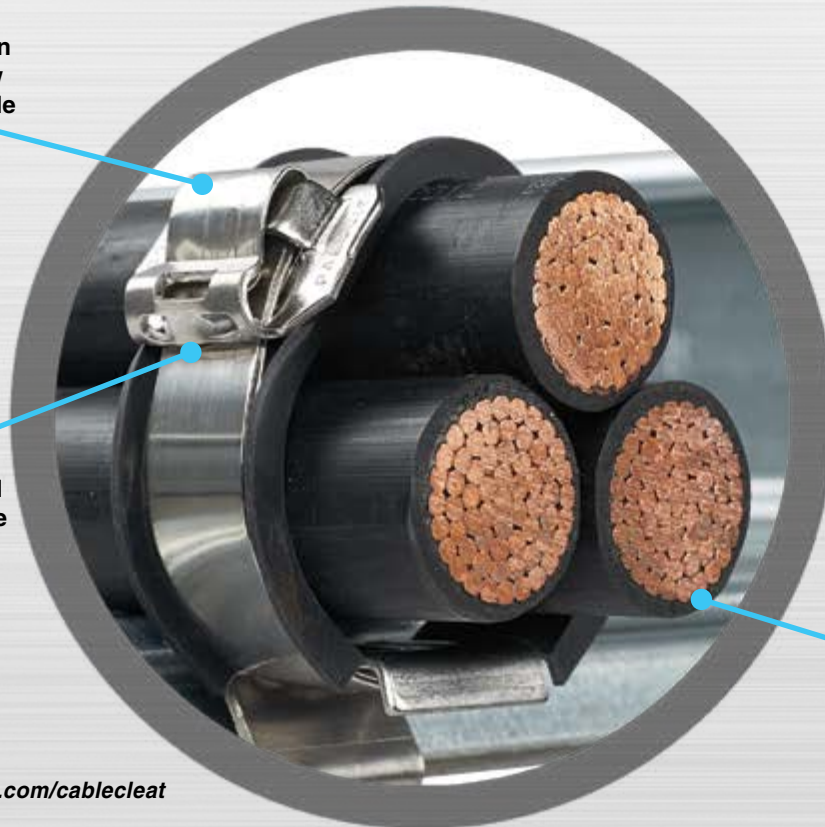

Part Number	Description	Trefoil Double Loop Cable Diameter Range				Trefoil Triple Loop Cable Diameter Range				Flat Multicore Double Loop Cable Diameter Range				Width		Thickness		Length		Std. Pkg. Qty.
		From		To		From		To		From		To								
		In.	mm	In.	mm	In.	mm	In.	mm	In.	mm	In.	mm	In.	mm	In.	mm	In.	mm	
MS4W75T30-Q6	Stainless steel buckle strap cleat.	0.472	12	0.787	20	-	-	-	-	0.472	12	1.772	45	0.75	19.1	0.03	0.76	19.6	498	25
MS6W75T30-Q6	Stainless steel buckle strap cleat.	0.787	20	1.181	30	0.472	12	0.787	20	1.772	45	2.756	70	0.75	19.1	0.03	0.76	25.9	658	25
MS8W75T30-Q6	Stainless steel buckle strap cleat.	1.181	30	1.654	42	0.787	20	1.024	26	2.756	70	3.740	95	0.75	19.1	0.03	0.76	32.1	815	25
MS10W75T30-Q6	Stainless steel buckle strap cleat.	1.654	42	2.283	58	1.024	26	1.378	35	3.740	95	4.724	120	0.75	19.1	0.03	0.76	38.4	975	25
MS12W75T30-Q6	Stainless steel buckle strap cleat.	2.283	58	2.835	72	1.378	35	1.732	44	4.724	120	5.906	150	0.75	19.1	0.03	0.76	44.7	1135	25
MS14W75T30-Q6	Stainless steel buckle strap cleat.	2.835	72	3.386	86	1.732	44	2.087	53	5.906	150	6.693	170	0.75	19.1	0.03	0.76	50.1	1273	25

Short Circuit Testing Summary¹

MS##W75T30-Q6 Double Loop Product			
Trefoil Formation 37 mm Cable Diameter	Trefoil Formation 38 mm Cable Diameter	Trefoil Formation 39 mm Cable Diameter	Trefoil Formation 39 mm Cable Diameter
One Short Circuit Event (Clause 6.4.4) 300 mm spacing	Two Short Circuit Events (Clause 6.4.5) 300 mm spacing	One Short Circuit Event (Clause 6.4.4) 600 mm spacing	Two Short Circuit Events (Clause 6.4.5) 600 mm spacing
153 kA	142 kA	109 kA	109 kA
7254 lbs force (32.3 kN)	6084 lbs force (27.1 kN)	6960 lbs force (31.0 kN)	6960 lbs force (31.0 kN)

MS##W75T30-Q6 Triple Loop Product	
Trefoil Formation 39 mm Cable Diameter	Trefoil Formation 39 mm Cable Diameter
One Short Circuit Event (Clause 6.4.4) 300 mm spacing	Two Short Circuit Events (Clause 6.4.5) 300 mm spacing
188 kA	188 kA
10391 lbs force (46.2 kN)	10391 lbs force (46.2 kN)

¹Test compliance to IEC 61914:2015 utilizing KEMA facility; Independent, ISO 17025 accredited testing, inspection, and certification services (IEEE, IEC, UL, and ANSI) for electric power equipment.

STAINLESS STEEL LOCKING STRAP CLEAT



The Stainless Steel Locking Strap Cleat is an effective option for protecting against lower to medium short circuit fault current requirements in harsh environments. The strap is made of 316L stainless steel, has inherent cable range-taking, and is compatible with quad, trefoil, and multicore cables.

The cleat is installed after running the cable via a unique in the industry mounting bracket. It is tensioned and cut using a battery-operated, electromechanical or manually-operated, ratchet-style installation tool. The straps have rounded edges to protect from damaging the cable and are often used in combination with a cushion sleeve inserted between the strap and cable for added protection.

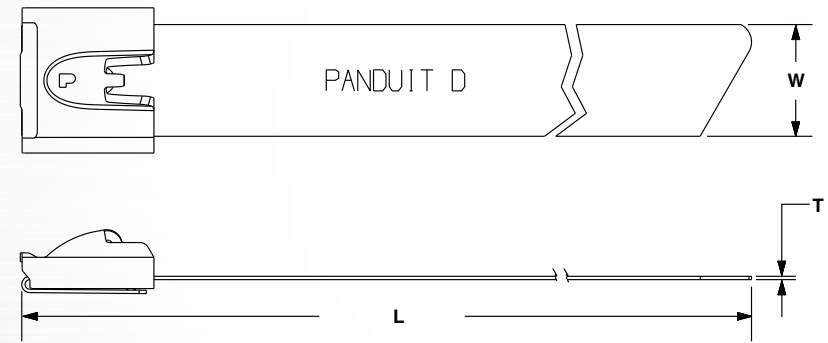

Cable tie cut off eliminates exposed sharp edges

Self-locking head for high-retained tension

Smooth surfaces and rounded edges reduce risk of cable insulation damage

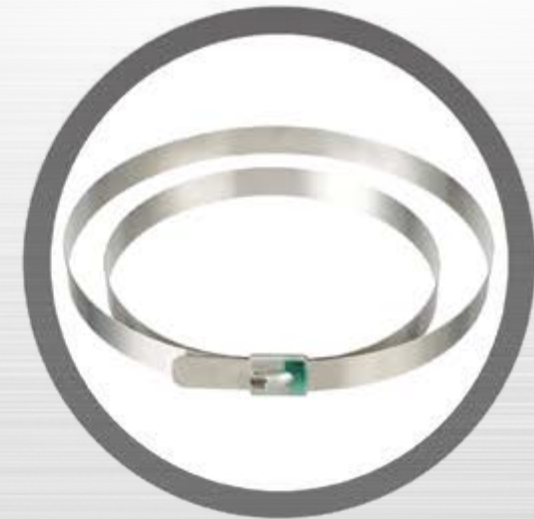
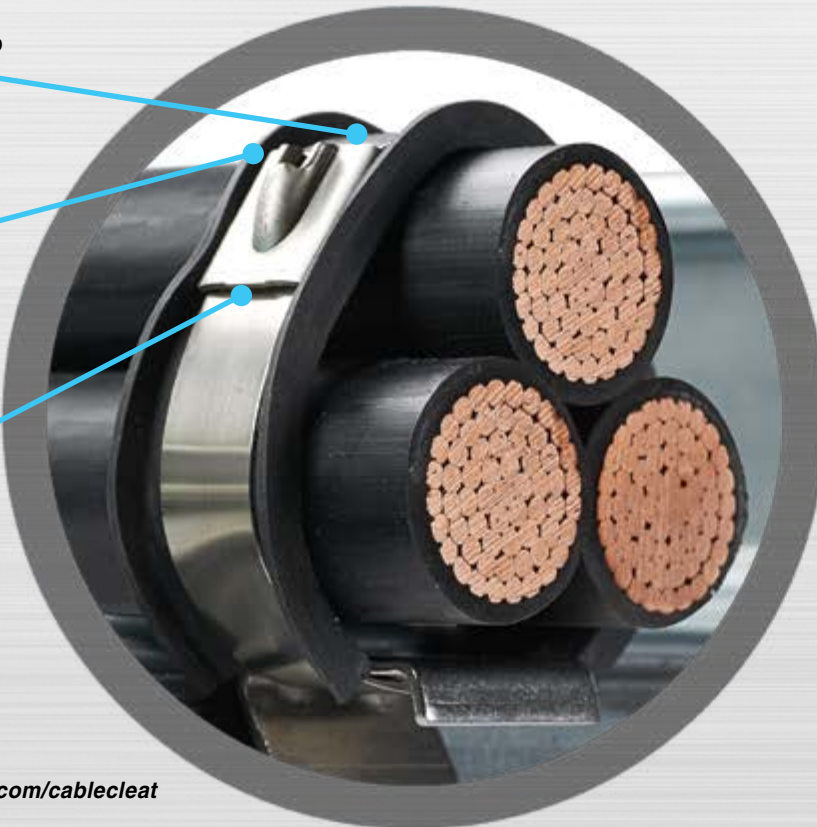

Part Number	Description	Trefoil Double Loop Cable Diameter Range				Flat Multicore Double Loop Cable Diameter Range				Width		Thickness		Length		Std Pkg. Qty.
		From		To		From		To								
		In.	mm	In.	mm	In.	mm	In.	mm	In.	mm	In.	mm			
MLT4DH-L316	Stainless steel locking strap cleat.	0.472	12	1.654	42	0.472	12	3.740	95	0.31	7.9	0.010	0.25	28.0	711	50
MLT4DH-L	Stainless steel locking strap cleat.	0.472	12	1.654	42	0.472	12	3.740	95	0.31	7.9	0.010	0.25	28.0	711	50
MLT4DEH15-Q316	Stainless steel locking strap cleat.	0.472	12	1.654	42	0.472	12	3.740	95	0.50	12.7	0.015	0.38	29.5	749	25
MLT4DSH-Q316	Stainless steel locking strap cleat.	0.472	12	1.654	42	0.472	12	3.740	95	0.63	15.9	0.015	0.38	29.5	749	25
MLT4DSH-Q	Stainless steel locking strap cleat.	0.472	12	1.654	42	0.472	12	3.740	95	0.63	15.9	0.015	0.38	29.5	749	25
MLT5DH-L316	Stainless steel locking strap cleat.	1.654	42	2.283	58	3.740	95	4.724	120	0.31	7.9	0.010	0.25	34.0	863	50
MLT6DEH15-Q316	Stainless steel locking strap cleat.	1.654	42	2.835	72	3.740	95	5.906	150	0.50	12.7	0.015	0.38	41.5	1054	25
MLT6DSH-Q316	Stainless steel locking strap cleat.	1.654	42	2.835	72	3.740	95	5.906	150	0.62	15.9	0.015	0.38	41.5	1054	25
MLT6DSH-Q	Stainless steel locking strap cleat.	1.654	42	2.835	72	3.740	95	5.906	150	0.62	15.9	0.015	0.38	41.5	1054	25
MLT6DH-L316	Stainless steel locking strap cleat.	2.283	58	2.835	72	4.724	120	5.906	150	0.31	7.9	0.010	0.25	40.0	1016	50
MLT8DEH15-Q316	Stainless steel locking strap cleat.	2.835	72	3.937	100	5.906	150	7.677	195	0.50	12.7	0.015	0.38	53.5	1359	25
MLT8DSH-Q316	Stainless steel locking strap cleat.	2.835	72	3.937	100	5.906	150	7.677	195	0.63	15.9	0.015	0.38	53.5	1359	25
MLT8DSH-Q	Stainless steel locking strap cleat.	2.835	72	3.937	100	5.906	150	7.677	195	0.63	15.9	0.015	0.38	53.5	1359	25

Short Circuit Testing Summary¹

MLT#DH-L316 Product			
Trefoil Formation 39 mm Cable Diameter	Trefoil Formation 39 mm Cable Diameter	Trefoil Formation 39 mm Cable Diameter	Trefoil Formation 39 mm Cable Diameter
One Short Circuit Event (Clause 6.4.4) 300 mm spacing	Two Short Circuit Events (Clause 6.4.5) 300 mm spacing	One Short Circuit Event (Clause 6.4.4) 600 mm spacing	Two Short Circuit Events (Clause 6.4.5) 600 mm spacing
47.0 kA	47.0 kA	42.2 kA	33.2 kA
649 lbs force (2.89 kN)	649 lbs force (2.89 kN)	1047 lbs force (4.66 kN)	648 lbs force (2.88 kN)
MLT#DSH-Q316 Product			
Trefoil Formation 38 mm Cable Diameter	Trefoil Formation 38 mm Cable Diameter	Trefoil Formation 39 mm Cable Diameter	Trefoil Formation 39 mm Cable Diameter
One Short Circuit Event (Clause 6.4.4) 300 mm spacing	One Short Circuit Event (Clause 6.4.4) 300 mm spacing	One Short Circuit Event (Clause 6.4.4) 600 mm spacing	Two Short Circuit Events (Clause 6.4.5) 600 mm spacing
75.1 kA	75.1 kA	60.4 kA	60.4 kA
1702 lbs force (7.57 kN)	1702 lbs force (7.57 kN)	2145 lbs force (9.45 kN)	2145 lbs force (9.45 kN)
MLT#DEH15-Q316 Product			
Trefoil Formation 38 mm Cable Diameter	—	Trefoil Formation 39 mm Cable Diameter	Trefoil Formation 39 mm Cable Diameter
One Short Circuit Event (Clause 6.4.4) 300 mm spacing	—	One Short Circuit Event (Clause 6.4.4) 600 mm spacing	Two Short Circuit Events (Clause 6.4.5) 600 mm spacing
56.1 kA	—	42.4 kA	35.7 kA
925 lbs force (4.11 kA)	—	1057 lbs force (4.70 kA)	749 lbs force (3.33 kA)

¹Test compliance to IEC 61914:2015 utilizing KEMA facility; Independent, ISO 17025 accredited testing, inspection, and certification services (IEEE, IEC, UL, and ANSI) for electric power equipment.

THE COMPLETE PANDUIT CABLE CLEAT TOOLS

The manually-operated **BT2HTI** and **BT75SDT** tools are used to install Panduit's Buckle Strap Cleats.

The **BT2HTI** is a ratchet-style installation tool, allowing for high tension with minimal effort.

The **BT75SDT** tensions the strap using a screw drive mechanism, providing high tension while reducing operator fatigue.

Both tools use a lever to cut the strap so there is an appropriate length remaining to fold over and secure with the buckle tab. A side entry slot allows for easy strap insertion, streamlining installation. The BT2HTI is more suitable for higher volume installations, and the BT75SDT for lower volume.



For use with
**Stainless Steel
Buckle Strap
Cleat**



BT2HTI

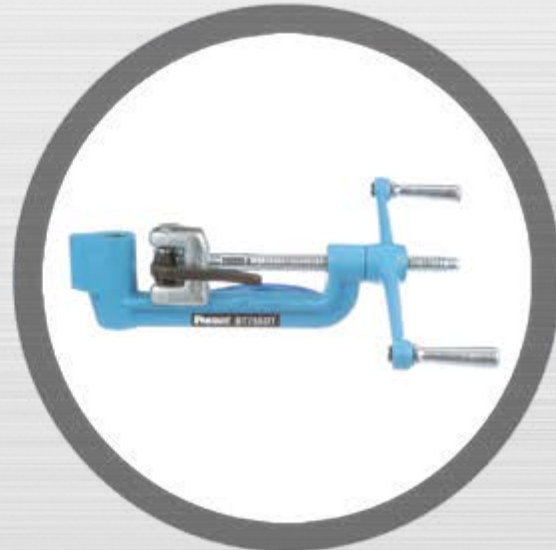

BT75SDT

Part Number	Description	Length		Width		Used With	Std Pkg. Qty.
		In.	mm	In.	mm		
BT2HTI	Installation tool for use with MS75 buckles.	6.94	176	7.64	194	Stainless Steel Buckle Strap Cleat	1
BT75SDT	Screw drive tension mechanism provides high tension with minimal effort, reducing operator fatigue; Heavy duty construction offers a longer service life; Strapping side entry allows quick side entry of the strap into tool to speed installation.	15	381	8	203	Stainless Steel Buckle Strap Cleat	1

THE COMPLETE PANDUIT CABLE CLEAT TOOLS

The battery-operated **PBTMT** and manually-operated, ratchet-style **RT2HT** tools are used to install Panduit's Locking Strap Cleats.

Both tools tension the strap through its locking head using a gripping tooth mechanism and then cut the end flush, eliminating any sharp edges.

A side entry slot allows for easy strap insertion, streamlining installation. The PBTMT is more suitable for higher volume installations, and the RT2HT for lower volume.



PBTMT/E



RT2HT

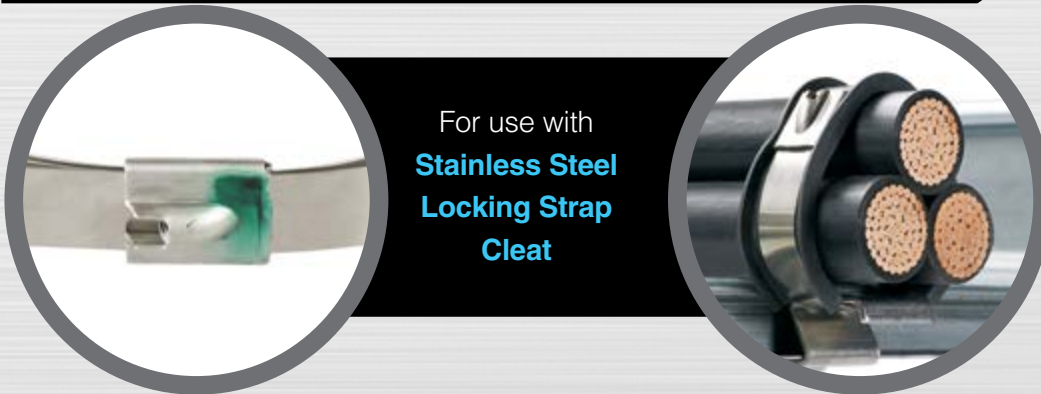

For use with
**Stainless Steel
Locking Strap
Cleat**

Part Number	Description	Length		Width		Used With	Std Pkg. Qty.
		In.	mm	In.	mm		
PBTMT/E	Battery powered installation tool, for use with Pan-Steel™ Heavy, Extra-heavy, and Super-Heavy, Cross Section MLT Style Ties, and MLTD Double Wrapped Style Ties, 2 –12 volt lithium-ion batteries and 115 volt, 60 Hz charger included.	10.33	262.4	3.17	80.5	Stainless Steel Locking Strap Cleat	1
RT2HT	Hand Operated Tool for use with Extra-Heavy and Super-Heavy Cross Section Pan-Steel™ Type MLT Ties.	7.1	180	4.05	103	Stainless Steel Locking Strap Cleat	1

PANDUIT MOUNTING BRACKETS AND CUSHION SLEEVE

Mounting Brackets for Easy Installation and Labor Savings

Install cable cleats after the cable is pulled with Panduit mounting brackets that affix to the cable tray and cleat after the cable is run in the tray.

CBH Series Brackets are compatible with the CCSSTR Series Stainless Steel Trefoil Cleats and CCALTR Series Aluminum Trefoil Cleats.

UC Series Brackets work in concert with Panduit's unique MLT Series Locking Strap Cleats and MS75 Series Buckle Strap Cleats.

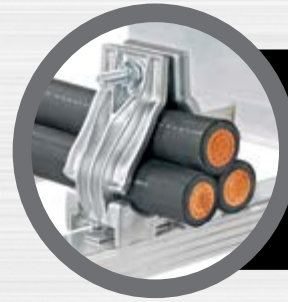

For use with
**Stainless
and Aluminum
Trefoil Cleats**

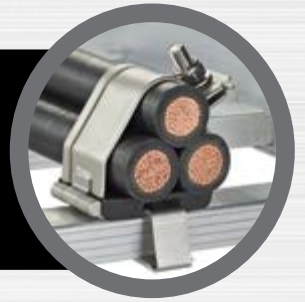

No loose pieces eliminates lost parts.

Mounting bracket eliminates the need to drill holes through rungs to secure cleats*

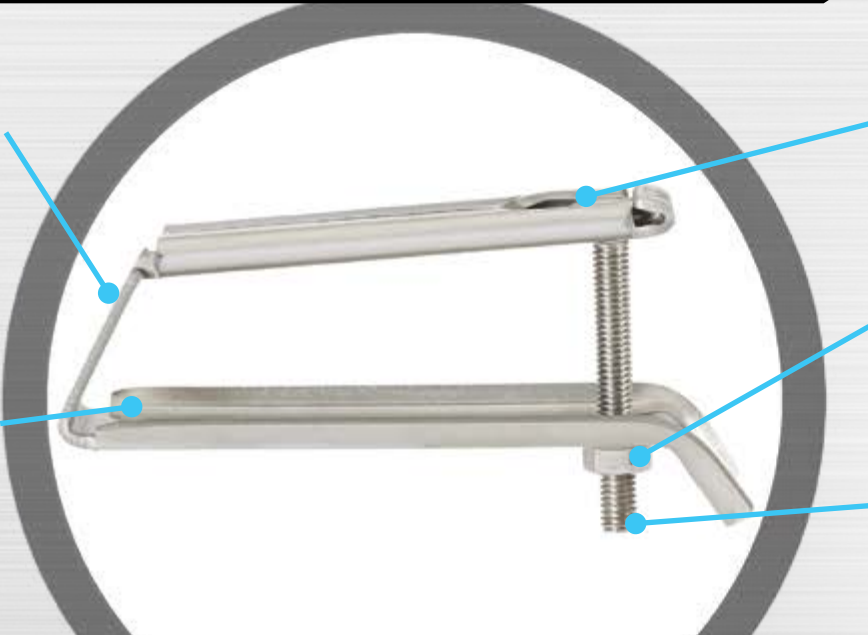

Capture slot for swing bolt provides added security

Peened nut prevents it from backing out completely off the screw

Easy-to-use swing bolt assembly

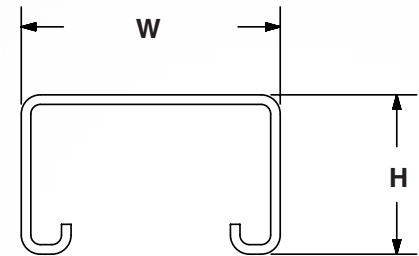

Part Number	Description	Rung Height		Rung Width		Part Weight	
		In.	mm	In.	mm	lb.	g
CBH15L50-V6	Cleat bracket, height 15 mm, length 50 mm, 316L stainless steel.	0.59	15	1.97	50	0.32	145
CBH20L50-V6	Cleat bracket, height 20 mm, length 50 mm, 316L stainless steel.	0.59 - 0.79	15 - 20	1.97	50	0.32	145
CBH25L50-V6	Cleat bracket, height 25 mm, length 50 mm, 316L stainless steel.	0.79 - 0.98	20 - 25	1.97	50	0.33	151
CBH30L50-V6	Cleat bracket, height 30 mm, length 50 mm, 316L stainless steel.	0.98 - 1.18	25 - 30	1.97	50	0.34	154

PANDUIT MOUNTING BRACKETS AND CUSHION SLEEVE

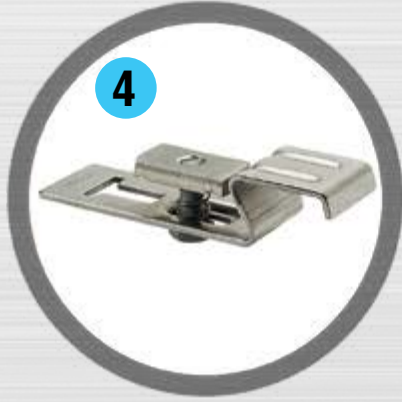

1 I-Beam Mounting Bracket*

3 Round Type Mounting Bracket*

2 Top Hat Mounting Bracket*

4 Strut Mounting Bracket*



For use with
Stainless
Steel Buckle
Strap Cleat



For use with
Stainless
Steel Locking
Strap Cleat

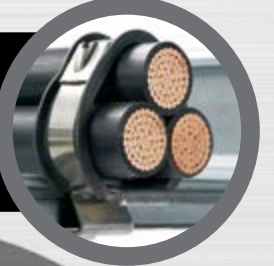

Available
in 100 ft.
(30.5 m) rolls

TPE low-smoke,
halogen-free,
and flame-
resistant

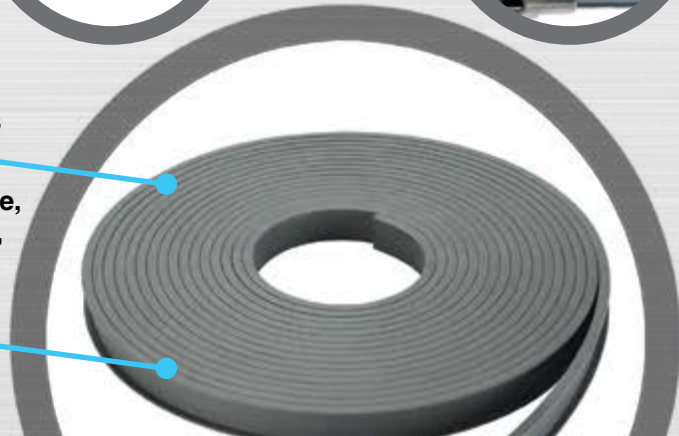

Part Number	Description	Std. Pkg. Qty.
UCSQ1-VC	Mounting bracket - Strut Type, galvanized steel.	5
UCRND1-VC	Mounting bracket - Round, galvanized steel.	5
UCIB1-VC	Mounting bracket - I-Beam, galvanized steel.	5
UCTH1-VC	Mounting bracket - Top Hat, galvanized steel.	5
UCFG1-V316	Mounting bracket - Use with composite fiberglass cable trays, 316L stainless steel.	5
UCSQ1-V316	Mounting bracket - Strut Type, 316L stainless steel.	5
UCRND1-V316	Mounting bracket - Round, 31L stainless steel.	5
UCIB1-V316	Mounting bracket - I-Beam, 316L stainless steel.	5
UCTH1-V316	Mounting bracket - Top Hat, 316L stainless steel.	5

Part Number	Description	Length		Width		Std Pkg. Qty.
		In.	mm	In.	mm	
PCSLSH-B-CR	Cushion sleeving used with locking strap cleats and buckle strap cleats.	100	30.5	1.05	26.8	1

Pkg. -CR = 100 ft. (30.5 m) reel.

*Available in 316L stainless steel and galvanized steel.

ALUMINUM TREFOIL CLEAT



The **Aluminum Trefoil Cable Cleat** is ideal for medium-high short circuit faults in less corrosive environments. It is available in multiple sizes with cable range-taking capability and is suitable for trefoil cable arrangements.

The cleat can be installed after running cable via a unique in the industry mounting bracket or before running cable through it by installing direct to the cable tray rung via a fixing hole and M8 bolt. Insulating spacers and washers are available to protect against galvanic corrosion between dissimilar cable tray rung and cable cleat materials.

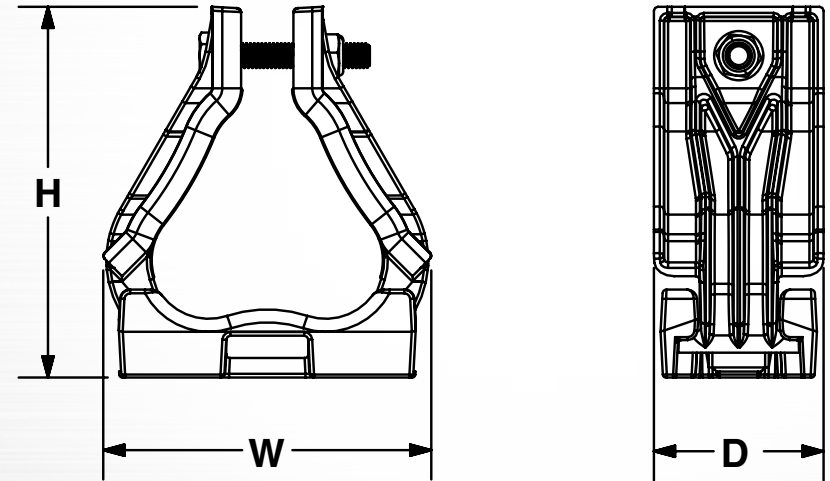

Nylon insert lock nut for vibration dampening

Rounded edges for cable protection

Installation before or after cable is run via fixing bolt or mounting bracket

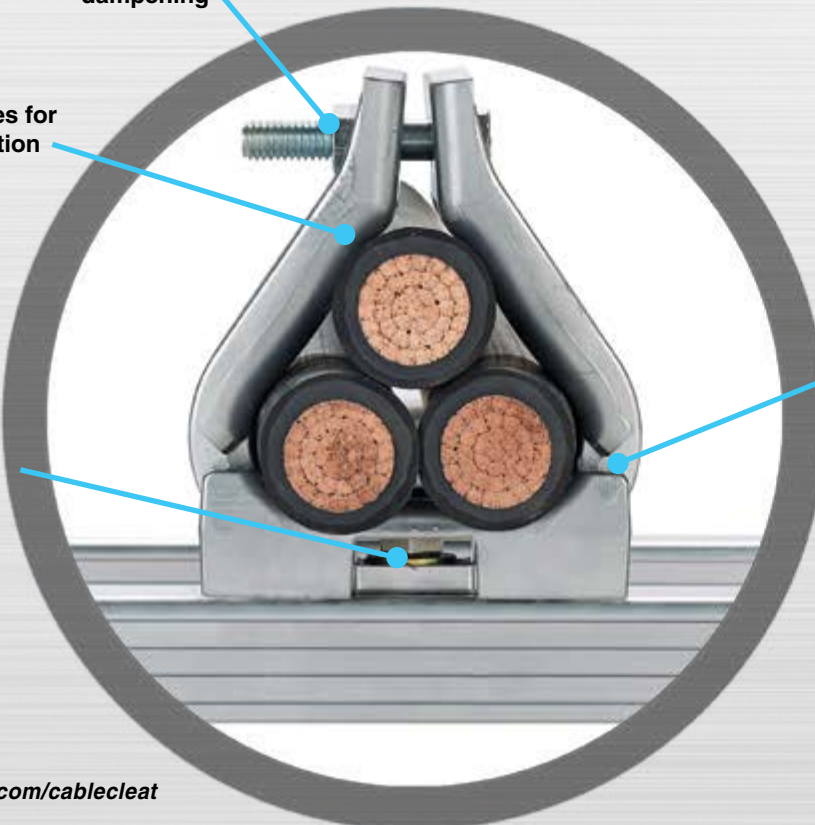

Hinged for cable range-taking



Part Number	Description	Cable Diameter Range		H		W		D		Weight		Mounting Holes
		In.	mm	In.	mm	In.	mm	In.	mm	Lb.	g	
CCALTR2326-X	Cable cleat, aluminum, trefoil configuration with a cable diameter of 23 - 26 mm.	0.91 - 1.02	23 - 26	3.92	100	3.98	101	2.17	55	0.81	370	1 x M8
CCALTR2528-X	Cable cleat, aluminum, trefoil configuration with a cable diameter of 25 - 28 mm.	0.98 - 1.10	25 - 28	4.06	103	4.15	105	2.17	55	0.85	385	1 x M8
CCALTR2730-X	Cable cleat, aluminum, trefoil configuration with a cable diameter of 27 - 30 mm.	1.06 - 1.18	27 - 30	4.19	107	3.86	98	2.17	55	0.85	388	1 x M8
CCALTR2932-X	Cable cleat, aluminum, trefoil configuration with a cable diameter of 29 - 32 mm.	1.14 - 1.26	29 - 32	4.33	110	3.87	98	2.17	55	0.87	397	1 x M8
CCALTR3135-X	Cable cleat, aluminum, trefoil configuration with a cable diameter of 31 - 35 mm.	1.22 - 1.38	31 - 35	4.55	116	3.96	101	2.17	55	0.92	418	1 x M8
CCALTR3438-X	Cable cleat, aluminum, trefoil configuration with a cable diameter of 34 - 38 mm.	1.34 - 1.50	34 - 38	4.77	121	4.18	106	2.17	55	0.93	424	1 x M8
CCALTR3741-X	Cable cleat, aluminum, trefoil configuration with a cable diameter of 37 - 41 mm.	1.46 - 1.61	37 - 41	4.99	127	4.41	112	2.17	55	0.98	448	1 x M8
CCALTR4044-X	Cable cleat, aluminum, trefoil configuration with a cable diameter of 40 - 44 mm.	1.57 - 1.73	40 - 44	5.24	133	4.63	118	2.17	55	1.05	477	1 x M8
CCALTR4347-X	Cable cleat, aluminum, trefoil configuration with a cable diameter of 43 - 47 mm.	1.69 - 1.85	43 - 47	5.52	140	4.85	123	2.17	55	1.14	516	1 x M8
CCALTR4651-X	Cable cleat, aluminum, trefoil configuration with a cable diameter of 46 - 51 mm.	1.81 - 2.01	46 - 51	5.83	148	5.05	128	2.17	55	1.23	558	1 x M8
CCALTR5056-X	Cable cleat, aluminum, trefoil configuration with a cable diameter of 50 - 56 mm.	1.97 - 2.20	50 - 56	6.20	158	5.50	140	2.17	55	1.32	602	1 x M8
CCALTR5561-X	Cable cleat, aluminum, trefoil configuration with a cable diameter of 55 - 61 mm.	2.17 - 2.40	55 - 61	6.57	167	5.72	145	2.17	55	1.42	647	1 x M8
CCALTR6067-X	Cable cleat, aluminum, trefoil configuration with a cable diameter of 60 - 67 mm.	2.36 - 2.64	60 - 67	7.01	178	6.15	156	2.17	55	1.55	706	1 x M8
CCALTR6675-X	Cable cleat, aluminum, trefoil configuration with a cable diameter of 66 - 75 mm.	2.60 - 2.95	66 - 75	7.93	193	6.72	171	2.17	55	1.73	787	1 x M8

Short Circuit Testing Summary¹

Trefoil Formation 38 mm Cable Diameter	Trefoil Formation 38 mm Cable Diameter	Trefoil Formation 35 mm Cable Diameter	Trefoil Formation 38 mm Cable Diameter
One Short Circuit Event (Clause 6.4.4) 300 mm spacing	Two Short Circuit Events (Clause 6.4.5) 300 mm spacing	One Short Circuit Event (Clause 6.4.4) 600 mm spacing	Two Short Circuit Events (Clause 6.4.5) 600 mm spacing
114 kA	109 kA	94.6 kA	94.6 kA
3921 lbs force (17.4 kN)	3585 lbs force (15.9 kN)	5401 lbs force (24.0 kN)	5401 lbs force (24.0 kN)

¹Test compliance to IEC 61914:2015 utilizing KEMA facility; Independent, ISO 17025 accredited testing, inspection, and certification services (IEEE, IEC, UL, and ANSI) for electric power equipment.

ALUMINUM TWO-HOLE CLEAT



The **Aluminum Two-Hole Cleat** is ideal for medium-high short circuit faults in less corrosive environments. It is available in multiple sizes with cable range-taking capability and is suitable for single conductor cables.

The cleat is installed after running cable by installing direct to the cable tray rung via fixing holes and two M10 bolts. Insulating spacers and washers are available to protect against galvanic corrosion in case of dissimilar cable tray rung and cable cleat materials.

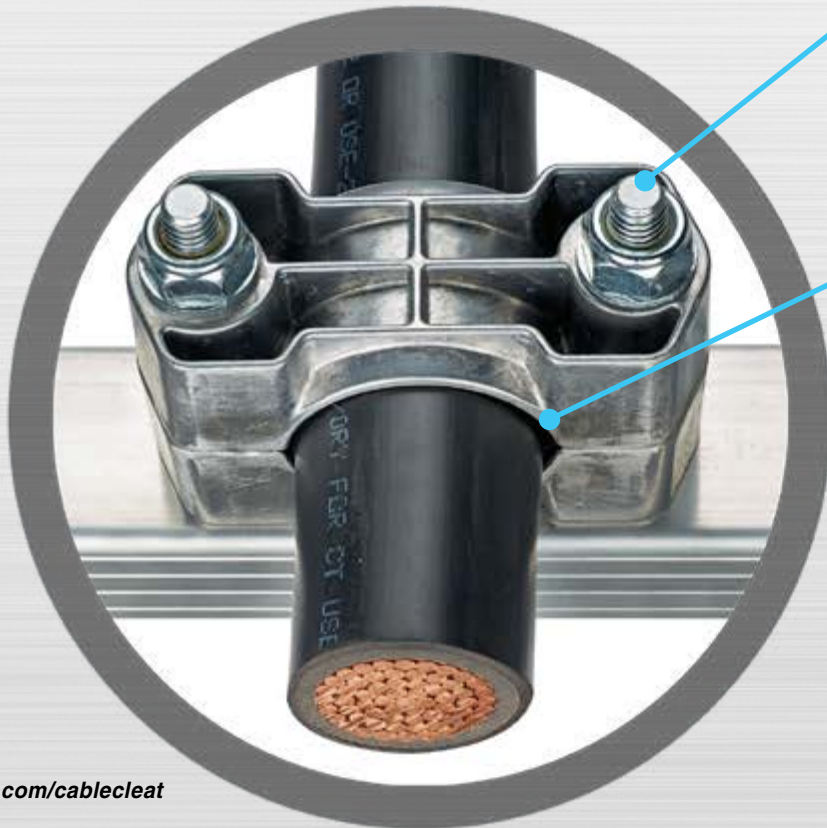
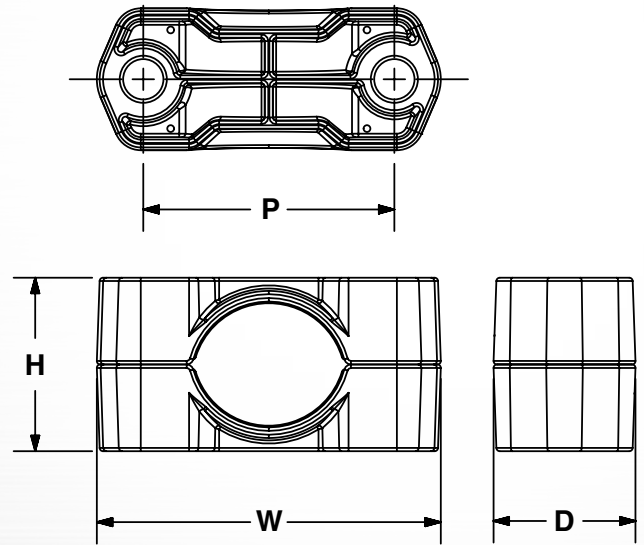

Tightening bolts can be installed from top or bottom

Rounded edges for cable protection

Ridges to hold cable in place

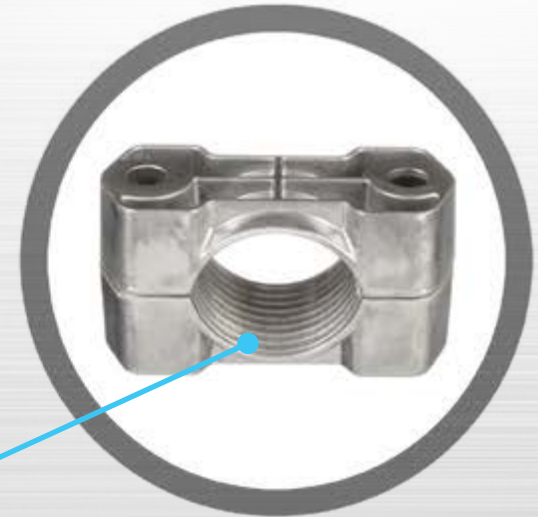

Part Number	Description	Cable Diameter Range		H		W		D		F		Weight		Mounting Holes
		In.	mm	In.	mm	In.	mm	In.	mm	In.	mm	Lb.	g	
CCAL2H3846-X	Cable cleat, aluminum, two-hole configuration with a cable diameter of 38 - 46 mm.	1.50 - 1.81	38 - 46	2.01	51	3.98	101	1.64	42	2.91	74	0.50	226	2 x M10
CCAL2H4658-X	Cable cleat, aluminum, two-hole configuration with a cable diameter of 46 - 58 mm.	1.81 - 2.28	46 - 58	2.36	60	4.52	115	1.69	43	3.39	86	0.64	291	2 x M10
CCAL2H5870-X	Cable cleat, aluminum, two-hole configuration with a cable diameter of 58 - 70 mm.	2.28 - 2.76	58 - 70	2.87	73	5.18	132	1.75	45	3.96	101	0.89	404	2 x M10
CCAL2H7083-X	Cable cleat, aluminum, two-hole configuration with a cable diameter of 70 - 83 mm.	2.76 - 3.27	70 - 83	3.39	86	5.71	145	1.81	46	4.47	114	1.09	496	2 x M10
CCAL2H8397-X	Cable cleat, aluminum, two-hole configuration with a cable diameter of 83 - 97 mm.	3.27 - 3.82	83 - 97	3.94	100	6.36	162	1.87	47	5.06	129	1.39	630	2 x M10
CCAL2H97109-X	Cable cleat, aluminum, two-hole configuration with a cable diameter of 97 - 109 mm.	3.82 - 4.29	97 - 109	4.53	115	6.87	175	1.93	49	5.55	141	1.66	754	2 x M10
CCAL2H109120-X	Cable cleat, aluminum, two-hole configuration with a cable diameter of 109 - 120 mm.	4.29 - 4.72	109 - 120	5.04	128	7.33	186	1.98	50	5.99	152	1.92	873	2 x M10

Short Circuit Testing Summary¹

Flat Formation 105 mm Cable Spacing	Flat Formation 105 mm Cable Spacing
One Short Circuit Event (Clause 6.4.4) 600 mm spacing	Two Short Circuit Events (Clause 6.4.5) 600 mm spacing
131 kA	131 kA
3748 lbs force (16.7 kN)	3748 lbs force (16.7 kN)

¹Test compliance to IEC 61914:2015 utilizing KEMA facility; Independent, ISO 17025 accredited testing, inspection, and certification services (IEEE, IEC, UL, and ANSI) for electric power equipment.

ALUMINUM ONE-HOLE CLEAT



The **Aluminum One-Hole Cleat** is ideal for lower to medium short circuit faults in less corrosive environments. It is available in multiple sizes with cable range-taking capability and is suitable for single conductor cables.

The cleat is installed after running cable by installing direct to the cable tray rung via a fixing hole and M10 bolt. Insulating spacers and washers are available to protect against galvanic corrosion in case of dissimilar cable tray rung and cable cleat materials.

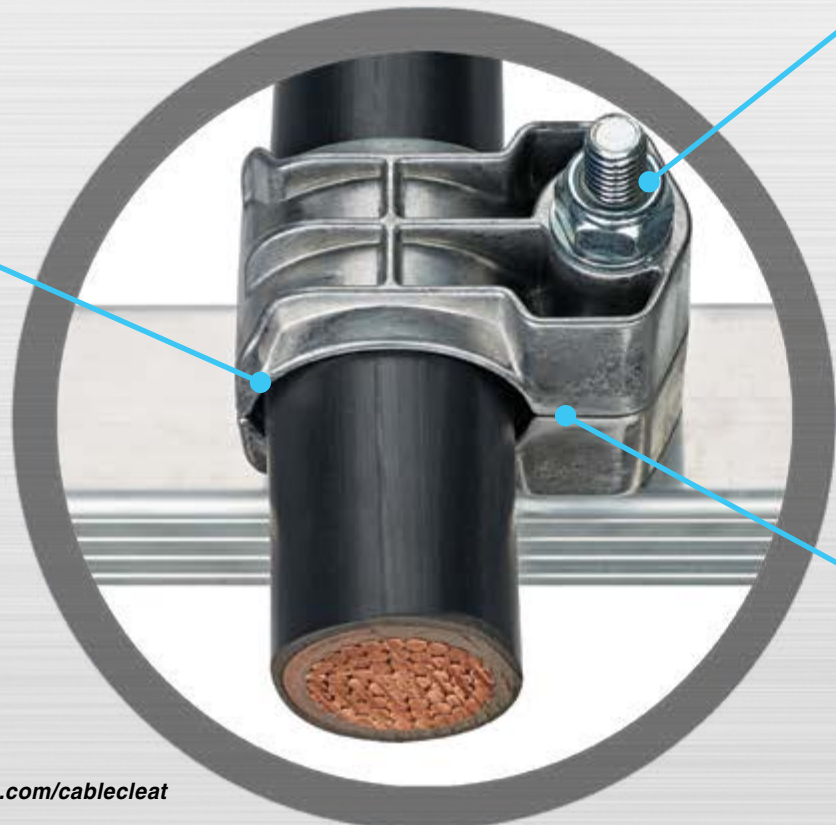
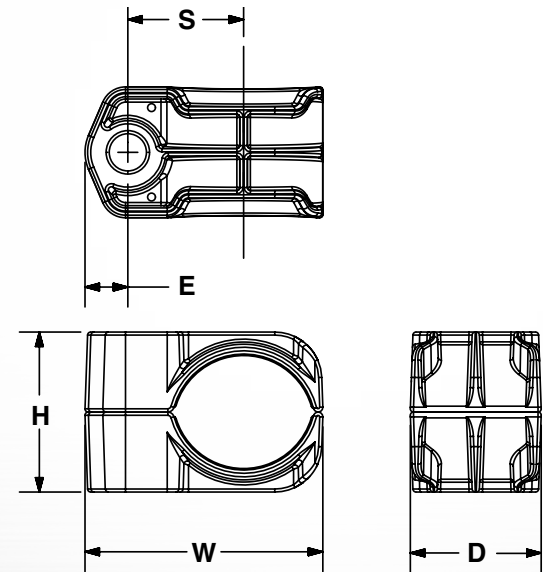

Rounded edges for cable protection

Tightening bolt can be installed from top or bottom

Ridges to hold cable in place

Interlock feature prevents rotation between top and bottom pieces

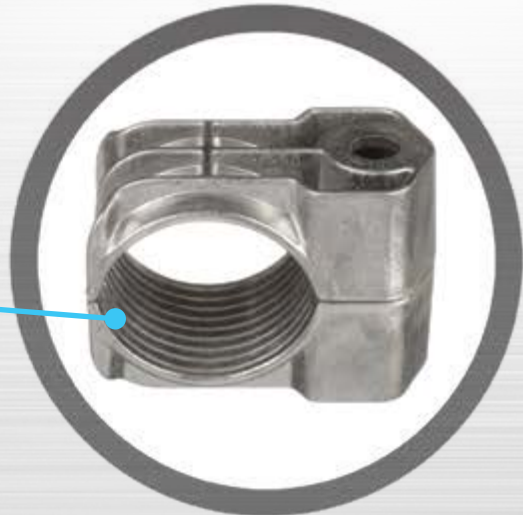

Part Number	Description	Cable Diameter Range		H		W		D		E		S		Weight		Mounting Holes
		In.	mm	In.	mm	In.	mm	In.	mm	In.	mm	In.	mm	Lb.	g	
CCAL1H1013-X	Cable cleat, aluminum, one-hole configuration with a cable diameter of 10 - 13 mm.	0.39 - 0.51	10 - 13	0.91	23	1.59	40	1.60	41	0.48	12	0.77	20	0.11	50	1 x M10
CCAL1H1316-X	Cable cleat, aluminum, one-hole configuration with a cable diameter of 13 - 16 mm.	0.51 - 0.63	13 - 16	1.02	26	1.72	44	1.61	41	0.48	12	0.83	21	0.13	59	1 x M10
CCAL1H1619-X	Cable cleat, aluminum, one-hole configuration with a cable diameter of 16 - 19 mm.	0.63 - 0.75	16 - 19	1.14	29	1.88	48	1.61	41	0.50	13	0.91	23	0.15	68	1 x M10
CCAL1H1923-X	Cable cleat, aluminum, one-hole configuration with a cable diameter of 19 - 23 mm.	0.75 - 0.91	19 - 23	1.26	32	2.04	52	1.61	41	0.50	13	0.99	25	0.17	77	1 x M10
CCAL1H2327-X	Cable cleat, aluminum, one-hole configuration with a cable diameter of 23 - 27 mm.	0.91 - 1.06	23 - 27	1.42	36	2.28	58	1.62	41	0.51	13	1.07	27	0.20	89	1 x M10
CCAL1H2732-X	Cable cleat, aluminum, one-hole configuration with a cable diameter of 27 - 32 mm.	1.06 - 1.26	27 - 32	1.57	40	2.44	62	1.63	41	0.53	14	1.19	30	0.24	107	1 x M10
CCAL1H3238-X	Cable cleat, aluminum, one-hole configuration with a cable diameter of 32 - 38 mm.	1.26 - 1.50	32 - 38	1.77	45	2.68	68	1.63	42	0.53	14	1.30	33	0.27	125	1 x M10
CCAL1H3846-X	Cable cleat, aluminum, one-hole configuration with a cable diameter of 38 - 46 mm.	1.50 - 1.81	38 - 46	2.01	51	2.98	76	1.64	42	0.54	14	1.45	37	0.33	149	1 x M10
CCAL1H4651-X	Cable cleat, aluminum, one-hole configuration with a cable diameter of 46 - 51 mm.	1.81 - 2.01	46 - 51	2.36	60	3.25	83	1.65	42	0.56	14	1.58	40	0.40	181	1 x M10
CCAL1H5157-X	Cable cleat, aluminum, one-hole configuration with a cable diameter of 51 - 57 mm.	2.01 - 2.24	51 - 57	2.56	65	3.49	89	1.66	42	0.57	14	1.70	43	0.44	202	1 x M10

Short Circuit Testing Summary¹

Flat Formation 105 mm Cable Spacing	Flat Formation 105 mm Cable Spacing
One Short Circuit Event (Clause 6.4.4) 600 mm spacing	Two Short Circuit Events (Clause 6.4.5) 600 mm spacing
93.4 kA	93.4 kA
1904 lbs force (8.47 kN)	1904 lbs force (8.47 kN)

¹Test compliance to IEC 61914:2015 utilizing KEMA facility; Independent, ISO 17025 accredited testing, inspection, and certification services (IEEE, IEC, UL, and ANSI) for electric power equipment.

POLYMER TREFOIL CLEAT



The **Polymer Trefoil Cleat** is ideal for medium-high short circuit faults in less harsh environments. It is available in multiple sizes with cable range-taking capability and is suitable for trefoil cable arrangements.

The cleat is installed after running cable by installing direct to the cable tray rung via a fixing hole and M10 bolt.

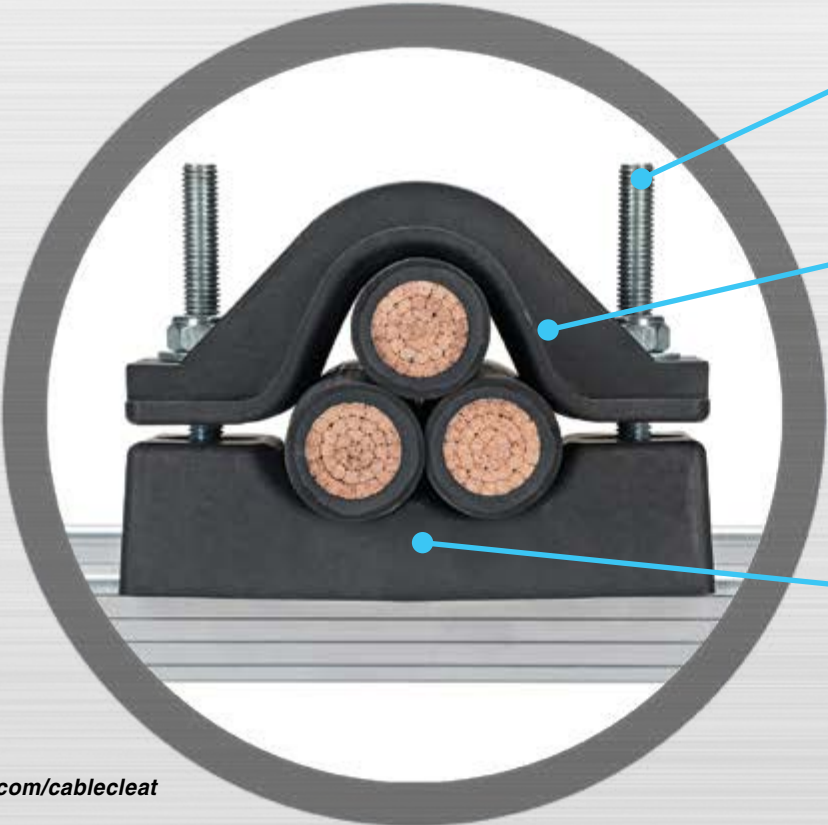
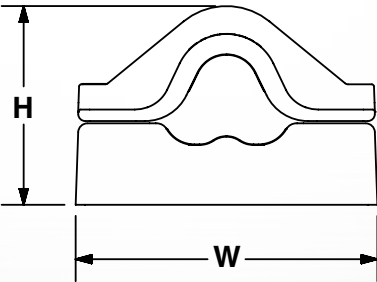
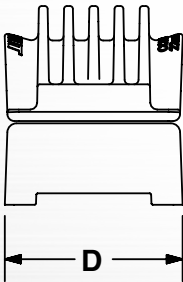
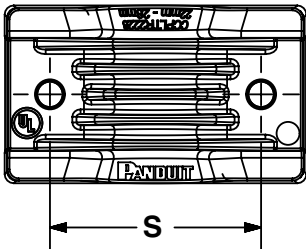

Dual bolt installation

Rounded edges for cable protection

Ridges to hold cable in place

Corrosion resistant body

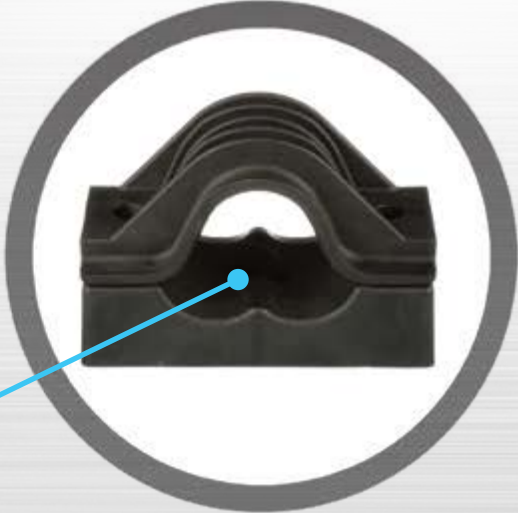

Part Number	Description	Cable Diameter Range		H		W		D		S		Weight		Mounting Holes
		In.	mm	In.	mm	In.	mm	In.	mm	In.	mm	Lb.	g	
CCPLTR2228-X	Cable cleat, polymer, trefoil configuration with a cable diameter of 22 - 28 mm.	0.87 - 1.10	22 - 28	3.46	88	5.20	132	3.07	78	3.62	92	1.29	585	1 X M10, 2 X M10
CCPLTR2633-X	Cable cleat, polymer, trefoil configuration with a cable diameter of 26 - 33 mm.	1.02 - 1.30	26 - 33	3.86	98	5.59	142	3.07	78	4.02	102	1.39	630	1 X M10, 2 X M10
CCPLTR3139-X	Cable cleat, polymer, trefoil configuration with a cable diameter of 31 - 39 mm.	1.22 - 1.54	31 - 39	4.13	105	6.06	154	3.07	78	4.49	114	1.51	685	1 X M10, 2 X M10
CCPLTR3745-X	Cable cleat, polymer, trefoil configuration with a cable diameter of 37 - 45 mm.	1.46 - 1.77	37 - 45	4.61	117	6.54	166	3.07	78	4.96	126	1.64	745	1 X M10, 2 X M10
CCPLTR4352-X	Cable cleat, polymer, trefoil configuration with a cable diameter of 43 - 52 mm.	1.69 - 2.05	43 - 52	5.04	128	7.09	180	3.07	78	5.51	140	1.80	815	1 X M10, 2 X M10
CCPLTR5060-X	Cable cleat, polymer, trefoil configuration with a cable diameter of 50 - 60 mm.	1.97 - 2.36	50 - 60	5.55	141	7.76	197	3.07	78	6.14	156	1.97	895	1 X M10, 2 X M10

Short Circuit Testing Summary¹

Trefoil Formation 38 mm Cable Diameter	Trefoil Formation 38 mm Cable Diameter	Flat Formation 38 mm Cable Diameter	Flat Formation 38 mm Cable Diameter
One Short Circuit Event (Clause 6.4.4) 300 mm spacing	Two Short Circuit Events (Clause 6.4.5) 300 mm spacing	One Short Circuit Event (Clause 6.4.4) 600 mm spacing	Two Short Circuit Events (Clause 6.4.5) 600 mm spacing
136 kA	130 kA	109 kA	109 kA
5581 lbs force (24.8 kN)	5099 lbs force (22.7 kN)	7170 lbs force (31.0 kN)	7170 lbs force (31.0 kN)

¹Test compliance to IEC 61914:2015 utilizing KEMA facility; Independent, ISO 17025 accredited testing, inspection, and certification services (IEEE, IEC, UL, and ANSI) for electric power equipment.

POLYMER TWO-HOLE CLEAT



The **Polymer Two-Hole Cleat** is ideal for lower to medium short circuit faults in less harsh environments. It is available in multiple sizes with cable range-taking capability and is suitable for single conductor cable arrangements.

The cleat is installed after running cable by installing direct to the cable tray rung via fixing holes and two M10 bolts.

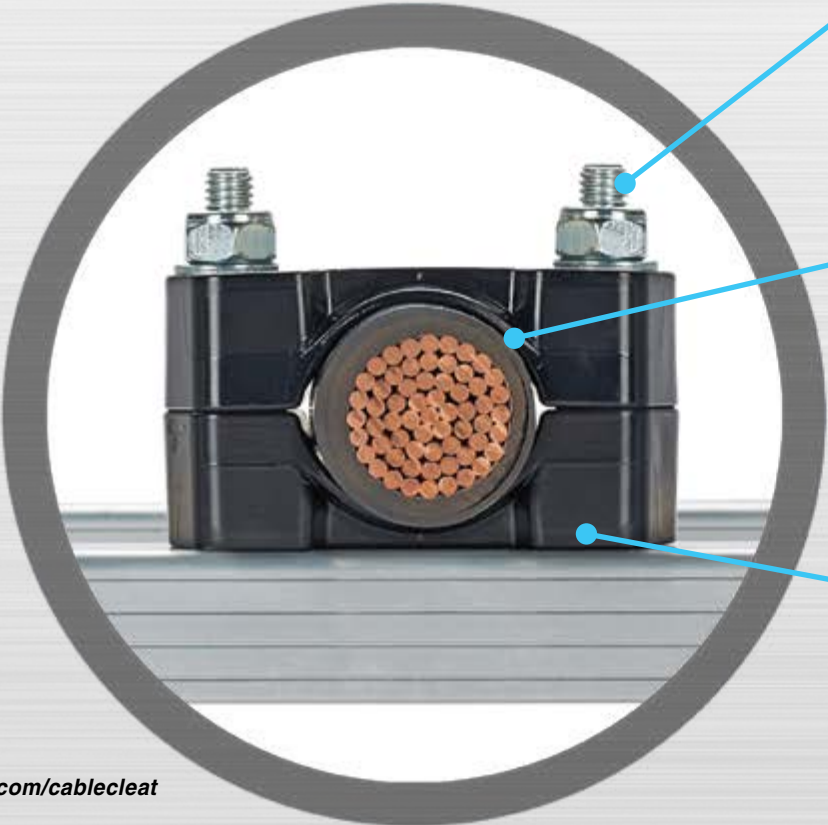
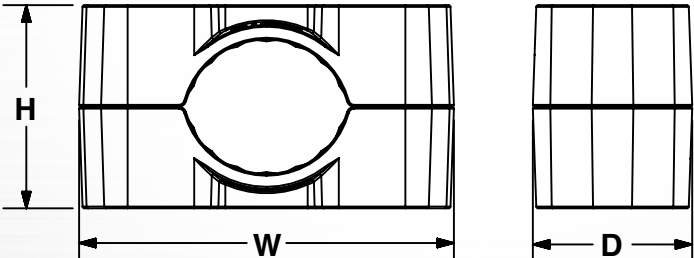
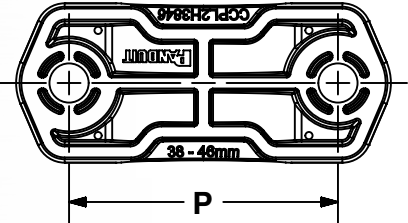

Dual bolt installation

Rounded edges for cable protection

Ridges to hold cable in place

Corrosion resistant body



Part Number	Description	Cable Diameter Range		H		W		D		P		Weight		Mounting Holes
		In.	mm	In.	mm	In.	mm	In.	mm	In.	mm	Lb.	g	
CCPL2H3846-X	Cable cleat, polymer, two-hole configuration with a cable diameter of 38 - 46 mm.	1.50 - 1.81	38 - 46	2.20	56	4.07	103	1.73	44	2.92	74	0.31	143	2 x M10
CCPL2H4658-X	Cable cleat, polymer, two-hole configuration with a cable diameter of 46 - 58 mm.	1.81 - 2.28	46 - 58	2.56	65	4.53	115	1.74	44	3.37	86	0.38	175	2 x M10
CCPL2H5870-X	Cable cleat, polymer, two-hole configuration with a cable diameter of 58 - 70 mm.	2.28 - 2.76	58 - 70	3.07	78	5.04	128	1.76	45	3.85	98	0.48	220	2 x M10
CCPL2H7083-X	Cable cleat, polymer, two-hole configuration with a cable diameter of 70 - 83 mm.	2.76 - 3.27	70 - 83	3.19	81	5.56	141	1.85	47	4.36	111	0.60	273	2 x M10
CCPL2H8397-X	Cable cleat, polymer, two-hole configuration with a cable diameter of 83 - 97 mm.	3.27 - 3.82	83 - 97	4.13	105	6.13	156	1.95	50	4.91	125	0.74	335	2 x M10
CCPL2H97109-X	Cable cleat, polymer, two-hole configuration with a cable diameter of 97 - 109 mm.	3.82 - 4.29	97 - 109	4.72	120	6.64	169	2.06	50	5.40	137	0.88	402	2 x M10
CCPL2H109120-X	Cable cleat, polymer, two-hole configuration with a cable diameter of 109 - 120 mm.	4.29 - 4.72	109 - 120	5.24	133	7.10	180	2.09	53	5.84	148	1.01	460	2 x M10
CCPL2H120135-X	Cable cleat, polymer, two-hole configuration with a cable diameter of 120 - 135 mm.	4.72 - 5.31	120 - 135	5.71	145	7.69	195	2.17	55	6.42	163	1.17	533	2 x M10
CCPL2H135150-X	Cable cleat, polymer, two-hole configuration with a cable diameter of 135 - 150 mm.	5.31 - 5.91	135 - 150	6.34	161	8.31	211	2.19	56	7.01	178	1.35	615	2 x M10
CCPL2H150165-X	Cable cleat, polymer, two-hole configuration with a cable diameter of 150 - 165 mm.	5.91 - 6.50	150 - 165	6.97	177	8.92	227	2.29	58	7.61	193	1.57	712	2 x M10

Short Circuit Testing Summary¹

Flat Formation 105 mm Cable Spacing	Flat Formation 105 mm Cable Spacing
One Short Circuit Event (Clause 6.4.4) 600 mm spacing	Two Short Circuit Events (Clause 6.4.5) 600 mm spacing
85.4 kA	85.4 kA
1593 lbs force (7.09 kN)	1593 lbs force (7.09 kN)

¹Test compliance to IEC 61914:2015 utilizing KEMA facility; Independent, ISO 17025 accredited testing, inspection, and certification services (IEEE, IEC, UL, and ANSI) for electric power equipment.

POLYMER ONE-HOLE CLEAT



The **Polymer One-Hole Cleat** is ideal for lower to medium short circuit faults in less harsh environments. It is available in multiple sizes with cable range-taking capability and is suitable for single conductor cable arrangements.

The cleat is installed after running cable by installing direct to the cable tray rung via a fixing hole and M10 bolt.

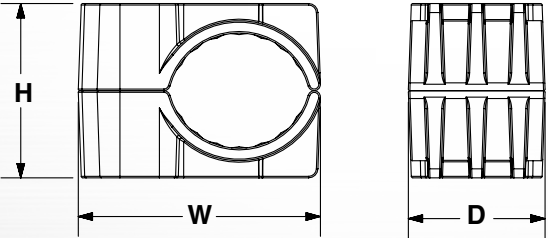
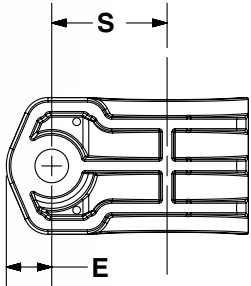

Single bolt installation

Interlock feature prevents rotation between top and bottom pieces

Corrosion resistant body

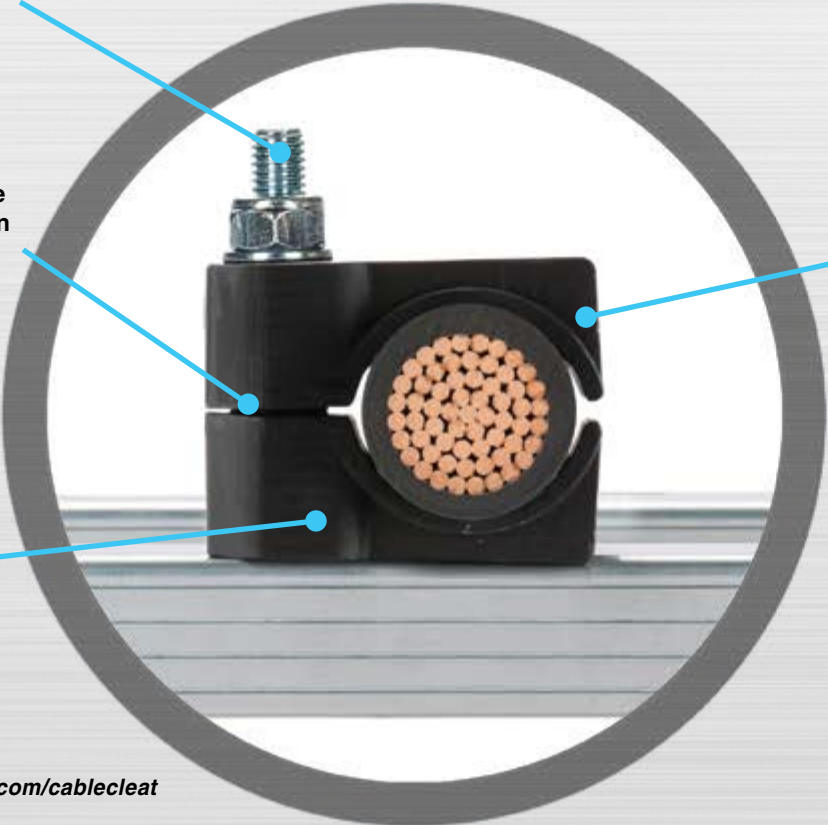

Rounded edges for cable protection

Ridges to hold cable in place

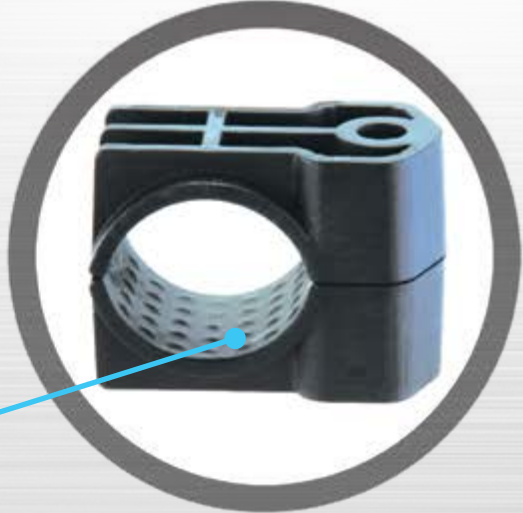

Part Number	Description	Cable Diameter Range		H		W		D		E		S		Weight		Mounting Holes
		In.	mm	In.	mm	In.	mm	In.	mm	In.	mm	In.	mm	Lb.	g	
CCPL1H1013-X	Cable cleat, polymer, one-hole configuration with a cable diameter of 10 - 13 mm.	0.39 - 0.51	10 - 13	1.10	28	1.74	44	1.69	43	0.56	14	0.81	21	0.08	38	1 x M10
CCPL1H1316-X	Cable cleat, polymer, one-hole configuration with a cable diameter of 13 - 16 mm.	0.51 - 0.63	13 - 16	1.22	31	1.87	48	1.69	43	0.56	14	0.87	22	0.10	44	1 x M10
CCPL1H1619-X	Cable cleat, polymer, one-hole configuration with a cable diameter of 16 - 19 mm.	0.63 - 0.75	16 - 19	1.34	34	2.00	51	1.70	43	0.56	14	0.94	24	0.11	49	1 x M10
CCPL1H1923-X	Cable cleat, polymer, one-hole configuration with a cable diameter of 19 - 23 mm.	0.75 - 0.91	19 - 23	1.46	37	2.15	55	1.70	43	0.56	14	1.01	26	0.12	56	1 x M10
CCPL1H2327-X	Cable cleat, polymer, one-hole configuration with a cable diameter of 23 - 27 mm.	0.91 - 1.06	23 - 27	1.61	41	2.32	59	1.71	43	0.56	14	1.09	28	0.14	63	1 x M10
CCPL1H2732-X	Cable cleat, polymer, one-hole configuration with a cable diameter of 27 - 32 mm.	1.06 - 1.26	27 - 32	1.77	45	2.52	64	1.71	44	0.57	14	1.19	30	0.16	72	1 x M10
CCPL1H3238-X	Cable cleat, polymer, one-hole configuration with a cable diameter of 32 - 38 mm.	1.26 - 1.50	32 - 38	1.97	50	2.75	70	1.72	44	0.57	15	1.31	33	0.18	82	1 x M10
CCPL1H3846-X	Cable cleat, polymer, one-hole configuration with a cable diameter of 38 - 46 mm.	1.50 - 1.81	38 - 46	2.28	58	3.06	78	1.73	44	0.57	15	1.46	37	0.21	96	1 x M10
CCPL1H4651-X	Cable cleat, polymer, one-hole configuration with a cable diameter of 46 - 51 mm.	1.81 - 2.01	46 - 51	2.56	65	3.29	84	1.74	44	0.58	15	1.57	40	0.25	114	1 x M10
CCPL1H5157-X	Cable cleat, polymer, one-hole configuration with a cable diameter of 51 - 57 mm.	2.01 - 2.24	51 - 57	2.76	70	3.53	90	1.75	44	0.58	15	1.69	43	0.28	125	1 x M10

Short Circuit Testing Summary¹

Flat Formation 105 mm Cable Spacing	Flat Formation 105 mm Cable Spacing
One Short Circuit Event (Clause 6.4.4) 600 mm spacing	Two Short Circuit Events (Clause 6.4.5) 600 mm spacing
69.5 kA	69.5 kA
1055 lbs force (4.69 kN)	1055 lbs force (4.69 kN)

¹Test compliance to IEC 61914:2015 utilizing KEMA facility; Independent, ISO 17025 accredited testing, inspection, and certification services (IEEE, IEC, UL, and ANSI) for electric power equipment.

PANDUIT SOLUTIONS FOR ELECTRICAL AND NETWORKING INSTALLATIONS

From Breaking Ground to Routine Maintenance and Repair, Panduit Products Impact Your Entire Project Lifecycle

Partner with a company committed to meeting the daily challenges you face. Panduit offers a full solution of over 30,000 readily available parts – from cable ties to power connectors, terminals to identification – Panduit products are engineered for all aspects of designing, installing and maintaining infrastructures within heavy-duty industrial environments.

Productivity Reduce costs and meet deadlines with products and tools engineered to improve efficiency

Reliability Ensure performance and design consistency of products that are vital to the success of the job

Safety Protect personnel, equipment and infrastructure

START EVERY PROJECT OFF RIGHT

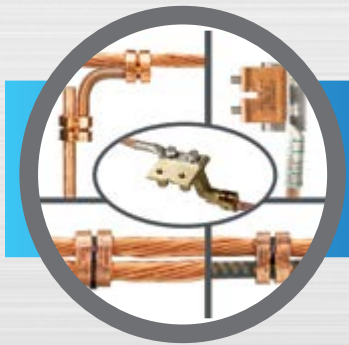

StructuredGround™ Direct Burial Compression Grounding System



Crimp Tools



Power Connectors



Abrasion Protection

PANDUIT SOLUTIONS FOR ELECTRICAL AND NETWORKING INSTALLATIONS



Stainless Steel Cable Ties



Labeling and Identification



Cable Ties



Lockout/Tagout and Safety Systems



VeriSafe™ Absence of Voltage Tester - AVT



NetKey™ Network Components

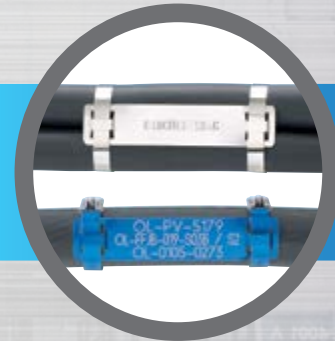

Permanent Identification



Cable Management Accessories



PANDUIT™

Panduit Corp.
 World Headquarters
 Tinley Park, IL 60487

cs@panduit.com
 US and Canada: 800.777.3300
 Europe, Middle East, and Africa:
 44.20.8601.7200
 Latin America: 52.33.3777.6000
 Asia Pacific: 65.6305.7575

www.panduit.com/cablecleat

Global Capabilities

Global Expertise and Support

Global distribution, manufacturing, sales and technical support teams make Panduit solutions readily accessible, allowing the right products to be delivered when and where they are needed.

Worldwide Certifications

Panduit solutions hold a variety of the most common heavy industry certifications and approvals worldwide.