

Table of Contents

Type	page	Materials, Tools and Accessories	
Pictorial Index	2	Welding Material	32
Mold Numbering System	4	Wrap Sleeves	33
		Mold Sealers	33
		Cable Cleaning Brushes	34
Cable-to-Cable		Cable Clamps	34
SS	5	Rasp	34
TA	6	Torch Head	35
XA / XB	9	Galvanizing Touch-Up	35
PT	10	Mold Cleaning Brush	36
PC	11	Slag Removal Spade	36
		Disks	36
Cable-to-Ground Rod		Wear Plates	37
GB	12	Split Crucibles	37
GR	13	Handle Clamps	38
GT	15	Vertical Mold Support	38
GY	17	Chain Support	38
		Magnetic Handle Clamps	39
Cable-to-Steel		Fence Fabric Attachment	39
HA / HS	19	Ground Rod Drivers	40
HA (pipe)	20	Pliers	41
HC / HT	21	Screwdriver	41
VS	22	Welding Tray	41
VS (pipe)	23	Tool Kits	41
VF / VB	24	Ground System Testers	42
VT / VG	25	CADWELD PLUS	43
VV	26		
VN	27	Technical Information	
		Copper-Clad Steel	45
Cable-to-Lug		Conductor Chart	45
GL	28	Ground Rods Chart	45
LA	29	Concentric Wire Chart	46
Lugs of LA	30	Solid Wire Chart	46
		Cast Iron Pipe Chart	47
Cable-to-Stud		Fence Post Sections Chart	47
HX / HV	31	Copper Busbar Chart	47
		Steel Pipe Chart	48
		Steel Wire Chart	48
		Other CADWELD Connections	49-56

WARNING

Pentair products shall be installed and used only as indicated in Pentair's product instruction sheets and training materials. Instruction sheets are available at www.ericopentair.com and from your Pentair customer service representative. Improper installation, misuse, misapplication or other failure to completely follow Pentair's instructions and warnings may cause product malfunction, property damage, serious bodily injury and/or death, and void your warranty.

Copper-Clad Steel (CCS) Conductors

Copper-Clad Steel (CCS) conductors are composed of a steel core with a continuous and constant copper cladding that is thoroughly bonded throughout. CCS conductors combine the strength of steel with the high conductivity and corrosion resistance of copper.

CADWELD welded electrical connections have been used to join CCS conductors for over 40 years. The CADWELD exothermic process fuses the CCS conductors together to form a connection that will not corrode, loosen, or increase in resistance for the intended service life of the installation. CCS conductors may also be welded to copper conductors, rebar or any other horizontal or vertical steel surface or structure for electrical grounding.

CADWELD welded electrical connections are preferable to mechanical connections for CCS conductors. Mechanical connections rely on the deformation of the conductors and the pressure exerted by the connector on the conductor to reduce the contact resistance. Since the core of CCS conductors is steel, a CCS conductor will not deform as much as a pure copper conductor and therefore an exothermically welded connection is better suited for this application.

How to Order CADWELD Products

This catalog lists the most popular CADWELD connections for CCS construction. Look in the index for the connection you need. If you cannot find the connection you need, contact Pentair or your local distributor or agent.

1. What connection do you require?

Available connections are listed in the pictorial index, which also shows the degree of difficulty in making the connection, and ease of mold cleaning. We strongly recommend that wherever possible you use molds listed in this catalog. After selecting the connection, turn to the appropriate page and select the mold, welding material and tools you need.

2. What are the conductor sizes?



This catalog covers connections between CCS conductors to each other, to concentric stranded copper cable, to lugs, to ground rods, to rebar, and to rail. For sizes not listed, contact Pentair or your local distributor or agent.

Note: Other Pentair catalogs describe connections to conductors for solid or concentric stranded copper conductors, busbar, lightning protection cable, steel cable, etc.



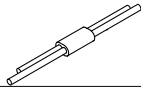
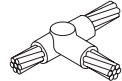
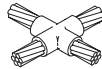
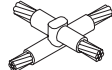
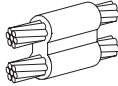
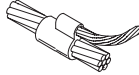



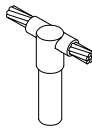
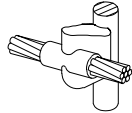

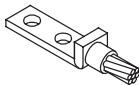
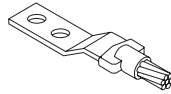
3. You must have the following to make a weld:

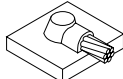
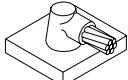
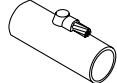
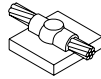
1. CADWELD engineered mold.
2. Welding material required by your mold.
3. Handle clamps and or frame.
4. CADWELD PLUS control unit or flint ignitor.
5. Lugs, sleeves, packing material listed on the page with the mold as required.

CABLE TO CABLE					
Name	Page	Type		Ease	Split
Horizontal Splice	5	SS		1	Vertical
Horizontal Tee	6	TA		1	Horizontal
Horizontal X, Same Plane	9	XA		1	Horizontal
Horizontal X	9	XB		1	Horizontal
Parallel Tap	10	PT		1	Vertical
Horizontal Parallel	11	PC		1	Vertical

CABLE TO GROUND ROD					
Name	Page	Type		Ease	Split
Ground Rod Splice	12	GB		1	Vertical
Cable to Ground Rod - Tap	13	GR		1	Vertical
Cable to Ground Rod - Through	15	GT		1	Vertical
Cable to Ground Rod - Through / Side	17	GY		1	Vertical

CABLE TO LUG					
Name	Page	Type		Ease	Split
Cable to Lug	28	GL		1	Vertical
Cable to Lug	29	LA		1	Horizontal

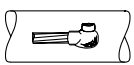
CABLE TO STEEL					
Name	Page	Type		Ease	Split
Horizontal Steel Surface	19	HA		1	*
Horizontal Steel Surface	19	HS		1	*
Horizontal Steel Pipe	20	HA, Pipe		1	*
Horizontal Steel Surface	21	HC		1	*
Horizontal Steel Surface	22	HT		1	*
Vertical Steel Surface	22	VS		1	Vertical
Vertical Steel Pipe	23	VS, Pipe			Vertical
Vertical Steel Surface	24	VF			Vertical
Vertical Steel Surface	24	VB			Vertical
Vertical Steel Surface	25	VT			*
Vertical Steel Surface	25	VG			*
Vertical Steel Surface	26	VV			Vertical
Vertical Steel Surface	27	VN			*

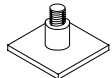
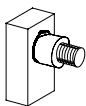
CABLE TO STUD					
Name	Page	Type		Ease	Split
Steel or Copper Studs to Steel Surface	31	HX		1	Vertical
Steel or Copper Studs to Steel Surface	31	HV		1	Horizontal

The CADWELD Mold Numbering System

The CADWELD mold part number gives, in code, the complete information of the mold – type of connection, mold price key, and conductor size(s).

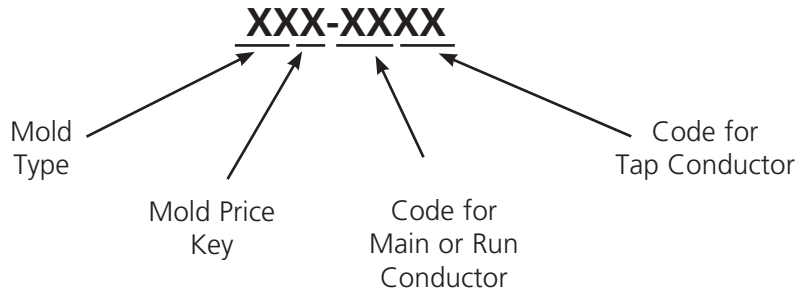

EXAMPLES

TAC-9F9C

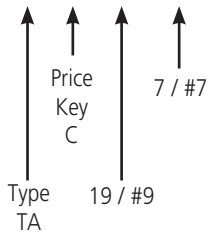

GTC-P16 9H

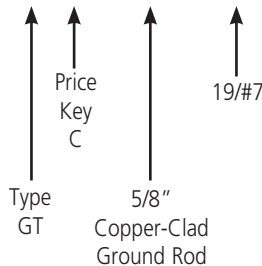

SSC-9F

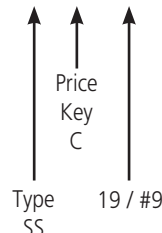

VSC-9D-V5C

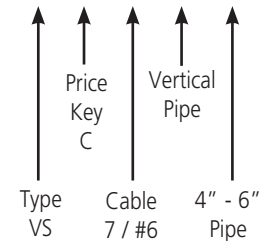

Certain tools may be required for various connections.

If required, these tools are listed on the same page as the connection and in Section A.

- Some tools listed in Section A can save you a lot of time.
- Also refer to A9E, Contractor Tips, to make your job easier, and learn about labor saving ideas.

REQUIRED TOOLS SUMMARY

Required tools are listed with each mold. For your reference, handle clamps and/or frame are summarized below.

<u>MOLD</u>	<u>REQUIRED</u>
A*	Includes frame with handle
C, Q & R	Requires L160
D, F & Z	Requires L159
E*	Includes frame but also requires L160
J*	Includes frame but also requires L159
K*, M* & V*	Includes frame with handles

* To order mold only - without handles or frame - add suffix "M" to mold part number.

For Stranded Copper-Clad Steel Conductors

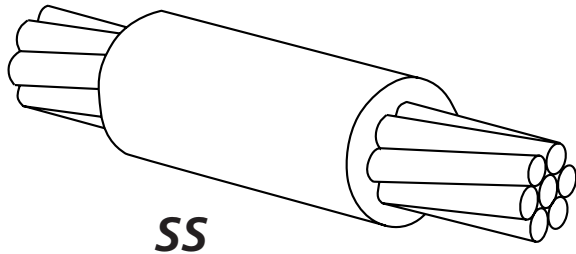

HORIZONTAL SPLICE

- Splice of horizontal cables.
- Concentric stranded copper cable unless otherwise noted.
- Solid conductor may be copper or copper-clad.
- Also available are splices of different and mixed cable sizes. For copper-clad DSA cables, contact Pentair.
- **Bold letter** in mold part number is the price key.

REQUIRED TOOLS

	Part No.
Handle Clamps	
for C Price Key Molds	L160
for D Price Key Molds	L159
CADWELD PLUS Control Unit or Flint Ignitor	PLUSCU T320

SUGGESTED TOOLS

Cable Cleaning Brush	T313 or T314
Slag Removal Spade	B136A or B136B
Mold Cleaning Brush	T394
Cable Clamp	B265
Torch Head	T111

ACCESSORIES

- See Section A

CABLE SIZE (sq mm)	MOLD PART NO.	WELDING MATERIAL ¹
7/#10	SS C 9A	32
7/#8	SS C 9B	45
7/#7	SS C 9C	65
7/#6	SS C 9D	90
7/#5	SS C 9E	115
19/#9	SS C 9F	115
19/#8	SS C 9G	115
19/#7	SS C 9H	150
19/#6	SS C 9J	200

¹ For CADWELD PLUS add suffix "PLUSF20" (refer page 44)

For Stranded Copper-Clad Steel Conductors

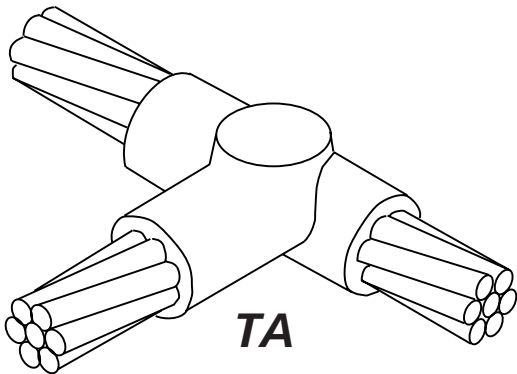

HORIZONTAL TEE CONNECTIONS

- Tee of horizontal run and tap cables.
- Concentric stranded copper cable unless otherwise noted.
- Solid conductor may be copper or copper-clad.
- **Bold letter** in mold part number is the price key.

REQUIRED TOOLS

	Part No.
Handle Clamps	L160
for C Price Key Molds	L159
for D Price Key Molds	
CADWELD PLUS Control Unit or Flint Ignitor	PLUSCU T320

SUGGESTED TOOLS

Cable Cleaning Brush	T313 or T314
Slag Removal Spade	B136A or B136B
Mold Cleaning Brush	T394
Cable Clamp	B265
Torch Head	T111

ACCESSORIES

- See Section A

CABLE SIZE (sq mm)		MOLD PART NO.	WELDING MATERIAL ¹
Run	Tap		
7/#10	7/#10	TAC 9 A9A	45
7/#8	7/#8	TAC 9 B9B	65
	7/#10	TAC 9 B9A	45
	2/0*	TAC 9 B2G	65
	4/0*	TAC 9 B2Q	90
7/#7	7/#7	TAC 9 C9C	90
	7/#8	TAC 9 C9B	90
	7/#10	TAC 9 C9A	45
	2/0*	TAC 9 C2G	90
	4/0*	TAC 9 C2Q	115
7/#6	7/#6	TAC 9 D9D	115
	7/#7	TAC 9 D9C	90
	7/#8	TAC 9 D9B	90
	7/#10	TAC 9 D9A	45
	2/0*	TAC 9 D2G	90
	4/0*	TAC 9 D2Q	115
	7/#5	7/#5	TAC 9 E9E
7/#6		TAC 9 E9D	115
7/#7		TAC 9 E9C	90
7/#8		TAC 9 E9B	90
7/#10		TAC 9 E9A	90
2/0*		TAC 9 E2G	90
4/0*		TAC 9 E2Q	150

¹ For CADWELD PLUS add suffix "PLUSF20" (refer page 44)
*Concentric stranded copper cable

CABLE SIZE (sq mm)		MOLD PART NO.	WELDING MATERIAL ¹
Run	Tap		
19/#9	19/#9	TAC 9 F9F	150
	7/#5	TAC 9 F9E	150
	7/#6	TAC 9 F9D	150
	7/#7	TAC 9 F9C	90
	7/#8	TAC 9 F9B	90
	2/0*	TAC 9 F2G	90
	4/0*	TAC 9 F2Q	150
	19/#8	19/#8	TAC 9 G9G
19/#9		TAC 9 G9F	150
7/#5		TAC 9 G9E	150
7/#6		TAC 9 G9D	150
7/#7		TAC 9 G9C	90
7/#8		TAC 9 G9B	90
2/0*		TAC 9 G2G	90
4/0*		TAC 9 G2Q	150

¹ For CADWELD PLUS add suffix "PLUSF20" (refer page 44)
*Concentric stranded copper cable

For Stranded Copper-Clad Steel Conductors

CABLE SIZE (sq mm)		MOLD PART NO.	WELDING MATERIAL ¹
Run	Tap		
19/#7	19/#7	TAC9H9H	200
	19/#8	TAC9H9G	200
	19/#9	TAC9H9F	200
	7/#5	TAC9H9E	150
	7/#6	TAC9H9D	150
	7/#7	TAC9H9C	90
	7/#8	TAC9H9B	90
	2/0*	TAC9H2G	90
	4/0*	TAC9H2Q	150
	500*	TAC9H3Q	250
19/#6	19/#6	TAC9J9J	2-150
	19/#7	TAC9J9H	200
	19/#8	TAC9J9G	200
	19/#9	TAC9J9F	200
	7/#5	TAC9J9E	150
	7/#6	TAC9J9D	115
	2/0*	TAC9J2G	90
	4/0*	TAC9J2Q	150
	500*	TAC9J3Q	2-150
2/0*	19/#6	TAC2G9J	115
	19/#7	TAC2G9H	115
	19/#8	TAC2G9G	115
	19/#9	TAC2G9F	115
	7/#5	TAC2G9E	115
	7/#6	TAC2G9D	90
	7/#7	TAC2G9C	90
	7/#8	TAC2G9B	90
	7/#10	TAC2G9A	65

CABLE SIZE (sq mm)		MOLD PART NO.	WELDING MATERIAL ¹
Run	Tap		
4/0*	19/#6	TAC2Q9J	150
	19/#7	TAC2Q9H	150
	19/#8	TAC2Q9G	150
	19/#9	TAC2Q9F	150
	7/#5	TAC2Q9E	150
	7/#6	TAC2Q9D	150
	7/#7	TAC2Q9C	90
	7/#8	TAC2Q9B	90
	7/#10	TAC2Q9A	90
	250*	19/#6	TAC2V9J
19/#7		TAC2V9H	150
19/#8		TAC2V9G	150
19/#9		TAC2V9F	150
7/#5		TAC2V9E	150
7/#6		TAC2V9D	150
7/#7		TAC2V9C	90
7/#8		TAC2V9B	90
7/#10		TAC2V9A	90
500*	19/#6	TAD3Q9J	2-150
	19/#7	TAC3Q9H	250
	19/#8	TAC3Q9G	200
	19/#9	TAC3Q9F	200
	7/#5	TAC3Q9E	200
	7/#6	TAC3Q9D	150
	7/#7	TAC3Q9C	115
	7/#8	TAC3Q9B	115

¹ For CADWELD PLUS add suffix "PLUSF20" (refer page 44)

*Concentric stranded copper cable

¹ For CADWELD PLUS add suffix "PLUSF20" (refer page 44)

*Concentric stranded copper cable

For Stranded Copper-Clad Steel Conductors

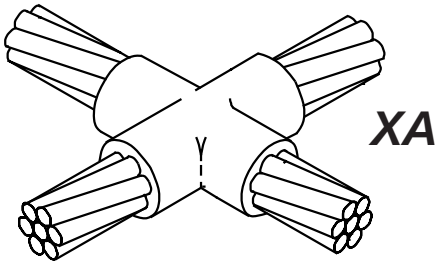

XA

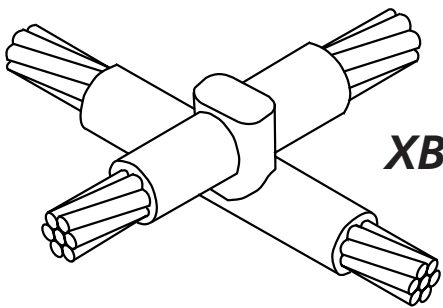

XB

HORIZONTAL X CONNECTIONS

- **XA** – Cross of horizontal cables, tap cable cut – cables in same plane.
- **XB** – Cross of horizontal cables, lapped and not cut.
- Concentric stranded copper cable unless otherwise noted.
- Solid conductor may be copper or copper-clad.
- **Bold letter** in mold part number is the price key.

REQUIRED TOOLS

	Part No.
Handle Clamps	
for C Price Key Molds	L160
for D Price Key Molds	L159
CADWELD PLUS Control Unit or Flint Ignitor	PLUSCU T320

SUGGESTED TOOLS

Cable Cleaning Brush	T313 or T314
Slag Removal Spade	
#65 w/m & smaller	B136A
#90 w/m & larger	B136B
Mold Cleaning Brush	T394
Cable Clamp	B265
Torch Head	T111

ACCESSORIES

- See Section A

CABLE SIZE (sq mm)		TYPE XA		TYPE XB	
run	tap	MOLD PART NO.	WELDING MATERIAL ¹	MOLD PART NO.	WELDING MATERIAL ¹
7/#10	7/#10	XA C 9A9A	65	XB C 9A9A	90
7/#8	7/#8	XA C 9B9B	90	XB C 9B9B	150
	7/#10	XA C 9B9A	90	XB C 9B9A	115
7/#7	7/#7	XA C 9C9C	115	XB Q 9C9C	200
	7/#8	XA C 9C9B	115	XB Q 9C9B	200
	7/#10	XA C 9C9A	115	XB Q 9C9A	150
7/#6	7/#6	XA C 9D9D	200	XB Q 9D9D	250
	7/#7	XA C 9D9C	150	XB Q 9D9C	200
	7/#8	XA C 9D9B	150	XB Q 9D9B	200
	7/#10	XA C 9D9A	115	XB Q 9D9A	150
7/#5	7/#5	XA C 9E9E	200	XB Q 9E9E	250
	7/#6	XA C 9E9D	200	XB Q 9E9D	250
	7/#7	XA C 9E9C	150	XB Q 9E9C	200
	7/#8	XA C 9E9B	150	XB Q 9E9B	200

¹For CADWELD PLUS add suffix "PLUSF20" (refer page 44)

For Stranded Copper-Clad Steel Conductors

CABLE SIZE (sq mm)		TYPE XA		TYPE XB	
Run	Tap	MOLD PART NO.	WELDING MATERIAL ¹	MOLD PART NO.	WELDING MATERIAL ¹
19/#9	19/#9	XAC9F9F	200	XBQ9F9F	2-150
	7/#5	XAC9F9E	200	XBQ9F9E	2-150
	7/#6	XAC9F9D	200	XBQ9F9D	2-150
	7/#7	XAC9F9C	150	XBQ9F9C	250
	7/#8	XAC9F9B	150	XBQ9F9B	250
19/#8	19/#8	XAC9G9G	250	XBZ9G9G	2-200
	19/#9	XAC9G9F	250	XBZ9G9F	2-200
	7/#5	XAC9G9E	250	XBQ9G9E	2-150
	7/#6	XAC9G9D	200	XBQ9G9D	2-150
	7/#7	XAC9G9C	150	XBQ9G9C	250
	7/#8	XAC9G9B	150	XBQ9G9B	250
19/#7	19/#7	XAD9H9H	2-150	XBZ9H9H	500
	19/#8	XAD9H9G	2-150	XBZ9H9G	500
	19/#9	XAD9H9F	2-150	XBZ9H9F	500
	7/#5	XAD9H9E	2-150	XBZ9H9E	2-200
	7/#6	XAC9H9D	250	XBZ9H9D	2-200
	7/#7	XAC9H9C	250	XBQ9H9C	2-150
	7/#8	XAC9H9B	250	XBQ9H9B	250
19/#6	19/#6	XAD9J9J	500	XBZ9J9J	3-250
	19/#7	XAD9J9H	500	XBZ9J9H	3-200
	19/#8	XAD9J9G	2-200	XBZ9J9G	3-200
	19/#9	XAD9J9F	2-150	XBZ9J9F	500
	7/#5	XAD9J9E	2-150	XBZ9J9E	500
	7/#6	XAD9J9D	2-150	XBZ9J9D	500
	7/#7	XAC9J9C	250	XBZ9J9C	2-200
	7/#8	XAC9J9B	250	XBQJ9B	2-150

¹For CADWELD PLUS add suffix "PLUSF20" (refer page 44)

For Stranded Copper-Clad Steel Conductors

PARALLEL HORIZONTAL CONDUCTORS

- Parallel through connection of horizontal cables.
- Run conductor is on the bottom of molds.
- Concentric strand copper cable unless otherwise noted.
- Solid conductor may be copper or copper-clad.
- **Bold letter** in mold part number is the price key.

REQUIRED TOOLS

	Part No.
Handle Clamps	
for C Price Key Molds	L160
for D Price Key Molds	L159
CADWELD PLUS Control Unit or Flint Ignitor	PLUSCU T320

SUGGESTED TOOLS

Cable Cleaning Brush	T313 or T314
Slag Removal Spade	
#65 w/m & smaller	B136A
#90 w/m & larger	B136B
Mold Cleaning Brush	T394
Cable Clamp	B265
Torch Head	T111

ACCESSORIES

- See Section A

CABLE SIZE (sq mm)		MOLD PART NO.	WELDING MATERIAL ¹
run	tap		
7/#10	7/#10	PT C 9A9A	65
7/#8	7/#8	PT C 9B9B	90
	7/#10	PT C 9B9A	65
7/#7	7/#7	PT C 9C9C	115
	7/#8	PT C 9C9B	115
	7/#10	PT C 9C9A	90
7/#6	7/#6	PT C 9D9D	150
	7/#7	PT C 9D9C	150
	7/#8	PT C 9D9B	115
	7/#10	PT C 9D9A	115
7/#5	7/#5	PT C 9E9E	200
	7/#6	PT C 9E9D	200
	7/#7	PT C 9E9C	150
	7/#8	PT C 9E9B	150
19/#9	19/#9	PT C 9F9F	250
	7/#5	PT C 9F9E	200
	7/#6	PT C 9F9D	200
	7/#7	PT C 9F9C	150
	7/#8	PT C 9F9B	150
19/#8	19/#8	PT D 9G9G	2-150
	19/#9	PT C 9G9F	250
	7/#5	PT C 9G9E	200
	7/#6	PT C 9G9D	200
	7/#7	PT C 9G9C	150
	7/#8	PT C 9G9B	150
19/#7	19/#7	PT D 9H9H	2-150
	19/#8	PT D 9H9G	2-150
	19/#9	PT C 9H9F	250
	7/#5	PT C 9H9E	200
	7/#6	PT C 9H9D	200
	7/#7	PT C 9H9C	150
	7/#8	PT C 9H9B	150
19/#6	19/#6	PT D 9J9J	2-200
	19/#7	PT D 9J9H	2-150
	19/#8	PT D 9J9G	2-150
	19/#9	PT C 9J9F	250
	7/#5	PT C 9J9E	200
	7/#6	PT C 9J9D	200
	7/#7	PT C 9J9C	150
	7/#8	PT C 9J9B	150

¹For CADWELD PLUS add suffix "PLUSF20" (refer page 44)

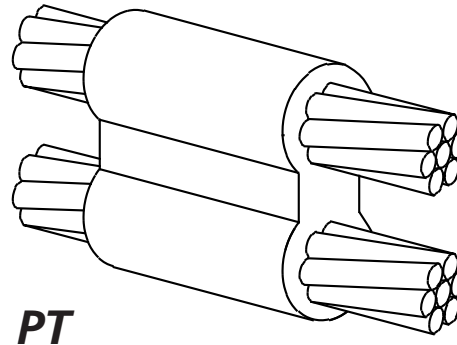

PT

For Stranded Copper-Clad Steel Conductors

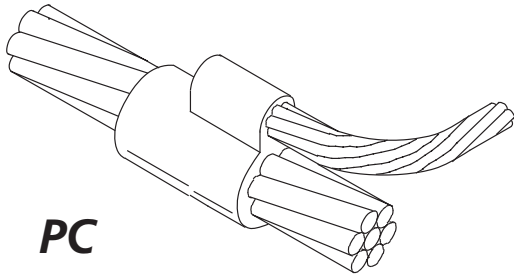

PARALLEL TAP CONNECTIONS

- Parallel through connection of horizontal cables.
- Solid conductor may be copper or copper-clad.
- Concentric strand copper cable unless otherwise noted.
- **Bold letter** in mold part number is the price key.

REQUIRED TOOLS

	Part No.
Handle Clamps	
for C Price Key Molds	L160
for D Price Key Molds	L159
CADWELD PLUS Control Unit or Flint Ignitor	PLUSCU T320

SUGGESTED TOOLS

Cable Cleaning Brush	T313 or T314
Slag Removal Spade	
#65 w/m & smaller	B136A
#90 w/m & larger	B136B
Mold Cleaning Brush	T394
Cable Clamp	B265
Torch Head	T111

ACCESSORIES

- See Section A

CABLE SIZE run	CABLE SIZE (sq mm) tap	MOLD PART NO.	WELDING MATERIAL ¹
7/#10	8 SOL	PC C 9A1D	32
	6 SOL	PC C 9A1G	32
	6*	PC C 9A1H	32
	4*	PC C 9A1L	45
	2*	PC C 9A1V	65
7/#8	8 SOL	PC C 9B1D	45
	6 SOL	PC C 9B1G	45
	6*	PC C 9B1H	45
	4*	PC C 9B1L	45
	2*	PC C 9B1V	65
7/#7	8 SOL	PC C 9C1D	45
	6 SOL	PC C 9C1G	45
	6*	PC C 9C1H	45
	4*	PC C 9C1L	65
	2*	PC C 9C1V	65
7/#6	8 SOL	PC C 9D1D	65
	6 SOL	PC C 9D1G	65
	6*	PC C 9D1H	65
	4*	PC C 9D1L	65
	2*	PC D 9D1V	90
7/#5	8 SOL	PC C 9E1D	65
	6 SOL	PC C 9E1G	65
	6*	PC C 9E1H	65
	4*	PC C 9E1L	90
	2*	PC C 9E1V	90

¹ For CADWELD PLUS add suffix "PLUSF20" (refer page 44)

*Concentric stranded copper cable

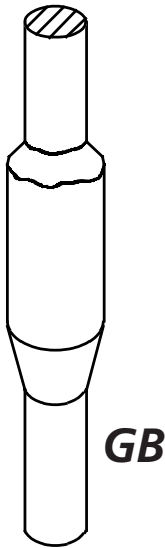

GROUND ROD SPLICE

- CADWELD ground rod splices are very strong and use the proven corrosion resistant CADWELD connection.
- CADWELD ground rod splices are available for copper-clad, galvanized or stainless ground rods.
- **Bold letter** in mold part number is the price key.

REQUIRED TOOLS

	Part No.
Handle Clamps	
for C Price Key Molds	L160
for D Price Key Molds	L159
CADWELD PLUS Control Unit or Flint Ignitor	PLUSCU T320
Ground Rod Splice Clamp	B120

SUGGESTED TOOLS

Cable Cleaning Brush	T313 or T314
Slag Removal Spade	
#65 w/m & smaller	B136A
#90 w/m & larger	B136B
Mold Cleaning Brush	T394
Cable Clamp	B265
File	T329
Torch Head	T111

ACCESSORIES

- See Section A

GROUND ROD SIZE Dia. (mm)	GROUND ROD TYPE	MOLD PART NO.	WELDING MATERIAL ¹
1/2"	Steel or Copper-Clad Sectional (9/16" Threads)	HDGBC 14	250
	Copper-Clad Plain (Unthreaded)	HDGBC 15	250
	Copper-Clad Sectional With 1/2" Threads)	HDGBC 13	250
5/8"	Copper-Clad; 0.563" Diameter Fits Both Plain And Sectional (Threaded) Rods	HDGBD 16	2-150
	0.625" Diameter Stainless, Stainless Clad, Galvanized, Etc.	HDGBD 31	2-150
3/4"	Copper-Clad; 0.682" Diameter Fits Both Plain And Sectional (Threaded) Rods	HDGBD 18	2-200
	0.75" Diameter Fits Both Plain And Sectional (Threaded) Rods	HDGBD 33	2-200
1"	Copper-Clad; 0.914" Diameter Fits Both Plain And Sectional (Threaded) Rods	HDGBF 22	3-250
	1.00" Diameter Stainless, Stainless Clad, Galvanized, Etc.	HDGBF 37	3-250

¹ For CADWELD PLUS add suffix "PLUSF20" (refer page 44)

For Stranded Copper-Clad Steel Conductors

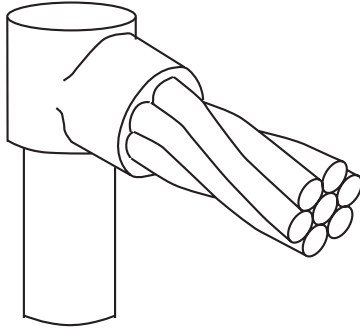

GR

CABLE TO GROUND ROD

- Single cable to top of ground rod. Concentric strand copper cable unless otherwise noted. For copper-clad, galvanized, stainless clad or stainless steel ground rods.
- **Bold letter** in mold part number is the price key.

REQUIRED TOOLS

	Part No.
Handle Clamps	
for C Price Key Molds	L160
for D Price Key Molds	L159
CADWELD PLUS Control Unit or Flint Ignitor	PLUSCU T320

SUGGESTED TOOLS

Cable Cleaning Brush	T313 or T314
Slag Removal Spade	
#65 w/m & smaller	B136A
#90 w/m & larger	B136B
Mold Cleaning Brush	T394
Cable Clamp	B265
File	T329
Torch Head	T111

ACCESSORIES

- See Section A

GROUND ROD SIZE Dia. (mm)	CABLE SIZE (sq mm)	MOLD PART NUMBER			WELDING MATERIAL ¹
		STEEL OR COPPER-CLAD SECTIONAL (WITH 9/16" THREADS)	COPPER-CLAD PLAIN (UNTHREADED)	COPPER-CLAD SECTIONAL (WITH 1/2" THREADS)	
1/2"	7/#10	GR C 149A	GR C 159A	GR C 139A	65
	7/#8	GR C 149B	GR C 159B	GR C 139B	90
	7/#7	GR C 149C	GR C 159C	GR C 139C	90
	7/#6	GR C 149D	GR C 159D	GR C 139D	90
	7/#5	GR C 149E	GR C 159E	GR C 139E	90
	19/#9	GR C 149F	GR C 159F	GR C 139F	90
	19/#8	GR C 149G	GR C 159G	GR C 139G	90

¹For CADWELD PLUS add suffix "PLUSF20" (refer page 44)

For Stranded Copper-Clad Steel Conductors

GROUND ROD SIZE Dia. (mm)	CABLE SIZE (sq mm)	MOLD PART NUMBER		
		COPPER-CLAD SECTIONAL (THREADED) OR PLAIN	STEEL	WELDING MATERIAL ¹
5/8"	7/#10	GRC169A	GRC319A	65
	7/#8	GRC169B	GRC319B	90
	7/#7	GRC169C	GRC319C	90
	7/#6	GRC169D	GRC319D	90
	7/#5	GRC169E	GRC319E	90
	19/#9	GRC169F	GRC319F	90
	19/#8	GRC169G	GRC319G	115
	19/#7	GRC169H	GRC319H	150
	19/#6	GRC169J	GRC319J	150
	3/4"	7/#10	GRC189A	GRC339A
7/#8		GRC189B	GRC339B	90
7/#7		GRC189C	GRC339C	90
7/#6		GRC189D	GRC339D	90
7/#5		GRC189E	GRC339E	90
19/#9		GRC189F	GRC339F	90
19/#8		GRC189G	GRC339G	115
19/#7		GRC189H	GRC339H	150
19/#6		GRC189J	GRC339J	150
1"		7/#10	GRC229A	GRC379A
	7/#8	GRC229B	GRC379B	150
	7/#7	GRC229C	GRC379C	150
	7/#6	GRC229D	GRC379D	150
	7/#5	GRC229E	GRC379E	150
	19/#9	GRC229F	GRC379F	150
	19/#8	GRC229G	GRC379G	200
	19/#7	GRC229H	GRC379H	200
	19/#6	GRC229J	GRC379J	200

¹ For CADWELD PLUS add suffix "PLUSF20" (refer page 44)

For Stranded Copper-Clad Steel Conductors

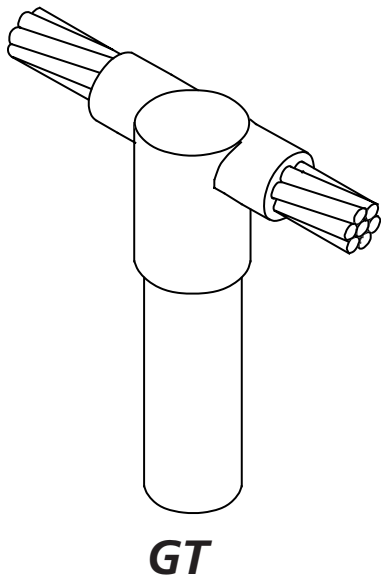

CABLE TO GROUND ROD

- Through cable to top of ground rod. Connections are for concentric strand copper cable unless otherwise noted.
- For copper-clad, galvanized, stainless clad or stainless steel ground rods.
- **Bold letter** in mold part number is the price key.

REQUIRED TOOLS

	Part No.
Handle Clamps	
for C Price Key Molds	L160
for D Price Key Molds	L159
CADWELD PLUS Control Unit or Flint Ignitor	PLUSCU T320

SUGGESTED TOOLS

Cable Cleaning Brush	T313 or T314
Slag Removal Spade	
#65 w/m & smaller	B136A
#90 w/m & larger	B136B
Mold Cleaning Brush	T394
Cable Clamp	B265
File	T329
Torch Head	T111

ACCESSORIES

- See Section A

GROUND ROD SIZE Dia. (mm)	CABLE SIZE (sq mm)	MOLD PART NUMBER			WELDING MATERIAL ¹
		STEEL OR COPPER-CLAD SECTIONAL (WITH 9/16" THREADS)	COPPER-CLAD PLAIN (UNTHREADED)	COPPER-CLAD SECTIONAL (WITH 1/2" THREADS)	
1/2"	7/#10	GTC C 149A	GT C 159A	GT C 139A	90
	7/#8	GTC C 149B	GT C 159B	GT C 139B	90
	7/#7	GTC C 149C	GT C 159C	GT C 139C	90
	7/#6	GTC C 149D	GT C 159D	GT C 139D	115
	7/#5	GTC C 149E	GT C 159E	GT C 139E	150
	19/#9	GTC C 149F	GT C 159F	GT C 139F	150
	19/#8	GTC C 149G	GT C 159G	GT C 139G	200

¹ For CADWELD PLUS add suffix "PLUSF20" (refer page 44)

For Stranded Copper-Clad Steel Conductors

GROUND ROD SIZE Dia. (mm)	CABLE SIZE (sq mm)	MOLD PART NUMBER		
		COPPER-CLAD SECTIONAL (THREADED) OR PLAIN	STEEL	WELDING MATERIAL ¹
5/8"	7/#10	GTC169A	GTC319A	90
	7/#8	GTC169B	GTC319B	115
	7/#7	GTC169C	GTC319C	115
	7/#6	GTC169D	GTC319D	115
	7/#5	GTC169E	GTC319E	150
	19/#9	GTC169F	GTC319F	150
	19/#8	GTC169G	GTC319G	200
	19/#7	GTC169H	GTC319H	250
	19/#6	GTC169J	GTC319J	250
	3/4"	7/#10	GTC189A	GTC339A
7/#8		GTC189B	GTC339B	115
7/#7		GTC189C	GTC339C	115
7/#6		GTC189D	GTC339D	115
7/#5		GTC189E	GTC339E	150
19/#9		GTC189F	GTC339F	150
19/#8		GTC189G	GTC339G	200
19/#7		GTC189H	GTC339H	250
19/#6		GTC189J	GTC339J	250
1"		7/#10	GTC229A	GTC379A
	7/#8	GTC229B	GTC379B	150
	7/#7	GTC229C	GTC379C	150
	7/#6	GTC229D	GTC379D	150
	7/#5	GTC229E	GTC379E	200
	19/#9	GTC229F	GTC379F	200
	19/#8	GTC229G	GTC379G	200
	19/#7	GTC229H	GTC379H	250
	19/#6	GTC229J	GTC379J	250

¹ For CADWELD PLUS add suffix "PLUSF20" (refer page 44)

For Stranded Copper-Clad Steel Conductors

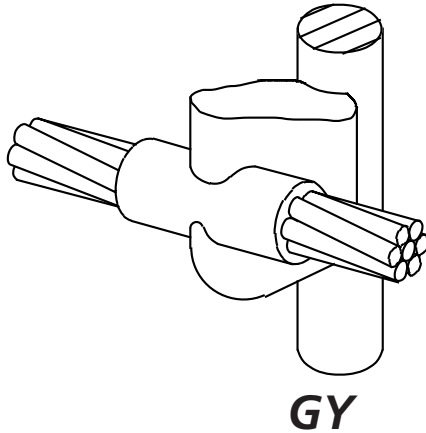

CABLE TO GROUND ROD

- Through cable to side of ground rod.
- Concentric strand copper cable unless otherwise noted.
- Ground rods can be copper-clad, galvanized, stainless clad or stainless steel.
- **Bold letter** in mold part number is the price key.

REQUIRED TOOLS

	Part No.
Handle Clamps	
for C Price Key Molds	L160
for D Price Key Molds	L159
CADWELD PLUS Control Unit or Flint Ignitor	PLUSCU T320

SUGGESTED TOOLS

Cable Cleaning Brush	T313 or T314
Slag Removal Spade	
#65 w/m & smaller	B136A
#90 w/m & larger	B136B
Mold Cleaning Brush	T394
Cable Clamp	B265
File	T329
Torch Head	T111

ACCESSORIES

- See Section A

GROUND ROD SIZE Dia. (mm)	CABLE SIZE (sq mm)	MOLD PART NUMBER			WELDING MATERIAL ¹
		STEEL OR COPPER-CLAD SECTIONAL (WITH 9/16" THREADS)	COPPER-CLAD PLAIN (UNTHREADED)	COPPER-CLAD SECTIONAL (WITH 1/2" THREADS)	
1/2"	7/#10	GY R 149A	GY R 159A	GY R 139A	90
	7/#8	GY R 149B	GY R 159B	GY R 139B	115
	7/#7	GY R 149C	GY R 159C	GY R 139C	115
	7/#6	GY R 149D	GY R 159D	GY R 139D	150
	7/#5	GY R 149E	GY R 159E	GY R 139E	150
	19/#9	GY R 149F	GY R 159F	GY R 139F	150
	19/#8	GY R 149G	GY R 159G	GY R 139G	200

¹ For CADWELD PLUS add suffix "PLUSF20" (refer page 44)

For Stranded Copper-Clad Steel Conductors

GROUND ROD SIZE Dia. (mm)	CABLE SIZE (sq mm)	MOLD PART NUMBER		
		COPPER-CLAD SECTIONAL (THREADED) OR PLAIN	STEEL	WELDING MATERIAL ¹
5/8"	7/#10	GYR169A	GYR319A	90
	7/#8	GYR169B	GYR319B	115
	7/#7	GYR169C	GYR319C	115
	7/#6	GYR169D	GYR319D	150
	7/#5	GYR169E	GYR319E	150
	19/#9	GYR169F	GYR319F	150
	19/#8	GYR169G	GYR319G	200
	19/#7	GYF169H	GYF319H	2-150
	19/#6	GYF169J	GYF319J	2-200
	3/4"	7/#10	GYR189A	GYR339A
7/#8		GYR189B	GYR339B	115
7/#7		GYR189C	GYR339C	115
7/#6		GYR189D	GYR339D	150
7/#5		GYR189E	GYR339E	200
19/#9		GYR189F	GYR339F	200
19/#8		GYR189G	GYR339G	250
19/#7		GYF189H	GYF339H	2-200
19/#6		GYF189J	GYF339J	500
1"		7/#10	GYR229A	GYR379A
	7/#8	GYR229B	GYR379B	115
	7/#7	GYR229C	GYR379C	115
	7/#6	GYR229D	GYR379D	150
	7/#5	GYR229E	GYR379E	200
	19/#9	GYR229F	GYR379F	200
	19/#8	GYR229G	GYR379G	250
	19/#7	GYF229H	GYF379H	2-200
	19/#6	GYF229J	GYF379J	500

¹For CADWELD PLUS add suffix "PLUSF20" (refer page 44)

For Stranded Copper-Clad Steel Conductors

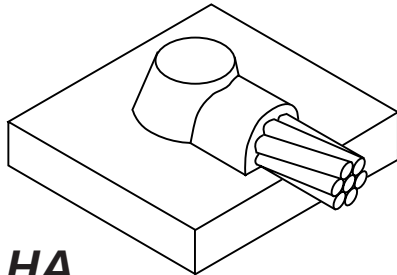

HA

Cable on surface

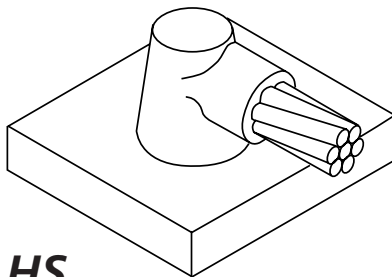

HS

Cable off surface

TYPE HA		
CABLE SIZE (sq mm)	MOLD PART NO.	WELDING MATERIAL ¹
7/#10	HAA9A	65

TYPE HS		
CABLE SIZE (sq mm)	MOLD PART NO.	WELDING MATERIAL ¹
7/#8	HSC9B	90
7/#7	HSC9C	90
7/#6	HSC9D	115
7/#5	HSC9E	115
19/#9	HSC9F	115
19/#8	HSC9G	150
19/#7	HSC9H	200
19/#6	HSC9J	200

¹For CADWELD PLUS add suffix "PLUSF20" (refer page 44)

HORIZONTAL STEEL SURFACE

- Horizontal concentric copper conductor to flat steel surface or top of horizontal pipe
- **A test weld should be made to check the possibility of burn-through on thin sections or thin wall pipe.**
- Concentric stranded copper cable listed.
- **Bold letter** in mold part number is the price key.

REQUIRED TOOLS

	Part No..
Handle Clamps*	
Flat Surface for C Price Key Molds	L160
for D Price Key Molds	L159
Pipe (curved surface) for C Price Key Molds	B160V
for D Price Key Molds	B159V
CADWELD PLUS Control Unit or Flint Ignitor	PLUSCU T320

SUGGESTED TOOLS

Cable Cleaning Brush	T313 or T314
Slag Removal Spade	
#65 w/m & smaller	B136A
#90 w/m & larger	B136B
Mold Cleaning Brush	T394
Cable Clamp	B265
Torch Head	T111
Rasp	T321

ACCESSORIES

- See Section A

*Handles are included with A Price Key Molds.

Cable to Steel Pipe (Types HA and HS) –

Use flat surface mold part number with suffix.

Cable	Nominal Pipe Diameter	Suffix
7/#10	12" and smaller 14" and larger	Nominal Pipe Size None
7/#8 thru 19/#9	28" and smaller 30" and larger	Nominal Pipe Size None

Example: 7/#10 cable to 3-1/2" pipe, HAA9A3.50

For welds to copper surface, contact Pentair or your local distributor or agent.

For Stranded Copper-Clad Steel Conductors

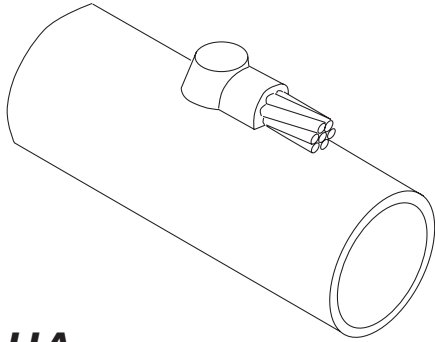

HA

Cable to Horizontal Steel Pipe

RANGE OF HORIZONTAL STEEL PIPES

- Horizontal conductor to top of horizontal steel pipe.
- **A test weld should be made to check the possibility of burn-through on thin sections or thin wall pipe.**
- When only one pipe size is involved, see Cable to Steel Pipe table on previous page.
- Concentric stranded copper cable listed.
- **Bold letter** in mold part number is the price key.

REQUIRED TOOLS

	Part No.
Handle Clamps*	
Flat Surface	for C Price Key Molds L160 for D Price Key Molds L159
Pipe (curved surface)	for C Price Key Molds B160V for D Price Key Molds B159V
CADWELD PLUS Control Unit or Flint Ignitor	PLUSCU T320

SUGGESTED TOOLS

Cable Cleaning Brush	T313 or T314
Slag Removal Spade	
#65 w/m & smaller	B136A
#90 w/m & larger	B136B
Mold Cleaning Brush	T394
Rasp	T321
Torch Head	T111

ACCESSORIES

- See Section A

*Handles are included with A Price Key Molds.

CABLE SIZE	NOMINAL PIPE SIZE	MOLD PART NO.	WELDING MATERIAL ¹
7/#10	1-1/4" to 2" Pipe	HA A 9A162C	65
	3" to 4" Pipe	HA A 9A350C	65
	6" to 8" Pipe	HA A 9A7C	65
	10" to 12" Pipe	HA A 9A11C	65
	14" Pipe or Larger	(2)	
7/#8	3" to 4" Pipe	HA H 9B350C	90
	6" to 10" Pipe	HA H 9B8C	90
	12" to 28" Pipe	HA H 9B20C	90
	30" Pipe or Larger	(2)	

¹ For CADWELD PLUS add suffix "PLUSF20" (refer page 44)
(2) Use flat surface mold part number. See previous page.

CABLE SIZE	NOMINAL PIPE SIZE	MOLD PART NO.	WELDING MATERIAL ¹
7/#7	3" to 4" Pipe	HA H 9C350C	90
	6" to 10" Pipe	HA H 9C8C	90
	12" to 28" Pipe	HA H 9C20C	90
	30" Pipe or Larger	(2)	
7/#6	3" to 4" Pipe	HA H 9D350C	115
	6" to 10" Pipe	HA H 9D8C	115
	12" to 28" Pipe	HA H 9D20C	115
	30" Pipe or Larger	(2)	
7/#5	3" to 4" Pipe	HA H 9E350C	115
	6" to 8" Pipe	HA H 9E8C	115
	12" to 28" Pipe	HA H 9E20C	115
	30" Pipe or Larger	(2)	

(2) Use flat surface mold part number. See previous page.

For Stranded Copper-Clad Steel Conductors

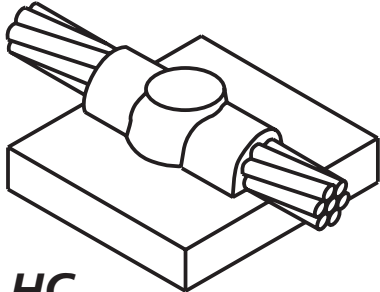

HC

Cable on surface

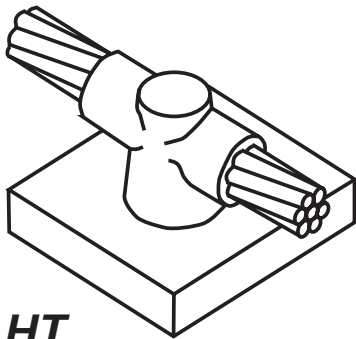

HT

Cable off surface

RANGE OF HORIZONTAL STEEL PIPES

- Cable to horizontal flat steel surface or cable to top of horizontal steel pipe.
- **A test weld should be made to check the possibility of burn-through on thin sections or thin wall pipe.**
- Concentric stranded copper cable listed.
- **Bold letter** in mold part number is the price key.

REQUIRED TOOLS

		Part No..
Handle Clamps*		
Flat Surface	for C Price Key Molds	L160
	for D Price Key Molds	L159
Pipe (curved surface)	for C Price Key Molds	B160V
	for D Price Key Molds	B159V
CADWELD PLUS Control Unit or Flint Ignitor		PLUSCU T320

SUGGESTED TOOLS

Cable Cleaning Brush	T313 or T314
Slag Removal Spade	
#65 w/m & smaller	B136A
#90 w/m & larger	B136B
Mold Cleaning Brush	T394
Rasp	T321
Torch Head	T111

ACCESSORIES

- See Section A

TYPE HC

CABLE SIZE (sq mm)	MOLD PART NO.	WELDING MATERIAL ¹
7/#10	HCA A 9A	65

TYPE HT

CABLE SIZE (sq mm)	MOLD PART NO.	WELDING MATERIAL ¹
7/#8	HTC C 9B	90
7/#7	HTC C 9C	115
7/#6	HTC C 9D	150
7/#5	HTC C 9E	150
19/#9	HTC C 9F	150
19/#8	HTC C 9G	200
19/#7	HTC C 9H	250
19/#6	HTC C 9J	2-150

Cable to horizontal Steel Pipe (Types HC and HT) – Use flat surface mold part number with suffix.

Cable	Nominal Pipe Diameter	Suffix
7/#10	12" and smaller 14" and larger	Nominal Pipe Size None
7/#8 thru 19/#6	28" and smaller 30" and larger	Nominal Pipe Size None

Example: 7/#10 cable to 6" pipe, HCA**A**9A6

¹For CADWELD PLUS add suffix "PLUSF20" (refer page 44)

For Stranded Copper-Clad Steel Conductors

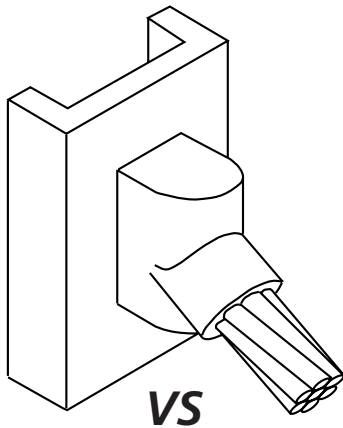

VERTICAL STEEL SURFACE

- Cable down at 45° to vertical steel surface including pipe.
- Cable to vertical flat steel surface; cable to side of vertical or horizontal steel pipe.
- Concentric stranded copper cable listed.
- **A test weld should be made to check the possibility of burn through on thin sections or thin wall pipe.**
- **Bold letter** in mold part number is the price key.

REQUIRED TOOLS

		Part No.
Handle Clamps		
Flat Surface	for C Price Key Molds	L160
	for D Price Key Molds	L159
Pipe	for C Price Key Molds	B160V
	for D Price Key Molds	B159V
		(Pipes 10ø-250 mm dia. add B158)
CADWELD PLUS Control Unit or Flint Ignitor		PLUSCU T320

SUGGESTED TOOLS

Cable Cleaning Brush	T313 or T314
Mold Cleaning Tool	T394
Mold Cleaning Brush	B265
Rasp	T321
Torch Head	T111

ACCESSORIES

- See Section A

CABLE SIZE (sq mm)	MOLD PART NO.	WELDING MATERIAL ¹
7/#10	V C 9A	65
7/#8	V C 9B	90
7/#7	V C 9C	90
7/#6	V C 9D	115
7/#5	V C 9E	115
19/#9	V C 9F	115
19/#8	V C 9G	150
19/#7	V C 9H	200
19/#6	V C 9J	200

¹For CADWELD PLUS add suffix "PLUSF20" (refer page 44)

Cable to Vertical Steel Pipe –

Use flat surface mold part number; add **V** and suffix.

Cable	Nominal Pipe Diameter Suffix	
7/#10 thru 19/#9	30" and smaller 32" and larger	Nominal Pipe Size None
Example: 7/#7 to 4" pipe, V C 9CV4		
Cable to horizontal steel pipe- Add H and nominal pipe size to flat surface mold number Example: 7/#8 to 8" pipe, V C 9BH8		

For Stranded Copper-Clad Steel Conductors

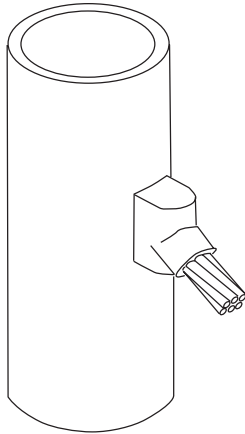

VS

RANGE OF VERTICAL PIPES

- Cable down at 45° to vertical steel surface including pipe.
- **A test weld should be made to check the possibility of burn through on thin sections or thin wall pipe.**
- When only one pipe size rather than a range sizes is involved, see Cable to Steel Pipe Table on previous page.
- Concentric stranded copper cable listed.
- **Bold letter** in mold part number is the price key.

REQUIRED TOOLS

	Part No.
Handle Clamps	
for C Price Key Molds	L160
for D Price Key Molds	L159
CADWELD PLUS Control Unit or Flint Ignitor	PLUSCU T320

SUGGESTED TOOLS

Cable Cleaning Brush	T313 or T314
Slag Removal Spade	
#65 w/m & smaller	B136A
#90 w/m & larger	B136B
Rasp	T321
Torch Head	T111
Mold Cleaning Brush	T394

ACCESSORIES

- See Section A

CABLE SIZE	NOMINAL PIPE SIZE	MOLD PART NO.	WELDING MATERIAL ¹
7/#10	1-1/2" to 4" Pipe	VSC9AV3C	45
	4" to 6" Pipe	VSC9AV5C	45
	6" to 10" Pipe	VSC9AV8C	45
	12" to 30" Pipe	VSC9AV21C	45
	32" Pipe or Larger	(2)	
7/#8	2" to 4" Pipe	VSC9BV3C	90
	4" to 6" Pipe	VSC9BV5C	90
	6" to 10" Pipe	VSC9BV8C	90
	12" to 30" Pipe	VSC9BV21C	90
	32" Pipe or Larger	(2)	

¹ For CADWELD PLUS add suffix "PLUSF20" (refer page 44)
 (2) Use flat surface mold part number. See previous page.

CABLE SIZE	NOMINAL PIPE SIZE	MOLD PART NO.	WELDING MATERIAL ¹
7/#7	2" to 4" Pipe	VSC9C3C	90
	4" to 6" Pipe	VSC9CV5C	90
	6" to 10" Pipe	VSC9CV8C	90
	12" to 30" Pipe	VSC9CV21C	90
	32" Pipe or Larger	(2)	
7/#6	2" to 4" Pipe	VSC9DV3C	115
	4" to 6" Pipe	VSC9DV5C	115
	6" to 10" Pipe	VSC9DV8C	115
	12" to 30" Pipe	VSC9DV21C	115
	32" Pipe or Larger	(2)	
7/#5	2" to 4" Pipe	VSC9EV3C	115
	4" to 6" Pipe	VSC9EV5C	115
	6" to 10" Pipe	VSC9EV8C	115
	12" to 30" Pipe	VSC9EV21C	115
	32" Pipe or Larger	(2)	

(2) Use flat surface mold part number. See previous page.

For Stranded Copper-Clad Steel Conductors

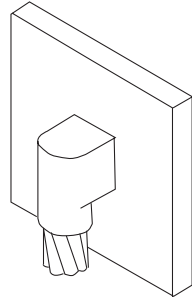

VB

Cable down to vertical steel surface

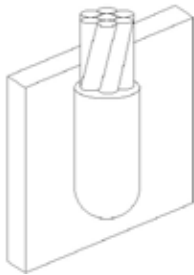

VF

Cable up to vertical steel surface

VERTICAL STEEL SURFACE

- Connection of vertical cable to vertical flat steel surface or to side of vertical or horizontal steel pipe.
- **A test weld should be made to check the possibility of burn through on thin sections or thin wall pipe.**
- Cable to steel pipe. Add pipe orientation and nominal pipe size to flat surface mold part number. Examples: VFC9CV6, 7/#7 conductor to vertical 6" pipe VFC9AH4, 7/#10 conductor to horizontal 4" pipe.
- Concentric stranded copper cable listed.
- **Bold letter** in mold part number is the price key.

REQUIRED TOOLS

		Part No.
Handle Clamps	for C Price Key Molds	L160
	for D Price Key Molds	L159
CADWELD PLUS Control Unit or Flint Ignitor		PLUSCU T320

SUGGESTED TOOLS

Cable Cleaning Brush	T313 or T314
Slag Removal Spade	B136A or B136B
Mold Cleaning Brush	T394
Rasp	T321
Torch Head	T111

ACCESSORIES

- See Section A

TYPE VB

CABLE SIZE (sq mm)	MOLD PART NO.	WELDING MATERIAL ¹
7/#10	VBC9A	65
7/#8	VBC9B	115
7/#7	VBC9C	115
7/#6	VBC9D	150
7/#5	VBC9E	150
19/#9	VBC9F	200
19/#8	VBC9G	200
19/#7	VBC9H	250
19/#6	VBR9J	2-150

TYPE VF

CABLE SIZE (sq mm)	MOLD PART NO.	WELDING MATERIAL ¹
7/#10	VFC9A	90
7/#8	VFC9B	150
7/#7	VFC9C	150
7/#6	VFR9D	200
7/#5	VFR9E	200
19/#9	VFR9F	200
19/#8	VFR9G	250
19/#7	VFF9H	2-150
19/#6	VFF9J	2-200

¹ For CADWELD PLUS add suffix "PLUSF20" (refer page 44)

For Stranded Copper-Clad Steel Conductors

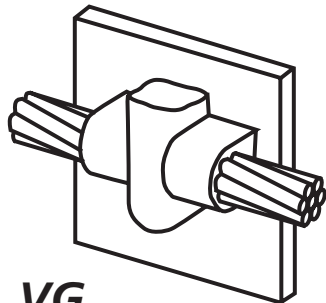

VG

Cable on surface

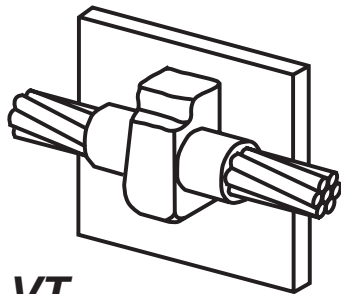

VT

Cable off surface

VERTICAL STEEL SURFACE

- CADWELD through connections to vertical flat steel surface; cable to vertical side of horizontal pipe (Type VG only); cable to vertical steel pipe (Type VT only).
- **A test weld should be made to check the possibility of burn through on thin sections or thin wall pipe.**
- Cable to steel pipe. Add nominal pipe size to flat surface mold part number. Examples: Horizontal Pipe, Use Type VG, add nominal pipe size suffix, for 7/#7 to 6 in. pipe, VGC9C6 for Vertical Pipe, Use Type VT, add nominal pipe size suffix, Example for 7/#8 to 4 in. pipe, VTC9B4.
- Concentric stranded copper cable listed.
- **Bold letter** in mold part number is the price key.

REQUIRED TOOLS

		Part No.
Handle Clamps	for C Price Key Molds	L160
	for D Price Key Molds	L159
CADWELD PLUS Control Unit or Flint Ignitor		PLUSCU T320

SUGGESTED TOOLS

Cable Cleaning Brush	T313 or T314
Slag Removal Spade	B136A or B136B
Mold Cleaning Brush	T394
Rasp	T321
Torch Head	T111

ACCESSORIES

- See Section A

TYPE VG		
CABLE SIZE (sq mm)	MOLD PART NO.	WELDING MATERIAL ¹
7/#10	VGC 9 A	65
7/#8	VGC 9 B	115
7/#7	VGC 9 C	115
19/#6	VGC 9 D	150
19/#5	VGC 9 E	150
19/#9	VGC 9 F	150

TYPE VT		
CABLE SIZE (sq mm)	MOLD PART NO.	WELDING MATERIAL ¹
7/#10	VTC 9 A	90
7/#8	VTC 9 B	115
7/#7	VTC 9 C	115
19/#6	VTC 9 D	150
19/#5	VTC 9 E	150
19/#9	VTC 9 F	150

¹For CADWELD PLUS add suffix "PLUSF20" (refer page 44)

For Stranded Copper-Clad Steel Conductors

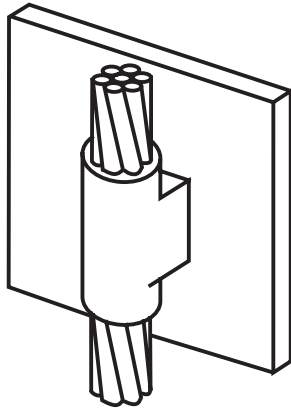

VV

VERTICAL STEEL SURFACE

- Through connections to vertical flat surface or to side of vertical or horizontal steel pipe.
- **A test weld should be made to check the possibility of burn through on thin sections or thin wall pipe.**
- Cable to steel pipe. Add pipe orientation and nominal pipe size to flat surface mold part number. Examples: VVR9CV6, 7/#7 conductor to vertical 6" pipe VVR9AH46, 7/#10 to horizontal 6" pipe.
- Concentric stranded copper cable listed.
- **Bold letter** in mold part number is the price key.

REQUIRED TOOLS

	Part No.
Handle Clamps	
for C Price Key Molds	L160
for D Price Key Molds	L159
CADWELD PLUS Control Unit or Flint Ignitor	PLUSCU T320

SUGGESTED TOOLS

Cable Cleaning Brush	T313 or T314
Slag Removal Spade	B136A or B136B
Mold Cleaning Brush	T394
Rasp	T321
Torch Head	T111

ACCESSORIES

- See Section A

CABLE SIZE (sq mm)	MOLD PART NO.	WELDING MATERIAL ¹
7/#10	VVC9A	115
7/#8	VVR9B	200
7/#7	VVR9C	200
7/#6	VVR9D	250
7/#5	VVR9E	250
19/#9	VVR9F	250

¹ For CADWELD PLUS add suffix "PLUSF20" (refer page 44)

For Stranded Copper-Clad Steel Conductors

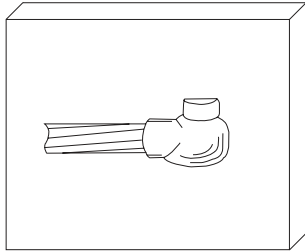

VN Cable on Flat Surface
Right hand shown - RH

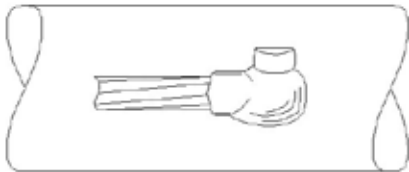

VN Cable on Pipe
Right hand shown - RH

VERTICAL STEEL SURFACE

- Conductor to vertical flat steel surface or cable to the side of horizontal steel pipe.
- **A test weld should be made to check the possibility of burn through on thin sections or thin wall pipe.**
- Cable to steel pipe. Add pipe orientation and nominal pipe size to flat surface mold part number. Example: VNC9CLH4 - weld on left end of conductor, #4 pipe, 7/#7 stranded conductor.
- Concentric stranded copper cable listed.
- **Bold letter** in mold part number is the price key.

REQUIRED TOOLS

	Part No.
Handle Clamps	
for C Price Key Molds	L160
for D Price Key Molds	L159
CADWELD PLUS Control Unit or Flint Ignitor	PLUSCU T320

SUGGESTED TOOLS

Cable Cleaning Brush	T313 or T314
Slag Removal Spade	B136A or B136B
Mold Cleaning Brush	T394
Rasp	T321
Torch Head	T111

ACCESSORIES

- See Section A

Cable to Horizontal Steel Pipe (Type VN) –

Use flat surface mold part number with suffix.

Cable	Nominal Pipe Size	Suffix
#1 and smaller	12" and smaller	Nominal Pipe Size
	14" and larger	None
1/0 thru 250	28" and smaller	Nominal Pipe Size
	30" and larger	None

Example: 2/0 cable to 4" pipe, VNC-2G-LH-4

CABLE SIZE (sq mm)	MOLD PART NO.	WELDING MATERIAL ¹
7/#10	VNC 9 A	65
7/#8	VNC 9 B	90
7/#7	VNC 9 C	90
7/#6	VNC 9 D	115
7/#5	VNC 9 E	115
19/#9	VNC 9 F	115

¹For CADWELD PLUS add suffix "PLUSF20" (refer page 44)

For Stranded Copper-Clad Steel Conductors

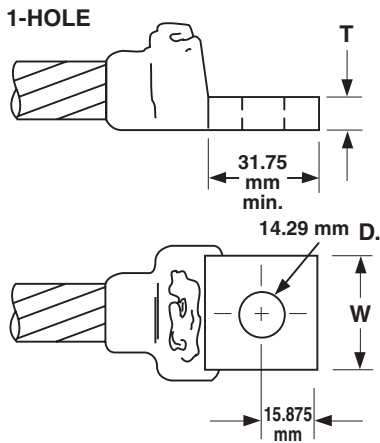
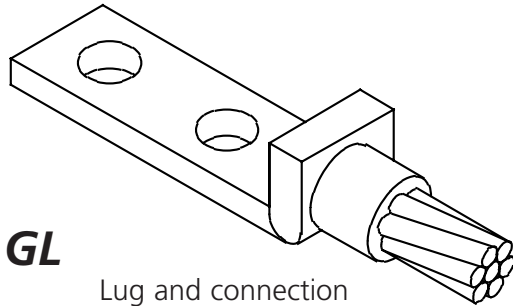

NEMA Drilled Lugs-B121 Series

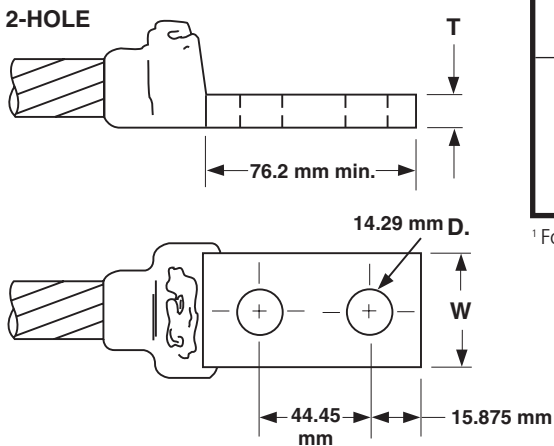

NEMA Drilled Lugs-B122 Series

COPPER LUGS

- Lugs and connections for equipment and structures. Ideal for power applications.
- Concentric stranded copper cable is listed.
- **Bold letter** in mold part number is the price key.

REQUIRED TOOLS

	Part No.
Handle Clamps	
for C Price Key Molds	L160
for D Price Key Molds	L159
CADWELD PLUS Control Unit or Flint Ignitor	PLUSCU T320

SUGGESTED TOOLS

Cable Cleaning Brush	T313 or T314
Slag Removal Spade	
#65 w/m & smaller	B136A
#90 w/m & larger	B136B
Mold Cleaning Brush	T394
Cable Clamp	B265
Torch Head	T111

ACCESSORIES

- See Section A

CABLE SIZE	MOLD NUMBER	WELDING MATERIAL ¹	LUG SIZE T X W	GL LUG NUMBER	
				1 HOLE	2 HOLES
7/#10	GL C CE9A	32	1/8 x 1	B121CE	B122-CE
7/#8	GL C CE9B	45	1/8 x 1	B121CE	B122-CE
7/#7	GL C CE9C	45	1/8 x 1	B121CE	B122-CE
7/#6	GL C CE9D	65	1/8 x 1	B121CE	B122-CE
7/#5	GL C DE9E	65	3/16 x 1	B121DE	B122-DE
19/#9	GL C DE9F	65	3/16 x 1	B121DE	B122DE
19/#8	GL C DE9G	90	3/16 x 1	B121DE	B122DE
19/#7	GL C DE9H	90	3/16 x 1	B121DE	B122DE
19/#6	GL C EE9J	115	1/4 x 1	B121EE	B122EE

¹For CADWELD PLUS add suffix "PLUSF20" (refer page 44)

All lugs are tin plated copper.

For Stranded Copper-Clad Steel Conductors

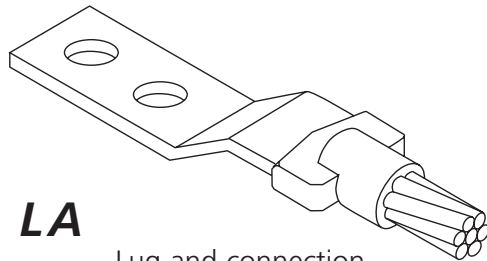

LA

Lug and connection

CABLE SIZE (sq mm)	BUS OR LUG SIZE (mm)	MOLD PART NUMBER	WELDING MATERIAL ¹
7/#10	3/16 x 1	LAC 9 ADE	65
7/#8	3/16 x 1	LAC 9 BDE	65
	1/4 x 1	LAC 9 BEE	65
7/#7	3/16 x 1	LAC 9 CDE	90
	1/4 x 1	LAC 9 CEE	90
7/#6	3/16 x 1	LAC 9 DDE	90
	1/4 x 1	LAC 9 DEE	90
	1/4 x 1-1/2	LAC 9 DEG	90
7/#5	3/16 x 1	LAC 9 EDE	90
	1/4 x 1	LAC 9 EEE	90
	1/4 x 1-1/2	LAC 9 EEG	90
19/#9	3/16 x 1	LAC 9 FDE	90
	1/4 x 1	LAC 9 FEE	90
	1/4 x 1-1/2	LAC 9 FEG	90
19/#8	1/4 x 1	LAC 9 GEE	115
	1/4 x 1-1/2	LAC 9 GEG	115
19/#7	1/4 x 1	LAC 9 HEE	150
	1/4 x 1-1/2	LAC 9 HEG	150
19/#6	1/4 x 1	LAC 9 JEE	200
	1/4 x 1-1/2	LAC 9 JEG	200

¹ For CADWELD PLUS add suffix "PLUSF20" (refer page 44)
See page 30 for Lugs.

COPPER LUGS (METRIC)

- Cable to lug and connections. Can be either field fabricated from copper busbar or factory-made lugs. Ideal for power applications. Connection must be made with cable and lug horizontal.
- Concentric stranded copper cable is listed.
- **Bold letter** in mold part number is the price key.

REQUIRED TOOLS

	Part No.
Handle Clamps	
for C Price Key Molds	L160
for D Price Key Molds	L159
CADWELD PLUS Control Unit or Flint Ignitor	PLUSCU T320

SUGGESTED TOOLS

Cable Cleaning Brush	T313 or T314
Slag Removal Spade	
#65 w/m & smaller	B136A
#90 w/m & larger	B136B
Mold Cleaning Brush	T394
Cable Clamp	B265
Torch Head	T111

ACCESSORIES

- See Section A

LUGS FOR TYPE LA LUG CONNECTIONS

NEMA lugs for Type LA connections are made from electrolytic grade copper bar stock to provide an efficient bolting surface for grounding applications. All listed lugs are tin plated.

For sizes not listed or for 45° or 90° lugs, contact Pentair or your local distributor or agent..

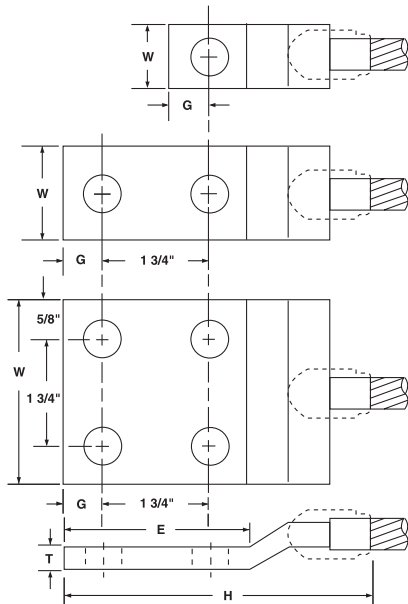

LA Offset Lug

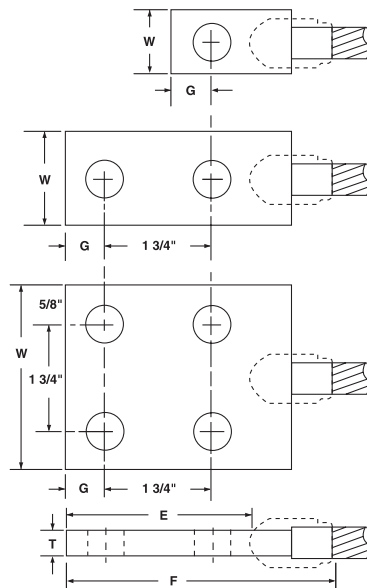

LA Straight Lug

LUG SIZE	NO. OF HOLES	BOLT SIZE	LA LUG PART NO.		DIMENSIONS IN INCHES						SIZE IN Kcmil
			STRAIGHT	OFFSET	T	W	G	E	F*	H*	
1/8 x 1	1	3/8	B101CE	B101CEOL	1/8	1	1/2	7/8	2-3/8	3-1/8	159
	2	1/2	B102CE	B102CEOL	1/8	1	5/8	3	4-1/2	5-1/4	159
3/16 x 1	1	1/2	B101DE	B101DEOL	3/16	1	9/16	1-1/8	2-7/8	3-5/8	239
	2	1/2	B102DE	B102DEOL	3/16	1	5/8	3	4-3/4	5-1/2	239
	2**	3/8		B103DEOL	3/16	1	7/16	1-7/8		4-3/8	239
1/4 x 1	1	1/2	B101EE	B101EEOL	1/4	1	5/8	1-1/8	3	3-5/8	318
	2	1/2	B102EE	B102EEOL	1/4	1	5/8	3	4-7/8	5-5/8	318
1/4 x 1-1/2	1	5/8	B101EG	B101EGOL	1/4	1-1/2	3/4	1-1/2	3	4-1/8	478
	2	1/2	B102EG	B102EGOL	1/4	1-1/2	5/8	3	4-7/8	5-5/8	478
1/4 x 2	2	1/2	B102EH	B102EHOL	1/4	2	5/8	3	5-1/4	6	637
3/8 x 1-1/2	1	5/8	B101GG	B101GGOL	3/8	1-1/2	3/4	1-1/2	3-3/4	4-3/4	716
	2	1/2	B102GG	B102GGOL	3/8	1-1/2	5/8	3	5-3/4	7	716
3/8 x 2	1	5/8	B101GH	B101GHOL	3/8	2	1	2-1/8	4-3/8	5-5/8	955
	2	1/2	B102GH	B102GHOL	3/8	2	5/8	3	5-3/4	7	955
1/2 x 2	2	1/2	B102JH	B102JHOL	1/2	2	5/8	3	5-3/4	7	1374
1/4 x 3	4	1/2	B104EK	B104EKOL	1/4	3	5/8	3	5-1/2	6-1/4	955
3/8 x 3	4	1/2	B104GK	B104GKOL	3/8	3	5/8	3	6	7	1432
1/2 x 3	4	1/2	B104JK	B104JKOL	1/2	3	5/8	3	6-1/4	7-1/4	1910

*Approximate

**Non-NEMA drillings. Two holes for 3/8" screws on 1" centers. For use with B1612Q CADWELD Ground Plate.

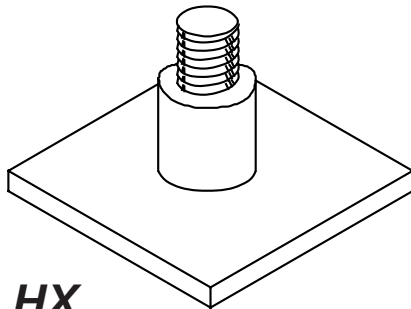

HX

Vertical stud to horizontal steel surface

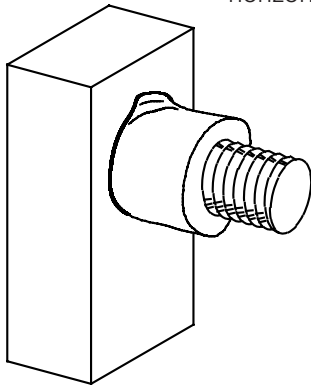

HV

Horizontal stud to horizontal steel surface

COPPER AND STEEL STUDS

- Connections of copper and steel studs to steel surfaces. Copper studs on grounded structures provide a convenient point of attachment of temporary protective ground clamps.
- **Bold letter** in mold part number is the price key.

REQUIRED TOOLS

		Part No.
Handle Clamps	for C Price Key Molds	L160
	for D Price Key Molds	L159
CADWELD PLUS Control Unit or Flint Ignitor		PLUSCU T320

SUGGESTED TOOLS

Mold Cleaning Brush	T394	
Rasp	T321	
Torch Head	T111	
Mold Scraper Tool	#65 w/m & smaller	B136A
	#90 w/m & larger	B136B

ACCESSORIES

- See Section A

Type HX Connections for Steel Surfaces Only

STEEL STUDS ONLY

STUD SIZE	MOLD PART NO.	TYPE HX WELD DIMENSIONS A (thickness)	B (diameter)	WELDING MATERIAL
1/4"	HXC10	3/8"	3/4"	25
5/16"	HXC11	3/8"	3/4"	25
3/8"	HXC12	9/16"	7/8"	45
1/2"	HXC14	5/8"	1-1/16"	65
3/4"	HXC18	5/8"	1-1/2"	150
1"	HXC22	15/16"	1-5/8"	2-150

Type HV Connections for Steel Surfaces only

COPPER* STUDS ONLY

STUD SIZE	MOLD PART NO.	WELDING MATERIAL
1/2"	HVC14CU	115
5/8"	HVC31CU	150
3/4"	HVC33CU	250
7/8"	HVD35CU	2-150
1"	HVD37CU	2-150

*or silicon bronze

Type HV Connections for Steel Surfaces Only

STEEL STUDS ONLY

STUD SIZE	MOLD PART NO.	TYPE HX WELD DIMENSIONS A (thickness)	B (diameter)	WELDING MATERIAL
1/4"	HVC10	3/8"	3/4"	25
5/16"	HVC11	3/8"	3/4"	25
3/8"	HVC12	9/16"	7/8"	45
1/2"	HVC14	5/8"	1-1/16"	65
3/4"	HVC18	5/8"	1-1/2"	150
1"	HVC22	15/16"	1-5/8"	250

SAFETY FIRST

Pentair recommends SAFETY FIRST when making CADWELD Connections.

We offer the following gloves and glasses as shown

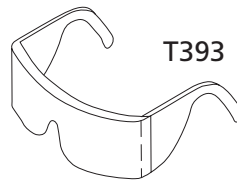

Safety Glasses

These glasses may be worn separately or over prescription glasses.

Gloves

Heavy canvas gloves with leather palms.

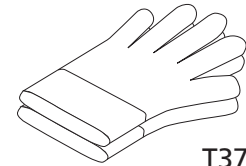

T378L

CADWELD WELDING MATERIAL

CADWELD Welding Material is a mixture of copper oxide and aluminum, packaged by size in plastic tubes. Each tube contains the starting material at the bottom of the plastic tube, with the Welding Material on top. These materials are not explosive and not subject to spontaneous ignition. These containers are packaged in boxes along with metal disks. Each weld uses one disk. Disks are included with the Welding Material.

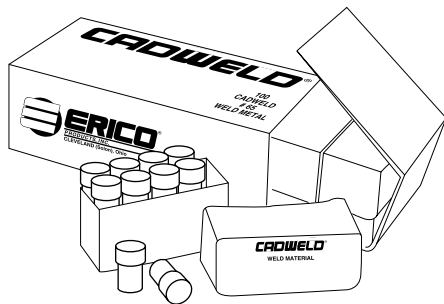

Five types of CADWELD Welding Materials are used for grounding connections:

1. F20 or standard Welding Material is used for all grounding connections with the exception of those to cast iron or to load bearing rail. The Standard Welding Material containers have clear (or natural) caps. Standard Welding Material is also used with most FX molds.
 2. XL Welding Material is used with CADWELD EXOLON molds. CADWELD EXOLON Welding Material containers have white caps.
 3. XF-19 Alloy Welding Material is used for all connections to cast iron such as Type HB and others. XF-19 Welding Material containers have orange caps.
- For DUCTILE IRON, see Section 3, Cast Iron Containers
4. CADWELD F80 Alloy Welding Material is used for all connections to load bearing rail such as Type W Bonds. F80 Welding Material containers have yellow caps.
 5. Cathodic connections require different welding material and molds. Contact Pentair or your local distributor or agent.

ADAPTING MOLDS TO FIT CONDUCTORS

Cables smaller than indicated on mold tag can be welded by using either Wrap Sleeve or Adapter Sleeves.

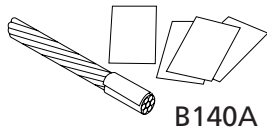

CADWELD Wrap Sleeve B140A

CADWELD Wrap Sleeve is wrapped around the cable until the diameter is about the same as the cable opening in the mold.



T403

CADWELD Mold Sealer

T403 CADWELD Mold Sealer is ideal for sealing hot or cold molds to retard leakage from large stranded conductors. It is required on certain molds such as Types HA, HB, HC, VG and VN. It prolongs useful mold life when the cable opening becomes worn.

It is available in a convenient 2 pound package.

CABLE AND WORK SURFACE PREPARATION

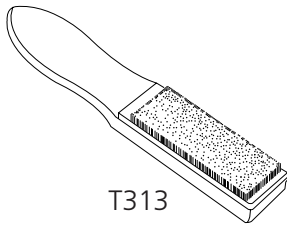

T313

Cable Cleaning Brushes

Two types of brushes are available to aid in removing oxides and cleaning copper surfaces. T313 Card Cloth Brush with short stiff bristles is generally preferred for cleaning concentric conductors and busbars, which are not heavily oxidized.

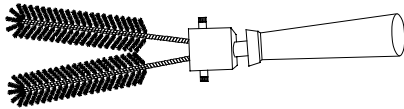

T314

T314 Cable Cleaning Brush

T314 Cable Cleaning Brush cleans any conductor and is especially useful for coarse or very dirty conductors. The brushes can be rotated to provide new cleaning bristles and are replaceable.

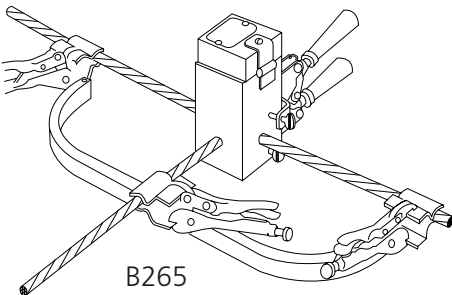

B265

Cable Clamp B265

The B265 Cable clamp should be used with hard drawn copper cable, CCS conductors or any cable under tension. Use of the clamp aids in preventing cable movement and prolongs mold life.

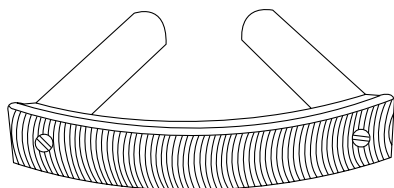

T321

Rasp

T321 rasp is used to remove rust from any steel surface or galvanizing from hot dipped galvanized steel to expose the bare steel for welding. The curved blade makes it an efficient tool for flat surfaces. T321A Replacement blades are also available.

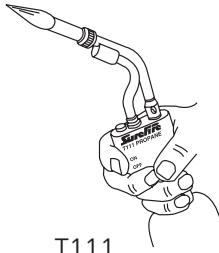

T111

Surefire™ Torch Head

T111 Self igniting propane torch head. Squeeze the control knob for an instant flame. Release and it's out. No flame adjusting. The burn tip remains cool during normal use. Operates on its side or upside down. Can withstand 60 MPH winds without flareout. Fits all standard 14 and 16 oz. propane cylinders.

SUREFIRE™ is a trademark of IPI

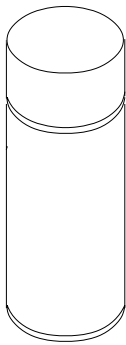

T372A

Galvanizing Touch-Up

Easy to use galvanizing paint in a spray can is used to touch up heat affected areas on galvanized steel surfaces after welding. The damage to the galvanizing is often minimal so the repair is often cosmetic. T372A galvanizing compound available in 12 ounce aerosol can.



T358

T358 Regalv

T358 Regalv is a 97% zinc rich organic coating which also can be used to repair galvanized surfaces. The brush is attached to the cap.

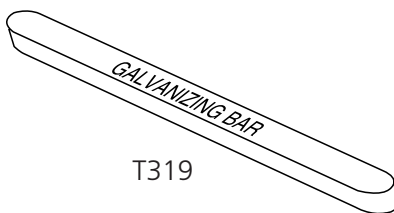

T319

Galvanizing Bar

T319 Galvanizing Bar is used to repair a galvanized surface that has been damaged by welding or drilling. This is a low temperature, self-fluxing material. Often there is sufficient heat after making the CADWELD Connection to melt the bar or a small torch may be used.

MOLD CARE AND USE

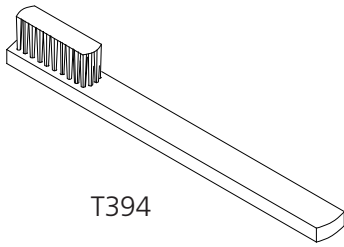

T394

Mold Cleaning Brush

Mold cleaning brush T394 is very useful for removing slag from molds – especially vertically split molds.

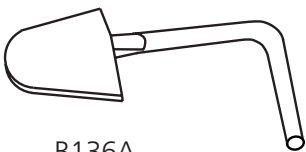

B136A
B136B

Slag Removal Spades

Slag Removal Spades are useful for removing the slag after making a CADWELD Connection – especially useful with horizontally split molds.

Slag Spade Part No.	Using Material Size
B-136-A	#65 & Smaller
B-136-B	#90 & Larger

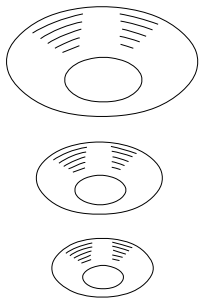

Disks

Each time a weld is made, a new disk is required. The disk sits on the bottom of the crucible. Its purpose is to hold the powdered welding material until the reaction takes place. The slag produced by the reaction rises to the surface and the molten copper settles to the bottom of the crucible where it melts the disk and melts through the conductors to produce a permanent molecular bond.

Disks are available in three sizes:

B117A used in molds using #15 thru #32 welding material (3/4" diameter).
 B117B used in molds using #45 thru #115 welding material (1" diameter).
 B117C used in molds using #150 thru #500 welding material (1-1/2" diameter).
 Disks are included with Welding Material and are not required for CADWELD PLUS.

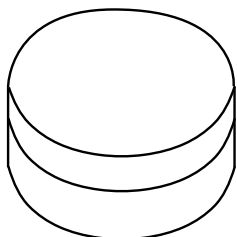

T328D

Disk Kit

A disk container (T328) which includes 20 of each of the three sizes of steel disks is available for your convenience. Kit P/N T328D.

CADWELD MOLDS

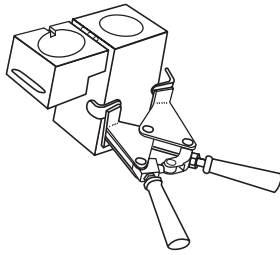

A semi-permanent graphite mold is used for making most CADWELD Connections. The mold controls the direction and speed of the molten CADWELD welding material flow and its final solidified shape. The graphite used in a CADWELD mold is a high temperature type that lasts for an average of 50 or more CADWELD connections under normal usage.

Wear Plates

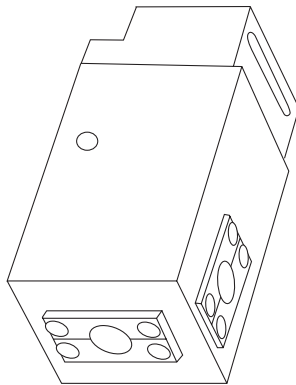

Wear Plates reduce mechanical abrasion of molds at cable entry points and help prevent leakage of molten metal (particularly on larger 7 strand conductor). These features prolong mold life.

Most CADWELD molds are available with factory mounted wear plates for the following sizes:

CCS conductors: 7/#10 thru 19/#6

Ground rods: 1/2" thru 1"

To order WEAR PLATES specify: Mold Part No. followed by the suffix "-W" i.e., TAC9F9FW.

Not available with types HA, HB, HC, LJ, certain PTs, & PCs, RR, VB, VF, VG VN, XA, CXBQ or XBZ.

Following are the number of Wear Plates (W.P.) used on the various types listed in this catalog.

TYPE	W.P.	TYPE	W.P.	TYPE	W.P.
GB	1	HT	2	RC	2
GB-GR	2	LA	1	RD	2
GB-GT	3	LE	2	SS	2
GL	1	LL	1*	TA	3
GR	2	PC	2**	VS	1
GT	3	PT	2**	VT	2
GY	3	RA	1	VV	1
HS	1	RB	2	XB	4

*Available only on molds for 2" and narrower bus size.

**Available only on mold for 7/#10 and larger run and tap.

Split Crucible Molds

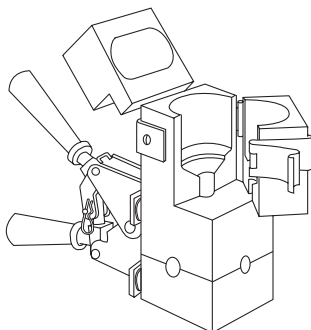

Molds made with a horizontal opening and solid crucible section may be specified as a SPLIT CRUCIBLE TYPE. The SPLIT CRUCIBLE MOLD allows for easier cleaning, but lead times are longer.

To order a SPLIT CRUCIBLE TYPE specify: Mold Part No. followed by the suffix "-L" i.e., TAC2Q2QL.

Available in Type TA, XA, XB, (C & D mold price only), LE and LJ connections.

MOLD FASTENING AND MOUNTING

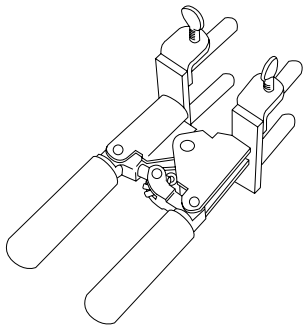

CADWELD Handle Clamps

Handle Clamps such as the one shown are required for most molds. Specialized frames with handles are used on some molds. Flint ignitors are included with all Handle Clamps. The following Handle Clamps are most widely used.

1. L160 for all molds having a "C", "E", "Q", or "R" mold price key. (3" wide molds)
2. L159 for all molds having a "D", "F", "J" or "Z" mold price key. (4" wide molds)

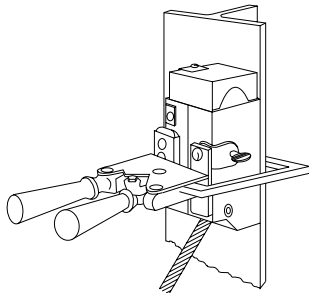

Vertical Surface Mold Support

The CADWELD mold can be securely held to a vertical "H" column or angle by using the Vertical Surface Mold Support. It is easily attached to an existing L159 or L160 Handle Clamp. For use with Types VB, VG, VN, and VS molds, fits steel up to 1" thick, for Type VF mold, 3/4" thick.

- B134: For use with L160 E-Z CHANGE Handle Clamp
- B135: For use with L159 E-Z CHANGE Handle Clamp

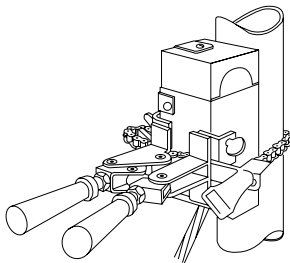

Chain Support Handle Clamps

The CADWELD mold can be securely held to a pipe using the clamp assembly consisting of a modified L159 or L160 Handle Clamp with built-in Pipe Attachment.

Clamp Part No.	Fits Mold Price	For Following Connection Types	Pipe
B159V	D & F	VS, VF, VB, & VV	Vertical
B160V	C & R	VS, VF, VB, & VV	Vertical
B159VT	D & F	VT	Vertical
B160VT	C & R	VT	Vertical
B159H	D & F	HA, HS, HC, & HT	Horizontal
B160H	C & R	HA, HS, HC, & HT	Horizontal

The above clamps are equipped with 20" length of chain which will fit up to 4" pipes. Extra 20" length of chain, B158, is available to fit up to 10" pipes.

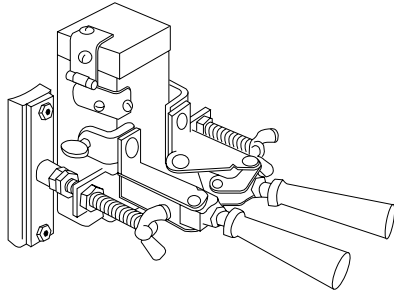

Magnetic Handle Clamps

The CADWELD mold can be securely held to a large flat or slightly curved vertical surface using the Handle Clamp with Magnetic Support. Used on vertically split molds.

Clamp Part No.	Fits Mold Price Key	Minimum Width Required*
B396	C & R Price Key	8"
B159M	D & F Price Key	10-1/2"
B399AM	T Price Key	6"
B399BM	P & N Price Key	7"

*Width will vary slightly depending upon the type of connection being made.

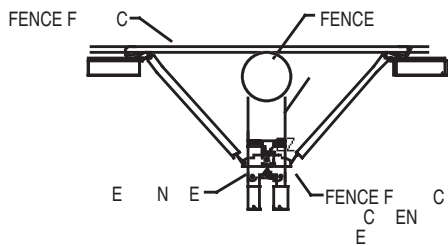

Fence Fabric Attachment Assembly

An easy to use, labor saving, Fence Fabric Attachment Assembly fastens to your existing L159 or L160 Handle Clamp to firmly hold your mold to the fence post after the fence fabric has been attached. Ideal for retrofit jobs.

Fence Fabric Attachment Part No.	Fits Handles
B827A	L160, L159

GROUND ROD SPECIALTY TOOLS



Ground Rod Drivers

Product #	Description
EGRD58	5' Driver body with insert for up to 5/8" ground rods
EGRD58I*	Replacement insert for 5/8" copper-bonded ground rods
EGRD34	5' Driver body with insert for up to 3/4" ground rods
EGRD34I*	Replacement insert for 3/4" copper-bonded ground rods and 5/8" galvanized ground rods

*Both 5/8" and 3/4" inserts fit standard body of EGRD58 or EGRD34.

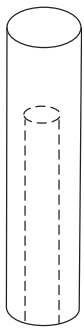

Ground Rod Driving Sleeves**

Use a CADWELD ground rod driving sleeve to prevent mushrooming top of ground rod.

Ground Rod Size	Part No.
1/2" Copper Bonded or Steel Rod	B137-14
5/8" Copper Bonded (.563" diameter)	B137-16
5/8" Steel (.625" diameter)	B137-31
3/4" Copper Bonded (.682" diameter)	B137-18
3/4" Steel (.750" diameter)	B137-33
1" Copper Bonded (.914" diameter)	B137-22
1" Steel (1.00" diameter)	B137-37

** For plain (unthreaded) ground rods only.

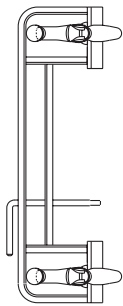

B120

Ground Rod Splice Clamp

The B120 Ground Rod Splice Clamp must be used to support the upper rod and provide a method of correctly positioning the rods and mold while splicing the rods. (Type HDGB and GB Connection).

OTHER TOOLS

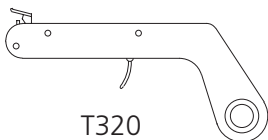

T320

Flint Ignitors

T320 CADWELD Flint Ignitors are used to ignite the starting material when making a CADWELD Connection. An ignitor is included with each Handle Clamp or frame. T320A Replacement Flints are also available.

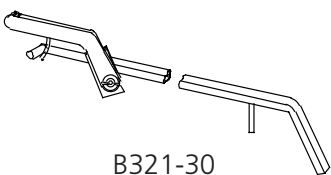

B321-30

Flint Ignitor Extension

B321-30 Flint Ignitor Extension attaches to the T320 Flint Ignitor and allows the installer to be about 30" from the mold. Ideal for such operations where the mold is in a narrow trench and the installer is at ground level.

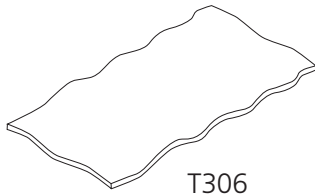

Ceramic Blanket

The woven Ceramic Blanket (Part T306) can be used to hold a hot mold or keep the work surface free of slag when cleaning the mold.

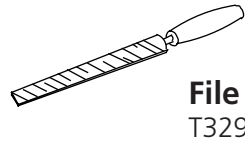

Screwdriver T305

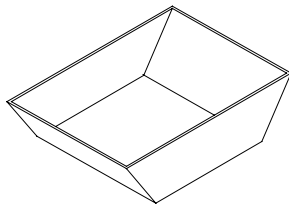
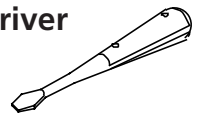

Welding Tray

The Welding Tray (Part No. XLB974-B2) can contain a spill of molten welding material. It is for personnel safety. Recommended when working overhead or over expensive equipment.

TOOL KITS

Tool Box T396

A tool box is highly recommended to carry tools, molds, welding material and a propane torch.

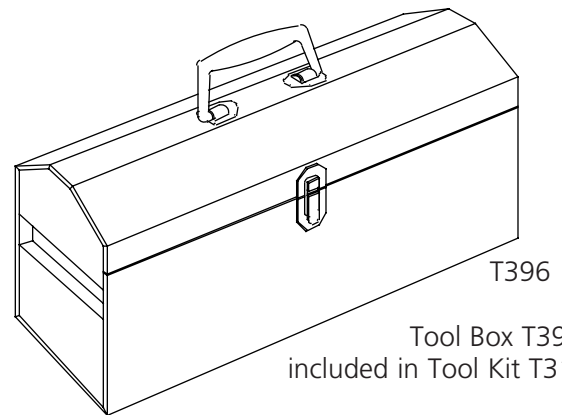

Tool Box T396 is included in Tool Kit T315A

Tool Kit T315A

Other Tool Kits can be made for your particular requirements.

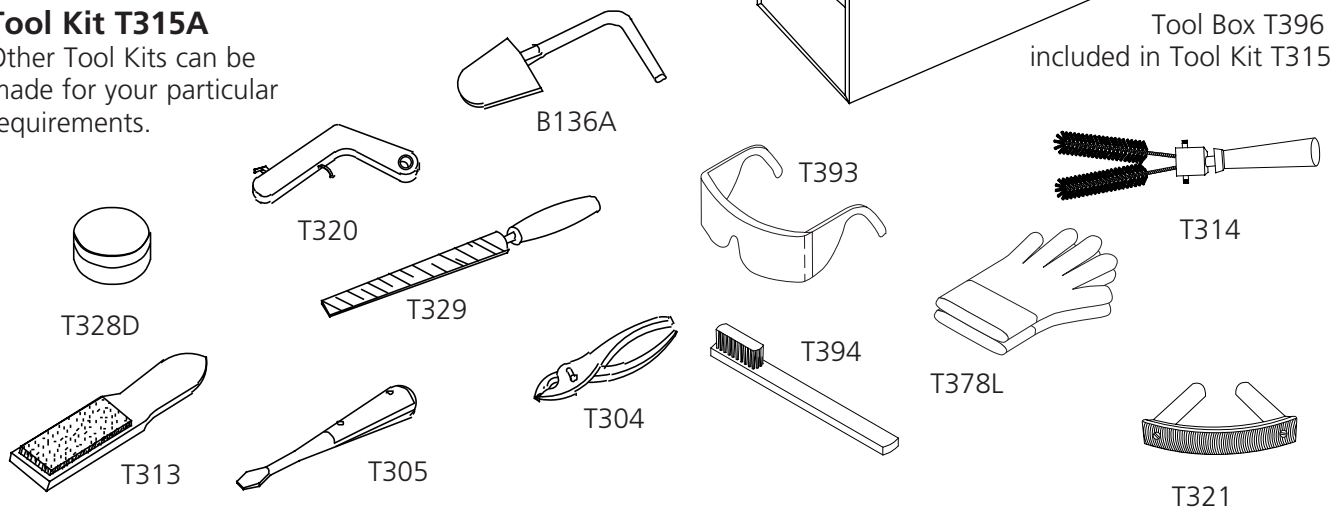

TOOL TRAY

Tool Tray Only: T331

Ideal for carrying one or two molds, welding material, propane torch and tools.

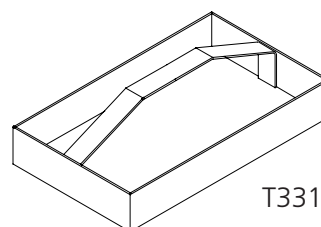

Tool Tray T331 is not included in Tool Kit T315A

Ground System Testers

EST Series

Product #	Description
EST3640	2-pole and 3-pole ground/earth resistance measurements, 10mΩ to 1999Ω
EST4610	2-, 3- and 4-point soil resistance measurements, 10mΩ to 1999Ω
EST4630	2-, 3- and 4-point measurements, rechargeable 9.6V NiMH battery pack and durable case
EST6472	3- and 4-point measurements up to 99,000Ω, uses 2-clamp method (selective ground testing), frequency scan from 40 to 5078Hz for optimum test accuracy in electrically noisy environments, automatic calculation of Rho
ESR182	Clamp-on probe for use with EST6472
EST401	Clamp-on ground resistance tester
ESTREELKIT500	Set of two 500-ft test leads on heavy duty insulated thermoplastic 11" diameter reels with integral carrying handle, ideal for three point fall-of-potential measurements at large sites, cranks for fast test lead retrieval



EST3640



EST4610



EST4630



EST6472

EST401



The EST401 clamp-on ground resistance tester measures ground rod and small grid resistance without the use of auxiliary ground rods. The EST401 can be used in multi-grounded systems without disconnecting the ground under test. By performing measurements on intact ground systems, the user can measure the resistance to ground and verify the continuity of the grounding connections and bonds. With the current management function, the EST401 is ideal for measuring ground current at pole ground rods, service entrances, pad-mounted transformers, transmission towers and service panels.

CADWELD PLUS

The CADWELD PLUS system:

- Consists of a tamper proof, disposable, moisture-resistant welding material cup. The welding material, disk and ignition source are incorporated into the self-contained package
- Long shelf life
- Completes welds at distances of up to 6 ft/1.8 meters (up to 15 ft/4.6 meters with optional lead)
- Requires minimum components – no starting material, no disks, no flint igniters
- Easy to handle, store and transport – by air, land or sea in unlimited quantities
- Reduces installation time
- Has color-coded welding material containers – by size and alloy type – for easy identification
- Has electronic ignition with a CE/UL battery powered controller box that is designed for 600 connections with one set of 8 standard AA batteries (included) – requiring no special batteries or chargers
- Designed for use in standard CADWELD molds including CADWELD MULTI

**Proven Safety and
Proven Performance
with No Equal**

Installation is Easy!

4 Simple Steps For Permanently Welded Electrical Connections

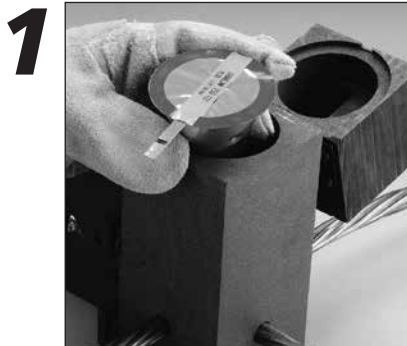

Insert CADWELD PLUS package into mold (may require use of a cover/baffle)



Attach control unit termination clip to ignition strip



Press and hold control unit switch and wait for the ignition



Open the mold and remove the expended steel cup – no special disposal required

CADWELD PLUS Control Unit initiates the reaction of the metal crucible. The standard unit includes a 6-foot (1.8 meter) high temperature control unit lead. The lead attaches to the ignition strip using a custom made, purpose-designed termination clip.

After the termination clip is installed on the ignition strip, the installer pushes and holds the ignition button to start a charging and discharging sequence. Within a few seconds the control unit sends a predetermined voltage to the ignition strip and the reaction is initiated.

CADWELD PLUS

CADWELD PLUS uses the following color codes and general product nomenclature:



CADWELD PLUS for Grounding Applications

Traditional Welding Material Part Number (Clear Cap)	CADWELD PLUS Part Number	European Article Number	Size Identification Ring Color
15	15PLUSF20	165700	Black
25	25PLUSF20	165701	Red
32	32PLUSF20	165702	White
45	45PLUSF20	165703	Light Blue
65	65PLUSF20	165704	Dark Green
90	90PLUSF20	165705	Gray
115	115PLUSF20	165706	Orange
150	150PLUSF20	165707	Dark Blue
200	200PLUSF20	165708	Yellow
250	250PLUSF20	165709	Purple
use 2 x 150	300PLUSF20	165710	Light Green
use 2 x 200	400PLUSF20	165711	Brown
500	500PLUSF20	165712	Light Brown



PLUSCU



PLUSCULD

Accessories

Part Number	European Article Number	Description
PLUSCU	165738	CADWELD PLUS Control Unit with plug-in, replaceable lead
PLUSCU15L	165745	CADWELD PLUS Control Unit with 15 ft. (4.6 m) plug-in, replaceable lead
MC2X2KIT	165740	Kit, Baffle Cover, Graphite - 2" X 2" Mold
MC25X3KIT	165744	Kit, Baffle Cover, Graphite - 2½" X 3" Mold
MC3X3KIT	165741	Kit, Baffle Cover, Graphite - 3" X 3" Mold
MC4X4KIT	165742	Kit, Baffle Cover, Graphite - 4" X 4" Mold
PLUSCULDQC	PLUSCULDQC	Plug-in, Replacement Lead, 6 ft. (1.8 m)
PLUSCULD15QC	PLUSCULD15QC	Plug-in, Replacement Lead, 15 ft. (4.6 m)

Gram weight PLUS weld metal type i.e. 45PLUSF20

CADWELD PLUS Patent Numbers 6,553,911 6,703,578

Technical Information

COPPER-CLAD STEEL CONDUCTORS

CADWELD Cable Code	Cable Stranding	Nominal Dia. (inches)	Cross Sectional Area (kcmil)
7Y	3/#10	.220	31.15
7X	3/#9 CW	.247	39.28
9Y	3/#8 CW	.277	49.53
9A	7/#10 CW	.306	72.68
9X	3/#7 CW	.311	62.45
9T	7/#9 CW	.343	91.65
9W	3/#6 CW	.349	78.75
9B	7/#8 CW	.385	115.60
9V	3/#5 CW	.392	99.31
9C	7/#7 CW	.433	145.70
9D	7/#6 CW	.486	183.80
9E	7/#5 CW	.546	231.71
9F	19/#9 CW	.572	248.80
9L	7/#4 CW	.613	292.20
9G	19/#8 CW	.642	313.70
9H	19/#7 CW	.721	395.50
7W	37/#9 CW	.801	484.40
9J	19/#6 CW	.810	498.80
7V	37/#8 CW	.899	610.90
9K	19/#5 CW	.910	628.90
9M	37/#7 CW	1.010	770.30

GROUND RODS

Nominal Size	Material	Type	Thread Size	Rod Diameter	CADWELD Ground Rod Code
1/2"	Copper-bonded Steel*	Sectional	9/16"	.505	14
		Plain	–	.500	14
	Copper-bonded	Plain	–	.475	15
	Copper-bonded	Sectional	1/2"	.447	13
5/8"	Copper-bonded Steel*	Sectional	5/8"	.563	16
		Plain	–	.625	31
	Galvanized Steel**	Plain	–	.631	31
	Copper-bonded	Plain	–	.563	16
3/4"	Copper-bonded Steel*	Sectional	3/4"	.682	18
		Plain	–	.750	33
	Copper-bonded	Plain	–	.682	18
1"	Copper-bonded Steel*	Sectional	1"	.914	22
		Plain	–	1.00	37
	Copper-bonded	Plain	–	.914	22

* Plain steel, stainless steel and stainless steel clad rods.

** Manufactured in accordance with NEMA GR-1.

Technical Information

BARE CLASS A, B, AND C CONCENTRIC STRANDED CONDUCTOR

Based on A.S.T.M. Standard Specifications.

CADWELD Cable code	Size in Circular mils	Size A.W.G.	Conductor Dia. In.	NUMBER OF WIRES / Strand Dia. Inches				
				7	19	37	61	91
4Y	1,000,000		1.152			.1644*	.1280	.1048
4Q	800,000		1.031			.1470*	.1145	.0938
4L	750,000		.998			.1424*	.1109	.0908
4G	700,000		.964			.1375*	.1071	.0877
3X	600,000		.893			.1273	.0992	.0812
3Q	500,000		.813		.1622*	.1162	.0905	
3H	400,000		.728		.1451	.1040	.0810	
3D	350,000		.681		.1357	.0973	.0757	
3A	300,000		.630		.1257	.0900	.0701	
2V	250,000		.575		.1147	.0822	.0640	
2Q	211,600	4/0	.528	.1739	.1055	.0756		
2L	167,800	3/0	.470	.1548	.0940	.0673		
2G	133,100	2/0	.419	.1379	.0837	.0600		
2C	105,500	1/0	.373	.1228	.0745	.0534		
1Y	83,690	1	.332	.1093	.0664	.0476		
1V	66,370	2	.292	.0974	.0591			
1Q	52,630	3	.260	.0867	.0526			
1L	41,740	4	.232	.0772	.0469			
1H	26,240	6	.184	.0612	.0372			
1E	16,510	8	.146	.0486	.0295			
1B	10,380	10	.116	.0385	.0234			
	6,530	12	.092	.0305	.0185			
	4,110	14	.073	.0242	.0147			

* Class AA

BARE SOLID COPPER WIRE

Based on A.S.T.M. Standard Specifications

CADWELD Cable code	Size A.W.G.	Cross Sectional Area Circular Mils	Wire Dia. In.
2P	4/0	211,600	.4600
2K	3/0	167,800	.4096
2F	2/0	133,100	.3648
2B	1/0	105,500	.3249
1X	1	83,690	.2893
1T	2	66,370	.2576
1P	3	52,630	.2294
1K	4	41,740	.2043
1G	6	26,250	.1620
1D	8	16,510	.1285
1A	10	10,380	.1019
	12	6,530	.0808
	14	4,110	.0664

Technical Information

RECTANGULAR COPPER BUSBAR

CADWELD Busbar Code	Thickness Inches	Width Inches	Circular Mil Size	Weight Lbs. per Foot
CE CG CH	1/8	1	159,200	.484
		1-1/2	238,700	.726
		2	318,300	.969
DE DH	3/16	1	238,700	.727
		2	477,500	1.45
EE EG EH EK EM	1/4	1	318,300	.969
		1-1/2	477,500	1.45
		2	636,600	1.94
		3	954,900	2.91
		4	1,273,000	3.88
GE GG GH GK GM	3/8	1	477,500	1.45
		1-1/2	716,200	2.18
		2	954,900	2.91
		3	1,432,000	4.36
		4	1,910,000	5.81
JH	1/2	2	1,273,000	3.88
JK		3	1,910,000	5.81
JM		4	2,546,000	7.75

CAST IRON PIPE – CLASS A THRU D

AWWA Specification 1908,
ASA A21.2 Class 100-250.

Nominal Size (Inches)	Actual O.D. (Inches)
4	4.80 to 5.00
6	6.90 to 7.10
8	9.05 to 9.30
10	11.10 to 11.40
12	13.20 to 13.50
14	15.30 to 15.70
16	17.40 to 17.80
18	19.50 to 19.90
20	21.60 to 22.1
24	25.80 to 26.30
30	31.70 to 32.70
36	38.00 to 39.20
42	44.20 to 45.60
48	50.50 to 52.00
54	56.70 to 58.40
60	62.80 to 64.80
72	75.30 to 76.90
84	87.50 to 88.50

Other Standard Sections used for Fence Posts

Section	CADWELD Mold Code
1-1/2" square	PS15
2" square	PS20
2-1/2" square	PS25
3" square	PS30*
1.875 x 1.625 x .133 "H"	PH1
2.25 x 1.95 x .143 "H"	PH2

* For D or F mold price only

Technical Information

STANDARD STEEL WIRE GAGE

(WASHBURN MOEN GAGE) SOLID

Gage No.	Dia. Inches	Gage No.	Diameter Inches
7/0	.4900	6	.1920
6/0	.4615	7	.1770
5/0	.4305	8	.1620
4/0	.3938	9	.1483
3/0	.3625	10	.1350
2/0	.3310	11	.1205
1/0	.3065	12	.1055
1	.2830	13	.0915
2	.2625	14	.0800
3	.2437	15	.0720
4	.2253	16	.0625
5	.2070	17	.0540

STEEL PIPE SIZES











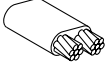

STANDARD WEIGHT
(SCHEDULE 40)

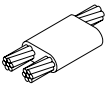

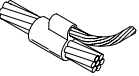

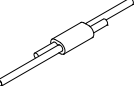
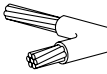
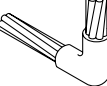
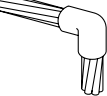
ASTM A53-90-B
ANSI/ASME B36.10M-1985

Nominal Size In	O.D. Inches	Wall Thickness Inches	CADWELD Mold Code
1	1.315	.133	1
1-1/4	1.660	.140	1.25
1-1/2	1.900	.145	1.50
2	2.375	.154	2
2-1/2	2.875	.203	2.50
3	3.500	.216	3
3-1/2	4.000	.226	3.50
4	4.500	.237	4
5	5.563	.258	5
6	6.625	.280	6
8	8.625	.322	8
10	10.750	.365	10

Other Cable to Cable Connections

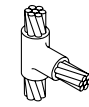

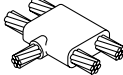
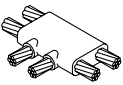
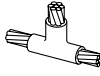
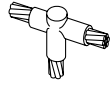
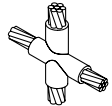
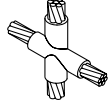
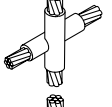
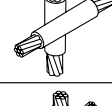

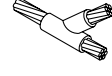
The connections shown below are for use only where connections shown in this catalog are not suitable.





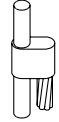
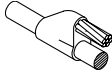
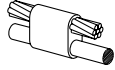
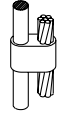
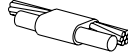



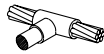
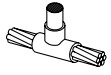

NAME	TYPE	EASE	SPLIT	
Parallel dead end	PJ		1	V
	PK		2	*
	PM		3	V
	PN		3	V
Parallel Tap	PH		3	V
	PA		2	*
	PB		3	V
	PC		1	V
	PD		3	V
	PG		1	V
Splice	PP		1	*
	PQ		3	V
	PR		2	V
	SC		1	*
	SD		3	V
	SE		3	V
	SV		3	V

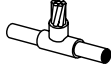
NAME	TYPE	EASE	SPLIT	
Tee	TC		3	V
	TD		3	*
	TE		3	*
	TF		3	V
	TL		3	V
	TV		3	V
X vertical (horizontal cable uncut)	XC		3	V
X vertical (vertical cable uncut)	XD		3	V
X vertical (neither cable cut)	XF		3	*
X vertical (neither cable cut)	XG		3	*
X - 45° tap	YC		3	V
	YD		3	V
	YE		3	V

Other Cable to Ground Rods or Other Connections

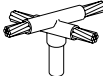

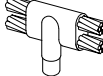







The connections shown below are for use only where connections shown in this catalog are not suitable.



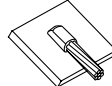
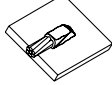
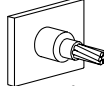

NAME	TYPE	EASE	SPLIT	
Parallel tap	GQ		3	V
	GS		1	V
Parallel thru	DQ		1	V
	GP		3	V
	GW		1	V
Splice	GD		3	V
	GE		1	V
	GF		1	V
	GV		1	V

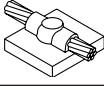
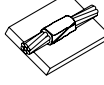
NAME	TYPE	EASE	SPLIT	
Tee	GG		1	*
	GH		3	V
	GJ		1	*
	GK		3	V
	GM		2	V
	GN		2	V
	GX		3	V
	NB		4	*
	NC		1	V
	ND		1	V
	Y - 45° tap	VW		2

Other Cable to Steel or Cast Iron Connections

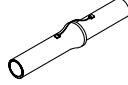
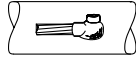
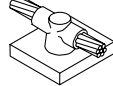
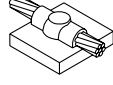

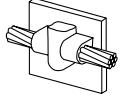
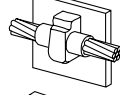







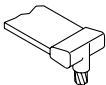



The connections shown below are for use only where connections shown in this catalog are not suitable.





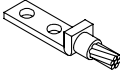



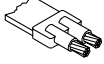
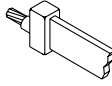
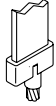

NAME	TYPE	EASE	SPLIT
Tap cast iron	VH 	1	V
	VJ 	1	V
	VK 	1	V
	VR 	1	V
Tap steel	HF 	1	*
	HG 	2	*
	VA 	1	V
	VC 	1	V
	VE 	2	V
	VL 	1	V
	Thru cast iron	HE 	1
Thru steel	HJ 	2	*
	HK 	1	V
	VX 	2	V

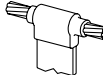
NAME	TYPE	EASE	SPLIT
Pipe	HB 	1	*
	VN 	1	*
Other connections to steel	HC 	1	*
	HT 	1	V
	VF 	1	V
	VB 	2	V
	VG 	1	V
	VT 	1	
	VV 	1	V

Other Cable to Busbar or Lug Connections



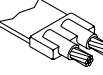

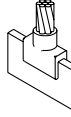

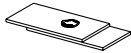
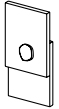
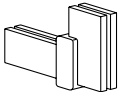
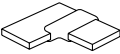

The connections shown below are for use only where connections shown in this catalog are not suitable.

NAME	TYPE	EASE	SPLIT	
EII	DN		2	V
	LX		2	*
	LY		3	*
	MA		2	*
	MB		3	*
	MC		3	*
	MD		3	*
	ME		2	*
	MF		3	*
	MG		2	V
Lug	PL		1	V
Parallel tap	LV		1	V
Parallel thru	LW		1	V
Splice	DM		2	*
	DS		2	*
	LB		1	V
	LC		3	V

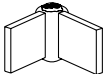
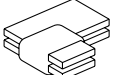
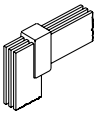
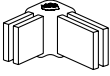
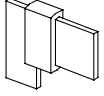
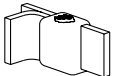
NAME	TYPE	EASE	SPLIT		
Splice	LD		3	V	
	LF		3	*	
	LG		3	V	
	LH		3	*	
	LK		2	V	
	LL		1	V	
	LM		1	V	
	LN		4	*	
	LP		2	*	
	LS		2	*	
	LT		2	*	
	LQ		2	V	
	Tee	LR		2	*



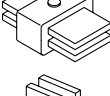



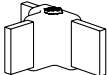
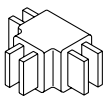
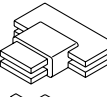
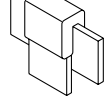
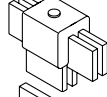
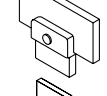
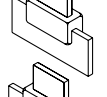
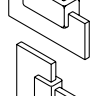
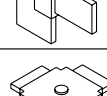
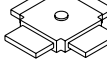
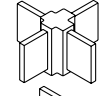
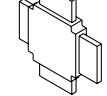

Other Busbar to Busbar Connections

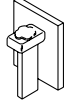
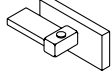
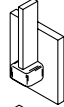
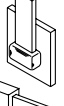
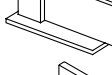
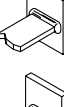

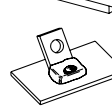
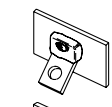

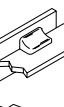
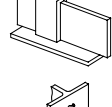
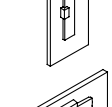

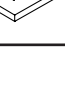

The connections shown below are for use only where connections shown in this catalog are not suitable.

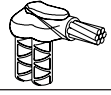
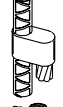
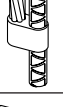
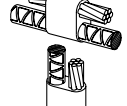
NAME	TYPE	EASE	SPLIT	
Button-weld	TW		1	*
	TX		1	V
EII	DJ		4	V
	EN		2	*
	EQ		4	V
	ER		2	*
	ES		3	*
	ET		2	V
	EV		3	*
	EP		1	V
Parallel tap	BJ		2	V
Splice	BC		3	V
	BD		3	*
	BF		2	*
	BG		2	*
	BH		4	V

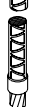
NAME	TYPE	EASE	SPLIT	
Tee	BK		2	*
	BL		3	*
	BN		3	*
	BR		2	V
	BS		2	V
	BT		4	*
	BV		3	*
	DE		3	V
	EE		3	V
	X	EA		4
EC			4	*
ED			4	V

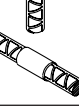

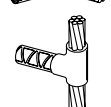
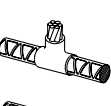
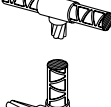
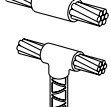
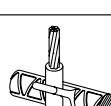
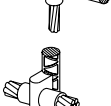



Other Busbar Connections / Other Rebar Connections



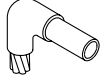
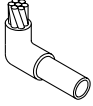

NAME	TYPE	EASE	SPLIT	
Tap	BX		3	V
	BY		3	V
	CA		3	V
	CB		2	V
	CJ		2	V
	DC		3	*
	DD		3	V
	DF		2	V
	HL		1	V
	HM		1	V
	HN		1	*
	Thru	CD		3
CK			2	V
CF			1	V
CC			1	V
CH			1	V

NAME	TYPE	EASE	SPLIT	
EII	DT		2	V
Parallel tap	DR		2	V
	RV		2	V
Parallel thru	RT		2	V
	RW		2	V
Splice	RE		2	V
	RF		2	V
	RG		1	V
	SF		2	V
	SR		1	V
	Tee	RH		1
RK			1	*
RL			2	V
RM			2	V
RN			2	V
RP			2	V
RQ			2	V
X		XJ		1
	RC		1	V

Cable to Copper Tube Connections

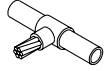
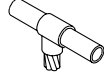
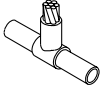
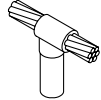

The connections shown below are for use only where connections shown in this catalog are not suitable.

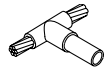

NAME	TYPE	EASE	SPLIT	
EII	DP		1	*
	MV		2	V
	MW		3	V
	MX		2	V
	MY		3	V
Splice	MH		1	V
	MJ		3	V
	MK		3	V

NAME	TYPE	EASE	SPLIT	
Tee	ML		1	*
	MM		3	*
	MP		3	*
	MQ		3	*
	MR		3	*
	MS		3	*
	MT		3	*
	NA		1	*

Busbar to Ground Rods Connections

The connections shown below are for use only where connections shown in this catalog are not suitable.

NAME	TYPE	EASE	SPLIT	
EII	CL		1	V
Tee	CM		3	V

NAME	TYPE	EASE	SPLIT	
Splice	CS		3	V
Tee	CQ		3	V
	CR		1	V

Copper Tube to Ground Rods Connections



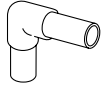

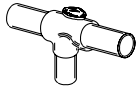
The connections shown below are for use only where connections shown in this catalog are not suitable.

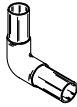

NAME	TYPE	EASE	SPLIT
EII	FT 	1	V

NAME	TYPE	EASE	SPLIT
Tee	FV 	1	V

Copper Tube to Copper Tube Connections

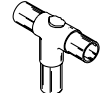
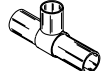
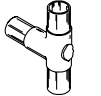
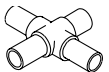

The connections shown below are for use only where connections shown in this catalog are not suitable.

NAME	TYPE	EASE	SPLIT
EII	FK 	1	*
	FL 	3	V
	FM 	2	V
Splice	FD1 	V	
	FE 	3	V

NAME	TYPE	EASE	SPLIT
Tee	FH 	3	V
	FF 	1	*
	FG 	2	V
	FH 	3	V
	FJ 	3	V
X	XT 	4	*

Copper Tube to Busbar or Lugs Connections

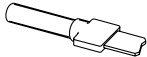
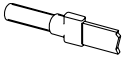
The connections shown below are for use only where connections shown in this catalog are not suitable.

NAME	TYPE	EASE	SPLIT
Splice	FN 	1	*
	FP 	1	V
Tee	EW 	2	V

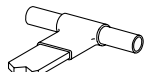
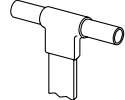
NAME	TYPE	EASE	SPLIT
Tee	FR 	2	*
	FS 	1	V

ELECTRICAL GROUNDING and BONDING

Molds & Welding Material

CADWELD EXOLON – Low Emission
CADWELD ONE-SHOT – Disposable Molds
Lugs, Tools & Accessories

Ground Rods & Accessories

Chemical Ground Rods
Ground Clamps
Ground Plate Electrodes
Ground Rod Couplings
Ground Rod Drivers
Ground Rods – Copperbonded
Galvanized, Stainless Steel

Bonding Products

Aircraft Ground Receptacles
Bonding Jumpers
Equipment Ground Plates
Equipotential Mesh
Fence & Gate Bonds
Grounding & Bonding Bars
Perimeter Busbars
Personnel Safety Mats
Split Bolts
SRG - Signal Reference Grids
Static Bonding Products
Switch Handle Bonds
TIA / EIA Ground Bars
Water-Pipe Clamps

Miscellaneous Grounding Products

Ground Enhancement Material (GEM)
Ground Inspection Wells
Ground Test Instruments
Grounding Conductor

LIGHTNING PROTECTION

Lightning Protection Products

ERICO SYSTEM 2000
– Conventional Lightning Protection
ERICO SYSTEM 3000
– Active Lightning Protection
Lightning Warning System
Industrial Stack Protection
Support Equipment
Air Terminals, Bases, Conductors, Masts
Fasteners & Fittings

SURGE PROTECTION

Surge Protection Products

Service Entrance
OEM Protection Components
Data & Signal Line Protection
Load Cell Protection
Branch Panel
Complete Home Protectors
Telecommunication Shelter Protection
Automation & Control Protection



www.erico.pentair.com



AUSTRALIA
Phone 1-800-263-508
Fax 1-800-423-091

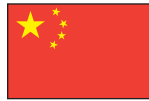

CHINA
Phone +86-21-3430-4878
Fax +86-21-5831-8177



HUNGARY
Phone 06-800-16538
Fax +39-0244-386-107



NORWAY
Phone 800-100-73
Fax 800-100-66



SWITZERLAND
Phone 0800-55-86-97
Fax 0800-55-96-15



BELGIUM
Phone 0800-757-48
Fax 0800-757-60



DENMARK
Phone 808-89-372
Fax 808-89-373



INDONESIA
Phone +62-21-575-0941
Fax +62-21-575-0942



POLAND
Phone +48-71-349-04-60
Fax +48-71-349-04-61



THAILAND
Phone +66-2-267-5776
Fax +66-2-636-6988



BRAZIL
Phone +55-11-3623-4333
Fax +55-11-3621-4066



FRANCE
Phone 0-800-901-793
Fax 0-800-902-024



ITALY
Phone 800-870-938
Fax 800-873-935



SINGAPORE
Phone +65-6-268-3433
Fax +65-6-268-1389



UNITED ARAB EMIRATES
Phone +971-4-881-7250
Fax +971-4-881-7270



CANADA
Phone +1-800-677-9089
Fax +1-800-677-8131



GERMANY
Phone 0-800-189-0272
Fax 0-800-189-0274



MEXICO
Phone +52-55-5260-5991
Fax +52-55-5260-3310



SPAIN
Phone 900-993-154
Fax 900-807-333



UNITED KINGDOM
Phone 0808-2344-670
Fax 0808-2344-676



CHILE
Phone +56-2-370-2908
Fax +56-2-369-5657



HONG KONG
Phone +852-2764-8808
Fax +852-2764-4486



NETHERLANDS
Phone 0800-0200-135
Fax 0800-0200-136



SWEDEN
Phone 020-790-908
Fax 020-798-964



UNITED STATES
Phone 1-800-753-9221
Fax +1-440-248-0723

AutoCad is a registered trademark of Autodesk, Inc.
Copperweld is a registered trademark of Copperweld Corporation
IEEE is a registered trademark of The Institute of Electrical and Electronics Engineers, Inc.
NEC is a registered trademark of National Fire Protection Association, Inc.
NEMA is a registered trademark of National Electrical Manufacturers Association
Surefire is a registered trademark of Newell-Rubbermade Company

© 2009, 2015 Pentair All Rights Reserved
Pentair, CADDY, CADWELD, CRITEC, ERICO, ERIFLEX, ERITECH and LENTON are owned by Pentair or its global affiliates. All other trademarks are the property of their respective owners. Pentair reserves the right to change specifications without prior notice.