

# GR

## DIGITAL

RICOH

# GR DIGITAL IV

## Camera User Guide

The product serial number may be found on the bottom of the camera.

### ***Before You Begin***

Before using your camera, take a few moments to familiarize yourself with camera controls and displays. **Refer to this section as you read through the rest of the manual (page 1).**

### ***Basic Photography and Playback***

**Read this section before using the camera for the first time (page 9).** It covers the steps involved in readying the camera for use, taking photographs, and playing them back.

### ***Reference***

**Read this section for information on topics not covered in “Basic Photography and Playback” (page 35).** It covers advanced shooting and playback options and describes how to print photographs, customize camera settings, and copy pictures to a computer.

The rechargeable battery needs to be charged before use. The battery is not charged at the time of purchase.

## Package Contents

---

Before using your Ricoh digital camera, confirm that the package contains the items listed below.



**GR DIGITAL IV**



**Hot shoe cover**

(Mounted on the camera hot shoe.)

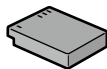

**DB-65 rechargeable battery**



**BJ-6 battery charger**

- AV cable
- USB cable
- Hand strap
- *Camera User Guide* (this manual)

## Notices

---

- **Safety precautions:** Read all safety precautions thoroughly to ensure safe use.
- **Test shots:** Take test shots to ensure that the camera is working properly before taking photos on important occasions.
- **Copyright:** Reproduction or alteration of copyrighted documents, magazines, and other materials, other than for personal, home, or other similarly limited purposes, without the consent of the copyright holder, is prohibited.
- **Exemption from liability:** Ricoh Co., Ltd. assumes no liability for failure to record or display images as a result of product malfunction.
- **Warranty:** This product is manufactured to local specifications and the warranty is valid within the country of purchase. The manufacturer assumes no responsibility for servicing the product in other countries or bearing any expense thereby incurred.
- **Radio interference:** Operating this product in the vicinity of other electronic equipment may adversely affect both the camera and the other device. Interference is particularly likely if the camera is used in close proximity to a radio or television. This can be resolved by moving the camera as far as possible from the other device, reorienting the radio or television antenna, or plugging the radio or television into a different outlet.

© 2011 RICOH CO., LTD. All rights reserved. This publication may not be reproduced in whole or in part without Ricoh's express written permission. Ricoh reserves the right to change the contents of this document at any time without prior notice.

Every effort has been made to ensure the accuracy of the information in this document. Should you nevertheless notice any errors or omissions, we would be grateful if you would notify us at the address listed on the back cover of this booklet.

Microsoft, Windows, Windows Vista, Windows 7, and Internet Explorer are registered trademarks of Microsoft Corporation in the United States of America and other countries. Macintosh and Mac OS are registered trademarks of Apple Inc. in the United States of America and other countries. Adobe, the Adobe logo, and Adobe Reader are trademarks of Adobe Systems Incorporated. HDMI, the HDMI logo and High-Definition Multimedia Interface are trademarks or registered trademarks of HDMI Licensing LLC. Eye-Fi, the Eye-Fi logo and Eye-Fi connected are trademarks of Eye-Fi, Inc. All other trade names mentioned in this document are the property of their respective owners.

# Safety Precautions

## Warning Symbols

Various symbols are used throughout this instruction manual and on the product to prevent physical harm to you or other people and damage to property. The symbols and their meanings are explained below.

 **Danger**

This symbol indicates matters that may lead to imminent risk of death or serious injury if ignored or incorrectly handled.

 **Warning**

This symbol indicates matters that may lead to death or serious injury if ignored or incorrectly handled.

 **Caution**

This symbol indicates matters that may lead to injury or physical damage if ignored or incorrectly handled.

## Sample Warnings



The  symbol alerts you to actions that must be performed.



The  symbol alerts you to prohibited actions.

The  symbol may be combined with other symbols to indicate that a specific action is prohibited.

● Examples

 Do not touch    Do not disassemble

Observe the following precautions to ensure safe use of this equipment.

## Danger



● Do not attempt to disassemble, repair or alter the equipment yourself. The high-voltage circuitry in the equipment poses significant electrical hazard.



● Do not attempt to disassemble, alter or directly solder the battery.



● Do not put the battery in a fire, attempt to heat it, use it in a high temperature environment such as next to a fire or inside a car, or abandon it. Do not put it into water or the sea or allow it to get wet.



● Do not attempt to pierce, hit, compress, drop, or subject the battery to any other severe impact or force.



● Do not use a battery that is significantly damaged or deformed.

## **Warning**



- Turn off the power immediately in the event of abnormalities such as smoke or unusual odors being emitted. Remove the battery as soon as possible, being careful to avoid electric shocks or burns. If you are drawing power from a household electrical outlet, be sure to unplug the power cord from the outlet to avoid fire or electrical hazards. Discontinue use of the equipment immediately if it is malfunctioning. Contact the nearest service center at your earliest convenience.



- Turn off the power immediately if any metallic object, water, liquid or other foreign object gets into the camera. Remove the battery and memory card as soon as possible, being careful to avoid electric shocks or burns. If you are drawing power from a household electrical outlet, be sure to unplug the power cord from the outlet to avoid fire or electrical hazards. Discontinue use of the equipment immediately if it is malfunctioning. Contact the nearest service center at your earliest convenience.



- Avoid any contact with the liquid crystal inside the picture display, should the monitor be damaged. Follow the appropriate emergency measures below.
- SKIN: If any of the liquid crystal gets on your skin, wipe it off and rinse the affected area thoroughly with water, then wash well with soap.
- EYES: If it gets in your eyes, wash your eyes with clean water for at least 15 minutes and seek medical advice immediately.
- INGESTION: If any of the liquid crystal is ingested, rinse the mouth out thoroughly with water. Have the person drink a large amount of water and induce vomiting. Seek medical assistance immediately.



- Follow these precautions to prevent the battery from leaking, overheating, igniting or exploding.
- Do not use a battery other than those specifically recommended for the equipment.
- Do not carry or store together with metal objects such as ball-point pens, necklaces, coins, hairpins, etc.
- Do not put the battery into a microwave or high pressure container.
- If leakage of battery fluid or a strange odor, color change, etc. is noticed during use or during charging, remove the battery from the camera or battery charger immediately and keep it away from fire.



- Please observe the following in order to prevent fire, electrical shock or cracking of the battery while charging.
- Use only the indicated power supply voltage. Also avoid the use of multi-socket adapters and extension cords.
- Do not damage, bundle or alter power cords. Also, do not place heavy objects on, stretch or bend power cords.
- Do not connect or disconnect the power plug with wet hands. Always grip the plug section when disconnecting a power cord.
- Do not cover equipment while charging.



- Keep the battery and SD memory card used in this equipment out of the reach of children to prevent accidental ingestion. Consumption is harmful to human beings. If swallowed, seek medical assistance immediately.



- Keep the equipment out of the reach of children.



- Do not touch the internal components of the equipment if they become exposed as a result of being dropped or damaged. The high-voltage circuitry in the equipment could lead to an electric shock. Remove the battery as soon as possible, being careful to avoid electric shocks or burns. Take the equipment to your nearest dealer or service center if it is damaged.



- Do not use the equipment in wet areas as this could result in fire or electric shock.



- Do not use the equipment near flammable gases, gasoline, benzene, thinner or similar substances to avoid the risk of explosion, fire or burns.
- Do not use the equipment in locations where usage is restricted or prohibited as this may lead to disasters or accidents.



- Wipe off any dust that accumulates on the electrical plug as this may lead to fire.
- Use only the specified AC adapter in household electrical outlets. Other adapters pose the risk of fire, electric shock or injury.



- To avoid the risk of fire, electric shock or injury, do not use the battery charger or AC adapter with commercially available electronic transformers when traveling abroad.

Observe the following precautions to ensure safe use of this unit.

 **Caution**



- Contact with fluid leaking from a battery can lead to burns. If part of your body comes in contact with a damaged battery, rinse the area with water immediately. (Do not use soap.) If a battery starts to leak, remove it immediately from the equipment and wipe the battery chamber thoroughly before replacing it with a new battery.



- Plug the power cords securely into the electrical outlets. Loose cords pose a fire hazard.



- Do not allow the camera to get wet. In addition, do not operate it with wet hands. Both pose the risk of electric shock.



- Do not fire the flash at drivers of vehicles, as this may cause the driver to lose control and result in a traffic accident.

**Safety Precautions for Accessories**

When using optional products, carefully read the instructions before using that product.

## Product Manuals

The following manuals are provided with the GR DIGITAL IV:



### Camera User Guide (this booklet)

This guide describes how to use your camera and install the software included in the internal memory of the camera to your computer.



### Software User Guide (pdf file)

The *Software User Guide* describes how to copy pictures from your camera to a computer for display and editing.

The "Software User Guide" is available in the [MANUAL] folder in the internal memory of the camera.



Each language has its own "Software User Guide".

To copy the User Guide onto your computer, connect the camera to the computer using the supplied USB cable. See page 139 for more information.

Image viewing and editing software, "MediaBrowser" (for Windows only), is also included in the internal memory of the camera. For information on using this software, see the **Help** menu in MediaBrowser or telephone one of the following customer support centers:

- **North America (U.S.)** TEL: (Toll Free) +1-800-458-4029
- **Europe**
  - UK, Germany, France and Spain:** TEL: (Toll Free) +800-1532-4865
  - Other Countries:** TEL: +44-1489-564-764
- **Asia** TEL: +63-2-438-0090
- **China** TEL: +86-21-5385-3786

Business hours: 9:00 AM to 5:00 PM





# Table of Contents

---

Package Contents.....	ii
Notices.....	iii
Safety Precautions.....	iv
Product Manuals.....	viii
<b>Before You Begin</b> .....	<b>1</b>
Read this section before using your camera for the first time.	
<b>Introduction</b> .....	<b>2</b>
Parts of the Camera.....	2
<b>Basic Photography and Playback</b> .....	<b>9</b>
Read this section before using your camera for the first time.	
<b>First Steps</b> .....	<b>10</b>
Charging the Battery.....	10
Inserting the Battery and a Memory Card.....	12
Turning the Camera On and Off.....	15
Basic Setup.....	17
<b>Taking Photographs</b> .....	<b>18</b>
Taking a Photograph.....	18
Digital Zoom.....	20
Close-ups (Macro Mode).....	21
Flash.....	22
Self-Timer.....	24
Tilt Indicator.....	25
<b>Viewing and Deleting Photographs</b> .....	<b>27</b>
Viewing Photographs.....	27
Deleting Photographs.....	30
 (DISP) Button.....	33

**Reference** **35**

Read this section for more information on camera functions.

<b>More on Photography .....</b>	<b>36</b>
Mode P: Program Shift .....	36
Mode A: Aperture Priority .....	38
Mode S: Shutter Priority .....	39
Mode M: Manual Exposure .....	40
<b>SCENE</b> Mode: Matching Settings to the Scene.....	42
“MY” Modes: Using Custom Settings .....	48
The Shooting Menu.....	49
<b>Movies .....</b>	<b>86</b>
 Recording Movies.....	86
 Viewing Movies .....	88
<b>More on Playback.....</b>	<b>89</b>
The Playback Menu.....	89
Viewing Pictures on TV .....	101
<b>Printing Photographs .....</b>	<b>104</b>
Connecting the Camera .....	104
Printing .....	106
<b>The Setup Menu.....</b>	<b>109</b>
Key Custom Options .....	112
Setup Menu Options .....	123
<b>Downloading Images to Your Computer .....</b>	<b>135</b>
For Windows .....	135
For Macintosh.....	142
<b>Technical Notes .....</b>	<b>144</b>
Troubleshooting .....	144
Specifications.....	150
Optional Accessories .....	154
Using the Camera Abroad.....	161
Precautions for Use .....	161
Camera Care and Storage.....	163
Warranty and Servicing .....	164
NOTICES .....	165
<b>Index .....</b>	<b>166</b>

# ***Before You Begin***

Read this section before using your camera for the first time.

■ Introduction.....	2
---------------------	---

# Introduction

## Parts of the Camera

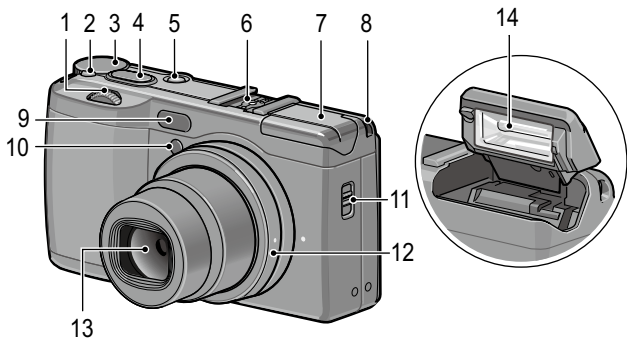

Refer to the page to the right of each item.

<b>1</b> Up-down dial .....	5	<b>8</b> Strap eyelet	
<b>2</b> Mode dial lock release button .....	4	<b>9</b> External AF sensor	
<b>3</b> Mode dial .....	4	<b>10</b> AF auxiliary light .....	24, 124
<b>4</b> Shutter-release button .....	18	<b>11</b>  OPEN switch .....	22
<b>5</b> POWER button .....	15	<b>12</b> Ring cap .....	156
<b>6</b> Hot shoe .....	159	<b>13</b> Lens	
<b>7</b> Flash cover .....	22	<b>14</b> Flash .....	22

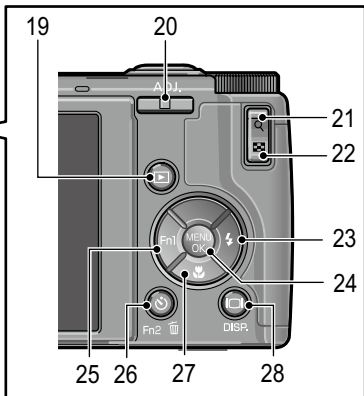
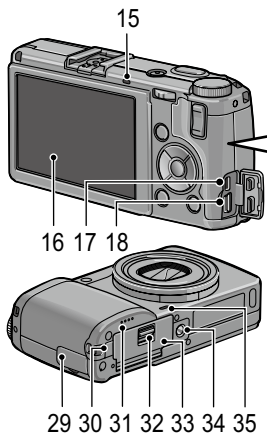

- |  |                         |   |               |
|--|-------------------------|---|---------------|
| <b>15</b> Autofocus/flash lamp .....                       | 15, 19, 23              | <b>25</b> ◀/Fn1 (function 1) button .....                             | 119           |
| <b>16</b> Picture display .....                            | 6                       | <b>26</b> ⏱ (self-timer)/Fn2 (function 2)/<br>🗑 (delete) button ..... | 24, 30, 119   |
| <b>17</b> Common terminal for USB port/<br>AV output ..... | 101, 105, 137, 140, 142 | <b>27</b> ▼/🌸 (macro) button .....                                    | 21            |
| <b>18</b> Connector for HDMI cable .....                   | 102                     | <b>28</b>  ◻  (DISP.) button .....                                    | 25, 33        |
| <b>19</b> ▶ (playback) button .....                        | 27, 89                  | <b>29</b> Connector cover .....                                       | 101, 102, 105 |
| <b>20</b> ADJ. lever .....                                 | 5, 117                  | <b>30</b> DC power cable cover .....                                  | 158           |
| <b>21</b> 🔍 (enlarged view) button<br>.....                | 20, 28, 29, 121         | <b>31</b> Speaker   |               |
| <b>22</b> 🖼 (thumbnail display) button<br>.....            | 20, 28, 29, 121         | <b>32</b> Release lever .....   | 12            |
| <b>23</b> ▶/⚡ (flash) button .....                         | 22                      | <b>33</b> Battery/card cover .....                                    | 12            |
| <b>24</b> MENU/OK button<br>.....                          | 49, 89, 109             | <b>34</b> Tripod screw hole   |               |
|  |                         | <b>35</b> Microphone  |               |

## Mode Dial

Press the mode dial lock release (①) and rotate the mode dial to choose a shooting mode (②).

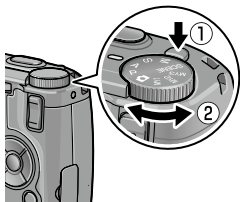

**P (program shift):** You choose from combinations of shutter speed and aperture that produce the same exposure (page 36).

**A (aperture priority):** You choose an aperture and let the camera adjust the shutter speed for optimal exposure (page 38).

**S (shutter priority):** You choose a shutter speed and let the camera adjust aperture for optimal exposure (page 39).

 **(auto):** The camera sets shutter speed and aperture for optimal exposure (page 18).

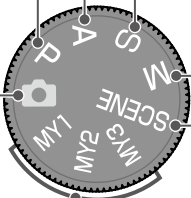

**M (manual exposure):** You choose shutter speed and aperture (page 40).

**MY1/MY2/MY3 ("my settings"):** Recall settings saved using **Reg. My Settings** (pages 48, 112).

**SCENE (scene):** Shootings in the Dynamic Range/Interval Composite/Skew Correct/Movies mode are available (page 42).

## Up-down Dial and ADJ. Lever

When viewing pictures or navigating the menus, you can use the up-down dial in place of the ▲ and ▼ buttons and the ADJ. lever in place of the ◀ and ▶ buttons. The ADJ. lever and up-down dial can also be used to select shutter speed and aperture in P, A, S, and M modes.

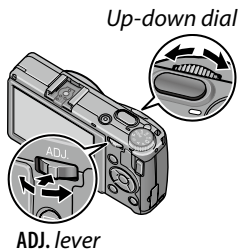

### Note

- You can assign frequently-used shooting menu items to the **ADJ.** lever for easy access (page 117).
- Functions assigned to the up-down dial and **ADJ.** lever can be changed in **M Mode Dial Options** and **Playback Mode Dial Options** in the setup menu (page 121).

## Picture Display

### Shooting (still photography)

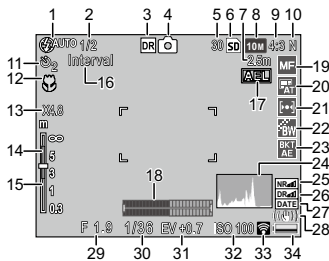

### Shooting (movie mode)

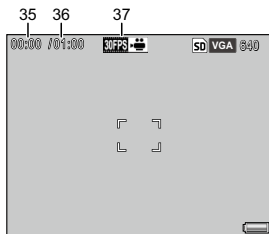

<b>1</b> Flash mode.....	<b>22</b>	<b>11</b> Self-timer.....	<b>24</b>	<b>24</b> Histogram .....	<b>34</b>
<b>2</b> Flash compensation .....	<b>70</b>	<b>12</b> Macro mode .....	<b>21</b>	<b>25</b> Noise reduction .....	<b>73</b>
Manual flash level .....	<b>71</b>	<b>13</b> Zoom.....	<b>20</b>	<b>26</b> Dynamic range .....	<b>72</b>
<b>3</b> Scene mode.....	<b>42</b>	<b>14</b> Depth of field .....	<b>56</b>	compensation. ....	<b>72</b>
Continuous .....	<b>64</b>	Optional AF distance .....	<b>56</b>	<b>27</b> Date imprint.....	<b>76</b>
<b>4</b> Shooting mode .....	<b>4, 36</b>	display.....	<b>56</b>	<b>28</b> Blur warning .....	<b>20</b>
Plus normal shooting .....	<b>84</b>	<b>15</b> Focus bar .....	<b>56</b>	<b>29</b> Aperture .....	<b>36, 38, 40</b>
<b>5</b> Number of exposures .....	<b>153</b>	<b>16</b> Interval shooting... ..	<b>75</b>	<b>30</b> Shutter speed .....	<b>36, 39, 40</b>
remaining* .....	<b>153</b>	Multiple exposure .....	<b>68</b>	.....	<b>36, 39, 40</b>
<b>6</b> Destination.....	<b>14</b>	<b>17</b> Autoexposure .....	<b>119</b>	<b>31</b> Exposure .....	<b>77</b>
<b>7</b> Snap focus .....	<b>60</b>	lock .....	<b>119</b>	compensation .....	<b>77</b>
distance.....	<b>60</b>	<b>18</b> Tilt indicator.....	<b>25</b>	<b>32</b> ISO.....	<b>82</b>
<b>8</b> Picture size .....	<b>53</b>	<b>19</b> Focus mode .....	<b>55</b>	<b>33</b> Eye-Fi connection.....	<b>8</b>
<b>9</b> Aspect ratio .....	<b>53</b>	<b>20</b> White balance mode .....	<b>78</b>	<b>34</b> Battery level.....	<b>8</b>
<b>10</b> Picture quality.....	<b>53</b>	<b>21</b> Metering .....	<b>61</b>	<b>35</b> Movie length .....	<b>8</b>
		<b>22</b> Image setting.....	<b>62</b>	<b>36</b> Time available* .....	<b>87</b>
		<b>23</b> Bracketing.....	<b>67</b>	<b>37</b> Frame rate.....	<b>87</b>

\* Approximation only; actual capacity varies with shooting conditions and make of memory card. Display shows "9999" when memory remains for over 9,999 images.



### Playback (photographs)

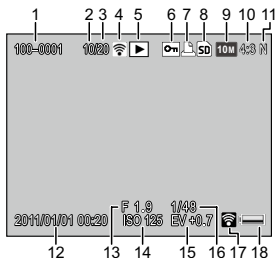

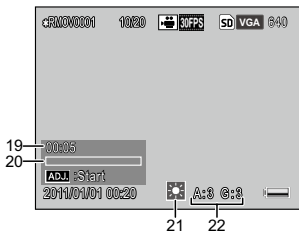

### Playback (photographs)



<b>1</b> File number .....	132	<b>10</b> Aspect ratio .....	53	<b>17</b> Eye-Fi connection	
<b>2</b> Current frame		<b>11</b> Picture quality .....	53	.....	8
<b>3</b> Total frames		<b>12</b> Date of recording		<b>18</b> Battery level .....	8
<b>4</b> Eye-Fi transferred		.....	17	<b>19</b> Length/elapsed time	
images .....	8	<b>13</b> Aperture		.....	88
<b>5</b> Playback mode		.....	36, 38, 40	<b>20</b> Progress indicator	
indicator		<b>14</b> ISO .....	82	.....	88
<b>6</b> Protected image ....	90	<b>15</b> Exposure		<b>21</b> White balance .....	78
<b>7</b> DPOF print		compensation .....	77	<b>22</b> White balance	
indicator .....	92	<b>16</b> Shutter speed		compensation .....	81
<b>8</b> Source .....	14	.....	36, 39, 40		
<b>9</b> Picture size .....	53				

## Battery Level Indicator

Icon	Status
 (green)	Battery fully charged.
 (green)	Battery partially discharged.
 (orange)	Low battery. Charge or replace the battery.









### Note

- If using NiMH batteries, the battery level may not be displayed correctly depending on the type of the batteries or conditions.

## Eye-Fi Connection

When using an Eye-Fi card (page 13), the connection status is displayed in the shooting and playback modes.

Icon	Status
	Not connected
	Connecting
	Waiting for data transfer
	Transferring
	Connection terminated
	Transferred images
	Eye-Fi card information acquisition error • Turn the camera off and on. If the issues still persist, there may be something wrong with the card.

# ***Basic Photography and Playback***

Read this section before using your camera for the first time.

- First Steps..... 10
- Taking Photographs..... 18
- Viewing and Deleting Photographs..... 27

# First Steps

Prepare the camera for use.

## Charging the Battery

The rechargeable battery supplied with the camera is not charged at shipment. Charge the battery in the supplied BJ-6 battery charger before use.

### 1 Place the battery in the charger.

Place the battery label up with the "+" and "-" labels oriented to match the labels on the charger.

#### **Caution** ~~~~~

- Be sure the battery is in the correct orientation.

### 2 Plug the charger in.

The charger lamp will light while the battery charges.

#### **Note** ~~~~~

- An exhausted battery will be fully charged in about two and a half hours at 25 °C.
- If the charger lamp blinks, a battery or charger fault may have occurred. Unplug the charger and remove the battery.
- Charging is complete when the charger lamp turns off.

### 3 Remove the battery.

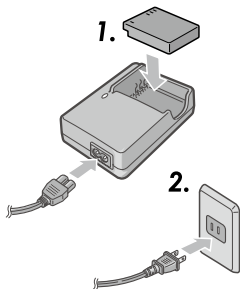

**Tip: Compatible Batteries**

- The camera can be used with a DB-65 rechargeable Li-ion battery (supplied), DB-60 rechargeable batteries or with a pair of AAA alkaline or rechargeable nickel-metal hydride (NiMH) batteries.

**Tip: Battery Capacity**

- Under normal conditions, about 390 shots can be taken with a fully-charged DB-65 battery. About 30 shots can be taken with a pair of fresh AAA alkaline batteries.

These figures are based on tests conducted according to CIPA standards under the following conditions: temperature 23°C (73°F); picture display on; 10 shots taken with 30 seconds between shots and the flash fired with every other shot; and the cycle repeated after the camera has been turned off and then on again.

**Caution**

- **Rechargeable Li-ion batteries:** Use only genuine DB-65 or DB-60 batteries.
- **Alkaline batteries:** Battery life varies with make and storage conditions. Capacity drops at low temperatures.
- **NiMH batteries:** Note that performance may be impaired immediately after purchase or following an extended period of disuse, and that the batteries may need to be used and recharged two or three times before they will hold a charge.
- Manganese and Ni-Cd batteries cannot be used.
- Batteries may be hot immediately after use. Before removing batteries, turn the camera off and wait for them to cool down.

## Inserting the Battery and a Memory Card

Be sure the camera is off before inserting or removing batteries and a memory card.

SD memory card or SDHC memory card can be used with this camera ("memory card" indicates SD and SDHC memory cards in this guide).

### 1 Open the battery/card cover.

Unlatch (1) and open (2) the cover.

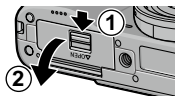

### 2 Insert a memory card.

Holding the memory card in the orientation shown, slide it in until it clicks into place.

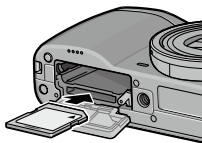

### 3 Insert the battery.

Using the battery to keep the battery latch pressed to one side, slide the battery in. The latch will click into place when the battery is fully inserted.

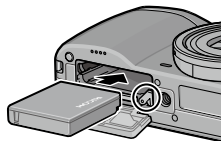

### 4 Close the battery/card cover.

Close (1) and latch (2) the cover.

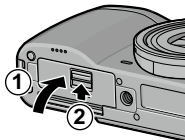

#### **Caution** //

- Be sure the cover is latched.

## Removing the Battery and a Memory Card

Unlatch and open the battery/card cover, press and release the battery latch and remove the battery by hand, being careful not to drop it.

Press the memory card in to eject it. The card can then be removed by hand.

### **Tip: Inserting AAA Batteries**

- Insert in the orientation shown, press the cover closed, and slide the release lever to the closed position.

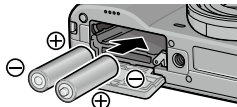

### **Caution**

- If the camera will not be used for an extended period, remove the batteries and store them in a cool dry place.

### **Tip: Eye-Fi Cards**

- Eye-Fi X2 series cards (SD memory cards with built-in wireless LAN function) can be used with this camera. For more information on Eye-Fi cards, access the Web page of Eye-Fi (<http://www.eye.fi/>).
- When using an Eye-Fi card, the following settings are displayed in the setup menu (page 111).
  - **Eye-Fi Connection Settings:** Enables or disables the wireless LAN function of a compatible memory card.
  - **Eye-Fi Connection Display:** Displays the SSID for the wireless LAN.
- This product does not guarantee the functions of Eye-Fi card (including wireless transfer). If any issues arise with an Eye-Fi card, consult the card manufacturer. Eye-Fi cards can be used only in the country in which the cards were purchased. For confirming whether the use of the card has been approved in the country, consult the card manufacturer.

## **Destination to Record**

Pictures taken with this camera can be recorded to the internal memory or a memory card. When a memory card is not set in the camera, data is recorded in the internal memory.

The data in the internal memory can be copied to a memory card (page 94).



### **Caution** =====

- Pictures will not be recorded to the internal memory when a memory card is inserted, even if the memory card is full.



### **Note** =====

- Format memory cards before first use or after they have been used in a computer or other device (page 123).
- See page 153 for information on memory card capacity.



## Turning the Camera On and Off

### Shooting Mode

Press the **POWER** button to turn the camera on.

The **POWER** button will light and the camera will play the start-up sound. The autofocus/flash lamp blinks for several seconds while the camera starts up.

To turn the camera off, press the **POWER** button again.

The number of pictures taken so far that day will be displayed before the camera turns off (zero is displayed if the camera clock is not set).

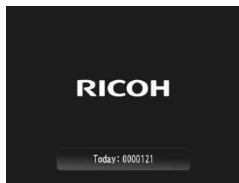
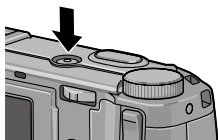

## Playback Mode

Press the  button for about a second to turn the camera on in playback mode.

Press the  button again to turn the camera off.

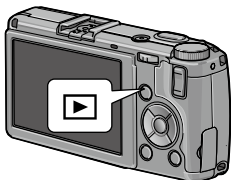

### **Note**

- The camera will turn off automatically to save power if no operations are performed for the time selected in the **Auto Power Off** menu (page 125).
- If **Sleep Mode** is set in the setup menu, the camera dims the display automatically to save power after a set period of time (page 126).
- If **On** is selected for **LCD Auto Dim** in the setup menu, the camera dims the display automatically to save power when no operations are performed for five seconds (page 126).
- The power indicator lamp can be set to **On** or **Off** in **Power Button Lamp** in the key custom settings (page 121).

## Basic Setup

A language-selection dialog is displayed the first time the camera is turned on. Follow the steps below to choose a language and set the time and date.

### 1 Select a language.

Press ▲, ▼, ◀, or ▶ to highlight a language and press MENU/OK to select.

To exit before setup is complete, press the DISP. button.



### 2 Set the clock.

Press ◀ or ▶ to highlight the year, month, day, hour, minute, or date format and press ▲ or ▼ to change. Press MENU/OK.

A confirmation dialog will be displayed.

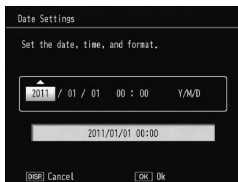

### 3 Press MENU/OK.



#### Note

- If you leave the battery in the camera for at least two hours, the battery can be removed for about a week without resetting the clock or language selection.
- The language, time, and date can be changed in the setup menu (page 111).

# Taking Photographs

After setting up the camera as described in “First Steps” (page 10), you are ready to take your first photos.

## Taking a Photograph

- 1 Rotate the mode dial to .

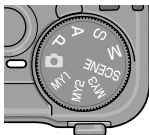

- 2 Focus.

Frame your subject in the center of the picture display and press the shutter-release button halfway to set focus and exposure.

The focus frames (up to nine) that contain objects that are in focus are shown in green.



- 3 Take the picture.

Gently press the shutter-release button the rest of the way down to take the picture.

The photograph you have just taken will be displayed in the picture display.



### Tip: Focus

- The autofocus/flash lamp and the focus frame show whether the subject is in focus.

Autofocus/flash lamp

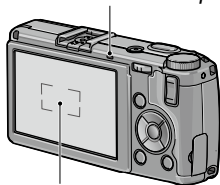

Focus frame

Focus status	Focus frame	Autofocus/flash lamp
Camera has not yet focused.	White	Off
Subject in focus.	Green	On (green)
Camera unable to focus.	Red (blinks)	Blinks (green)

- The camera may be unable to focus or a subject may not be in focus even if focus frames are displayed in green in the following cases.
    - Objects that lack contrast, such as the sky, a wall that is only one color, or the hood of a car
    - Flat objects containing only horizontal lines
    - Fast-moving objects
    - Objects that are poorly lit
    - Objects with bright reflections or backlighting
    - Flickering objects, such as fluorescent lights
    - Point light sources, such as light bulbs, spotlights, or LEDs
- If the camera is unable to focus, lock focus on another object at the same distance from the camera as your subject, then recompose the photograph and take the picture.

**Tip: Avoiding Blurred Pictures**

- In situations in which photographs are especially prone to blurring caused by camera shake, attempt one of the following remedies:
  - Selecting **On** for **Camera Shake Correction** in the shooting menu (page 74)
  - Turning the flash on or using auto flash (page 22)
  - Choosing a higher ISO (page 82)
  - Using the self-timer (page 24)

**Note**

- You can choose how long a picture is displayed after shooting in **LCD Confirmation Time** in the setup menu (page 125). If selecting **Hold**, a picture is displayed until the shutter-release button is pressed halfway next time.

## Digital Zoom

---

When **Digital Zoom** is selected for **Zoom Button** in the key custom settings, the **Q** button can be used to zoom in to a maximum of 4.0x. Use the **DISP** button to zoom out.

- 1 **Assign digital zoom to the Q and DISP buttons.**  
Select **Digital Zoom** for the **Zoom Button** option in the key custom settings (page 121).
- 2 **Frame the picture using the Q and DISP buttons.**  
The zoom ratio is shown in the picture display.
- 3 **Take the picture.**

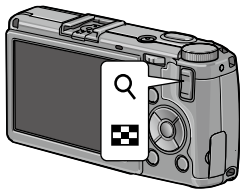

**Note**



- **10M 4:3 F** or **10M 4:3 N** is selected for **Picture Quality/Size** (page 53), **Auto Resize** can be selected for **Digital Zoom Image** (page 131).
- Digital zoom is not available in the dynamic range, interval composite, and multiple exposure modes or when a RAW-quality option is selected for **Picture Quality/Size**.

## Close-ups (Macro Mode)

---

Use macro mode for close-ups of small objects as close as 1.0 cm (0.4 in.) to the lens (at this distance, the area photographed will be about 26 × 19 mm/1.0 × 0.7 in.).

### 1 Press the button.

A  icon will be briefly displayed in the center of the picture display.  will then appear at the top of the display.

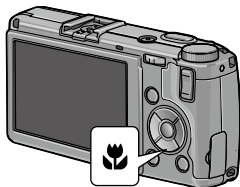

### 2 Take the picture.



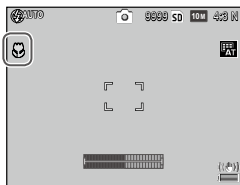



To exit macro mode, press the  button again.

**Note**

- The camera will focus using spot autofocus in macro mode (page 55).

## Flash

The following flash modes are available.

Mode	Description
 <b>Flash On</b>	The flash fires with every shot.
 <b>Auto</b>	The flash fires automatically when required (default).
 <b>Red-Eye Flash</b>	Reduces "red-eye" in portraits taken with the flash.
 <b>Flash Synchro.</b>	Combines the flash with slow shutter speeds. Use when taking portraits that include details of the background indoors or at night. Use of a tripod is recommended to prevent blur.
 <b>Manual Flash</b>	The flash fires with every shot; flash output is fixed at the level selected for <b>Manual Flash Amount</b> in the shooting menu (page 71).
 <b>Flash Off</b>	The flash will not fire.

### Using the Built-in Flash

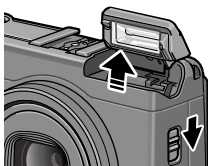

#### 1 Raise the flash.

Slide the  **OPEN** switch as shown.





## 2 Select a flash mode.

Press the  button and press  or  to select a flash mode. The flash mode icon is briefly displayed in the center of the picture display and then appears in the top left corner of the display.

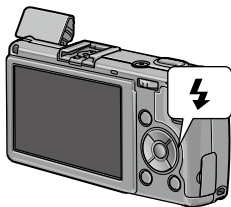

The autofocus/flash lamp blinks while the flash charges. Photos can be taken when the lamp stops blinking.



### Note

- To close the flash when it is not in use, gently press the center of the flash cover down until it latches.
- The flash has a range of approximately 20 cm to 3.0 m (8 in.–10 ft.), measured from the front of the lens (auto ISO; see page 82).
- If the camera is powered by AAA batteries, the picture display will turn off until charging is complete.
- A pre-flash is fired before the main flash to achieve optimal exposure.
- Flash amount can be adjusted in **Flash Exposure Compensation** in the shooting menu (page 70).



### Caution

- The flash turns off automatically in dynamic range, internal composite, movie, continuous, and bracketing modes.
- Do not use the built-in flash with conversion lenses or lens hoods.

## Self-Timer

The self-timer can be set to two seconds or a custom setting. Two-second timer is useful for preventing blur caused by the camera movement when the shutter-release button is pressed.

The number of pictures and the shooting interval can be set for a custom setting in **Custom Self-Timer** in the shooting menu (page 74).

### 1 Choose a self-timer mode.

Press the  button once to select the two-second timer and again to select the custom setting. The current selection is displayed in the picture display. Pressing the button a third time turns the timer off.

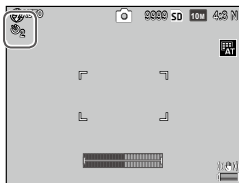

### 2 Start the timer.

Press the shutter-release button to lock focus and start the timer.



#### Note

- The selected self-timer mode remains in effect until a new mode is chosen or the camera is turned off.
- When two-second timer is selected, the AF auxiliary light does not light.
- By default, the self-timer is assigned to the  (**Fn2**) button, but it can also be assigned to the **Fn1** button. The self-timer can only be used when assigned to a button (page 119).
- Custom setting is not available for the interval composite shooting and skew correct mode in scene mode, and multiple exposure shooting.

## Tilt Indicator

Use the tilt indicator to level the camera and correct the perspective when photographing buildings or landscapes.

### 1 Display level setting options.

Press and hold the  (DISP.) button until level setting options are displayed.

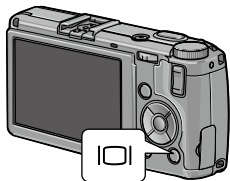

### 2 Highlight an option.

Press  or  to highlight an option:

Option	Description
Off	Tilt indicator is not displayed.
Level + Tilt	Displays the tilt and level indicator at the bottom of the picture display (default).
Level	Displays the tilt indicator at the bottom of the picture display.
Level + Sound	Displays the tilt indicator at the bottom of the picture display, and a beep sounds at a regular interval when the camera is level.
Sound	A beep sounds at a regular interval when the camera is level. The tilt indicator is not displayed in the picture display.

### 3 Select the highlighted option.

Press **MENU/OK** to select the highlighted option.

## Understanding the Tilt Indicator



*Camera level*



*Tilt camera left to level*



*Tilt camera backward to level*



*Unable to measure tilt; camera rotated too far forward or backward*



### Note

- Tilt indicator can also be set in **Level Setting** in the setup menu (page 126).
- The standard perspective can be registered in **Level (Tilt) Calibration** in the setup menu (page 126).
- When **Volume Settings** is set to Off, a beep does not sound even if the level sound function is set.



### Caution

- The tilt indicator is not displayed when the camera is upside down, movies are being recorded, or in the interval shooting.
- The tilt indicator is intended as a guide only and should not be used as a spirit level or in other applications in which a high degree of precision is required. Accuracy drops when the camera is in motion or you are shooting on a vehicle or other moving platform.

# Viewing and Deleting Photographs

Pictures can be viewed in the picture display.

## Viewing Photographs



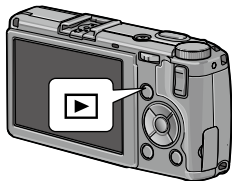

---

### 1 Switch to the playback mode.

Press the  button to display a picture in the playback mode.



### 2 Display a picture.

Press  to view subsequent pictures,  to view in reverse order. Press  to skip ahead ten frames,  to go back ten frames.

Press the  button again to exit to shooting mode.



#### Note



- The display order can be selected from **File Numbers** or **Sht. Date/Time** in **Playback Order Options** in the setup menu (page 130).



#### Tip: Auto Rotate

- If **On** is selected for **Auto Rotate** in the setup menu, pictures will be automatically displayed in the correct orientation in the picture display (page 129).

## Viewing Multiple Photographs

Use the  and  buttons to view a picture in a single frame, multiple pictures in 20/81 frames or calendar display, or 20 frames sorted by date.

Single frame



20 frames





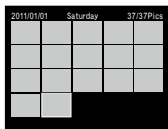
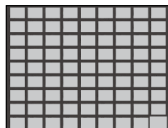

81 frames



20 frames sorted  
by date

Calendar

Press , , , and  to highlight a picture, and press the **ADJ.** lever in to view the picture in a single frame view. Press the **DISP.** button to switch between a single-frame view and multiple-frame view.

## Playback Zoom

Press the **Q** button or rotate the up-down dial to zoom in on the photo currently displayed full frame. To zoom in to the magnification selected in **One Press Zoom Ratio** (page 128), press the **ADJ.** lever in.

The following operations are available:

Use	Description
<b>Q</b> / 	Zoom in and out. Press <b>▲</b> , <b>▼</b> , <b>◀</b> or <b>▶</b> to move the display area.
Up-down dial	Rotate right to zoom in, left to zoom out.
<b>MENU/OK</b>	Zoom in to the magnification selected in <b>One Press Zoom Ratio</b> (page 128).
<b>ADJ.</b> lever	Press left or right to view a preceding or next image at the same zoom ratio. The playback zoom is canceled automatically if a movie or a picture taken in the <b>S-Cont</b> or <b>M-Cont</b> mode is displayed.



### Note

- Maximum magnification varies with image size:

Image size (pixels)	Maximum magnification
<b>10M / 9M / 7M / 8M / 5M / 3M</b>	16×
<b>1M</b>	6.7×
<b>VGA / RAW*</b>	3.4×

\* Only when **RAW only** is selected for **RAW/JPEG Setting** in the setup menu (page 130).

- The functions assigned to the up-down dial and the **ADJ.** lever can be changed in **Playback Mode Dial Options** in the key custom settings (page 121).

## Deleting Photographs

### Deleting Individual Photographs

- 1 Display a photograph you want to delete.**  
Display a photograph you want to delete in single-frame playback (page 27).
- 2 Press the  button.**
- 3 Highlight Delete One.**  
Press ▲ or ▼ to highlight Delete One.
- 4 Press MENU/OK.**

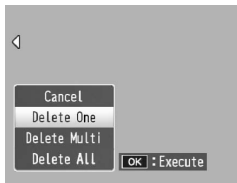

### Deleting All Files

To delete all files, press the  button to display delete options and select **Delete All**. A confirmation dialog will be displayed; press ◀ or ▶ to highlight **Yes** and press MENU/OK.



### 1 Press the button.

In multi-frame playback, proceed to Step 2.

In single-frame playback, delete options will be displayed. Highlight **Delete Multi** and press **MENU/OK**.

### 2 Select **Sel. Individ.** or **Sel. Range**.

To select images one at a time, highlight **Sel. Individ.**, press **MENU/OK**, and proceed to Step 3.

To select a range, highlight **Sel. Range**, press **MENU/OK**, and proceed to Step 3.1. To exit without deleting files, press the **DISP.** button.

### 3 Select photographs.

Press **▲**, **▼**, **◀**, or **▶** to highlight photos and press **MENU/OK** to select. Selected pictures are marked with  icon.

To deselect a photo, highlight it and press **MENU/OK** again.



### **Tip: Selecting Ranges**

**3.1** Press ▲, ▼, ◀, or ▶ to highlight the first image and press **MENU/OK** to select. The selected image is marked with  icon. If you selected a wrong image, press the **DISP.** button and try again.

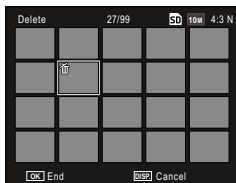

**3.2** Press ▲, ▼, ◀, or ▶ to highlight the last image and press **MENU/OK** to select. The selected image and images in the range will be marked with  icon.

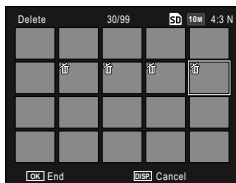

- Repeat Steps 3.1 and 3.2 to select additional ranges.
- To select or deselect individual photos, press the **ADJ.** lever in to switch to **Sel. Indiv.** mode.

## **4** Press .

A confirmation dialog will be displayed.

## **5** Select **Yes**.

Press ◀ or ▶ to highlight **Yes** and press **MENU/OK**.

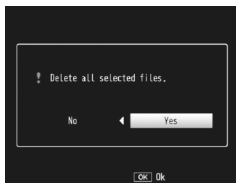

## (DISP.) Button



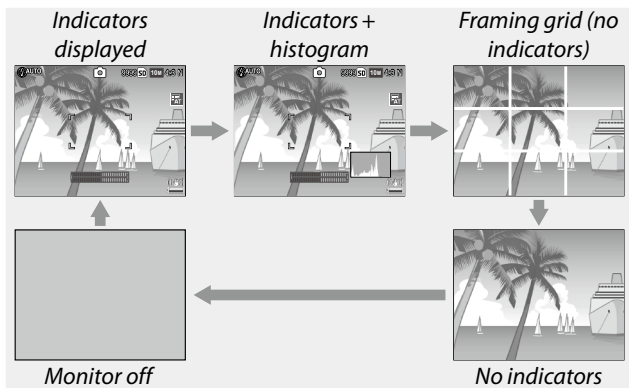

Use the  (DISP.) button to choose the information displayed in the picture display.

### Shooting Mode

Press the  (DISP.) button to cycle through the following displays:



Display	Description
Indicators displayed	Displays indicators for shooting modes and settings. If a display option is selected for the level setting (page 25), the tilt indicator is displayed.
Indicators+ histogram	Displays the indicators for shooting modes and settings, and the histogram (not available in movie mode).
Framing grid	Displays the framing grid guide. The type of grid can be selected in <b>Grid Guide Display Options</b> in the setup menu (page 127).
No indicators	Displays no indicators.

Display	Description
Monitor off	<p>Turns the monitor off. Select this mode to save power or for using an optional external viewfinder.</p> <p>The monitor will turn on in the following cases.</p> <ul style="list-style-type: none"> <li>• When the ADJ. lever, MENU/OK, DISP., , Q, or  is pressed.</li> <li>• When  or  is pressed in the manual focus mode.</li> </ul>



### Note



- ● REC icon blinks and the recording time and remaining time are displayed in the picture display while shooting a movie regardless of the display mode.

## Playback Mode

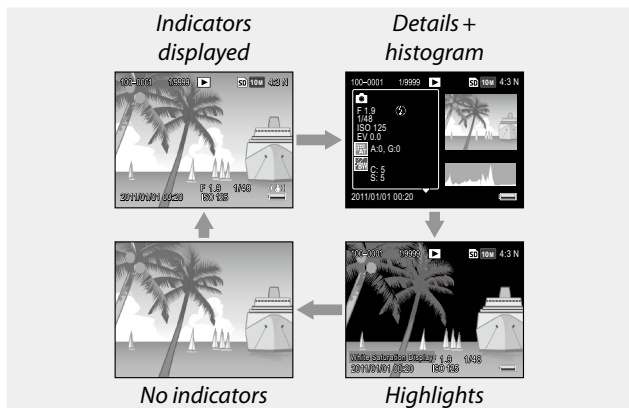
Press the  (DISP.) button to cycle through the following displays:



### Note

- If **On** is selected for **White Saturation Display** in the setup menu (page 129), the white saturation areas of the image flash in black in the Highlights display.
- Details for shooting settings are displayed in the details+histogram display, and the pages can be switched using  and  buttons.

# Reference

Read this section for more information on camera functions.

■ More on Photography .....	36
■ Movies .....	86
■ More on Playback.....	89
■ Printing Photographs .....	104
■ The Setup Menu .....	109
■ Downloading Images to Your Computer ....	135
■ Technical Notes .....	144

# More on Photography

This section provides information on P, A, S, M, **SCENE**, and “MY” modes and on using shooting menu options.

## Mode P: Program Shift

In mode P (program shift), use the up-down dial to choose from several combinations of shutter speed and aperture, all of which produced the same exposure.

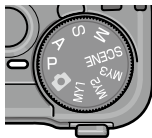

### 1 Choose mode P.

Rotate the mode dial to P. The shooting mode is shown by an icon in the display.



### 2 Measure exposure.

Press the shutter-release button halfway to measure exposure. The current shutter speed and aperture appear in the display.

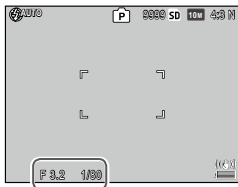

### 3 Choose shutter speed and aperture.

Remove your finger from the shutter-release button and rotate the up-down dial to select a combination of shutter speed and aperture.

**Note**

- Shutter speed and aperture can be adjusted for ten seconds after you remove your finger from the shutter-release button.

## 4 Take the photograph.

Gently press the shutter-release button all the way down to take the photograph.

**Note: The Exposure Program**

- The exposure program (ISO 100, flash off) is shown below. The shaded area gives the combinations of shutter speed and aperture available at each exposure value (EV).

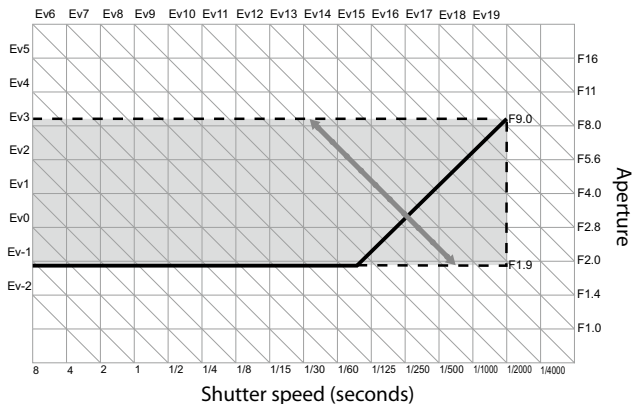

## Mode A: Aperture Priority

In mode A (aperture priority), you choose the aperture and the camera selects the shutter speed. Choose large apertures (low f-numbers) to emphasize the main subject by blurring background and foreground details. Choose small apertures (high f-numbers) to bring both the background and main subject into focus.

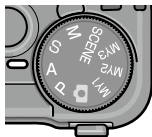

### 1 Choose mode A.

Rotate the mode dial to A. The current aperture is displayed in orange.

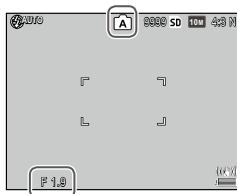

### 2 Choose an aperture.

Rotate the up-down dial to choose an aperture. Your selection only takes effect when the photo is taken; the effect cannot be previewed in the picture display.

### 3 Press the shutter-release button halfway.

Press the shutter-release button halfway to set focus and exposure. The shutter speed selected by the camera will be displayed in the picture display.

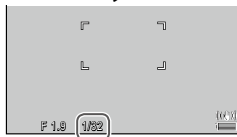

### 4 Take the photograph.

Gently press the shutter-release button the rest of the way down to shoot.

#### Note

- If **On** is selected for **Auto Aperture Shift** in the shooting menu (page 83), the camera will adjust aperture for optimal exposure.



## Mode S: Shutter Priority

In mode S (shutter priority), you choose the shutter speed and the camera selects the aperture. Choose fast shutter speeds to “freeze” motion, slow shutter speeds to suggest motion by blurring moving objects.

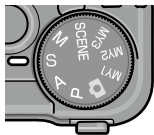

### 1 Choose mode S.

Rotate the mode dial to S. The current shutter speed is displayed in orange.

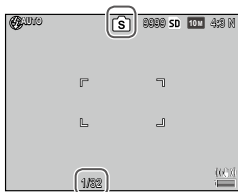

### 2 Choose shutter speed.

Rotate the up-down dial to choose a shutter speed.

### 3 Press the shutter-release button halfway.

Press the shutter-release button halfway to set focus and exposure. The aperture selected by the camera will be displayed in the picture display.

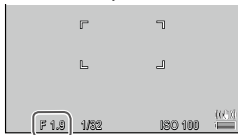

### 4 Take the photograph.

Gently press the shutter-release button the rest of the way down to shoot.



#### Note

- Maximum aperture (the lowest possible f-number) may not be selected at slow shutter speeds, even when the subject is poorly lit.

- If **On** is selected for **Shutter Speed Auto Shift** in the shooting menu (page 83), the shutter speeds are adjusted automatically to achieve optimal exposure when overexposed or underexposed.
- The monitor is off while shooting in a slow shutter speed.

### **Caution**

- Noise reduction is applied to an image if the shutter speed is set to more than 10 seconds. It may take a while to save the image.

## Mode M: Manual Exposure

In mode M (manual exposure), use the up-down dial to choose aperture and the **ADJ.** lever to select a shutter speed.

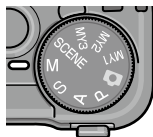

### 1 Choose mode M.

Rotate the mode dial to M. The shooting mode, exposure indicator, and current aperture and shutter speed appear in the display.

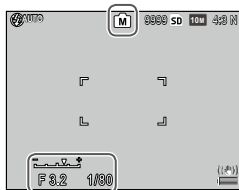

### 2 Choose an aperture and shutter speed.

Rotate the up-down dial to choose an aperture and press the **ADJ.** lever left or right to select a shutter speed (if desired, the roles of the two controls can be reversed; see page 121).

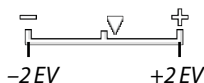

The effects can be previewed in the picture display and are reflected in the exposure indicator (if the image would be under- or over-exposed by more than 2 EV, the effects cannot be previewed and the indicator will turn orange).

### 3 Press the shutter-release button halfway.

Press the shutter-release button halfway to focus.

### 4 Take the photograph.

Gently press the shutter-release button the rest of the way down to shoot.



#### Note

- If **Auto** or **Auto-Hi** is selected for **ISO Setting** (page 82), ISO will be set to a value between 100 and 400 while the camera is in manual exposure mode.
- Functions assigned to  and  buttons, up-down dial, and **ADJ.** lever which are used in mode **M** can be changed in **M Mode Dial Options** and **One Press M Mode** in the key custom settings (pages 121 and 122).
- **B** (Bulb) or **T** (Time) can be selected for the shutter speed in mode **M**. In the **B** setting, the shutter is opened to expose while the shutter-release button is pressed. In the **T** setting, press the shutter-release button to open and close the shutter. The shooting ends automatically after 180 seconds elapsed. You can use an optional CA-2 cable switch wired remote shutter release. In the **B** and **T** settings, the following functions are not available.
  - Self-timer
  - Interval shooting
  - Bracketing
  - **One Press M Mode**
- If setting **Continuous Mode** in the shooting menu when **B** or **T** is selected, the shutter speed will be automatically set to 180 seconds. **B** or **T** setting cannot be selected if **Continuous Mode** has been selected.







#### Caution

- Noise reduction is applied to an image if the shutter speed is set to more than 10 seconds. It may take a while to save the image.

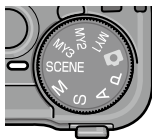
## SCENE Mode: Matching Settings to the Scene

Select **SCENE** mode to shoot movies or to choose from one of the following subject types. Camera settings are automatically optimized for the selected subject type.



Option	Description
 <b>DR</b> Dynamic Range	Choose for natural contrast when photographing subjects that are partly in the shade on a sunny day and other high-contrast scenes (page 44).
 <b>Interval Composite</b>	Synthesizes the bright parts of images which are taken in the interval shooting. This mode is useful for capturing the trail of stars and the moon etc (page 45).
 <b>Skew Correct Mode</b>	Reduce the effects of perspective when photographing rectangular objects, such as message boards or business cards (page 47).
 <b>Movie</b>	Shoot movies with sound (page 86).

To select a scene mode option:

### 1 Rotate the mode dial to **SCENE**.

The option currently selected for **SCENE** mode is displayed in the picture display.



- 2** Press MENU/OK.  
A menu of scene mode options will be displayed.

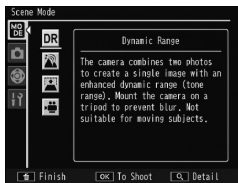

- 3** Select an option.  
Press ▲ or ▼ to highlight an option and press MENU/OK to exit to the selected shooting mode.
- 4** Shoot.
- **Dynamic range mode:** See page 44.
  - **Interval composite mode:** See page 45.
  - **Skew correct mode:** See page 47.
  - **Movie mode:** See page 86.

## SCENE Mode: Dynamic Range

Each time the shutter-release button is pressed, the camera takes two shots at different exposures, then combines the areas that are correctly exposed to create a single composite image with natural contrast, reducing loss of detail in highlights and shadows.



### 1 Mount the camera on a tripod.

### 2 Shoot.

Gently press the shutter-release button all the way down.

The camera will take two pictures and combine them to create a single image with an enhanced dynamic range.



#### **Note**

- Dynamic range shooting requires more time to create an exposure than other modes. Use a tripod. Note that the camera may move when the shutter-release button is pressed, even if mounted on a tripod. This can be prevented by using the self-timer (page 24) or an optional CA-2 cable switch wired remote shutter release.
- The following shooting menu options are available in dynamic range mode:
  - **Dynamic Range Expansion:** Choose amount by which dynamic range is enhanced (page 84).
  - **Plus Normal Shooting:** Choose **On** to record two copies of each photo, one with normal exposure and another with enhanced dynamic range (page 84).

- Dynamic range shooting is also available by selecting **Dynamic Range Compensation** in the shooting menu (page 72).

**Caution** 

- The flash turns off, digital zoom cannot be used, and RAW-quality options cannot be selected for **Picture Quality/Size** (page 53).
- The desired effect may not be achieved if the scene is too bright or too dark.
- Moving subjects may be blurred.
- Flicker from fluorescent lights may affect colors and brightness.

### **SCENE Mode: Interval Composite**

The bright parts of the pictures taken in the interval shooting are synthesized to create a single composite image. This mode is useful for capturing the trail of stars and the moon etc.

Set **Interval Composite Time** and **Save Interval Composite Img.** in the shooting menu beforehand (pages 84 and 85).

#### **1 Mount the camera on a tripod.**

#### **2 Take a test shot in mode M.**

Set up a composition and adjust the exposure, shutter speed, ISO sensitivity, white balance, and focus settings.

#### **3 Select **Interval Composite** in scene mode.**

## 4 Start shooting.

Press the shutter-release button. Photographs will be taken automatically at the selected interval.

To confirm the image in process, press the shutter-release button halfway. Pressing the shutter-release button all the way down saves the image, and start another interval composite shooting.

## 5 End shooting.

Press **MENU/OK** to end shooting when all the desired photographs have been taken.



### Caution

- The following functions are not available in interval composite mode.
  - Flash
  - Digital zoom
- If **MENU/OK** is pressed while image synthesis is in process, the image will not be synthesized.



### Note

- The values for the first shot are applied to the following settings of the succeeding shots.
  - **Auto** or **Auto-Hi** setting of **ISO Setting**
  - **Auto** setting of **White Balance**
- Autofocus and self-timer are available for the first shot only.
- Setting  $\infty$  for focus mode, and **1 second** for **Interval Composite Time** are recommended for capturing the trail of stars.
- ISO settings over **ISO 800** are not available.
- Shutter speeds longer than 60 seconds are not available.
- If **ISO 800** is selected, or **ISO 400** is selected when the shutter speed is set to 60 seconds, **MAX** setting is automatically applied to **Noise Reduction**.
- Confirm that a star is displayed in a dot in a test shot. The dots will create a star trail when images are synthesized.
- Use an optional external viewfinder (GV-1/GV-2) when shooting under low light condition.



## SCENE Mode: Skew Correct Mode

To take pictures in skew correct mode, frame the subject so that it occupies as much of the frame as possible.

### 1 Take a photograph.

Press the shutter-release button to take a photograph.

If the camera detects an object that can be used to correct perspective, a message will be displayed with the object shown by an orange frame. The camera can detect up to five objects.

### 2 Select a correction area.

Press **▶**.

Press **▲** to record the photograph without correcting perspective.

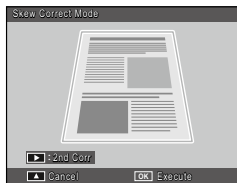

### 3 Press MENU/OK.



#### Caution

- The camera records two images each time the shutter is released: the unmodified photograph and a copy that has been processed to correct perspective. No photograph will be taken if memory is insufficient to record two images.
- The camera may not be able to correct perspective if:
  - The subject is out of focus.
  - The four edges of the subject are not clearly visible.
  - There is little contrast between the subject and the background.
  - The background contains many fine details.
- AE/AF target selection is not available in skew correct mode.

**Note**

- The **Skew Correction** option in the playback menu can be used to correct perspective in existing photographs (page 95).
- **1M 4:3 F** and **VGA 4:3 F** are the available options for **Picture Quality/Size** in skew correct mode.

## “MY” Modes: Using Custom Settings

To take photos using settings saved with the **Reg. My Settings** in key custom settings (page 112), rotate the mode dial to MY1/MY2/MY3.

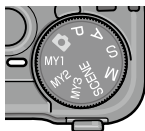

### 1 Rotate the mode dial to MY1, MY2, or MY3.

The shooting mode saved using **Reg. My Settings** will be displayed in the picture display.



### 2 Take the photograph.

**Note**

- Settings can be adjusted in “MY” modes. The settings saved with **Reg. My Settings** are restored when another mode is selected or the camera is turned off.

**Tip: Choosing a Shooting Mode**

- To choose a shooting mode in “MY” mode without changing other settings, use the **Switch Shooting Mode** option in the shooting menu (page 84). **Switch Shooting Mode** is not available in “MY” modes for which a scene mode is selected.

## The Shooting Menu

Use the ▲, ▼, ◀, ▶, and MENU/OK buttons to navigate the menus.

### 1 Display the shooting menu.

In modes other than **SCENE**, pressing the MENU/OK button in shooting mode displays the shooting menu.

 **Tip: SCENE Mode** 

- In scene mode, pressing MENU/OK displays the mode menu; press ◀ to highlight the mode tab, ▼ to display the shooting menu, and ▶ to place the cursor in the menu.

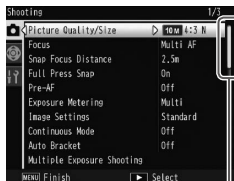

*Scroll bar shows position in menu*

### 2 Select a menu item.

Press ▲ or ▼ to highlight a menu item and press ▶ to display options for the highlighted item.

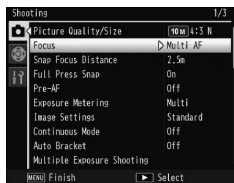

### 3 Select an option.

Press ▲ or ▼ to highlight an option. Press MENU/OK to select and exit to shooting mode, or press ◀ to select and return to the shooting menu.

The items available in the shooting menu vary with the shooting mode.

### 📷, P, A, S, M, MY1, MY2, MY3 and Multiple Exposure Shooting Modes

Option	Default	Page	Option	Default	Page
Picture Quality/Size	<b>10M</b> 4:3 N	53	Custom Self-Timer <sup>1</sup>	Pictures: 2 Pics Interval: 5 seconds	74
Focus	Multi AF	55			
Snap Focus Distance	Auto	60			
Full Press Snap	On	60	Interval Shooting	00 Hour 00 Min. 00 Sec.	75
Pre-AF	Off	61			
Exposure Metering	Multi	61	Date Imprint	Off	76
Image Settings	Standard	62	Exposure Compensation <sup>2</sup>	0.0	77
Continuous Mode <sup>1</sup>	Off	64	White Balance	Multi-P AUTO	78
Auto Bracket <sup>1</sup>	Off	67	White Balance Compensation	A: 0; G: 0	81
Multiple Exposure Shooting	Automatic Exposure: On Save Each Image: Off Saving image: Off	68	ISO Setting	Auto	82
			Magnification Ratio (MF)	2×	83
			Restore Defaults <sup>3</sup>	—	83
Flash Exposure Compensation	0.0	70	Auto Aperture Shift <sup>4</sup>	Off	83
Manual Flash Amount	1/2	71	Shutter Speed Auto Shift <sup>5</sup>	Off	83
Flash Synchro Settings	1st Curtain	71	Switch Shooting Mode <sup>6</sup>	—	84
Dynamic Range Compensation <sup>1</sup>	Off	72	1 Not available in multiple exposure shooting mode.		
Noise Reduction	Off	73	2 Not available in mode M.		
Noise Reduction ISO	Over ISO 401	73	3 📷 mode only.		
Move Target Setting	AF	74	4 Mode A only.		
Camera Shake Cor- rection	On	74	5 Mode S only.		
			6 Mode MY1, MY2 or MY3 only.		

## SCENE Mode: Dynamic Range

Option	Default	Page	Option	Default	Page
Dynamic Range Expansion	Weak	84	Move Target Setting	AF	74
Plus Normal Shooting	Off	84	Custom Self-Timer	Pictures: 2 Pics Interval: 5 seconds	74
Picture Quality/Size	<b>10M</b> 4:3N	53			
Focus	Multi AF	55	Date Imprint	Off	76
Snap Focus Distance	2.5 m	60	Exposure Compensation	0.0	77
Pre-AF	Off	61	White Balance	Multi-P AUTO	78
Exposure Metering	Multi	61	White Balance Compensation	A: 0; G: 0	81
Image Settings	Standard	62	ISO Setting	Auto	82
Noise Reduction	Off	73	Magnification Ratio (MF)	2×	83
Noise Reduction ISO	Over ISO 401	73			

## SCENE: Interval Composite

Option	Default	Page	Option	Default	Page
Interval Composite Time	0h00m00s	84	Noise Reduction ISO	Over ISO 401	73
Save Interval Composite Img.	Off	85	Camera Shake Correction	On	74
Picture Quality/Size	<b>10M</b> 4:3N	53	Date Imprint	Off	76
Focus	Multi AF	55	White Balance	Auto	78
Exposure Metering	Multi	61	White Balance Compensation	A: 0; G: 0	81
Image Settings	Standard	62	ISO Setting	Auto	82
Dynamic Range Compensation	Off	72	Magnification Ratio (MF)	2×	83
Noise Reduction	Off	73			

**SCENE Mode: Skew Correct Mode**

Option	Default	Page	Option	Default	Page
Picture Quality/Size	<b>1M</b> 4:3N	53	Flash Exposure Compensation	0.0	70
Focus	Multi AF	55	Flash Synchro Settings	1st Curtain	71
Snap Focus Distance	2.5 m	60	Date Imprint	Off	76
Full Press Snap	On	60	Exposure Compensation	0.0	77
Pre-AF	Off	61	White Balance	Multi-P AUTO	78
Exposure Metering	Multi	61	ISO Setting	Auto	82
Image Settings	Standard	62	Magnification Ratio (MF)	2×	83

**SCENE Mode: Movie**

Option	Default	Page	Option	Default	Page
Movie Size	<b>VGA</b> 640	87	White Balance	Multi-P Auto	78
Frame Rate	30 Frame/Sec	87	White Balance Compensation	A: 0, G: 0	81
Focus	Multi AF	55	Magnification Ratio (MF)	2×	83
Snap Focus Distance	2.5 m	60			
Pre-AF	Off	61			

## Picture Quality/Size



Picture quality (RAW, fine, and normal) and size (dimensions in pixels) determine the number of photographs that can be stored in internal memory or on a memory card (page 153). The following options are available:

Option	Quality	Size
<b>RAW</b> 4:3	RAW	3,648 × 2,736
<b>RAW</b> 3:2		3,648 × 2,432
<b>RAW</b> 16:9		3,648 × 2,048
<b>RAW</b> 1:1		2,736 × 2,736
<b>10M</b> 4:3 F	Fine	3,648 × 2,736
<b>10M</b> 4:3 N (default)	Normal	
<b>9M</b> 3:2 F	Fine	3,648 × 2,432
<b>9M</b> 3:2 N	Normal	
<b>7M</b> 16:9 F	Fine	3,648 × 2,048
<b>7M</b> 16:9 N	Normal	
<b>7M</b> 1:1 F	Fine	2,736 × 2,736
<b>7M</b> 1:1 N	Normal	
<b>8M</b> 4:3 F	Fine	3,264 × 2,448
<b>5M</b> 4:3 F		2,592 × 1,944
<b>3M</b> 4:3 F		2,048 × 1,536
<b>1M</b> 4:3 F		1,280 × 960
<b>VGA</b> 4:3 F		640 × 480





Choose how the camera focuses.

Option	Description
<b>Multi AF</b>	The camera selects the focus area with the closest subject, preventing out-of-focus shots by keeping the camera from focusing on the background (default).
<b>Spot AF</b>	Focus on the subject in the center of the frame.
<b>Subj. Tracking</b>	<p>The camera tracks and focuses on the selected subject.</p> <p>Frame the subject to set as the tracking target in the center of the picture display, and press the shutter-release button halfway to set the target. The target subject is framed with a green box.</p> <p>If missing the target subject while tracking, the green box turns red and blinks.</p> <p>Tracking is canceled when the target subject is out of the picture frame, the shutter-release button is released, or after finishing the shooting.</p>
 <b>MF</b> (manual focus)	Focus manually (page 58).
 <b>Snap</b>	Focus is fixed at distance selected with <b>Snap Focus Distance</b> (page 60) for quick shutter response.
 $\infty$ (infinity)	Fix the focus distance at infinity when photographing distant scenes.

The camera measures the distance to a subject using the external AF sensor (except for **Subj. Tracking** focus). If **On** is selected for **Optional AF Distance Display** in the setup menu (page 126), the distance to the subject is displayed in the picture display.

*AF distance display*

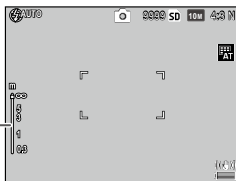

At setting of **MF**, the focus bar is displayed. At settings of **MF**, **Snap**, and  $\infty$  in mode **A** and **M**, the focus bar and the depth of field are displayed.

If **On** is selected for **Optional AF Distance Display** when **Auto** is selected for **Snap Focus Distance**, AF distance is displayed.

*Depth of field*

*Focus bar*

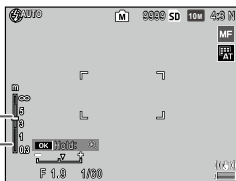

Distances and the depth of field in the focus bar are approximate.



## Note

- **Focus** can be assigned to the **ADJ.** lever in **ADJ Lever Setting** (page 117) or **Fn** buttons in **Fn Button Pair Setting** (page 119). The **Fn** buttons can be used to switch back and forth between autofocus and manual focus/snap focus/subject tracking focus.
- The following functions are not available for **Subj. Tracking** focus mode.
  - Custom setting of the self-timer
  - Interval shooting
  - Bracketing
  - AE/AF target selection
  - Macro target
- If selecting **On** for **Pre-AF** in the shooting menu (page 61), the camera automatically focuses on a subject in **Multi AF** or **Spot AF** mode even if the shutter-release button is not pressed halfway. This mode increases the drain on the battery.
- The external AF sensor is turned off and AF distance is not displayed when using the camera with AAA batteries or with an optional wide conversion lens on.
- If **On** is selected for **Optional AF Distance Display** (page 126), select **Off** for **Sleep Mode** and **LCD Auto Dim** in the setup menu.
- When focus distance metering by the external AF sensor is not available, **2.5m** (8.2 ft) is set for the **Auto** setting of **Snap Focus Distance**.

## Focus: MF (Manual Focus)

Manual focus can be used to lock focus over a series of photographs or to focus when the camera is unable to focus using autofocus.

### 1 Select MF (manual focus).

Select **MF** in the **Focus** menu.

The focus mode and focus bar are displayed in the picture display.



### 2 Choose the focus distance.

Press ▲ to increase the focus distance, ▼ to decrease.

To zoom in on the subject in the center of the picture display and check focus, press and hold the **MENU/OK** button. Press and hold the button again to return to the normal shooting display.

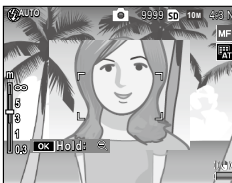

### 3 Take the picture.



#### Note

- The camera can focus on the subject at a close distance in the macro mode using the manual focus.
- The zoom ratio for the zoom by pressing and holding **MENU/OK** button can be selected from **2x** and **4x** in **Magnification Ratio (MF)** in the shooting menu (page 83).

## Choosing the Focus and Metering Target

Target selection can be used to set focus and exposure for off-center subjects without moving the camera, making it easier to use a tripod.

Select a type of target in **Move Target Setting** in the shooting menu beforehand (page 74).

### 1 Activate target selection.

Press the **ADJ.** lever in and then press the lever left or right to highlight  and press **MENU/OK**.

### 2 Position the target.

Using the **▲**, **▼**, **◀**, and **▶** buttons, position the cross hairs over your subject and press **MENU/OK** (to return to the target selection menu, press the **DISP.** button).

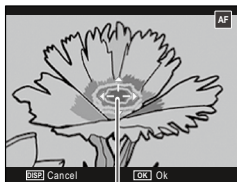

Target

### 3 Take the picture.



#### Note

- Target selection is not available in subject tracking and manual focus modes (page 55).
- AF target selection remains in effect until a new target is selected.
- Target selection is canceled if changing to the manual focus mode.
- The **Fn** buttons can be used for focus target selection in macro mode if **Macro Target** is selected for **Fn Button Pair Setting** (page 119). Press  or **▼** to cancel the target selection function.
- AE/AF target selection cannot be used with the macro target function. To use the macro target function, press the **DISP.** button to cancel the target selection in AE/AF target selection mode.

- For using the functions assigned to the **ADJ.** lever 1 to 5, press the **DISP.** button to cancel the target selection.

### Snap Focus Distance

Select the distance at which the camera focuses when **Snap** is selected for **Focus** (page 55) or **Full Press Snap** is on (page 60). Choose from **Auto**, **1 m** (3.3 ft.), **1.5 m** (4.9 ft.), **2.5 m** (8.2 ft.), **5 m** (16.4 ft.), and  $\infty$  (infinity).

### Full Press Snap

Take photographs without pausing to focus when **Multi AF**, **Spot AF**, or **Subj. Tracking** is selected for **Focus** (page 55).

Option	Description
<b>Off</b>	The camera focuses normally.
<b>On</b>	If the shutter-release button is pressed all the way down in one motion, the camera will take a picture at the focus distance selected for <b>Snap Focus Distance</b> (page 60). Choose when quick shutter response is required.
<b>Auto-Hi ISO</b>	As for <b>On</b> , except that ISO sensitivity is automatically set to <b>Auto-Hi</b> (page 82).

### **Caution** ~~~~~

- Full press snap is not available in macro mode or when **MF**, **Snap**, or  $\infty$  is selected for **Focus**.
- Care is required to avoid blur caused by camera movement.

### **Note** ~~~~~

- The camera will focus normally if you pause with the shutter-release button pressed halfway.
- If **Auto** is selected for **Snap Focus Distance**, the camera focuses according to the focus distance measured by the external AF sensor. When focus distance metering by the external AF sensor is not available, **2.5 m** (8.2 ft.) is set for **Snap Focus Distance**.

## Pre-AF

If **On** is selected when **Multi AF** or **Spot AF** is selected for **Focus** (page 55), the camera will continue to focus even when the shutter-release button is not pressed halfway (the focus range, however, is narrower than for normal focus). This may decrease the time needed to focus when a picture is taken, potentially improving shutter response.



### Caution

- Using pre-AF increases the drain on the battery.

## Exposure Metering

Choose how the camera measures exposure.

Option	Description
<b>Multi</b>	The camera meters exposure in 256 areas of the frame (default).
<b>Center</b>	The camera meters the entire frame but assigns the greatest weight to the center. Use when the subject in the center of the frame is brighter or darker than the background.
<b>Spot</b>	The camera meters only the subject in the center of the frame, ensuring that it is correctly exposed even when it is markedly brighter or darker than the background.

Settings of **Center** and **Spot** are shown by an icon in the picture display.













### Note

- **Exposure Metering** can be assigned to the **ADJ.** lever in **ADJ. Lever Setting** (page 117) or **Fn** buttons in **Fn Button Pair Setting** (page 119).

## Image Settings

Adjust contrast, sharpness, and vividness (color depth) or take monochrome photographs.

Option	Description
 <b>Vivid</b>	Take strong, vivid photos with heightened contrast and sharpness and maximum vividness.
 <b>Standard</b>	Normal contrast, sharpness, and vividness (default).
 <b>Setting 1</b>	Make individual adjustments to vividness, contrast, sharpness, and colors to create custom settings that can be recalled as desired.
 <b>Setting 2</b>	
 <b>Black &amp; White</b>	Take photos in black and white. Contrast and sharpness can be adjusted manually.
 <b>B&amp;W (TE)</b> (toning effect)	Create monochrome photos with a sepia, red, green, blue, or purple tint. Hue, vividness, contrast, and sharpness can be adjusted manually.
 <b>Hi-Contrast B&amp;W</b>	Emphasizes the contrast to the effect of the <b>Black &amp; White</b> setting creating images of like a super-sensitive film or images developed with sensitizing. Contrast, sharpness, and vignetting can be adjusted manually.
 <b>Cross Process</b>	Take photos by adding a hue different from the actual hue. Hue, contrast, and vignetting can be adjusted manually.
 <b>Positive Film</b>	Take photos in high vividness creating images like positive film. Vividness, contrast, sharpness, and vignetting can be adjusted manually.
 <b>Bleach Bypass</b>	Take photos by reducing vividness and increasing contrast. Hue, contrast, sharpness, and vignetting can be adjusted manually.



**Note**

- Image setting is not applied to a RAW image. If **RAW only** is selected for **RAW/JPEG Setting** (page 130), image setting has no effect.
- If a RAW-quality option is selected for **Picture Quality/Size** in the shooting menu, **Hi-Contrast B&W**, **Cross Process**, **Positive Film**, and **Bleach Bypass** have no effect.
- **Hi-Contrast B&W** has no effect in continuous shooting mode.
- If **Hi-Contrast B&W**, **Cross Process**, **Positive Film**, or **Bleach Bypass** is selected, **Subj. Tracking** in the focus mode has no effect.
- If **Black & White**, **B&W (TE)**, or **Hi-Contrast B&W** is selected, **WB-BKT** has no effect.
- **Noise Reduction** in the shooting settings has no effect when **Hi-Contrast B&W** is selected.

To make individual adjustments to the settings, highlight the desired option and press ►.

## 1 Adjust settings.

Press ▲ and ▼ to highlight an option and press ◀ and ▶ to change.



*Setting 1/Setting 2*

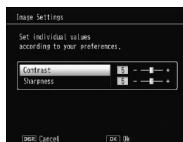

*Black & White*

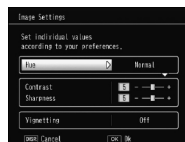

*Bleach Bypass*

## 2 Press MENU/OK.

Press MENU/OK to return to the **Image Settings** menu when settings are complete.

### 3 Exit to shooting mode.

Press MENU/OK.

The option currently selected for **Image Settings** will be displayed in the picture display.





#### Note

- **Image Settings** can be assigned to the **ADJ.** lever in **ADJ Lever Setting** (page 117) or **Fn** buttons in **Fn Button Pair Setting** (page 119).

**Fn** buttons can be used to switch image settings if **Color>B&W**, **Color>TE**, **Color>High B&W**, **Color>Cross**, **Color>Pos. Film**, **Color>B Bypass** is selected for **Fn Button Pair Setting**.

### Continuous Mode

Shoot photographs in continuous sequence. The following options are available:

-  **Continuous**: The camera records photographs one after the other while the shutter-release button is pressed.
-  **AF-Cont**: The camera shoots by trailing a target subject using the external AF sensor while the shutter-release button is pressed.

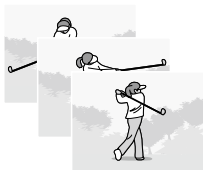

-  **S-Cont** (stream continuous): While the shutter-release button is pressed, the camera shoots up to 16 frames at about 7.5 frames per second and joins them to form a single image (**10M** in size). About 2s are required to shoot the entire sequence.

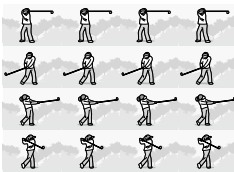

-  **M-Cont** (memory-reversal continuous): The camera shoots while the shutter-release button is pressed, but only the last 16 frames (about the last two seconds of shooting) are recorded, creating a single image (**10M** in size).

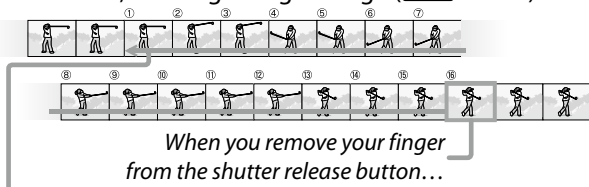

...the camera records the last 16 frames taken (frames ① to ⑯).

At settings other than **Off**, the current selection is shown by an icon in the picture display.



To cancel the continuous shooting mode, select **Off** for **Continuous Mode**.



### Note

- In the **S-Cont** and **M-Cont** modes, **Normal** setting is applied automatically for **Digital Zoom Image** even if **Auto Resize** is selected (page 131).
- In the **AF-Cont** mode, **Multi AF** setting is applied automatically to **Focus**.
- At settings other than **Off**, the flash turns off automatically, focus and exposure are fixed with the first shot in each series, and **Auto** white balance is used in place of **Multi-P AUTO** (page 78).
- In the **S-Cont** and **M-Cont** modes, **ISO AUTO** setting is applied automatically for **ISO Setting** even if a setting from **ISO 80** to **ISO 250** is selected.

- If releasing the shutter-release button within two seconds in **M-Cont** mode, the number of recorded photographs will be less than 16 images.
- The number of photographs that can be taken in succession depends on the picture size.
- The maximum number of photographs that can be taken in succession is 999. Even if the number of exposures remaining is more than 1000, 999 is displayed in the picture display.
- When **On** is selected for **Card Sequence No.** in the setup menu (page 132), if the last four digits of a file number exceeds 9999 while shooting in the continuous mode, a new folder is created automatically in a memory card and the shooting is continued.
- **Continuous Mode** can be assigned to the **ADJ.** lever in **ADJ Lever Setting** (page 117) or **Fn** buttons in **Fn Button Pair Setting** (page 119).





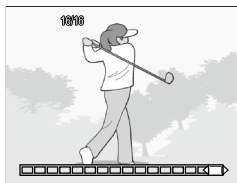

 **Tip: Viewing S-Cont and M-Cont Images with Playback Zoom** 

- Zoom can be used to view the individual frames of **S-Cont** and **M-Cont** images during playback. Pressing the **Q** button while an image taken with either of these options is displayed in single-frame playback displays the first frame in the sequence; use the ◀ and ▶ buttons to display other frames. Your current position in the sequence is shown by strip at the bottom of the display (the **DISP.** button can be used to hide the strip; see page 33). Press **MENU/OK** to exit.



## Auto Bracket

Vary exposure, white balance, or color to record two or three images “bracketing” current settings.

Option	Description
 <b>AE-BKT</b> <b>1/3EV</b>	Each time the shutter-release button is pressed, the camera takes three photos: one underexposed by 0.3 EV, a second at current exposure settings, and a third overexposed by 0.3 EV. Choose when you find it difficult to judge the correct exposure.
 <b>AE-BKT</b> <b>1/2EV</b>	As above, except that the camera varies exposure by 0.5 EV with each shot instead of 0.3 EV.
 <b>WB-BKT</b>	The camera records three copies of each photo: one with a “warm,” reddish cast, a second at the white balance currently selected in the shooting menu (page 78), and a third with a “cool,” blueish cast. Choose when you find it difficult to select the correct white balance.
 <b>Img. Set.</b> <b>BKT</b>	The camera takes three photos in three different picture qualities. The picture quality for the second and third picture can be selected.
 <b>DR-BKT</b>	The camera takes three photos in three different dynamic range compensation settings: one without the dynamic range compensation, a second with <b>Weak</b> setting, and a third with <b>Strong</b> setting.
 <b>CONTRAST-</b> <b>BKT</b>	The camera takes photos in different contrasts.



### Note

- Bracketing is not available when an option other than **Off** is selected for **Continuous**.
- **WB-BKT** is not available when shooting monochrome photographs.
- **AE-BKT 1/3EV** and **AE-BKT 1/2EV** are the available options when a RAW-quality option is selected for **Picture Quality/Size** (page 53).
- The flash turns off automatically when bracketing is in effect.

To make adjustments to the settings for **AE-BKT 1/3EV** or **AE-BKT 1/2EV**, highlight the desired option and press **▶**.

## 1 Set the exposure settings.

Press **◀** and **▶** to highlight an option and press **▲** and **▼** to set the exposure value.

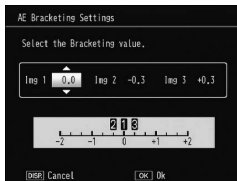

## 2 Press MENU/OK.

### Caution

- **Auto** white balance setting is applied even when **Multi-P AUTO** is selected for **White Balance** in the shooting menu (page 78).

### Note

- **Auto Bracket** can be assigned to the **ADJ.** lever in **ADJ Lever Setting** (page 117) or **Fn** buttons in **Fn Button Pair Setting** (page 119).

## Multiple Exposure Shooting

Shoot a picture by synthesizing up to five images.

## 1 Select On or Off for options.

Press **▲** or **▼** to select an option, and select **On** or **Off**.

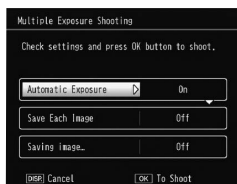

Option	Description
<b>Automatic Exposure</b>	Select <b>On</b> to shoot pictures by automatically adjusting the amount of exposure according to the number of pictures to synthesize.
<b>Save Each Image</b>	Select <b>On</b> to save original pictures separately from a composite image. Selecting <b>Off</b> does not save original pictures but a composite image only.
<b>Saving image</b>	Select <b>On</b> to save images at each synthesis. Selecting <b>Off</b> saves a composite image only.

## 2 Press MENU/OK.

To exit the multiple exposure shooting mode, press the DISP. button.

## 3 Take pictures.

Press the shutter-release button to take the first picture. Select **Next shot** and press MENU/OK to take the next picture. Repeat the procedures to take all the pictures (select **Retake shot** to cancel and retake an image), and select **Complete** to finish. A composite image is saved.

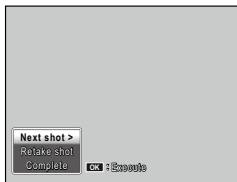

### Caution

- After taking five pictures, a composite image is saved automatically.
- Multiple exposure shooting is not available in scene mode.
- The following functions are not available in the multiple exposure shooting mode.
  - Continuous shooting
  - Digital zoom
  - Bracketing
  - Interval shooting
- Image settings cannot be adjusted while shooting.

**Note**

- If assigning **Multiple Exposure Shooting** to **Fn** buttons, pressing **Fn1** or **Fn2** button takes pictures in the multiple exposure shooting mode.

**Flash Exposure Compensation**

Adjust flash level by  $-2.0$  to  $+2.0$  in steps of  $\frac{1}{3}$ EV. Selecting **Flash Exposure Compensation** in the shooting menu displays the slider; press  $\blacktriangle$  or  $\blacktriangledown$  to choose a flash exposure compensation value and press **MENU/OK**.

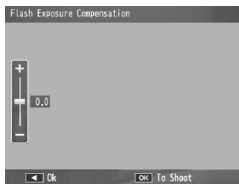

Flash exposure compensation is displayed in the picture display except when the flash is off.

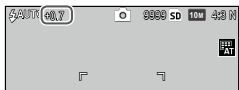
**Caution**

- Flash exposure compensation may have no effect outside the range of the flash (page 23).

**Note**

- **Flash Exposure Compensation** can be assigned to the **ADJ.** lever in **ADJ Lever Setting** (page 117) or **Fn** buttons in **Fn Button Pair Setting** (page 119).



## Manual Flash Amount

Choose amount of light produced by the flash in manual flash mode (page 22). Flash output is expressed as a fraction of full power (all values are approximate):

FULL 1/1.4 1/2 1/2.8 1/4 1/5.6 1/8 1/11 1/16 1/22 1/32 1/64

Flash level is displayed in the picture display in manual flash mode.

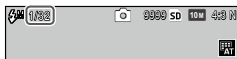

### Note

- **Flash Exposure Compensation** has no effect in manual flash mode, and **Manual Flash Amount** setting is applied instead.
- The actual flash amount may differ from the setting in **Manual Flash Amount**.
- **Manual Flash Amount** can be assigned to the **ADJ.** lever in **ADJ Lever Setting** (page 117) or **Fn** buttons in **Fn Button Pair Setting** (page 119).

## Flash Synchro Settings

Choose how the flash synchronizes with the shutter.

- **1st Curtain:** The flash fires at the beginning of the exposure (default).
- **2nd Curtain:** The flash fires at the end of the exposure. This option produces trails of light behind moving light sources.

## Dynamic Range Compensation

The camera captures a wide range of tones from dark to bright. The intensity can be selected from **Weak**, **Medium**, or **Strong**.

An indicator is displayed in the picture display when dynamic range compensation is set.

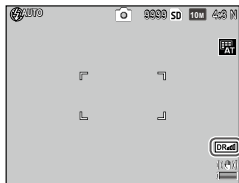

### Caution

- Available ISO settings are limited in dynamic range compensation mode.
  - **Weak:** ISO 125 to ISO 2500
  - **Medium:** ISO 160 to ISO 1600
  - **Strong:** ISO 200 to ISO 1250
- If **Strong** is selected, more noise are likely to occur in images.
- If using the digital zoom, **Dynamic Range Compensation** has no effect.
- **Dynamic Range Compensation** is not available for multiple exposure shooting.
- The desired effect may not be achieved if the scene is too bright or too dark.

### Note

- Setting **Multi** for **Exposure Metering** is recommended when using the dynamic range compensation function (page 61).
- Dynamic range compensation can be applied to a RAW image.
- **Dynamic Range Compensation** can be assigned to the **ADJ.** lever in **ADJ Lever Setting** (page 117) and **Fn** buttons in **Fn Button Pair Setting** (page 119).

## Noise Reduction

Choose **Weak**, **Strong**, or **MAX** to reduce “noise” (random variations in brightness and color) in photographs taken at high ISO sensitivities.

The minimum ISO sensitivity at which noise reduction applies can be selected using **Noise Reduction ISO** (see below).

An indicator is displayed when noise reduction is on.



### Note

- When a RAW-quality option is selected for **Picture Quality/Size**, noise reduction applies only to the JPEG copy, not to the DNG file.
- The time needed to record photographs varies with the option selected for **Noise Reduction**.

## Noise Reduction ISO

Select the minimum ISO sensitivity at which noise reduction applies when **Weak**, **Strong**, or **MAX** is selected for **Noise Reduction**. Choose from **All** (noise reduction applies at all ISO sensitivities), **Over ISO 201**, **Over ISO 401**, **Over ISO 801**, and **Over ISO 1601**.

## Move Target Setting

Select a type of target for the target selection function (page 59).

Option	Description
AE/AF	Spot metering and spot autofocus; choose the focus and exposure target.
AF	Spot autofocus (default); choose the focus target. Exposure is metered using the option selected for <b>Exposure Metering</b> (page 61).
AE	Spot metering; choose the metering target. Focus is set using the option selected for <b>Focus</b> (page 55).

## Camera Shake Correction

Choose **On** to prevent blur caused by camera shake.

### **Caution**

- The camera shake correction function is not available when the shutter speed is set to **B**, **T**, or more than 1 second in mode **M**, the self-timer is set, or using an optional cable switch.
- The camera shake correction function cannot prevent the blur caused by the movement of the subject.
- Effects of the camera shake correction function differ depending on the shooting conditions.

## Custom Self-Timer

Set the number of pictures and the shooting interval for the self-timer shooting.

- **Pictures:** Set the number of pictures to be taken from 1 to 10 pictures (default: 2).
- **Interval:** Set the interval between 5 to 10 seconds (default: 5).



## Note

- If the number of pictures is set to more than two, the focus is fixed to the position set in the first picture.

## Interval Shooting

To take photos automatically at intervals of from five seconds to one hour, select **Interval Shooting** in the shooting menu and follow the steps below:

### 1 Choose an interval.

Press ◀ and ▶ to highlight hours, minutes, or seconds and press ▲ and ▼ to change. Press **MENU/OK** to exit to shooting mode.

**Interval** will be displayed in the picture display.

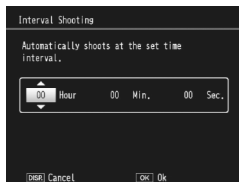

### 2 Start shooting.

Press the shutter-release button. Photographs will be taken automatically at the selected interval.

### 3 End shooting.

Press **MENU/OK** to end shooting when all the desired photographs have been taken.



## Caution

- Interval shooting is not available in scene mode.
- If the time needed to record photographs is longer than the selected interval, the next photograph will not be taken until recording is complete.

**Note**

- The interval resets to zero when the camera is turned off.
- Use a fully-charged battery or optional AC adapter and be sure that sufficient space remains in internal memory or on the memory card. Interval shooting ends automatically when the number of exposures remaining reaches zero.
- Photographs can be taken at any time by pressing the shutter-release button.
- **Continuous Mode** is set to **Off** automatically in the interval shooting.

**Date Imprint**

Imprint the date (YY/MM/DD) or date and time (YY/MM/DD hh:mm) on photographs as they are taken.

An indicator is displayed in the picture display when date imprint is on.

**Note**

- Date imprint is not available when the clock is not set. Set the clock (page 17) before using date imprint.
- The date cannot be imprinted on movies.
- When a RAW-quality option is selected for **Picture Quality/Size**, the date is imprinted only on the JPEG copy, not the DNG file.
- The date is permanently imprinted on the image and cannot be removed.

## Exposure Compensation

The camera automatically adjusts exposure for the subject in the center of the frame, producing optimal exposure.

### 1 Display the exposure compensation slider.

Selecting **Exposure Compensation** in the shooting menu displays the slider.

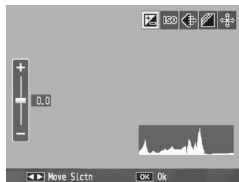

### 2 Adjust exposure compensation.

Press **▲** or **▼** to choose an exposure compensation value. Press the shutter-release button to take a picture or press **MENU/OK** to exit to shooting mode.

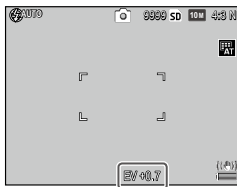

#### **Caution** .....

- Exposure compensation is not available in mode **M**, interval composite shooting and movie mode.









#### **Note** .....

- Exposure Compensation** can be assigned to the **ADJ.** lever in **ADJ Lever Setting** (page 117), **Fn** buttons in **Fn Button Pair Setting** (page 119), or **Q** and **☑** buttons in **Zoom Button** (page 121).

## White Balance

The camera automatically adjusts white balance so that a white subject will appear white regardless of the color of the light source.

Select an option to match white balance to the light source under mixed lighting or when photographing a subject that is a solid color.

Option	Description
 <b>Auto</b>	The camera adjusts white balance automatically.
 <b>Multi-P AUTO</b>	The camera adjusts white balance to account for differences in lighting in separate areas of the frame (default).
 <b>Outdoors</b>	Use when shooting in daylight under clear skies.
 <b>Cloudy</b>	Use when shooting in daylight under cloudy skies.
 <b>Incandescent 1</b>	Use with incandescent lighting.
 <b>Incandescent 2</b>	Pictures taken in the <b>Incandescent 2</b> setting are tinged with reddish cast comparing to the <b>Incandescent 1</b> .
 <b>Fluorescent Lamp</b>	Use with fluorescent lighting.
 <b>Manual Settings</b>	Measure white balance manually (page 80).
 <b>Detail</b>	Make fine adjustments to white balance (page 80).

### 1 Display white balance options.

Select **White Balance** in the shooting menu.

### 2 Select a white balance option.

Press ▲ or ▼ to select an option. Press the shutter-release button to take a picture or press **MENU/OK** to exit to shooting mode.



The current selection is shown by an icon in the picture display.



**Note** .....

- **White Balance** can be assigned to the **ADJ.** lever in **ADJ Lever Setting** (page 117), **Fn** buttons in **Fn Button Pair Setting** (page 119), or  and  buttons in **Zoom Button** (page 121).

**Caution** .....

- **Auto** white balance may not produce the desired results with scenes lacking white objects. This can be corrected by adding a white object to the scene before shooting.
- Options other than **Auto** may not produce the desired results when the flash is used. Select **Auto** when using the flash.
- **Auto** setting is applied automatically in the following cases even if **Multi-P AUTO** is selected.
  - In the interval composite shooting (scene mode)
  - In the continuous shooting
  - If **AE-BKT 1/3EV** or **AE-BKT 1/2EV** is selected for **Auto Bracket**

## Manual: Measuring White Balance

To measure a value for white balance:

### 1 Select Manual Settings.

Highlight  **Manual Settings** in the white balance menu.

### 2 Measure white balance.

Frame a blank piece of paper or other white object so that it fills the frame and press the **DISP.** button.

### 3 Press MENU/OK.



#### Note

- The area to measure the white balance in can be selected in **Area measured for manual WB** in the setup menu (page 131).
- When the flash setting is on, the white balance for when the flash fires can be measured by pressing the **DISP.** button.

## Detail: Making Fine Adjustments to White Balance

To make fine adjustments to white balance:

### 1 Select Detail.

Highlight  **Detail** in the white balance menu and press the **DISP.** button.

### 2 Choose a setting.

Press **▲** or **▼** to choose a white balance. Press **MENU/OK** when settings are complete.



### 3 Press MENU/OK.

## White Balance Compensation

Compensate for color casts by modifying white balance on the green-magenta or blue-amber axis. The modifications apply to the option currently selected for white balance and to all options selected while the modifications are in effect.

### 1 Display white balance compensation controls.

Selecting **White Balance Compensation** in the shooting menu (page 49) displays the controls.

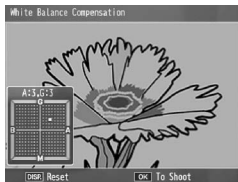

### 2 Compensate color casts.

Choose white balance compensation using the ▲, ▼, ◀, or ▶ button.

Press the **DISP.** button to reset white balance compensation to a neutral value.

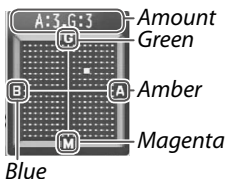

### 3 Press MENU/OK.

Press the **DISP.** button twice to cancel.



#### Note

- **White Balance Compensation** can be assigned to the **ADJ.** lever in **ADJ Lever Setting** (page 117) or **Fn** buttons in **Fn Button Pair Setting** (page 119).
- When the mode dial is rotated to **SCENE**, white balance compensation is only available in dynamic range, interval composite and movie modes.
- The **White Balance Compensation** option in the playback menu (page 99) does not use the same values as the shooting menu option.

## ISO Setting

Adjust the camera's sensitivity to light.

- **Auto:** The camera automatically adjusts sensitivity according to brightness, the distance to the subject, and the options selected for macro mode and picture quality and size.
- **Auto-Hi** (high sensitivity auto): As above, except that the camera selects higher sensitivities when the subject is poorly lit. The maximum sensitivity and the shutter speed to shift the value of ISO sensitivity can be selected in the setup menu (page 124).
- **ISO 80–ISO 3200:** Sensitivity is set to the selected value.



### Note

- Step value for ISO sensitivity can be selected from **1EV** or **1/3EV** in **ISO Step Setting** in the setup menu (page 124).
- "Noise" (random variations in brightness and color) may appear in photographs taken at high sensitivities.
- The sensitivity displayed in the picture display in **Auto** and **Auto-Hi** modes may differ from the actual value. If the flash is used, a sensitivity of **Auto** is equivalent to ISO 154, regardless of the value displayed in the picture display. The range of sensitivities available in **Auto** mode when the flash is off is shown below:

Picture size	ISO sensitivity		
	Default	Min.	Max.
VGA	100	80	283
1M			238
3M			176
Over 5M			154

- Available ISO settings are limited in dynamic range compensation shooting (page 72).

- If **On** is selected for **ADJ. Direct ISO Control** in the key custom settings, ISO sensitivity can be changed by pressing the **ADJ.** lever left or right in the shooting mode. In mode **P** and **A**, ISO sensitivity can be also changed by pressing the shutter-release button halfway.
- **ISO Setting** can be assigned to the **ADJ.** lever in **ADJ Lever Setting** (page 117) or **Fn** buttons in **Fn Button Pair Setting** (page 119).

### Magnification Ratio (MF)

The zoom ratio for the zoom by pressing and holding **MENU/OK** button can be selected from **2 x** and **4 x**.

### Restore Defaults

To restore default shooting menu settings (pages 50–52), rotate the mode dial to  and select **Restore Defaults** in the shooting menu. A confirmation dialog will be displayed; highlight **Yes** and press **MENU/OK** to restore default values and exit to shooting mode.

### Auto Aperture Shift

If **On** is selected, the camera will automatically adjust aperture to prevent overexposure in mode **A**.



**Note**

- Auto aperture shift is available only in mode **A**.

### Shutter Speed Auto Shift

If **On** is selected, the shutter speeds are adjusted automatically to achieve optimal exposure when overexposed or underexposed.

## Switch Shooting Mode

When the mode dial is rotated to a “MY” mode (page 48), you can use this option to switch between , P, A, S, and M modes without rotating the mode dial to a new setting. This option is only available in “MY” modes and is not displayed if the shooting mode currently selected for **Reg. My Settings** is a scene mode.

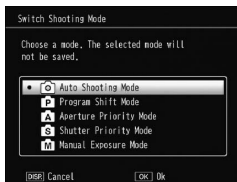

## Dynamic Range Expansion

Choose the dynamic range expansion from **Weak**, **Medium**, or **Strong**.

The range of brightness to be processed extends by selecting the stronger effect.

## Plus Normal Shooting

Choose **On** to record two copies in the dynamic range shooting, one with normal exposure and another with enhanced dynamic range.

## Interval Composite Time

Set the shooting interval between 1 second and 1 hour for the interval composite shooting.

### **Note**

- Set the interval longer than the shutter speed.

## Save Interval Composite Img.

Select an option for saving images in the interval composite shooting.

- **Off:** Saves a composite image only.
- **Save Each Image:** Saves original pictures separately from a composite image.
- **Saving image:** Saves images at each synthesis.

This section describes how to record and view movies.

## Recording Movies

Shoot movies with sound. Movies are stored as AVI files.

**1** Rotate the mode dial to **SCENE**.

**2** Press **MENU/OK**.

A menu of scene mode options will be displayed.

**3** Select .

Press **▲** or **▼** to highlight  (movie) and press **MENU/OK**.

**4** Shoot.

Press the shutter-release button to begin recording; press again to end.

● REC icon blinks and the recording time and remaining time are displayed in the picture display while shooting a movie.

Recording ends automatically when memory is full.

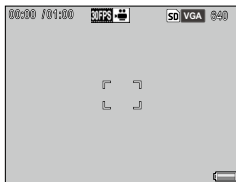

### **Note** .....

- Sounds made by the camera may be recorded with the movie.
- Movies may be up to 29 minutes in length or 4GB in size. Depending on the type of memory card used, shooting may end before this length is reached. The maximum total length of all movie files that can be stored in internal memory or on a memory card varies with the options selected for **Movie Size** and **Frame Rate** (page 87).

86 • The flash cannot be used.



- The camera focuses when the shutter-release button is pressed to begin recording.
- The amount of time remaining is calculated based on the amount of memory available and may not diminish at an even rate.
- Charge the battery before shooting or use an optional AC adapter. For long recordings, choose memory cards with high write speeds and check the amount of memory available before shooting.
- AE/AF target selection is not available for movies.

## Choosing the Frame Size and Frame Rate

Movies consist of a series of images (frames) that are played at high speed to create the illusion of motion. Choose a frame size (the size of each frame in pixels) and frame rate (the rate at which the frames are recorded).

### 1 Display the shooting menu.

Press **MENU/OK** to display the scene menu. Press ◀ to highlight the mode tab, press ▼ to highlight the shooting menu tab, and press ▶ to place the cursor in the shooting menu.

### 2 Select **Movie Size** or **Frame Rate**.

Highlight **Movie Size** or **Frame Rate** and press ▶ to display options for the selected item.



### 3 Select an option.

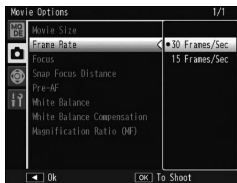



- **Movie Size:** Choose **VGA** 640 (640×480 pixels) or **QVGA** 320 (320×240 pixels).
- **Frame Rate:** Choose **30 Frames/Sec** (30fps) or **15 Frames/Sec** (15fps).



### 4 Press **MENU/OK**.

The selected option will be displayed in the picture display.













**1** Press .  
Press the  button to display pictures in the picture display.

**2** Display the movie.  
Use the , , , and  buttons to scroll through pictures (page 27) until the first frame of the movie is displayed. Movies are indicated by a  icon.



**3** Start playback.  
Press the **ADJ.** lever in to start playback. Progress is shown in the playback display. The following operations can be performed:



To	Press	Description
Advance/ rewind	 / 	Hold  to fast forward,  to rewind. Press  or  when the playback is paused to advance or rewind a movie frame by frame. Hold  or  when the playback is paused for slow advance or rewind.
Pause/ resume	<b>ADJ.</b>	Press the <b>ADJ.</b> lever in to pause; press again to resume.
Adjust volume	 / 	Press  to increase volume,  to decrease.

# More on Playback

This section details the options in the playback menu and describes how to view pictures on a TV.



## The Playback Menu

### 1 Display the playback menu.

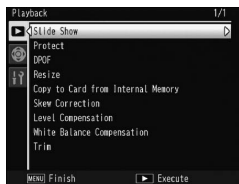
Press the  button and press the MENU/OK button.



### 2 Select a menu item.

Press  or  to scroll through the menu and press  to display options for the highlighted item.

The playback menu contains the following options:

Option	Page	Option	Page
Slide Show	90	Skew Correction	95
Protect	90	Level Compensation	96
DPOF	92	White Balance Compensation	99
Resize	94	Trim	100
Copy to Card from Internal Memory	94		

## Slide Show

Selecting this option starts an automated slide show.

Pictures are displayed at three second intervals. When a movie is displayed, movie playback begins automatically; the slide show resumes when playback is complete.

The slide show repeats until stopped; press any button to end the slide show.

## Protect

Protect pictures from accidental deletion.



### Caution

- Formatting erases all files, including protected files.

### Protecting Individual Pictures

To protect or remove protection from individual files, play the picture back and select **Protect** in the playback menu to display the options. Highlight **1 File** and press **MENU/OK**.

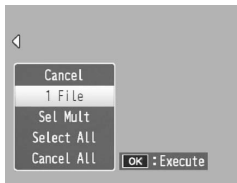

Protected files are indicated by an icon.



### Protecting or Removing Protection from All Files

To protect all files, select **Protect**, highlight **Select All** and press **MENU/OK**. To remove protection from all files, highlight **Cancel All** and press **MENU/OK**.

## Changing the Protect Status of Multiple Files

### 1 Select **Protect** in the playback menu.

In multi-frame playback, proceed to Step 2.

In single-frame playback, the options will be displayed. Highlight **Sel Mult** and press **MENU/OK**.

### 2 Select **Sel. Individ.** or **Sel. Range**.

Select **Protect** in the playback menu to display the options. To select images one at a time, highlight **Sel. Individ.**, press **MENU/OK**, and proceed to Step 3. To select ranges, highlight **Sel. Range**, press **MENU/OK**, and proceed to Step 3.1.

### 3 Select photographs.

Press **▲**, **▼**, **◀**, or **▶** to highlight a photo and press **MENU/OK** to select. Protected pictures are marked with an icon. To remove protection from a photo, highlight it and press **MENU/OK** again.

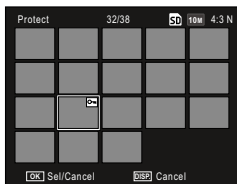



### Tip: Selecting Ranges

**3.1** Press ▲, ▼, ◀, or ▶ to highlight the first image and press **MENU/OK** to select. The selected image is marked with an icon.

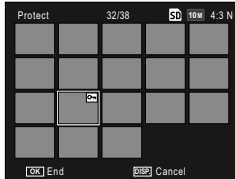

**3.2** Press ▲, ▼, ◀, or ▶ to highlight the last image and press **MENU/OK** to select. The selected image and images in the range will be marked with icons.

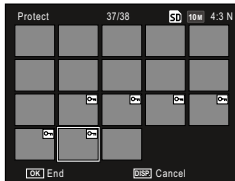

- Repeat Steps 3.1 and 3.2 to select additional ranges.
- To select or deselect individual photos, press the **ADJ.** lever in to switch to **Sel. Indiv.** mode.

## 4 Press the Fn2 button.

A message will be displayed while the camera protects the selected files. The camera will then return to playback mode.

### DPOF: Selecting Pictures for Printing

Use this option to create a digital “print order” listing the photos you wish to print and the number of prints, and then take the memory card to a digital print service center that supports the DPOF (Digital Print Order Format) standard.



### Caution

- If a photograph created using a RAW picture-quality option is selected for printing, only the JPEG copy will be printed.
- **DPOF** is not available for photos saved in internal memory of the camera.

### Selecting Individual Photos for Printing

Display a photo to add to a DPOF selection and select **DPOF** in the playback menu to display the options. Highlight **1 File** and press **MENU/OK**.

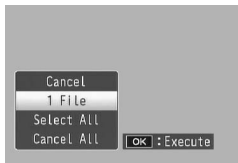

Press ◀ or ▶ to highlight a photo and press **MENU/OK** to select.

### Selecting All Photos for Printing

To select all photos for printing, select **DPOF**, highlight **Select All** and press **MENU/OK**. To remove all photos from the print order, highlight **Cancel All** and press **MENU/OK**.

### Selecting Multiple Photos for Printing

Select photos in multi-frame view.

#### 1 Select **DPOF**.

Press **MENU/OK** in multi-frame playback to display the playback menu. Highlight **DPOF** and press ▶.

#### 2 Select photos and choose the number of prints.

Press ◀ or ▶ to highlight a photo and ▲ or ▼ to choose the number of prints. To remove a photograph from the print order, press ▼ until the number of prints is zero.

#### 3 Press **MENU/OK**.

A message will be displayed while the camera creates the print order.



#### Note

- For information on removing all photos from the print order, see page 92.

## Resize: Creating Small Copies of Photographs

To create a small copy of the current photograph, select **Resize** in the playback menu and choose a size from **1M**, **4:3 F** or **VGA 4:3 F**.

### **Note** .....

- All copies have an aspect ratio of 4:3. Copies created from photos with an aspect ratio of 3:2, 1:1, or 16:9 have a black border.
- Movies and RAW-quality photos cannot be resized.

## Copy to Card from Internal Memory

To copy all files from internal memory to a memory card, insert the memory card in the camera and select **Copy to Card from Internal Memory** in the playback menu.

### **Caution** .....

- If the space available on the memory card is insufficient to copy all the files in internal memory, a message will be displayed. To copy only those files that will fit in the space available, highlight **Yes** and press **MENU/OK**; to exit without copying any files, select **No**.
- Files cannot be copied to internal memory from a memory card.



## Skew Correction

Create copies that have been processed to reduce the effects of perspective on rectangular objects, such as message boards or business cards.

### 1 Display the photo.

Display the photo to be processed in playback mode.

### 2 Select **Skew Correction**.

Press **MENU/OK** to display the playback menu, highlight **Skew Correction**, and press **▶**.

If the camera detects an object to correct perspective, the object is shown with an orange frame. The camera can detect up to five objects; to select a different object, press **▶**, or press **▲** to exit without correcting perspective. If the camera cannot detect an object, an error message is displayed.

### 3 Press **MENU/OK**.

A message will be displayed while the camera copies the photo.



#### **Caution**

- Skew correction is available only with still images taken with this camera. It is not available for movies or photos taken using **S-Cont** or **M-Cont**.
- When used with photos taken with a RAW-quality option selected for picture quality (page 53), skew correction applies only to the JPEG copy.



## Note

- The copy is the same size as the original.
- To reduce the time required, create a small copy of the original using the **Resize** function (page 94) and perform skew correction on the copy.
- Skew correction can also be performed during shooting (pages 42 and 47).

## Level Compensation

Create copies that have been processed to adjust brightness and contrast.

### *Auto: Automatic Level Correction*

#### 1 Display the photo.

Display the photo to be processed in playback mode.

#### 2 Select **Level Compensation**.

Press **MENU/OK** to display the playback menu, highlight **Level Compensation**, and press **▶**.

#### 3 Select **Auto**.

Highlight **Auto** and press **▶**.

If the camera is able to create a copy, a preview will be displayed with the original image displayed at upper left, the corrected copy at right. If

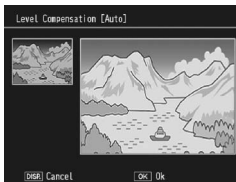

the camera cannot create a copy, an error message will be displayed and the camera will exit to the playback menu.

#### 4 Press **MENU/OK**.

Press **MENU/OK** to copy the image (to exit without creating a copy, press the **DISP.** button). A message will be displayed while the camera copies the photo.

## Manual: Manual Level Correction

### 1 Select Manual.

Display the photo to be processed and select **Level Compensation** > **Manual** in the playback menu.

### 2 Select the black point, white point, or mid-point.

The preview contains a histogram showing how pixels of different brightnesses are distributed in the image, with dark pixels (shadows) on the left and bright pixels (highlights) on the right. Press the **ADJ.** lever in to cycle through the black point, mid-point, and white point and press ◀ or ▶ to position the selected point for enhanced brightness and contrast. For help, press the **Fn2** button; press the button again to return to the preview display.

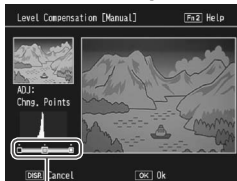

*From left to right:  
black point, mid-  
point, white point*

### 3 Press MENU/OK.

Press **MENU/OK** to copy the image (to exit without creating a copy, press the **DISP.** button). A message will be displayed while the camera copies the photo.

 **Tip: Choosing the Black Point, White Point, and Mid-Point** 

- **Adjusting brightness:** To make the image brighter, move the mid-point to the left. Moving the mid-point to the right makes the image darker.





- **Correcting exposure:** If the image is overexposed, move the black point to the right until it lines up with the darkest pixel in the histogram. If the image is underexposed, move the white point to the left until it lines up with the brightest pixel. You can then move the mid-point left or right to adjust brightness.

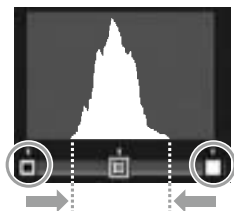

*Correcting overexposure*

- **Increasing contrast:** To increase contrast, align the black point and white point with the darkest and brightest pixels. You can then move the mid-point left or right to adjust brightness.



 **Caution** 

- Level correction is available only with still images taken with this camera. It is not available for movies or pictures taken using **S-Cont** or **M-Cont**.
- The desired results may not be achieved with monochrome images.
- Although level correction can be applied multiple times, the compression applied every time a copy is saved will result in a drop in image quality.

## White Balance Compensation

Create copies with modified white balance.

### 1 Display the photo.

Display the photo to be copied in playback mode.

### 2 Select **White Balance Compensation**.

Press **MENU/OK** to display the playback menu, highlight **White Balance Compensation**, and press **▶**.

### 3 Adjust white balance.

Use the **▲**, **▼**, **◀**, or **▶** to adjust white balance.

Press the **DISP.** button to reset white balance compensation to a neutral value (to view or hide help, press the **Fn2** button).

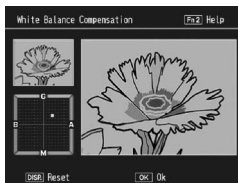

### 4 Press **MENU/OK**.

Press **MENU/OK** to copy the image (to exit without creating a copy, press the **DISP.** button twice). A message will be displayed while the camera copies the photo.



#### Caution

- White balance compensation is available only with still images taken with this camera. It is not available for movies or pictures taken using **S-Cont** or **M-Cont**.
- The desired results may not be achieved with monochrome images.
- Although white balance compensation can be applied multiple times, the compression applied every time a copy is saved will result in a drop in image quality.

Create a copy of a trimmed image.

### **1** Display the photo.

Display the photo to be processed in playback mode.

### **2** Select **Trim**.

Press **MENU/OK** to display the playback menu, highlight **Trim**, and press **▶**.

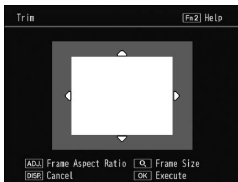

### **3** Trim the photo.

Press **▲**, **▼**, **◀**, or **▶** to move the trimming box, and **■** or **Q** to change the trimming size, and press the **ADJ.** lever in to change the aspect ratio of the trimming box (4:3/1:1).

For help, press **Fn2**, and press the button again to return to the previous display.

### **4** Press **MENU/OK**.

Press **MENU/OK** to save the copy. A message will be displayed while the camera copies the photo.



#### **Caution**

- Trimming is available only with still images taken with this camera.
- Pictures taken in the RAW mode cannot be trimmed.
- Although trimming can be applied multiple times, a copy will result in a drop in image quality.



### Note

- Trimmed images are saved in fine quality.
- The size of the trimming box differs depending on the size of an original image.
- The size of a trimmed image differs depending on the size of an original image and the trimming box.

## Viewing Pictures on TV

To view pictures on a TV, connect the camera using an AV cable or optional HDMI cable.



### Caution

- The camera's picture display and speaker will turn off and photos and movies will be played back on the TV.
- Do not move the camera by holding the AV cable or HDMI cable connected to the camera.

### Connecting to a TV using an AV Cable

Connect the camera to AV devices equipped with video input terminals using an AV cable (AV-1).

#### 1 Turn the camera off.

Be sure the camera is off before connecting or disconnecting an AV cable.

#### 2 Connect the AV cable to the TV.

#### 3 Connect the camera.

Open the terminal cover and plug the cable into the common terminal for USB port/AV output. *Do not use force.*

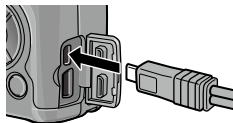

## 4 Tune the television to the video channel.

Select video input. See the television manual for details.

## 5 Turn the camera on.



### Note

- The camera supports the following video standards: NTSC (used in North America, the Caribbean, parts of Latin America, and some East Asian countries) and PAL (used in the United Kingdom and much of Europe, Australia, New Zealand, and parts of Asia and Africa). SECAM is not supported. Where possible, the camera is set to the standard used in your country or region before shipment; before connecting the camera to a device that uses a different video standard, choose the appropriate video mode (page 133).

### Connecting to a TV using an HDMI Cable

Connect the camera to AV devices equipped with HDMI terminals using an optional HDMI cable (HC-1).

#### 1 Turn the camera off.

Be sure the camera is off before connecting or disconnecting an HDMI cable.

#### 2 Connect the HDMI cable to the TV.

#### 3 Connect the camera.

Open the terminal cover and plug the cable into the HDMI connector. *Do not use force.*

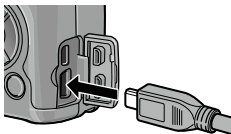

#### 4 Tune the television to the video channel.

Select video input. See the television manual for details.



## 5 Turn the camera on.



### Note

- If connecting or disconnecting the HDMI cable, the display switches to single-frame view.
- **AUTO** is selected for the resolution of image output using an HDMI cable. If the resolution of image displayed on TV is low with the **AUTO** setting, select **1080i**, **720P**, or **480P** in **HDMI Output** in the setup menu (page 134).

# Printing Photographs

The camera can be connected to a printer via the supplied USB cable and photographs printed directly from the camera without using a computer.



## Caution

- Movies cannot be printed.
- If a photograph created using a RAW picture-quality option is selected for printing, only the JPEG copy will be printed.



## Note

- The camera conforms to PictBridge, a standard widely used for direct printing, and direct printing is consequently only available with PictBridge-compliant printers. See the documentation provided with your printer for information on whether it supports PictBridge.
- Selecting **PTP** for **USB Connection Type** in the setup menu is required depending on the type of printers.

## Connecting the Camera

---

Connect the camera to the printer using the supplied USB cable.

### 1 Turn the camera off.

Be sure the camera is off before connecting or disconnecting the USB cable.

### 2 Connect the USB cable to the printer.

Connect the USB cable to the printer and turn the printer on.

### 3 Connect the camera.

Open the terminal cover and plug the cable into the common terminal for USB port/AV output.

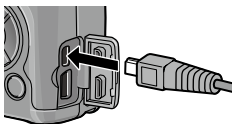

Press the **ADJ.** lever in. The camera will turn on and the message will be displayed; press the **ADJ.** lever in again immediately.



#### **Note**

- If you do not press the **ADJ.** lever in while the above message is displayed, it may in some cases be replaced after two seconds by a message stating that the camera is connecting to a computer. Turn the camera off and press the **ADJ.** lever in again.

The message will be replaced by the PictBridge playback display. If the PictBridge playback display does not appear, the camera is still establishing a connection to the printer.

#### **Caution**

- Do not use force when connecting the USB cable or when handling the camera with the cable connected.

# Printing



## Caution

- Do not disconnect the USB cable while printing is in progress.
- If an error is displayed during printing, check the printer and take the appropriate action.

## Printing a Photograph or All Photographs

### 1 Select a photo.

To select a photo, press ◀ or ▶ until the desired photo is shown in the PictBridge playback display and press the **ADJ.** lever in. Highlight **1 File** and press **MENU/OK**.

To print one copy of all photos, press the **ADJ.** lever in. Highlight **All Files** and press **MENU/OK**.

### 2 Adjust printer settings.

Highlight an item and press ▶ to view the options available, or choose **Printer Select** to use the default setting for the current printer (the options available vary with the type of printer; items not supported by the connected printer cannot be selected).

Press ▲ or ▼ to highlight an option and press **MENU/OK**.

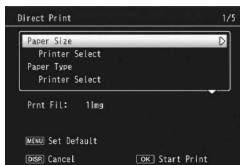

Item	Description
<b>Paper Size</b>	Choose the paper size.
<b>Paper Type</b>	Choose the paper type.
<b>Layout</b>	Choose the number of pictures per page.

Item	Description
<b>Date Print</b>	Include the time and date of recording. See page 17 for information on selecting the order in which the time and date are displayed. If the picture was taken using <b>Date Imprint</b> (page 76), only the imprinted date will be printed.
<b>File Name Print</b>	Include the file name.
<b>Optimize Image</b>	Choose whether the printer optimizes photo data.
<b>Print Size</b>	Choose the print size.
<b>Print Quality</b>	Choose the print quality.
<b>Report Print*</b>	Print a report.
<b>Printing Quantity</b>	Choose the number of copies.
<b>Toner Saving*</b>	Use less toner during printing.
<b>1-Side/2-Sides*</b>	Print on one or both sides of the paper.

\* Ricoh printers only. Visit <http://www.ricoh.com/> for details.

### 3 Start printing.

Press **MENU/OK** when the menu in Step 2 is displayed. A message is displayed during printing; to exit before printing is complete, press the **DISP.** button. The PictBridge playback display will appear when printing is complete.

- 1 Press the  button in the PictBridge playback display.**

Photographs will be displayed in multi-frame playback.

- 2 Select a picture.**

Highlight a picture and press **MENU/OK**.

- 3 Choose the number of prints.**

Press **▲** or **▼** to choose the number of prints. Selected pictures are marked with a  icon; to deselect a photograph, press **▼** until the number of prints is zero.



Press **◀** or **▶** to highlight an additional photograph and press **▲** or **▼** to choose the number of prints.

- 4 Adjust printer settings.**

Press **MENU/OK** to display the direct print menu. Adjust settings as described on page 106.

- 5 Start printing.**

Press **MENU/OK** when the print menu is displayed. A message is displayed during printing; to exit before printing is complete, press the **DISP.** button. The PictBridge playback display will appear when printing is complete.

# The Setup Menu

The setup menu can be accessed from the shooting and playback menus (pages 49 and 89).

Key Custom Options tab and Setup tab are available for the setup menu.

## 1 Display the menus.

Press **MENU/OK** to display the menu for the current mode (in scene mode, a **MODE** tab will be displayed).

## 2 Select a menu tab.

Press **◀** to highlight the tab for the current menu and press **▲** or **▼** to highlight the key custom options tab or the setup tab. Press **▶** to place the cursor in the selected tab.



① *Key custom options tab*

② *Setup tab*

## 3 Select a menu item.

Press **▲** or **▼** to highlight a menu item and press **▶** to display options for the highlighted item.

## 4 Select an option.

Press **▲** or **▼** to highlight an option and press **MENU/OK** to select (the procedure may differ for some items).

The key custom options tab contains the following options:



Option	Default	Page	Option	Default	Page
Reg. My Settings	—	112	Fn Button Pair Switching	Fn Pair Setting1	120
Recall My Settings	—	114	Zoom Button	Exposure Comp.	121
Edit My Settings	—	115	Power Button Lamp	On	121
My Settings for Fn Settings	Off	117	Playback Mode Dial Options	Setting1	121
My Settings WB Comp.	Off	117	M Mode Dial Options	Setting1	121
ADJ Lever Setting 1	White Balance	117	One Press M Mode	Aprtr Priority	122
ADJ Lever Setting 2	ISO	117	ADJ. Direct ISO Control	Off	122
ADJ Lever Setting 3	Quality	117	Delete My Settings	—	122
ADJ Lever Setting 4	Image	117	Restore Defaults	—	—
ADJ Lever Setting 5	Expo. Metering	117			
ADJ Shutter Confirmation	Off	118			
Fn Button Pair Setting	Auto Bracket	119			

 **Note**

- The settings except **Reg. My Settings** in the key custom settings can be reset to the default settings with **Restore Defaults**.



The setup tab contains the following options:

Option	Default	Page	Option	Default	Page
Format [Card]	—	123	One Press Zoom Ratio	9.8×	128
Format [Internal Memory]	—	123	Auto Rotate	On	129
LCD Brightness	Auto	123	White Saturation Display	Off	129
ISO Step Setting	1EV	124	Playback Order Options	Sht. Date/ Time	130
ISO Auto-High Settings	Maximum ISO: AUTO 400 Change Shutter Speed: Auto	124	RAW/JPEG Setting	Fine	130
			Color Space Setting	sRGB	130
			Area measured for manual WB	Spot	131
			Digital Zoom Image	Normal	131
			Store Menu Cursor Position	Off	131
AF Auxiliary Light	On	124	Card Sequence No.	On	132
Operation Sounds	All	125	Date Settings	—	133
Volume Settings	 (medium)	125	Language/言語	(Varies <sup>1</sup> )	133
LCD Confirmation Time	0.5 seconds	125	Video Out Mode	(Varies <sup>1</sup> )	133
Auto Power Off	5 Min.	125	USB Connection Type	Mass Storage	133
Sleep Mode	Off	126	HDMI Output	AUTO	134
LCD Auto Dim	On	126	Confirm Firmware Version	—	134
Optional AF Distance Display	Off	126	Eye-Fi Connection Set- tings <sup>2</sup>	On	134
Level Setting	Level+Tilt	126	Eye-Fi Connection Display <sup>2</sup>	—	134
Level (Tilt) Calibration	—	126			
Grid Guide Display Options		127			
Shooting Info. Display Frame	Off	127			
Information Display Mode	Off	128			

1 Varies with country or region of purchase.

2 Displayed only when using an Eye-Fi card.

## Key Custom Options

### Reg. My Settings

You can register up to 18 frequently-used shooting settings (twelve for the internal memory and six for a memory card) and easily recall the settings by assigning the settings to MY1, MY2 or MY3 of the mode dial (page 48).

#### 1 Adjust settings.

Set the camera to the desired settings. The following settings can be registered:

- **Camera settings:** Shooting mode (📷, P, A, S, M, or SCENE), aperture (modes A and M), shutter speed (modes S and M), focus position for manual focus, macro, flash, self-timer and display modes.
- **Shooting menu options:** All options except **Multiple Exposure Shooting**, **Interval Shooting**, **Magnification Ratio (MF)**, **Restore Defaults**, **Auto Aperture Shift**, **Shutter Speed Auto Shift**, and **Switch Shooting Mode**. White balance compensation will be stored if **My Settings WB Comp.** is on (page 117).
- **Key custom options:** **Fn Button Pair Setting** (only when **On** is selected for **My Settings for Fn Settings**)
- **Setup options:** **ISO Step Setting**, **ISO Auto-High Settings**, **Optional AF Distance Display**, **Level Setting**, **Grid Guide Display Options**, **Shooting Info. Display Frame**, and **Digital Zoom Image**.

#### 2 Select **Reg. My Settings**.

Highlight **Reg. My Settings** in the key custom options tab and press ►.

### 3 Save settings.

To assign the settings to MY1, MY2, or MY3 on the mode dial, highlight **MY 1**, **MY 2**, or **MY 3** and press **MENU/OK** (to exit without saving settings, press the **DISP.** button).

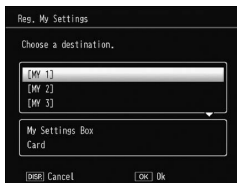

To save the settings to a “box” or “card” to be recalled and assigned to the mode dial at a later date (page 114), select **My Settings Box** or **Card** and press **▶**. Highlight the desired number and press **MENU/OK**.

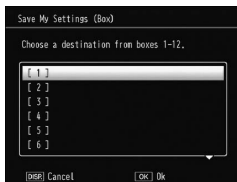

Unnamed boxes will be named using the current date and time. If the box has already been assigned a name, the dialog will be displayed. Select **Yes** to use the current name, **No** to use a name based on the current date and time.



#### Note

- Settings assigned to “card” will be cleared if the memory card is formatted. Settings assigned to “box” will not be cleared even if the internal memory is formatted.

## Recall My Settings

Assign settings in a “box” or “card” to MY1, MY2, or MY3.

### 1 Select Recall My Settings.

Highlight **Recall My Settings** in the key custom options tab and press **▶**.

### 2 Select the source.

Highlight **My Settings Box** or **Card**, and press **▶**.

### 3 Select a destination.

Highlight the destination to assign the setting to (**MY 1**, **MY 2**, or **MY 3**) and press **▶**.

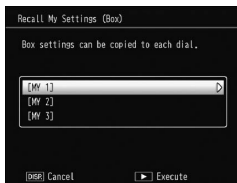

### 4 Select a setting.

Highlight a setting to assign to the selected position on the mode dial and press **MENU/OK**.

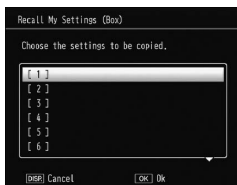

To exit without assigning settings to the mode dial, press the **DISP.** button.



#### Note

- My settings configured with other cameras cannot be recalled with this camera.

Edit and rename settings saved with **Reg. My Settings**.

### 1 Select **Edit My Settings**.

Highlight **Edit My Settings** in the key custom options tab and press **▶**.

### 2 Select settings.

To edit the settings assigned to **MY1**, **MY2**, or **MY3** on the mode dial, highlight **MY 1**, **MY 2**, or **MY 3** and press **▶**.

To edit settings saved in “box” or “card”, select **My Settings Box** or **Card** and press **▶**. Highlight the desired number and press **▶**.

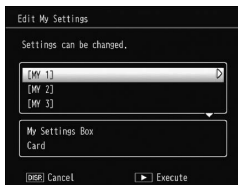

### 3 Edit settings.

Press **▲** or **▼** to highlight items and press **▶** to edit. After editing each item, press **◀** to return to the settings list, where you can edit additional settings.



### 4 Save changes.

Press **MENU/OK** to save changes and exit (to exit without saving changes, press the **DISP.** button).



### Tip: Naming My Settings

- Select **Name** in Step 3 to rename the current setting. The current name is highlighted in the name area; to edit the current name, press ◀ or ▶ to position the cursor in the name area and press ▼ to place the cursor in the keyboard area (to delete the current name, press ▼ while the name is highlighted). Highlight characters using ▲, ▼, ◀, or ▶ and press **MENU/OK** to enter the highlighted character at the current cursor position (to delete the character at the current cursor position, select **[Delete]**). Press **Fn2** to switch between upper and lower case. Names can be up to 32 characters long. Press the **ADJ.** lever in to use the new name, or press the **DISP.** button to exit without renaming the settings.



### Note

- When the settings registered in **Reg. My Settings** are assigned to **MY1**, **MY2**, or **MY3**, if editing the settings in **Edit My Settings**, the changes are reflected to the settings assigned to **MY1**, **MY2**, or **MY3**. If editing the assigned settings directly in the **MY1**, **MY2**, or **MY3** mode, the changes are not reflected to the settings registered in **Reg. My Settings**. After changing the settings directly in the **MY1**, **MY2**, or **MY3** mode, the settings edited in **Edit My Settings** will not be reflected to the settings assigned to **MY1**, **MY2**, or **MY3**.
- Names assigned to "My" settings are displayed immediately after the mode dial is rotated to **MY1**, **MY2**, or **MY3** or when ▲ is pressed.
- My Settings can be deleted in **Delete My Settings** in key custom settings (page 122).



## My Settings for Fn Settings

Select **On** to include the options assigned to the **Fn** buttons (page 119) in the settings saved with **Reg. My Settings**.

## My Settings WB Comp.

Select **On** to include white balance compensation (page 81) in the settings saved with **Reg. My Settings**.

## ADJ Lever Setting

Assign up to five frequently-used options to the **ADJ.** lever for quick access in , **P**, **A**, **S**, and **M** modes. At shipment, the **ADJ.** lever can be used for white balance (page 78), ISO setting (page 82), picture quality (page 53), image setting (page 62), and exposure metering (page 61), but it can also be used for white balance compensation (page 81), focus (page 55), continuous (page 64), bracketing (page 67), flash compensation (page 70), manual flash amount (page 71), exposure compensation (page 77), and dynamic range compensation (page 72).

## Assigning a Function to the ADJ. Lever

- 1 Select a setting from ADJ Lever Setting 1 to ADJ Lever Setting 5 in the key custom settings and press **▶**.
- 2 Select a function to assign to the setting and press **MENU/OK**.

## Using the ADJ. Lever

To select an option currently assigned to the ADJ. lever:

### 1 Display options.

With the camera in shooting mode, press the ADJ. lever in and press the lever left or right or press **◀** or **▶** to view the options assigned to the lever (AE/AF target selection (fixed) and the options assigned to ADJ. lever 1 to 5 are switched).



### 2 Select an option.

Press **▲** or **▼** to highlight an option and press the ADJ. lever in or press **MENU/OK** to select.

#### **Note** .....

- AE/AF target selection (page 74) displayed at the upper right corner of the picture display cannot be replaced with another function.

## ADJ Shutter Confirmation

Select **On** to use the shutter-release button to select the highlighted option in ADJ. lever mode.



## Fn Button Pair Setting

Assign functions to the Fn (function) buttons: ◀ (Fn1) and ☺ (Fn2).

The following settings can be assigned.

Option	Description
AF/MF	Switch between multi or spot AF and manual focus (page 55).
AF/Snap	Switch between multi or spot AF and snap focus (page 55).
AF/Subj. Trckng	Switch between multi or spot AF and target tracking focus (page 55).
AE Lock	Lock exposure.
JPEG>RAW	If a fine- or normal-quality option is selected for <b>Picture Quality/Size</b> , pressing the Fn button selects a RAW-quality option with the same aspect ratio (page 53).
Color>B&W	Select <b>Black &amp; White</b> for <b>Image Settings</b> (page 62).
Color>TE	Select <b>B&amp;W (TE)</b> for <b>Image Settings</b> (page 62).
Color>High B&W	Select <b>Hi-Contrast B&amp;W</b> for <b>Image Settings</b> (page 62).
Color>Cross	Select <b>Cross Process</b> for <b>Image Settings</b> (page 62).
Color>Pos. Film	Select <b>Positive Film</b> for <b>Image Settings</b> (page 62).
Color>B Bypass	Select <b>Bleach Bypass</b> for <b>Image Settings</b> (page 62).
Exposure Comp.	Display the exposure compensation slider (page 77).
White Balance	Display white balance options (page 78).
WB Correction	Display white balance compensation controls (page 81).
ISO	Display ISO sensitivity options (page 82).
Quality	Display options for picture quality/size (page 53) or movie size (page 87).
Focus	Display focus options (page 55).
Expo. Metering	Display exposure metering options (page 61).
Image	Display image setting options (page 62).

Option	Description
<b>Cont. Mode</b>	Display continuous shooting options (page 64).
<b>Auto Bracket</b>	Display bracketing options (page 67).
<b>Flash Comp.</b>	Display the flash compensation slider (page 70).
<b>Flash Amount</b>	Adjust manual flash output (page 71).
<b>Dyn Range Comp</b>	Display the dynamic range compensation options (page 72).
<b>Multi Exposure</b>	Enters the Multiple Exposure shooting mode (page 68).
<b>Macro Target</b>	Position the focus target in macro mode (page 21).
<b>Self-timer</b>	Set the self-timer (page 24).

Up to 4 settings can be registered.

## 1 Select Fn Button Pair Setting.

Highlight **Fn Button Pair Setting** in the key custom options tab and then press ►.

## 2 Select a number to assign a function to.

Press ▲ or ▼ to select **Fn Pair Setting 1 to 4** and press ►.

## 3 Select a function to assign.

Press ▲ or ▼ to highlight a function to assign and press MENU/OK.



Repeat steps 2 and 3 to assign additional functions.

## 4 Press the DISP. button.

### Fn Button Pair Switching

Select a setting to apply to Fn buttons from **Fn Pair Setting1 to 4** which are set in **Fn Button Pair Setting**.



## Note

- The functions currently assigned to **Fn** buttons are displayed when the camera is turned on, the mode dial is rotated, or **▲** is pressed. When the assigned functions are displayed in the picture display, rotating the up-down dial while pressing **▲** switches assigned functions (**Fn Pair Setting 1** to **4**) (this function is not available in the manual focus mode).

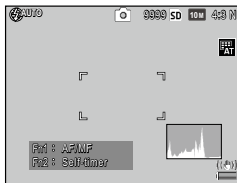

## Zoom Button

Choose the role played by the **Q** and **■** buttons. Choose from none (off), digital zoom (page 20), exposure compensation (default) (page 77), and white balance (page 78).

## Power Button Lamp

If **On** is selected, the power button LED will light when the camera is turned on.

## Playback Mode Dial Options/M Mode Dial Options

Choose the roles played by the **ADJ.** lever and up-down dial during playback zoom and in mode **M**.

	Playback Mode Dial Options		M Mode Dial Options	
	Setting1	Setting2	Setting1	Setting2
<b>ADJ. lever</b>	Next/previous frame	Scroll left/right	Shutter speed	Aperture
<b>Up-down dial</b>	Zoom in/out	Scroll up/down	Aperture	Shutter speed

## One Press M Mode

When exposure compensation is assigned to the **Q** and **AE-L/AF-ON** buttons (page 121) or AE lock is assigned to an **Fn** button (page 119), pressing the button in manual exposure mode sets shutter speed and/or aperture to values close to those needed for optimal exposure.

- **Aprrt Priority:** Aperture remains at the selected value; shutter speed is adjusted for optimal exposure.
- **Shtrr Priority:** Shutter speed remains at the selected value; aperture is adjusted for optimal exposure.
- **Program:** Both aperture and shutter speed are adjusted for optimal exposure.

## ADJ. Direct ISO Control

Select **On** to enable to change ISO sensitivity by pressing the **ADJ.** lever left or right in the shooting mode.

## Delete My Settings

Highlight **MY 1**, **MY 2**, or **MY 3**, or highlight **My Settings Box** or **Card**, press **▶**, and highlight a setting to be deleted. Press **MENU/OK** to delete the selected setting. A confirmation dialog will be displayed; press **◀** or **▶** to highlight **Yes** and press **MENU/OK**.

## Setup Menu Options

### Format [Card]/Format [Internal Memory]

Select **Format [Card]** to format a memory card. Select **Format [Internal Memory]** if a message is displayed prompting you to format internal memory.



#### Caution

- *Formatting deletes all data on the card or in internal memory.* Before formatting, copy the data you wish to keep to a computer (page 135).

### LCD Brightness

Select the brightness for the picture display.

#### 1 Select LCD Brightness.

Highlight **LCD Brightness** in the setup tab and then press **▶**.

#### 2 Select an option.

Press **▲** or **▼** to select **Auto** or **Manual** and press **▶**. If selecting **Auto**, the display returns to the setup menu.

If selecting **Manual**, the control is displayed.

#### 3 Adjust the brightness of the picture display.

Press **▲** to increase the brightness and **▼** to decrease.

#### 4 Press MENU/OK.

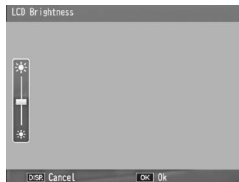

## ISO Step Setting

Step value for ISO sensitivity can be selected from 1EV and 1/3EV. The available ISO settings differ depending on the selected step value.

Option	Available ISO Sensitivity
1EV	Auto/Auto-Hi/ISO 80/ISO 100/ISO 200/ISO 400/ISO 800/ISO 1600/ISO 3200
1/3EV	Auto/Auto-Hi/ISO 80/ISO 100/ISO 125/ISO 160/ISO 200/ISO 250/ISO 320/ISO 400/ISO 500/ISO 640/ISO 800/ISO 1000/ISO 1250/ISO 1600/ISO 2000 /ISO 2500/ISO 3200

## ISO Auto-High Settings

Choose the maximum sensitivity (**Maximum ISO**) selected by the camera and the shutter speed to shift the value of ISO sensitivity (**Change Shutter Speed**) when **Auto-Hi** is selected for **ISO Setting** in the shooting menu (page 82).

Choose the maximum sensitivity from settings of ISO 200 (**AUTO 200**), 400 (**AUTO 400**) (default), 800 (**AUTO 800**), 1600 (**AUTO 1600**) or 3200 (**AUTO 3200**).

Choose the shutter speed from **Auto**, **1/2**, **1/4**, **1/8**, **1/15**, **1/30**, **1/60**, **1/125**, or **1/250**.

## AF Auxiliary Light









If **On** is selected, the AF auxiliary light will light to assist the focus operation when the subject is poorly lit.

## Operation Sounds

Choose when the camera plays a sound.

Option	Description
All	Sounds are played at startup, when the shutter is released, when the camera focuses, and when an error occurs. If <b>Sound</b> or <b>Level+Sound</b> is selected for the level setting (page 25), the camera will also beep at regular intervals when the camera is level.
Level Sound	If <b>Sound</b> or <b>Level+Sound</b> is selected for <b>Level Setting</b> , the camera will beep at regular intervals when the camera is level.
Shutter Sounds	Sounds are played when the shutter is released or an error occurs. If <b>Sound</b> or <b>Level+Sound</b> is selected for <b>Level Setting</b> , the camera will beep at regular intervals when the camera is level.

## Volume Settings

Select the volume for the operation sounds. Choose from Off,  (low),  (medium), and  (high).

## LCD Confirmation Time

Choose how long a picture is displayed in the picture display after shooting. Select from 0.5, 1, 2, and 3 seconds, **Hold** (photograph is displayed until shutter-release button is pressed halfway next time and can be viewed with playback zoom or deleted), and **Off** (photographs are not displayed in the picture display after shooting).

## Auto Power Off

Choose the delay before the camera turns off automatically to save power when no operations are performed. Select from **Off** (the camera does not turn off automatically), **1 minute**, **5 minutes**, and **30 minutes**.

**Note**

- The auto power off function is not available for the following cases.
  - When connected to a computer or printer.
  - In the interval shooting or interval composite shooting (scene mode)
  - When transferring images using an Eye-Fi card

**Sleep Mode**

Choose the delay before the picture display enters sleep mode. Choose from **Off** (the function does not work), **10 Seconds**, **1 Minute**, and **3 Minutes**.

**Note**

- The sleep function is not available for the following cases.
  - When connected to an AV device using an AV cable or HDMI cable
  - In the interval composite shooting (scene mode)

**LCD Auto Dim**

Select **On** to dim the picture display to save power if no operations are performed for five seconds.

**Optional AF Distance Display**

Selecting **On** to display the indicator for the distance to the subject in shooting mode.

**Level Setting**

Choose tilt indicator settings to level the camera and correct the perspective for photographing buildings or landscapes (page 25).

**Level (Tilt) Calibration**

Register the current perspective as the standard.



## Grid Guide Display Options

Choose the type of framing grid available in shooting mode (page 33).

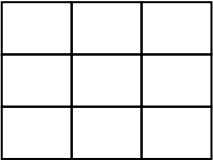
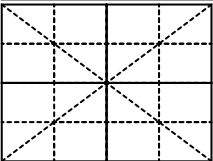
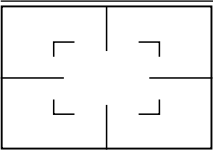
Item	Description
	A three-by-three grid for “rule of thirds” composition (default).
	A four-by-four grid with diagonal lines running from corner to corner makes it easy to find the center of the subject. Use for architectural photography or photographing products for display.
	A two-by-two grid with the center of the frame left clear to make it easier to view the subject. Use if your subject is in motion.

## Shooting Info. Display Frame

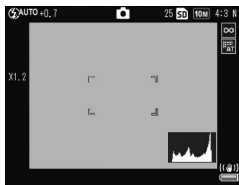

Select **On** to display shooting icons in a frame surrounding the view through the lens (page 6), making it easier to frame photographs in the picture display. The frame is not displayed in movie mode.



## Information Display Mode

Select **On** to display shooting information in the picture display even when the picture display is off (page 33), allowing you to adjust camera settings while using an optional external viewfinder (page 154) to frame photographs.

Shooting information can be displayed by:

- Pressing the Fn1, , or  button
- Rotating the mode dial to a new position
- Using the up-down dial
- Pressing the **ADJ.** lever left or right
- Pressing the flash **OPEN** switch ( **OPEN**) to raise the flash

The information display turns off if the shutter-release button is pressed halfway or no operations are performed for a few seconds.

## One Press Zoom Ratio

Select the magnification at which pictures are displayed when zoomed in using the **MENU/OK** button or **ADJ.** lever (page 29). Choose from 5.7x, 9.8x, and 16x.

## Auto Rotate

Select **On** to automatically display pictures in the correct orientation.



### Caution

- The orientation of the pictures taken in the **Continuous, AF-Cont**, or auto bracket mode will be the orientation of the first shot.
- The auto rotate function is not available for the following cases.
  - Movies
  - Pictures taken in the **S-Cont** or **M-Cont** mode
  - When viewing pictures in the multi-frame view
  - Pictures with too much perspective (taken with the camera tilted too far forward or backward)
  - Pictures taken with the camera upside-down
  - If the orientation of the camera changed while viewing a picture in the enlarge view
  - While the skew correction is in process (when an orange frame is displayed)
  - In the slide show or viewing images on a TV

## White Saturation Display

Select **On** to display the white saturation areas of the image flashed in black in the Highlights display. If selecting **Off**, the Highlights display is not available in the playback mode (page 34).

## Playback Order Options

Select the order for the pictures to be displayed in the playback mode.

- **File Numbers:** Pictures are displayed in the order of file numbers.
- **Sht. Date/Time:** Pictures are displayed in the order of shooting date and time.

## RAW/JPEG Setting

Choose the quality and size of JPEG copies recorded when a RAW-quality option is selected for **Picture Quality/Size** (page 53). Select **Fine** or **Normal** to record a fine- or normal-quality copy of the same dimensions as the RAW image, **VGA** to record a copy of **VGA 4:3 F** in size. If selecting **RAW only**, a JPEG copy is not recorded.

## Color Space Setting

Choose the color space used to record photographs. **sRGB** is widely used to reproduce digital images but offers a smaller gamut of colors than **AdobeRGB**.

### **Caution**

- The Adobe RGB color space was developed by Adobe Systems, Inc., and is compatible with the default color space used in Adobe Photoshop and other image editing software. Note, however, that colors will only be reproduced correctly in software that supports the Adobe RGB color space. Note too that specialized equipment is required to print the full range of colors in the Adobe RGB gamut; when printed using consumer household printers or digital photo print services, colors will generally be less vivid than in photographs that use the sRGB color space.

## Area measured for manual WB

Select the area to measure the white balance in from **Entire frame** or **Spot**.

## Digital Zoom Image

Choose how the image taken using the digital zoom will be saved.

- **Normal:** It crops a portion of an image and enlarges the portion back to the size selected in **Picture Quality/Size**, resulting in lower image quality.
- **Auto Resize:** It crops a portion of an image and save the image in the cropped size. It keeps from decreasing the image quality, however, the image size becomes smaller.

**Auto Resize** zoom is available only when **10M 4:3 F** or **10M 4:3 N** is selected for **Picture Quality/Size** (page 53).

The current picture size is displayed in the picture display when the camera is zoomed in (the sizes of cropped image differ depending on the zoom ratio).

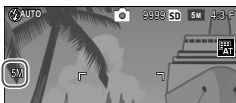

### **Caution** .....

- **Auto Resize** has no effect when **S-Cont** or **M-Cont** is selected for **Continuous**, or in multiple exposure shooting or scene mode.

## Store Menu Cursor Position

If **On** is selected, the most-recently accessed item will be highlighted when menus are displayed.

## Card Sequence No.

Choose how the camera names image files when saving photographs to a memory card.

- **On:** File names consist of “R” followed by a seven-digit number (e.g., “R0010001.jpg”), assigned in ascending order from 0010001 to 9999999. When a new memory card is inserted, file numbering continues from the last number used.
- **Off:** File names consist of “RIMG” followed by a four-digit number (e.g., “RIMG0001.jpg”), assigned in ascending order from 0001 to 9999. When a new memory card is inserted, file numbering is reset to 0001.



### Note

- This option applies only to memory cards. The names of photos in internal memory consist of “RIMG” and a four-digit number.
- Photos copied to a computer using DL-10 (page 135) are given new names consisting of “RIMG” and a four-digit number.
- Photos taken with **AdobeRGB** selected for **Color Space Setting** (page 130) are indicated by file names beginning with an underscore (e.g., “\_R010001.jpg” or “\_RIMG001.jpg”).



### Caution

- When **On** is selected, no further photographs can be stored if the memory card contains a folder numbered 999 and a file name ending in 9999; when **Off** is selected, no further photographs can be stored if the memory card contains a file numbered 9999. To take additional photos, format the card after copying its contents to a computer.

## Date Settings

Set the camera clock (page 17).

## Language/言語

Choose the language in which camera messages and menus are displayed.

Option	Description	Option	Description
日本語	Japanese	Danske	Danish
English	English	Svenska	Swedish
Deutsch	German	Русский	Russian
Français	French	简体中文	Simplified Chinese
Italiano	Italian	繁体中文	Traditional Chinese
Español	Spanish	한국어	Korean
Nederlands	Dutch	ไทย	Thai

## Video Out Mode

When connecting the camera to a TV or VCR (page 101), choose a video out mode that matches the standard used in the device. The camera supports NTSC and PAL; SECAM is not supported.

## USB Connection Type

Select the type of USB connection from **Mass Storage** or **PTP**.

## HDMI Output

Choose the resolution of image output using an HDMI cable. Choose the setting from **AUTO**, **1080i**, **720P**, or **480P**.

### Note

- Normally, select **AUTO**. If the resolution of image displayed on TV is low with the **AUTO** setting, select **1080i**, **720P**, or **480P**. The image may be improved.

## Confirm Firmware Version

Confirm the version of the firmware and update the firmware if necessary.

For information about firmware, visit the Ricoh website ([http://www.ricoh.com/r\\_dc/support/](http://www.ricoh.com/r_dc/support/)).

## Eye-Fi Connection Settings

When using the SD memory card with wireless LAN function, selecting **On** enables the wireless LAN function. Selecting **Off** turns the wireless LAN function off, and the card can be used as a standard SD memory card.

## Eye-Fi Connection Display

When an Eye-Fi card is used, selecting this option displays the destination SSID.



# Downloading Images to Your Computer

The screen images shown here may differ from the images displayed on your computer depending on your computer OS.

## For Windows

You can copy pictures to your computer using the software included in the internal memory of the camera.

Software	Description
DL-10	Copies pictures to your computer.
MediaBrowser	View, manage, and edit images.



### Caution

- Administrator privileges are required for installation.
- DL-10 is not network-compatible. Use as a stand-alone application.



### Note

- For details on MediaBrowser, see the Help in MediaBrowser or visit the website:

*<http://www.mediabrowser.jp/en/index.html>*

## System Requirements for Using the Software

Before installing the software included in the camera, check that your computer meets the following environment requirements.

<b>Operating Systems Supported</b>	Windows XP Home Edition Service Pack 3/Professional Service Pack 3 Windows Vista Service Pack 2 Windows 7 (32- and 64-bit)
<b>CPU</b>	<b>Pentium® IV:</b> 1.6 GHz or faster <b>Pentium® M:</b> 1.4 GHz or faster <b>Core™ 2 Duo:</b> 1.5 GHz or faster
<b>Memory</b>	<b>Windows XP:</b> 512 MB or more <b>Windows Vista/Windows 7:</b> 1 GB or more
<b>Hard drive space required for installation</b>	300 MB or more
<b>Display Resolution</b>	1024 × 768 pixels or greater
<b>Display Colors</b>	65,000 colors or greater
<b>USB Port</b>	A USB port compatible with the above-mentioned computer

### **Caution**

- Windows XP 64-bit and Windows Vista 64-bit are not supported.
- If your computer has an upgraded OS, the USB function may not work normally, so it will not be supported.
- The software may not operate properly if changes are made to the operating system, such as with patches and service package releases.
- The camera does not support connection to a USB port added by using an extension function (PCI bus or other).
- If used in conjunction with a hub or other USB devices, the software may not work properly.
- When dealing with movies and other large files, a larger memory environment is recommended.

Install the supplied software to your computer.



### Caution

- Before proceeding, confirm that **Mass Storage** is selected for **USB Connection Type** in the setup menu (page 133).

## 1 Turn the camera power off, and pull the SD memory card out of the camera.

With SD memory card in the camera, the software cannot be installed.

## 2 Connect the supplied USB cable to the computer.

## 3 Connect the USB cable to the common terminal for USB port/AV output of the camera.

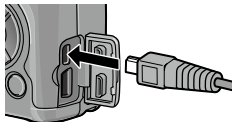

The camera turns on automatically when a connection is established.

RICOHDCI(E:) screen is displayed (E indicates the drive name).

## 4 Click **Start the digital camera software installer**, and then click the **OK** button.

Digital camera software installer screen appears.



## Windows 7

Click **Open folder to view files** and double-click **AU-TORUN.EXE** from the displayed files.

*Click to install software required for batch downloading and editing of images.*

*Click to display the Website for user registration.*



## 5 Click **Installing the software.**

### Windows XP

After a while, the **Choose Setup Language** screen appears.

### Windows Vista/Windows 7

If a **User Account Control** dialog is displayed, select **Allow** (Windows Vista) or **Yes** (Windows 7). If an icon appears on the task bar, click the icon to display the dialog. After a short pause, the **Choose Setup Language** dialog will be displayed.

## 6 Select a language and follow the on-screen instructions to complete installation.

The MediaBrowser installer will start. To install MediaBrowser, accept the license agreement and follow the on-screen instructions.

## 7 Click **Unblock** for DL-10.

For Windows 7, click **Allow access**.

## 8 When a message appears prompting you to restart your computer, select **Yes, I want to restart my computer now.** and then click **Finish.**

Your computer will restart automatically.

After your computer restarts, a Windows security warning message appears.



### **Caution**

- When using the USB cable, do not move the camera with the USB cable.
- Do not disconnect the USB cable with the camera power on.
- Do not connect a cable other than the supplied USB cable.
- If you install the DC Software 2 in the computer in which the DC software is already installed, DL-10 for the DC Software 2 is added to the Start-up folder.
- If you uninstall the DC Software 2 with the DC Software and the DC Software 2 have been already installed, DL-10 added to the Start-up folder may be deleted.

### **Viewing Software Manual**

In the internal memory of the camera, “Software User Guide” (PDF file) is available. This guide explains how to download images from the camera to your computer. To view the guide, copy the guide onto your computer.

#### **1 Open My computer with the camera connected to the computer.**

The internal memory of the camera appears as the drive.

#### **2 Open MANUAL folder.**

Each language has its own “Software User Guide” (PDF file).

### 3 Copy the PDF file for your language directly to the hard disk of your computer.



#### Note

- Adobe Reader or Acrobat Reader is required to view the operation manual (PDF file). Install the application from the Adobe website if either of the applications is not installed in your computer.

When the DL-10 Software has already been installed from the camera, select **Start > DC Software 2 > Adobe Reader Download** to display the website for downloading.

- For details about Adobe Reader, see the Help for Adobe Reader.

### Copying Pictures to Your Computer

Follow the steps below to copy pictures to your computer.



#### Caution

- Before proceeding, confirm that **Mass Storage** is selected for **USB Connection Type** in the setup menu (page 133).
- To copy pictures stored in the SD memory card, insert the card in the camera first and then connect the camera to the computer.
- Turn the camera off before connecting the USB cable.

### 1 Connect the supplied USB cable to the computer.

### 2 Connect the USB cable to the common terminal for USB port/AV output of the camera.

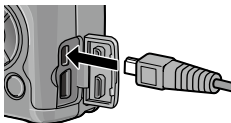

The camera turns on automatically when a connection is established.

### 3 Copy photos to the computer.

#### If DL-10 is installed:

DL-10 starts and transfers images automatically. Pictures are copied to the **Digital Camera** folder in **My Documents**, where they are sorted into separate folders by date of recording. See the “Software User Guide” (PDF file) for more information.

#### If DL-10 is not installed:

Copy files from the camera to the desired location.

When **Digital camera software installer** screen appears, click x.

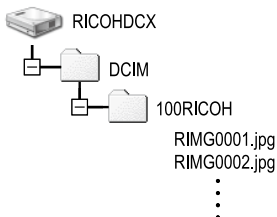

*Example of the display  
in Windows XP*

### 4 Turn the camera off and disconnect the USB cable when transfer is complete.



#### Caution

- Do not turn off the camera or disconnect the USB cable during image transfer.

## For Macintosh

This camera supports the following Macintosh operating systems.

- Mac OS X 10.4 to 10.6.7



### Note

- In the internal memory of the camera, "Software User Guide" (PDF file) is available. To view the guide, copy the guide onto your computer (page 139).

## Copying Pictures to Your Computer

Follow the steps below to copy pictures to your computer.



### Caution

- Before proceeding, confirm that **Mass Storage** is selected for **USB Connection Type** in the setup menu (page 133).
- To copy pictures stored in the SD memory card, insert the card first and then connect the camera to the computer.
- Turn the camera off before connecting the USB cable.

**1** Connect the supplied USB cable to the computer.

**2** Connect the USB cable to the common terminal for USB port/AV output of the camera.

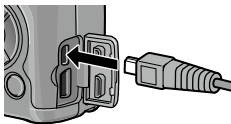

The camera turns on automatically when a connection is established.



### 3 Copy photos to the computer.

Copy files from the camera to the desired location.

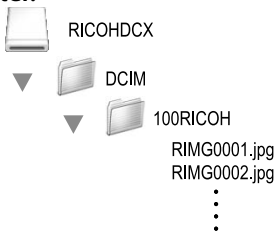

### 4 Disconnect the USB cable when transfer is complete.

Drag the camera volume into the Trash and then disconnect the USB cable.



#### Caution

- Do not turn off the camera or disconnect the USB cable during image transfer.
- If the USB cable is disconnected without disabling the connection, the Unsafe Removal of Device screen may be displayed. Be sure to stop the connection before removing the USB cable.
- When you connect your camera to a Macintosh computer, a file called "FINDER.DAT" or ".DS\_Store" may be created in your SD memory card, which will appear as **Unmatched File** on your camera. You can delete this file from the SD memory card if you wish.

## Troubleshooting

### Error Messages

If an error message is displayed, take the steps listed below.

Message	Solution	Page
Insert card	No memory card inserted. Insert card.	12
Set date.	Camera clock not set. Set camera clock.	17, 133
The file number limit has been exceeded.	Camera is out of file numbers. Insert another card.	12, 132
Unmatched File	Camera cannot display the file. Use computer to check file contents and delete file.	—
Insufficient memory. Continue?	Space on memory card is insufficient to copy all files. Insert another card.	12
Protected	File is protected and cannot be deleted.	90
Card Is Write-Protected.	Card is write protected (locked). Unlock card.	—
Print settings cannot be applied to this file.	File is a movie or other file that cannot be selected for printing.	—
Insufficient Memory/ Capacity short	Insufficient memory to store additional files. Delete existing files or insert another card.	12, 30
	Maximum number of images selected for printing. Set number of prints for other images to zero.	108
Format internal memory.	Internal memory is not correctly formatted. Format internal memory.	123
Format card.	Card is not correctly formatted. Format card in camera.	123
Card Error	Format card. If message persists, card is faulty, discontinue use.	123
Writing Data	Camera is saving data. Wait until save is complete.	—
No File	No files available for playback.	—
Cannot Record	Memory is full. Use another card or remove card and use internal memory.	12

### Power Supply

Problem	Cause	Solution	Page
The camera does not turn on.	Battery is exhausted or not inserted.	Check that battery is correctly inserted. Charge battery (rechargeable battery only), insert fresh battery, or use AC adapter.	10, 12, 158
	Battery is incompatible.	Use supplied battery or compatible AAA batteries.	11
	AC adapter is not connected.	Check connection.	158
	Battery is not in correct orientation.	Insert battery in correct orientation.	12
The camera turns off during use.	Camera has turned off automatically to save power.	Turn camera on.	15
	Battery is exhausted.	Charge battery (rechargeable battery only), insert fresh battery, or use AC adapter.	10, 12, 158
	Battery is incompatible.	Use supplied battery or compatible AAA batteries.	11
The camera does not turn off.	Camera malfunction.	Remove and reinsert battery or disconnect and reconnect AC adapter.	12, 158
Low battery indicator displayed or camera turns off when battery has charge remaining.	Battery is incompatible.	Use supplied battery or compatible AAA batteries.	11
Battery cannot be charged.	Battery has reached end of charging life.	Replace with a new battery.	—
Battery is quickly exhausted.	Ambient temperature is very high or very low.	—	—
	Poor lighting requires extensive use of flash.	—	—

## Shooting

Problem	Cause	Solution	Page
No picture taken when shutter-release button is pressed.	Battery is exhausted.	Charge battery (rechargeable battery only), insert fresh battery, or use AC adapter.	10, 12, 158
	Camera is off or not in shooting mode.	Press <b>POWER</b> button to turn camera on or press  to select shooting mode.	15, 27
	Memory card is not formatted.	Format card.	123
	Memory card is full.	Insert new card or delete files.	12, 30
	Memory card has reached end of working life.	Insert new card.	12
	Flash is charging.	Wait until flash lamp stops blinking.	—
	Memory card is locked.	Unlock card.	—
	Memory card contacts are dirty.	Clean with soft, dry cloth.	—
Cannot view photos after shooting.	Display time is too short.	Choose longer display time.	125
Picture display is blank.	Picture display is dark.	Adjust picture display brightness.	123
	Picture display is off.	Press <b>DISP.</b> to turn picture display on.	33
	AV cable or HDMI cable is connected.	Disconnect the cable.	—
Camera unable to focus in autofocus mode.	Lens is dirty.	Clean with soft, dry cloth.	—
	Subject is not at center of frame.	Use focus lock.	—
	Subject not suitable for autofocus.	Use focus lock or manual focus.	19, 58
	Subject is too close.	Use macro mode or move away from subject.	21
Pictures are blurred.	Camera moved during shooting.	Use tripod or press elbows against torso.	—
	Lighting is poor and shutter speeds are slow.	Use the flash or choose higher ISO setting.	22, 82

Problem	Cause	Solution	Page
Flash does not fire or will not charge.	Flash is not raised.	Slide <b>OPEN</b> switch down to raise flash.	22
	Flash cover is not fully open.	Do not obstruct flash cover.	—
	Bracketing enabled or camera in continuous, dynamic range, interval composite, or movie mode.	Change camera settings.	44, 45, 64, 67, 86
	Flash is off.	Raise flash and choose another flash mode.	22
	Battery is exhausted.	Charge battery (rechargeable battery only), insert fresh battery, or use AC adapter.	10, 12, 158
Flash does not illuminate subject.	Subject is more than 3.0 m/9.8 ft. from camera.	Move closer to subject.	—
	Subject is dark.	Increase flash output.	70
	Flash output is too low.	Increase flash output.	70
	Flash cover is not fully open.	Do not obstruct flash cover.	—
Photos are too bright.	Flash output is too high.	Reduce flash output, move away from subject, or use different light source.	70
	Picture display is too bright.	Adjust picture display brightness.	123
Photos are too dark.	Flash is off and subject is poorly lit.	Raise flash and choose another flash mode.	22
	Picture display is too dark.	Adjust picture display brightness.	123
Colors are unnatural.	Camera unable to adjust white balance for shooting conditions using auto white balance.	Include white object in photo or choose another white balance option.	78
Picture display brightness changes during focusing.	Ambient lighting is poor or differs from that used for autofocus.	This is normal and does not indicate a malfunction.	—
Vertical streaks (“smear”) appear in photos.	Subject is bright.	This is normal and does not indicate a malfunction.	—

Problem	Cause	Solution	Page
Tilt indicator is not displayed.	Off or Sound selected for Level Setting.	Choose Level + Tilt, Level, or Level + Sound.	25
	Indicators are hidden.	Press DISP. to display indicators.	33
	The camera is upside down.	Hold the camera in the correct orientation.	—
Photo is not level, although tilt indicator showed that camera was level.	Camera was moving when photo was taken.	Do not take pictures from moving objects.	—
	Subject is not level.	Straighten subject.	—

### Playback/Deletion

Problem	Cause	Solution	Page
Photo information not displayed.	Indicators are hidden.	Press DISP. to display indicators.	33
Cannot play pictures back.	AV cable/HDMI cable incorrectly connected.	Reconnect the cable.	101
	Video mode does not match TV.	Choose another video mode.	133
Cannot view pictures on memory card.	Card was not formatted in camera.	Insert card that has been formatted in camera and contains pictures recorded with camera.	12, 123
	Pictures were created with other device.		
	Memory card contacts are dirty.	Clean with soft, dry cloth.	—
	Card malfunction.	Insert another card. If you can view pictures on second card, first card has probably malfunctioned, discontinue use.	12
Picture display has turned off.	Battery is exhausted.	Charge battery (rechargeable battery only), insert fresh battery, or use AC adapter.	10, 12, 158
	Camera has turned off automatically to save power.	Turn camera on.	15
Cannot delete file.	File is protected.	Remove protection.	90
	Memory card is locked.	Unlock memory card.	—
Cannot format card.	Card is locked.		

## Miscellaneous

Problem	Cause	Solution	Page
Cannot insert memory card.	Card is not in correct orientation.	Insert in correct orientation.	12
Camera controls have no effect.	Battery is exhausted.	Charge battery (rechargeable battery only), insert fresh battery, or use AC adapter.	10, 12, 158
	Camera malfunction.	Turn camera off and then on again.	15
		Remove and reinsert battery or disconnect and reconnect AC adapter.	12, 158
Date is incorrect.	Clock is not set correctly.	Set clock to correct date and time.	17
Date has been reset.	Battery has not been inserted for about a week.	Set clock to correct date and time.	17
Pictures are not displayed on TV.	Video mode does not match TV.	Choose another video mode.	133
	AV cable/HDMI cable not connected.	Connect the cable.	101
	AV device is not tuned to VIDEO IN channel.	Tune the AV device to VIDEO IN channel.	—

## Specifications

Effective pixels	Approximately 10 million	
Image sensor	1/1.7" CCD (approximately 10.4 million total pixels)	
Lens	Focal length	6.0 mm (35-mm format equivalent: 28 mm)
	Aperture (f-number)	f/1.9 – f/9 (ND filter used for apertures of f/8.0 – f/11 in auto shooting mode)
	Focus range (from lens)	Approx. 30 cm – ∞, approx. 1.0 cm – ∞ in macro mode
	Construction	8 elements in 6 groups (2 aspherical lens elements with 2 surfaces)
Zoom	4.0× digital zoom, approx. 5.7× auto resize zoom (VGA)	
Focus mode	CCD-based multi and spot AF, Subj. Tracking, MF, Snap, ∞, focus lock, and AF-assist	
Blur Reduction	Image Sensor Shift Image Stabilizer	
Shutter speed	Photographs	B (Bulb), T (Time) 180, 120, 60, 30, 15, 13, 10, 8, 6, 5, 4, 3.2, 2.5, 2, 1.6, 1.3, and 1 – 1/2000 s (upper and lower limits vary according to shooting and flash mode)
	Movies	1/30 – 1/2000 s
Exposure control	Metering	TTL-CCD metering in multi (256-segment), center-weighted, and spot modes with autoexposure lock
	Mode	Program AE, Aperture priority AE, Shutter priority AE, Manual exposure
	Exposure compensation	Manual (+2.0 to –2.0 EV in increments of 1/3 EV), Auto bracketing (–0.5 EV, ±0 EV, +0.5 EV and –0.3 EV, ±0 EV, +0.3 EV)
Exposure link range (in auto shooting mode, light metering mode [center])	1.8 EV to 17.7 EV (link range for automatic ISO converted based on the EV for ISO100) *For 5.3 EV or lower, the camera will shift the setting 0.125 EV toward the low brightness side (up to -1.0 EV maximum) for every 1.0 EV that the exposure link range decreases.	
ISO sensitivity (Standard Output Sensitivity)	Auto/Auto-Hi/ISO 80/ISO 100/ISO 125/ISO 160/ISO 200/ISO 250/ISO 320/ISO 400/ISO 500/ISO 640/ISO 800/ISO 1000/ISO 1250/ISO 1600/ISO 2000/ISO 2500/ISO 3200	
White balance	Auto, Multi-P AUTO, Outdoors, Cloudy, Incandescent 1, Incandescent 2, Fluorescent Lamp, Manual Settings, Detail, White balance bracket	



Flash	Mode	Auto (flash fires when lighting is poor or subject is backlit), Red-eye, On, Slow sync, Manual, Off
	Guide number	5.4 (ISO 100 equivalent)
	Range (built-in flash)	Approx. 20 cm – 3.0 m (ISO Auto)
	Flash compensation	$\pm 2.0$ EV in increments of $\frac{1}{3}$ EV
	Charging Time	Approx. 5 seconds when using a rechargeable battery Approx. 8 seconds when using AAA alkaline batteries
Picture display		3.0" transparent LCD, approx. 1,230,000 pixels (640 × 4 × 480 = 1,228,800)
Shooting mode		Auto, Program shift, Aperture priority, Shutter speed priority, Manual exposure, Scene (Dynamic range, Interval composite, Skew correct, Movie), "My Settings"
Picture quality <sup>1</sup>		Fine, Normal, RAW (DNG) <sup>2</sup>
Image size (pixels)	Photographs	3648 × 2736, 3648 × 2432, 2736 × 2736, 3648 × 2048, 3264 × 2448, 2592 × 1944, 2048 × 1536, 1280 × 960, 640 × 480
	Movies	640 × 480, 320 × 240
Storage		SD/SDHC and MultiMedia memory cards, Eye-Fi card (X2 series), internal memory (approx. 40 MB)
File size (approx.)	3648 × 2736	2,193 KB/frame (N), 3,728 KB/frame (F), 14.6 MB/frame (RAW)
	3648 × 2432	1,954 KB/frame (N), 3,319 KB/frame (F), 13.0 MB/frame (RAW)
	3648 × 2048	1,654 KB/frame (N), 2,803 KB/frame (F), 11.0 MB/frame (RAW)
	2736 × 2736	1,657 KB/frame (N), 2,808 KB/frame (F), 11.0 MB/frame (RAW)
	3264 × 2448	3,014 KB/frame (F)
	2592 × 1944	2,311 KB/frame (F)
	2048 × 1536	1,498 KB/frame (F)
	1280 × 960	836 KB/frame (F)
	640 × 480	221 KB/frame (F)
File format	Photographs	JPEG (Exif Ver. 2.21) <sup>3</sup> , RAW (DNG)
	Movies	AVI (OpenDML Motion JPEG compliant)
	Compression	JPEG baseline compliant (photographs and movies)

Other shooting options	Continuous shooting (Continuous, AF-Cont, S-Cont, M-Cont), Self-timer (shutter release delay of approx. 2 s or Custom), Interval shooting (intervals of 5 s to 1 h in increments of 5 s) <sup>4</sup> , White balance bracket, Image setting bracket, Dynamic range bracket, Contrast bracket, Color space setting, AE/AF target selection, Camera shake correction, Dynamic range compensation, Multiple exposure shooting, Noise reduction, Histogram display, Framing grid, Depth-of-field indicator, Tilt indicator, Hot shoe
Other playback options	Auto image rotation, Multi-frame playback, Playback zoom (up to 16×), Slide show, Resize, Skew Correction, Level Compensation, White Balance Compensation, Trim, DPOF
Interface	USB 2.0 (High-Speed), Mass Storage <sup>5</sup> , audio output 1.0 Vp-p (75 Ω), HDMI cable connector (Type D)
Video signal format	NTSC, PAL
Power source	One DB-65 rechargeable battery (3.7 V)
	Two AAA alkaline or NiMH batteries
	Optional AC-4c AC adapter (3.8 V)
Battery life (based on CIPA standard) <sup>6</sup>	<ul style="list-style-type: none"> <li>• DB-65: approx. 390 shots</li> <li>• AAA alkaline batteries: approx. 30 shots<sup>7</sup></li> </ul>
Dimensions (W × H × D)	108.6 mm × 59.8 mm × 25.2 mm (excluding projections)
Weight (approx.)	<ul style="list-style-type: none"> <li>• Camera (excluding battery, memory card, and strap): 190 g</li> <li>• Battery and strap: 30 g</li> </ul>
Tripod screw hole	1/4-20UNC
Date storage time	Approx. 1 week
Operating temperature	0 °C to 40 °C
Operating humidity	90% or less
Storage temperature	-20 °C to 60 °C

1 The options available vary with image size.

2 A JPEG file is also recorded (the JPEG file may be a fine- or normal-quality file with the dimensions as the RAW file or VGA file). RAW files are in the standard DNG format promoted by Adobe Systems, Inc.

3 Compatible with the **Design** rule for **Camera File** system (DCF, a JEITA standard) and DPOF. Full compatibility with other devices is not guaranteed.

4 Flash off.

5 Mass Storage is supported under 64-bit version of Windows XP, Windows Vista, Windows 7, and Mac OS X 10.1.2–10.6.7.

6 Measured according to CIPA standard. For reference only, actual number of shots varies greatly according to how camera is used.

7 Measured with Panasonic alkaline batteries.

## Internal Memory/Memory Card Capacity

The following table lists the approximate number of frames or length of movies that can be stored in internal memory or on a memory card at different settings.

		Internal memory	1 GB	2 GB	4 GB	8 GB	16 GB	32 GB
Photographs	RAW 4:3	2	50	103	203	415	831	1668
	10M 4:3 F	10	240	487	957	1957	3922	7867
	10M 4:3 N	17	411	830	1631	3333	6678	13396
	RAW 3:2	2	57	116	228	467	935	1877
	9M 3:2 F	11	271	548	1077	2202	4412	8851
	9M 3:2 N	19	461	931	1828	3737	7487	15020
	RAW 16:9	2	67	137	270	553	1108	2222
	7M 16:9 F	13	321	653	1284	2624	5257	10546
	7M 16:9 N	23	544	1097	2155	4405	8824	17702
	RAW 1:1	2	67	137	270	551	1105	2217
	7M 1:1 F	13	319	647	1270	2596	5202	10435
	7M 1:1 N	23	544	1097	2155	4405	8824	17702
	8M 4:3 F	12	297	602	1183	2418	4845	9718
	5M 4:3 F	15	370	749	1471	3008	6026	12089
	3M 4:3 F	24	570	1159	2277	4654	9324	18704
1M 4:3 F	43	1041	2118	4160	8505	17039	34181	
VGA 4:3 F	158	3776	7681	15082	30828	61759	123888	
Movies	VGA 640, 30fps	22 s	8 min. 54 s	17 min. 58 s	35 min. 17 s	72 min. 8 s	144 min. 30 s	289 min. 52 s
	VGA 640, 15fps	43 s	17 min. 4 s	34 min. 9 s	67 min. 3 s	137 min. 3 s	274 min. 33 s	550 min. 45 s
	QVGA 320, 30fps	54 s	21 min. 26 s	42 min. 41 s	83 min. 49 s	171 min. 19 s	343 min. 11 s	688 min. 26 s
	QVGA 320, 15fps	1 min. 38 s	38 min. 45 s	78 min. 48 s	154 min. 44 s	316 min. 16 s	633 min. 35 s	1270 min. 57 s



### Note

- The figures for movies are the total length that can be recorded. Each movie can be up to 29 minutes long (4 GB in size).
- Depending on the subject, the number of pictures that can be taken may differ from the number of exposures remaining.
- Capacity varies with shooting conditions and the make of memory card.
- Use a high-speed memory card when shooting for extended periods.

## Optional Accessories

The GR DIGITAL IV can be used with the following optional accessories.



**AC-4c AC adapter**

The adaptor cannot be used depending on country or region.



**DB-65 rechargeable battery**

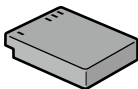

**BJ-6 battery charger**

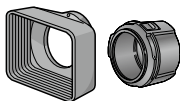

**GH-2 hood and adapter**

A hood to prevent sunlight from entering the lens and an adapter for general-purpose filters with a diameter of 43 mm.

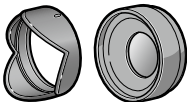

**GW-2 wide conversion lens**

A conversion lens with a focal length multiplier of 0.75x for wide-angle shots, giving a combined focal length of 21 mm (35-mm format equivalent). Requires GH-2. Case included.

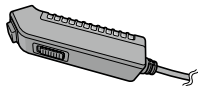

**CA-2 cable switch**

A wired remote shutter release.



**GF-1 external flash**

An external flash with TTL autofocus system (page 159).

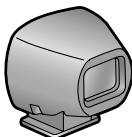

**GV-1 external viewfinder**

An optical viewfinder that attaches to the camera hot shoe. Frames offer coverage for 21 mm and 28 mm lenses (35-mm format equivalent). Case included.

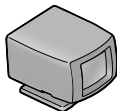

**GV-2 mini external viewfinder**

A compact optical viewfinder that attaches to the camera hot shoe. Frames offer coverage for 28 mm lenses (35-mm format equivalent) with marks for 1:1 aspect ratio. Case included.



**GL-1 Metal Lens Cap**

A metal lens cap with power switch lock for preventing the camera from being turned on accidentally (the camera does not fit in the softcase with the metal lens cap on).



**AV-1 AV cable**

An AV cable for connecting the camera to the video input terminal of a TV etc.



**HC-1 HDMI cable**

An HDMI cable for connecting the camera to a compatible TV, etc.



**GC-3 soft case**



**GC-4 soft case (can be used with GV-2)**

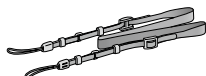

**GS-1 or ST-2 neck strap**

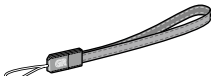

**GS-2 hand strap**



**Note**

- Before using optional accessories, read the manual provided with the product.
- The built-in flash cannot be used with conversion lenses or lens hoods.
- GH-1, GW-1, and GT-1 accessories for GR DIGITAL and GR DIGITAL II cameras cannot be used.
- For the latest information on optional accessories, visit the Ricoh website (<http://www.ricohpmmc.com/>).



### Tip: Ring Cap

- Remove the ring cap before attaching a conversion lens, the lens hood and adapter, or a metal lens cap.
- **To remove the ring cap:** Turn the camera off and rotate the ring cap counterclockwise until it can be removed.
- **To reattach the ring cap:** Turn the camera off and place the cap on the camera body (①) and ring cap (②) aligned. Rotate the cap clockwise until it clicks into place.

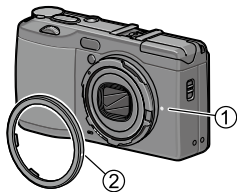

## Camera System and Accessories

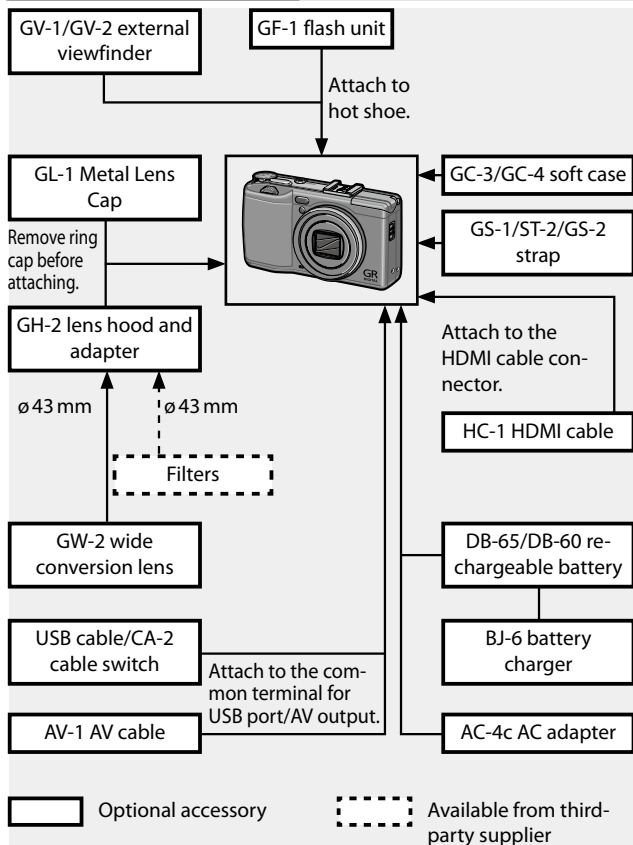

## Using an Optional AC Adapter

An optional AC-4c AC adapter is recommended for extended use or when the camera is connected to a computer. Be sure the camera is off before connecting the AC adapter.

### 1 Open the battery/card cover.

Unlatch and open the cover and remove batteries.

### 2 Insert the AC adapter coupler.

The battery latch will click into place when the coupler is fully inserted.

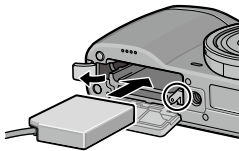

### 3 Place the cable in the cable channel.

Open the power (DC input) cable cover and place the power cable in the cable channel.

### 4 Close the battery/card cover.

Close and latch the cover.

#### **Caution** .....

- Be sure the cover is latched.

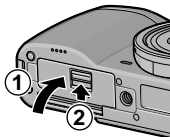

### 5 Plug the adapter in.

Attach the AC cable to the adapter and plug it in to a power outlet.

#### **Caution** .....

- Be sure that both plugs are fully inserted.
- Disconnect the AC adapter and unplug it from the power outlet when not in use.



- Data may become corrupted if the AC adapter is disconnected or power is interrupted while the camera is on.
- The battery indicator (  ) may be displayed while the AC adapter is in use. This is normal, and you can continue using the camera.
- Do not pick up the camera by the cable when the AC adapter is attached.
- The adaptor cannot be used depending on country or region.

## Flash Unit

An optional GF-1 flash unit (TTL autoflash system) can be connected to the camera hot shoe.

**1 Close the flash cover.**

**2 Remove the hot shoe cover from the hot shoe of the camera.**

**3 Attach the flash.**

Turn the camera and the GF-1 off and attach the GF-1 to the hot shoe.



**4 Turn the flash and camera on.**



### Note

- If the optional flash unit icon is not displayed, turn the GF-1 and camera off and then remove and reattach the flash.
- Switch the flash modes by pressing the  button. If using the manual flash, set the flash mode to the manual flash setting in both of the camera and GF-1. The flash amount can be selected in **Manual Flash Amount** in the shooting menu (page 71).
- Optional flash unit cannot be used in interval shooting, dynamic range shooting, and interval composite shooting.

## **Other Flash Units**

Use only flash units with one signal terminal, which must be an X-contact with a positive voltage of no more than 20V. Use a flash that covers the angle of view of the lens.

**1 Close the flash cover.**

**2 Attach the flash.**

Turn the camera and the optional flash unit off and attach the flash to the camera hot shoe.

**3 Set aperture manually.**

Turn the camera on, select mode **A** or **M**, and choose an aperture (pages 38 and 40).

**4 Choose a manual ISO sensitivity setting.**

Select an option other than **Auto** or **Auto-Hi** for ISO sensitivity (page 82).

**5 Turn the flash on.**

Turn the flash on and set it to auto mode. Set aperture and ISO sensitivity to the values selected with the camera. Take a test shot and adjust flash aperture and ISO settings as necessary.

### **Caution**

- Turn the optional flash unit off before removing it from the camera.
- Do not raise the built-in flash when an optional flash unit is attached to the camera.
- If the external flash is on, it will fire with every shot regardless to the flash mode selected with the camera. Turn the flash unit off to shoot without the flash.
- Optional flash units are in principle for use at ranges that exceed the range of the built-in flash. Using an optional flash unit at shorter ranges may result in overexposure.

## **Using the Camera Abroad**

---

### ***Using the AC-4c AC Adapter and BJ-6 Battery Charger***

These products are for use with currents of 100–240V and 50 or 60Hz. Before travelling, purchase a travel adapter for connection to the type of outlets used at your destination. Do not use these products with electrical transformers, as this could damage the camera.

### ***Warranty***

This product was manufactured for use in the country of purchase, and the warranty is not valid in other countries. Should the product fail or malfunction while out of the country, the manufacturer assumes no responsibility for servicing the product locally or bearing any expenditure incurred thereby.

### ***Television Playback***

An AV cable can be used to connect the camera to televisions and monitors equipped with a video input terminal. The camera supports the NTSC and PAL video formats. Before connecting the camera to a video device, select the appropriate video output mode.

## **Precautions for Use**

---

- This product was manufactured for use in the country of purchase, the warranty is not valid in other countries. Should the product fail or malfunction while out of the country, the manufacturer assumes no responsibility for servicing the product locally or bearing any expenditure incurred thereby.
- Do not drop the camera or subject it to physical shocks. When carrying the camera, be careful that it does not strike other objects. Particular care is required to protect the lens and picture display.

- The flash may overheat if fired many times in succession. Do not use the flash more than necessary. Do not use the flash in close contact with your body or other objects. Failure to observe these precautions could result in burns or fire.
- Using the flash unit in close proximity to your subject's eyes could cause temporary visual impairment. Particular care should be observed when photographing infants. Do not direct the flash at the operator of a motor vehicle.
- Batteries may become hot with extended use. Wait for batteries to cool before removing them from the camera.
- The picture display may be difficult to read in direct sunlight.
- You may notice that picture display varies in brightness or contains pixels that do not light or that are always lit. This is common to all LCD monitors and does not indicate a malfunction.
- Do not apply force to the picture display.
- Abrupt changes in temperature may cause condensation, resulting in visible condensation inside the lens or camera malfunction. This can be avoided by placing the camera in a plastic bag to slow the temperature change, and removing it only after the air in the bag has reached the same temperature its surroundings.
- To prevent damage to the product, do not insert objects into the holes in the microphone and speaker coverings.
- Keep the camera dry and avoid handling it with wet hands. Failure to observe these precautions could result in product malfunction or electric shock.
- Take a test shot to ensure that the camera is functioning properly before using it on important occasions such as travel or weddings. We recommend that you keep this manual and spare batteries at hand.

**Tip: Avoiding Condensation**

- Condensation is particularly likely to occur if you move to an area with a sharply different temperature, if humidity is high, in a cold room after the heater has come on, or where the camera is exposed to cold air from an air conditioner or other device.

## Camera Care and Storage

---

### ***Caring for the Camera***

- Photographs can be affected by fingerprints and other foreign matter on the lens. Avoid touching the lens with your fingers. Remove dust or lint with a blower from a camera supply store, or gently clean the lens with a soft, dry cloth. Clean the picture display by wiping it with a soft cloth dampened with a small amount of any monitor cleaner that does not contain organic solvents.
- Clean the camera thoroughly after using it at the beach or handling cosmetics. Do not expose the camera to volatile substances such as thinner, benzene, or pesticides. Failure to observe this precaution could result in damage to the camera or its finish.
- In the unlikely event of malfunction, visit a Ricoh Repair Center.
- The camera contains high-voltage circuits. Do not disassemble.
- The picture display is easily scratched, avoid touching it with hard objects.

### ***Storage***

- Do not store the camera where it will be exposed to: extreme heat or humidity, large changes in temperature or humidity, dust, dirt, or sand, severe vibration, prolonged contact with chemicals, including mothballs and other insect repellent, or with vinyl or rubber products, strong magnetic fields (for example, in the vicinity of a monitor, transformer, or magnet).
- Remove the batteries if the product will be left unused for a long period of time.

### ***Before Cleaning***

Turn the camera off and remove the battery or disconnect the AC adapter.

## Warranty and Servicing

---

1. This product is backed by a limited warranty. During the warranty period mentioned in the Warranty supplied with your camera, any defective parts will be repaired free of charge. In the event of a camera malfunction, contact the dealer from which you purchased the camera or your nearest Ricoh Repair Center. Please note that you will not be reimbursed for the cost of bringing the camera to the Ricoh Repair Center.
2. This warranty does not cover any damage resulting from:
  - 1 failure to follow the instructions in the instruction manual;
  - 2 repair, modification or overhaul not conducted by an authorized service center listed in the instruction manual;
  - 3 fire, natural disaster, act of God, lightning, abnormal voltage, etc.;
  - 4 improper storage (noted in the "Camera User Guide"), leaking of battery and other fluids, mold, or otherwise insufficient care of the camera.
  - 5 submergence in water (flooding), exposure to alcohol or other beverages, infiltration of sand or mud, physical shock, dropping of the camera, or pressure on the camera, and other unnatural causes.
3. After the warranty period has passed, you will be liable for all repair fees, including those incurred at an authorized service center.
4. You will be liable for all repair fees, even within the warranty period, if the warranty card is not attached or if the distributor's name or the purchase date have been changed or are not indicated on the card.
5. Expenses for overhaul and thorough inspection by special request of the customer will be charged to the customer, whether or not they are incurred during the warranty period.
6. This warranty only applies to the camera and not to the accessories, such as the case and strap, nor does it apply to the battery and other consumables provided.
7. Any consequential damages arising from failure of the camera, such as expenses incurred in taking pictures or loss of expected profit, will not be reimbursed whether they occur during the warranty period or not.
8. The warranty is only valid in the country in which the camera was purchased.
  - \* The above provisions refer to repairs offered free of charge, and do not limit your legal rights.
  - \* The intention of the above provisions is also described in the warranty card provided with this camera.
9. Parts essential to the servicing of the camera (that is, components required to maintain the functions and quality of the camera) will be available for a period of five years after the camera is discontinued.
10. Please note that if the camera is seriously damaged by flooding, submergence, infiltration of sand or mud, violent shocks or dropping, it may not be repairable, and restoration to its original condition may be impossible.



### Note

- Before sending the camera in for repair, check the battery and read the instruction manual again to ensure proper operation.
- Some repairs require a significant amount of time to complete.
- When sending the camera to a service center, please include a note which describes the defective part and the problem as precisely as possible.
- Remove all accessories not related to the problem before sending the camera to the service center.
- This warranty does not apply to data stored on memory cards or in internal memory.

## NOTICES

---

### **INFORMATION TO THE USER**

#### **USA FCC Part 15 Class B**

This equipment has been tested and found to comply with the limits for a Class B digital device, pursuant to part 15 of the FCC Rules. These limits are designed to provide reasonable protection against harmful interference in a residential installation. This equipment generates, uses and can radiate radio frequency energy and if not installed and used in accordance with the instructions, may cause harmful interference to radio communications. However, there is no guarantee that interference will not occur in a particular installation. If this equipment does cause harmful interference to radio or television reception, which can be determined by turning the equipment off and on, the user is encouraged to try to correct the interference by one or more of the following measures:

- Reorient or relocate the receiving antenna.
- Increase the separation between the equipment and receiver.
- Connect the equipment into an outlet on a circuit different from that to which the receiver is connected.
- Consult the dealer or an experienced radio/TV technician for help. (FCC 15.105B)

Changes or modifications not expressly approved by the party responsible for compliance could void the user's authority to operate the equipment. (FCC 15.21)

Properly shielded and grounded cables and connectors must be used for connections to host computer in order to comply with FCC emission limits. (FCC 15.27)

An AC adapter with a ferrite core must be used for RF interference suppression.

#### **COMPLIANCE INFORMATION STATEMENT**

Product Name: DIGITAL CAMERA

Model Number: GR DIGITAL IV

This device complies with Part 15 of the FCC Rules.

Operation is subject to the following two conditions:

- (1) This device may not cause harmful interference, and
- (2) This device must accept any interference received, including interference that may cause undesired operation.

RICOH AMERICAS CORPORATION

5 Dedrick Place, West Caldwell NJ, 07006 Tel.: 1-800-225-1899

#### **Note to Users in Canada**

**Note:** This Class B digital apparatus complies with Canadian ICES-003

#### **Remarque Concernant les Utilisateurs au Canada**

**Avertissement :** Cet appareil numérique de la classe B est conforme a la norme NMB-003 du Canada

IMPORTANT SAFETY INSTRUCTIONS—SAVE THESE INSTRUCTIONS  
DANGER—TO REDUCE THE RISK OF FIRE OR ELECTRIC SHOCK, CAREFULLY FOLLOW THESE INSTRUCTIONS.

# Index

## A

- A (aperture priority) mode..... 38
- AV cable ..... 101
- AAA alkaline ..... 11
- AC adapter ..... 158
- ADJ. Direct ISO Control**..... 122
- ADJ. mode** ..... 118
- ADJ Lever Setting**..... 117
- ADJ Shutter Confirmation**..... 118
- ADJ. lever..... 5
- Adobe Reader ..... 140
- AF auxiliary light..... 2, 124
- AF sensor, external..... 2
- Alkaline ..... 11
- Aperture..... 6, 7
- Area measured for manual WB**... 131
- Auto Aperture Shift**..... 83
- Auto Bracket**..... 67
- Auto (📷) mode ..... 18
- Auto Power Off**..... 125
- Auto Rotate**..... 129
- Autofocus/flash lamp..... 19, 23
- AVI..... 86

## B

- B (bulb)..... 41
- Battery ..... 10, 12
- Battery charger..... 10, 154
- Battery level..... 8
- Battery/card cover..... 12
- Black-and-white ..... 62
- Bleach Bypass** ..... 62
- Blur..... 20
- Bracketing..... 67

## C

- Cable switch ..... 154
- Capacity ..... 11, 153
- Card Sequence No.** ..... 132
- Case, soft..... 155
- Close-up..... 21
- Color Space Setting**..... 130

- Camera Shake Correction**..... 74
- Computer ..... 135
- Confirm Firmware Version**..... 134
- Connector cover..... 101, 105
- Continuous Mode** ..... 64
- Contrast..... 96
- Conversion lens, wide..... 154
- Copy to Card from Internal Memory**..... 94
- Copying to computer..... 140, 142
- Cross Process**..... 62
- Custom Self-Timer** ..... 74

## D

- Date and time ..... 17, 133
- Date Imprint**..... 76
- DC power cable cover..... 3, 158
- Defaults ..... 50–52, 110, 111
- Delete My Settings** ..... 122
- Deleting photographs ..... 30
- Depth of field..... 56
- Digital zoom ..... 20
- Digital Zoom Image** ..... 131
- DISP. button ..... 33
- DL-10..... 135, 141
- DNG ..... 54
- DPOF**..... 92
- Dynamic range ..... 42, 44
- Dynamic Range Compensation** .... 72
- Dynamic Range Expansion** ..... 84

## E

- Edit My Settings**..... 115
- Error message ..... 144
- Exposure Compensation**..... 77
- Exposure lock (AE Lock) ..... 59
- Exposure Metering** ..... 61
- Exposure program ..... 37
- Eye-Fi..... 8, 13, 134

## F

- Fine picture quality..... 54
- Flash cover ..... 23



<b>Flash Exposure Compensation</b> .....	70
Flash level.....	71
Flash mode.....	22
Flash OPEN switch (⚡ OPEN).....	2, 22
<b>Flash Synchro Settings</b> .....	71
Flash, built-in.....	22
Flash, manual.....	71
Flash, optional.....	159
<b>Fn Button Pair Setting</b> .....	119
<b>Fn Button Pair Switching</b> .....	120
Focus.....	19, 55
Focus bar.....	56
Focus lock.....	58
Focus target.....	59
Formatting.....	123
<b>Frame Rate</b> .....	87
<b>Full Press Snap</b> .....	60

## **G**

Grid.....	33, 127
-----------	---------

## **H**

HDMI.....	102, 134
<b>Hi-Contrast B&amp;W</b> .....	62
Highlights.....	34
Histogram.....	33, 34, 97
Hood and adapter.....	154
Hot shoe.....	159

## **I**

Image setting bracketing.....	67
<b>Image Settings</b> .....	62
<b>Information Display Mode</b> .....	128
Installation.....	137
<b>Interval Composite</b> .....	42, 45
<b>Interval Composite Time</b> .....	84
<b>Interval Shooting</b> .....	75
<b>ISO Auto-High Settings</b> .....	124
<b>ISO Setting</b> .....	82
<b>ISO Step Setting</b> .....	124

## **J**

JPEG.....	54, 130
-----------	---------

## **K**

Key custom options.....	110, 112
-------------------------	----------

## **L**

<b>Language/言語</b> .....	17, 133
<b>LCD Auto Dim</b> .....	126
<b>LCD Brightness</b> .....	123
<b>LCD Confirmation Time</b> .....	125
<b>Level Compensation</b> .....	96
<b>Level Setting</b> .....	126
<b>Level (Tilt) Calibration</b> .....	126
Lock release.....	4

## **M**

M (manual exposure) mode.....	40
<b>M Mode Dial Options</b> .....	121
Macintosh.....	142
Macro mode.....	21
<b>Macro Target</b> .....	59, 120
<b>Magnification Ratio (MF)</b> .....	83
<b>Manual Flash Amount</b> .....	71
Manual focus.....	55, 58
MediaBrowser.....	135
Memory card.....	12
Memory, internal.....	14, 94, 153
<b>MENU/OK button</b> .....	49, 89, 109
Microphone.....	3
Mode dial.....	4
Monochrome.....	62
<b>Move Target Setting</b> .....	74
Movie mode.....	42, 52, 86
Movie playback.....	88
<b>Movie Size</b> .....	87
Multi-frame playback.....	28
<b>Multiple Exposure Shooting</b> .....	68
MY modes.....	48
<b>My Settings for Fn Settings</b> .....	117
<b>My Settings WB Comp</b> .....	117

## **N**

Neck strap.....	155
Nickel-metal hydride (NiMH).....	11
<b>Noise Reduction</b> .....	73
<b>Noise Reduction ISO</b> .....	73
Normal picture quality.....	54
NTSC.....	102, 133

## **O**

<b>One Press M Mode</b> .....	122
<b>One Press Zoom Ratio</b> .....	128
<b>Operation Sounds</b> .....	125
<b>Optional accessories</b> .....	154, 157
<b>Optional AF Distance Display</b> .....	126

## **P**

<b>P (program shift) mode</b> .....	36
<b>PAL</b> .....	102, 133
<b>PictBridge</b> .....	104
<b>Picture Display</b> .....	6, 33
<b>Picture Quality/Size</b> .....	53
<b>Playback menu</b> .....	89
<b>Playback Mode Dial Options</b> .....	121
<b>Playback Order Options</b> .....	130
<b>Playback zoom</b> .....	29
<b>Playback, movies</b> .....	88
<b>Playback, photographs</b> .....	27
<b>Playback, TV</b> .....	101
<b>Plus Normal Shooting</b> .....	84
<b>Positive Film</b> .....	62
<b>POWER button</b> .....	15
<b>Power Button Lamp</b> .....	121
<b>Pre-AF</b> .....	61
<b>Printing</b> .....	104
<b>Protect</b> .....	90
<b>PTP</b> .....	104, 133

## **R**

<b>RAW</b> .....	54
<b>RAW/JPEG Setting</b> .....	130
<b>Recall My Settings</b> .....	114
<b>Rechargeable battery</b> .....	10, 12
<b>Red-eye reduction</b> .....	22
<b>Reg. My Settings</b> .....	112
<b>Remote shutter release</b> .....	154
<b>Resize</b> .....	94
<b>Restore Defaults</b> .....	83, 110
<b>Ring cap</b> .....	156

## **S**

<b>S (shutter priority) mode</b> .....	39
<b>Save Interval Composite Img.</b> .....	85
<b>Scene mode</b> .....	42

<b>SD memory card</b> .....	12
<b>SDHC memory card</b> .....	12
<b>Self-timer</b> .....	24
<b>Setup menu</b> .....	111
<b>Shooting Info. Display Frame</b> .....	127
<b>Shooting menu</b> .....	49
<b>Shutter speed</b> .....	150
<b>Shutter Speed Auto Shift</b> .....	83
<b>Size</b> .....	53
<b>Skew correction</b> .....	47, 95
<b>Sleep Mode</b> .....	126
<b>Slide Show</b> .....	90
<b>Snap Focus Distance</b> .....	60
<b>Software</b> .....	135
<b>Speaker</b> .....	3
<b>Specifications</b> .....	150
<b>Store Menu Cursor Position</b> .....	131
<b>Strap eyelet</b> .....	2
<b>Subj. Tracking</b> .....	55
<b>Switch Shooting Mode</b> .....	84
<b>System requirements</b> .....	136

## **T**

<b>T (time)</b> .....	41
<b>Target selection (AF/AE)</b> .....	59, 74
<b>Tilt indicator</b> .....	25
<b>Time and date</b> .....	17, 133
<b>Trim</b> .....	100
<b>TV</b> .....	101

## **U**

<b>Up-down dial</b> .....	5
<b>USB cable</b> .....	104, 137, 142
<b>USB Connection Type</b> .....	133

## **V**

<b>Video Out Mode</b> .....	133
<b>Viewfinder, external</b> .....	154
<b>Viewing photographs</b> .....	27, 101
<b>Volume</b> .....	88, 125

## **W**

<b>Warranty</b> .....	161, 164
<b>White Balance</b> .....	78

<b>White Balance Compensation</b>	
.....	81, 99
<b>White Saturation Display</b>	129
Wireless LAN.....	13, 134
Windows.....	135

## **Z**

Zoom.....	20, 29
<b>Zoom Button</b> .....	121

## **Telephone Support Numbers in Europe**

---

<b>UK</b>	(from within the UK)	0203 0262290
	(from outside the UK)	+44 203 0262290
<b>Deutschland</b>	(innerhalb Deutschlands)	06331 268 438
	(außerhalb Deutschlands)	+49 6331 268 438
<b>France</b>	(à partir de la France)	0800 88 18 70
	(en dehors de la France)	+33 1 60 60 19 94
<b>Italia</b>	(dall'Italia)	02 40326427
	(dall'estero)	+39 02 40326427
<b>España</b>	(desde España)	911 230396
	(desde fuera de España)	+34 911 230396
<b>Belgium</b>	(from outside the Belgium)	+32 2 8088300 (French)
	(from outside the Belgium)	+32 505 51082 (Flemish)

[http://www.ricoh.com/r\\_dc/](http://www.ricoh.com/r_dc/)

## From environmental friendliness to environmental conservation and to environmental management

Ricoh is aggressively promoting environment-friendly activities and also environment conservation activities to solve the great subject of management as one of the citizens on our precious earth.

To reduce the environmental loads of digital cameras, Ricoh is also trying to solve the great subjects of "Saving energy by reducing power consumption" and "Reducing environment-affecting chemical substances contained in products".



### If You Encounter a Problem with This Product

See "Troubleshooting" (page 144) in this manual. If the problem persists, contact a Ricoh office.

Ricoh Offices	
RICOH COMPANY, LTD.	3-2-3, Shin-Yokohama Kouhoku-ku, Yokohama City, Kanagawa 222-8530, JAPAN <a href="http://www.ricoh.com/r_dc/">http://www.ricoh.com/r_dc/</a>
RICOH AMERICAS CORPORATION	5 Dedrick Place, West Caldwell, New Jersey 07006, U.S.A. 1-800-22RICOH <a href="http://www.ricoh-usa.com/">http://www.ricoh-usa.com/</a>
RICOH INTERNATIONAL B.V. (EPMCM)	Oberrather Straße 6, D-40472 Düsseldorf, GERMANY (innerhalb Deutschlands) 06331 268 438 (außerhalb Deutschlands) +49 6331 268 438 <a href="http://www.ricoh.com/r_dc/">http://www.ricoh.com/r_dc/</a>
RICOH ASIA PACIFIC OPERATIONS LIMITED	21/F, One Kowloon, 1 Wang Yuen Street, Kowloon Bay, Hong Kong
About MediaBrowser	
North America (U.S.)	(Toll Free) +1-800-458-4029
Europe	UK, Germany, France and Spain: (Toll Free) +800-1532-4865 Other Countries: +44-1489-564-764
Asia	+63-2-438-0090
China	+86-21-5385-3786
Business hours: 9:00 AM to 5:00 PM	

Ricoh Company, Ltd.  
Ricoh Building, 8-13-1, Ginza, Chuo-ku, Tokyo  
104-8222, Japan  
2011 August

**En** EN (USA) GB (GB) AE (AE)  
Printed in China



\* L 7 6 4 0 8 7 2 A \*