

CAMPERVANS

 ADRIA



Inspiration for *your* adventures.

Inspiration for *your* adventures.

The Adria *Campervan* Collection

The Adria **brand promise** is 'to deliver premium quality, design and value, for memorable experiences'.



We have the best job in the world
We create inspiration for your adventures
We design our campervans from the heart, for the soul
Designed for living
Designed to perform
An innovative spirit and an obsession for quality
We know it's never just a vehicle, it's part of your story
What are you waiting for?



inspirations
magazine

DISCOVER MORE AT: WWW.ADRIA-MOBIL.COM

Why choose Adria?

**IF YOU ARE SEEKING FREEDOM AND ADVENTURE,
OWNING A CAMPERVAN IS A GREAT CHOICE.**

YOUR VEHICLE

Freedom and adventures when you want it, just plan your getaways and go!

YOUR ACCOMMODATION

Your own controlled environment. Travel with family, friends, with your things and to your standards.

YOUR ITINERARY

Independent travel, no more airports or hotels. Stay away from the crowds and find your own places.

YOUR ADVENTURES

Life changes with a campervan, offering endless possibilities for your adventures

YOUR PEACE OF MIND

Adria is one of the Europe's leading recreational vehicle manufacturers, with over 600,000 vehicles produced since 1965.



Campervans that inspire

THE REASONS FOR CHOOSING ADRIA HAVE NEVER BEEN SO COMPELLING.

PASSION .

Over fifty years of experience, skill and passion applied to every vehicle.

INSPIRED DESIGN .

Campervans designed for living and designed to perform.

WORLD-CLASS MANUFACTURING .

ISO 9001 EFQM 5 star certified advanced manufacturing facilities.

SUSTAINABILITY .

Environmental management system certified to ISO 14001. Committed to sustainable development, prevention and reducing environmental impacts.

PREMIUM QUALITY .

World-class manufacturing and quality control techniques for durability and reliability.

PEACE OF MIND .

Class-leading warranty, the support of over 500 Adria dealers, world-class parts supply and aftersales service.

AWARD-WINNING VEHICLES .

Independent awards for design, innovation, quality and customer satisfaction.

Watch the production
process movie at
www.adria-mobil.com



Highlights

TWIN SPORTS MEET THE NEW GENERATION

SPORTS VAN OR FAMILY VAN? BOTH.

New generation Twin Sports range, built on the new Fiat Ducato, perfect for outdoor sports enthusiasts and for families. The sports campervan with the original and best SunRoof, 'cabin-loft' interior and pop-top roof accommodation, now available in four layouts.



TWIN SPORTS LAYOUTS

Available in a choice of four layouts.



**ADRIA
MACH**

For an easier life.

Adria MACH smart control mobile application, available for the first time on Twin Sports, Twin Supreme and Plus models in two versions – MACH and MACH Plus.



TWIN SPORTS 640 SG

Exclusive layout for sporty people, with innovative rear space, with special storage solutions for outdoor gear.

VIEW
ONLINE

Discover 360° walkthroughs,
layouts, specification technical
data and our product configurator
at www.adria-mobil.com

Highlights

TWINS ESCAPE THE ORDINARY



**EUROPEAN
INNOVATION
AWARD FOR
DESIGN.**

Our Twin campervans,
continue to lead with innovation,
style and quality. Built on the new
Fiat Ducato; and Citroën Jumper.
The campervan with the original
and best SunRoof and
'cabin-loft' interior.

Available as Supreme,
Plus and Axess models,
with a choice of layouts.



BASE VEHICLES



ACTIVE MPC

PLAY.STAY.EVERYDAY.
Multi-Purpose Camper built on the
new Renault Trafic, available in two
models – Base and Pro.



All our campervans now feature the new
Fiat Ducato, the base vehicle offering the
latest in design, performance, comfort
and safety. Our Twins Axess models are
also available on the Citroën Jumper,
offering exceptional value.

Fiat 2.2 I Multijet 3 (Euro 6.d Final)
engines, a choice of manual or automatic
gearbox (from 140 HP on), the latest
exterior and interior styling, including new
cabin, dashboard, infotainment systems,
driver and safety aids.



Citroën Jumper, available on
Twin Axess models. Powerful
2.2 I HDI (Euro 6.3) engines
with a high level of standard
equipment, a manual only
6-speed gearbox and a large
90 l fuel tank.

Designed for living

DETAILS MATTER

All of our campervans are designed for living, where the details matter and every centimetre counts. The science of layouts and construction, with everything in the right place, is learned over decades and Adria brings this experience to every layout.



VIEW
ONLINE

Discover 360° walkthroughs,
layouts, specification technical data
and our product configurator at
www.adria-mobil.com

Contemporary living spaces and a choice of layouts, furniture and textiles.



kitchens

Kitchen designs based on ergonomic principles, with style and functionality, matched with the best appliances.



bathrooms

Bathroom solutions
dependent on the model, with quality fittings.



Duplex bathroom solution features swivelling wall (selected models only).



Compact, fixed bathroom for smaller layouts.

bedrooms

A choice of sleeping solutions, beds with optimised dimensions and really comfortable mattresses.



TWIN SPORTS

Adria exclusive design pop-top sleeping compartment adds extra accommodation.



120x200 cm sleeping compartment with comfortable bed, useful storage space, USB ports and reading lights. Sleeping compartment tent is made in acrylic-based materials, for insulation, water resistance and breathability.

Twin 640 SGX and Twin Sports 640 SGX features elevating rear bed, with useful storage space below.



Sleep well

We offer a range of premium quality mattresses giving great comfort and support. Featuring high resistance foam construction, easy-care fabric and natural protection against bacteria, odours and static.



Smart lighting management, with spot, LED and ambient lights, easy to control your ambience in all living spaces.

FABRIC



AIR KNITTED FABRIC



ZIPPER



WASHABLE
40 DEGREES



DRYING IN AIR
NOT MACHINE

SILVER PROTECTION



100% NATURAL



NON-TOXIC



ANTI-STATIC



ANTIBACTERIAL



ANTI-ODOUR

» multimedia

Inspired entertainment solutions for entertainment on the go. Easy to use Adria digital controllers for the main living functions.



» storage

Optimized storage throughout, places for all the things you need.

Twin Sports 640 SG features vario-space XL garage, with removable beds, track system, drying wardrobe for outdoor gear and hard tool storage.



storage

Optimized storage throughout,
places for all the things you need.



For an easier life

Our smart control mobile application controls key functions, monitors utilities, gives access to user manuals, navigation data and Mobile Office functions, from the convenience of your smart phone or tablet.

Pre-installation standard on **Twin Sports, Twin Supreme and Plus** models with the option to install MACH or MACH Plus, at order stage or after delivery.



Discover more at www.adria-mobil.com/MACH

*SIM card required

**if vehicle is fitted with this option

MACH

uses Bluetooth® for **local control** of key functions (control panel, heating, air-conditioning** refrigerator, lighting, water pump, water tank levels and battery status). Also enables monitoring of external and internal temperature and provides basic vehicle information and levelling data.

MACH PLUS

uses Bluetooth® Wi-Fi and LTE for **local and remote control*** of key functions (control panel, heating, air-conditioning** refrigerator, lighting, water pump, water tank levels and battery status) with statistics and prediction feature. MACH plus also monitors air pressure, outside humidity and gives access to **interactive User Manuals**, vehicle information and levelling data as well as **Mobile Office Wi-Fi hotspot*** functionality (access to web, IP radio and TV).

HOW MACH WORKS



INSTALL

the app. from Google Play or Apple Store or visit adria-mobil.com/mach



CONNECT

to your vehicle.



CREATE

your Adria ID.



ENJOY

a tailored experience.

Designed to perform

Real world performance

All Adria campervans are also designed to perform. Everything is meticulously designed, developed and tested to ensure your safety, comfort and enjoyment. Built to enjoy, built to last.



1_INSPIRED DESIGN.

Designed with seamless integration of interior spaces, contemporary interiors and Adria signature features.

2_BASE VEHICLES.

Perfect integration with the base vehicle, with a choice of Fiat and Citroën depending on the model you select. The latest Euro 6 engines and a range of driver and safety aids.

3_BODY CONSTRUCTION.

Strong, robust body construction with a 7 Year Water Ingress Warranty.

4_INSULATION.

The latest thermal insulation materials, sophisticated heat and air flow management to Adria's 'Thermo-build' standards and no 'cold-spots'.

5_HEATING.

Truma heating (with optional Webasto on selected models). Heated and insulated waste water tank also available.

6_AIRFLOW.

Adria's sophisticated Air Flow System means every vehicle has integrated air-flow and ventilation, with no cold-spots.

7_WINDOWS & DOORS.

Framed windows, soft-closing doors and SunRoof (model dependent) for optimum lighting, ventilation, privacy and security.

8_FURNITURE & STORAGE.

Craftsman-built cabinetry integrated with heating and air flow for optimum thermal efficiency. Great storage solutions inside.

9_COMFORT.

Contemporary living spaces with optimized space and functionality for comfortable living and a home-style feeling.

10_CUSTOMER SERVICE.

Class-leading 2 Year General Warranty and 7 Year Water Ingress warranty as standard, a dealer network of over 500 dealers, and efficient after sales and parts service, with roadside assistance, where provided by the base vehicle manufacturer.

Climate control

Our campervans are designed for use, all year round.

INSULATION

Adria 'Thermo-build' standards of insulation and air-flow management, built with advanced insulation materials, best heating design and air-flow for controllable comfort, all year round.

TESTED TO EXTREMES

All vehicles are tested in our own climate chamber, from -40 to +60 degrees and in humidity from 45 % to 80 % between +30 and +60 degrees.

AIR-CONDITIONING

Optional air-conditioning available to order.

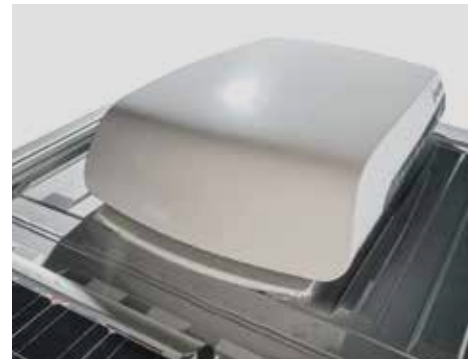

HEATING

Heating by Truma, Alde and Webasto, dependent on model. Precisely engineered and cold-chamber tested.

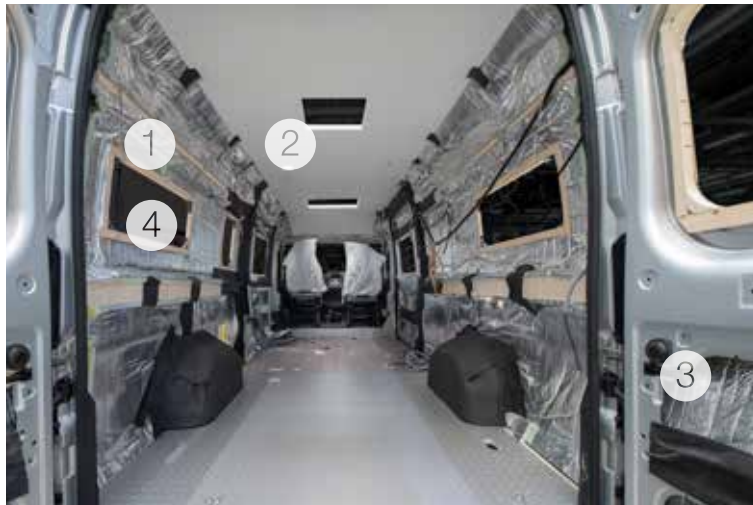

Optimised insulation, moisture control and reduced heat-loss in all vans. Twin Sports, Twin Supreme and Plus models with enhanced insulation:

- 1 Reduced thermal bridges and new thermal breaks.
- 2 Recycled Ecofiber 40 material, heat-bonded for better insulation.
- 3 Improved insulation and air-loops around doors and windows.
- 4 Vapour barriers to prevent condensation.



AIR-FLOW MANAGEMENT

Adria's integrated Air Flow System for ventilation and the optimum circulation of air, cooling and heating.

POWER PACK

Enjoy more autonomy with our optional Power Pack, including high performance Solar Panels and LiFe PO4 lithium battery.

Fiat Ducato TWIN SPORTS/TWIN SUPREME/TWIN PLUS/TWIN AXESS

Choose the new Fiat Ducato, the base vehicle offering the latest in design, performance, comfort and safety.

Powerful and efficient 2.2 I Multijet 3 (Euro 6.d Final) engines, at 120 HP, 140 HP, Power 160 HP and Power 180 HP.

A choice of manual or automatic gearbox (from 140 HP on), the latest exterior and interior styling, including new cabin, dashboard, infotainment systems, driver and safety aids.



Base Vehicles

We choose the base vehicle and chassis for each campervan for the best torsional strength, performance dynamics and interior living space design.

All vehicles offer the latest Euro6 engines, advanced driver and safety aids.

EXTERIOR FEATURES

New exterior styling with new front grill, and many features available including full LED lights, black trim skid-plate and fog-lights with cornering function.



16" Light chassis alloy wheels



16" Light chassis alloy wheels



16" Heavy chassis alloy wheels



16" Heavy chassis alloy wheels /
9 Automatic Transmission

INTERIOR FEATURES



New interior styling with new dashboard, gear-knob and steering wheel, digital instrument cluster, new multimedia and driver assistance systems.



FIAT DUCATO CHASSIS

Proven chassis with the following features:

- Rigid rear axle with longitudinal parabolic leaf springs, & telescopic dampers.
- 16" wheels optional for Light Chassis models.

Citroën Jumper TWIN AXESS

The Citroën Jumper is available on Axess models, offering great performance and technology, including the latest in driving and safety aids. Efficient and powerful 2.2 l HDi engines (Euro 6.3) at 120 HP*, 140 HP and 165 HP.

Features a high-level of standard equipment, with a manual only 6-speed gearbox and the benefits of a large 90 l fuel tank.

CITROËN CHASSIS

The Citroën Jumper chassis on selected Axess models.

- 16" wheels optional for Light Chassis models.



16" Light chassis alloy wheels 16" Heavy chassis alloy wheels

Citroën Jumper vs. Fiat Ducato

DESIGN	Citroën	Fiat
Restyled exterior	no	yes
Restyled interior	no	yes
Cluster type	analog	digital
ENGINES		
standard	120 HDi	120 Multijet 3
2 nd level	140 HDi	140 Multijet 3
3 rd level	165 HDi	160 Multijet 3
4 th level		180 MultiJet 3
WHEELS		
Light chassis	15" (s) / 16" (o)	15" (s) / 16" (o)
Heavy chassis / 9AT gearbox	16" (s)	16" (s)
GEARBOX		
Manual	6-speed	6-speed
Automatic		9-speed

STANDARD EQUIPMENT	Citroën	Fiat
Driver airbag	s	s
Co-driver airbag	s	s
Central locking	s	s
ABS	s	s
ESP	s	s
Manual air condition	s	s
Electrical mirror	s	s
Captain chair	s	s
Cruise control & speed limiter	s	s
Phone / tablet holder	s	s
DAB antenna + 4 speakers	s	s
Stop & start	s	s
Fuel tank	90 l	75 l (s) / 90 l (o)
Phone / tablet holder	s	s
Wheel covers	s	s
Composite leaf springs	-	s*
Tyre pressure sensor	s	o

Some features may not be available on some models. Various packages are available, please see your Adria dealer or go to www.adria-mobil.com for details.

s standard
o optional

*Not on Twin 540

The collection

TWIN SPORTS

PAGE 24



MEET
THE NEW
GENERATION

TWIN SUPREME

PAGE 38



TWIN PLUS

PAGE 42



T W I N A X E S S

PAGE 46



A C T I V E M P C

PAGE 56



TWIN SPORTS

Sports van or family van? Both.



MEET
THE NEW
GENERATION



INSPIRED
DESIGN



SIGNATURE
FEATURES



HOME-STYLE
FEELING



CONTEMPORARY
LIVING SPACES



INSPIRED
SOLUTIONS

TWIN SPORTS

MEET THE NEW GENERATION

Our Twin Sports models will appeal to the more adventurous, thanks to the additional sleeping accommodation, living and storage space. Built on the new Fiat Ducato, with exclusive design pop-top roof and sleeping compartment. Perfect for sporty people with outdoor gear and also for families with children.

Sports van or family van? Both.



600 SPB

640 SG

640 SGX

640 SLB



TWIN SPORTS



Adria MACH smart control mobile app.

Exterior features

Twin Sports campervans with high specifications on the Fiat Ducato.



INSPIRED DESIGN

Inspired design for great style, performance and practicality.



Exterior features

- 1 **NEW FIAT DUCATO.**
- 2 **AUTOMOTIVE STYLE** cabin exterior in choice of exterior colours.
- 3 Adria exclusive design **POP-TOP ROOF** sleeping compartment.
- 4 **EXCLUSIVE DESIGN** roof mechanisms for secure use.
- 5 **FRAMED WINDOWS.**
- 6 Adria exclusive design SunRoof with **PANORAMIC WINDOW.**
- 7 **SOFT-CLOSING DOORS** with integrated mosquito net.
- 8 **INTEGRATED ROOF DESIGN** for optional equipment placement.
- 9 **EXTERNAL SHOWER CONNECTOR.**
- 10 Pre-installation for **REAR-VIEW CAMERA**

POP-TOP ROOF

Aerodynamic integration of lightweight composite pop-top roof. Integrates with SunRoof and optional equipment (air-conditioning, midi-heki, awning).

Design and construction ensures completely secure use, when open or closed.



SIGNATURE FEATURES

Exclusive Adria signature features.

Adria exclusive design SunRoof and 'Cabin-loft' open-plan interior.



Discover 360° walkthroughs, layouts, specification technical data and our product configurator at www.adria-mobil.com



HOME-STYLE FEELING

Stylish, premium open-plan interiors.

Contemporary interior with Onyx furniture style and a choice of textiles. Heating by Truma and Webasto.



Interior features



I. Contemporary interior design with smart lighting system.

II. Adria exclusive design SunRoof with panoramic window.

III. 'Cabin-loft' open plan design.

IV. Pop-top sleeping compartment with lights, USB ports.

V. Adria digital controller and Adria MACH smart mobile app.

VI. Dinette with expandable table and leg for outdoor use.

VII. Heating by Truma and Webasto (640 SGX and 640 SG).





CONTEMPORARY LIVING SPACES

Living spaces with comfort and versatility.



Large flexible dinette and kitchen with 2 burner stove, sink & large compressor fridge.

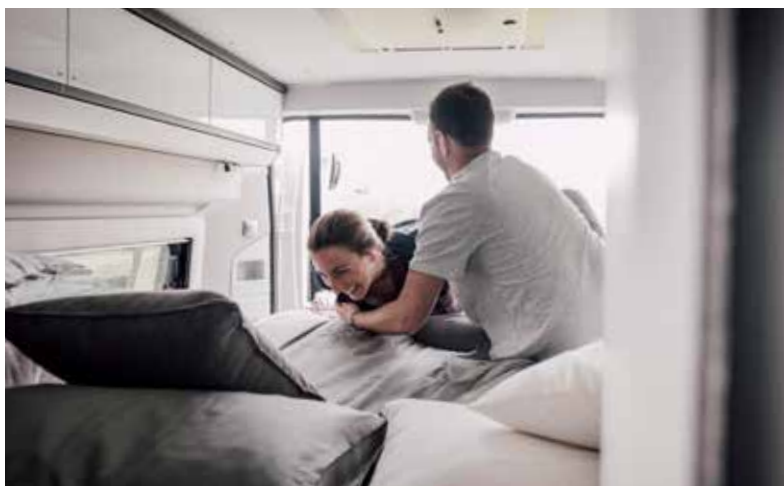

Comfortable rear bedroom with a choice of bed formats.



Duplex bathroom with swivel wall feature.



SLEEPING COMPARTMENT

Removable tent suitable for cleaning, storing and can be recycled. Made in acrylic-based materials, for insulation, water resistance and breathability. Fixed mosquito screens, front screen can be opened independently.

120x200 cm sleeping compartment with comfortable bed, useful storage space, USB ports and reading lights.



INSPIRED SOLUTIONS

Innovative features for inspiring adventures.

POP-TOP ROOF MECHANISMS.



On the longer 640 models an ingenious, easy to use pivot mechanism, with extended side arms, for perfect closure and integration with the van roof when not in use and stability against winds, when in use.



On the shorter 600 models the compact pop-top uses an easy to operate scissor mechanism, with perfect closure.

Both mechanisms feature two separate roof locking mechanisms.



600 SPB

L 5998 (mm) | W 2050 (mm) | 4 4+1*

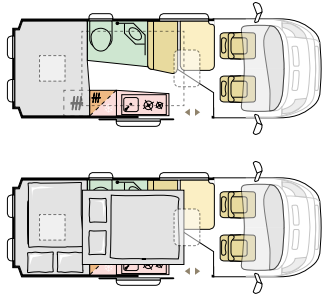

640 SG

L 6363 (mm) | W 2050 (mm) | 4 4+1*

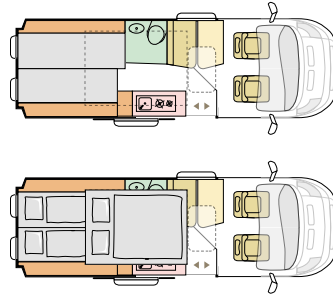

640 SGX

L 6363 (mm) | W 2050 (mm) | 4 4+1*

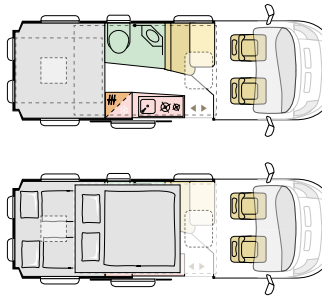

640 SLB

L 6363 (mm) | W 2050 (mm) | 4 4+1+1*

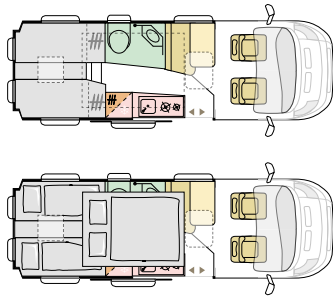

*optional



KEY data

LENGTH
5998 | 6363 mm
WIDTH
2050 mm
HEIGHT
2580 | 2680 mm
WEIGHT
3500 kg
ENGINE
2,2 120 / 140 / 160 / 180 HP



KEY features

- New Fiat Ducato.
 - Adria exclusive design pop-top roof.
 - Large insulated and breathable sleeping compartment.
 - Tent features storage, lights, USB ports, windows & mosquito screens.
 - Integrated with exclusive design SunRoof and roof window.
 - Rear bedroom with single or fixed beds.
 - Rear double bed for 2.
 - Additional bed for 1 converting from dinette.
 - Onyx interior design with glossy white furniture.
 - Dinette in open plan interior, with expandable table.
 - Kitchen, 2 burner stove, sink & large compressor fridge
 - Duplex bathroom with swivel wall feature
 - Large rear garage with dedicated storage.
 - Pre-installation for Adria MACH.
- Key options:**
- MACH and MACH Plus
 - Isofix; Mosquito net; front dinette bed.
 - Electrical sliding door.
 - Awnings, solar panels, air-conditioning.
 - Power Pack.

EXTERIOR finishes

- SILVER ALLUMINIUM METALLIC
- EXPEDITION GREY SOLID
- ARTENSE GREY SOLID
- LANZAROTE GREY SOLID
- IRON GREY METALLIC

POP-TOP color

- DARK GREY

- WHITE

- WHITE

INTERIOR

ONYX



TEXTILE selection

BAXTER (standard)



AUDREY



BERNICE



BLAKE



ARNO



LEATHER VAAST (leather option)



Soft furnishings & decorative cushions

With your choice of textile, you can select any decorative cushion set.

SOPHISTICATED CLASSIC



VIOLET CHIC



OCEAN SERENITY



CHERRY PUNCH



AUTUMN CALMNESS



SPRING GARDEN



Accessories

Ready to go accessory options (applicability may vary by vehicle):

- Awning.
- Roof mounted air-conditioning.
- Power Pack (Solar panel and lithium battery).

Go to www.adria-mobil.com for more information and vehicle availability.

* With your choice of textile you can select any decorative cushion set.

T W I N S

Escape the ordinary.



TWINS

Escape the ordinary in our award-winning Twin campervans. High specifications and really practical, comfortable layouts. Experience innovative features like our exclusive SunRoof and 'cabin-loft' open-plan design.

Escape the ordinary.



- 600 SPB
- 640 SGX
- 640 SLB
- 640 SPB Family

- 540 SP
- 600 SPB
- 600 SPB Family
- 640 SGX
- 640 SLB

- 540 SP
- 600 SP
- 600 SP Family
- 640 SL



TWIN SUPREME



TWIN PLUS



TWIN AXESS



Adria MACH smart control mobile app.

Exterior features

Twin campervans with high specifications on the best base vehicles.



European Innovation Award winner for exterior design.



1 New Fiat Ducato or Citroën Jumper (Axess models).

2 Automotive style cabin exterior in choice of exterior colours.

3 Sporty graphics.

4 Framed windows.

5 Adria exclusive design SunRoof (Supreme models).

6 Soft-closing doors with integrated mosquito net.

7 LED awning light.

8 Insulated and heated waste water tank.

9 Pre-installation for rear-view camera.

10 Electrical power sliding door option.

VIEW ONLINE

Discover 360° walkthroughs, layouts, specification technical data and our product configurator at www.adria-mobil.com

Interior features



I. Contemporary interior design with smart lighting system.

II. Adria exclusive design SunRoof with panoramic window (Supreme).

III. Exclusive 'cabin-loft' open plan design (all models).

IV. New digital controller and Adria MACH smart mobile app (Supreme & Plus models).

V. Dinette with expandable table and leg for outdoor use.

VI. Choice of bathroom solutions.

VII. Heating by Truma, Alde and Webasto (model dependent).



T W I N S U P R E M E





ESCAPE THE ORDINARY IN A TWIN SUPREME.

The European Innovation Award winning campervan, with signature features like the Adria exclusive design SunRoof with panoramic window, soft-close doors and optimised insulation. Contemporary interior, 'cabin-loft' open design, packed with features.

T W I N S U P R E M E





TWIN PLUS





ESCAPE THE ORDINARY IN A TWIN PLUS.

Well-specified campervan with contemporary interior, 'cabin-loft' open plan design, packed with features.









ESCAPE THE ORDINARY IN A TWIN AXESS.

Offering great value, a choice of base vehicle, with contemporary interiors and great features.



T W I N A X E S S





Axess, Plus or Supreme?

All the new generation models are packed with features and offer high specifications. To help you decide, we have summarized the key differences between Supreme, Plus and Axess models.

TWIN AXESS



KEY FEATURES	AXESS	PLUS	SUPREME
New FIAT Ducato (Euro 6.d Final)	✓	✓	✓
Citroën Jumper	✓		
Body color	3 exterior colors	8 exterior colors	8 exterior colors
Cabin exterior color	White	White / Silver / Dark grey	Silver
5,4 m layouts	✓	✓	
6 m layouts	✓	✓	✓
6,4 m layouts	✓	✓	✓
Compressor fridges	✓	✓	✓
U shaped cupboards		✓	✓
Full insulation		✓	✓
SunRoof			✓
Framed windows		✓	✓
Adria digital control panel	✓	✓	✓
Furniture style	Sandy Brown	Sandy White / Sandy Brown	Onyx
Heating*	Truma / Webasto	Truma / Webasto	Truma / Alde / Webasto
Duplex bathroom		✓	✓
Aluminum hard floor in garage*		✓	✓



SANDY BROWN

*depends from model

TWIN PLUS

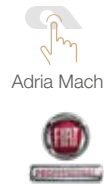

TWIN SUPREME

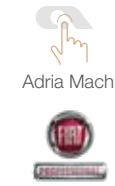

TWIN S LAYOUTS

TWIN supreme

600 SPB
L 5998 (mm) | ☀️ 🌙
W 2050 (mm) | 4 2+1*

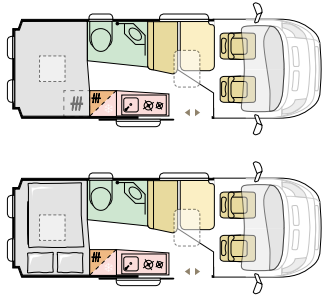

640 SGX
L 6363 (mm) | ☀️ 🌙
W 2050 (mm) | 4 2+1*

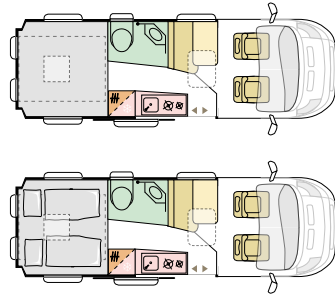

640 SLB
L 6363 (mm) | ☀️ 🌙
W 2050 (mm) | 4 2+1+1*

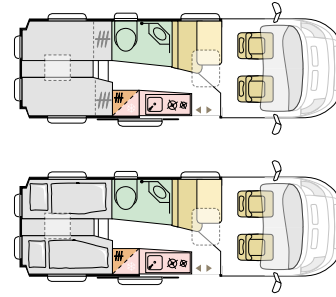

640 SPB FAMILY ☀️ 🌙
L 6363 (mm) |
W 2050 (mm) | 4 4+1*

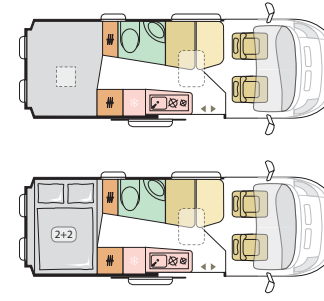

TWIN plus

540 SP
L 5413 (mm) | ☀️ 🌙
W 2050 (mm) | 4 2

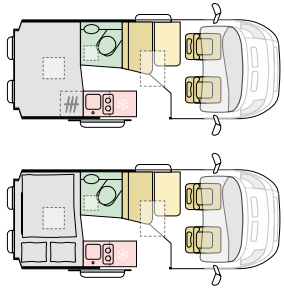

600 SPB
L 5998 (mm) | ☀️ 🌙
W 2050 (mm) | 4 2+1*

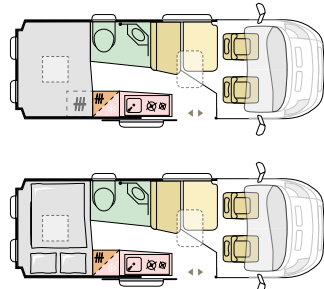

600 SPB FAMILY ☀️ 🌙
L 5998 (mm) |
W 2050 (mm) | 4 4+1*

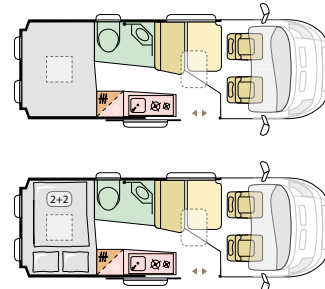

640 SGX
L 6363 (mm) | ☀️ 🌙
W 2050 (mm) | 4 2+1*

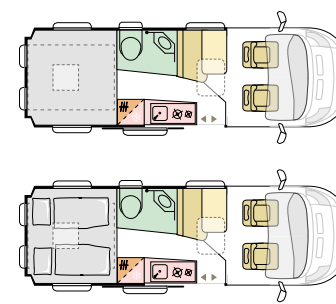

640 SLB
L 6363 (mm) | ☀️ 🌙
W 2050 (mm) | 4 2+1+1*

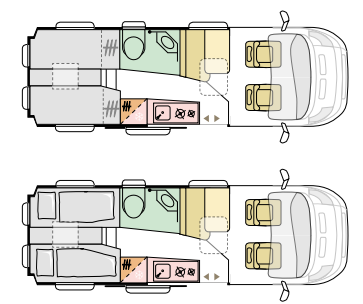

TWIN axess

540 SP
L 5413 (mm) | ☀️ 🌙
W 2050 (mm) | 4 2

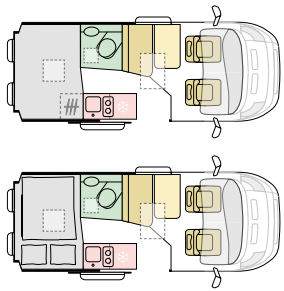

600 SP
L 5998 (mm) | ☀️ 🌙
W 2050 (mm) | 4 2+1*

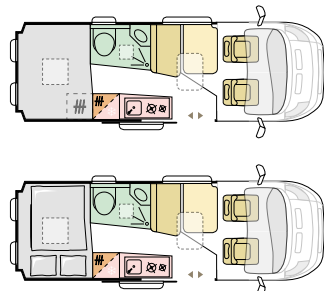

600 SP FAMILY ☀️ 🌙
L 5998 (mm) |
W 2050 (mm) | 4 4+1*

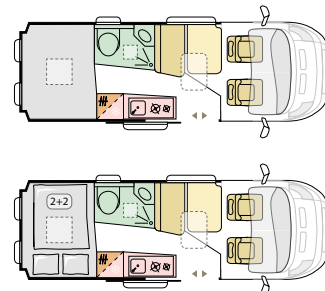

640 SL
L 6363 (mm) | ☀️ 🌙
W 2050 (mm) | 4 2+1*

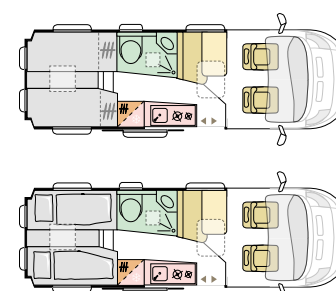

*optional



KEY data

LENGTH

5998 - 6363 mm

WIDTH

2050 mm

HEIGHT

2580 mm

WEIGHT

3500 kg

FIAT 6D ENGINE

2,2 120 / 140 / 160 / 180 HP*



KEY features

- Exclusive design SunRoof and panorama.
- Cabin-loft open plan design and lighting.
- Duplex bathroom solution, with swivelling wall.
- Dinette with extendable table.
- Rear bedroom with single or fixed beds.
- Adria digital controller for key utilities.
- Easy to use digital controller.
- 90 l or 152 l compressor fridge, sink & 2 burner stove.
- Dinette table, use outside with extendable leg.

- Heating by Alde, Truma and Webasto (model dependent).
- Pre-installation for Adria MACH.

Key options:

- MACH and MACH Plus.
- Isofix; Mosquito net; front dinette bed.
- Electrical sliding door.
- See Factory-fit options.

LENGTH

5413 - 6363 mm

WIDTH

2050 mm

HEIGHT

2580 mm

WEIGHT

3300 - 3500 kg

FIAT 6D ENGINE

2,2 120 / 140 / 160 / 180 HP*



- 'Cabin-loft' open plan design and lighting.
- Large roof window 700 x 500 mm (not 540 SP).
- Dinette with extendable table.
- Rear bedroom with single, double or fixed beds.
- Easy to use digital controller.
- 90 l, 115 l or 152 l compressor fridge, sink & 2 burner stove.
- Dinette table, use outside with extendable leg.
- New digital controller and Adria MACH smart app.

- Adria digital controller for key utilities.
- Truma heater located in dinette (model dependent).
- Pre-installation for Adria MACH.

Key options:

- MACH and MACH Plus
- Isofix; Mosquito net; front dinette bed.
- Electrical sliding door.
- See Factory-fit options.

LENGTH

5413 - 6363 mm

WIDTH

2050 mm

HEIGHT

2580 mm

WEIGHT

3300 - 3500 kg

FIAT 6D ENGINE

2,2 120 / 140 / 160 / 180 HP

CITROËN 6D ENGINE

2,2 120 / 140 / 165 HP*



- 'Cabin-loft' open plan design and lighting.
- Large roof window 700 x 500 mm.
- Dinette with extendable table.
- Rear bedroom with single, double or fixed beds.
- Easy to use digital controller.
- Adria digital controller for key utilities.
- 90 l compressor fridge, sink & 2 burner stove.
- Dinette table, use outside with extendable leg.

- Compact bathroom solution with fixed shower.
- Truma heater located in dinette (model dependent).

Key options:





- Isofix; Mosquito net; front dinette bed.
- Electrical sliding door.
- See Factory-fit options.

* optional, depends on the model

TWIN supreme



EXTERIOR finishes

-  WHITE
-  BLACK METALLIC
-  SILVER ALLUMINIUM METALLIC
-  LANZAROTE GREY
-  EXPEDITION GREY
-  ARTENSE GREY
-  IRON GREY METALLIC
-  BATIC ORANGE METALLIC









INTERIOR

ONYX



TWIN plus





-  WHITE
-  BLACK METALLIC
-  SILVER ALLUMINIUM METALLIC
-  LANZAROTE GREY
-  EXPEDITION GREY
-  ARTENSE GREY
-  IRON GREY METALLIC
-  BATIC ORANGE METALLIC

SANDY WHITE/SANDY BROWN



TWIN axess



-  WHITE
-  SILVER METALLIC
-  BLACK METALLIC

SANDY BROWN



TEXTILE selection

BAXTER (standard)



AUDREY



BERNICE



BLAKE



ARNO



LEATHER VAAST (leather option)



**Soft furnishings
& decorative cushions**

With your choice of textile, you can select any decorative cushion set.

SOPHISTICATED
CLASSIC



VIOLET
CHIC



AUTUMN
CALMNESS



OCEAN
SERENITY



CHERRY
PUNCH



SPRING
GARDEN



Accessories

Ready to go accessory options (applicability may vary by vehicle):

- Awning.
- Roof-mounted air-conditioning.
- Power Pack (Solar panel and lithium battery).

*With your choice of textile, you can select any cushion set.

MULTI-PURPOSE CAMPER

Play. Stay. Everyday.



ACTIVE

With the Active Multi-Purpose Camper, you can really Play, Stay, Everyday.
 It's great for playing, for those with a passion for outdoor sports. Just get and go, stay away from home.
 Everyday commuting, school run, shopping trip, evening out? No problem.
 Choose **Active Base** a perfect everyday vehicle suitable for overnight stays or the **Active Pro**,
 fully equipped, with kitchen and both with pop-up sleeping compartment.



BASE

PRO



ACTIVE STANDARD EXTERIOR BASE



ACTIVE STANDARD EXTERIOR PRO

Play. Stay. Everyday.

The joy of this kind of vehicle is in its compact, agile and multi-purpose character.



Make Active your own basecamp for outdoor living and sports!

Park it up, open it up and go play. There's plenty of space and storage for all your outdoor gear and a living space to open up and connect with nature.

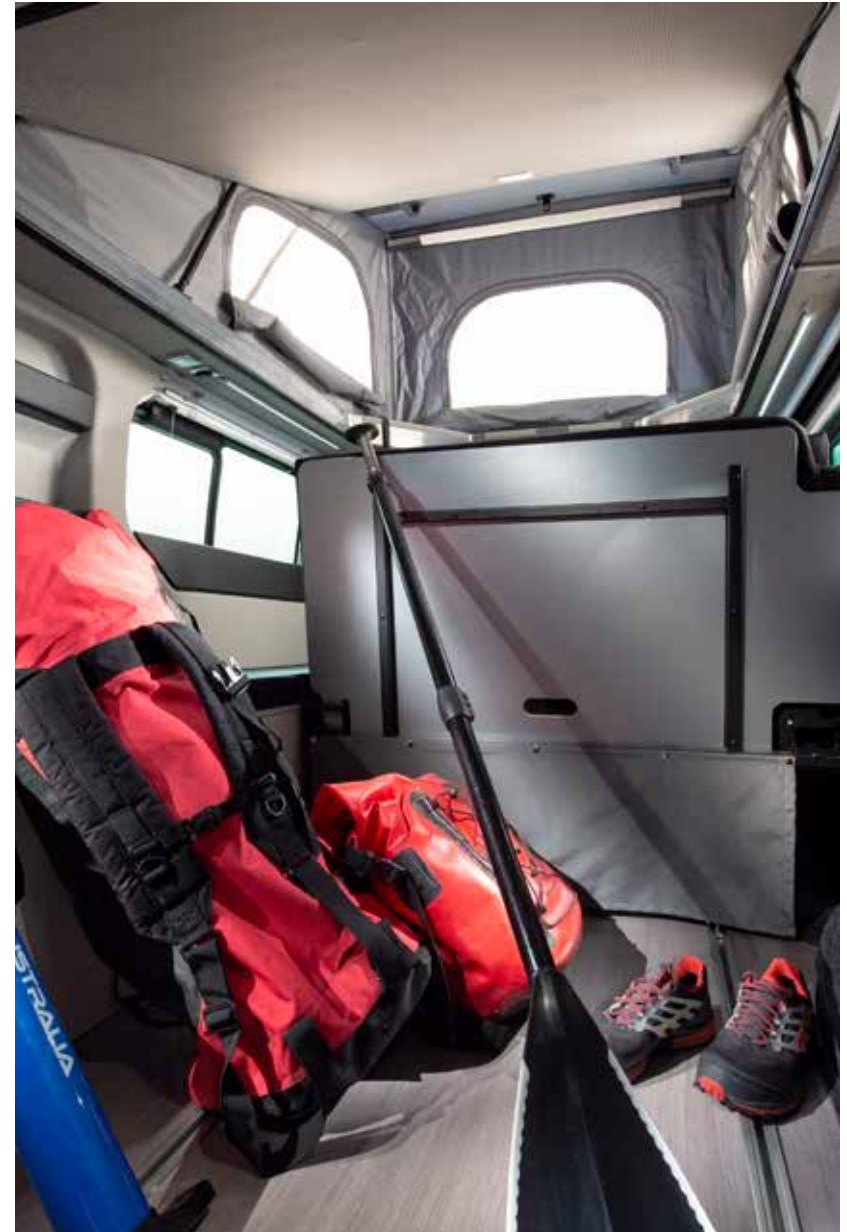



STAY

Stay in the Active with easy to set up overnight accommodation!

Comfortable accommodation for up-to five people, with a bedroom converted in the living space and also in the pop-top roof compartment.



EVERYDAY

Use the Active every day! It's a brilliant main or second household car as it's a pleasure to drive and it's so capacious and practical, much more than most regular cars.

Homologated seats for six passengers, including a large moveable bench.

So much practical storage space, great for holidays of course, also pretty useful for those shopping trips and other every-day use.

Exterior features

The Active is a converted Renault Trafic, with choice of the latest Euro 6.d 2,0l Renault engines and driver aids, with a choice of alloy wheels.



1 Accommodation for up-to 4 people (Pro) and 5 people (Base).

2 Renault Euro6.d 2,0l engine, selection of driver aids.

3 Agile, length 4,99m and height 2,035m (optional under 2m).

4 Automotive styling, with new graphics, full LED headlights.

5 Pop-up roof with integrated sleeping compartment.

6 Privacy style windows.

7 Optional awning and black pop-up roof with rails (on white Active).

VIEW
ONLINE

Discover 360° walkthroughs, layouts, specification technical data and our product configurator at www.adria-mobil.com

Interior features

ACTIVE BASE



I. Interior design in white décor.

II. Swivel front seats, 5 or optional 6 homologated seats.

III. Movable and folding bench seat and optional single seat.

IV. Luggage box, space for portable fridge & battery.

V. External inlet for 230v and internal USB ports.

VI. Space for 1 x 100 Ah battery.

VII. Webasto heating (option).



ACTIVE PRO



I. Interior with glossy white scratch resistant furniture.

II. Swivel front seats, 5 or optional 6 homologated seats.

III. Movable, folding bench seat & optional single seat.

IV. Kitchen with table, 2 burner stove, sink and 36l fridge.

V. Optimized wardrobe and storage space.

VI. Space for 2 x 100 Ah batteries.

VII. Webasto heating (option).



A C T I V E



The MPC is a truly multi-purpose vehicle and quickly transforms from an everyday driver to a campervan. The living space is efficiently designed with everything in the right place and with the pop-up sleeping compartment open, the extra headroom is invaluable.



ACTIVE LAYOUTS

BASE

L 4990 (mm) | 5 5
W 1970 (mm)



ACTIVE Base

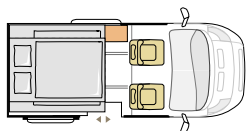
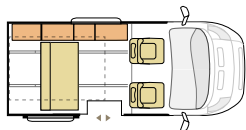

PRO

L 4990 (mm) | 5 4
W 1970 (mm)



ACTIVE Pro

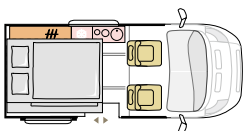
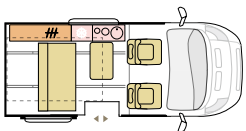

KEY DATA	ACTIVE Base	ACTIVE Pro
Length	4999 mm	4999 mm
Width	1960 mm	1960 mm
Height	2035 1999 mm	2035 1999 mm
Weight	2000 kg	2000 kg
Engine	2.0 110 / 130 / 150 / 170 HP	2.0 110 / 130 / 150 / 170 HP
KEY FEATURES		
Automotive styling, sporty graphics & LED headlights.	✓	✓
Pop-up roof with integrated sleeping compartment.	✓	✓
Interior design with white décor.	✓	
Interior with glossy white scratch resistant furniture		✓
Swivel front seats, 5 or optional 6 homologated seats	✓	✓
Movable and folding bench seat & optional single seat.	✓	✓
Kitchen with table, 2 burner stove, sink and 36 l fridge.		✓
Induction plate (230 V)	✓	
Swivel front seats	✓	
Luggage box with space for portable fridge & battery	✓	
Optimized wardrobe and storage space.		✓
External inlet for 230 v and internal USB ports	✓	✓
Connection for outdoor shower.		✓
Space for 1 x 100 Ah battery	✓	✓
Space for 2 x 100 Ah batteries.		✓
Heating*	Webasto heating (option)	Webasto heating (option)

L = LENGTH W = WIDTH ☀ NUMBER OF SEATS 🌙 NUMBER OF BERTHS 🍳 KITCHEN 🗺 TABLE 🪑 SEATING AREA 🚪 WARDROBE 🛏 BERTHS 🚿 BATHROOM 🏠 FLOOR

Renault trafic



Designed and engineered to integrate with the base vehicle, making driving a pleasure, with powerful new Euro 6 engine choice and contemporary cabin design. Latest generation diesel engines for power and performance, in three variants.

EURO 6.d Final

2.0 l / 110 HP
2.0 l / 130 HP
2.0 l / 150 HP
2.0 l / 170 HP

- Manual or automatic gearbox.
- Advanced multimedia and driver information.
- Range of driver aids available.
- Style Packs available (bumpers, mirrors, plastic trim).
- Choice of 16" and 17" alloy wheel designs.
- Optional rear-view reversing camera.





World-class partners

**ADRIA RECREATIONAL VEHICLES
ARE THE CHOICE OF CHAMPIONS.**



TINA MAZE

Double World Champion and double Olympic gold medalist. One of the best skiers of all time, Tina Maze, from Slovenia, regularly uses her Twin campervan to follow the snow for skiing and wind, for windsurfing.

ADRIA MOBIL CYCLING TEAM

The Adria-Mobil Cycling Team are the top Slovenian cycling team in the UCI European Tour. For more information visit www.adria-mobil-cycling.com



PRIMOŽ ROGLIČ

2020 Olympic Gold Medal Winner, Men's Road Cycling Individual Time Trial. The world's top cyclist and winner of the Velo d'Or in 2020. Twice winner of La Vuelta in 2019-20, second in the 2020 Tour de France and winner in Liege. Primož, from Slovenia, uses his Sonic to support his training, competing and for holidays.



JAKOV FAK

World-class biathlete representing Slovenia, top three ranked. Silver medal biathlon winner at the 2018 Winter Olympics and Bronze in Vancouver in 2010. Jakov uses his Sonic to support his training, competing and for holidays.



KTM FACTORY RACING TEAM

Every January since 2013, a fleet of Adria motorhomes are taken on the Dakar Rally by Red Bull KTM Factory Racing. Custom-designed Adria Twins also support KTM's team in the MXGP World Championship.



SOCIAL MEDIA

Join the Adria family on Facebook, Instagram, YouTube and Pinterest to share your adventures.



DISCOVER MORE IN THE NEW EDITION OF INSPIRATIONS MAGAZINE, ONLINE AT adria-mobil.com/inspirations



ADRIA MOBIL, d.o.o.
Straška cesta 50
8000 Novo mesto
Slovenia
Tel. +386(0)7 393 71 00
Fax: +386(0)7 393 72 00
Email: info@adria-mobil.si
Website: www.adria-mobil.com

**I FEEL
SLOVENIA**

Slovenia
Your caravanning destination
www.slovenia.info



The purpose of the catalogue is illustrative. Pictures inside the catalogue may include some elements not belonging to standard equipment or portray products belonging to different markets. Products may change from technical or commercial points of view in respect of regulations. Please contact your selected Dealer to obtain detailed information before purchasing.

Published by: Adria Mobil, d.o.o.; Art Direction: Pubblimarket2; Production: Enigma d.o.o.; Photography: Branko Čeak, Jože Maček, Jure Horvat, Styling: Nataša Mandelj Čeak; Cover photo: Branko Čeak, Jože Maček, Jure Horvat; Lifestyle photos: Francesco Zanet, Simone Benedetti, Daniele Molineris, Luca Masarà, Shutterstock, iStock, themediumgray.com; Styling: Pubblimarket2, Claudia Barberi. KTM Images: Rally Zone; Photo Adria Mobil Cycling: Vid Ponikvar|Sportida; Primož Roglič|Cor Vos, Tour de Tietema; Renders: Inpac d.o.o.; Copy: Neil Morley; Lythography: Tomo Per; Thanks to: Müller, Amfibija, My Dream Journey; Printed by: Printera Grupa d.o.o.

Printed and published: August 2021