

Camry Fuel Lid Door Lever Inoperative

Service Category

Section Door/Hatch

Market USA

Toyota Supports
 ASE Certification 

Applicability

YEAR(S)	MODEL(S)	ADDITIONAL INFORMATION
2007 - 2014	Camry, Camry HV	WMI(s): 4T1, 4T4 Plant Code(s): R, U

Introduction

Some 2007 – 2014 model year North American produced Camry and Camry HV vehicles may exhibit a condition where the fuel lid door will not open when pulling up on the fuel lid lock lever. Follow the Repair Procedure in this bulletin to address this condition.

Warranty Information

OP CODE	DESCRIPTION	TIME	OFF	T1	T2
BD1607	R & R Fuel Lid Lever Sub-Assy	0.5	64606-06020	9A	12
BD1608	R & R Fuel Lid Lever Sub-Assy and Cable Sub-Assy	1.5	77035-06180	9A	13

APPLICABLE WARRANTY

- This repair is covered under the Toyota Basic Warranty. This warranty is in effect for 36 months or 36,000 miles, whichever occurs first, from the vehicle's in-service date.
- Warranty application is limited to occurrence of the specified condition described in this bulletin.

Camry Fuel Lid Door Lever Inoperative

Parts Information

PART NUMBER	PART NAME	QTY
64606-06020	Lever Sub-Assy, Fuel Lid Lock Open	1
90159-A0053*	Screw, w/Washer Tapping	1*
77035-06180**	Cable Sub-Assy, Fuel	1**
77377-75010**	Retainer, Fuel Filler Opening Lid Lock	1**
82711-33500**	Clamp, Wiring Harness	1**
64648-12020**	Grommet, Luggage Door Lock Opener	1**

*Replace only if original screw is damaged.

**ONLY needed if cable replacement is necessary.

Repair Procedure

1. Confirm operation of the interior fuel door release lever. If lever is inoperative and it does NOT feel as if there is any tension on the lever when operating, then follow the steps outlined below to diagnose the repair. If tension can be felt when pulling the fuel door release lever, then this bulletin does NOT apply.
2. Confirm fuel door release lever housing is secured properly to the vehicle.
Is the fuel door release lever housing secured properly to the vehicle?
 - **YES** — Continue to step 3.
 - **NO** — This bulletin does NOT apply. Continue diagnosis using the applicable Repair Manual.
3. Disassemble the housing from the vehicle for inspection. There is one 10mm bolt and a tab holding the mechanism in place.

Figure 1.

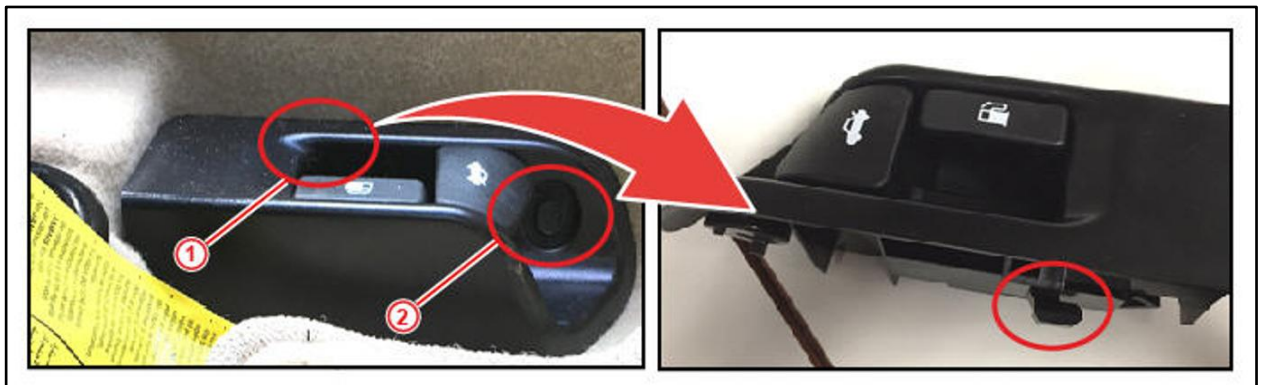

1 Body Tab

2 10 mm Bolt

Camry Fuel Lid Door Lever Inoperative

Repair Procedure (Continued)

4. During disassembly confirm if the fuel door release cable is loose or disengaged from the fuel door release lever housing. You can remove the luggage door and fuel lid lock cables for inspection.
5. If the cable is loose or disengaged from the housing, inspect the housing for damage. Confirm if the mounting tabs that retain the cable are broken or damaged.

Figure 2.

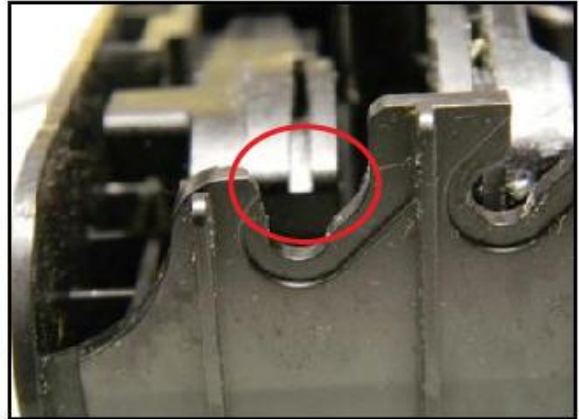

6. If the housing is damaged, replace the fuel lid release lever housing assembly and continue to step 7. If the housing is NOT damaged, do NOT continue to the next step, this bulletin does NOT apply to the vehicle being repaired.
7. Prior to reassembling, inspect the fuel door release cable for damage. If cable appears to be in good condition, then the cable assembly does NOT need to be replaced. If the cable is damaged, replace the cable assembly.

Figure 3.

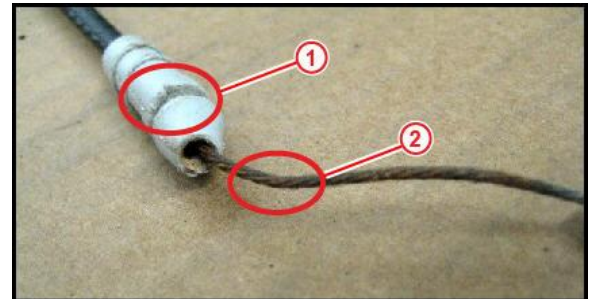

HINT

Figure 3 provides an example of a damaged cable. The cable is kinked and the retaining slot that attaches to the release lever housing is also damaged.

1	Damage to Retaining Slot
2	Kink in Cable

8. Disconnect the cable from the negative (–) battery terminal.
9. Remove the front seat assembly LH.
10. Remove the rear seat cushion assembly.
11. Remove the rear seat cushion lock hook (lock hooks MUST NOT be reused).
12. Remove the rear side seatback assembly LH.
13. Remove the front door scuff plate LH.

Camry Fuel Lid Door Lever Inoperative

Repair Procedure (Continued)

14. Disconnect the front door opening trim weatherstrip.
15. Remove the rear door scuff plate LH.
16. Disconnect the rear door opening trim weatherstrip LH.
17. Remove the lap belt outer anchor cover.
18. Disconnect the front seat outer belt assembly LH.
19. Remove the center pillar lower garnish LH.
20. Remove the luggage compartment door cover.
21. Remove the luggage compartment door hinge cover LH.
22. Remove the spare wheel cover assembly.
23. Remove the rear floor finish plate.
24. Remove the luggage compartment front trim cover (HV ONLY).
25. Remove the No. 1 luggage compartment trim hook.
26. Remove the luggage compartment inner trim cover LH.
27. Remove the fuel lid lock open lever sub-assembly.
28. Remove the fuel lid lock control cable sub-assembly.
 - A. Disengage the 2 clamps.

Figure 4.

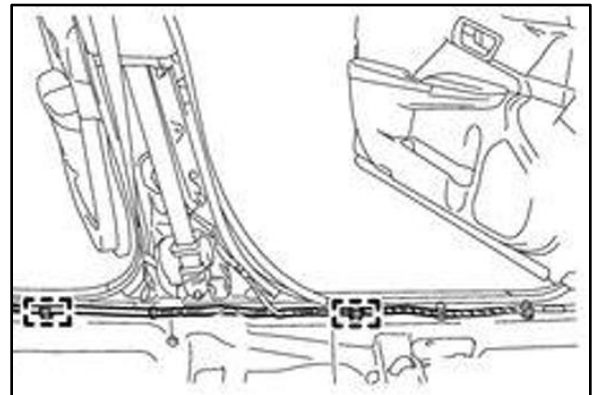

- B. Using a clip remover, disengage the clamp and disconnect the wire harness.

Figure 5.

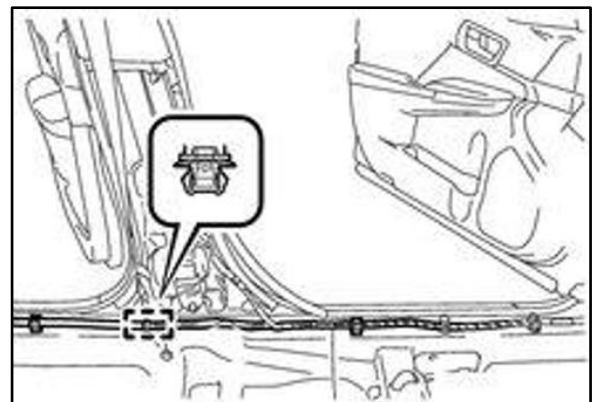

Camry Fuel Lid Door Lever Inoperative

Repair Procedure (Continued)

- C. Using a clip remover, disengage the 2 clamps and remove the 2 scuff plate clips.

Figure 6.

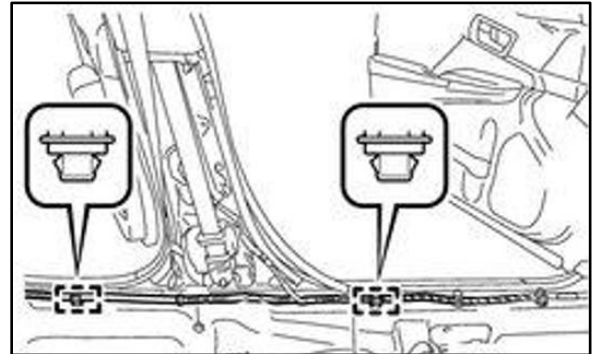

- D. Turn back the floor carpet so that the luggage door lock control cable sub-assembly and fuel lid lock control cable sub-assembly can be removed.
- E. Disengage the guide as shown in the illustration.

Figure 7.

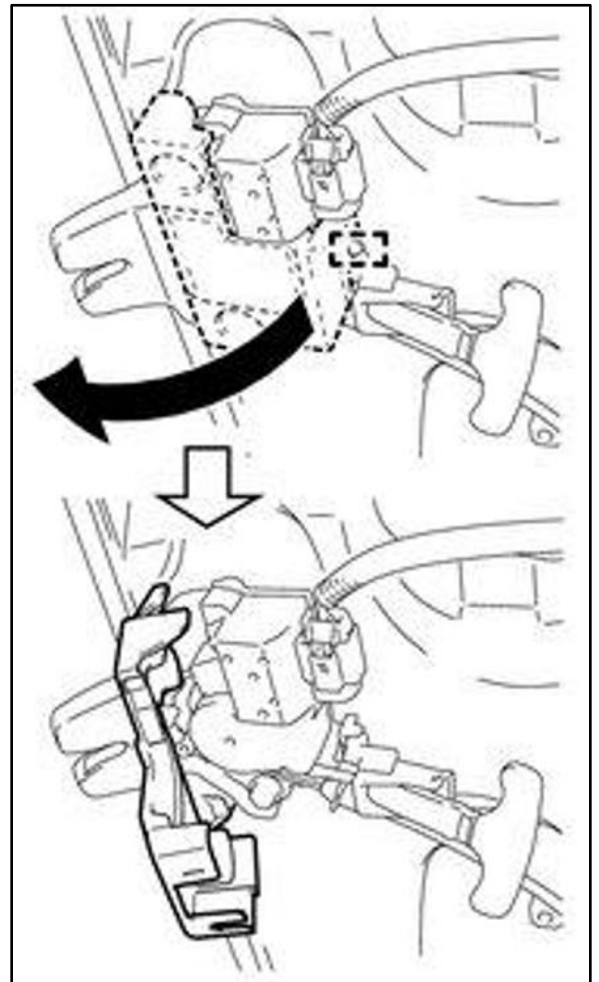

Camry Fuel Lid Door Lever Inoperative

Repair Procedure (Continued)

- F. Disconnect the luggage door lock control cable sub-assembly.

Figure 8.

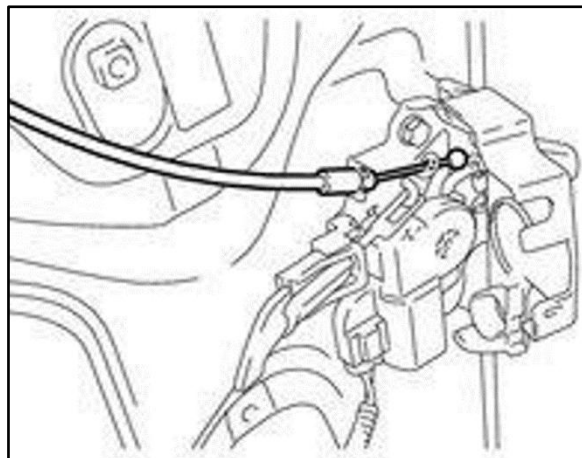

- G. Disengage the clamp and disconnect the luggage door lock control cable sub-assembly.

Figure 9.

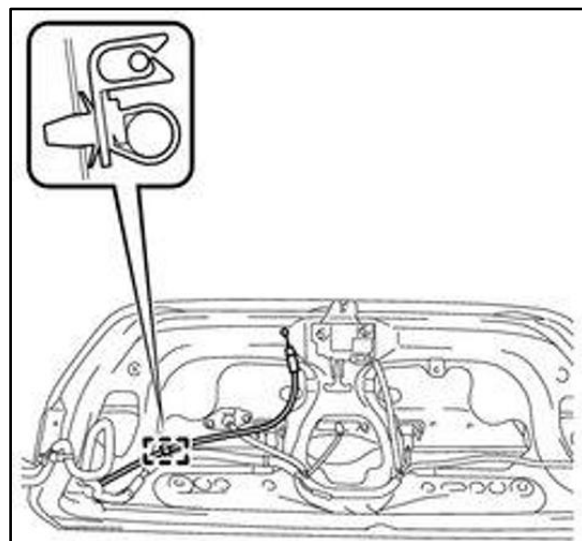

Camry Fuel Lid Door Lever Inoperative

Repair Procedure (Continued)

- H. Rotate the fuel filler opening lid lock retainer to align the cutouts and the guides, and then pull the fuel filler opening lid lock retainer.

Figure 10.

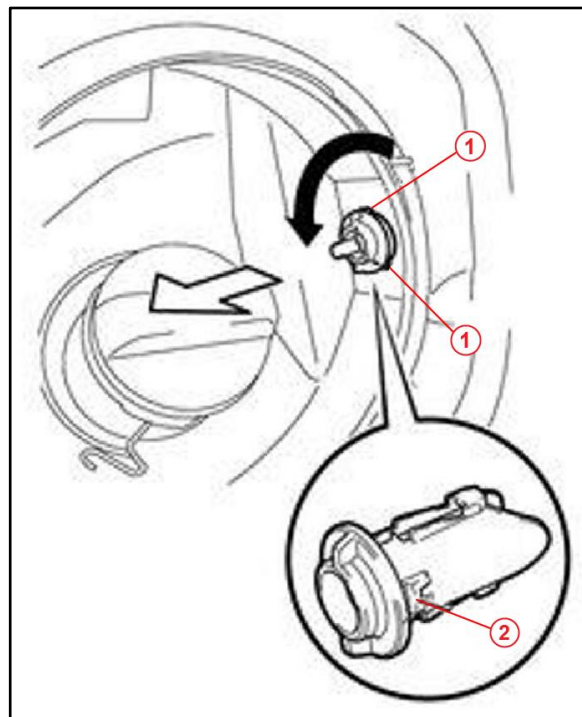

1	Cutout
2	Guide

Camry Fuel Lid Door Lever Inoperative

Repair Procedure (Continued)

- I. Rotate the fuel filler opening lid lock retainer to align the cutouts and guides, and then pull the fuel filler opening lid lock retainer.

Figure 11.

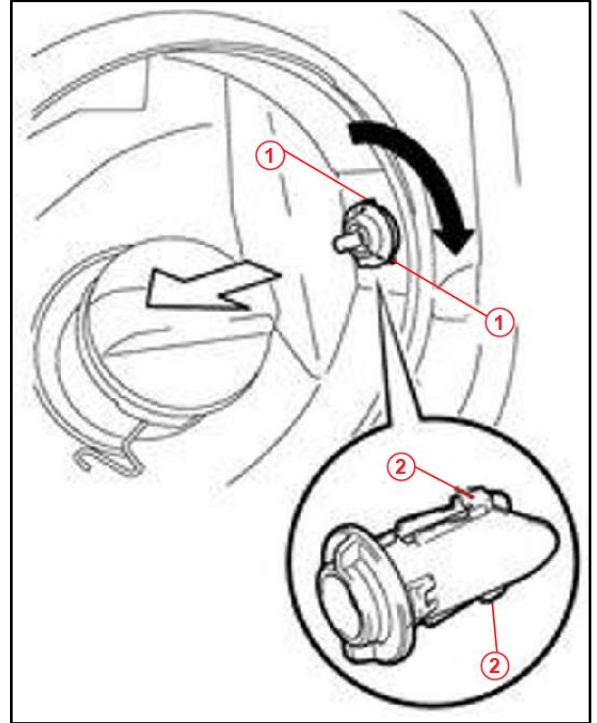

1	Cutout
2	Guide

Camry Fuel Lid Door Lever Inoperative

Repair Procedure (Continued)

- J. Pull out the fuel filler opening lid lock retainer with both guides aligned with the cutouts.

Figure 12.

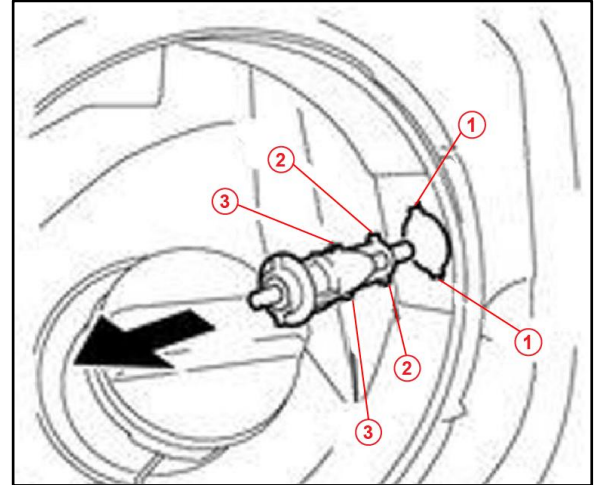

1	Cutout
2	Guide
3	Fuel Filler Opening Lid Lock Retainer

- K. Disengage the 2 claws and remove the fuel filler opening lid lock retainer.

Figure 13.

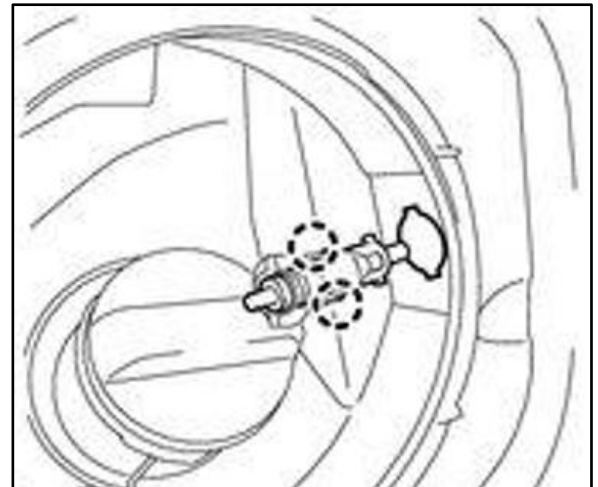

Camry Fuel Lid Door Lever Inoperative

Repair Procedure (Continued)

- L. Disengage the 10 clamps and remove the fuel lid lock control cable sub-assembly and luggage door lock control cable sub-assembly.

Figure 14.

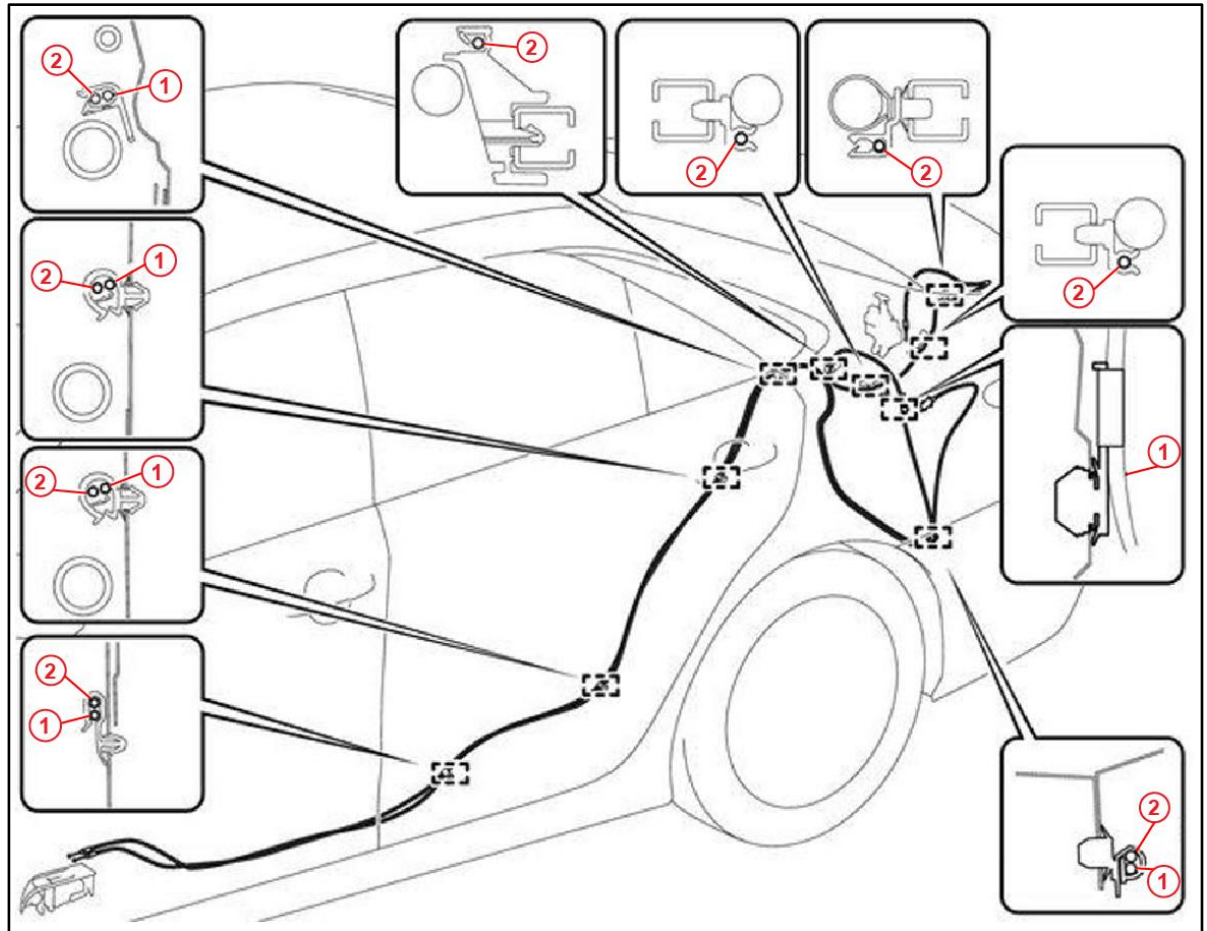

1	Fuel Lid Lock Control Cable Sub-Assembly
----------	---

2	Luggage Door Lock Control Cable Sub-Assembly
----------	---

Camry Fuel Lid Door Lever Inoperative

Repair Procedure (Continued)

M. Using a knife, cut off the clamp as shown in the illustration.

Figure 15.

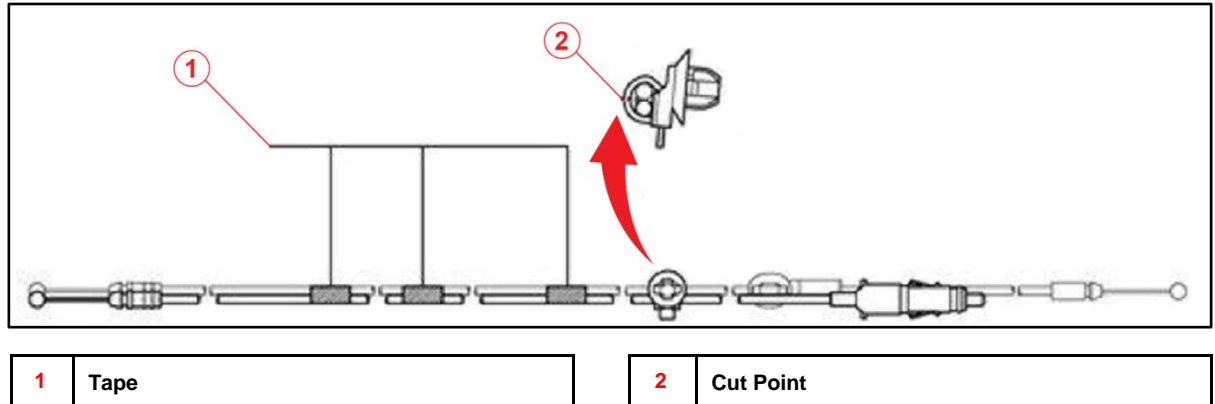

NOTICE

Be careful not to damage the vehicle fuel lid lock control cable sub-assembly and luggage door lock control cable sub-assembly.

N. Remove the clamp from the body.

O. Remove the 3 pieces of tape and fuel lid lock control cable sub-assembly.

Camry Fuel Lid Door Lever Inoperative

Installation

1. Install the fuel lid lock control cable sub-assembly to the luggage door lock control cable sub-assembly with the NEW clamp and the 3 pieces of tape as shown in the illustration.

Figure 16.

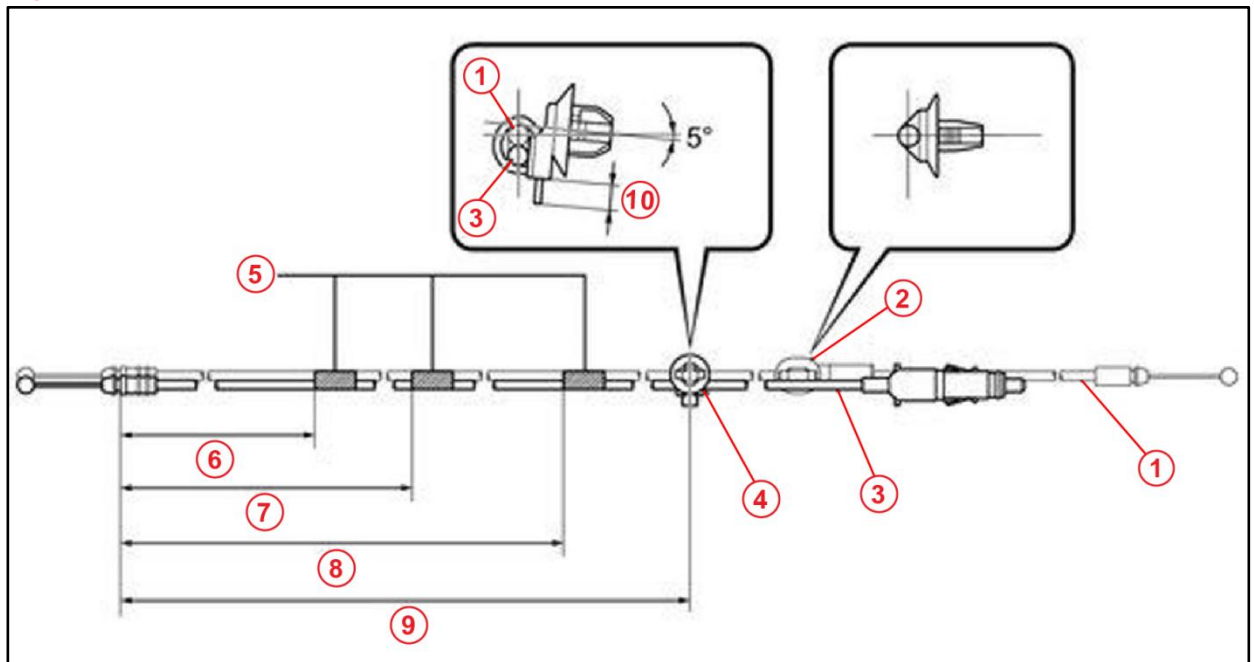

1	Luggage Door Lock Control Cable Sub-assembly
2	Luggage Cable Clamp
3	Fuel Lid Lock Control Cable Sub-assembly
4	Clamp
5	Tape

6	295 to 305 mm (11.6 to 12.0 in.)
7	880 to 900 mm (2.29 to 2.95 ft.)
8	2090 to 2110 mm (6.86 to 6.92 ft.)
9	2970 to 2990 mm (8.86 to 9.81 ft.)
10	5.0 mm (0.197 in.) or Less

NOTICE

- Wrap tape around the designated position 1 to 3 times.
- Make sure that the fuel lid lock control cable sub-assembly and luggage door lock control cable sub-assembly are not kinked.

- A. Install the fuel lid lock control cable sub-assembly and luggage door lock control cable sub-assembly by engaging the 10 clamps.

Camry Fuel Lid Door Lever Inoperative

Installation (Continued)

- B. Align the cutouts and guides, and then insert the fuel filler opening lid lock retainer.

Figure 17.

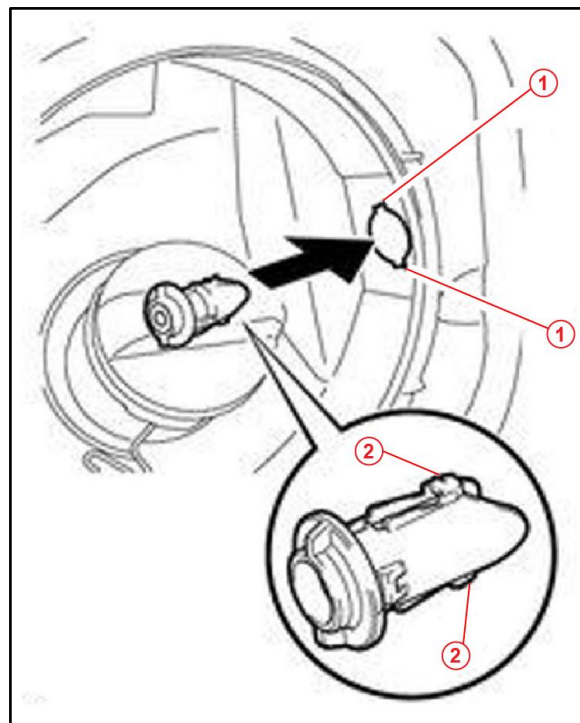

1	Cutout
2	Guide

Camry Fuel Lid Door Lever Inoperative

Installation (Continued)

- C. Engage the 2 claws and install the fuel filler opening lid lock retainer.
- D. Engage the 2 claws and install the fuel lid lock control cable sub-assembly.

Figure 18.

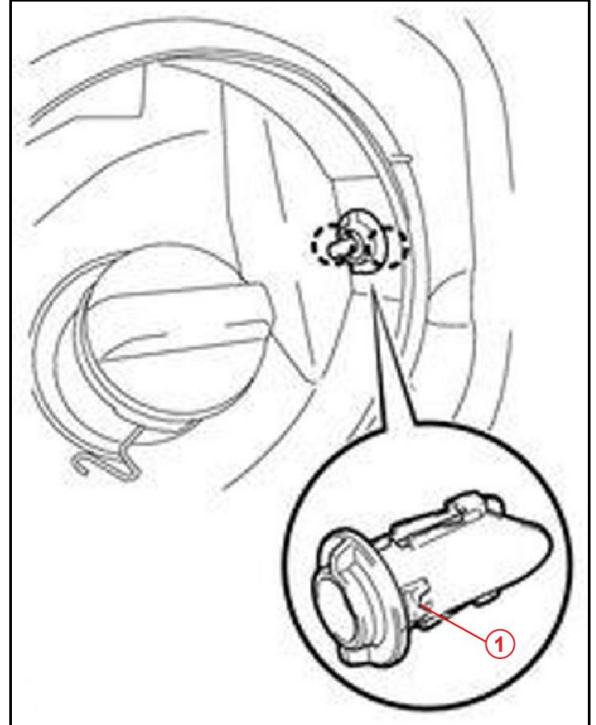

1	Claw (2)
----------	-----------------

- E. Engage the clamp and connect the luggage door lock control cable sub-assembly.
- F. Connect the luggage door lock control cable sub-assembly.

Figure 19.

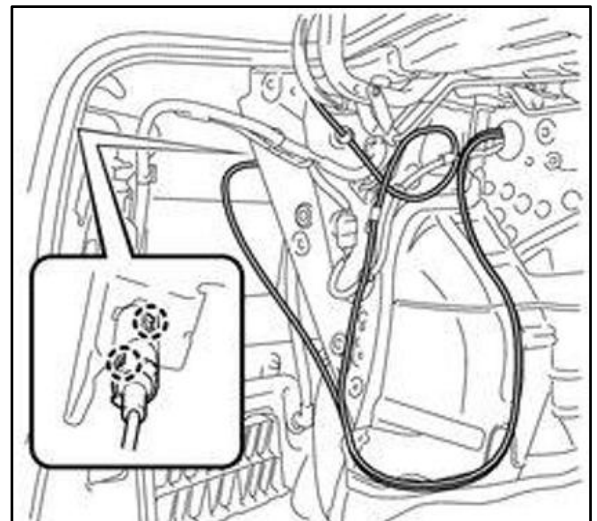

Camry Fuel Lid Door Lever Inoperative

Installation (Continued)

- G. Engage the guide as shown in the illustration.

Figure 20.

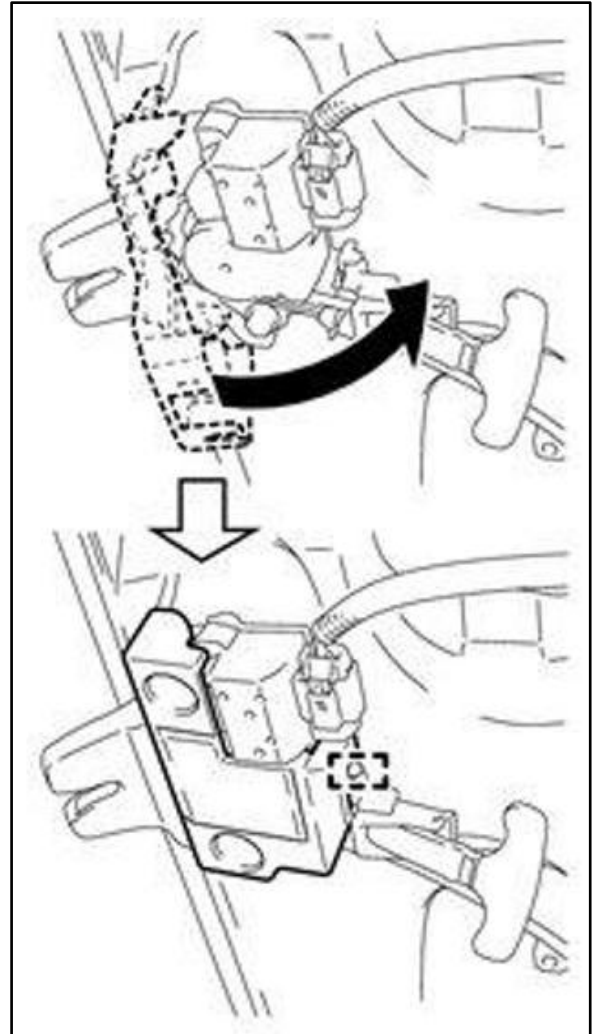

- H. Return the floor carpet to the original position.
 - I. Engage the 2 clamps and install the 2 scuff plate clips.
 - J. Engage the 3 clamps to connect the wire harness.
2. Install NEW fuel lid lock open lever sub-assembly.
 3. Install luggage compartment inner trim cover LH.
 4. Install No. 1 luggage compartment trim hook.
 5. Install luggage compartment front trim cover (HV ONLY).
 6. Install rear floor finish plate.
 7. Install spare wheel cover assembly.
 8. Install luggage compartment door hinge cover LH.
 9. Install luggage compartment door cover.

Camry Fuel Lid Door Lever Inoperative

Installation (Continued)

10. Install rear side seatback assembly LH.
11. Install center pillar lower garnish LH.
12. Connect front seat outer belt assembly LH.
13. Install lap belt outer anchor cover.
14. Install rear door opening trim weatherstrip LH.
15. Install rear door scuff plate LH.
16. Install front door opening trim weatherstrip LH.
17. Install front foot scuff plate LH.
18. Install rear seat cushion lock hook (NEW lock hooks MUST be used).
19. Install rear seat cushion assembly.
20. Install front seat assembly LH.
21. Connect cable to negative (-) battery terminal.
22. Confirm the operation of the fuel door release.