



CAR AGA 1

AERODROMES

FOREWORD

CONTENTS

REVISION RECORD

LIST of EFFECTIVE PAGES



This Page Intentionally Left Blank



FOREWORD

1. The Civil Aviation Authority Bahamas is known in these regulations as the “Authority” and has implemented CAR AGA 1 - Civil Aviation Regulations – Aerodromes and Ground Aids - Aerodromes. The regulations are made under the Civil Aviation Authority Act – 2021.

Notes:

- (a) *All aerodromes, regardless of use, must be registered.*
 - (b) *Aerodromes, capable of being certified, are addressed in CAR AGA 1.*
 - (c) *Heliports, capable of being certified or licensed, are addressed in CAR AGA 2.*
 - (d) *Aerodromes, either temporarily or permanently incapable of certification, may be licensed under CAR AGA 3.*
2. Any reference in this regulation to an Annex to the Chicago Convention includes any differences, present or future, notified to ICAO by the Authority in respect of the Standards specified in that Annex. Appendices to ICAO Annex 14 Volume I are not included in these regulations and require compliance when referred to.
3. Unless otherwise stated, applicable CAR DEF definitions and abbreviations are used throughout this document.
4. The editing practices used in this document are as follows:
 - (a) ‘Shall’ or ‘Will’ or ‘Must’ is used to indicate a mandatory requirement.
 - (b) ‘Should’ is used to indicate a recommendation.
 - (c) ‘May’ is used to indicate discretion by the Authority, the industry or the applicant, as appropriate.

Note: The use of the male gender implies all genders.

5. Paragraphs and sub-paragraphs with new, amended and corrected text will be enclosed within brackets until a subsequent “amendment” is issued.
6. Manuals related to the specifications of CAR AGA 1;
 - (a) Aerodrome Design Manual (Doc 9157)
 - Part 1 — Runways
 - Part 2 — Taxiways, Aprons and Holding Bays
 - Part 3 — Pavements
 - Part 4 — Visual Aids
 - Part 5 — Electrical Systems
 - Part 6 — Frangibility
 - (b) Aeronautical Information Services Manual (Doc 8126)
 - (c) Airport Planning Manual (Doc 9184)
 - Part 1 — Master Planning



Part 2 — Land Use and Environmental Control
Part 3 — Guidelines for Consultant/Construction Services

- (d) Airport Services Manual (Doc 9137)
 - Part 1 — Rescue and Fire-fighting
 - Part 2 — Pavement Surface Conditions
 - Part 3 — Wildlife Control and Reduction
 - Part 4 — Fog Dispersal (withdrawn)
 - Part 5 — Removal of Disabled Aircraft
 - Part 6 — Control of Obstacles
 - Part 7 — Airport Emergency Planning
 - Part 8 — Airport Operational Services
 - Part 9 — Airport Maintenance Practices
- (e) Air Traffic Services Planning Manual (Doc 9426)
- (f) Airworthiness Manual (Doc 9760)
- (g) Volume I — Organization and Procedures
- (h) Volume II — Design Certification and Continuing Airworthiness
- (i) Guidance on the Balanced Approach to Aircraft Noise Management (Doc 9829)
- (j) Heliport Manual (Doc 9261)
- (k) Human Factors Training Manual (Doc 9683)
- (l) Manual of Surface Movement Guidance and Control Systems (SMGCS) (Doc 9476)
- (m) Advanced Surface Movement Guidance and Control Systems (A-SMGCS) Manual (Doc 9830)
- (n) Manual on Certification of Aerodromes (Doc 9774)
- (o) Manual on Laser Emitters and Flight Safety (Doc 9815)
- (p) Manual on Simultaneous Operations on Parallel or Near-Parallel Instrument Runways (SOIR) (Doc 9643)
- (q) Manual on the ICAO Bird Strike Information System (IBIS) (Doc 9332)
- (r) Procedures for Air Navigation Services — Aircraft Operations (PANS-OPS) (Doc 8168)
- (s) Volume I — Flight Procedures
- (t) Volume II — Construction of Visual and Instrument Flight Procedures
- (u) Procedures for Air Navigation Services — Air Traffic Management (PANS-ATM) (Doc 4444)
- (v) Procedures for Air Navigation Services — Aerodromes (PANS-AERODROMES) (Doc 9981)

CAR AGA 1



- (w) Safety Management Manual (SMM) (Doc 9859)
- (x) Stolport Manual (Doc 9150)
- (y) World Geodetic System — 1984 (WGS-84) Manual (Doc 9674)



LIST OF EFFECTIVES PAGES

i	25 Mar 21	3-13	25 Mar 21	5-26	25 Mar 21
ii	25 Mar 21	3-14	25 Mar 21	5-27	25 Mar 21
iii	25 Mar 21	3-15	25 Mar 21	5-28	25 Mar 21
iv	25 Mar 21	3-16	25 Mar 21	5-29	25 Mar 21
v	25 Mar 21	3-17	25 Mar 21	5-30	25 Mar 21
vi	25 Mar 21	3-18	25 Mar 21	5-31	25 Mar 21
vii	25 Mar 21	3-19	25 Mar 21	5-32	25 Mar 21
viii	25 Mar 21	3-20	25 Mar 21	5-33	25 Mar 21
ix	25 Mar 21	3-21	25 Mar 21	5-34	25 Mar 21
x	25 Mar 21	3-22	25 Mar 21	5-35	25 Mar 21
xi	25 Mar 21			5-36	25 Mar 21
xii	25 Mar 21			5-37	25 Mar 21
				5-38	25 Mar 21
				5-39	25 Mar 21
				5-40	25 Mar 21
				5-41	25 Mar 21
				5-42	25 Mar 21
				5-43	25 Mar 21
				5-44	25 Mar 21
				5-45	25 Mar 21
				5-46	25 Mar 21
				5-47	25 Mar 21
				5-48	25 Mar 21
				5-49	25 Mar 21
				5-50	25 Mar 21
				5-51	25 Mar 21
				5-52	25 Mar 21
				5-53	25 Mar 21
				5-54	25 Mar 21
				5-55	25 Mar 21
				5-56	25 Mar 21
				5-57	25 Mar 21
				5-58	25 Mar 21
				5-59	25 Mar 21
				5-60	25 Mar 21
				5-61	25 Mar 21
				5-62	25 Mar 21
				5-63	25 Mar 21
				5-64	25 Mar 21
				5-65	25 Mar 21
				5-66	25 Mar 21
				5-67	25 Mar 21
				5-68	25 Mar 21
				5-69	25 Mar 21
				5-70	25 Mar 21
				5-71	25 Mar 21
				5-72	25 Mar 21
				5-73	25 Mar 21
				5-74	25 Mar 21
				5-75	25 Mar 21
				5-76	25 Mar 21

SECTION 1

Chapter 1

1-1	25 Mar 21
1-2	25 Mar 21
1-3	25 Mar 21
1-4	25 Mar 21
1-5	25 Mar 21
1-6	25 Mar 21
1-7	25 Mar 21
1-8	25 Mar 21

Chapter 2

2-1	25 Mar 21
2-2	25 Mar 21
2-3	25 Mar 21
2-4	25 Mar 21
2-5	25 Mar 21
2-6	25 Mar 21
2-7	25 Mar 21
2-8	25 Mar 21

Chapter 3

3-1	25 Mar 21
3-2	25 Mar 21
3-3	25 Mar 21
3-4	25 Mar 21
3-5	25 Mar 21
3-6	25 Mar 21
3-7	25 Mar 21
3-8	25 Mar 21
3-9	25 Mar 21
3-10	25 Mar 21
3-11	25 Mar 21
3-12	25 Mar 21

Chapter 4

4-1	25 Mar 21
4-2	25 Mar 21
4-3	25 Mar 21
4-4	25 Mar 21
4-5	25 Mar 21
4-6	25 Mar 21
4-7	25 Mar 21
4-8	25 Mar 21
4-9	25 Mar 21
4-10	25 Mar 21

Chapter 5

5-1	25 Mar 21
5-2	25 Mar 21
5-3	25 Mar 21
5-4	25 Mar 21
5-5	25 Mar 21
5-6	25 Mar 21
5-7	25 Mar 21
5-8	25 Mar 21
5-9	25 Mar 21
5-10	25 Mar 21
5-11	25 Mar 21
5-12	25 Mar 21
5-13	25 Mar 21
5-14	25 Mar 21
5-15	25 Mar 21
5-16	25 Mar 21
5-17	25 Mar 21
5-18	25 Mar 21
5-19	25 Mar 21
5-20	25 Mar 21
5-21	25 Mar 21
5-22	25 Mar 21
5-23	25 Mar 21
5-24	25 Mar 21
5-25	25 Mar 21



5-77 25 Mar 21
 5-78 25 Mar 21
 5-79 25 Mar 21
 5-80 25 Mar 21
 5-81 25 Mar 21
 5-82 25 Mar 21
 5-83 25 Mar 21
 5-84 25 Mar 21
 5-85 25 Mar 21
 5-86 25 Mar 21
 5-87 25 Mar 21
 5-88 25 Mar 21

Chapter 6

6-1 25 Mar 21
 6-2 25 Mar 21
 6-3 25 Mar 21
 6-4 25 Mar 21
 6-5 25 Mar 21
 6-6 25 Mar 21
 6-7 25 Mar 21
 6-8 25 Mar 21
 6-9 25 Mar 21
 6-10 25 Mar 21
 6-11 25 Mar 21
 6-12 25 Mar 21
 6-13 25 Mar 21
 6-14 25 Mar 21

Chapter 7

7-1 25 Mar 21
 7-2 25 Mar 21
 7-3 25 Mar 21
 7-4 25 Mar 21

Chapter 8

8-1 25 Mar 21
 8-2 25 Mar 21
 8-3 25 Mar 21
 8-4 25 Mar 21

Chapter 9

9-1 25 Mar 21
 9-2 25 Mar 21
 9-3 25 Mar 21
 9-4 25 Mar 21
 9-5 25 Mar 21
 9-6 25 Mar 21

9-7 25 Mar 21
 9-8 25 Mar 21
 9-9 25 Mar 21
 9-10 25 Mar 21
 9-11 25 Mar 21
 9-12 25 Mar 21
 9-13 25 Mar 21
 9-14 25 Mar 21

Chapter 10

10-1 25 Mar 21
 10-2 25 Mar 21
 10-3 25 Mar 21
 10-4 25 Mar 21
 10-5 25 Mar 21
 10-6 25 Mar 21

Chapter 11

11-1 25 Mar 21
 11-2 25 Mar 21
 11-3 25 Mar 21
 11-4 25 Mar 21

Chapter 12

12-1 25 Mar 21
 12-2 25 Mar 21
 12-3 25 Mar 21
 12-4 25 Mar 21

Chapter 13

13-1 25 Mar 21
 13-2 25 Mar 21

Appendix 1

APP 1-1 25 Mar 21
 APP 1-2 25 Mar 21
 APP 1-3 25 Mar 21
 APP 1-4 25 Mar 21
 APP 1-5 25 Mar 21
 APP 1-6 25 Mar 21
 APP 1-7 25 Mar 21
 APP 1-8 25 Mar 21
 APP 1-9 25 Mar 21
 APP 1-10 25 Mar 21
 APP 1-11 25 Mar 21
 APP 1-12 25 Mar 21

Appendix 2

APP 2-1 25 Mar 21
 APP 2-2 25 Mar 21

Appendix 3

APP 3-1 25 Mar 21
 APP 3-2 25 Mar 21

SECTION 2

i 25 Mar 21
 ii 25 Mar 21

Chapter 1

2-1-1 25 Mar 21
 2-1-2 25 Mar 21
 2-1-3 25 Mar 21
 2-1-4 25 Mar 21

Chapter 11

2-11-1 25 Mar 21
 2-11-2 25 Mar 21

Chapter 12

2-12-1 25 Mar 21
 2-12-2 25 Mar 21

Chapter 13

2-13-1 25 Mar 21
 2-13-2 25 Mar 21

-End-



CONTENTS

Forewordi
 Revision Recordiii
 List of Effective Pages v
 Contentsvii
 Advisory Circular (AC) Contentsxi

CHAPTER 1 GENERAL

1.1 Applicability1-1
 1.2 Requirements for registration of an aerodrome1-1
 1.3 Aerodrome operator responsibilities1-1
 1.4 Abbreviations, symbols and interpretations1-2
 1.5 Operational coordination with service providers1-4
 1.6 Access to the aerodrome.....1-5
 1.7 Aeronautical studies1-6
 1.8 Operational directives.....1-6
 1.9 Common reference systems.....1-6
 1.10 Certification of aerodromes1-6
 1.11 Airport design.....1-7
 1.12 Aerodrome reference code.....1-7
 1.13 Specific procedures for aerodrome operations.....1-8
 1.14 Safety management system (SMS).....1-8

CHAPTER 2 AERODROME DATA

2.1 Aeronautical data2-1
 2.2 Aerodrome reference point.....2-1
 2.3 Aerodrome and runway elevations2-1
 2.4 Aerodrome reference temperature2-1
 2.5 Aerodrome dimensions and related information2-2
 2.6 Strength of pavements2-3
 2.7 Pre-flight altimeter check location2-4
 2.8 Declared distances2-4
 2.9 Condition of the movement area and related facilities2-5
 2.10 Disabled aircraft removal2-6
 2.11 Rescue and fire-fighting2-6
 2.12 Visual approach slope indicator systems2-7
 2.13 Coordination between Aeronautical Information Services and aerodrome authorities .2-7

CHAPTER 3 PHYSICAL CHARACTERISTICS

3.1 Runways3-1
 3.2 Runway shoulders3-5
 3.3 Runway turn pads3-6
 3.4 Runway strips3-7
 3.5 Runway end safety areas3-10
 3.6 Clearways3-12
 3.7 Stopways3-12
 3.8 Radio altimeter operating area3-13
 3.9 Taxiways3-14
 3.10 Taxiway shoulders.....3-18



3.11	Taxiway strips	3-18
3.12	Holding bays, runway-holding positions, intermediate holding positions and road-holding positions	3-19
3.13	Aprons	3-21
3.14	Isolated aircraft parking position	3-21
3.15	De-icing/anti-icing facilities (not applicable)	3-22
CHAPTER 4	OBSTACLE RESTRICTION AND REMOVAL	
4.1	Obstacle limitation surfaces	4-1
4.2	Obstacle limitation requirements	4-5
4.3	Objects outside the obstacle limitation surfaces.....	4-10
4.4	Other objects	4-10
CHAPTER 5	VISUAL AIDS FOR NAVIGATION	
5.1	Indicators and signalling devices.....	5-1
5.1.1	Wind direction indicator	5-1
5.1.2	Landing direction indicator	5-1
5.1.3	Signalling lamp	5-2
5.1.4	Signal panels and signal area	5-2
5.2	Markings	5-3
5.2.1	General	5-3
5.2.2	Runway designation marking	5-3
5.2.3	Runway centre line marking	5-5
5.2.4	Threshold marking.....	5-5
5.2.5	Aiming point marking	5-7
5.2.6	Touchdown zone marking	5-8
5.2.7	Runway side stripe marking.....	5-9
5.2.8	Taxiway centre line marking	5-10
5.2.9	Runway turn pad marking	5-14
5.2.10	Runway-holding position marking	5-15
5.2.11	Intermediate holding position marking	5-16
5.2.12	VOR aerodrome checkpoint marking	5-17
5.2.13	Aircraft stand marking	5-18
5.2.14	Apron safety lines	5-19
5.2.15	Road-holding position marking	5-19
5.2.16	Mandatory instruction marking	5-19
5.2.17	Information marking	5-21
5.3	Lights	5-21
5.3.1	General	5-21
5.3.2	Emergency lighting	5-25
5.3.3	Aeronautical beacons.....	5-26
5.3.4	Approach lighting systems	5-27
5.3.5	Visual approach slope indicator systems	5-34
5.3.6	Circling guidance lights	5-45
5.3.7	Runway lead-in lighting systems	5-46
5.3.8	Runway threshold identification lights	5-47
5.3.9	Runway edge lights	5-47
5.3.10	Runway threshold and wing bar lights	5-48
5.3.11	Runway end lights	5-53
5.3.12	Runway centre line lights	5-53
5.3.13	Runway touchdown zone lights	5-55



5.3.14	Simple touchdown zone lights	5-56
5.3.15	Rapid exit taxiway indicator lights	5-57
5.3.16	Stopway lights	5-58
5.3.17	Taxiway centre line lights.....	5-58
5.3.18	Taxiway edge lights	5-62
5.3.19	Runway turn pad lights	5-63
5.3.20	Stop bars	5-64
5.3.21	Intermediate holding position lights	5-65
5.3.22	De-icing/anti-icing facility exit lights (not applicable).....	5-65
5.3.23	Runway guard lights	5-66
5.3.24	Apron floodlighting	5-67
5.3.25	Visual docking guidance system	5-68
5.3.26	Advanced visual docking guidance system	5-70
5.3.27	Aircraft stand manoeuvring guidance lights	5-71
5.3.28	Road-holding position light	5-72
5.3.29	No-entry bar	5-73
5.3.30	Runway Status Lights.....	5-73
5.4	Signs	5-74
5.4.1	General	5-74
5.4.2	Mandatory instruction signs	5-78
5.4.3	Information signs	5-80
5.4.4	VOR aerodrome checkpoint sign	5-83
5.4.5	Aerodrome identification sign	5-84
5.4.6	Aircraft stand identification signs	5-84
5.4.7	Road-holding position sign	5-85
5.5	Markers	5-85
5.5.1	General	5-85
5.5.2	Unpaved runway edge markers	5-85
5.5.3	Stopway edge markers	5-86
5.5.4	<i>Not applicable</i>	5-86
5.5.5	Taxiway edge markers	5-86
5.5.6	Taxiway centre line markers	5-86
5.5.7	Unpaved taxiway edge markers	5-87
5.5.8	Boundary markers	5-87

CHAPTER 6 VISUAL AIDS FOR DENOTING OBSTACLES

6.1	Objects to be marked and/or lighted.....	6-1
6.2	Marking and/or lighting of objects	6-3

CHAPTER 7 VISUAL AIDS FOR DENOTING RESTRICTED USE AREAS

7.1	Closed runways and taxiways, or parts thereof	7-1
7.2	Non-load-bearing surfaces	7-2
7.3	Pre-threshold area	7-2
7.4	Unserviceable areas	7-3

CHAPTER 8 ELECTRICAL SYSTEMS

8.1	Electrical power supply systems for air navigation facilities	8-1
8.2	System design.....	8-3
8.3	Monitoring	8-4



CHAPTER 9 AERODROME OPERATIONAL SERVICES, EQUIPMENT & INSTALLATIONS	
9.1	Aerodrome emergency planning9-1
9.2	Rescue and fire-fighting9-3
9.3	Disabled aircraft removal9-7
9.4	Wildlife strike hazard reduction9-8
9.5	Apron management service9-8
9.6	Ground servicing of aircraft9-9
9.7	Aerodrome vehicle operations9-9
9.8	Surface movement guidance and control systems9-10
9.9	Siting of equipment and installations on operational areas9-11
9.10	Fencing9-12
9.11	Security lighting9-13
9.12	Autonomous Runway Incursion Warning System9-13
CHAPTER 10 AERODROME MAINTENANCE	
10.1	General10-1
10.2	Pavements10-1
10.3	Removal of contaminants10-2
10.4	Runway pavement overlays10-2
10.5	Visual aids10-3
CHAPTER 11 CERTIFICATION PROCESS	
11.1	General requirements for certification11-1
11.2	Grant of an aerodrome certificate11-2
11.3	Duration of an aerodrome certificate11-2
11.4	Transfer of an aerodrome certificate11-2
11.5	Amendment of an aerodrome certificate11-3
11.6	Surrender of an aerodrome certificate11-3
CHAPTER 12 AERODROME OPERATIONS MANUAL	
12.1	Requirement of the Aerodrome Operations Manual12-1
12.2	Preparation of the Aerodrome Operations Manual (AOM)12-1
12.3	Contents of the Aerodrome Operations Manual12-2
12.4	Amendment and location of the Aerodrome Operations Manual12-2
12.5	Aerodrome Operations Manual review12-2
12.6	Approval of the Aerodrome Operations Manual12-3
CHAPTER 13 OBLIGATIONS OF THE AERODROME OPERATOR	
134.1	General13-1
13.2	Records13-1
13.3	Personnel Competence and Requirements13-1
Appendix 1	Contents of the Aerodrome Operations Manual (AOM).....App 1-1
Appendix 2	Paved Areas – friction level classificationApp 2-1
Appendix 3	Vehicle OperationsApp 3-1



SECTION 2 - ADVISORY CIRCULARS (AC)

General i
Presentation i

CHAPTER 1 GENERAL

AC 1.1 Requirement for an Aerodrome certificate.....2-1-1
AC 1.5.3(c) Runway Safety Team.....2-1-1
AC 1.5.4 Service Level Agreements2-1-1
AC 1.7 Aeronautical Studies.....2-1-2

CHAPTER 11 CERTIFICATION PROCESS

AC 11.1 Certification process2-11-1
AC 11.1.6 Key personnel.....2-11-1
AC 11.2 Grant of an Aerodrome certificate2-11-2

CHAPTER 12 AIRPORT OPERATIONS MANUAL (AOM)

AC 12.1 Preparation of the Aerodrome Operations Manual (AOM).....2-12-1
AC 12.3 Airport Operations Manual (AOM) Compliance Letter2-12-2

CHAPTER 13 OBLIGATIONS OF THE AERODROME OPERATOR

AC 13.1 General.....2-13-1
AC 13.3 Personnel competence2-13-1



This Page Intentionally Left Blank



CHAPTER 1

GENERAL

1.1 Applicability

(See AC 1.1)

1.1.1 CAR AGA 1 applies to aerodromes located in the territory of The Bahamas that are capable of meeting the requirements of these regulations, for the following operation of aeroplanes;

- (a) The conduct of international operations with any type of aeroplane having a passenger seating configuration, excluding any pilot seats, of 30 or more;
- (b) The conduct of domestic commercial operations with any type of aeroplane having a maximum take-off mass (MTOM) of 25,000 kg or more;

1.1.2 CAR AGA 1 also applies to the aerodrome service providers, rescue and firefighting services, security agencies, technical support companies for aircraft: dispatch, online service, fuelling, food and beverage supply, handling of cargo operation and other organisations which perform or may perform independent activities at the aerodrome.

1.1.3 A person shall not operate an aerodrome used for the purposes stated in 1.1.1 (a) or (b) unless it is certified in accordance with these regulations.

1.1.4 A person shall not operate an aeroplane on operations stated in 1.1.1 (a) or (b) from any aerodrome unless it is certified in accordance with these regulations.

1.2 Requirements for registration of an aerodrome

All locations within the Bahamas used for the take-off and landing of aircraft shall be registered with the Authority. The aerodrome operator shall formally notify the Authority and provide the following minimum registration requirements:

- (a) The name of the aerodrome.
- (b) The location of the aerodrome including the geographical coordinates of the aerodrome
- (c) The owner and operator of the aerodrome
- (d) The types of aircraft operating
- (e) A description of the main activities carried out at the aerodrome.

1.3 Aerodrome operator responsibilities

The following aerodrome operator responsibilities shall be applicable to all aerodromes that conduct commercial passenger, cargo and mail operations within the Bahamas:

- (a) Movement area maintenance programs and plan for paved areas, unpaved areas, visual aids, electrical systems (as applicable), secondary power supply (as applicable.);
- (b) aeronautical studies and risk assessment;



- (c) safety audits and inspections by the Authority;
- (d) apron management and safety;
- (e) handling and storage of hazardous materials;
- (f) vehicle operations (as applicable);
- (g) obstacle control;
- (h) fencing;
- (i) notifying and reporting aerodrome conditions to the pilots;
- (j) safety during construction or maintenance;
- (k) ground servicing of aircraft;
- (l) disabled aircraft removal;
- (m) aerodrome incident reporting and investigation; and
- (n) any other provision that in the opinion of the Authority is applicable to the aerodrome, commensurate with the aerodrome operations.

1.4 Abbreviations, symbols and interpretations

1.4.1 In this regulation, the terms and expressions listed below have the following meaning:

(a) Abbreviations

AC	Advisory Circular
ACN	Aircraft classification number.
AIC	Aeronautical Information Circular
AIP	Aeronautical Information Publication
AIS	Aeronautical Information Services
AOM	Aerodrome operations manual
APRX	Approximately
ASDA	Accelerate-stop distance available
ARIWS	Autonomous runway incursion warning system
ATS	Air traffic services
AVSEC	Aviation security
C	Degree Celsius
cd	Candela
cm	Centimetre
DME	Distance measuring equipment
E	Modulus of elasticity
FOD	Foreign object debris
Ft	Foot
ILS	Instrument landing system
IMC	Instrument meteorological conditions
K	Degree Kelvin
kg	Kilogram



km	Kilometre
km/h	Kilometre per hour
kt	Knot
L	Litre
LDA	Landing distance available
m	Metre
max	Maximum
min	Minimum
mm	Millimetre
MN	Meganewton
MPa	Megapascal
MTOM	Maximum Take-off Mass
NM	Nautical mile
NU	Not usable
OCA/H	Obstacle clearance altitude/height
OFZ	Obstacle free zone
OLS	Obstacles Limitation Surfaces
OMGWS	Outer main gear wheel span
OPS	Obstacle protection surface
PANS	Procedures of Air navigation service
PCN	Pavement classification number
RCAM	Runway Condition Assessment Matrix
RCR	Runway condition report
RESA	Runway end safety area
RVR	Runway visual range
RWYCC	Runway condition code
TODA	Take-off distance available
TORA	Take-off runway available
TRA	Task Resource Analysis
VMC	Visual meteorological conditions
VOR	Very high frequency omnidirectional radio range
WHMP	Wildlife hazard management programme
WIP	Work in progress

(b) Symbols

°	-	Degree
=	-	Equals
'	-	Minute of arc
μ	-	Friction coefficient
>	-	Greater than
<	-	Less than
%	-	Percentage
±	-	Plus or minus

(c) Interpretations

The interpretation of some of the specifications in these regulations expressly requires the exercising of discretion, the taking of a decision or the performance of a function by the appropriate authority. In other specifications, the expression appropriate authority does not actually appear although its inclusion is implied. In both cases, the responsibility for whatever determination or action is necessary shall rest with the Authority, as having jurisdiction over the aerodrome.



The specifications, unless otherwise indicated in a particular context, shall apply to all aerodromes open to public use in accordance with the requirements of Article 15 of the ICAO Convention. The specifications of CAR AGA 1, Chapter 3, shall apply only to land aerodromes. The specifications in this regulation shall apply, where appropriate, to heliports but shall not apply to Stolports.

Wherever a colour is referred to in these regulations, the specifications for that colour given in Appendix 1 to ICAO Annex 14, Volume 1 shall apply.

1.5 Operational Coordination with Service Providers

- 1.5.1 The aerodrome operator shall coordinate with Air Traffic Services, Meteorological Services, Aeronautical Information Services, Rescue and Firefighting Services, Aviation Security Agencies, Customs, Immigration office and all other relevant services to ensure safety, availability and continuity on the provision of such services.
- 1.5.2 All Service Providers shall actively adhere to the aerodrome Safety Management System (SMS).
- 1.5.3 The aerodrome operator shall chair and lead as a minimum, the following committees:
- (a) The Safety Management Committee.
 - (b) The Security and Facilitation Committee.
 - (c) The Runway Safety Team (See AC 1.5.3(c))
 - (d) The Emergency Planning Committee,
 - (e) The Wildlife Hazard Control Committee
- 1.5.4 The aerodrome operator shall Service Level Agreements with the aerodrome users and service providers with the aim of agreeing competences, liabilities or any other aspect needed to ensure aerodrome safety, availability and continuity of service provision. (See AC 1.5.4)
- 1.5.5 The aerodrome operator shall make arrangements with the Aeronautical Information Services provider for immediate notification to ensure that the appropriate parties receive the necessary data to provide updated information prior to the flight and satisfy the need of information during the flight, including;
- (a) information on the aerodrome certification situation and the aerodrome conditions;
 - (b) serviceability of the facilities, services and navigation aids located within the area of competence;
 - (c) any information that may be relevant to operations.
- 1.5.6 To ensure that Aeronautical Information Services units obtain information to enable them to provide up-to-date pre-flight information and to meet the need for in-flight information, arrangements shall be made between Aeronautical Information Services and aerodrome authorities responsible for aerodrome services to report the following to the responsible Aeronautical Information Services unit, with a minimum of delay.
- (a) Information on the status of certification of aerodromes and aerodrome conditions.



- (b) the operational status of associated facilities, services and navigation aids within their area of responsibility;
- (c) any other information considered to be of operational significance.

1.5.7 Before introducing changes to the air navigation system, due account shall be taken by the services responsible for such changes of the time needed by Aeronautical Information Services for the preparation, production and issue of relevant material for promulgation.

Note: To ensure timely provision of the information to Aeronautical Information Services, close coordination between those services concerned is required. Of a particular importance are changes to aeronautical information that affect charts and/or computer-based navigation systems which qualify to be notified by the aeronautical information regulation and control (AIRAC) system, as specified in CAR AIS, (Regulation and Control of Aeronautical Information)

1.5.8 The predetermined, internationally agreed AIRAC effective dates in addition to 14 days postage time shall be observed by the responsible aerodrome services when submitting the raw information/data to Aeronautical Information Services.

1.5.9 The aerodrome services responsible for the provision of raw aeronautical information/data to the Aeronautical Information Services shall ensure accuracy and integrity requirements for aeronautical data as specified in CAR AIS.

1.6 Access to the Aerodrome

1.6.1 A person authorised by the Authority may verify, audit, inspect and carry out tests on the aerodrome facilities, services and equipment, inspect the aerodrome operator's documents and records and audit the aerodrome operator's SMS before the aerodrome certificate is granted or renewed and subsequently, at any other time, for the purpose of ensuring safety at the aerodrome.

1.6.2 An aerodrome operator or applicant shall, at the request of the Authority's authorised person cooperate in the inspection duties and allow access to any part of the aerodrome or any aerodrome facility, including equipment, technical records and documents as well as operator and management personnel.

1.6.3 The aerodrome operator shall observe and comply with the annual monitoring programme established by the Authority for safety monitoring purposes at each aerodrome. This shall not affect random unannounced inspections or audits conducted by an authorised person to determine whether approved operation requirements and procedures are met under all circumstances and whether they conform to the activity and comply with these regulations.

1.6.4 The aerodrome operator shall resolve the findings from the Authority's authorised person(s) and once notified by an official report, shall send a corrective action plan within the established period.

1.6.5 Failure to resolve the findings may result in the revocation/suspension of the aerodrome certificate and/or enforcement consequences.



1.7 Aeronautical Studies

(See AC 1.7)

1.7.1 An aeronautical study shall be conducted to assess the impact of deviations from the aerodrome standards specified in these regulations to present alternative means of ensuring the safety of aircraft operations, to estimate the effectiveness of each alternative and to recommend procedures to compensate for the deviation.

1.8 Operational Directives

1.8.1 The Authority may issue operational directives to prohibit, limit or subject an operation to certain conditions in the interest of safety.

1.8.2 Operational directives shall have:

- (a) The reason for issuance;
- (b) The scope and duration; and
- (c) Action required from aerodrome operators.

1.8.3 Anything required by the operational directives shall be considered an additional requirement to those established in these regulations

1.8.4 The Authority may also issue Acceptable Means of Compliance to facilitate compliance and implementation of this regulation.

1.9 Common reference systems

1.9.1 Horizontal reference system

World Geodetic System — 1984 (WGS-84) shall be used as the horizontal (geodetic) reference system. Reported aeronautical geographical coordinates (indicating latitude and longitude) shall be expressed in terms of the WGS-84 geodetic reference datum.

1.9.2 Vertical reference system

Mean sea level (MSL) datum, which gives the relationship of gravity-related height (elevation) to a surface known as the geoid, shall be used as the vertical reference system.

1.9.3 Temporal reference system

- (a) The Gregorian calendar and Coordinated Universal Time (UTC) shall be used as the temporal reference system.
- (b) When a different temporal reference system is used, this shall be indicated in GEN 2.1.2 of the Aeronautical Information Publication (AIP) of The Bahamas;

1.10 Certification of aerodromes

1.10.1 The Authority shall certify aerodromes used for international operations in accordance with the specifications contained in these regulations as well as other relevant ICAO specifications through an appropriate regulatory framework.



- 1.10.2 The Authority should certify aerodromes open to public use in accordance with these specifications as well as other relevant ICAO specifications through an appropriate regulatory framework.
- 1.10.3 The regulatory framework shall include the establishment of criteria and procedures for the certification or licensing of aerodromes.
- 1.10.4 As part of the certification process, the Authority shall ensure that an aerodrome manual which will include all pertinent information on the aerodrome site, facilities, services, equipment, operating procedures, organization and management including a safety management system, is submitted by the applicant for approval/acceptance prior to granting the aerodrome certificate.

1.11 Airport design

- 1.11.1 Architectural and infrastructure-related requirements for the optimum implementation of international civil aviation security measures shall be integrated into the design and construction of new facilities and alterations to existing facilities at an aerodrome.
- 1.11.2 The design of aerodromes shall take into account land-use and environmental control measures.

1.12 Aerodrome reference code

- 1.12.1 An aerodrome reference code — code number and letter — which is selected for aerodrome planning purposes shall be determined in accordance with the characteristics of the aeroplane for which an aerodrome facility is intended.
- 1.12.2 The aerodrome reference code numbers and letters shall have the meanings assigned to them in Table 1-1.
- 1.12.3 The code number for element 1 shall be determined from Table 1-1, column 1, selecting the code number corresponding to the highest value of the aeroplane reference field lengths of the aeroplanes for which the runway is intended.

Note: The determination of the aeroplane reference field length is solely for the selection of a code number and is not intended to influence the actual runway length provided.

- 1.12.4 The code letter for element 2 shall be determined from Table 1-1, column 3, by selecting the code letter which corresponds to the greatest wingspan, column 4 of the aeroplanes for which the facility is intended.



Table 1-1. Aerodrome reference code
(see 1.12.2 to 1.12.4)

Code element 1	
Code number	Aeroplane reference field length
1	Less than 800 m
2	800 m up to but not including 1 200 m
3	1 200 m up to but not including 1 800 m
4	1 800 m and over
Code element 2	
Code letter	Wingspan
A	Up to but not including 15 m
B	15 m up to but not including 24 m
C	24 m up to but not including 36 m
D	36 m up to but not including 52 m
E	52 m up to but not including 65 m
F	65 m up to but not including 80 m

1.13 Specific Procedures for Aerodrome Operations

- 1.13.1 When the aerodrome accommodates an aeroplane that exceeds the certificated characteristics of the aerodrome, the compatibility between the operation of the aeroplane and aerodrome infrastructure and operations shall be assessed and appropriate measures be developed and implemented in order to maintain an acceptable level of safety during operations.
- 1.13.2 Information concerning alternative measures, operational procedures and operating restrictions implemented at an aerodrome arising from 1.13.1 shall be promulgated.

1.14 Safety Management System

- 1.14.1 The SMS of an operator of a certified aerodrome shall:
 - (a) be established in accordance with the framework elements contained CAR SMS; and
 - (b) be commensurate with the size of the service provider and the complexity of its aviation products or services.
 - (c) be made acceptable to the Authority as the Authority responsible for the aerodrome’s certification.



CHAPTER 2

AERODROME DATA

2.1 Aeronautical data

- 2.1.1 Determination and reporting of aerodrome-related aeronautical data shall be in accordance with the accuracy and integrity classification required to meet the needs of the end-users of aeronautical data.
- 2.1.2 Aerodrome mapping data should be made available to the Aeronautical Information Services for aerodromes deemed relevant by States where safety and/or performance-based operations suggest possible benefits.
- 2.1.3 Where made available in accordance with 2.1.2, the selection of the aerodrome mapping data features to be collected shall be made with consideration of the intended applications.
- 2.1.4 Digital data error detection techniques shall be used during the transmission and/or storage of aeronautical data and digital data sets.

2.2 Aerodrome reference point

- 2.2.1 An aerodrome reference point shall be established for an aerodrome.
- 2.2.2 The aerodrome reference point shall be located near the initial or planned geometric centre of the aerodrome and shall normally remain where first established.
- 2.2.3 The position of the aerodrome reference point shall be measured and reported to the Aeronautical Information Services authority in degrees, minutes and seconds.

2.3 Aerodrome and runway elevations

- 2.3.1 The aerodrome elevation and geoid undulation at the aerodrome elevation position shall be measured to the accuracy of one-half metre or foot and reported to the Aeronautical Information Services authority.
- 2.3.2 For an aerodrome used by international civil aviation for non-precision approaches, the elevation and geoid undulation of each threshold, the elevation of the runway end and any significant high and low intermediate points along the runway shall be measured to the accuracy of one-half metre or foot and reported to the Aeronautical Information Services authority.
- 2.3.3 For precision approach runway, the elevation and geoid undulation of the threshold, the elevation of the runway end and the highest elevation of the touchdown zone shall be measured to the accuracy of one-quarter metre or foot and reported to the Aeronautical Information Services authority.

2.4 Aerodrome reference temperature

- 2.4.1 An aerodrome reference temperature shall be determined for an aerodrome in degrees Celsius.
- 2.4.2 The aerodrome reference temperature shall be the monthly mean of the daily maximum temperatures for the hottest month of the year (the hottest month being that which has the highest monthly mean temperature). This temperature should be averaged over a period of years.



2.5 Aerodrome dimensions and related information

- 2.5.1 The following data shall be measured or described, as appropriate, for each facility provided on an aerodrome:
- (a) runway — true bearing to one-hundredth of a degree, designation number, length, width, displaced threshold location to the nearest metre or foot, slope, surface type, type of runway and, for a precision approach runway category I, the existence of an obstacle free zone when provided;
 - (b) strip
runway end safety area } length, width to the nearest metre or foot, surface type; and
stopway }
arresting system – location (which runway end) and description.
 - (c) taxiway — designation, width, surface type;
 - (d) apron — surface type, aircraft stands;
 - (e) the boundaries of the air traffic control service;
 - (f) clearway — length to the nearest metre or foot, ground profile;
 - (g) visual aids for approach procedures, marking and lighting of runways, taxiways and aprons, other visual guidance and control aids on taxiways and aprons, including taxi-holding positions and stopbars, and location and type of visual docking guidance systems;
 - (h) location and radio frequency of any VOR aerodrome checkpoint;
 - (i) location and designation of standard taxi-routes; and
 - (j) distances to the nearest metre or foot of localizer and glide path elements comprising an instrument landing system (ILS) or azimuth and elevation antenna of a microwave landing system (MLS) in relation to the associated runway extremities.
- 2.5.2 The geographical coordinates of each threshold shall be measured and reported to the Aeronautical Information Services authority in degrees, minutes, seconds and hundredths of seconds.
- 2.5.3 The geographical coordinates of appropriate taxiway centre line points shall be measured and reported to the Aeronautical Information Services authority in degrees, minutes, seconds and hundredths of seconds.
- 2.5.4 The geographical coordinates of each aircraft stand shall be measured and reported to the Aeronautical Information Services authority in degrees, minutes, seconds and hundredths of seconds.
- 2.5.5 The geographical coordinates of obstacles in Area 2 (the part within the aerodrome boundary) and in Area 3 shall be measured and reported to the Aeronautical Information Services authority in degrees, minutes, seconds and tenths of seconds. In addition, the top elevation, type, marking and lighting (if any) of obstacles shall be reported to the Aeronautical Information Services authority.



2.6 Strength of pavements

2.6.1 The bearing strength of a pavement shall be determined.

2.6.2 The bearing strength of a pavement intended for aircraft of apron (ramp) mass greater than 5 700 kg shall be made available using the aircraft classification number — pavement classification number (ACN-PCN) method by reporting all of the following information:

- (a) the pavement classification number (PCN);
- (b) pavement type for ACN-PCN determination;
- (c) subgrade strength category;
- (d) maximum allowable tyre pressure category or maximum allowable tyre pressure value; and
- (e) evaluation method.

2.6.3 The pavement classification number (PCN) reported shall indicate that an aircraft with an aircraft classification number (ACN) equal to or less than the reported PCN can operate on the pavement subject to any limitation on the tyre pressure, or aircraft all-up mass for specified aircraft type(s).

2.6.4 The ACN of an aircraft shall be determined in accordance with the standard procedures associated with the ACN- PCN method.

2.6.5 For the purposes of determining the ACN, the behaviour of a pavement shall be classified as equivalent to a rigid or flexible construction.

2.6.6 Information on pavement type for ACN-PCN determination, subgrade strength category, maximum allowable tyre pressure category and evaluation method shall be reported using the following codes:

(a) *Pavement type for ACN-PCN determination:*

	<i>Code</i>
Rigid pavement	R
Flexible pavement	F

(b) *Subgrade strength category:*

	<i>Code</i>
<i>High strength:</i> characterised by $K = 150 \text{ MN/m}^3$ and representing all K values above 120 MN/m^3 for rigid pavements and by CBR = 15 and representing all CBR values above 13 for flexible pavements.	A
<i>Medium strength:</i> characterized by $K = 80 \text{ MN/m}^3$ and representing a range in K of $60 \text{ to } 120 \text{ MN/m}^3$ for rigid pavements and by CBR = 10 and representing a range in CBR of 8 to 13 for flexible pavements.	B
<i>Low strength:</i> characterized by $K = 40 \text{ MN/m}^3$ and representing a range in K of $25 \text{ to } 60 \text{ MN/m}^3$ for rigid pavements and by CBR = 6 and representing a range in CBR of 4 to 8 for flexible pavements.	C
<i>Ultra low strength:</i> characterized by $K = 20 \text{ MN/m}^3$ and representing all K values below 25 MN/m^3 for rigid pavements and by CBR = 3 and representing	D



- (c) all CBR values below 4 for flexible pavements
Maximum allowable tyre pressure category:

	<i>Code</i>
<i>Unlimited:</i> no pressure limit	W
<i>High:</i> pressure limited to 1.75 MPa	X
<i>Medium:</i> pressure limited to 1.25 MPa	Y
<i>Low:</i> pressure limited to 0.50 MPa	Z

- (d) *Evaluation method:*

	<i>Code</i>
<i>Technical evaluation:</i> representing a specific study of the pavement characteristics and application of pavement behaviour technology.	T
<i>Using aircraft experience:</i> representing a knowledge of the specific type and mass of aircraft satisfactorily being supported under regular use.	U

2.6.7 Criteria shall be established to regulate the use of a pavement by an aircraft with an ACN higher than the PCN reported for that pavement in accordance with 2.6.2 and 2.6.3.

2.6.8 The bearing strength of a pavement intended for aircraft of apron (ramp) mass equal to or less than 5 700 kg shall be made available by reporting the following information:

- (a) maximum allowable aircraft mass; and
- (b) maximum allowable tyre pressure.

Example: 4 000 kg/0.50 MPa.

2.7 Pre-flight altimeter check location

2.7.1 One or more pre-flight altimeter check locations shall be established for an aerodrome.

2.7.2 A pre-flight check location shall be located on an apron.

2.7.3 The elevation of a pre-flight altimeter check location shall be given as the average elevation, rounded to the nearest metre or foot, of the area on which it is located. The elevation of any portion of a pre-flight altimeter check location shall be within 3 m (10 ft) of the average elevation for that location.

2.8 Declared distances

The following distances shall be calculated to the nearest metre or foot for a runway intended for use by international commercial air transport:

- (a) take-off run available;
- (b) take-off distance available;
- (c) accelerate-stop distance available; and



(d) landing distance available.

2.9 Condition of the movement area and related facilities

2.9.1 Information on the condition of the movement area and the operational status of related facilities shall be provided to the appropriate Aeronautical Information Services units, and similar information of operational significance to the air traffic services units, to enable those units to provide the necessary information to arriving and departing aircraft. The information shall be kept up to date and changes in conditions reported without delay.

2.9.2 The condition of the movement area and the operational status of related facilities shall be monitored, and reports on matters of operational significance affecting aircraft and aerodrome operations shall be provided in order to take appropriate action, particularly in respect of the following:

- (a) construction or maintenance work;
- (b) rough or broken surfaces on a runway, a taxiway or an apron;
- (c) water, snow, slush, ice, or frost on a runway, a taxiway or an apron;
- (d) liquid chemicals or other contaminants on a runway, taxiway or apron;
- (e) snow banks or drifts adjacent to a runway, a taxiway or an apron;
- (f) other temporary hazards, including parked aircraft;
- (g) failure or irregular operation of part or all of the aerodrome visual aids; and
- (h) failure of the normal or secondary power supply.

2.9.3 To facilitate compliance with 2.9.1 and 2.9.2, the following inspections shall be carried out each day;

- (a) for the movement area, at least once where the aerodrome reference code number is 1 or 2 and at least twice where the aerodrome reference code number is 3 or 4;
- (b) for the runway(s), inspections in addition to (a) whenever the runway surface conditions may have changed significantly due to meteorological conditions.

2.9.4 Personnel assessing and reporting runway surface conditions required in 2.9.2 and 2.9.5 shall be trained and competent to perform their duties.

Runway surface condition(s) for use in the runway condition report

2.9.5 The runway surface condition shall be assessed and reported through a runway condition code (RWYCC) and a description using the following terms:

COMPACTED SNOW
 DRY
 DRY SNOW
 DRY SNOW ON TOP OF COMPACTED SNOW
 DRY SNOW ON TOP OF ICE



FROST
ICE
SLUSH
STANDING WATER
WATER ON TOP OF COMPACTED SNOW
WET
WET ICE
WET SNOW
WET SNOW ON TOP OF COMPACTED SNOW
WET SNOW ON TOP OF ICE
CHEMICALLY TREATED
LOOSE SAND

- 2.9.6 Whenever an operational runway is contaminated, an assessment of the contaminant depth and coverage over each third of the runway shall be made and reported.
- 2.9.7 When friction measurements are used as part of the overall runway surface assessment on compacted snow- or ice-covered surfaces, the friction measuring device shall meet the standard set or agreed by the Authority.
- 2.9.8 Friction measurements made on runway surface conditions with contaminants other than compacted snow and ice should not be reported.
- 2.9.9 Information that a runway or portion thereof is slippery wet shall be made available.
- 2.9.10 Notification shall be given to relevant aerodrome users when the friction level of a paved runway or portion thereof is less than the minimum friction level specified by the Authority in accordance with 10.2.3. (See Appendix 2)

2.10 Disabled aircraft removal

- 2.10.1 The telephone/telex number(s) of the office of the aerodrome coordinator of operations for the removal of an aircraft disabled on or adjacent to the movement area should be made available, on request, to aircraft operators.
- 2.10.2 Information concerning the capability to remove an aircraft disabled on or adjacent to the movement area should be made available.

2.11 Rescue and fire-fighting

- 2.11.1 Information concerning the level of protection provided at an aerodrome for aircraft rescue and fire-fighting purposes shall be made available.
- 2.11.2 The level of protection normally available at an aerodrome should be expressed in terms of the category of the rescue and fire-fighting services as described in 9.2 and in accordance with the types and amounts of extinguishing agents normally available at the aerodrome.
- 2.11.3 Changes in the level of protection normally available at an aerodrome for rescue and fire-fighting shall be notified to the appropriate air traffic services units and Aeronautical Information Services units to enable those units to provide the necessary information to arriving and departing aircraft. When such a change has been corrected, the above units shall be advised accordingly.
- 2.11.4 A change should be expressed in terms of the new category of the rescue and fire-fighting service



available at the aerodrome.

2.12 Visual approach slope indicator systems

The following information concerning a visual approach slope indicator system installation shall be made available:

- (a) associated runway designation number;
- (b) type of system according to 5.3.5.2. For an AT-VASIS, PAPI or APAPI installation, the side of the runway on which the lights are installed, i.e. left or right, shall be given;
- (c) where the axis of the system is not parallel to the runway centre line, the angle of displacement and the direction of displacement, i.e. left or right, shall be indicated;
- (d) nominal approach slope angle(s). For a T-VASIS or an AT-VASIS this shall be angle Θ according to the formula in Figure 5-18 and for a PAPI and an APAPI this shall be angle $(B + C) \div 2$ and $(A + B) \div 2$, respectively as in Figure 5-20; and
- (e) minimum eye height(s) over the threshold of the on-slope signal(s). For a T-VASIS or an AT-VASIS this shall be the lowest height at which only the wing bar(s) are visible; however, the additional heights at which the wing bar(s) plus one, two or three fly-down light units come into view may also be reported if such information would be of benefit to aircraft using the approach. For a PAPI this shall be the setting angle of the third unit from the runway minus $2'$, i.e. angle B minus $2'$, and for an APAPI this shall be the setting angle of the unit farther from the runway minus $2'$, i.e. angle A minus $2'$.

2.13 Coordination between Aeronautical Information Services and aerodrome authorities

2.13.1 To ensure that AIS units obtain information to enable them to provide up-to-date pre-flight information and to meet the need for in-flight information, arrangements shall be made between Aeronautical Information Services and aerodrome authorities responsible for aerodrome services to report to the responsible Aeronautical Information Services unit, with a minimum of delay:

- (a) information on the status of certification of aerodromes and aerodrome conditions (refer 1.4, 2.9, 2.10, 2.11 and 2.12);
- (b) the operational status of associated facilities, services and navigation aids within their area of responsibility;
- (c) any other information considered to be of operational significance.

2.13.2 Before introducing changes to the air navigation system, due account shall be taken by the services responsible for such changes of the time needed by Aeronautical Information Services for the preparation, production and issue of relevant material for promulgation. To ensure timely provision of the information to Aeronautical Information Services, close coordination between those services concerned is therefore required.

2.13.3 Of a particular importance are changes to aeronautical information that affect charts and/or computer-based navigation systems which qualify to be notified by the aeronautical information regulation and control (AIRAC) system, as specified in ICAO Annex 15, Chapter 6. The predetermined, internationally agreed AIRAC effective dates shall be observed by the responsible aerodrome services when submitting the raw information/data to Aeronautical Information



Services.

- 2.13.4 The aerodrome services responsible for the provision of raw aeronautical information/data to the Aeronautical Information Services shall do that while taking into account accuracy and integrity required to meet the needs of the end-user of aeronautical data.



CHAPTER 3

PHYSICAL CHARACTERISTICS

3.1 Runways

Number and orientation of runways

- 3.1.1 The number and orientation of runways at an aerodrome shall be such that the usability factor of the aerodrome is not less than 95 per cent for the aeroplanes that the aerodrome is intended to serve.
- 3.1.2 The siting and orientation of runways at an aerodrome shall, where possible, be such that the arrival and departure tracks minimize interference with areas approved for residential use and other noise-sensitive areas close to the aerodrome in order to avoid future noise problems.
- 3.1.3 Choice of maximum permissible crosswind components

In the application of 3.1.1 it shall be assumed that landing or take-off of aeroplanes is, in normal circumstances, precluded when the crosswind component exceeds:

- 37 km/h (20 kt) in the case of aeroplanes whose reference field length is 1 500 m or over, except that when poor runway braking action owing to an insufficient longitudinal coefficient of friction is experienced with some frequency, a crosswind component not exceeding 24 km/h (13 kt) should be assumed;
- 24 km/h (13 kt) in the case of aeroplanes whose reference field length is 1 200 m or up to but not including 1 500 m; and
- 19 km/h (10 kt) in the case of aeroplanes whose reference field length is less than 1 200 m.

3.1.4 Data to be used

The selection of data to be used for the calculation of the usability factor shall be based on reliable wind distribution statistics that extend over as long a period as possible, preferably of not less than five years. The observations used should be made at least eight times daily and spaced at equal intervals of time.

Location of threshold

- 3.1.5 A threshold shall be located at the extremity of a runway unless operational considerations justify the choice of another location.
- 3.1.6 When it is necessary to displace a threshold, either permanently or temporarily, from its normal location, account shall be taken of the various factors which may have a bearing on the location of the threshold. Where this displacement is due to an unserviceable runway condition, a cleared and graded area of at least 60 m in length should be available between the unserviceable area and the displaced threshold. Additional distance shall also be provided to meet the requirements of the runway end safety area as appropriate.

Actual length of runways

3.1.7 Primary runway



Except as provided in 3.1.9, the actual runway length to be provided for a primary runway shall be adequate to meet the operational requirements of the aeroplanes for which the runway is intended and should be not less than the longest length determined by applying the corrections for local conditions to the operations and performance characteristics of the relevant aeroplanes.

3.1.8 Secondary runway

The length of a secondary runway shall be determined similarly to primary runways except that it needs only to be adequate for those aeroplanes which require to use that secondary runway in addition to the other runway or runways in order to obtain a usability factor of at least 95 per cent.

3.1.9 Runways with stopways or clearways

Where a runway is associated with a stopway or clearway, an actual runway length less than that resulting from application of 3.1.7 or 3.1.8, as appropriate, may be considered satisfactory, but in such a case any combination of runway, stopway and clearway provided shall permit compliance with the operational requirements for take-off and landing of the aeroplanes the runway is intended to serve.

Width of runways

3.1.10 The width of a runway shall be not less than the appropriate dimension specified in the following tabulation:

Outer Main Gear Wheel Span (OMGWS)				
Code number	Up to but not including 4.5 m	4.5 m up to but not including 6 m	6 m up to but not including 9 m	9 m up to but not including 15 m
1 ^a	18 m	18 m	23 m	–
2 ^a	23 m	23 m	30 m	–
3	30 m	30 m	30 m	45 m
4	–	–	45 m	45 m

a. The width of a precision approach runway should be not less than 30 m where the code number is 1 or 2.

Minimum distance between parallel runways

3.1.11 Where parallel non-instrument runways are intended for simultaneous use, the minimum distance between their centre lines should be:

- 210 m where the higher code number is 3 or 4;
- 150 m where the higher code number is 2; and
- 120 m where the higher code number is 1.

3.1.12 Where parallel instrument runways are intended for simultaneous use subject to conditions specified in the PANS-ATM (Doc 4444) and the PANS-OPS (Doc 8168), Volume I, the minimum distance between their centre lines shall be:

- 1 035 m for independent parallel approaches;



- 915 m for dependent parallel approaches;
- 760 m for independent parallel departures;
- 760 m for segregated parallel operations; except that:
 - (a) for segregated parallel operations the specified minimum distance:
 - (1) may be decreased by 30 m for each 150 m that the arrival runway is staggered toward the arriving aircraft, to a minimum of 300 m; and
 - (2) shall be increased by 30 m for each 150 m that the arrival runway is staggered away from the arriving aircraft;
 - (b) for independent parallel approaches, combinations of minimum distances and associated conditions other than those specified in the PANS-ATM (Doc 4444) may be applied when it is determined that such combinations would not adversely affect the safety of aircraft operations.

Slopes on runways

3.1.13 Longitudinal slopes

The slope computed by dividing the difference between the maximum and minimum elevation along the runway centre line by the runway length shall not exceed:

- 1 per cent where the code number is 3 or 4; and
- 2 per cent where the code number is 1 or 2.

3.1.14 Along no portion of a runway shall the longitudinal slope exceed:

- 1.25 per cent where the code number is 4, except that for the first and last quarter of the length of the runway the longitudinal slope shall not exceed 0.8 per cent;
- 1.5 per cent where the code number is 3, except that for the first and last quarter of the length of a precision approach runway category II or III the longitudinal slope shall not exceed 0.8 per cent; and
- 2 per cent where the code number is 1 or 2.

3.1.15 Longitudinal slope changes

Where slope changes cannot be avoided, a slope change between two consecutive slopes shall not exceed:

- 1.5 per cent where the code number is 3 or 4; and
- 2 per cent where the code number is 1 or 2.

3.1.16 The transition from one slope to another shall be accomplished by a curved surface with a rate of



change not exceeding:

- 0.1 per cent per 30 m (minimum radius of curvature of 30 000 m) where the code number is 4;
- 0.2 per cent per 30 m (minimum radius of curvature of 15 000 m) where the code number is 3; and
- 0.4 per cent per 30 m (minimum radius of curvature of 7 500 m) where the code number is 1 or 2.

3.1.17 Sight distance

Where slope changes cannot be avoided, they should be such that there will be an unobstructed line of sight from:

- any point 3 m above a runway to all other points 3 m above the runway within a distance of at least half the length of the runway where the code letter is C, D, E or F;
- any point 2 m above a runway to all other points 2 m above the runway within a distance of at least half the length of the runway where the code letter is B; and
- any point 1.5 m above a runway to all other points 1.5 m above the runway within a distance of at least half the length of the runway where the code letter is A.

3.1.18 Distance between slope changes

Undulations or appreciable changes in slopes located close together along a runway shall be avoided. The distance between the points of intersection of two successive curves should not be less than:

- (a) the sum of the absolute numerical values of the corresponding slope changes multiplied by the appropriate value as follows:
 - 30 000 m where the code number is 4;
 - 15 000 m where the code number is 3; and
 - 5 000 m where the code number is 1 or 2; or
- (b) 45 m; whichever is greater.

3.1.19 Transverse slopes

To promote the most rapid drainage of water, the runway surface shall, if practicable, be cambered except where a single crossfall from high to low in the direction of the wind most frequently associated with rain would ensure rapid drainage. The transverse slope should ideally be:

- 1.5 per cent where the code letter is C, D, E or F; and
- 2 per cent where the code letter is A or B;

but in any event should not exceed 1.5 per cent or 2 per cent, as applicable, nor be less than 1 per

cent except at runway or taxiway intersections where flatter slopes may be necessary.

For a cambered surface the transverse slope on each side of the centre line should be symmetrical.

3.1.20 The transverse slope shall be substantially the same throughout the length of a runway except at an intersection with another runway or a taxiway where an even transition should be provided taking account of the need for adequate drainage.

Strength of runways

3.1.21 A runway shall be capable of withstanding the traffic of aeroplanes the runway is intended to serve.

Surface of runways

3.1.22 The surface of a runway shall be constructed without irregularities that would impair the runway surface friction characteristics or otherwise adversely affect the take-off or landing of an aeroplane.

3.1.23 A paved runway shall be so constructed or resurfaced as to provide surface friction characteristics at or above the minimum friction level set by the Authority. (See Appendix 2)

3.1.24 The surface of a paved runway shall be evaluated when constructed or resurfaced to determine that the surface friction characteristics achieve the design objectives.

3.1.25 Measurements of the surface friction characteristics of a new or resurfaced paved runway shall be made with a continuous friction measuring device using self-wetting features.

3.1.26 The average surface texture depth of a new surface shall be not less than 1.0 mm.

3.1.27 When the surface is grooved or scored, the grooves or scorings should be either perpendicular to the runway centre line or parallel to non-perpendicular transverse joints, where applicable.

3.2 Runway shoulders

General

3.2.1 Runway shoulders shall be provided for a runway where the code letter is D or F.

Width of runway shoulders

3.2.2 For aeroplanes with an outer main gear wheel span from 9 m up to but not including 15 m the runway shoulders shall extend symmetrically on each side of the runway so that the overall width of the runway and its shoulders is not less than:

- 60 m where the code letter is D or E;
- 60 m where the code letter is F with two or three engined aeroplanes;
- 75 m where the code letter is F with four (or more)-engined aeroplanes.

Slopes on runway shoulders

3.2.3 The surface of the shoulder that abuts the runway shall be flush with the surface of the runway and its transverse slope shall not exceed 2.5 per cent.

Strength of runway shoulders

3.2.4 The portion of a runway shoulder between the runway edge and a distance of 30 m from the runway centreline shall be prepared or constructed so as to be capable, in the event of an aeroplane running off the runway, of supporting the aeroplane without inducing structural damage to the aeroplane and of supporting ground vehicles which may operate on the shoulder.

Surface of runway shoulders

3.2.5 A runway shoulder shall be prepared or constructed so as to resist erosion and the ingestion of the surface material by aeroplane engines.

3.2.6 Runway shoulders for code letter F aeroplanes shall be paved to a minimum overall width of runway and shoulder of not less than 60 m.

3.3 Runway turn pads

General

3.3.1 Where the end of a runway is not served by a taxiway or a taxiway turnaround and where the code letter is D, E or F, a runway turn pad shall be provided to facilitate a 180-degree turn of aeroplanes. (See Figure 3-1.)

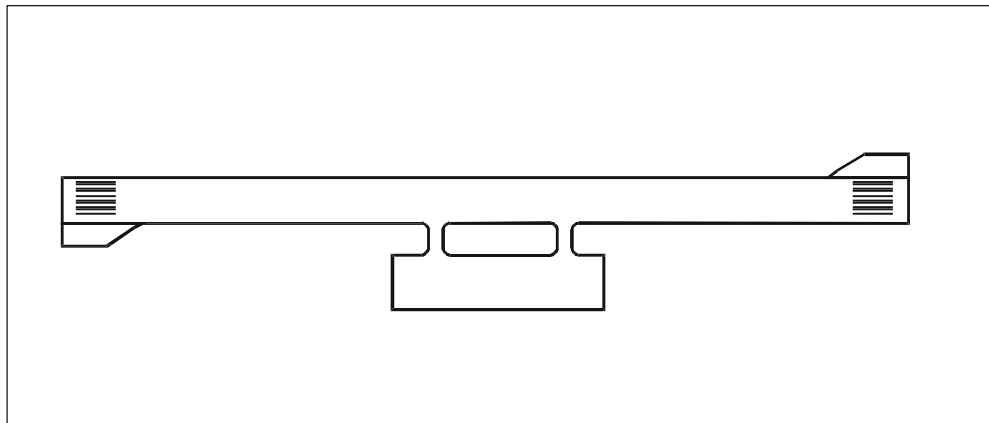

Figure 3-1. Typical turn pad layout

3.3.2 Where the end of a runway is not served by a taxiway or a taxiway turnaround and where the code letter is A, B or C, a runway turn pad should be provided to facilitate a 180-degree turn of aeroplanes.

3.3.3 The runway turn pad may be located on either the left or right side of the runway and adjoining the runway pavement at both ends of the runway and at some intermediate locations where deemed necessary.

3.3.4 The intersection angle of the runway turn pad with the runway shall not exceed 30 degrees.

3.3.5 The nose wheel steering angle to be used in the design of the runway turn pad shall not exceed 45 degrees.



3.3.6 The design of a runway turn pad shall be such that, when the cockpit of the aeroplane for which the turn pad is intended remains over the turn pad marking, the clearance distance between any wheel of the aeroplane landing gear and the edge of the turn pad shall be not less than that given by the following tabulation:

OMGWS				
	Up to but not including 4.5 m	4.5 m up to but not including 6 m	6 m up to but not including 9 m	9 m up to but not including 15 m
Clearance	1.50 m	2.25 m	3 m ^a or 4 m ^b	4 m
<p>^{a.} <i>If the turn pad is intended to be used by aeroplanes with a wheel base less than 18 m.</i></p> <p>^{b.} <i>If the turn pad is intended to be used by aeroplanes with a wheel base equal to or greater than 18 m.</i></p>				

Note: Wheel base means the distance from the nose gear to the geometric centre of the main gear.

Slopes on runway turn pads

3.3.7 The longitudinal and transverse slopes on a runway turn pad should be sufficient to prevent the accumulation of water on the surface and facilitate rapid drainage of surface water. The slopes should be the same as those on the adjacent runway pavement surface.

Strength of runway turn pads

3.3.8 The strength of a runway turn pad shall be at least equal to that of the adjoining runway which it serves, due consideration being given to the fact that the turn pad will be subjected to slow-moving traffic making hard turns and consequent higher stresses on the pavement.

Surface of runway turn pads

3.3.9 The surface of a runway turn pad shall not have surface irregularities that may cause damage to an aeroplane using the turn pad.

3.3.10 The surface of a runway turn pad should be so constructed or resurfaced as to provide surface friction characteristics at least equal to that of the adjoining runway.

Shoulders for runway turn pads

3.3.11 The runway turn pads shall be provided with shoulders of such width as is necessary to prevent surface erosion by the jet blast of the most demanding aeroplane for which the turn pad is intended, and any possible foreign object damage to the aeroplane engines.

3.3.12 The strength of runway turn pad shoulders shall be capable of withstanding the occasional passage of the aeroplane it is designed to serve without inducing structural damage to the aeroplane and to the supporting ground vehicles that may operate on the shoulder.

3.4 Runway strips

General

3.4.1 A runway and any associated stopways shall be included in a strip.

***Length of runway strips***

- 3.4.2 A strip shall extend before the threshold and beyond the end of the runway or stopway for a distance of at least:
- 60 m where the code number is 2, 3 or 4;
 - 60 m where the code number is 1 and the runway is an instrument one; and
 - 30 m where the code number is 1 and the runway is a non-instrument one.

Width of runway strips

- 3.4.3 A strip including a precision approach runway shall, wherever practicable, extend laterally to a distance of at least:
- 140 m where the code number is 3 or 4; and
 - 70 m where the code number is 1 or 2;
- on each side of the centre line of the runway and its extended centre line throughout the length of the strip.
- 3.4.4 A strip including a non-precision approach runway shall extend laterally to a distance of at least:
- 140 m where the code number is 3 or 4; and
 - 70 m where the code number is 1 or 2;
- on each side of the centre line of the runway and its extended centre line throughout the length of the strip.
- 3.4.5 A strip including a non-instrument runway shall extend on each side of the centre line of the runway and its extended centre line throughout the length of the strip, to a distance of at least:
- 75 m where the code number is 3 or 4;
 - 40 m where the code number is 2; and
 - 30 m where the code number is 1.

Objects on runway strips

- 3.4.6 An object situated on a runway strip which may endanger aeroplanes shall be regarded as an obstacle and should, as far as practicable, be removed.
- 3.4.7 No fixed object, other than visual aids required for air navigation or those required for aircraft safety purposes and which must be sited on the runway strip, and satisfying the relevant frangibility requirement in Chapter 5, shall be permitted on any part of a runway strip of a precision approach runway delineated by the lower edges of the inner transitional surfaces:



No mobile object shall be permitted on this part of the runway strip during the use of the runway for landing or take-off.

Grading of runway strips

3.4.8 That portion of a strip of an instrument runway within a distance of at least:

- 75 m where the code number is 3 or 4; and
- 40 m where the code number is 1 or 2;

from the centre line of the runway and its extended centre line should provide a graded area for aeroplanes which the runway is intended to serve in the event of an aeroplane running off the runway.

3.4.9 That portion of a strip of a non-instrument runway within a distance of at least:

- 75 m where the code number is 3 or 4;
- 40 m where the code number is 2; and
- 30 m where the code number is 1;

from the centre line of the runway and its extended centre line shall provide a graded area for aeroplanes which the runway is intended to serve in the event of an aeroplane running off the runway.

3.4.10 The surface of that portion of a strip that abuts a runway, shoulder or stopway shall be flush with the surface of the runway, shoulder or stopway.

3.4.11 That portion of a strip to at least 30 m before the start of a runway shall be prepared against blast erosion in order to protect a landing aeroplane from the danger of an exposed edge.

3.4.12 Where the areas in 3.4.11 have paved surfaces, they shall be able to withstand the occasional passage of the critical aeroplane for runway pavement design.

Slopes on runway strips

3.4.13 Longitudinal slopes

A longitudinal slope along that portion of a strip to be graded shall not exceed:

- 1.5 per cent where the code number is 4;
- 1.75 per cent where the code number is 3; and
- 2 per cent where the code number is 1 or 2.

3.4.14 Longitudinal slope changes

Slope changes on that portion of a strip to be graded shall be as gradual as practicable and abrupt changes or sudden reversals of slopes avoided.

3.4.15 Transverse slopes

Transverse slopes on that portion of a strip to be graded shall be adequate to prevent the accumulation of water on the surface but should not exceed:

- 2.5 per cent where the code number is 3 or 4; and
- 3 per cent where the code number is 1 or 2;

except that to facilitate drainage the slope for the first 3 m outward from the runway, shoulder or stopway edge should be negative as measured in the direction away from the runway and may be as great as 5 per cent.

3.4.16 The transverse slopes of any portion of a strip beyond that to be graded shall not exceed an upward slope of 5 per cent as measured in the direction away from the runway.

Strength of runway strips

3.4.17 That portion of a strip of an instrument runway within a distance of at least:

- 75 m where the code number is 3 or 4; and
- 40 m where the code number is 1 or 2;

from the centre line of the runway and its extended centre line shall be so prepared or constructed as to minimize hazards arising from differences in load-bearing capacity to aeroplanes which the runway is intended to serve in the event of an aeroplane running off the runway.

3.4.18 That portion of a strip containing a non-instrument runway within a distance of at least:

- 75 m where the code number is 3 or 4;
- 40 m where the code number is 2; and
- 30 m where the code number is 1;

from the centre line of the runway and its extended centre line shall be so prepared or constructed as to minimize hazards arising from differences in load-bearing capacity to aeroplanes which the runway is intended to serve in the event of an aeroplane running off the runway.

3.5 Runway end safety areas

General

3.5.1 A runway end safety area shall be provided at each end of a runway strip where:

- the code number is 3 or 4; and
- the code number is 1 or 2 and the runway is an instrument one.

3.5.2 A runway end safety area shall be provided at each end of a runway strip where the code number is 1 or 2 and the runway is a non-instrument one.

Dimensions of runway end safety areas



3.5.3 A runway end safety area shall extend from the end of a runway strip to a distance of at least 90 m where:

- the code number is 3 or 4; and
- the code number is 1 or 2 and the runway is an instrument one.

If an arresting system is installed, the above length may be reduced, based on the design specification of the system, subject to acceptance by the Authority.

3.5.4 A runway end safety area shall, as far as practicable, extend from the end of a runway strip to a distance of at least:

- 240 m where the code number is 3 or 4; or a reduced length when an arresting system is installed;
- 120 m where the code number is 1 or 2 and the runway is an instrument one; or a reduced length when an arresting system is installed; and
- 30 m where the code number is 1 or 2 and the runway is a non-instrument one.

3.5.5 The width of a runway end safety area shall be at least twice that of the associated runway.

3.5.6 The width of a runway end safety area should, wherever practicable, be equal to that of the graded portion of the associated runway strip.

Objects on runway end safety areas

3.5.7 An object situated on a runway end safety area which may endanger aeroplanes shall be regarded as an obstacle and shall, as far as practicable, be removed.

Clearing and grading of runway end safety areas

3.5.8 A runway end safety area shall provide a cleared and graded area for aeroplanes which the runway is intended to serve in the event of an aeroplane undershooting or overrunning the runway.

Slopes on runway end safety areas

3.5.9 General

The slopes of a runway end safety area shall be such that no part of the runway end safety area penetrates the approach or take-off climb surface.

3.5.10 Longitudinal slopes

The longitudinal slopes of a runway end safety area shall not exceed a downward slope of 5 per cent. Longitudinal slope changes should be as gradual as practicable and abrupt changes or sudden reversals of slopes avoided.

3.5.11 Transverse slopes

The transverse slopes of a runway end safety area shall not exceed an upward or downward slope

of 5 per cent. Transitions between differing slopes shall be as gradual as practicable.

Strength of runway end safety areas

3.5.12 A runway end safety area should be so prepared or constructed as to reduce the risk of damage to an aeroplane undershooting or overrunning the runway, enhance aeroplane deceleration and facilitate the movement of rescue and fire-fighting vehicles as required in 9.2.34 to 9.2.36.

3.6 Clearways

Location of clearways

3.6.1 The origin of a clearway should be at the end of the take-off run available.

Length of clearways

3.6.2 The length of a clearway shall not exceed half the length of the take-off run available.

Width of clearways

3.6.3 A clearway shall extend laterally on each side of the extended centre line of the runway, to a distance of at least;

- (a) 75 m for instrument runways; and
- (b) half of the width of the runway strip for non-instrument runways.

Slopes on clearways

3.6.4 The ground in a clearway should not project above a plane having an upward slope of 1.25 per cent, the lower limit of this plane being a horizontal line which:

- (a) is perpendicular to the vertical plane containing the runway centre line; and
- (b) passes through a point located on the runway centre line at the end of the take-off run available.

3.6.5 Abrupt upward changes in slope shall be avoided when the slope on the ground in a clearway is relatively small or when the mean slope is upward. In such situations, in that portion of the clearway within a distance of 22.5 m or half the runway width whichever is greater on each side of the extended centre line, the slopes, slope changes and the transition from runway to clearway shall generally conform with those of the runway with which the clearway is associated.

Objects on clearways

3.6.6 An object situated on a clearway which may endanger aeroplanes in the air shall be regarded as an obstacle and should be removed.

3.7 Stopways

Note.— The inclusion of detailed specifications for stopways in this section is not intended to imply that a stopway has to be provided.

Width of stopways

3.7.1 A stopway shall have the same width as the runway with which it is associated.

Slopes on stopways

3.7.2 Slopes and changes in slope on a stopway, and the transition from a runway to a stopway, shall comply with the specifications of 3.1.13 to 3.1.19 for the runway with which the stopway is associated except that:

- (a) the limitation in 3.1.14 of a 0.8 per cent slope for the first and last quarter of the length of a runway need not be applied to the stopway; and
- (b) at the junction of the stopway and runway and along the stopway the maximum rate of slope change may be 0.3 per cent per 30 m (minimum radius of curvature of 10 000 m) for a runway where the code number is 3 or 4.

Strength of stopways

3.7.3 A stopway shall be prepared or constructed so as to be capable, in the event of an abandoned take-off, of supporting the aeroplane which the stopway is intended to serve without inducing structural damage to the aeroplane.

Surface of stopways

3.7.4 The surface of a paved stopway shall be so constructed or resurfaced as to provide surface friction characteristics at or above those of the associated runway.

3.8 Radio altimeter operating area

General

3.8.1 A radio altimeter operating area should be established in the pre-threshold area of a precision approach runway.

Length of the area

3.8.2 A radio altimeter operating area should extend before the threshold for a distance of at least 300 m.

Width of the area

3.8.3 A radio altimeter operating area should extend laterally, on each side of the extended centre line of the runway, to a distance of 60 m, except that, when special circumstances so warrant, the distance may be reduced to no less than 30 m if an aeronautical study indicates that such reduction would not affect the safety of operations of aircraft.

Longitudinal slope changes

3.8.4 On a radio altimeter operating area, slope changes should be avoided or kept to a minimum. Where slope changes cannot be avoided, the slope changes should be as gradual as practicable and abrupt changes or sudden reversals of slopes avoided. The rate of change between two consecutive slopes should not exceed 2 per cent per 30 m.



3.9 Taxiways

General

- 3.9.1 Taxiways shall be provided to permit the safe and expeditious surface movement of aircraft.
- 3.9.2 Sufficient entrance and exit taxiways for a runway shall be provided to expedite the movement of aeroplanes to and from the runway and provision of rapid exit taxiways considered when traffic volumes are high.
- 3.9.3 The design of a taxiway shall be such that, when the cockpit of the aeroplane for which the taxiway is intended remains over the taxiway centre line markings, the clearance distance between the outer main wheel of the aeroplane and the edge of the taxiway shall be not less than that given by the following tabulation:

OMGWS				
	Up to but not including 4.5 m	4.5 m up to but not including 6 m	6 m up to but not including 9 m	9 m up to but not including 15 m
Clearance	1.50 m	2.25 m	3 m ^{a,b} or 4 m ^c	4 m

- ^{a.} On straight portions.
- ^{b.} On curved portions if the taxiway is intended to be used by aeroplanes with a wheel base of less than 18 m.
- ^{c.} On curved portions if the taxiway is intended to be used by aeroplanes with a wheel base equal to or greater than 18 m.

Note: Wheel base means the distance from the nose gear to the geometric centre of the main gear.

Width of taxiways

- 3.9.4 A straight portion of a taxiway shall have a width of not less than that given by the following tabulation:

OMGWS				
	Up to but not including 4.5 m	4.5 m up to but not including 6 m	6 m up to but not including 9 m	9 m up to but not including 15 m
Taxiway width	7.5 m	10.5 m	15 m	23 m

Taxiway curves

- 3.9.5 Changes in direction of taxiways shall be as few and small as possible. The radii of the curves should be compatible with the manoeuvring capability and normal taxiing speeds of the aeroplanes for which the taxiway is intended. The design of the curve shall be such that, when the cockpit of the aeroplane remains over the taxiway centre line markings, the clearance distance between the outer main wheels of the aeroplane and the edge of the taxiway shall not be less than those specified in 3.9.3.

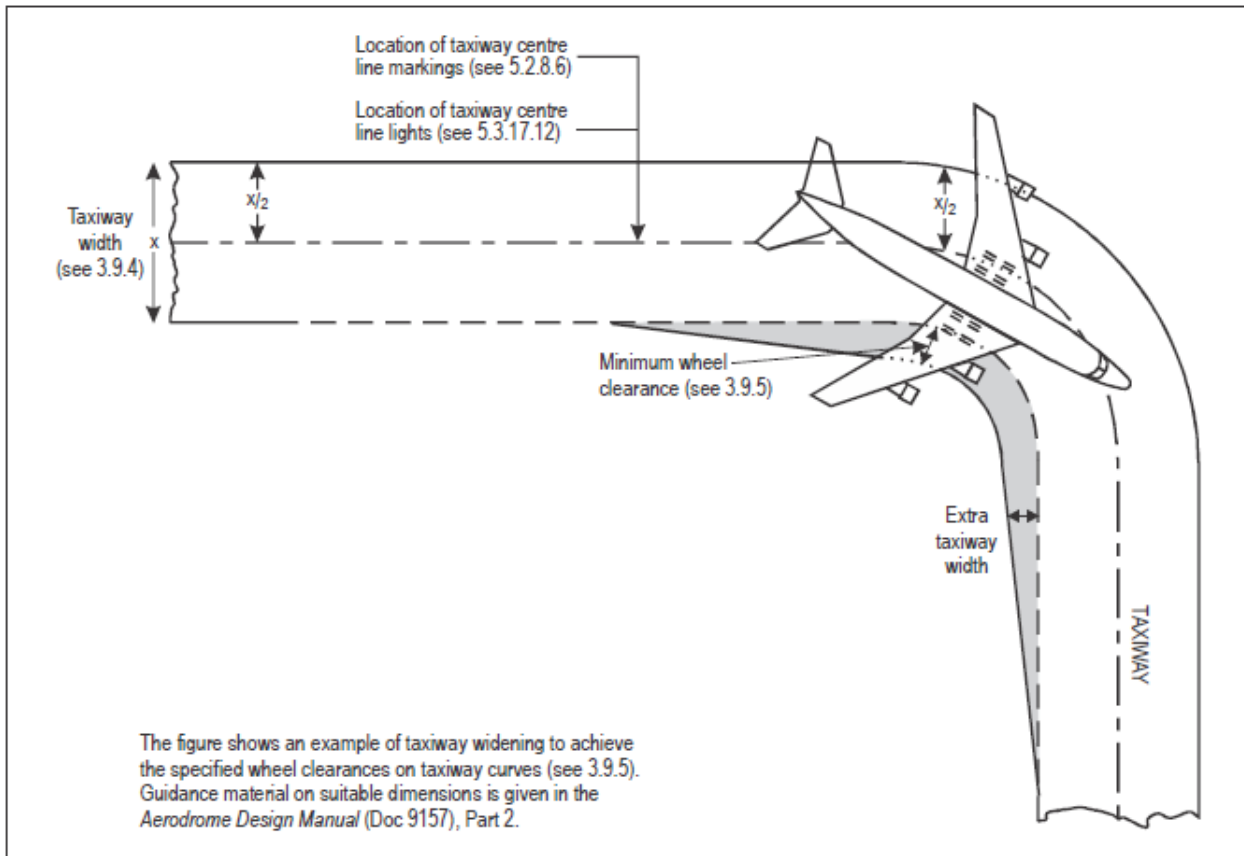

Figure 3-2. Taxiway curve

Junctions and intersections

3.9.6 To facilitate the movement of aeroplanes, fillets should be provided at junctions and intersections of taxiways with runways, aprons and other taxiways. The design of the fillets shall ensure that the minimum wheel clearances specified in 3.9.3 are maintained when aeroplanes are manoeuvring through the junctions or intersections.

Taxiway minimum separation distances

3.9.7 The separation distance between the centre line of a taxiway and the centre line of a runway, the centre line of a parallel taxiway or an object shall not be less than the appropriate dimension specified in Table 3-1, except that it may be permissible to operate with lower separation distances at an existing aerodrome if an aeronautical study indicates that such lower separation distances would not adversely affect the safety or significantly affect the regularity of operations of aeroplanes.

Slopes on taxiways

3.9.8 Longitudinal slopes

The longitudinal slope of a taxiway shall not exceed:

- 1.5 per cent where the code letter is C, D, E or F; and
- 3 per cent where the code letter is A or B.



3.9.9 Longitudinal slope changes

Where slope changes on a taxiway cannot be avoided, the transition from one slope to another slope shall be accomplished by a curved surface with a rate of change not exceeding:

- 1 per cent per 30 m (minimum radius of curvature of 3 000 m) where the code letter is C, D, E or F; and
- 1 per cent per 25 m (minimum radius of curvature of 2 500 m) where the code letter is A or B.

Table 3-1. Taxiway minimum separation distances

<i>Distance between taxiway centreline and runway centreline (metres)</i>												
<i>Code letter</i>	<i>Instrument runways Code number</i>				<i>Non-instrument runways Code number</i>				<i>Taxiway centreline to taxiway centreline (metres)</i>	<i>Taxiway other than aircraft stand taxi lane, centreline to object (metres)</i>	<i>Aircraft stand taxi lane Centreline to aircraft stand taxi lane centreline (metres)</i>	<i>Aircraft stand taxi lane centreline to object (metres)</i>
	<i>1</i>	<i>2</i>	<i>3</i>	<i>4</i>	<i>1</i>	<i>2</i>	<i>3</i>	<i>4</i>				
<i>(1)</i>	<i>(2)</i>	<i>(3)</i>	<i>(4)</i>	<i>(5)</i>	<i>(6)</i>	<i>(7)</i>	<i>(8)</i>	<i>(9)</i>	<i>(10)</i>	<i>(11)</i>	<i>(12)</i>	<i>(13)</i>
<i>A</i>	77.5	77.5	-	-	37.5	47.5	-	-	23	15.5	19.5	12
<i>B</i>	82	82	152	-	42	52	87	-	32	20	28.5	16.5
<i>C</i>	88	88	158	158	48	58	93	93	44	26	40.5	22.5
<i>D</i>	-	-	166	166	-	-	101	101	63	37	59.5	33.5
<i>E</i>	-	-	172.5	172.5	-	-	107.5	107.5	76	43.5	72.5	40
<i>F</i>	-	-	180	180	-	-	115	115	91	51	87.5	47.5

3.9.10 Sight distance

Where a change in slope on a taxiway cannot be avoided, the change shall be such that, from any point:

- 3 m above the taxiway, it will be possible to see the whole surface of the taxiway for a distance of at least 300 m from that point, where the code letter is C, D, E or F;
- 2 m above the taxiway, it will be possible to see the whole surface of the taxiway for a distance of at least 200 m from that point, where the code letter is B; and
- 1.5 m above the taxiway, it will be possible to see the whole surface of the taxiway for a distance of at least 150 m from that point, where the code letter is A.

3.9.11 Transverse slopes

The transverse slopes of a taxiway shall be sufficient to prevent the accumulation of water on the surface of the taxiway but should not exceed:

- 1.5 per cent where the code letter is C, D, E or F; and
- 2 per cent where the code letter is A or B.

Strength of taxiways

3.9.12 The strength of a taxiway shall be at least equal to that of the runway it serves, due consideration being given to the fact that a taxiway will be subjected to a greater density of traffic and, as a result of slow moving and stationary aeroplanes, to higher stresses than the runway it serves.

Surface of taxiways

3.9.13 The surface of a taxiway shall not have irregularities that cause damage to aeroplane structures.

3.9.14 The surface of a paved taxiway shall be so constructed or resurfaced as to provide suitable surface friction characteristics.

Rapid exit taxiways

3.9.15 A rapid exit taxiway shall be designed with a radius of turn-off curve of at least:

- 550 m where the code number is 3 or 4; and
- 275 m where the code number is 1 or 2; to enable exit speeds under wet conditions of:
- 93 km/h where the code number is 3 or 4; and
- 65 km/h where the code number is 1 or 2.

3.9.16 The radius of the fillet on the inside of the curve at a rapid exit taxiway shall be sufficient to provide a widened taxiway throat in order to facilitate early recognition of the entrance and turn-off onto the taxiway.

3.9.17 A rapid exit taxiway shall include a straight distance after the turn-off curve sufficient for an exiting aircraft to come to a full stop clear of any intersecting taxiway.

3.9.18 The intersection angle of a rapid exit taxiway with the runway shall not be greater than 45° nor less than 25° and preferably should be 30°.

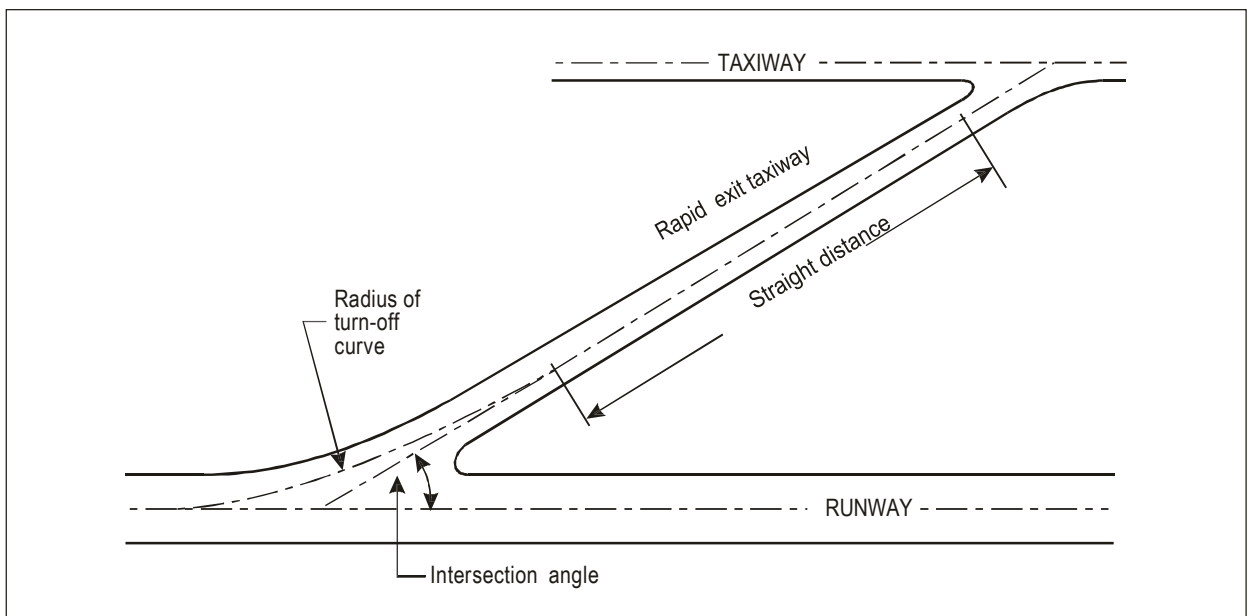

**Figure 3-3. Rapid exit taxiway*****Taxiways on bridges***

- 3.9.19 The width of that portion of a taxiway bridge capable of supporting aeroplanes, as measured perpendicularly to the taxiway centre line, shall not be less than the width of the graded area of the strip provided for that taxiway, unless a proven method of lateral restraint is provided which shall not be hazardous for aeroplanes for which the taxiway is intended.
- 3.9.20 Access should be provided to allow rescue and fire-fighting vehicles to intervene in both directions within the specified response time to the largest aeroplane for which the taxiway bridge is intended.
- 3.9.21 A bridge should be constructed on a straight section of the taxiway with a straight section on both ends of the bridge to facilitate the alignment of aeroplanes approaching the bridge.

3.10 Taxiway shoulders

- 3.10.1 Straight portions of a taxiway where the code letter is C, D, E or F shall be provided with shoulders which extend symmetrically on each side of the taxiway so that the overall width of the taxiway and its shoulders on straight portions is not less than:
- 44 m where the code letter is F;
 - 38 m where the code letter is E;
 - 34 m where the code letter is D; and
 - 25 m where the code letter is C.

On taxiway curves and on junctions or intersections where increased pavement is provided, the shoulder width shall be not less than that on the adjacent straight portions of the taxiway.

- 3.10.2 When a taxiway is intended to be used by turbine-engined aeroplanes, the surface of the taxiway shoulder shall be so prepared as to resist erosion and the ingestion of the surface material by aeroplane engines.

3.11 Taxiway strips***General***

- 3.11.1 A taxiway, other than an aircraft stand taxi lane, shall be included in a strip.

Width of taxiway strips

- 3.11.2 A taxiway strip shall extend symmetrically on each side of the centre line of the taxiway throughout the length of the taxiway to at least the distance from the centre line given in Table 3-1, column 11.

Objects on taxiway strips

- 3.11.3 The taxiway strip shall provide an area clear of objects which may endanger taxiing aeroplanes.



Grading of taxiway strips

3.11.4 The centre portion of a taxiway strip shall provide a graded area to a distance from the centre line of the taxiway of not less than that given by the following tabulation:

- 10.25 m where the OMGWS is up to but not including 4.5 m;
- 11 m where the OMGWS is 4.5 m up to but not including 6 m;
- 12.50 m where the OMGWS is 6 m up to but not including 9 m;
- 18.50 m where the OMGWS is 9 m up to but not including 15 m, where the code letter is D;
- 19 m where the OMGWS is 9 m up to but not including 15 m, where the code letter is E;
- 22 m where the OMGWS is 9 m up to but not including 15 m, where the code letter is F.

Slopes on taxiway strips

3.11.5 The surface of the strip shall be flush at the edge of the taxiway or shoulder, if provided, and the graded portion shall not have an upward transverse slope exceeding:

- 2.5 per cent for strips where the code letter is C, D, E or F; and
- 3 per cent for strips of taxiways where the code letter is A or B;

the upward slope being measured with reference to the transverse slope of the adjacent taxiway surface and not the horizontal. The downward transverse slope shall not exceed 5 per cent measured with reference to the horizontal.

3.11.6 The transverse slopes on any portion of a taxiway strip beyond that to be graded shall not exceed an upward or downward slope of 5 per cent as measured in the direction away from the taxiway.

3.12 Holding bays, runway-holding positions, intermediate holding positions and road-holding positions

General

3.12.1 Holding bay(s) should be provided when the traffic density is medium or heavy.

3.12.2 A runway-holding position or positions shall be established:

- (a) on the taxiway, at the intersection of a taxiway and a runway; and
- (b) at an intersection of a runway with another runway when the former runway is part of a standard taxi-route.

3.12.3 A runway-holding position shall be established on a taxiway if the location or alignment of the taxiway is such that a taxiing aircraft or vehicle can infringe an obstacle limitation surface or interfere with the operation of radio navigation aids.



3.12.4 An intermediate holding position shall be established on a taxiway at any point other than a runway-holding position where it is desirable to define a specific holding limit.

3.12.5 A road-holding position shall be established at an intersection of a road with a runway.

Location

3.12.6 The distance between a holding bay, runway-holding position established at a taxiway/runway intersection or road-holding position and the centre line of a runway shall be in accordance with Table 3-2 and, in the case of a precision approach runway, such that a holding aircraft or vehicle will not interfere with the operation of radio navigation aids or penetrate the inner transitional surface.

3.12.7 At elevations greater than 700 m (2 300 ft) the distance of 90 m specified in Table 3-2 for a precision approach runway code number 4 should be increased as follows:

- (a) up to an elevation of 2 000 m (6 600 ft); 1 m for every 100 m (330 ft) in excess of 700 m (2 300 ft);
- (b) elevation in excess of 2 000 m (6 600 ft) and up to 4 000 m (13 320 ft); 13 m plus 1.5 m for every 100 m (330 ft) in excess of 2 000 m (6 600 ft); and
- (c) elevation in excess of 4 000 m (13 320 ft) and up to 5 000 m (16 650 ft); 43 m plus 2 m for every 100 m (330 ft) in excess of 4 000 m (13 320 ft).

3.12.8 If a holding bay, runway-holding position or road-holding position for a precision approach runway code number 4 is at a greater elevation compared to the threshold, the distance specified in Table 3-2 shall be further increased 5 m for every metre the bay or position is higher than the threshold.

3.12.9 The location of a runway-holding position established in accordance with 3.12.3 shall be such that a holding aircraft or vehicle will not infringe the obstacle free zone, approach surface, take-off climb surface or ILS/MLS critical/ sensitive area or interfere with the operation of radio navigation aids.

Table 3-2. Minimum distance from the runway centre line to a holding bay, runway-holding position or road-holding position

Type of runway	Code number			
	1	2	3	4
Non-instrument	30 m	40 m	75 m	75 m
Non-precision approach	40 m	40 m	75 m	75 m
Precision approach category I	60 m ^b	60 m ^b	90 m ^{a,b}	90 m ^{a,b,c}
Precision approach categories II and III	—	—	90 m ^{a,b}	90 m ^{a,b,c}
Take-off runway	30 m	40 m	75 m	75 m

- a. If a holding bay, runway-holding position or road-holding position is at a lower elevation compared to the threshold, the distance may be decreased 5 m for every metre the bay or holding position is lower than the threshold, contingent upon not infringing the inner transitional surface.
- b. This distance may need to be increased to avoid interference with radio navigation aids, particularly the glide path and localizer facilities.



Information on critical and sensitive areas of ILS and MLS is contained in Annex 10, Volume I, Attachments C and G, respectively (see also 3.12.6).

3.13 Aprons

General

3.13.1 Aprons shall be provided where necessary to permit the on- and off-loading of passengers, cargo or mail as well as the servicing of aircraft without interfering with the aerodrome traffic.

Size of aprons

3.13.2 The total apron area shall be adequate to permit expeditious handling of the aerodrome traffic at its maximum anticipated density.

Strength of aprons

3.13.3 Each part of an apron shall be capable of withstanding the traffic of the aircraft it is intended to serve, due consideration being given to the fact that some portions of the apron will be subjected to a higher density of traffic and, as a result of slow moving or stationary aircraft, to higher stresses than a runway.

Slopes on aprons

3.13.4 Slopes on an apron, including those on an aircraft stand taxi lane, shall be sufficient to prevent accumulation of water on the surface of the apron but shall be kept as level as drainage requirements permit.

3.13.5 On an aircraft stand the maximum slope shall not exceed 1 per cent.

Clearance distances on aircraft stands

3.13.6 An aircraft stand shall provide the following minimum clearances between an aircraft entering or exiting the stand and any adjacent building, aircraft on another stand and other objects:

<i>Code letter</i>	<i>Clearance</i>
A	3 m
B	3 m
C	4.5 m
D	7.5 m
E	7.5 m
F	7.5 m

When special circumstances so warrant, these clearances may be reduced at a nose-in aircraft stand, where the code letter is D, E or F:

- (a) between the terminal, including any fixed passenger bridge, and the nose of an aircraft; and
- (b) over any portion of the stand provided with azimuth guidance by a visual docking guidance system.

3.14 Isolated aircraft parking position



- 3.14.1 An isolated aircraft parking position shall be designated or the aerodrome control tower shall be advised of an area or areas suitable for the parking of an aircraft which is known or believed to be the subject of unlawful interference, or which for other reasons needs isolation from normal aerodrome activities.
- 3.14.2 The isolated aircraft parking position shall be located at the maximum distance practicable and in any case never less than 100 m from other parking positions, buildings or public areas, etc. Care should be taken to ensure that the position is not located over underground utilities such as gas and aviation fuel and, to the extent feasible, electrical or communication cables.

3.15 De-icing/anti-icing facilities

Not applicable



CHAPTER 4

OBSTACLE RESTRICTION AND REMOVAL

4.1 Obstacle limitation surfaces

*Outer horizontal surface**Conical surface*

4.1.1 *Description.*— *Conical surface.* A surface sloping upwards and outwards from the periphery of the inner horizontal surface.

4.1.2 *Characteristics.*— The limits of the conical surface shall comprise:

- (a) a lower edge coincident with the periphery of the inner horizontal surface; and
- (b) an upper edge located at a specified height above the inner horizontal surface.

4.1.3 The slope of the conical surface shall be measured in a vertical plane perpendicular to the periphery of the inner horizontal surface.

Inner horizontal surface

4.1.4 *Description.*— *Inner horizontal surface.* A surface located in a horizontal plane above an aerodrome and its environs.

4.1.5 *Characteristics.*— The radius or outer limits of the inner horizontal surface shall be measured from a reference point or points established for such purpose.

4.1.6 The height of the inner horizontal surface shall be measured above an elevation datum established for such purpose.

Approach surface

4.1.7 *Description.*— *Approach surface.* An inclined plane or combination of planes preceding the threshold.

4.1.8 *Characteristics.*— The limits of the approach surface shall comprise:

- (a) an inner edge of specified length, horizontal and perpendicular to the extended centre line of the runway and located at a specified distance before the threshold;
- (b) two sides originating at the ends of the inner edge and diverging uniformly at a specified rate from the extended centre line of the runway;
- (c) an outer edge parallel to the inner edge; and
- (d) the above surfaces shall be varied when lateral offset, offset or curved approaches are utilized, specifically, two sides originating at the ends of the inner edge and diverging uniformly at a specified rate from the extended centre line of the lateral offset, offset or curved ground track.

- 4.1.9 The elevation of the inner edge shall be equal to the elevation of the midpoint of the threshold.
- 4.1.10 The slope(s) of the approach surface shall be measured in the vertical plane containing the centre line of the runway and shall continue containing the centre line of any lateral offset or curved ground track.

Inner approach surface

4.1.11 *Description.*— *Inner approach surface.* A rectangular portion of the approach surface immediately preceding the threshold.

4.1.12 *Characteristics.*— The limits of the inner approach surface shall comprise:

- (a) an inner edge coincident with the location of the inner edge of the approach surface but of its own specified length;
- (b) two sides originating at the ends of the inner edge and extending parallel to the vertical plane containing the centre line of the runway; and
- (c) an outer edge parallel to the inner edge.

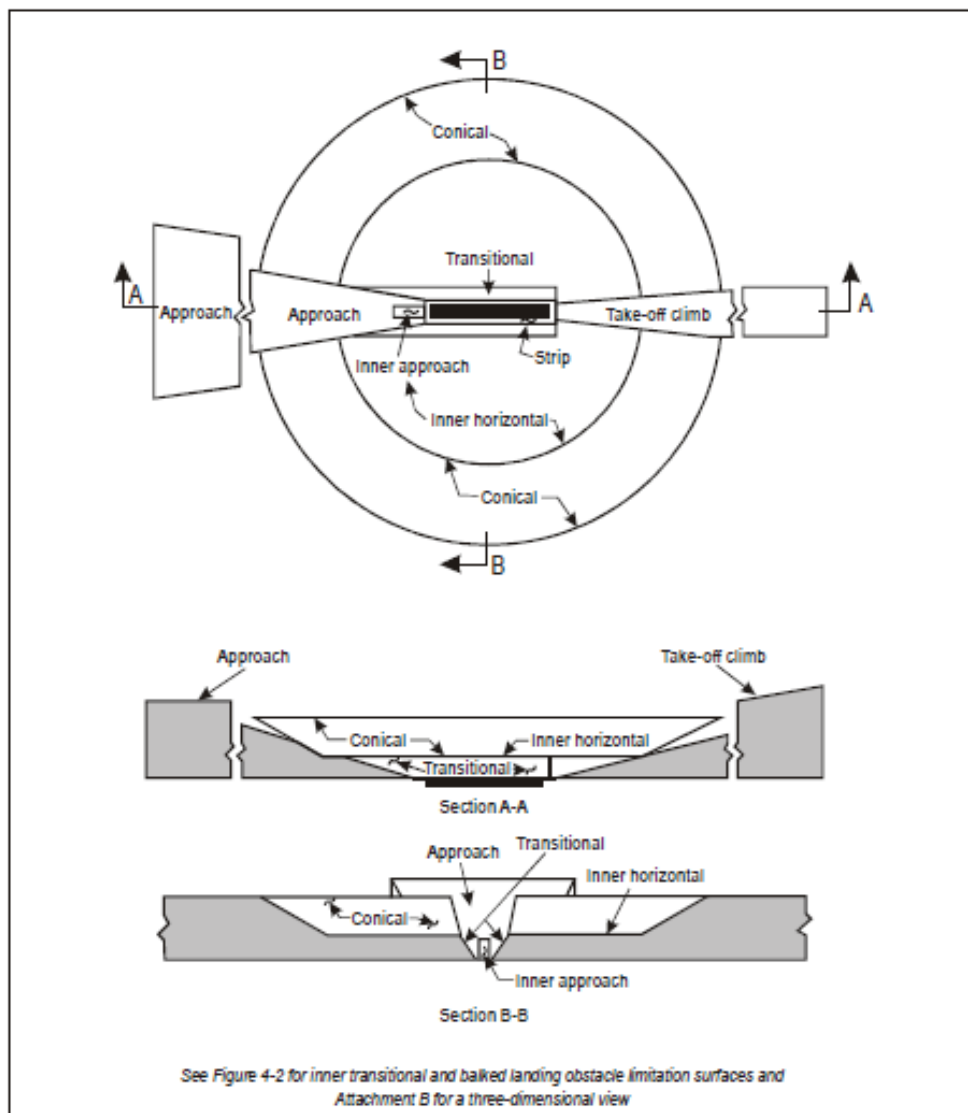

Figure 4-1. Obstacle limitation surfaces

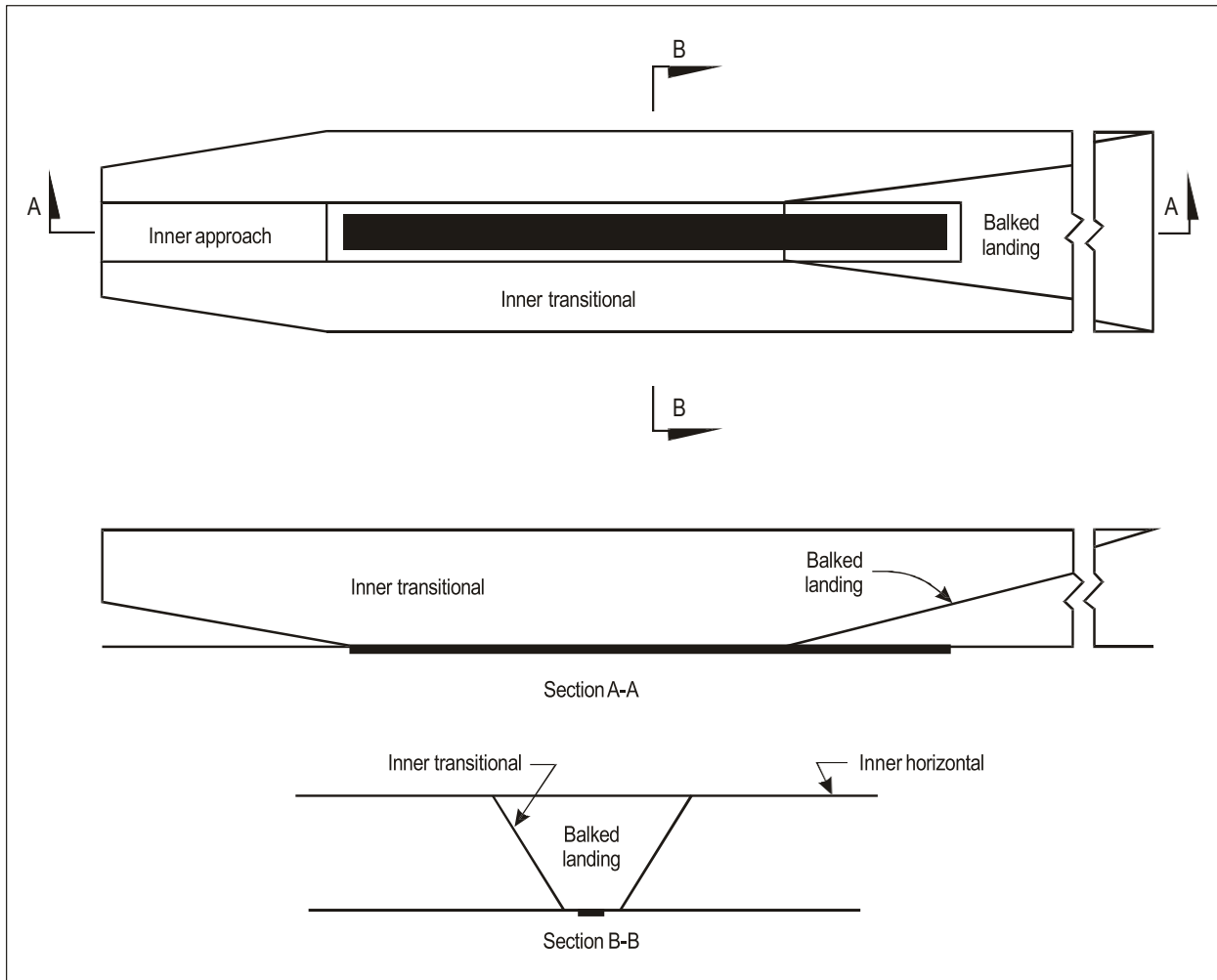

Figure 4-2. Inner approach, inner transitional and balked landing obstacle limitation surfaces

Transitional surface

4.1.13 *Description.*— *Transitional surface.* A complex surface along the side of the strip and part of the side of the approach surface, that slopes upwards and outwards to the inner horizontal surface.

4.1.14 *Characteristics.*— The limits of a transitional surface shall comprise:

- (a) edge located in the plane of the inner horizontal surface.
- (b) a lower edge beginning at the intersection of the side of the approach surface with the inner horizontal surface and extending down the side of the approach surface to the inner edge of the approach surface and from there along the length of the strip parallel to the runway centre line; and an upper

4.1.15 The elevation of a point on the lower edge shall be:

- (a) along the side of the approach surface — equal to the elevation of the approach surface at that point; and
- (b) along the strip — equal to the elevation of the nearest point on the centre line of the runway or its extension.



4.1.16 The slope of the transitional surface shall be measured in a vertical plane at right angles to the centre line of the runway.

Inner transitional surface

4.1.17 *Description.*— *Inner transitional surface.* A surface similar to the transitional surface but closer to the runway.

4.1.18 *Characteristics.*— The limits of an inner transitional surface shall comprise:

- (a) a lower edge beginning at the end of the inner approach surface and extending down the side of the inner approach surface to the inner edge of that surface, from there along the strip parallel to the runway centre line to the inner edge of the balked landing surface and from there up the side of the balked landing surface to the point where the side intersects the inner horizontal surface; and
- (b) an upper edge located in the plane of the inner horizontal surface.

4.1.19 The elevation of a point on the lower edge shall be:

- (a) along the side of the inner approach surface and balked landing surface — equal to the elevation of the particular surface at that point; and
- (b) along the strip — equal to the elevation of the nearest point on the centre line of the runway or its extension.

4.1.20 The slope of the inner transitional surface shall be measured in a vertical plane at right angles to the centre line of the runway.

Balked landing surface

4.1.21 *Description.*— *Balked landing surface.* An inclined plane located at a specified distance after the threshold, extending between the inner transitional surface.

4.1.22 *Characteristics.*— The limits of the balked landing surface shall comprise:

- (a) an inner edge horizontal and perpendicular to the centre line of the runway and located at a specified distance after the threshold;
- (b) two sides originating at the ends of the inner edge and diverging uniformly at a specified rate from the vertical plane containing the centre line of the runway; and
- (c) an outer edge parallel to the inner edge and located in the plane of the inner horizontal surface.

4.1.23 The elevation of the inner edge shall be equal to the elevation of the runway centre line at the location of the inner edge.

4.1.24 The slope of the balked landing surface shall be measured in the vertical plane containing the centre line of the runway.



Take-off climb surface

4.1.25 *Description.*— *Take-off climb surface.* An inclined plane or other specified surface beyond the end of a runway or clearway.

4.1.26 *Characteristics.*— The limits of the take-off climb surface shall comprise:

- (a) an inner edge horizontal and perpendicular to the centre line of the runway and located either at a specified distance beyond the end of the runway or at the end of the clearway when such is provided and its length exceeds the specified distance;
- (b) two sides originating at the ends of the inner edge, diverging uniformly at a specified rate from the take-off track to a specified final width and continuing thereafter at that width for the remainder of the length of the take-off climb surface; and
- (c) an outer edge horizontal and perpendicular to the specified take-off track.

4.1.27 The elevation of the inner edge shall be equal to the highest point on the extended runway centre line between the end of the runway and the inner edge, except that when a clearway is provided the elevation shall be equal to the highest point on the ground on the centre line of the clearway.

4.1.28 In the case of a straight take-off flight path, the slope of the take-off climb surface shall be measured in the vertical plane containing the centre line of the runway.

4.1.29 In the case of a take-off flight path involving a turn, the take-off climb surface shall be a complex surface containing the horizontal normal to its centre line, and the slope of the centre line shall be the same as that for a straight take-off flight path.

4.2 Obstacle limitation requirements

Non-instrument runways

4.2.1 The following obstacle limitation surfaces shall be established for a non-instrument runway:

- conical surface;
- inner horizontal surface;
- approach surface; and
- transitional surfaces.

4.2.2 The heights and slopes of the surfaces shall not be greater than, and their other dimensions not less than, those specified in Table 4-1.

4.2.3 New objects or extensions of existing objects shall not be permitted above an approach or transitional surface except when, in the opinion of the appropriate authority, the new object or extension would be shielded by an existing immovable object.

4.2.4 New objects or extensions of existing objects should not be permitted above the conical surface or inner horizontal surface except when, in the opinion of the Authority, the object would be shielded by an existing immovable object, or after aeronautical study it is determined that the object would not adversely affect the safety or significantly affect the regularity of operations of aeroplanes.



- 4.2.5 Existing objects above any of the surfaces required by 4.2.1 should as far as practicable be removed except when, in the opinion of the appropriate authority, the object is shielded by an existing immovable object, or after aeronautical study it is determined that the object would not adversely affect the safety or significantly affect the regularity of operations of aeroplanes.
- 4.2.6 In considering proposed construction, account should be taken of the possible future development of an instrument runway and consequent requirement for more stringent obstacle limitation surfaces.

Non-precision approach runways

- 4.2.7 The following obstacle limitation surfaces shall be established for a non-precision approach runway:
- conical surface;
 - inner horizontal surface;
 - approach surface; and
 - transitional surfaces.
- 4.2.8 The heights and slopes of the surfaces shall not be greater than, and their other dimensions not less than, those specified in Table 4-1, except in the case of the horizontal section of the approach surface (see 4.2.9).
- 4.2.9 The approach surface shall be horizontal beyond the point at which the 2.5 per cent slope intersects:
- (a) a horizontal plane 150 m above the threshold elevation; or
 - (b) the horizontal plane passing through the top of any object that governs the obstacle clearance altitude/height (OCA/H);

whichever is the higher.



Table 4-1. Dimensions and slopes of obstacle limitation surfaces — Approach runways

Surface and dimensions ^a (1)	RUNWAY CLASSIFICATION										
	Non-instrument Code number				Non-precision approach Code number			Precision approach category I Code number			II or III Code number
	1 (2)	2 (3)	3 (4)	4 (5)	1,2 (6)	3 (7)	4 (8)	1,2 (9)	3,4 (10)	3,4 (11)	
CONICAL											
Slope	5%	5%	5%	5%	5%	5%	5%	5%	5%	5%	
Height	35 m	55 m	75 m	100 m	60 m	75 m	100 m	60 m	100 m	100 m	
INNER HORIZONTAL											
Height	45 m	45 m	45 m	45 m	45 m	45 m	45 m	45 m	45 m	45 m	
Radius	2 000 m	2 500 m	4 000 m	4 000 m	3 500 m	4 000 m	4 000 m	3 500 m	4 000 m	4 000 m	
INNER APPROACH											
Width	—	—	—	—	—	—	—	90 m	120 m ^e	120 m ^e	
Distance from threshold	—	—	—	—	—	—	—	60 m	60 m	60 m	
Length	—	—	—	—	—	—	—	900 m	900 m	900 m	
Slope	—	—	—	—	—	—	—	2.5%	2%	2%	
APPROACH											
Length of inner edge	60 m	80 m	150 m	150 m	140 m	280 m	280 m	140 m	280 m	280 m	
Distance from threshold	30 m	60 m	60 m	60 m	60 m	60 m	60 m	60 m	60 m	60 m	
Divergence (each side)	10%	10%	10%	10%	15%	15%	15%	15%	15%	15%	
First section											
Length	1 600 m	2 500 m	3 000 m	3 000 m	2 500 m	3 000 m	3 000 m	3 000 m	3 000 m	3 000 m	
Slope	5%	4%	3.33%	2.5%	3.33%	2%	2%	2.5%	2%	2%	
Second section											
Length	—	—	—	—	—	3 600 m ^b	3 600 m ^b	12 000 m	3 600 m ^b	3 600 m ^b	
Slope	—	—	—	—	—	2.5%	2.5%	3%	2.5%	2.5%	
Horizontal section											
Length	—	—	—	—	—	8 400 m ^b	8 400 m ^b	—	8 400 m ^b	8 400 m ^b	
Total length	—	—	—	—	—	15 000 m	15 000 m	15 000 m	15 000 m	15 000 m	
TRANSITIONAL											
Slope	20%	20%	14.3%	14.3%	20%	14.3%	14.3%	14.3%	14.3%	14.3%	
INNER TRANSITIONAL											
Slope	—	—	—	—	—	—	—	40%	33.3%	33.3%	
BALKED LANDING SURFACE											
Length of inner edge	—	—	—	—	—	—	—	90 m	120 m ^e	120 m ^e	
Distance from threshold	—	—	—	—	—	—	—	c	1 800 m ^d	1 800 m ^d	
Divergence (each side)	—	—	—	—	—	—	—	10%	10%	10%	
Slope	—	—	—	—	—	—	—	4%	3.33%	3.33%	

a. All dimensions are measured horizontally unless specified otherwise. e. Where the code letter is F (Table 1-1), the width is increased to 140 m except for those aerodromes that accommodate a code letter F aeroplane equipped with digital avionics that provide steering commands to maintain an established track during the go-around manoeuvre.

b. Variable length (see 4.2.9 or 4.2.17).

c. Distance to the end of strip.

d. Or end of runway whichever is less.

Note.— See Circulars 301 and 345, and Chapter 4 of the PANS-Aerodromes, Part I (Doc 9981) for further information.

4.2.10 New objects or extensions of existing objects shall not be permitted above an approach surface within 3 000 m of the inner edge or above a transitional surface except when, in the opinion of the appropriate authority, the new object or extension would be shielded by an existing immovable object.

4.2.11 New objects or extensions of existing objects shall not be permitted above the approach surface beyond 3 000 m from the inner edge, the conical surface or inner horizontal surface except when, in the opinion of the appropriate authority, the object would be shielded by an existing immovable object, or after aeronautical study it is determined that the object would not adversely affect the safety or significantly affect the regularity of operations of aeroplanes.



4.2.12 Existing objects above any of the surfaces required by 4.2.7 should as far as practicable be removed except when, in the opinion of the appropriate authority, the object is shielded by an existing immovable object, or after aeronautical study it is determined that the object would not adversely affect the safety or significantly affect the regularity of operations of aeroplanes.

Precision approach runways

4.2.13 The following obstacle limitation surfaces shall be established for a precision approach runway category I:

- conical surface;
- inner horizontal surface;
- approach surface; and
- transitional surfaces.

4.2.14 The following obstacle limitation surfaces shall be established for a precision approach runway category I:

- inner approach surface;
- inner transitional surfaces; and
- balked landing surface.

4.2.15 The following obstacle limitation surfaces shall be established for a precision approach runway category II or III:

- conical surface;
- inner horizontal surface;
- approach surface and inner approach surface;
- transitional surfaces;
- inner transitional surfaces; and
- balked landing surface.

4.2.16 The heights and slopes of the surfaces shall not be greater than, and their other dimensions not less than, those specified in Table 4-1, except in the case of the horizontal section of the approach surface (see 4.2.17).

4.2.17 The approach surface shall be horizontal beyond the point at which the 2.5 per cent slope intersects:

- (a) a horizontal plane 150 m above the threshold elevation; or
- (b) the horizontal plane passing through the top of any object that governs the obstacle clearance limit; whichever is the higher.



- 4.2.18 Fixed objects shall not be permitted above the inner approach surface, the inner transitional surface or the balked landing surface, except for frangible objects which because of their function must be located on the strip. Mobile objects shall not be permitted above these surfaces during the use of the runway for landing.
- 4.2.19 New objects or extensions of existing objects shall not be permitted above an approach surface or a transitional surface except when, in the opinion of the appropriate authority, the new object or extension would be shielded by an existing immovable object.
- 4.2.20 New objects or extensions of existing objects shall not be permitted above the conical surface and the inner horizontal surface except when, in the opinion of the appropriate authority, an object would be shielded by an existing immovable object, or after aeronautical study it is determined that the object would not adversely affect the safety or significantly affect the regularity of operations of aeroplanes.
- 4.2.21 Existing objects above an approach surface, a transitional surface, the conical surface and inner horizontal surface should as far as practicable be removed except when, in the opinion of the appropriate authority, an object is shielded by an existing immovable object, or after aeronautical study it is determined that the object would not adversely affect the safety or significantly affect the regularity of operations of aeroplanes.

Runways meant for take-off

- 4.2.22 The following obstacle limitation surface shall be established for a runway meant for take-off:
- take-off climb surface.
- 4.2.23 The dimensions of the surface shall be not less than the dimensions specified in Table 4-2, except that a lesser length may be adopted for the take-off climb surface where such lesser length would be consistent with procedural measures adopted to govern the outward flight of aeroplanes.
- 4.2.24 The operational characteristics of aeroplanes for which the runway is intended should be examined to see if it is desirable to reduce the slope specified in Table 4-2 when critical operating conditions are to be catered to. If the specified slope is reduced, corresponding adjustment in the length of the take-off climb surface should be made so as to provide protection to a height of 300 m.
- 4.2.25 New objects or extensions of existing objects shall not be permitted above a take-off climb surface except when, in the opinion of the appropriate authority, the new object or extension would be shielded by an existing immovable object.
- 4.2.26 If no object reaches the 2 per cent (1:50) take-off climb surface, new objects should be limited to preserve the existing obstacle free surface or a surface down to a slope of 1.6 per cent (1:62.5).

**Table 4-2. Dimensions and slopes of obstacle limitation surfaces**

RUNWAYS MEANT FOR TAKE-OFF

Surface and dimensions ^a (1)	Code number		
	1 (2)	2 (3)	3 or 4 (4)
TAKE-OFF CLIMB			
Length of inner edge	60 m	80 m	180 m
Distance from runway end ^b	30 m	60 m	60 m
Divergence (each side)	10%	10%	12.5%
Final width	380 m	580 m	1 200 m 1 800 m ^c
Length	1 600 m	2 500 m	15 000 m
Slope	5%	4%	2% ^d

a. All dimensions are measured horizontally unless specified otherwise.

b. The take-off climb surface starts at the end of the clearway if the clearway length exceeds the specified distance.

c. 1 800 m when the intended track includes changes of heading greater than 15° for operations conducted in IMC, VMC by night.

d. See 4.2.24 and 4.2.26.

4.2.27 Existing objects that extend above a take-off climb surface shall as far as practicable be removed except when, in the opinion of the appropriate authority, an object is shielded by an existing immovable object, or after aeronautical study it is determined that the object would not adversely affect the safety or significantly affect the regularity of operations of aeroplanes.

4.3 Objects outside the obstacle limitation surfaces

4.3.1 Arrangements shall be made to enable the appropriate authority to be consulted concerning proposed construction beyond the limits of the obstacle limitation surfaces that extend above a height established by that authority, in order to permit an aeronautical study of the effect of such construction on the operation of aeroplanes.

4.3.2 In areas beyond the limits of the obstacle limitation surfaces, at least those objects which extend to a height of 150 m or more above ground elevation should be regarded as obstacles, unless a special aeronautical study indicates that they do not constitute a hazard to aeroplanes.

4.4 Other objects

4.4.1 Objects which do not project through the approach surface but which would nevertheless adversely affect the optimum siting or performance of visual or non-visual aids should, as far as practicable, be removed.

4.4.2 Anything which may, in the opinion of the appropriate authority after aeronautical study, endanger aeroplanes on the movement area or in the air within the limits of the inner horizontal and conical surfaces should be regarded as an obstacle and should be removed in so far as practicable.



CHAPTER 5

VISUAL AIDS FOR NAVIGATION

5.1 Indicators and signalling devices

5.1.1 Wind direction indicator

Application

5.1.1.1 An aerodrome shall be equipped with at least one wind direction indicator.

Location

5.1.1.2 A wind direction indicator shall be located so as to be visible from aircraft in flight or on the movement area and in such a way as to be free from the effects of air disturbances caused by nearby objects.

Characteristics

5.1.1.3 The wind direction indicator shall be in the form of a truncated cone made of fabric and should have a length of not less than 3.6 m and a diameter, at the larger end, of not less than 0.9 m. It should be constructed so that it gives a clear indication of the direction of the surface wind and a general indication of the wind speed. The colour or colours should be so selected as to make the wind direction indicator clearly visible and understandable from a height of at least 300 m, having regard to background. Where practicable, a single colour, preferably white or orange, should be used. Where a combination of two colours is required to give adequate conspicuity against changing backgrounds, they should preferably be orange and white, red and white, or black and white, and should be arranged in five alternate bands, the first and last bands being the darker colour.

5.1.1.4 The location of at least one wind direction indicator shall be marked by a circular band 15 m in diameter and 1.2 m wide. The band should be centred about the wind direction indicator support and should be in a colour chosen to give adequate conspicuity, preferably white.

5.1.1.5 Provision shall be made for illuminating at least one wind indicator at an aerodrome intended for use at night.

5.1.2 Landing direction indicator

Location

5.1.2.1 Where provided, a landing direction indicator shall be located in a conspicuous place on the aerodrome.

Characteristics

5.1.2.2 The landing direction indicator should be in the form of a “T”.

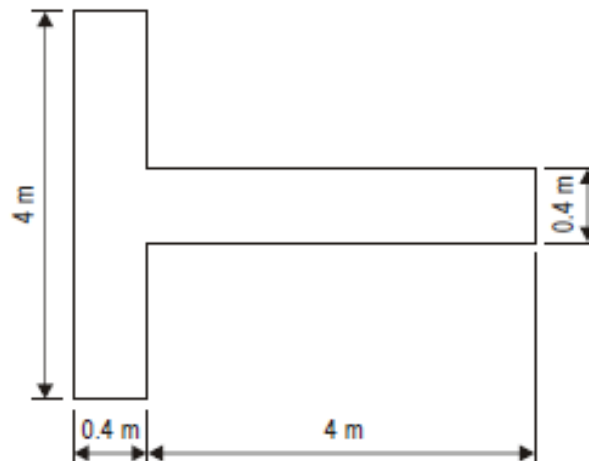

Figure 5-1. Landing direction indicator

5.1.2.3 The shape and minimum dimensions of a landing “T” shall be as shown in Figure 5-1. The colour of the landing “T” shall be either white or orange, the choice being dependent on the colour that contrasts best with the background against which the indicator will be viewed. Where required for use at night the landing “T” shall either be illuminated or outlined by white lights.

5.1.3 Signalling lamp

Application

5.1.3.1 A signalling lamp shall be provided at a controlled aerodrome in the aerodrome control tower.

Characteristics

5.1.3.2 A signalling lamp shall be capable of producing red, green and white signals, and of:

- (a) being aimed manually at any target as required;
- (b) giving a signal in any one colour followed by a signal in either of the two other colours; and
- (c) transmitting a message in any one of the three colours by Morse Code up to a speed of at least four words per minute.

When selecting the green light, use shall be made of the restricted boundary of green as specified in Appendix 1 to ICAO Annex 14, Volume 1, 2.1.2.

5.1.3.3 The beam spread should be not less than 1° nor greater than 3°, with negligible light beyond 3°. When the signalling lamp is intended for use in the daytime the intensity of the coloured light should be not less than 6 000 cd.

5.1.4 Signal panels and signal area

Location of signal area

5.1.4.1 The signal area shall be located so as to be visible for all angles of azimuth above an angle of 10°

above the horizontal when viewed from a height of 300 m.

Characteristics of signal area

5.1.4.2 The signal area shall be an even horizontal surface at least 9 m square.

5.1.4.3 The colour of the signal area should be chosen to contrast with the colours of the signal panels used, and it should be surrounded by a white border not less than 0.3 m wide.

5.2 Markings

5.2.1 General

Interruption of runway markings

5.2.1.1 At an intersection of two (or more) runways the markings of the more important runway, except for the runway side stripe marking, shall be displayed and the markings of the other runway(s) shall be interrupted. The runway side stripe marking of the more important runway may be either continued across the intersection or interrupted.

5.2.1.2 The order of importance of runways for the display of runway markings shall be as follows:

1st — precision approach runway;

2nd — non-precision approach runway; and 3rd — non-instrument runway.

5.2.1.3 At an intersection of a runway and taxiway the markings of the runway shall be displayed and the markings of the taxiway interrupted, except that runway side stripe markings may be interrupted.

Colour and conspicuity

5.2.1.4 Runway markings shall be white.

5.2.1.5 Taxiway markings, runway turn pad markings and aircraft stand markings shall be yellow.

5.2.1.6 Apron safety lines shall be of a conspicuous colour which shall contrast with that used for aircraft stand markings.

5.2.1.7 At aerodromes where operations take place at night, pavement markings shall be made with reflective materials designed to enhance the visibility of the markings.

Unpaved taxiways

5.2.1.8 An unpaved taxiway should be provided, so far as practicable, with the markings prescribed for paved taxiways.

5.2.2 Runway designation marking

Application

5.2.2.1 A runway designation marking shall be provided at the thresholds of a paved runway.

5.2.2.2 A runway designation marking shall be provided, so far as practicable, at the thresholds of an unpaved runway.

Location

5.2.2.3 A runway designation marking shall be located at a threshold as shown in Figure 5-2 as appropriate.

Characteristics

5.2.2.4 A runway designation marking shall consist of a two-digit number and on parallel runways shall be supplemented with a letter. On a single runway, dual parallel runways and triple parallel runways the two-digit number shall be the whole number nearest the one-tenth of the magnetic North when viewed from the direction of approach. On four or more parallel runways, one set of adjacent runways shall be numbered to the nearest one-tenth magnetic azimuth and the other set of adjacent runways numbered to the next nearest one-tenth of the magnetic azimuth. When the above rule would give a single digit number, it shall be preceded by a zero.

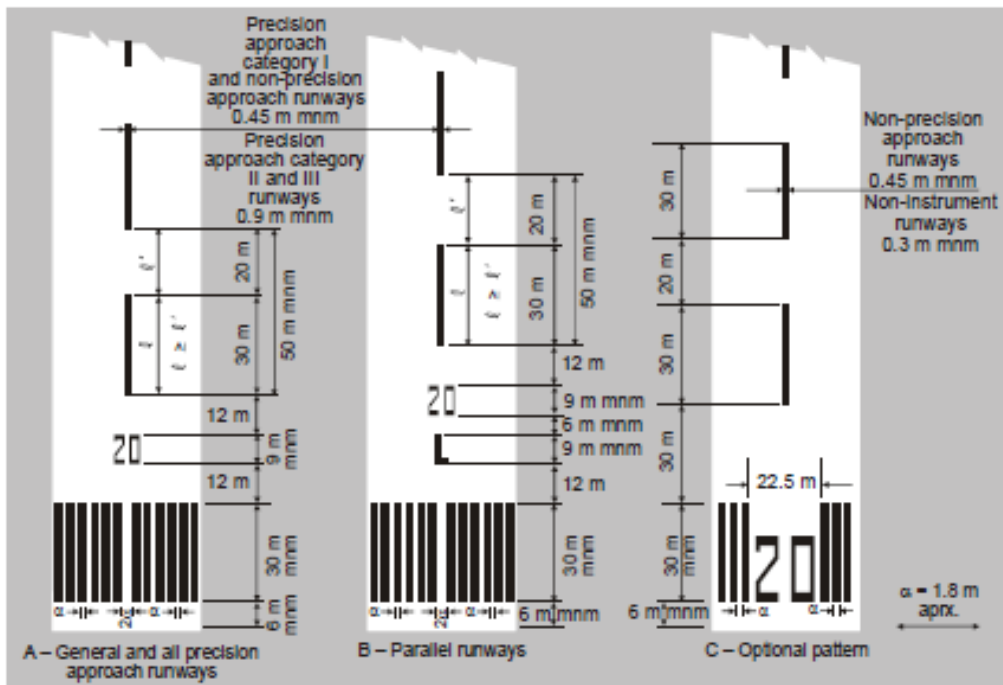

Figure 5-2. Runway designation, centre line and threshold markings

5.2.2.5 In the case of parallel runways, each runway designation number shall be supplemented by a letter as follows, in the order shown from left to right when viewed from the direction of approach:

- for two parallel runways: “L” “R”;
- for three parallel runways: “L” “C” “R”;
- for four parallel runways: “L” “R” “L” “R”;
- for five parallel runways: “L” “C” “R” “L” “R” or “L” “R” “L” “C” “R”;
- for six parallel runways: “L” “C” “R” “L” “C” “R”.

5.2.2.6 The numbers and letters shall be in the form and proportion shown in Figure 5-3. The dimensions shall be not less than those shown in Figure 5-3, but where the numbers are incorporated in the threshold marking, larger dimensions shall be used in order to fill adequately the gap between the

stripes of the threshold marking.

5.2.3 Runway centre line marking

Application

5.2.3.1 A runway centre line marking shall be provided on a paved runway.

Location

5.2.3.2 A runway centre line marking shall be located along the centre line of the runway between the runway designation markings as shown in Figure 5-2, except when interrupted in compliance with 5.2.1.1.

Characteristics

5.2.3.3 A runway centre line marking shall consist of a line of uniformly spaced stripes and gaps. The length of a stripe plus a gap shall be not less than 50 m or more than 75 m. The length of each stripe shall be at least equal to the length of the gap or 30 m, whichever is greater.

5.2.3.4 The width of the stripes shall be not less than:

- 0.90 m on precision approach category II and III runways;
- 0.45 m on non-precision approach runways where the code number is 3 or 4, and precision approach category I runways; and
- 0.30 m on non-precision approach runways where the code number is 1 or 2, and on non-instrument runways.

5.2.4 Threshold marking

Application

5.2.4.1 A threshold marking shall be provided at the threshold of a paved instrument runway, and of a paved non-instrument runway where the code number is 3 or 4 and the runway is intended for use by international commercial air transport.

5.2.4.2 A threshold marking shall be provided at the threshold of a paved non-instrument runway where the code number is 3 or 4 and the runway is intended for use by other than international commercial air transport.

5.2.4.3 A threshold marking should be provided, so far as practicable, at the thresholds of an unpaved runway.

Location

5.2.4.4 The stripes of the threshold marking shall commence 6 m from the threshold.

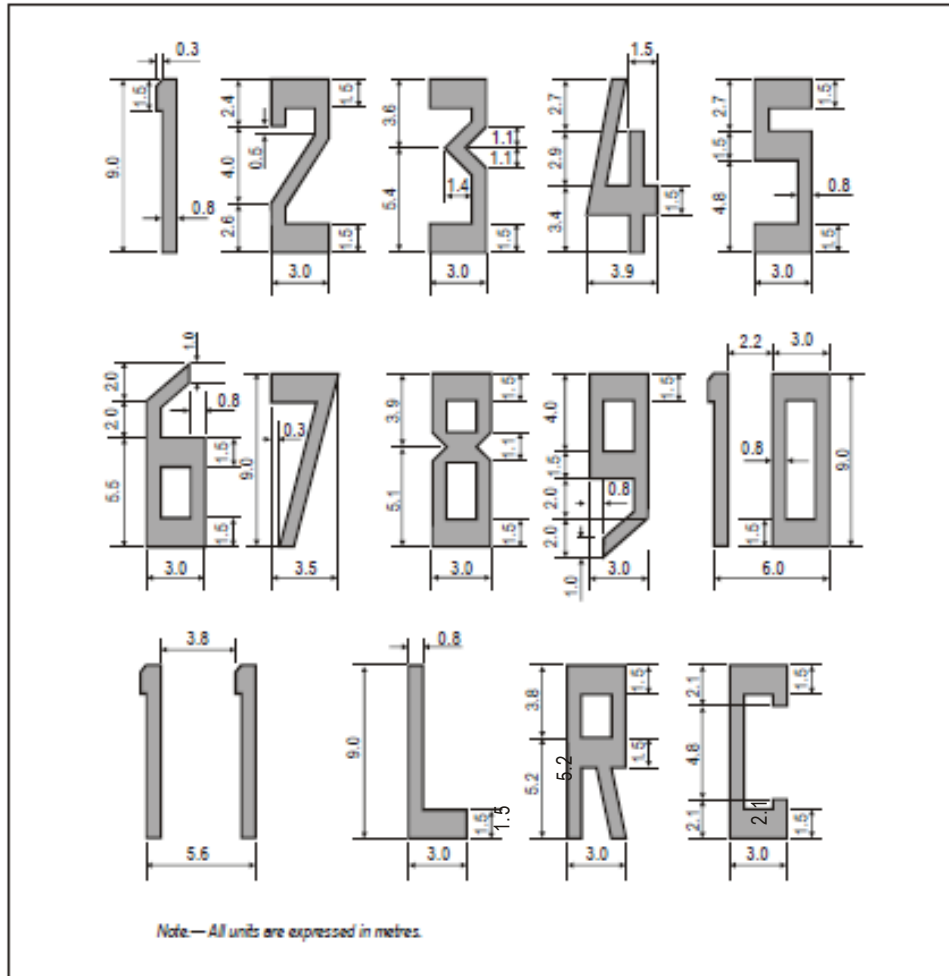

Figure 5-3. Form and proportions of numbers and letters for runway designation markings

Characteristics

5.2.4.5 A runway threshold marking shall consist of a pattern of longitudinal stripes of uniform dimensions disposed symmetrically about the centre line of a runway as shown in Figure 5-2 (A) and (B) for a runway width of 45 m. The number of stripes shall be in accordance with the runway width as follows:

<i>Runway width</i>	<i>Number of stripes</i>
18 m	4
23 m	6
30 m	8
45 m	12
60 m	16

except that on non-precision approach and non-instrument runways 45 m or greater in width, they may be as shown in Figure 5-2 (C).

5.2.4.6 The stripes shall extend laterally to within 3 m of the edge of a runway or to a distance of 27 m on either side of a runway centre line, whichever results in the smaller lateral distance. Where a runway designation marking is placed within a threshold marking there shall be a minimum of three stripes on each side of the centre line of the runway. Where a runway designation marking is placed above a threshold marking, the stripes shall be continued across the runway.

The stripes shall be at least 30 m long and approximately 1.80 m wide with spacings of approximately 1.80 m between them except that, where the stripes are continued across a runway, a double spacing shall be used to separate the two stripes nearest the centre line of the runway, and in the case where the designation marking is included within the threshold marking this spacing shall be 22.5 m.

Transverse stripe

5.2.4.7 Where a threshold is displaced from the extremity of a runway or where the extremity of a runway is not square with the runway centre line, a transverse stripe as shown in Figure 5-4 (B) should be added to the threshold marking.

5.2.4.8 A transverse stripe shall be not less than 1.80 m wide.

Arrows

5.2.4.9 Where a runway threshold is permanently displaced, arrows conforming to Figure 5-4 (B) shall be provided on the portion of the runway before the displaced threshold.

5.2.4.10 When a runway threshold is temporarily displaced from the normal position, it shall be marked as shown in Figure 5-4 (A) or 5-4 (B) and all markings prior to the displaced threshold shall be obscured except the runway centre line marking, which shall be converted to arrows.

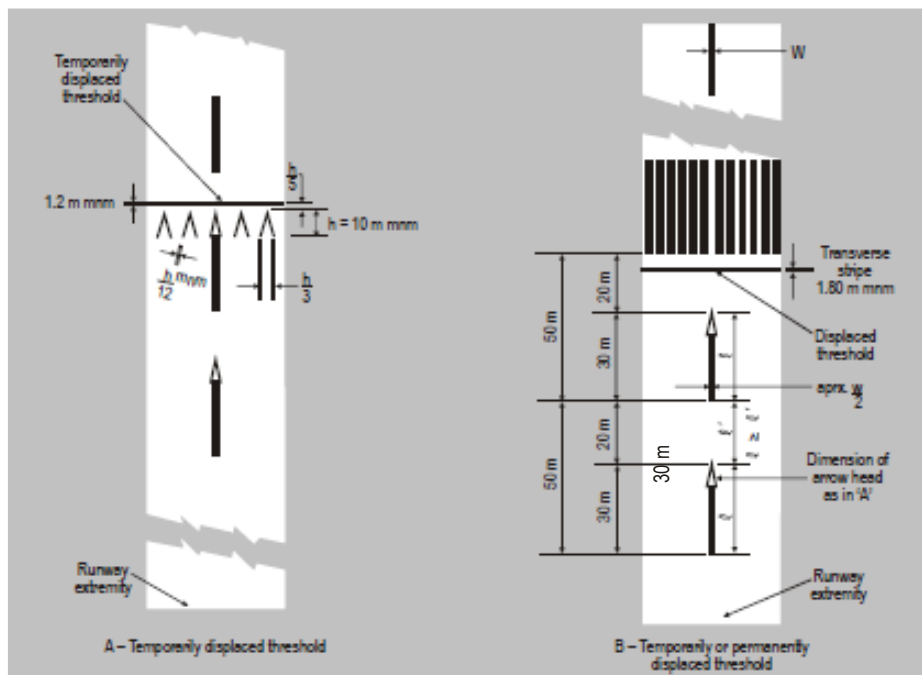

Figure 5-4. Displaced threshold markings

5.2.5 Aiming point marking

Application

5.2.5.1 An aiming point marking shall be provided at each approach end of a paved instrument runway where the code number is 2, 3 or 4.

5.2.5.2 An aiming point marking shall be provided at each approach end of:



- (a) a paved non-instrument runway where the code number is 3 or 4;
- (b) a paved instrument runway where the code number is 1; when additional conspicuity of the aiming point is desirable.

Location

5.2.5.3 The aiming point marking shall commence no closer to the threshold than the distance indicated in the appropriate column of Table 5-1, except that, on a runway equipped with a visual approach slope indicator system, the beginning of the marking shall be coincident with the visual approach slope origin.

5.2.5.4 An aiming point marking shall consist of two conspicuous stripes. The dimensions of the stripes and the lateral spacing between their inner sides shall be in accordance with the provisions of the appropriate column of Table 5-1. Where a touchdown zone marking is provided, the lateral spacing between the markings shall be the same as that of the touchdown zone marking.

5.2.6 Touchdown zone marking

Application

5.2.6.1 A touchdown zone marking shall be provided in the touchdown zone of a paved precision approach runway where the code number is 2, 3 or 4.

5.2.6.2 A touchdown zone marking shall be provided in the touchdown zone of a paved non-precision approach or non-instrument runway where the code number is 3 or 4 and additional conspicuity of the touchdown zone is desirable.

Table 5-1. Location and dimensions of aiming point marking

Location and dimensions (1)	Landing distance available			
	Less than 800 m (2)	800 m up to but not including 1 200 m (3)	1 200 m up to but not including 2 400 m (4)	2 400 m and above (5)
Distance from threshold to beginning of marking	150 m	250 m	300 m	400 m
Length of stripe ^a	30–45 m	30–45 m	45–60 m	45–60 m
Width of stripe	4 m	6 m	6–10 m ^b	6–10 m ^b
Lateral spacing between inner sides of stripes	6 m ^c	9 m ^c	18–22.5 m	18–22.5 m

- a. The greater dimensions of the specified ranges are intended to be used where increased conspicuity is required.
- b. The lateral spacing may be varied within these limits to minimize the contamination of the marking by rubber deposits.
- c. These figures were deduced by reference to the outer main gear wheel span which is element 2 of the aerodrome reference code at Chapter 1, Table 1-1.

Location and characteristics

5.2.6.3 A touchdown zone marking shall consist of pairs of rectangular markings symmetrically disposed about the runway centre line with the number of such pairs related to the landing distance available and, where the marking is to be displayed at both the approach directions of a runway, the distance between the thresholds, as follows:



<i>Landing distance available or the distance between thresholds</i>	<i>Pair(s) of markings</i>
less than 900 m	1
900 m up to but not including 1 200 m	2
1 200 m up to but not including 1 500 m	3
1 500 m up to but not including 2 400 m	4
2 400 m or more	6

5.2.6.4 A touchdown zone marking shall conform to either of the two patterns shown in Figure 5-5. For the pattern shown in Figure 5-5 (A), the markings shall be not less than 22.5 m long and 3 m wide. For the pattern shown in Figure 5-5 (B), each stripe of each marking shall be not less than 22.5 m long and 1.8 m wide with a spacing of 1.5 m between adjacent stripes. The lateral spacing between the inner sides of the rectangles shall be equal to that of the aiming point marking where provided. Where an aiming point marking is not provided, the lateral spacing between the inner sides of the rectangles shall correspond to the lateral spacing specified for the aiming point marking in Table 5-1 (columns 2, 3, 4 or 5, as appropriate). The pairs of markings shall be provided at longitudinal spacings of 150 m beginning from the threshold, except that pairs of touchdown zone markings coincident with or located within 50 m of an aiming point marking shall be deleted from the pattern.

5.2.6.5 On a non-precision approach runway where the code number is 2, an additional pair of touchdown zone marking stripes should be provided 150 m beyond the beginning of the aiming point marking.

5.2.7 Runway side stripe marking

Application

5.2.7.1 A runway side stripe marking shall be provided between the thresholds of a paved runway where there is a lack of contrast between the runway edges and the shoulders or the surrounding terrain.

5.2.7.2 A runway side stripe marking shall be provided on a precision approach runway irrespective of the contrast between the runway edges and the shoulders or the surrounding terrain.

Location

5.2.7.3 A runway side stripe marking shall consist of two stripes, one placed along each edge of the runway with the outer edge of each stripe approximately on the edge of the runway, except that, where the runway is greater than 60 m in width, the stripes should be located 30 m from the runway centre line.

5.2.7.4 Where a runway turn pad is provided, the runway side stripe marking shall be continued between the runway and the runway turn pad.

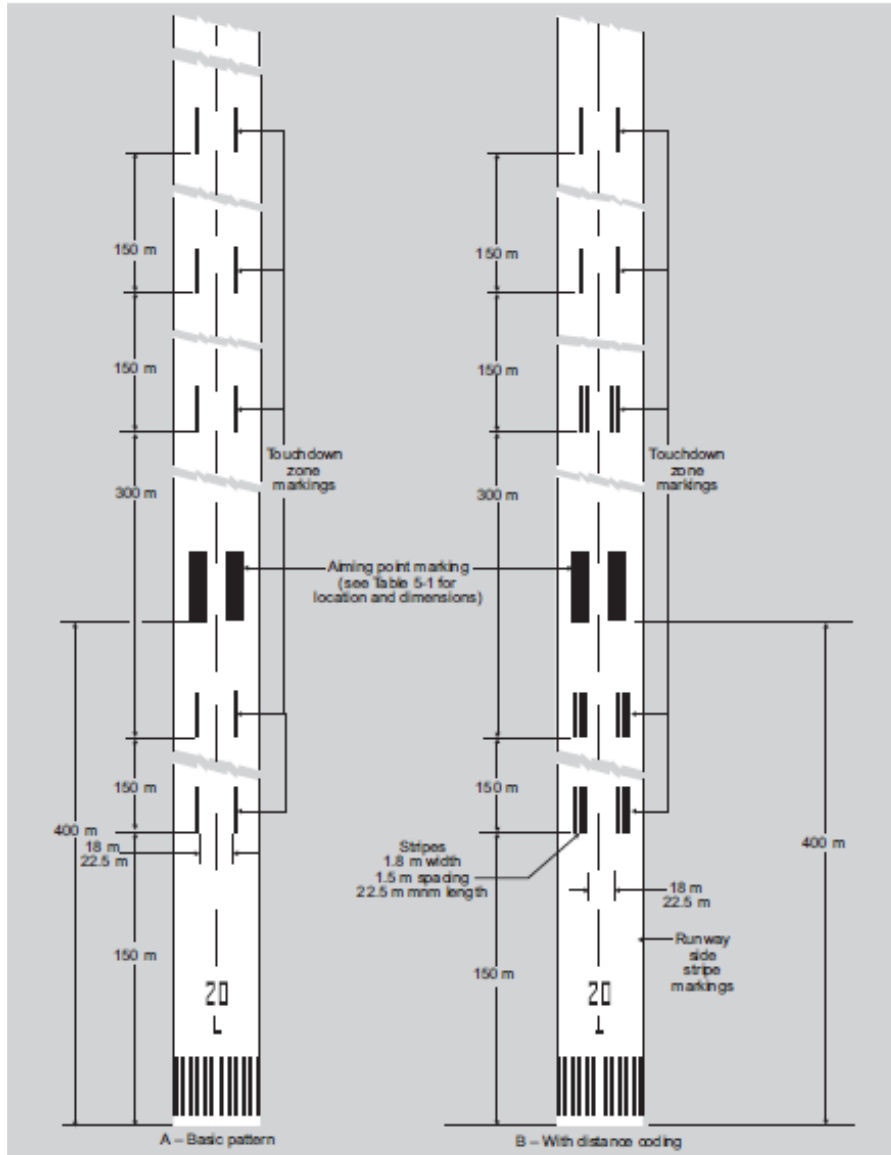

Figure 5-5. Aiming point and touchdown zone markings
(illustrated for a runway with a length of 2 400 m or more)

Characteristics

5.2.7.5 A runway side stripe shall have an overall width of at least 0.9 m on runways 30 m or more in width and at least 0.45 m on narrower runways.

5.2.8 Taxiway centre line marking

Application

5.2.8.1 Taxiway centre line marking shall be provided on a paved taxiway and apron where the code number is 3 or 4 in such a way as to provide continuous guidance between the runway centre line and aircraft stands.

5.2.8.2 Taxiway centre line marking shall be provided on a paved taxiway and apron where the code number is 1 or 2 in such a way as to provide continuous guidance between the runway centre line and aircraft stands.



5.2.8.3 Taxiway centre line marking shall be provided on a paved runway when the runway is part of a standard taxi- route and:

- (a) there is no runway centre line marking; or
- (b) where the taxiway centre line is not coincident with the runway centre line.

5.2.8.4 Where it is necessary to denote the proximity of a runway-holding position, enhanced taxiway centre line marking should be provided.

5.2.8.5 Where provided, enhanced taxiway centre line marking shall be installed at each taxiway/runway intersection.

Location

5.2.8.6 On a straight section of a taxiway the taxiway centre line marking shall be located along the taxiway centre line. On a taxiway curve the marking should continue from the straight portion of the taxiway at a constant distance from the outside edge of the curve.

5.2.8.7 At an intersection of a taxiway with a runway where the taxiway serves as an exit from the runway, the taxiway centre line marking should be curved into the runway centre line marking as shown in Figures 5-6 and 5-26. The taxiway centre line marking should be extended parallel to the runway centre line marking for a distance of at least 60 m beyond the point of tangency where the code number is 3 or 4, and for a distance of at least 30 m where the code number is 1 or 2.

5.2.8.8 Where taxiway centre line marking is provided on a runway in accordance with 5.2.8.3, the marking shall be located on the centre line of the designated taxiway.

5.2.8.9 Where provided:

- (a) An enhanced taxiway centre line marking shall extend from the runway-holding position Pattern A (as defined in Figure 5-6, Taxiway markings) to a distance of up to 47 m in the direction of travel away from the runway. See Figure 5-7 (a).

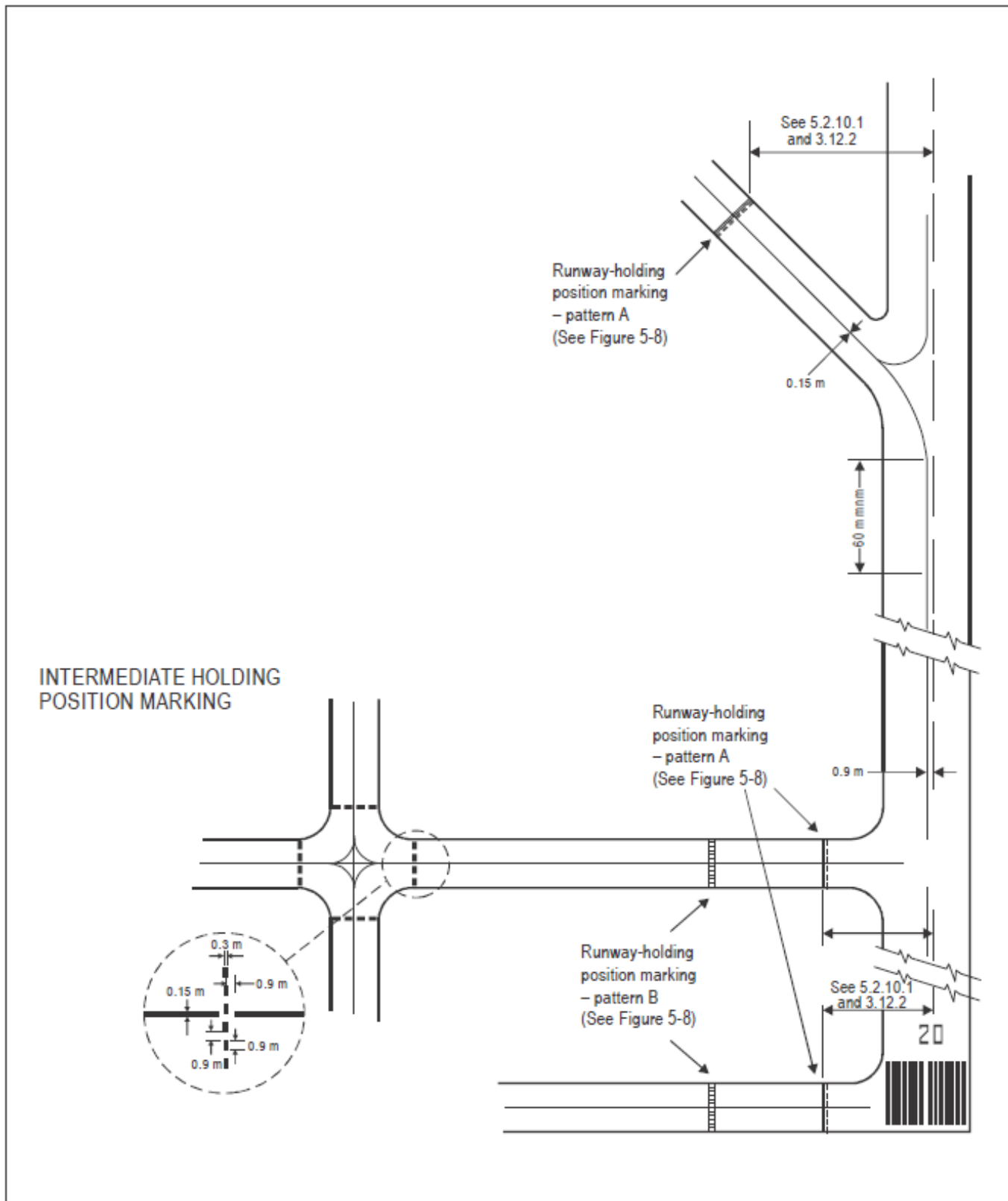

Figure 5-6. Taxiway markings
(shown with basic runway markings)

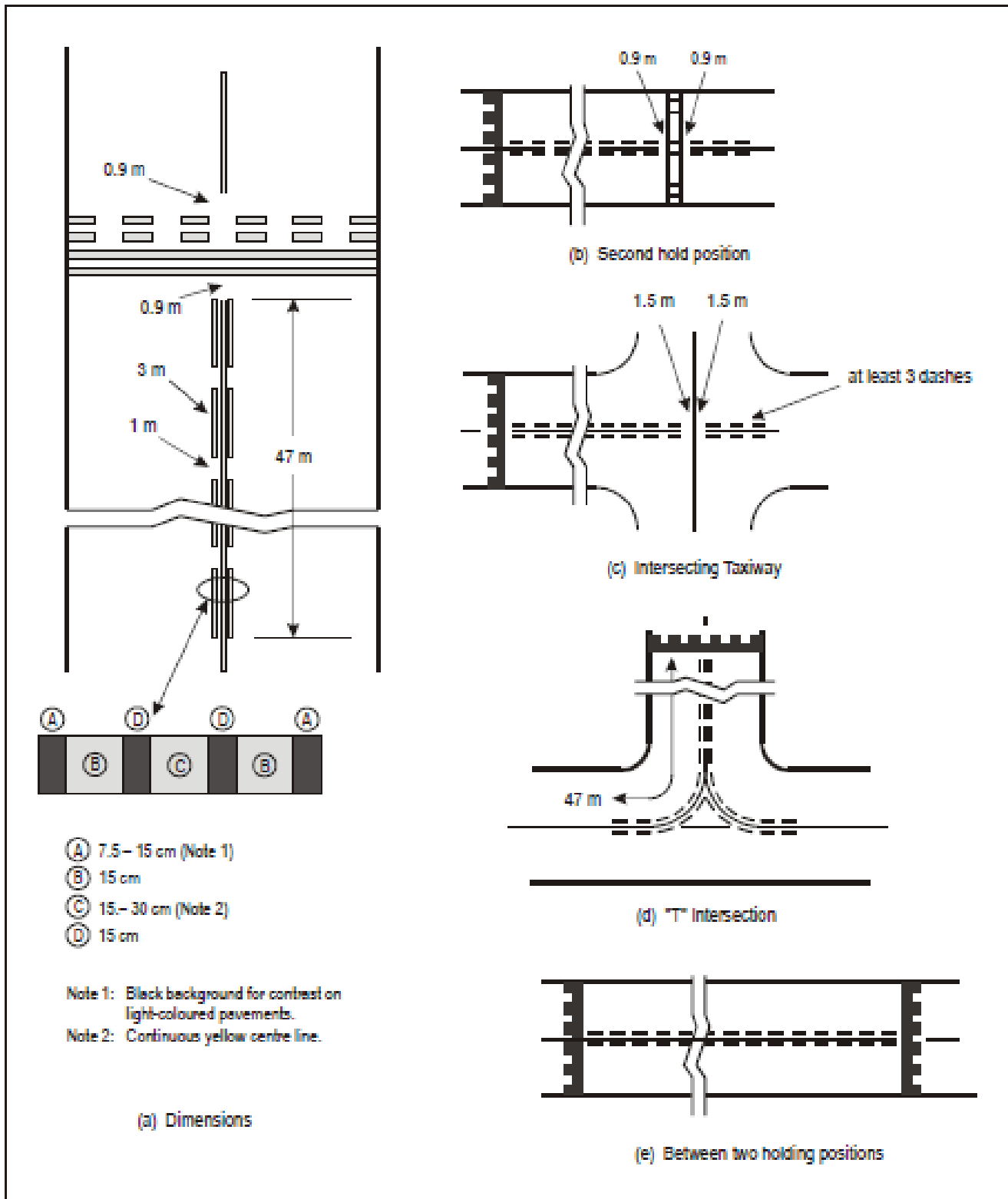

Figure 5-7. Enhanced taxiway centre line marking

- (a) If the enhanced taxiway centre line marking intersects another runway-holding position marking, such as for a precision approach category II or III runway, that is located within 47 m of the first runway-holding position marking, the enhanced taxiway centre line marking shall be interrupted 0.9 m prior to and after the intersected runway-holding position marking. The enhanced taxiway centre line marking shall continue beyond the intersected runway-holding position marking for at least three dashed line segments or 47 m from start to finish, whichever is greater. See Figure 5-7 (b).



- (b) If the enhanced taxiway centre line marking continues through a taxiway/taxiway intersection that is located within 47 m of the runway-holding position marking, the enhanced taxiway centre line marking shall be interrupted 1.5 m prior to and after the point where the intersected taxiway centre line crosses the enhanced taxiway centre line. The enhanced taxiway centre line marking shall continue beyond the taxiway/taxiway intersection for at least three dashed line segments or 47 m from start to finish, whichever is greater. See Figure 5-7 (c).
- (c) Where two taxiway centre lines converge at or before the runway-holding position marking, the inner dashed line shall not be less than 3 m in length. See Figure 5-7 (d).
- (d) Where there are two opposing runway-holding position markings and the distance between the markings is less than 94 m, the enhanced taxiway centre line markings shall extend over this entire distance. The enhanced taxiway centre line markings shall not extend beyond either runway-holding position marking. See Figure 5-7 (e).

Characteristics

5.2.8.10 A taxiway centre line marking shall be at least 15 cm in width and continuous in length except where it intersects with a runway-holding position marking or an intermediate holding position marking as shown in Figure 5-6.

5.2.8.11 Enhanced taxiway centre line marking shall be as shown in Figure 5-7.

5.2.9 Runway turn pad marking

Application

5.2.9.1 Where a runway turn pad is provided, a runway turn pad marking shall be provided for continuous guidance to enable an aeroplane to complete a 180-degree turn and align with the runway centre line.

Location

5.2.9.2 The runway turn pad marking shall be curved from the runway centre line into the turn pad. The radius of the curve should be compatible with the manoeuvring capability and normal taxiing speeds of the aeroplanes for which the runway turn pad is intended. The intersection angle of the runway turn pad marking with the runway centre line shall not be greater than 30 degrees.

5.2.9.3 The runway turn pad marking shall be extended parallel to the runway centre line marking for a distance of at least 60 m beyond the point of tangency where the code number is 3 or 4, and for a distance of at least 30 m where the code number is 1 or 2.

5.2.9.4 A runway turn pad marking shall guide the aeroplane in such a way as to allow a straight portion of taxiing before the point where a 180-degree turn is to be made. The straight portion of the runway turn pad marking shall be parallel to the outer edge of the runway turn pad.

5.2.9.5 The design of the curve allowing the aeroplane to negotiate a 180-degree turn shall be based on a nose wheel steering angle not exceeding 45 degrees.

5.2.9.6 The design of the turn pad marking shall be such that, when the cockpit of the aeroplane remains over the runway turn pad marking, the clearance distance between any wheel of the aeroplane landing gear and the edge of the runway turn pad shall be not less than those specified in 3.3.6.



Characteristics

5.2.9.7 A runway turn pad marking shall be at least 15 cm in width and continuous in length.

5.2.10 Runway-holding position marking

Application and location

5.2.10.1 A runway-holding position marking shall be displayed along a runway-holding position.

Characteristics

5.2.10.2 At an intersection of a taxiway and a non-instrument, non-precision approach or take-off runway, the runway- holding position marking shall be as shown in Figure 5-6, pattern A.

5.2.10.3 Where a single runway-holding position is provided at an intersection of a taxiway and a precision approach category I, II or III runway, the runway-holding position marking shall be as shown in Figure 5-6, pattern A. Where two or three runway-holding positions are provided at such an intersection, the runway-holding position marking closer (closest) to the runway shall be as shown in Figure 5-6, pattern A and the markings farther from the runway shall be as shown in Figure 5-6, pattern B.

5.2.10.4 The runway-holding position marking displayed at a runway-holding position established in accordance with 3.12.3 shall be as shown in Figure 5-6, pattern A.

5.2.10.5 Until 26 November, 2026 the dimensions of the runway-holding position markings shall be as shown in Figure 5-8, pattern A2 or pattern B2, as appropriate.

5.2.10.6 As of 26 November 2026, the dimensions of runway-holding position marking shall be as shown in Figure 5-8, pattern A2 or pattern B2, as appropriate.

5.2.10.7 Where increased conspicuity of the runway-holding position is required, the dimensions of runway-holding position marking shall be as shown in Figure 5-8, pattern A2 or pattern B2, as appropriate.

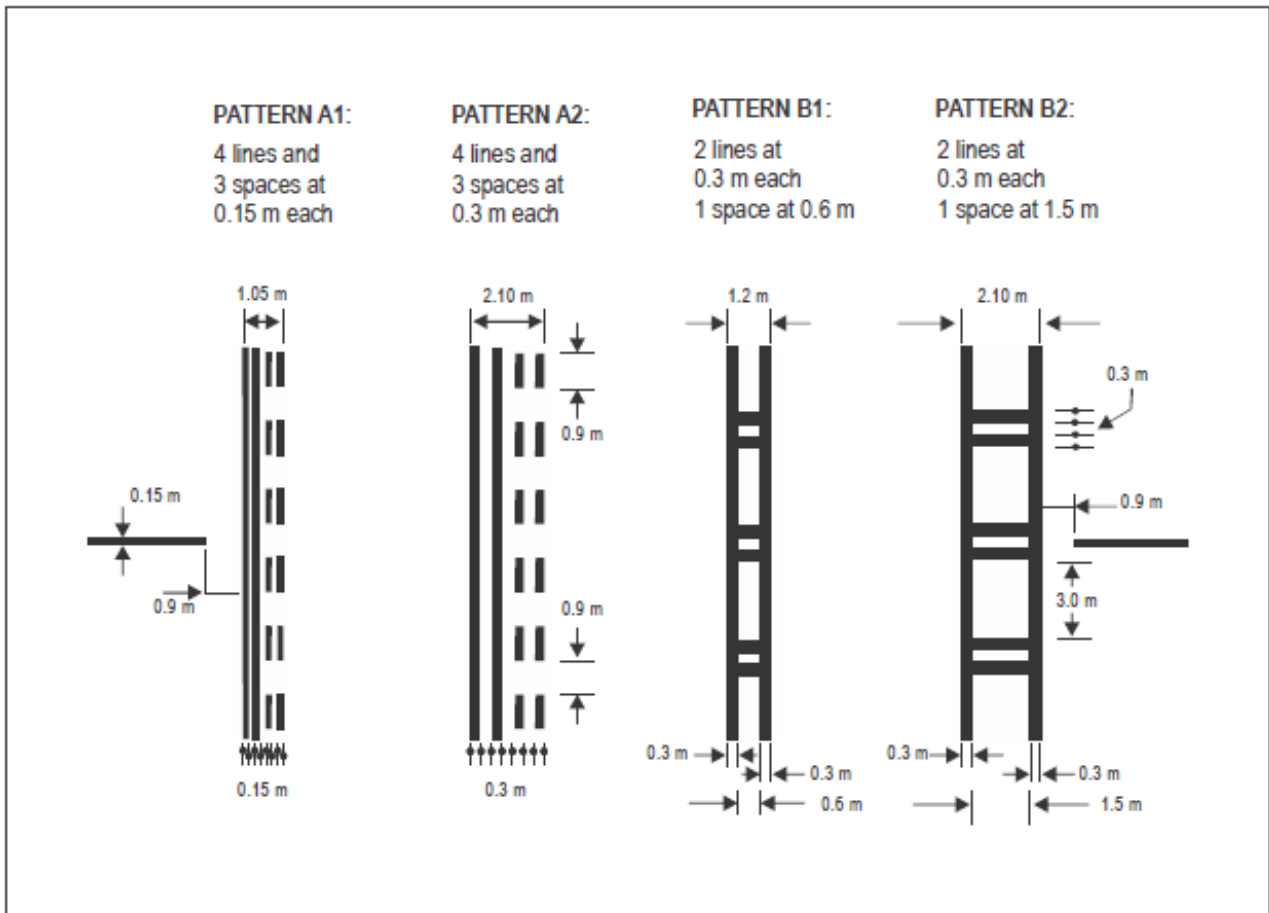

Figure 5-8. Runway-holding position markings

(Note: Patterns A1 and B1 are no longer valid after 2016)

5.2.10.8 Where a pattern B runway-holding position marking is located on an area where it would exceed 60 m in length, the term “CAT II” or “CAT III” as appropriate shall be marked on the surface at the ends of the runway-holding position marking and at equal intervals of 45 m maximum between successive marks. The letters shall be not less than 1.8 m high and shall be placed not more than 0.9 m beyond the holding position marking.

5.2.10.9 The runway-holding position marking displayed at a runway/runway intersection shall be perpendicular to the centre line of the runway forming part of the standard taxi-route. The pattern of the marking shall be as shown in Figure 5-8, pattern A2.

5.2.11 Intermediate holding position marking

Application and location

5.2.11.1 An intermediate holding position marking shall be displayed along an intermediate holding position.

5.2.11.2 An intermediate holding position marking shall be displayed at the exit boundary of a remote facility adjoining a taxiway.

5.2.11.3 Where an intermediate holding position marking is displayed at an intersection of two paved taxiways, it shall be located across the taxiway at sufficient distance from the near edge of the intersecting taxiway to ensure safe clearance between taxiing aircraft. It shall be coincident with a stop bar or intermediate holding position lights, where provided.

5.2.11.4 The distance between an intermediate holding position marking at the exit boundary of a facility and the centre line of the adjoining taxiway shall not be less than the dimension specified in Table 3-1, column 11.

Characteristics

5.2.11.5 An intermediate holding position marking shall consist of a single broken line as shown in Figure 5-6.

5.2.12 VOR aerodrome checkpoint marking

Application

5.2.12.1 When a VOR aerodrome checkpoint is established, it shall be indicated by a VOR aerodrome checkpoint marking and sign.

5.2.12.2 *Site selection*

Location

5.2.12.3 A VOR aerodrome checkpoint marking shall be centred on the spot at which an aircraft is to be parked to receive the correct VOR signal.

Characteristics

5.2.12.4 A VOR aerodrome checkpoint marking shall consist of a circle 6 m in diameter and have a line width of 15 cm (see Figure 5-9 (A)).

5.2.12.5 When it is preferable for an aircraft to be aligned in a specific direction, a line shall be provided that passes through the centre of the circle on the desired azimuth. The line should extend 6 m outside the circle in the desired direction of heading and terminate in an arrowhead. The width of the line should be 15 cm (see Figure 5-9 (B)).

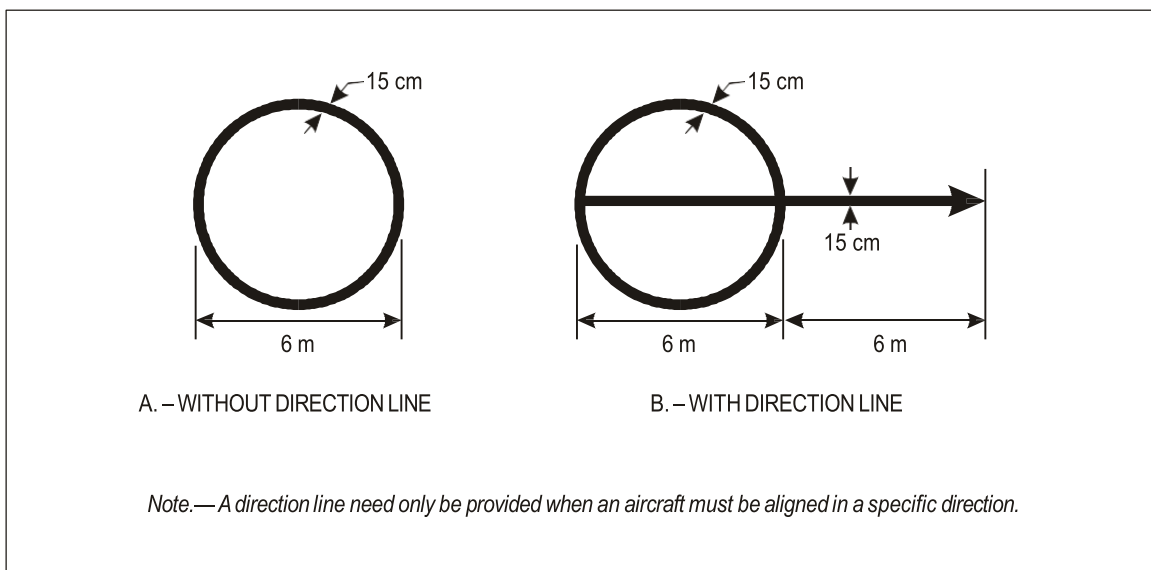

Figure 5-9. VOR aerodrome checkpoint marking



5.2.12.6 A VOR aerodrome checkpoint marking shall be white in colour but should differ from the colour used for the taxiway markings.

5.2.13 Aircraft stand marking

Application

5.2.13.1 Aircraft stand markings shall be provided for designated parking positions on a paved apron.

Location

5.2.13.2 Aircraft stand markings on a paved apron shall be located so as to provide the clearances specified in 3.13.6 and in 3.15.9, respectively, when the nose wheel follows the stand marking.

Characteristics

5.2.13.3 Aircraft stand markings shall include such elements as stand identification, lead-in line, turn bar, turning line, alignment bar, stop line and lead-out line, as are required by the parking configuration and to complement other parking aids.

5.2.13.4 An aircraft stand identification (letter and/or number) shall be included in the lead-in line a short distance after the beginning of the lead-in line. The height of the identification should be adequate to be readable from the cockpit of aircraft using the stand.

5.2.13.5 Where two sets of aircraft stand markings are superimposed on each other in order to permit more flexible use of the apron and it is difficult to identify which stand marking should be followed, or safety would be impaired if the wrong marking was followed, then identification of the aircraft for which each set of markings is intended shall be added to the stand identification.

5.2.13.6 Lead-in, turning and lead-out lines shall normally be continuous in length and have a width of not less than 15 cm. Where one or more sets of stand markings are superimposed on a stand marking, the lines should be continuous for the most demanding aircraft and broken for other aircraft.

5.2.13.7 The curved portions of lead-in, turning and lead-out lines shall have radii appropriate to the most demanding aircraft type for which the markings are intended.

5.2.13.8 Where it is intended that an aircraft proceed in one direction only, arrows pointing in the direction to be followed shall be added as part of the lead-in and lead-out lines.

5.2.13.9 A turn bar shall be located at right angles to the lead-in line, abeam the left pilot position at the point of initiation of any intended turn. It should have a length and width of not less than 6 m and 15 cm, respectively, and include an arrowhead to indicate the direction of turn.

5.2.13.10 If more than one turn bar and/or stop line is required, they shall be coded.

5.2.13.11 An alignment bar shall be placed so as to be coincident with the extended centre line of the aircraft in the specified parking position and visible to the pilot during the final part of the parking manoeuvre. It should have a width of not less than 15 cm.



5.2.13.12 A stop line shall be located at right angles to the alignment bar, abeam the left pilot position at the intended point of stop. It should have a length and width of not less than 6 m and 15 cm, respectively.

5.2.14 Apron safety lines

Application

5.2.14.1 Apron safety lines shall be provided on a paved apron as required by the parking configurations and ground facilities.

Location

5.2.14.2 Apron safety lines shall be located so as to define the areas intended for use by ground vehicles and other aircraft servicing equipment, etc., to provide safe separation from aircraft.

Characteristics

5.2.14.3 Apron safety lines shall include such elements as wing tip clearance lines and service road boundary lines as required by the parking configurations and ground facilities.

5.2.14.4 An apron safety line shall be continuous in length and at least 10 cm in width.

5.2.15 Road-holding position marking

Application

5.2.15.1 A road-holding position marking shall be provided at all road entrances to a runway.

Location

5.2.15.2 The road-holding position marking shall be located across the road at the holding position.

Characteristics

5.2.15.3 The road-holding position marking shall be in accordance with the local road traffic regulations.

5.2.16 Mandatory instruction marking

Application

5.2.16.1 Where it is impracticable to install a mandatory instruction sign in accordance with 5.4.2.1, a mandatory instruction marking shall be provided on the surface of the pavement.

5.2.16.2 Where operationally required, such as on taxiways exceeding 60 m in width, or to assist in the prevention of a runway incursion, a mandatory instruction sign should be supplemented by a mandatory instruction marking.

Location

5.2.16.3 The mandatory instruction marking on taxiways where the code letter is A, B, C or D shall be located across the taxiway equally placed about the taxiway centre line and on the holding side

of the runway-holding position marking as shown in Figure 5-10 (A). The distance between the nearest edge of the marking and the runway-holding position marking or the taxiway centre line marking shall be not less than 1 m.

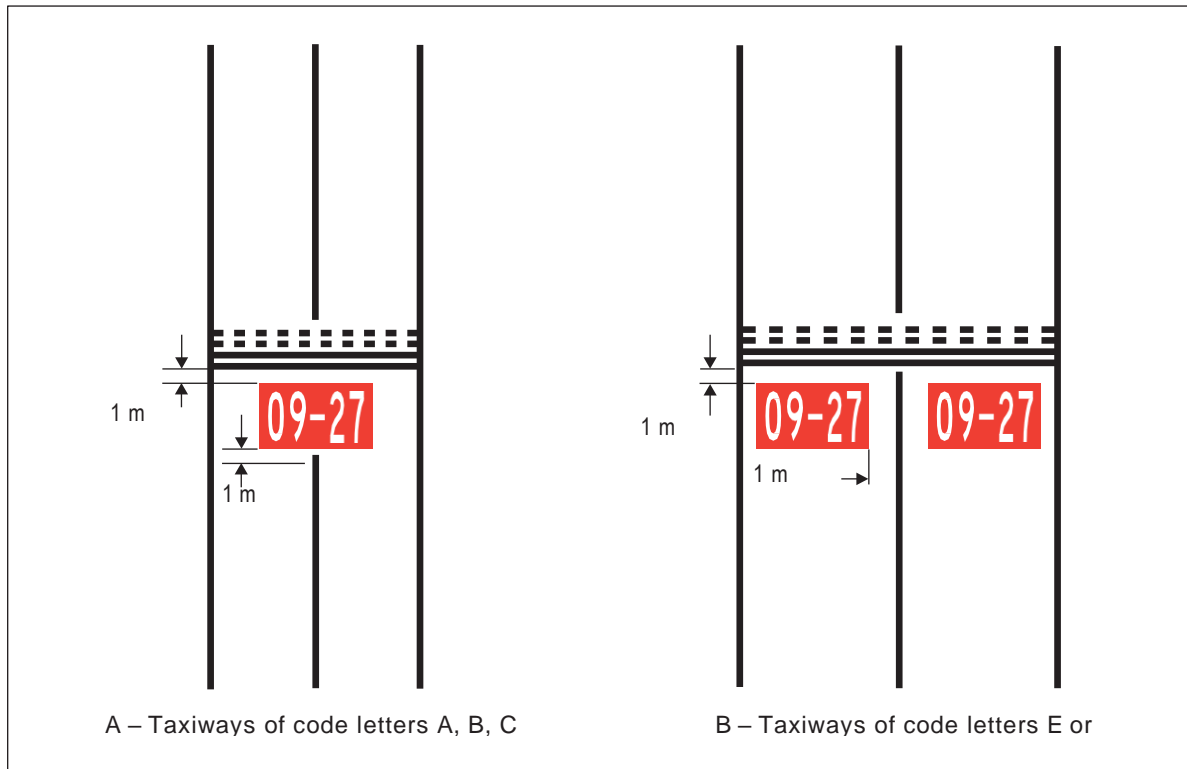

Figure 5-10. Mandatory instruction marking

5.2.16.4 The mandatory instruction marking on taxiways where the code letter is E or F shall be located on both sides of the taxiway centre line marking and on the holding side of the runway-holding position marking as shown in Figure 5-10 (B). The distance between the nearest edge of the marking and the runway-holding position marking or the taxiway centre line marking shall be not less than 1 m.

5.2.16.5 Except where operationally required, a mandatory instruction marking should not be located on a runway.

Characteristics

5.2.16.6 A mandatory instruction marking shall consist of an inscription in white on a red background. Except for a NO ENTRY marking, the inscription shall provide information identical to that of the associated mandatory instruction sign.

5.2.16.7 A NO ENTRY marking shall consist of an inscription in white reading NO ENTRY on a red background.

5.2.16.8 Where there is insufficient contrast between the marking and the pavement surface, the mandatory instruction marking shall include an appropriate border, preferably white or black.

5.2.16.9 The character height shall be 4 m for inscriptions where the code letter is C, D, E or F, and 2 m where the code letter is A or B. The inscriptions should be in the form and proportions shown in Appendix 3 to ICAO Annex 14, Volume 1.



5.2.16.10 The background shall be rectangular and extend a minimum of 0.5 m laterally and vertically beyond the extremities of the inscription.

5.2.17 Information marking

Application

5.2.17.1 Where an information sign would normally be installed and is impractical to install, as determined by the appropriate authority, an information marking shall be displayed on the surface of the pavement.

5.2.17.2 Where operationally required an information sign shall be supplemented by an information marking.

5.2.17.3 An information (location/direction) marking shall be displayed prior to and following complex taxiway intersections and where operational experience has indicated the addition of a taxiway location marking could assist flight crew ground navigation.

5.2.17.4 An information (location) marking shall be displayed on the pavement surface at regular intervals along taxiways of great length.

Location

5.2.17.5 The information marking shall be displayed across the surface of the taxiway or apron where necessary and positioned so as to be legible from the cockpit of an approaching aircraft.

Characteristics

5.2.17.6 An information marking shall consist of:

- (a) an inscription in yellow upon a black background, when it replaces or supplements a location sign; and
- (b) an inscription in black upon a yellow background, when it replaces or supplements a direction or destination sign.

5.2.17.7 Where there is insufficient contrast between the marking background and the pavement surface, the marking shall include:

- (a) a black border where the inscriptions are in black; and
- (b) a yellow border where the inscriptions are in yellow.

5.2.17.8 The character height shall be 4 m. The inscriptions should be in the form and proportions shown in Appendix 3 to ICAO Annex 14, Volume 1.

5.3 Lights

5.3.1 General

Lights which may endanger the safety of aircraft

5.3.1.1 A non-aeronautical ground light near an aerodrome which might endanger the safety of aircraft

shall be extinguished, screened or otherwise modified so as to eliminate the source of danger.

Laser emissions which may endanger the safety of aircraft

5.3.1.2 To protect the safety of aircraft against the hazardous effects of laser emitters, the following protected zones should be established around aerodromes:

- a laser-beam free flight zone (LFFZ)
- a laser-beam critical flight zone (LCFZ)
- a laser-beam sensitive flight zone (LSFZ).

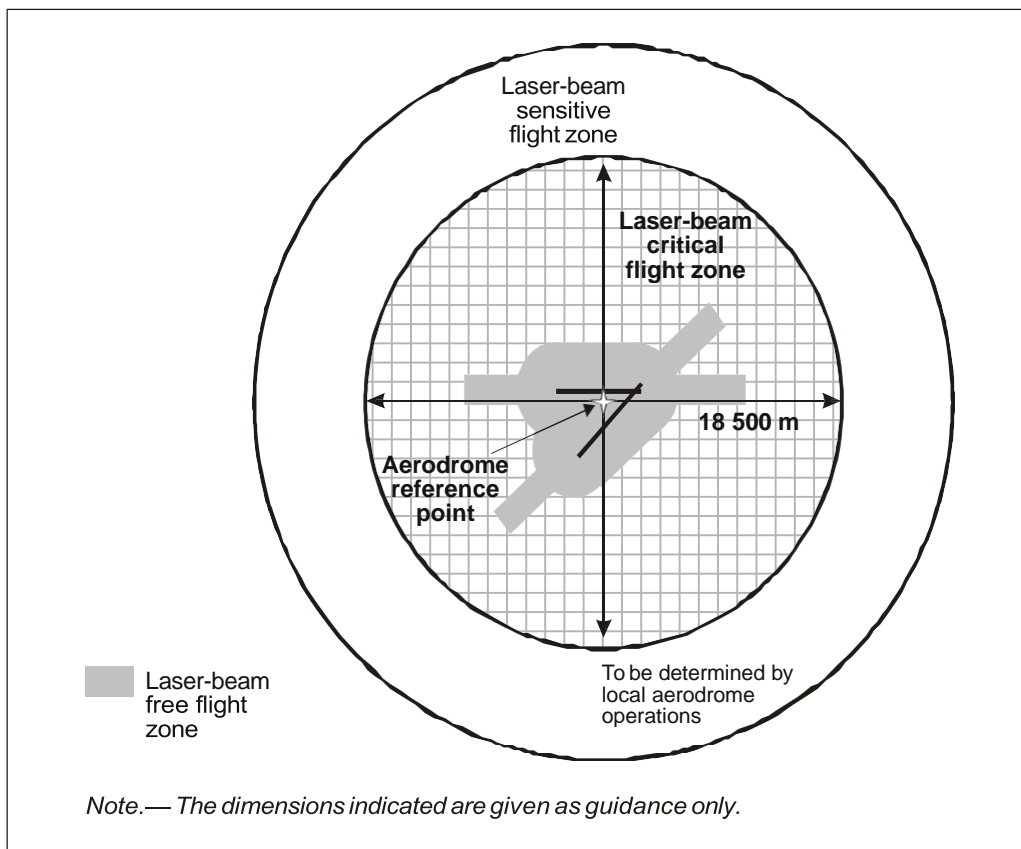

Figure 5-11. Protected flight zones

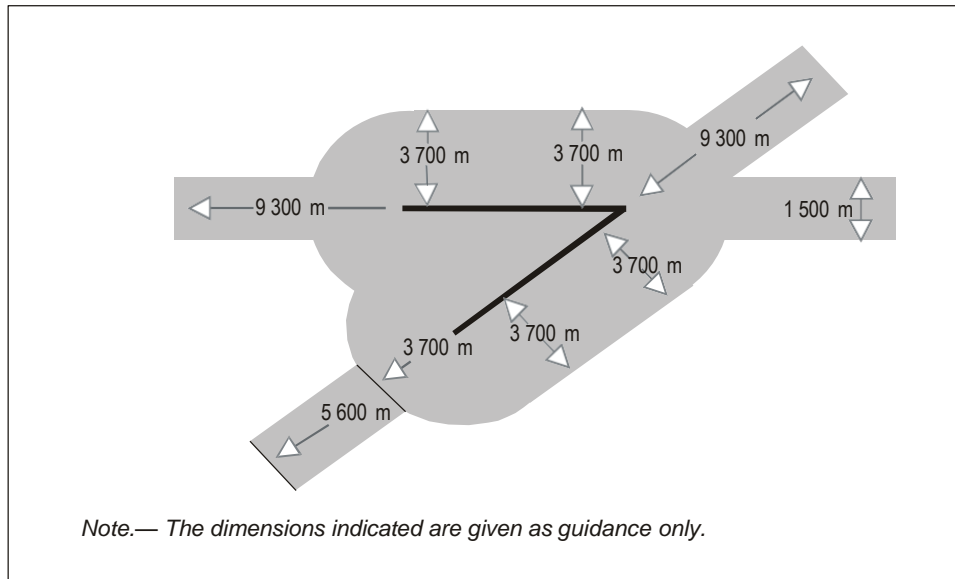

Figure 5-12. Multiple runway laser-beam free flight zone

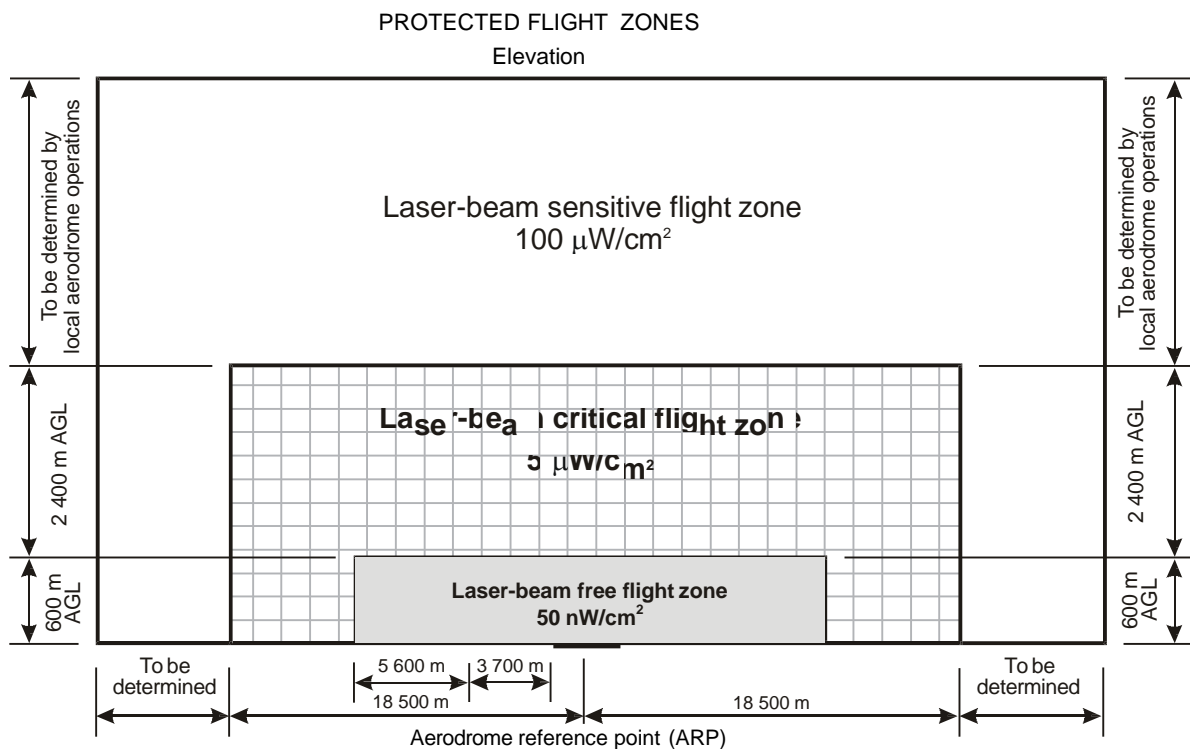

Figure 5-13. Protected flight zones with indication of maximum irradiance levels for visible laser beams

Lights which may cause confusion

5.3.1.3 A non-aeronautical ground light which, by reason of its intensity, configuration or colour, might prevent, or cause confusion in, the clear interpretation of aeronautical ground lights shall be extinguished, screened or otherwise modified so as to eliminate such a possibility. In particular, attention should be directed to a non- aeronautical ground light visible from the air within the areas described hereunder:



- (a) Instrument runway — code number 4:

within the areas before the threshold and beyond the end of the runway extending at least 4 500 m in length from the threshold and runway end and 750 m either side of the extended runway centre line in width.

- (b) Instrument runway — code number 2 or 3:

as in (a), except that the length should be at least 3 000 m.

- (c) Instrument runway — code number 1; and non-instrument runway:

within the approach area.

Aeronautical ground lights which may cause confusion to mariners

Note: In the case of aeronautical ground lights near navigable waters, consideration needs to be given to ensuring that the lights do not cause confusion to mariners.

Light fixtures and supporting structures

Note: See 9.9 for information regarding siting of equipment and installations on operational areas, and the Aerodrome Design Manual (Doc 9157), Part 6, for guidance on frangibility of light fixtures and supporting structures.

Elevated approach lights

5.3.1.4 Elevated approach lights and their supporting structures shall be frangible except that, in that portion of the approach lighting system beyond 300 m from the threshold:

- (a) where the height of a supporting structure exceeds 12 m, the frangibility requirement shall apply to the top 12 m only; and
- (b) where a supporting structure is surrounded by non-frangible objects, only that part of the structure that extends above the surrounding objects shall be frangible.

5.3.1.5 When an approach light fixture or supporting structure is not in itself sufficiently conspicuous, it shall be suitably marked.

Elevated lights

5.3.1.6 Elevated runway, stopway and taxiway lights shall be frangible. Their height shall be sufficiently low to preserve clearance for propellers and for the engine pods of jet aircraft.

Surface lights

5.3.1.7 Light fixtures inset in the surface of runways, stopways, taxiways and aprons shall be so designed and fitted as to withstand being run over by the wheels of an aircraft without damage either to the aircraft or to the lights themselves.

5.3.1.8 The temperature produced by conduction or radiation at the interface between an installed inset light and an aircraft tyre should not exceed 160°C during a 10-minute period of exposure.

Light intensity and control

5.3.1.9 The intensity of runway lighting shall be adequate for the minimum conditions of visibility and ambient light in which use of the runway is intended, and compatible with that of the nearest section of the approach lighting system when provided.

5.3.1.10 Where a high-intensity lighting system is provided, a suitable intensity control shall be incorporated to allow for adjustment of the light intensity to meet the prevailing conditions. Separate intensity controls or other suitable methods shall be provided to ensure that the following systems, when installed, can be operated at compatible intensities:

- approach lighting system;
- runway edge lights;
- runway threshold lights;
- runway end lights;
- runway centre line lights;
- runway touchdown zone lights; and
- taxiway centre line lights.

5.3.1.11 On the perimeter of and within the ellipse defining the main beam in Appendix 2 to ICAO Annex 14, Volume 1, Figures A2-1 to A2-10, the maximum light intensity value shall not be greater than three times the minimum light intensity value measured in accordance with Appendix 2 to ICAO Annex 14, Volume 1, collective notes for Figures A2-1 to A2-11, Note 2.

5.3.1.12 On the perimeter of and within the rectangle defining the main beam in Appendix 2 to ICAO Annex 14, Volume 1, Figures A2-12 to A2-20, the maximum light intensity value shall not be greater than three times the minimum light intensity value measured in accordance with Appendix 2 to ICAO Annex 14, Volume 1, collective notes for Figures A2-12 to A2-21, Note 2.

5.3.2 Emergency lighting

Application

5.3.2.1 At an aerodrome provided with runway lighting and without a secondary power supply, sufficient emergency lights shall be conveniently available for installation on at least the primary runway in the event of failure of the normal lighting system.

Location

5.3.2.2 When installed on a runway the emergency lights shall, as a minimum, conform to the configuration required for a non-instrument runway.

Characteristics

5.3.2.3 The colour of the emergency lights shall conform to the colour requirements for runway lighting, except that, where the provision of coloured lights at the threshold and the runway end is not practicable, all lights may be variable white or as close to variable white as practicable.



5.3.3 Aeronautical beacons

Application

5.3.3.1 Where operationally necessary an aerodrome beacon or an identification beacon shall be provided at each aerodrome intended for use at night.

5.3.3.2 The operational requirement shall be determined having regard to the requirements of the air traffic using the aerodrome, the conspicuity of the aerodrome features in relation to its surroundings and the installation of other visual and non-visual aids useful in locating the aerodrome.

Aerodrome beacon

5.3.3.3 An aerodrome beacon shall be provided at an aerodrome intended for use at night if one or more of the following conditions exist:

- (a) aircraft navigate predominantly by visual means;
- (b) reduced visibilities are frequent; or
- (c) it is difficult to locate the aerodrome from the air due to surrounding lights or terrain.

Location

5.3.3.4 The aerodrome beacon shall be located on or adjacent to the aerodrome in an area of low ambient background lighting.

5.3.3.5 The location of the beacon shall be such that the beacon is not shielded by objects in significant directions and does not dazzle a pilot approaching to land.

Characteristics

5.3.3.6 The aerodrome beacon shall show either coloured flashes alternating with white flashes, or white flashes only. The frequency of total flashes shall be from 20 to 30 per minute. Where used, the coloured flashes emitted by beacons at land aerodromes shall be green, and coloured flashes emitted by beacons at water aerodromes shall be yellow. In the case of a combined water and land aerodrome, coloured flashes, if used, shall have the colour characteristics of whichever section of the aerodrome is designated as the principal facility.

5.3.3.7 The light from the beacon shall show at all angles of azimuth. The vertical light distribution shall extend upwards from an elevation of not more than 1° to an elevation determined by the appropriate authority to be sufficient to provide guidance at the maximum elevation at which the beacon is intended to be used, and the effective intensity of the flash shall be not less than 2 000 cd.

Identification beacon

Application

5.3.3.8 An identification beacon shall be provided at an aerodrome which is intended for use at night and cannot be easily identified from the air by other means.



Location

5.3.3.9 The identification beacon shall be located on the aerodrome in an area of low ambient background lighting.

5.3.3.10 The location of the beacon shall be such that the beacon is not shielded by objects in significant directions and does not dazzle a pilot approaching to land.

Characteristics

5.3.3.11 An identification beacon at a land aerodrome shall show at all angles of azimuth. The vertical light distribution shall extend upwards from an elevation of not more than 1° to an elevation determined by the appropriate authority to be sufficient to provide guidance at the maximum elevation at which the beacon is intended to be used, and the effective intensity of the flash shall be not less than 2 000 cd.

5.3.3.12 An identification beacon shall show flashing-green at a land aerodrome and flashing-yellow at a water aerodrome.

5.3.3.13 The identification characters shall be transmitted in the International Morse Code.

5.3.3.14 The speed of transmission shall be between six and eight words per minute, the corresponding range of duration of the Morse dots being from 0.15 to 0.2 seconds per dot.

5.3.4 Approach lighting systems

Application

5.3.4.1 Application

A.— Non-instrument runway

Where physically practicable, a simple approach lighting system as specified in 5.3.4.2 to 5.3.4.9 should be provided to serve a non-instrument runway where the code number is 3 or 4 and intended for use at night, except when the runway is used only in conditions of good visibility and sufficient guidance is provided by other visual aids.

B.— Non-precision approach runway

Where physically practicable, a simple approach lighting system as specified in 5.3.4.2 to 5.3.4.9 shall be provided to serve a non-precision approach runway, except when the runway is used only in conditions of good visibility or sufficient guidance is provided by other visual aids.

C.— Precision approach runway category I

Where physically practicable, a precision approach category I lighting system as specified in 5.3.4.10 to 5.3.4.21 shall be provided to serve a precision approach runway category I.

D.— Precision approach runway categories II and III

A precision approach category II and III lighting system as specified in 5.3.4.22 to 5.3.4.39 shall be provided to serve a precision approach runway category II or III.



Simple approach lighting system

Location

- 5.3.4.2 A simple approach lighting system shall consist of a row of lights on the extended centre line of the runway extending, whenever possible, over a distance of not less than 420 m from the threshold with a row of lights forming a crossbar 18 m or 30 m in length at a distance of 300 m from the threshold.
- 5.3.4.3 The lights forming the crossbar shall be as nearly as practicable in a horizontal straight line at right angles to, and bisected by, the line of the centre line lights. The lights of the crossbar shall be spaced so as to produce a linear effect, except that, when a crossbar of 30 m is used, gaps may be left on each side of the centre line. These gaps shall be kept to a minimum to meet local requirements and each shall not exceed 6 m.
- 5.3.4.4 The lights forming the centre line shall be placed at longitudinal intervals of 60 m, except that, when it is desired to improve the guidance, an interval of 30 m may be used. The innermost light shall be located either 60 m or 30 m from the threshold, depending on the longitudinal interval selected for the centre line lights.
- 5.3.4.5 If it is not physically possible to provide a centre line extending for a distance of 420 m from the threshold, it should be extended to 300 m so as to include the crossbar. If this is not possible, the centre line lights shall be extended as far as practicable, and each centre line light shall then consist of a barrette at least 3 m in length. Subject to the approach system having a crossbar at 300 m from the threshold, an additional crossbar may be provided at 150 m from the threshold.
- 5.3.4.6 The system shall lie as nearly as practicable in the horizontal plane passing through the threshold, provided that:
- (a) no object other than an ILS or MLS azimuth antenna shall protrude through the plane of the approach lights within a distance of 60 m from the centre line of the system; and
 - (b) no light other than a light located within the central part of a crossbar or a centre line barrette (not their extremities) shall be screened from an approaching aircraft.

Any ILS or MLS azimuth antenna protruding through the plane of the lights shall be treated as an obstacle and marked and lighted accordingly.

Characteristics

- 5.3.4.7 The lights of a simple approach lighting system shall be fixed lights and the colour of the lights shall be such as to ensure that the system is readily distinguishable from other aeronautical ground lights, and from extraneous lighting if present. Each centre line light shall consist of either:
- (a) a single source; or
 - (b) a barrette at least 3 m in length.
- 5.3.4.8 Where provided for a non-instrument runway, the lights shall show at all angles in azimuth necessary to a pilot on base leg and final approach. The intensity of the lights shall be adequate for all conditions of visibility and ambient light for which the system has been provided.



5.3.4.9 Where provided for a non-precision approach runway, the lights shall show at all angles in azimuth necessary to the pilot of an aircraft which on final approach does not deviate by an abnormal amount from the path defined by the non-visual aid. The lights should be designed to provide guidance during both day and night in the most adverse conditions of visibility and ambient light for which it is intended that the system should remain usable.

Precision approach category I lighting system

Location

5.3.4.10 A precision approach category I lighting system shall consist of a row of lights on the extended centre line of the runway extending, wherever possible, over a distance of 900 m from the runway threshold with a row of lights forming a crossbar 30 m in length at a distance of 300 m from the runway threshold.

5.3.4.11 The lights forming the crossbar shall be as nearly as practicable in a horizontal straight line at right angles to, and bisected by, the line of the centre line lights. The lights of the crossbar shall be spaced so as to produce a linear effect, except that gaps may be left on each side of the centre line. These gaps shall be kept to a minimum to meet local requirements and each shall not exceed 6 m.

5.3.4.12 The lights forming the centre line shall be placed at longitudinal intervals of 30 m with the innermost light located 30 m from the threshold.

5.3.4.13 The system shall lie as nearly as practicable in the horizontal plane passing through the threshold, provided that:

- (a) no object other than an ILS or MLS azimuth antenna shall protrude through the plane of the approach lights within a distance of 60 m from the centre line of the system; and
- (b) no light other than a light located within the central part of a crossbar or a centre line barrette (not their extremities) shall be screened from an approaching aircraft.

Any ILS or MLS azimuth antenna protruding through the plane of the lights shall be treated as an obstacle and marked and lighted accordingly.

Characteristics

5.3.4.14 The centre line and crossbar lights of a precision approach category I lighting system shall be fixed lights showing variable white. Each centre line light position shall consist of either:

- (a) a single light source in the innermost 300 m of the centre line, two light sources in the central 300 m of the centre line and three light sources in the outer 300 m of the centre line to provide distance information; or
- (b) a barrette.

5.3.4.15 Where the serviceability level of the approach lights specified as a maintenance objective in 10.5.10 can be demonstrated, each centre line light position may consist of either:

- (a) a single light source; or
- (b) a barrette.



- 5.3.4.16 The barrettes shall be at least 4 m in length. When barrettes are composed of lights approximating to point sources, the lights shall be uniformly spaced at intervals of not more than 1.5 m.
- 5.3.4.17 If the centre line consists of barrettes as described in 5.3.4.14 b) or 5.3.4.15 b), each barrette should be supplemented by a flashing light, except where such lighting is considered unnecessary taking into account the characteristics of the system and the nature of the meteorological conditions.
- 5.3.4.18 Each flashing light as described in 5.3.4.17 shall be flashed twice a second in sequence, beginning with the outermost light and progressing toward the threshold to the innermost light of the system. The design of the electrical circuit shall be such that these lights can be operated independently of the other lights of the approach lighting system.
- 5.3.4.19 If the centre line consists of lights as described in 5.3.4.14 a) or 5.3.4.15 a), additional crossbars of lights to the crossbar provided at 300 m from the threshold shall be provided at 150 m, 450 m, 600 m and 750 m from the threshold. The lights forming each crossbar shall be as nearly as practicable in a horizontal straight line at right angles to, and bisected by, the line of the centre line lights. The lights shall be spaced so as to produce a linear effect, except that gaps may be left on each side of the centre line. These gaps shall be kept to a minimum to meet local requirements and each shall not exceed 6 m.
- 5.3.4.20 Where the additional crossbars described in 5.3.4.19 are incorporated in the system, the outer ends of the crossbars shall lie on two straight lines that either are parallel to the line of the centre line lights or converge to meet the runway centre line 300 m from threshold.
- 5.3.4.21 The lights shall be in accordance with the specifications of Appendix 2 to ICAO Annex 14, Volume 1, Figure A2-1.

Precision approach category II and III lighting system

Location

- 5.3.4.22 The approach lighting system shall consist of a row of lights on the extended centre line of the runway, extending, wherever possible, over a distance of 900 m from the runway threshold. In addition, the system shall have two side rows of lights, extending 270 m from the threshold, and two crossbars, one at 150 m and one at 300 m from the threshold, all as shown in Figure 5-14. Where the serviceability level of the approach lights specified as maintenance objectives in 10.5.7 can be demonstrated, the system may have two side rows of lights, extending 240 m from the threshold, and two crossbars, one at 150 m and one at 300 m from the threshold, all as shown in Figure 5-15.
- 5.3.4.23 The lights forming the centre line shall be placed at longitudinal intervals of 30 m with the innermost lights located 30 m from the threshold.
- 5.3.4.24 The lights forming the side rows shall be placed on each side of the centre line, at a longitudinal spacing equal to that of the centre line lights and with the first light located 30 m from the threshold. Where the serviceability level of the approach lights specified as maintenance objectives in 10.5.7 can be demonstrated, lights forming the side rows may be placed on each side of the centre line, at a longitudinal spacing of 60 m with the first light located 60 m from the threshold. The lateral spacing (or gauge) between the innermost lights of the side rows shall be not less than 18 m nor more than 22.5 m, and preferably 18 m, but in any event shall be equal to that of the touchdown zone lights.

- 5.3.4.25 The crossbar provided at 150 m from the threshold shall fill in the gaps between the centre line and side row lights.
- 5.3.4.26 The crossbar provided at 300 m from the threshold shall extend on both sides of the centre line lights to a distance of 15 m from the centre line.
- 5.3.4.27 If the centre line beyond a distance of 300 m from the threshold consists of lights as described in 5.3.4.31 b) or 5.3.4.32 b), additional crossbars of lights shall be provided at 450 m, 600 m and 750 m from the threshold.

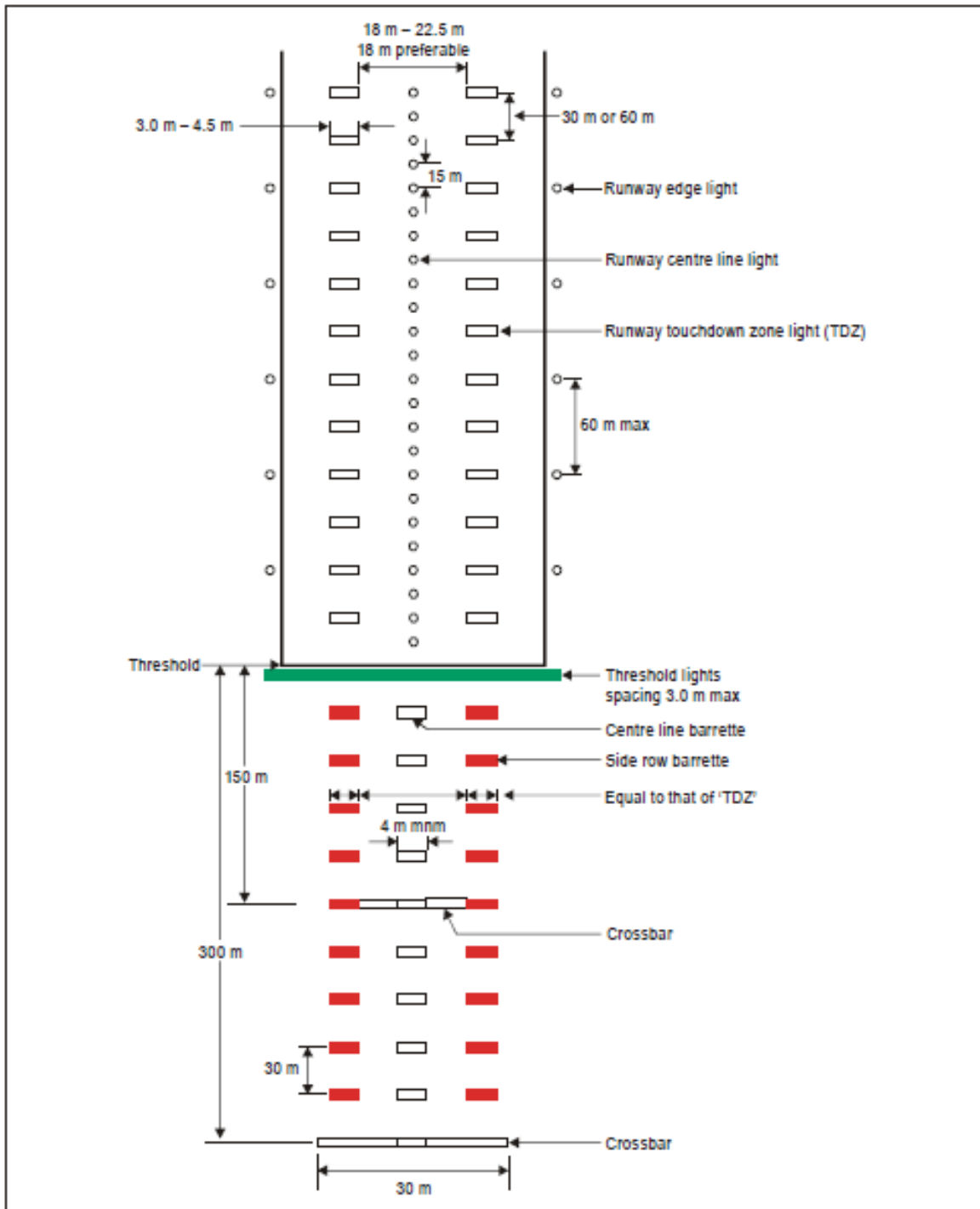

Figure 5-14. Inner 300 m approach and runway lighting for precision approach runways, categories II and III

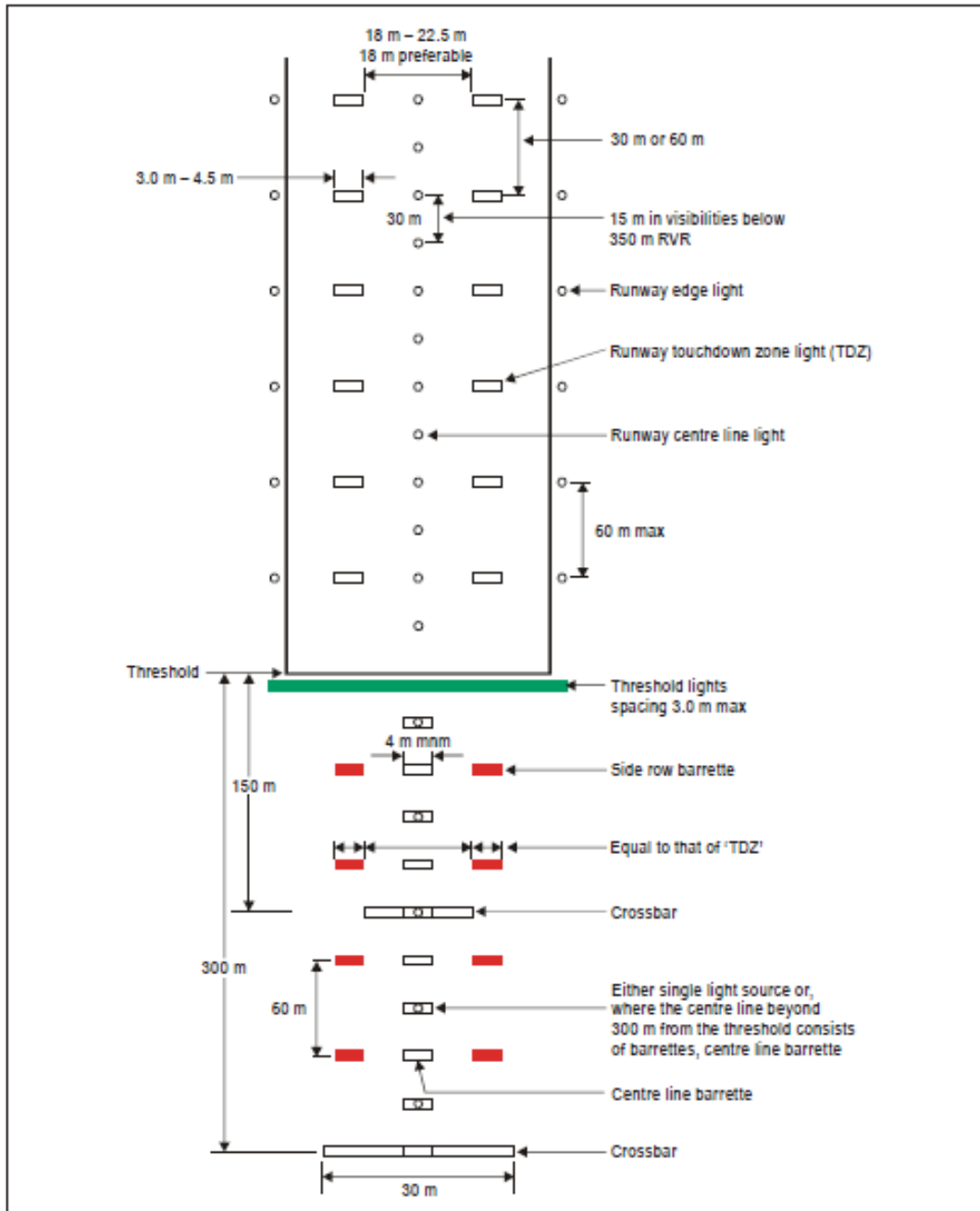

Figure 5-15. Inner 300 m approach and runway lighting for precision approach runways, categories II and III, where the serviceability levels of the lights specified as maintenance objectives in Chapter 10 can be demonstrated

5.3.4.28 Where the additional crossbars described in 5.3.4.27 are incorporated in the system, the outer ends of these crossbars shall lie on two straight lines that either are parallel to the centre line or converge to meet the runway centre line 300 m from the threshold.

5.3.4.29 The system shall lie as nearly as practicable in the horizontal plane passing through the threshold, provided that:

- (a) no object other than an ILS or MLS azimuth antenna shall protrude through the plane of the approach lights within a distance of 60 m from the centre line of the system; and
- (b) no light other than a light located within the central part of a crossbar or a centre line barrette (not their extremities) shall be screened from an approaching aircraft.



Any ILS or MLS azimuth antenna protruding through the plane of the lights shall be treated as an obstacle and marked and lighted accordingly.

Characteristics

5.3.4.30 The centre line of a precision approach category II and III lighting system for the first 300 m from the threshold shall consist of barrettes showing variable white, except that, where the threshold is displaced 300 m or more, the centre line may consist of single light sources showing variable white. Where the serviceability level of the approach lights specified as maintenance objectives in 10.5.7 can be demonstrated, the centre line of a precision approach category II and III lighting system for the first 300 m from the threshold may consist of either:

- (a) barrettes, where the centre line beyond 300 m from the threshold consists of barrettes as described in 5.3.4.32 a); or
- (b) alternate single light sources and barrettes, where the centre line beyond 300 m from the threshold consists of single light sources as described in 5.3.4.32 (b), with the innermost single light source located 30 m and the innermost barrette located 60 m from the threshold; or
- (c) single light sources where the threshold is displaced 300 m or more; all of which shall show variable white.

5.3.4.31 Beyond 300 m from the threshold each centre line light position shall consist of either:

- (a) a barrette as used on the inner 300 m; or
- (b) two light sources in the central 300 m of the centre line and three light sources in the outer 300 m of the centre line; all of which shall show variable white.

5.3.4.32 Where the serviceability level of the approach lights specified as maintenance objectives in 10.5.7 can be demonstrated, beyond 300 m from the threshold each centre line light position may consist of either:

- (a) a barrette; or
- (b) a single light source;

all of which shall show variable white.

5.3.4.33 The barrettes shall be at least 4 m in length. When barrettes are composed of lights approximating to point sources, the lights shall be uniformly spaced at intervals of not more than 1.5 m.

5.3.4.34 If the centre line beyond 300 m from the threshold consists of barrettes as described in 5.3.4.31 a) or 5.3.4.32 a), each barrette beyond 300 m should be supplemented by a flashing light, except where such lighting is considered unnecessary taking into account the characteristics of the system and the nature of the meteorological conditions.

5.3.4.35 Each flashing light as described in 5.3.4.34 shall be flashed twice a second in sequence, beginning with the outermost light and progressing toward the threshold to the innermost light of the system. The design of the electrical circuit shall be such that these lights can be operated independently of the other lights of the approach lighting system.



- 5.3.4.36 The side row shall consist of barrettes showing red. The length of a side row barrette and the spacing of its lights shall be equal to those of the touchdown zone light barrettes.
- 5.3.4.37 The lights forming the crossbars shall be fixed lights showing variable white. The lights shall be uniformly spaced at intervals of not more than 2.7 m.
- 5.3.4.38 The intensity of the red lights shall be compatible with the intensity of the white lights.
- 5.3.4.39 The lights shall be in accordance with the specifications of Appendix 2 to ICAO Annex 14, Volume 1, Figures A2-1 and A2-2.

5.3.5 Visual approach slope indicator systems

Application

- 5.3.5.1 A visual approach slope indicator system shall be provided to serve the approach to a runway whether or not the runway is served by other visual approach aids or by non-visual aids, where one or more of the following conditions exist:
- (a) the runway is used by turbojet or other aeroplanes with similar approach guidance requirements;
 - (b) the pilot of any type of aeroplane may have difficulty in judging the approach due to:
 - (1) inadequate visual guidance such as is experienced during an approach over water or featureless terrain by day or in the absence of sufficient extraneous lights in the approach area by night; or
 - (2) misleading information such as is produced by deceptive surrounding terrain or runway slopes;
 - (c) the presence of objects in the approach area may involve serious hazard if an aeroplane descends below the normal approach path, particularly if there are no non-visual or other visual aids to give warning of such objects;
 - (d) physical conditions at either end of the runway present a serious hazard in the event of an aeroplane undershooting or overrunning the runway; and
 - (e) terrain or prevalent meteorological conditions are such that the aeroplane may be subjected to unusual turbulence during approach.

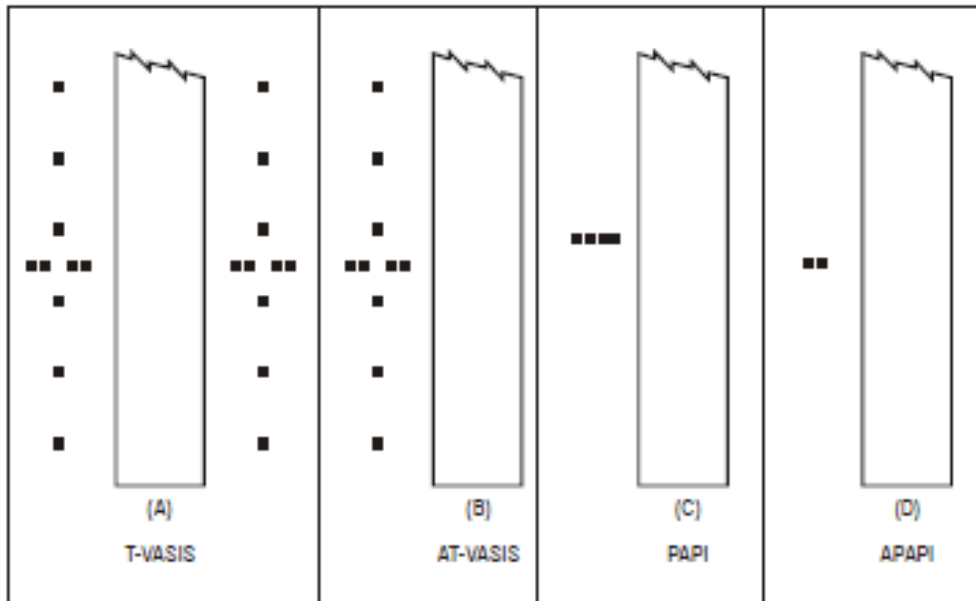

Figure 5-16. Visual approach slope indicator systems

5.3.5.2 The standard visual approach slope indicator systems shall consist of the following:

- (a) T-VASIS and AT-VASIS conforming to the specifications contained in 5.3.5.6 to 5.3.5.22 inclusive;
- (b) PAPI and APAPI systems conforming to the specifications contained in 5.3.5.23 to 5.3.5.40 inclusive; as shown in Figure 5-16.

5.3.5.3 PAPI, T-VASIS or AT-VASIS shall be provided where the code number is 3 or 4 when one or more of the conditions specified in 5.3.5.1 exist.

5.3.5.4 As of 1 January 2020, the use of T-VASIS and AT-VASIS as standard visual approach slope indicator systems should be discontinued.

5.3.5.5 PAPI or APAPI shall be provided where the code number is 1 or 2 when one or more of the conditions specified in 5.3.5.1 exist.

5.3.5.6 Where a runway threshold is temporarily displaced from the normal position and one or more of the conditions specified in 5.3.5.1 exist, a PAPI should be provided except that where the code number is 1 or 2 an APAPI may be provided.

T- VASIS and AT-VASIS

Description

5.3.5.7 The T-VASIS shall consist of twenty light units symmetrically disposed about the runway centre line in the form of two wing bars of four light units each, with bisecting longitudinal lines of six lights, as shown in Figure 5-17.

5.3.5.8 The AT-VASIS shall consist of ten light units arranged on one side of the runway in the form of a single wing bar of four light units with a bisecting longitudinal line of six lights.



5.3.5.9 The light units shall be constructed and arranged in such a manner that the pilot of an aeroplane during an approach will:

- (a) when above the approach slope, see the wing bar(s) white, and one, two or three fly-down lights, the more fly-down lights being visible the higher the pilot is above the approach slope;
- (b) when on the approach slope, see the wing bar(s) white; and
- (c) when below the approach slope, see the wing bar(s) and one, two or three fly-up lights white, the more fly-up lights being visible the lower the pilot is below the approach slope; and when well below the approach slope, see the wing bar(s) and the three fly-up lights red.

When on or above the approach slope, no light shall be visible from the fly-up light units; when on or below the approach slope, no light shall be visible from the fly-down light units.

Siting

5.3.5.10 The light units shall be located as shown in Figure 5-17, subject to the installation tolerances given therein.

Wing bar lights and one fly-down light visible 17 m to 22 m

Wing bar lights and two fly-down lights visible 22 m to 28 m

Wing bar lights and three fly-down lights visible 28 m to 54 m.

Characteristics of the light units

5.3.5.11 The systems shall be suitable for both day and night operations.

5.3.5.12 The light distribution of the beam of each light unit shall be of fan shape showing over a wide arc in azimuth in the approach direction. The wing bar light units shall produce a beam of white light from 1°54' vertical angle up to 6° vertical angle and a beam of red light from 0° to 1°54' vertical angle. The fly-down light units shall produce a white beam extending from an elevation of 6° down to approximately the approach slope, where it shall have a sharp cut-off. The fly-up light units shall produce a white beam from approximately the approach slope down to 1°54' vertical angle and a red beam below a 1°54' vertical angle. The angle of the top of the red beam in the wing bar units and fly-up units may be increased to comply with 5.3.5.21.

5.3.5.13 The light intensity distribution of the fly-down, wing bar and fly-up light units shall be as shown in Appendix 2 to ICAO Annex 14, Volume 1, Figure A2-22.

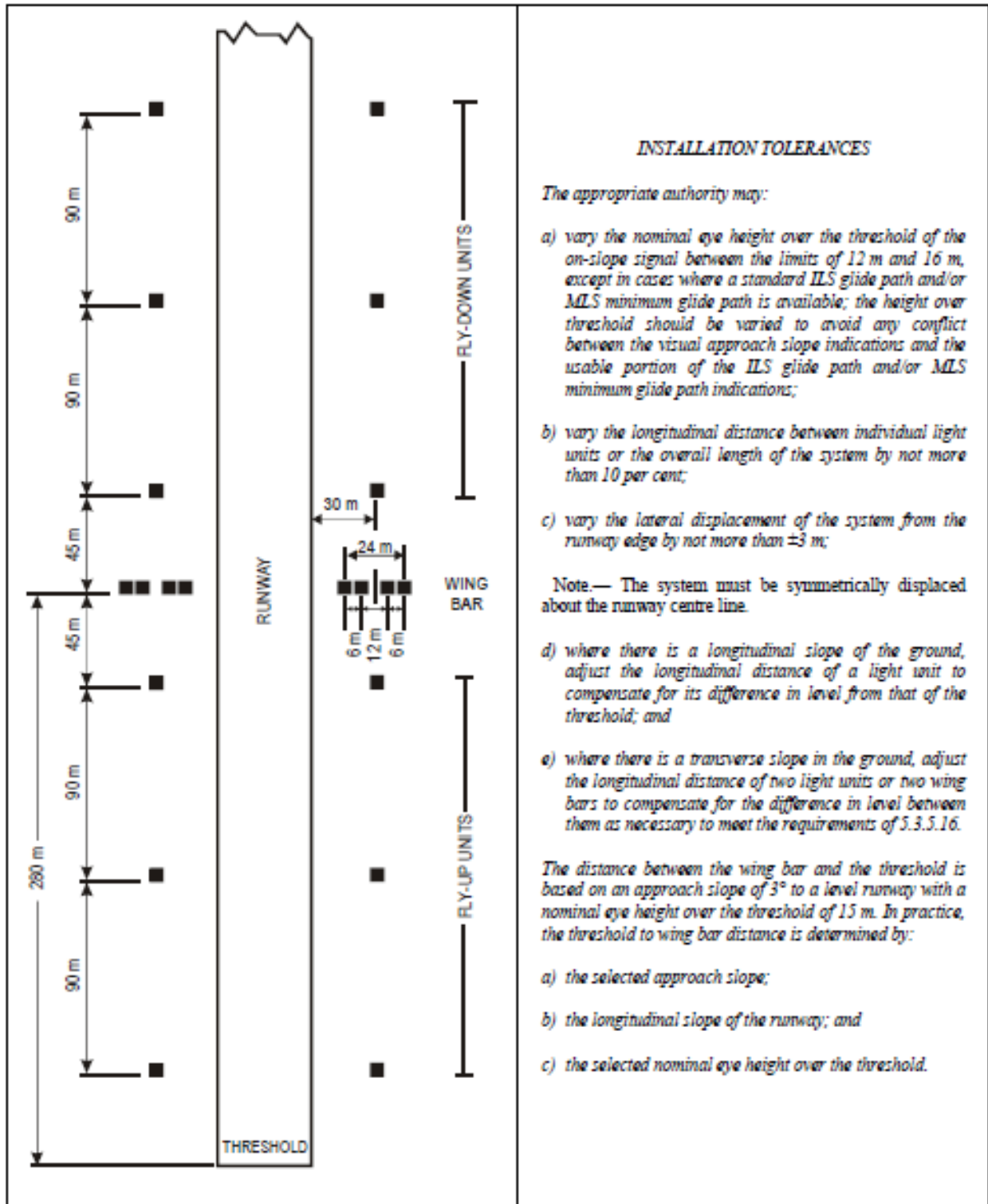

Figure 5-17. Siting of light units for T-VASIS

- 5.3.5.14 The colour transition from red to white in the vertical plane shall be such as to appear to an observer, at a distance of not less than 300 m, to occur over a vertical angle of not more than 15'.
- 5.3.5.15 At full intensity the red light shall have a Y coordinate not exceeding 0.320.
- 5.3.5.16 A suitable intensity control shall be provided to allow adjustments to meet the prevailing conditions and to avoid dazzling the pilot during approach and landing.

5.3.5.17 The light units forming the wing bars, or the light units forming a fly-down or a fly-up matched pair, shall be mounted so as to appear to the pilot of an approaching aeroplane to be substantially in a horizontal line. The light units shall be mounted as low as possible and shall be frangible.

5.3.5.18 The light units shall be so designed that deposits of condensation, dirt, etc., on optically transmitting or reflecting surfaces shall interfere to the least possible extent with the light signals and shall in no way affect the elevation of the beams or the contrast between the red and white signals. The construction of the light units shall be such as to minimize the probability of the slots being wholly or partially blocked by snow or ice where these conditions are likely to be encountered.

Approach slope and elevation setting of light beams

5.3.5.19 The approach slope shall be appropriate for use by the aeroplanes using the approach.

5.3.5.20 When the runway on which a T-VASIS is provided is equipped with an ILS and/or MLS, the siting and elevations of the light units shall be such that the visual approach slope conforms as closely as possible with the glide path of the ILS and/or the minimum glide path of the MLS, as appropriate.

5.3.5.21 The elevation of the beams of the wing bar light units on both sides of the runway shall be the same. The elevation of the top of the beam of the fly-up light unit nearest to each wing bar, and that of the bottom of the beam of the fly-down light unit nearest to each wing bar, shall be equal and shall correspond to the approach slope. The cut-off angle of the top of the beams of successive fly-up light units shall decrease by 5° of arc in angle of elevation at each successive unit away from the wing bar. The cut-in angle of the bottom of the beam of the fly-down light units shall increase by 7° of arc at each successive unit away from the wing bar (see Figure 5-18).

5.3.5.22 The elevation setting of the top of the red light beams of the wing bar and fly-up light units shall be such that, during an approach, the pilot of an aeroplane to whom the wing bar and three fly-up light units are visible would clear all objects in the approach area by a safe margin if any such light did not appear red.

5.3.5.23 The azimuth spread of the light beam shall be suitably restricted where an object located outside the obstacle protection surface of the system, but within the lateral limits of its light beam, is found to extend above the plane of the obstacle protection surface and an aeronautical study indicates that the object could adversely affect the safety of operations. The extent of the restriction shall be such that the object remains outside the confines of the light beam.

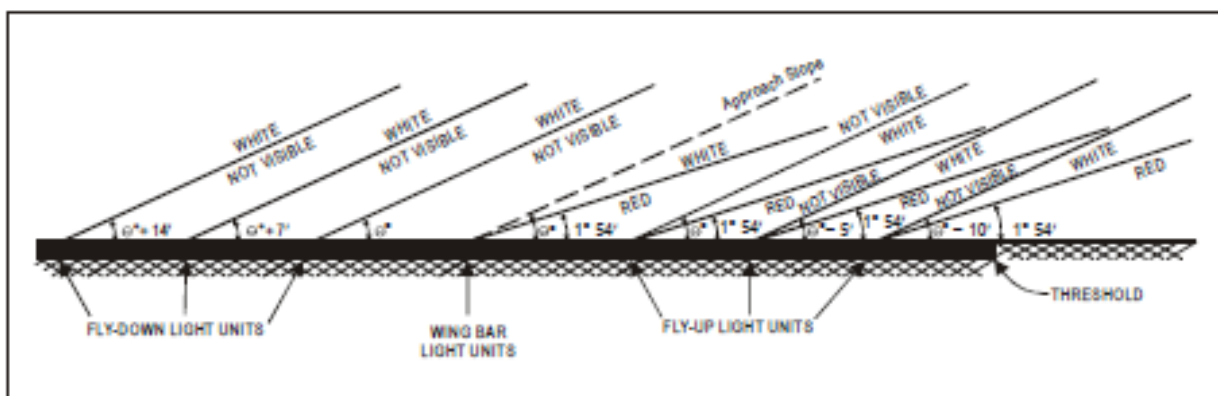

Figure 5-18. Light beams and elevation settings of T-VASIS and AT-VASIS

PAPI and APAPI

Description

5.3.5.24 The PAPI system shall consist of a wing bar of four sharp transition multi-lamp (or paired single lamp) units equally spaced. The system shall be located on the left side of the runway unless it is physically impracticable to do so.

5.3.5.25 The APAPI system shall consist of a wing bar of two sharp transition multi-lamp (or paired single lamp) units. The system shall be located on the left side of the runway unless it is physically impracticable to do so.

5.3.5.26 The wing bar of a PAPI shall be constructed and arranged in such a manner that a pilot making an approach will:

- (a) when on or close to the approach slope, see the two units nearest the runway as red and the two units farthest from the runway as white;
- (b) when above the approach slope, see the one unit nearest the runway as red and the three units farthest from the runway as white; and when further above the approach slope, see all the units as white; and
- (c) when below the approach slope, see the three units nearest the runway as red and the unit farthest from the runway as white; and when further below the approach slope, see all the units as red.

5.3.5.27 The wing bar of an APAPI shall be constructed and arranged in such a manner that a pilot making an approach will:

- (a) when on or close to the approach slope, see the unit nearer the runway as red and the unit farther from the runway as white;
- (b) when above the approach slope, see both the units as white; and
- (c) when below the approach slope, see both the units as red.

Siting

5.3.5.28 The light units shall be located as in the basic configuration illustrated in Figure 5-19, subject to the installation tolerances given therein. The units forming a wing bar shall be mounted so as to appear to the pilot of an approaching aeroplane to be substantially in a horizontal line. The light units shall be mounted as low as possible and shall be frangible.

Characteristics of the light units

5.3.5.29 The system shall be suitable for both day and night operations.

5.3.5.30 The colour transition from red to white in the vertical plane shall be such as to appear to an observer, at a distance of not less than 300 m, to occur within a vertical angle of not more than 3°.

5.3.5.31 At full intensity the red light shall have a Y coordinate not exceeding 0.320.



- 5.3.5.32 The light intensity distribution of the light units shall be as shown in Appendix 2 to ICAO Annex 14, Volume 1, Figure A2-23.
- 5.3.5.33 Suitable intensity control shall be provided so as to allow adjustment to meet the prevailing conditions and to avoid dazzling the pilot during approach and landing.
- 5.3.5.34 Each light unit shall be capable of adjustment in elevation so that the lower limit of the white part of the beam may be fixed at any desired angle of elevation between 1°30' and at least 4°30' above the horizontal.
- 5.3.5.35 The light units shall be so designed that deposits of condensation, snow, ice, dirt, etc., on optically transmitting or reflecting surfaces shall interfere to the least possible extent with the light signals and shall not affect the contrast between the red and white signals and the elevation of the transition sector.

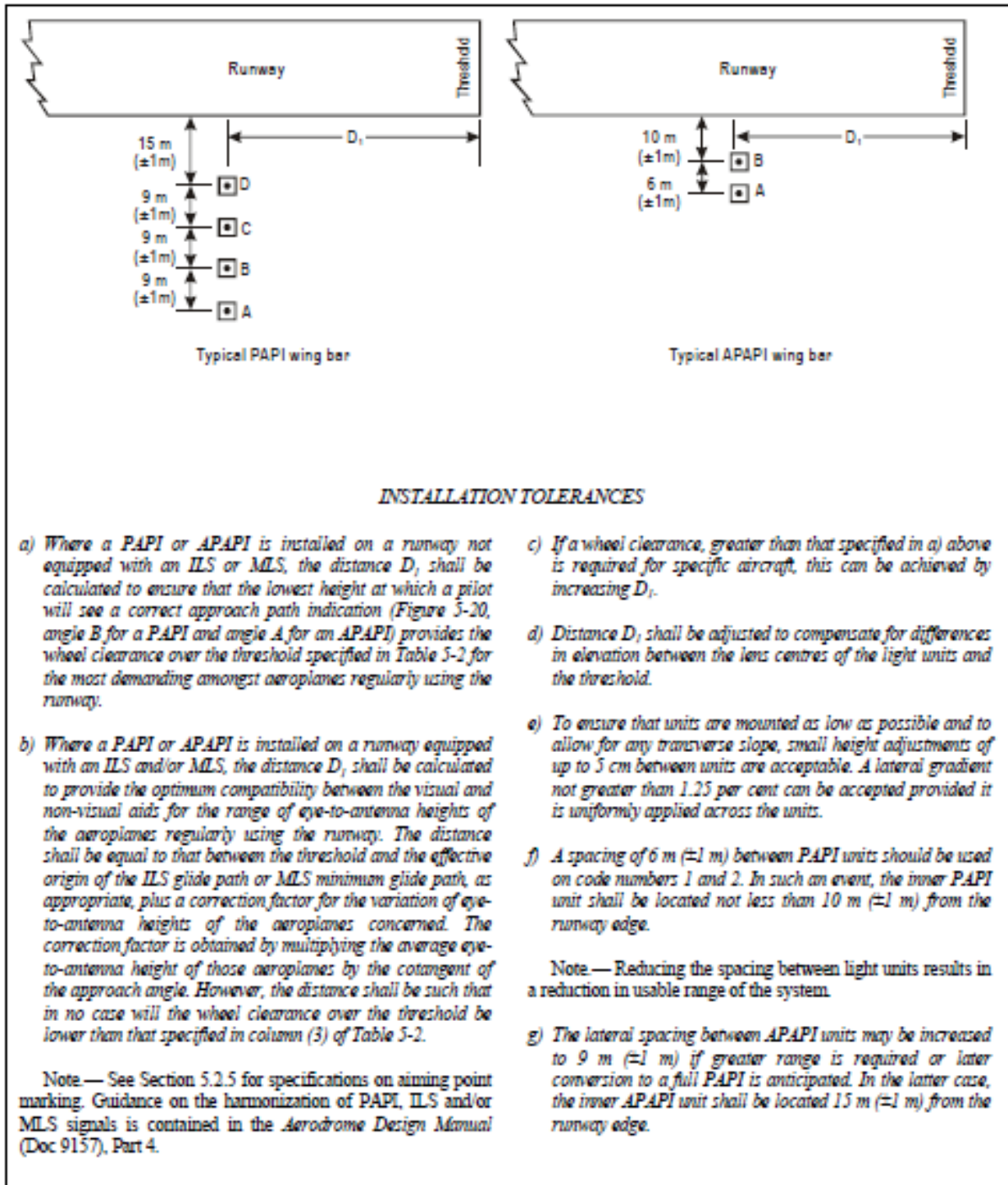

Figure 5-19. Siting of PAPI and APAPI

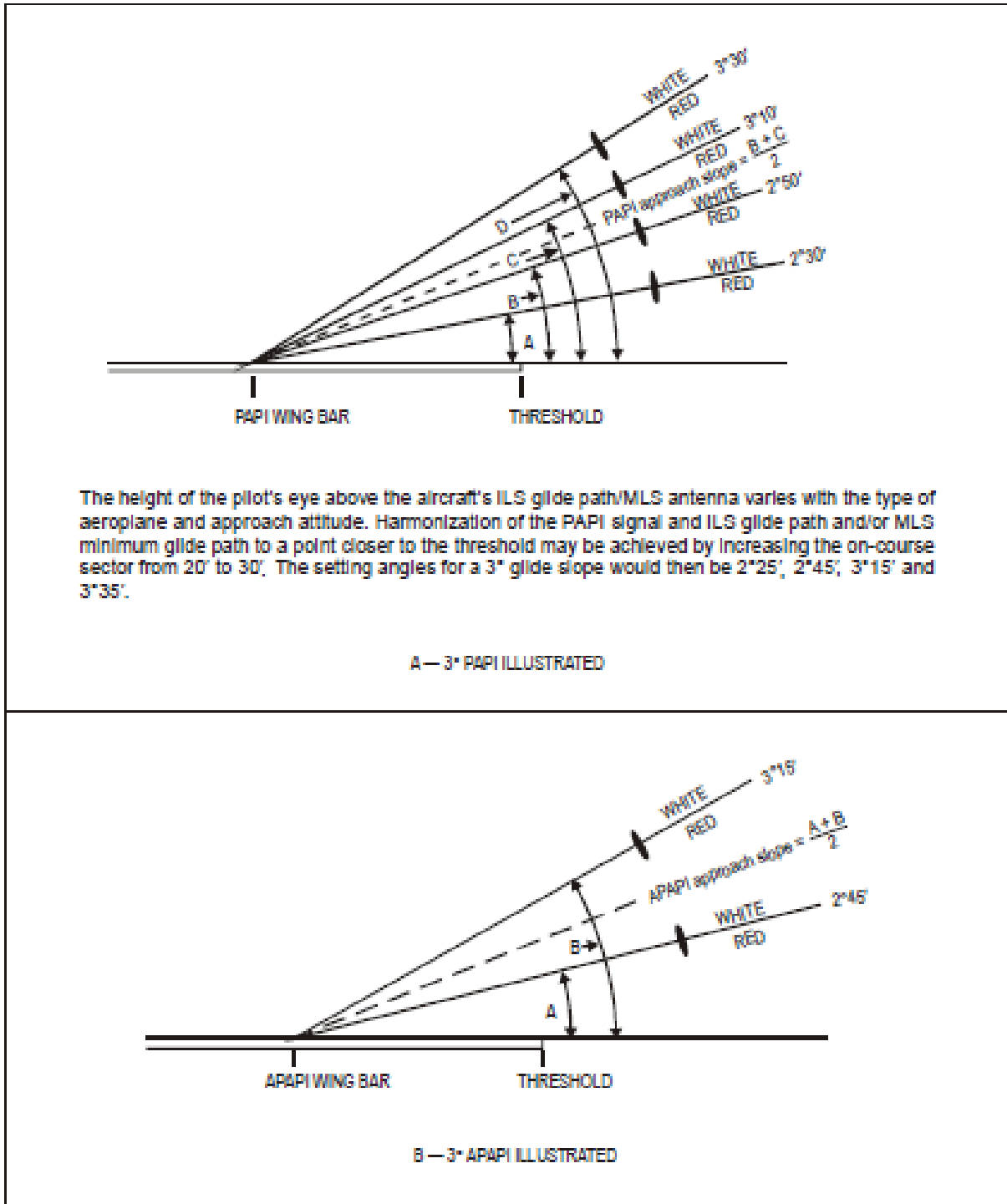

Figure 5-20. Light beams and angle of elevation setting of PAPI and APAPI



Table 5-2. Wheel clearance over threshold for PAPI and APAPI

Eye-to-wheel height of aeroplane in the approach configuration ^a	Desired wheel clearance (metres) ^{b,c}	Minimum wheel clearance (metres) ^d
(1)	(2)	(3)
up to but not including 3 m	6	3 ^e
3 m up to but not including 5 m	9	4
5 m up to but not including 8 m	9	5
8 m up to but not including 14 m	9	6

- a. In selecting the eye-to-wheel height group, only aeroplanes meant to use the system on a regular basis shall be considered. The most demanding amongst such aeroplanes shall determine the eye-to-wheel height group.
- b. Where practicable the desired wheel clearances shown in column (2) shall be provided.
- c. The wheel clearances in column (2) may be reduced to no less than those in column (3) where an aeronautical study indicates that such reduced wheel clearances are acceptable.
- d. When a reduced wheel clearance is provided at a displaced threshold it shall be ensured that the corresponding desired wheel clearance specified in column (2) will be available when an aeroplane at the top end of the eye-to-wheel height group chosen overflies the extremity of the runway.
- e. This wheel clearance may be reduced to 1.5 m on runways used mainly by light-weight non-turbojet aeroplanes.

Approach slope and elevation setting of light units

5.3.5.36 The approach slope as defined in Figure 5-20 shall be appropriate for use by the aeroplanes using the approach.

5.3.5.37 When the runway is equipped with an ILS and/or MLS, the siting and the angle of elevation of the light units shall be such that the visual approach slope conforms as closely as possible with the glide path of the ILS and/or the minimum glide path of the MLS, as appropriate.

5.3.5.38 The angle of elevation settings of the light units in a PAPI wing bar shall be such that, during an approach, the pilot of an aeroplane observing a signal of one white and three reds will clear all objects in the approach area by a safe margin (see Table 5-2).

5.3.5.39 The angle of elevation settings of the light units in an APAPI wing bar shall be such that, during an approach, the pilot of an aeroplane observing the lowest onslope signal, i.e. one white and one red, will clear all objects in the approach area by a safe margin (see Table 5-2).

5.3.5.40 The azimuth spread of the light beam shall be suitably restricted where an object located outside the obstacle protection surface of the PAPI or APAPI system, but within the lateral limits of its light beam, is found to extend above the plane of the obstacle protection surface and an aeronautical study indicates that the object could adversely affect the safety of operations. The extent of the restriction shall be such that the object remains outside the confines of the light beam.

5.3.5.41 Where wing bars are installed on each side of the runway to provide roll guidance, corresponding units shall be set at the same angle so that the signals of each wing bar change symmetrically at the same time.

Obstacle protection surface

5.3.5.42 An obstacle protection surface shall be established when it is intended to provide a visual approach slope indicator system.



- 5.3.5.43 The characteristics of the obstacle protection surface, i.e. origin, divergence, length and slope, shall correspond to those specified in the relevant column of Table 5-3 and in Figure 5-21.
- 5.3.5.44 New objects or extensions of existing objects shall not be permitted above an obstacle protection surface except when, in the opinion of the appropriate authority, the new object or extension would be shielded by an existing immovable object.
- 5.3.5.45 Existing objects above an obstacle protection surface shall be removed except when, in the opinion of the appropriate authority, the object is shielded by an existing immovable object, or after aeronautical study it is determined that the object would not adversely affect the safety of operations of aeroplanes.

Table 5-3. Dimensions and slopes of the obstacle protection surface

Surface dimensions	Runway type/code number							
	Non-instrument Code number				Instrument Code number			
	1	2	3	4	1	2	3	4
Length of inner edge	60 m	80 m ^a	150 m	150 m	150 m	150 m	300 m	300 m
Distance from the visual approach slope indicator system ^e	D ₁ +30 m	D ₁ +60 m	D ₁ +60 m	D ₁ +60 m	D ₁ +60 m	D ₁ +60 m	D ₁ +60 m	D ₁ +60 m
Divergence (each side)	10%	10%	10%	10%	15%	15%	15%	15%
Total length	7 500 m	7 500 m ^b	15 000 m	15 000 m	7 500 m	7 500 m ^b	15 000 m	15 000 m
<i>Slope</i>								
a) T-VASIS and AT-VASIS	– ^c	1.9°	1.9°	1.9°	–	1.9°	1.9°	1.9°
b) PAPI ^d	–	A–0.57°	A–0.57°	A–0.57°	A–0.57°	A–0.57°	A–0.57°	A–0.57°
c) APAPI ^d	A–0.9°	A–0.9°	–	–	A–0.9°	A–0.9°	–	–
a. This length is to be increased to 150 m for a T-VASIS or AT-VASIS. b. This length is to be increased to 15 000 m for a T-VASIS or AT-VASIS. c. No slope has been specified if a system is unlikely to be used on runway type/code number indicated. d. Angles as indicated in Figure 5-20. e. D ₁ is the distance of the visual approach slope indicator system from threshold prior to any displacement to remedy object penetration of the OPS (refer Figure 5-19). The start of the OPS is fixed to the visual approach slope indicator system location, such that displacement of the PAPI results in an equal displacement of the start of the OPS. See 5.3.5.46 e).								

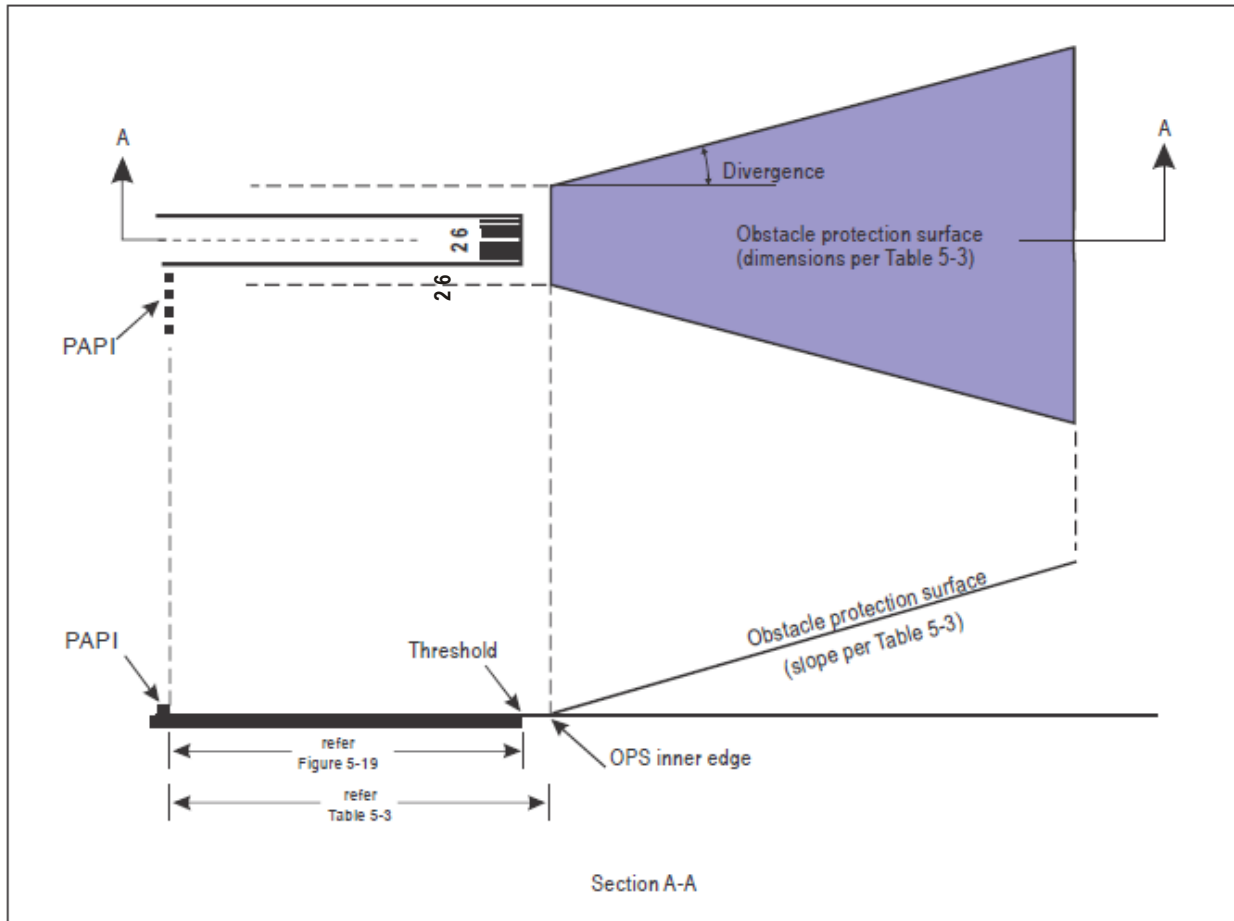

Figure 5-21. Obstacle protection surface for visual approach slope indicator systems

5.3.5.46 Where an aeronautical study indicates that an existing object extending above an obstacle protection surface (OPS) could adversely affect the safety of operations of aeroplanes one or more of the following measures shall be taken:

- (a) remove the object;
- (b) suitably raise the approach slope of the system;
- (c) reduce the azimuth spread of the system so that the object is outside the confines of the beam;
- (d) displace the axis of the system and its associated obstacle protection surface by no more than 5°;
- (e) such that the object no longer penetrates the OPS.

5.3.6 Circling guidance lights

Application

5.3.6.1 Circling guidance lights shall be provided when existing approach and runway lighting systems do not satisfactorily permit identification of the runway and/or approach area to a circling aircraft in the conditions for which it is intended the runway be used for circling approaches.

***Location***

5.3.6.2 The location and number of circling guidance lights should be adequate to enable a pilot, as appropriate, to:

- (a) join the downwind leg or align and adjust the aircraft's track to the runway at a required distance from it and to distinguish the threshold in passing; and
- (b) keep in sight the runway threshold and/or other features which will make it possible to judge the turn on to base leg and final approach, taking into account the guidance provided by other visual aids.

5.3.6.3 Circling guidance lights shall consist of:

- (a) lights indicating the extended centre line of the runway and/or parts of any approach lighting system; or
- (b) lights indicating the position of the runway threshold; or
- (c) lights indicating the direction or location of the runway;

or a combination of such lights as is appropriate to the runway under consideration.

Characteristics

5.3.6.4 Circling guidance lights shall be fixed or flashing lights of an intensity and beam spread adequate for the conditions of visibility and ambient light in which it is intended to make visual circling approaches. The flashing lights should be white, and the steady lights either white or gaseous discharge lights.

5.3.6.5 The lights shall be designed and be installed in such a manner that they will not dazzle or confuse a pilot when approaching to land, taking off or taxiing.

5.3.7 Runway lead-in lighting systems

Application

5.3.7.1 A runway lead-in lighting system shall be provided where it is desired to provide visual guidance along a specific approach path, for reasons such as avoiding hazardous terrain or for purposes of noise abatement.

Location

5.3.7.2 A runway lead-in lighting system shall consist of groups of lights positioned so as to define the desired approach path and so that one group may be sighted from the preceding group. The interval between adjacent groups should not exceed approximately 1 600 m.

5.3.7.3 A runway lead-in lighting system shall extend from a point as determined by the appropriate authority, up to a point where the approach lighting system, if provided, or the runway or the runway lighting system is in view.



Characteristics

5.3.7.4 Each group of lights of a runway lead-in lighting system shall consist of at least three flashing lights in a linear or cluster configuration. The system may be augmented by steady burning lights where such lights would assist in identifying the system.

5.3.7.5 The flashing lights and the steady burning lights shall be white.

5.3.7.6 Where practicable, the flashing lights in each group should flash in sequence towards the runway.

5.3.8 Runway threshold identification lights

Application

5.3.8.1 Runway threshold identification lights shall be installed:

- (a) at the threshold of a non-precision approach runway when additional threshold conspicuity is necessary or where it is not practicable to provide other approach lighting aids; and
- (b) where a runway threshold is permanently displaced from the runway extremity or temporarily displaced from the normal position and additional threshold conspicuity is necessary.

Location

5.3.8.2 Runway threshold identification lights shall be located symmetrically about the runway centre line, in line with the threshold and approximately 10 m outside each line of runway edge lights.

Characteristics

5.3.8.3 Runway threshold identification lights shall be flashing white lights with a flash frequency between 60 and 120 per minute.

5.3.8.4 The lights shall be visible only in the direction of approach to the runway.

5.3.9 Runway edge lights

Application

5.3.9.1 Runway edge lights shall be provided for a runway intended for use at night or for a precision approach runway intended for use by day or night.

5.3.9.2 Runway edge lights shall be provided on a runway intended for take-off with an operating minimum below an RVR of the order of 800 m by day.

Location

5.3.9.3 Runway edge lights shall be placed along the full length of the runway and shall be in two parallel rows equidistant from the centre line.

5.3.9.4 Runway edge lights shall be placed along the edges of the area declared for use as the runway or outside the edges of the area at a distance of not more than 3 m.



5.3.9.5 Where the width of the area which could be declared as runway exceeds 60 m, the distance between the rows of lights should be determined taking into account the nature of the operations, the light distribution characteristics of the runway edge lights, and other visual aids serving the runway.

5.3.9.6 The lights shall be uniformly spaced in rows at intervals of not more than 60 m for an instrument runway, and at intervals of not more than 100 m for a non-instrument runway. The lights on opposite sides of the runway axis shall be on lines at right angles to that axis. At intersections of runways, lights may be spaced irregularly or omitted, provided that adequate guidance remains available to the pilot.

Characteristics

5.3.9.7 Runway edge lights shall be fixed lights showing variable white, except that:

- (a) in the case of a displaced threshold, the lights between the beginning of the runway and the displaced threshold shall show red in the approach direction; and
- (b) a section of the lights 600 m or one-third of the runway length, whichever is the less, at the remote end of the runway from the end at which the take-off run is started, may show yellow.

5.3.9.8 The runway edge lights shall show at all angles in azimuth necessary to provide guidance to a pilot landing or taking off in either direction. When the runway edge lights are intended to provide circling guidance, they shall show at all angles in azimuth (see 5.3.6.1).

5.3.9.9 In all angles of azimuth required in 5.3.9.8, runway edge lights shall show at angles up to 15° above the horizontal with an intensity adequate for the conditions of visibility and ambient light in which use of the runway for take-off or landing is intended. In any case, the intensity shall be at least 50 cd except that at an aerodrome without extraneous lighting, the intensity of the lights may be reduced to not less than 25 cd to avoid dazzling the pilot.

5.3.9.10 Runway edge lights on a precision approach runway shall be in accordance with the specifications of Appendix 2 to ICAO Annex 14, Volume 1, Figure A2-9 or A2-10.

5.3.10 Runway threshold and wing bar lights (see Figure 5-22)

Application of runway threshold lights

5.3.10.1 Runway threshold lights shall be provided for a runway equipped with runway edge lights, except on a non- instrument or non-precision approach runway where the threshold is displaced and wing bar lights are provided.

Location of runway threshold lights

5.3.10.2 When a threshold is at the extremity of a runway, the threshold lights shall be placed in a row at right angles to the runway axis as near to the extremity of the runway as possible and, in any case, not more than 3 m outside the extremity.

5.3.10.3 When a threshold is displaced from the extremity of a runway, threshold lights shall be placed in a row at right angles to the runway axis at the displaced threshold.

5.3.10.4 Threshold lighting shall consist of:



- (a) on a non-instrument or non-precision approach runway, at least six lights;
- (b) on a precision approach runway category I, at least the number of lights that would be required if the lights were uniformly spaced at intervals of 3 m between the rows of runway edge lights; and
- (c) on a precision approach runway category II or III, lights uniformly spaced between the rows of runway edge lights at intervals of not more than 3 m.

5.3.10.5 The lights prescribed in 5.3.10.4 a) and b) shall be either:

- (a) equally spaced between the rows of runway edge lights; or
- (b) symmetrically disposed about the runway centre line in two groups, with the lights uniformly spaced in each group and with a gap between the groups equal to the gauge of the touchdown zone marking or lighting, where such is provided, or otherwise not more than half the distance between the rows of runway edge lights.

Application of wing bar lights

5.3.10.6 Wing bar lights shall be provided on a precision approach runway when additional conspicuity is considered desirable.

5.3.10.7 Wing bar lights shall be provided on a non-instrument or non-precision approach runway where the threshold is displaced and runway threshold lights are required, but are not provided.

Location of wing bar lights

5.3.10.8 Wing bar lights shall be symmetrically disposed about the runway centre line at the threshold in two groups, i.e. wing bars. Each wing bar shall be formed by at least five lights extending at least 10 m outward from, and at right angles to, the line of the runway edge lights, with the innermost light of each wing bar in the line of the runway edge lights.



This Page Intentionally Left Blank



CONDITION	LIGHTS	RUNWAY TYPE			
		NON-INSTRUMENT AND NON-PRECISION APPROACH RUNWAYS	PRECISION APPROACH RUNWAYS CATEGORY I	PRECISION APPROACH RUNWAYS CATEGORY I	PRECISION APPROACH RUNWAYS CATEGORY II
THRESHOLD AT RUNWAY EXTREMITY	RUNWAY THRESHOLD AND RUNWAY END LIGHTS	<p>[5.3.10.2, 5.3.10.4 a), 5.3.10.5, 5.3.11.2, 5.3.11.3]</p>	<p>[5.3.10.2, 5.3.10.4 b), 5.3.10.5, 5.3.10.8, 5.3.11.2, 5.3.11.3]</p>	<p>[5.3.10.2, 5.3.10.4 c), 5.3.10.8, 5.3.11.2, 5.3.11.3]</p>	<p>[5.3.10.2, 5.3.10.4 d), 5.3.10.8, 5.3.11.2, 5.3.11.3]</p>
THRESHOLD DISPLACED FROM RUNWAY EXTREMITY	RUNWAY THRESHOLD LIGHTS	<p>[5.3.10.3, 5.3.10.4 a), 5.3.10.5, 5.3.10.8]</p>	<p>[5.3.10.3, 5.3.10.4 b), 5.3.10.5, 5.3.10.8]</p>	<p>[5.3.10.3, 5.3.10.4 c), 5.3.10.8]</p>	<p>[5.3.10.3, 5.3.10.4 d), 5.3.10.8]</p>
	RUNWAY END LIGHTS		<p>[5.3.11.2, 5.3.11.3]</p>		<p>[5.3.11.2, 5.3.11.3]</p>

LEGEND
UNIDIRECTIONAL LIGHT
BIDIRECTIONAL LIGHT
CONDITIONAL RECOMMENDATION

Note— The minimum number of lights are shown for a runway 45 m wide with runway edge lights installed at the edge.

Figure 5-22. Arrangement of runway threshold and runway end lights



This Page Intentionally Left Blank



Characteristics of runway threshold and wing bar lights

- 5.3.10.9 Runway threshold and wing bar lights shall be fixed unidirectional lights showing green in the direction of approach to the runway. The intensity and beam spread of the lights shall be adequate for the conditions of visibility and ambient light in which use of the runway is intended.
- 5.3.10.10 Runway threshold lights on a precision approach runway shall be in accordance with the specifications of Appendix 2 to ICAO Annex 14, Volume 1, Figure A2-3.
- 5.3.10.11 Threshold wing bar lights on a precision approach runway shall be in accordance with the specifications of Appendix 2 to ICAO Annex 14, Volume 1, Figure A2-4.
- 5.3.11 Runway end lights (see Figure 5-22 to ICAO Annex 14, Volume 1)

Application

- 5.3.11.1 Runway end lights shall be provided for a runway equipped with runway edge lights.

Location

- 5.3.11.2 Runway end lights shall be placed on a line at right angles to the runway axis as near to the end of the runway as possible and, in any case, not more than 3 m outside the end.
- 5.3.11.3 Runway end lighting shall consist of at least six lights. The lights should be either:
- (a) equally spaced between the rows of runway edge lights; or
 - (b) symmetrically disposed about the runway centre line in two groups with the lights uniformly spaced in each group and with a gap between the groups of not more than half the distance between the rows of runway edge lights.

For a precision approach runway category III, the spacing between runway end lights, except between the two innermost lights if a gap is used, should not exceed 6 m.

Characteristics

- 5.3.11.4 Runway end lights shall be fixed unidirectional lights showing red in the direction of the runway. The intensity and beam spread of the lights shall be adequate for the conditions of visibility and ambient light in which use of the runway is intended.
- 5.3.11.5 Runway end lights on a precision approach runway shall be in accordance with the specifications of Appendix 2 to ICAO Annex 14, Volume 1, Figure A2-8.

5.3.12 Runway centre line lights

Application

- 5.3.12.1 Runway centre line lights shall be provided on a precision approach runway category II or III.
- 5.3.12.2 Runway centre line lights shall be provided on a precision approach runway category I, particularly when the runway is used by aircraft with high landing speeds or where the width between the runway edge lights is greater than 50 m.



- 5.3.12.3 Runway centre line lights shall be provided on a runway intended to be used for take-off with an operating minimum below an RVR of the order of 400 m.
- 5.3.12.4 Runway centre line lights shall be provided on a runway intended to be used for take-off with an operating minimum of an RVR of the order of 400 m or higher when used by aeroplanes with a very high take-off speed, particularly where the width between the runway edge lights is greater than 50m.

Location

- 5.3.12.5 Runway centre line lights shall be located along the centre line of the runway, except that the lights may be uniformly offset to the same side of the runway centre line by not more than 60 cm where it is not practicable to locate them along the centre line. The lights shall be located from the threshold to the end at longitudinal spacing of approximately 15 m. Where the serviceability level of the runway centre line lights specified as maintenance objectives in 10.5.7 or 10.5.11, as appropriate, can be demonstrated and the runway is intended for use in runway visual range conditions of 350 m or greater, the longitudinal spacing may be approximately 30 m.
- 5.3.12.6 Centre line guidance for take-off from the beginning of a runway to a displaced threshold should be provided by:
- an approach lighting system if its characteristics and intensity settings afford the guidance required during take-off and it does not dazzle the pilot of an aircraft taking off; or
 - runway centre line lights; or
 - barrettes of at least 3 m in length and spaced at uniform intervals of 30 m, as shown in Figure 5-23, designed so that their photometric characteristics and intensity setting afford the guidance required during take-off without dazzling the pilot of an aircraft taking off.

Where necessary, provision should be made to extinguish those centre line lights specified in b) or reset the intensity of the approach lighting system or barrettes when the runway is being used for landing. In no case should only the single source runway centre line lights show from the beginning of the runway to a displaced threshold when the runway is being used for landing.

Characteristics

- 5.3.12.7 Runway centre line lights shall be fixed lights showing variable white from the threshold to the point 900 m from the runway end; alternate red and variable white from 900 m to 300 m from the runway end; and red from 300 m to the runway end, except that for runways less than 1 800 m in length, the alternate red and variable white lights shall extend from the midpoint of the runway usable for landing to 300 m from the runway end.

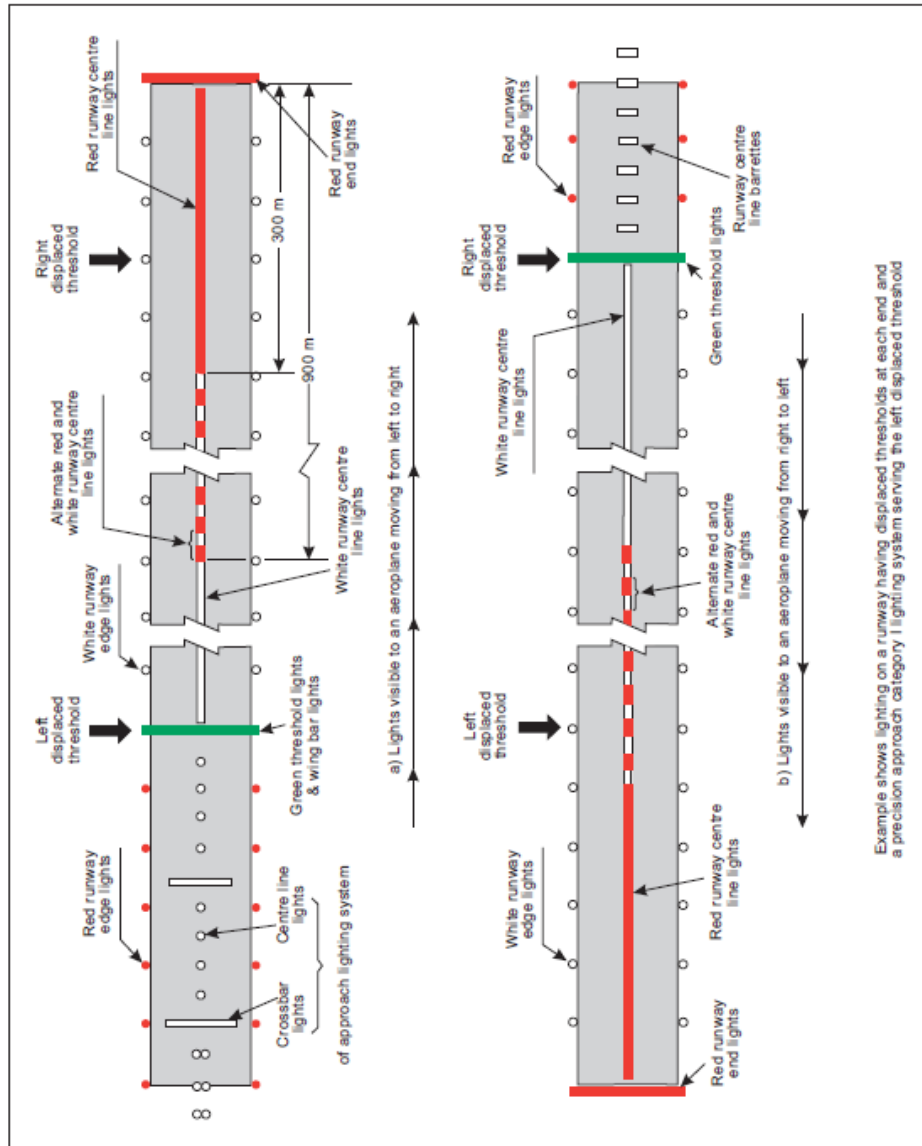

Example shows lighting on a runway having displaced thresholds at each end and a precision approach category I lighting system serving the left displaced threshold

Figure 5-23. Example of approach and runway lighting for runway with displaced thresholds

5.3.12.8 Runway centre line lights shall be in accordance with the specifications of Appendix 2 to ICAO Annex 14, Volume 1, Figure A2-6 or A2-7.

5.3.13 Runway touchdown zone lights

Application

5.3.13.1 Touchdown zone (TDZ) lights shall be provided in the touchdown zone of a precision approach runway category II or III.

Location

5.3.13.2 Touchdown zone lights shall extend from the threshold for a longitudinal distance of 900 m, except that, on runways less than 1 800 m in length, the system shall be shortened so that it does not extend beyond the midpoint of the runway. The pattern shall be formed by pairs of barrettes symmetrically located about the runway centre line. The lateral spacing between the innermost lights of a pair of barrettes shall be equal to the lateral spacing selected for the touchdown zone marking. The longitudinal spacing between pairs of barrettes shall be either 30 m or 60 m.

Characteristics

- 5.3.13.3 A barrette shall be composed of at least three lights with a spacing between the lights of not more than 1.5 m.
- 5.3.13.4 A barrette shall be not less than 3 m nor more than 4.5 m in length.
- 5.3.13.5 Touchdown zone lights shall be fixed unidirectional lights showing variable white.
- 5.3.13.6 Touchdown zone lights shall be in accordance with the specifications of Appendix 2 to ICAO Annex 14, Volume 1, Figure A2-5.
- 5.3.14 Simple touchdown zone lights

Application

- 5.3.14.1 Except where TDZ lights are provided in accordance with paragraph 5.3.13, at an aerodrome where the approach angle is greater than 3.5 degrees and/or the Landing Distance Available combined with other factors increases the risk of an overrun, simple touchdown zone lights should be provided.

Location

- 5.3.14.2 Simple touchdown zone lights shall be a pair of lights located on each side of the runway centreline 0.3 m beyond the upwind edge of the final touchdown zone marking. The lateral spacing between the inner lights of the two pairs of lights shall be equal to the lateral spacing selected for the touchdown zone marking. The spacing between the lights of the same pair shall not be more than 1.5 m or half the width of the touchdown zone marking, whichever is greater. (See Figure 5-24.)
- 5.3.14.3 Where provided on a runway without TDZ markings, simple touchdown zone lights should be installed in such a position that provides the equivalent TDZ information.

Characteristics

- 5.3.14.4 Simple touchdown zone lights shall be fixed unidirectional lights showing variable white, aligned so as to be visible to the pilot of a landing aeroplane in the direction of approach to the runway.
- 5.3.14.5 Simple touchdown zone lights shall be in accordance with the specifications in Appendix 2 to ICAO Annex 14, Volume 1, Figure A2-5.

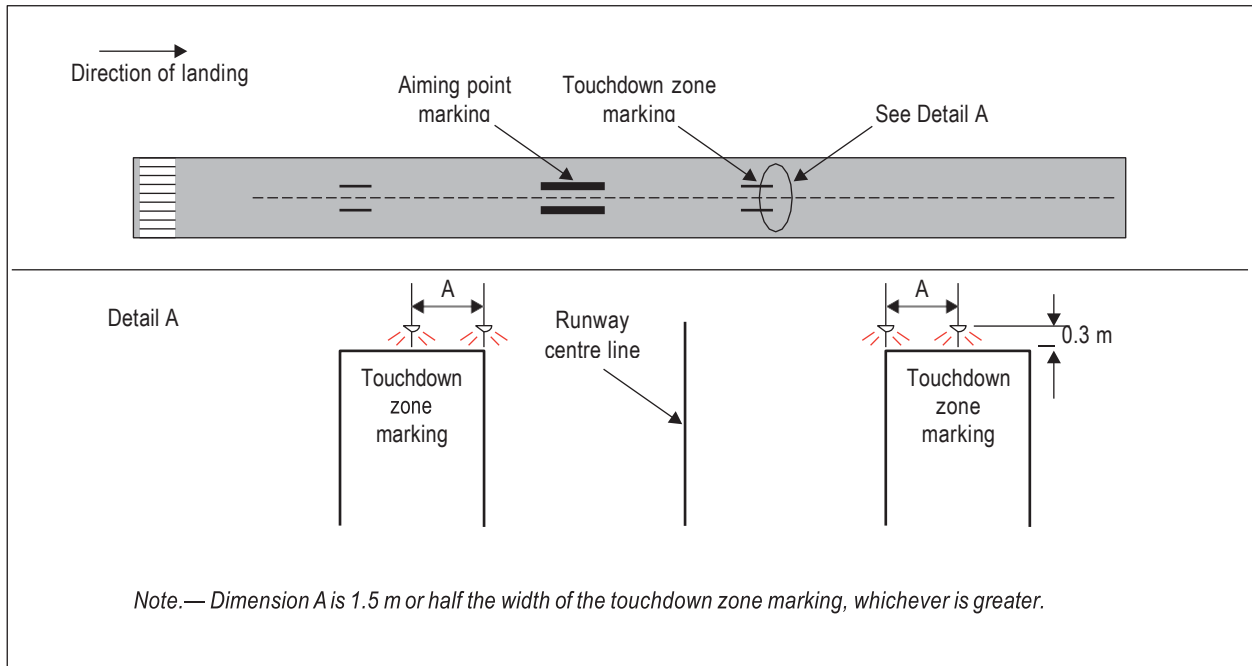

Figure 5-24. Simple touchdown zone lighting

5.3.15 Rapid exit taxiway indicator lights

Application

5.3.15.1 Rapid exit taxiway indicator lights shall be provided on a runway intended for use in runway visual range conditions less than a value of 350 m and/or where the traffic density is heavy.

5.3.15.2 Rapid exit taxiway indicator lights shall not be displayed in the event of any lamp failure or other failure that prevents the display of the light pattern depicted in Figure 5-25, in full.

Location

5.3.15.3 A set of rapid exit taxiway indicator lights shall be located on the runway on the same side of the runway centre line as the associated rapid exit taxiway, in the configuration shown in Figure 5-25. In each set, the lights shall be located 2 m apart and the light nearest to the runway centre line shall be displaced 2 m from the runway centre line.

5.3.15.4 Where more than one rapid exit taxiway exists on a runway, the set of rapid exit taxiway indicator lights for each exit shall not overlap when displayed.

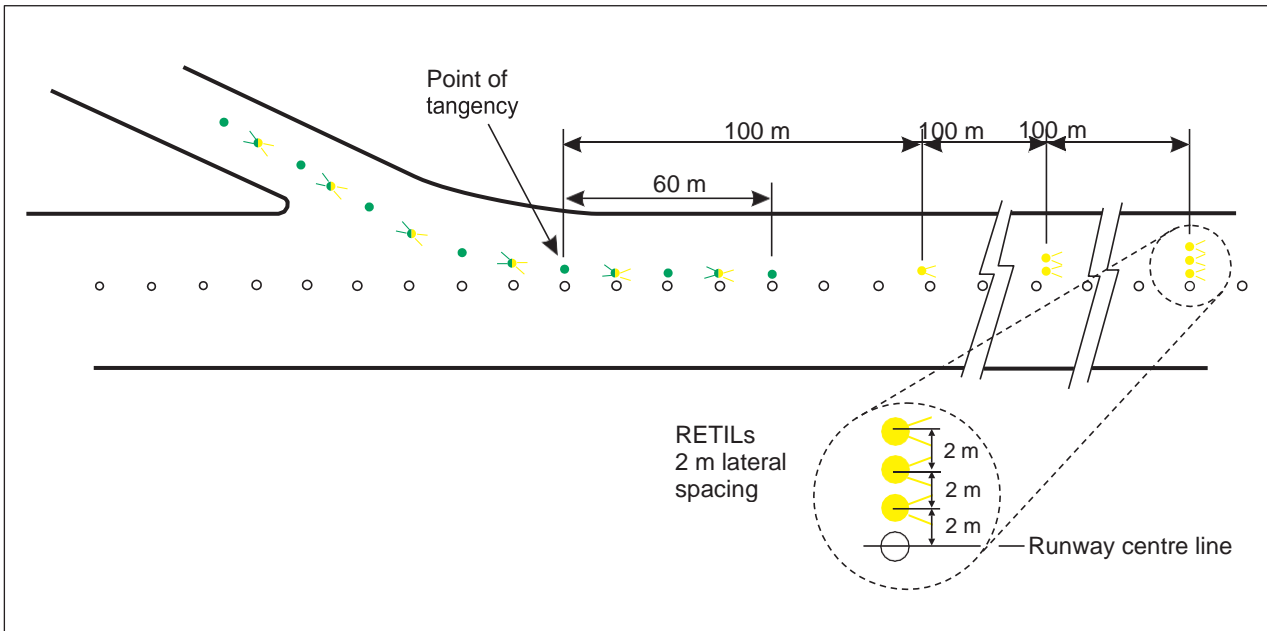

Figure 5-25. Rapid exit taxiway indicator lights (RETILS)

Characteristics

- 5.3.15.5 Rapid exit taxiway indicator lights shall be fixed unidirectional yellow lights, aligned so as to be visible to the pilot of a landing aeroplane in the direction of approach to the runway.
- 5.3.15.6 Rapid exit taxiway indicator lights shall be in accordance with the specifications in Appendix 2 to ICAO Annex 14, Volume 1, Figure A2-6 or Figure A2-7, as appropriate.
- 5.3.15.7 Rapid exit taxiway indicator lights should be supplied with power on a separate circuit to other runway lighting so that they may be used when other lighting is switched off.

5.3.16 Stopway lights

Application

- 5.3.16.1 Stopway lights shall be provided for a stopway intended for use at night.

Location

- 5.3.16.2 Stopway lights shall be placed along the full length of the stopway and shall be in two parallel rows that are equidistant from the centre line and coincident with the rows of the runway edge lights. Stopway lights shall also be provided across the end of a stopway on a line at right angles to the stopway axis as near to the end of the stopway as possible and, in any case, not more than 3 m outside the end.

Characteristics

- 5.3.16.3 Stopway lights shall be fixed unidirectional lights showing red in the direction of the runway.

5.3.17 Taxiway centre line lights



Application

- 5.3.17.1 Taxiway centre line lights shall be provided on an exit taxiway, taxiway and apron intended for use in runway visual range conditions less than a value of 350 m in such a manner as to provide continuous guidance between the runway centre line and aircraft stands, except that these lights need not be provided where the traffic density is light and taxiway edge lights and centre line marking provide adequate guidance.
- 5.3.17.2 Taxiway centre line lights shall be provided on a taxiway intended for use at night in runway visual range conditions of 350 m or greater, and particularly on complex taxiway intersections and exit taxiways, except that these lights need not be provided where the traffic density is light and taxiway edge lights and centre line marking provide adequate guidance.
- 5.3.17.3 Taxiway centre line lights shall be provided on an exit taxiway, taxiway and apron in all visibility conditions where specified as components of an advanced surface movement guidance and control system in such a manner as to provide continuous guidance between the runway centre line and aircraft stands.
- 5.3.17.4 Taxiway centre line lights shall be provided on a runway forming part of a standard taxi-route and intended for taxiing in runway visual range conditions less than a value of 350 m, except that these lights need not be provided where the traffic density is light and taxiway edge lights and centre line marking provide adequate guidance.
- 5.3.17.5 Taxiway centre line lights shall be provided in all visibility conditions on a runway forming part of a standard taxi-route where specified as components of an advanced surface movement guidance and control system.

Characteristics

- 5.3.17.6 Except as provided for in 5.3.17.8, taxiway centre line lights on a taxiway other than an exit taxiway and on a runway forming part of a standard taxi-route shall be fixed lights showing green with beam dimensions such that the light is visible only from aeroplanes on or in the vicinity of the taxiway.
- 5.3.17.7 Taxiway centre line lights on an exit taxiway shall be fixed lights. Alternate taxiway centre line lights shall show green and yellow from their beginning near the runway centre line to the perimeter of the ILS/MLS critical/sensitive area or the lower edge of the inner transitional surface, whichever is farthest from the runway; and thereafter all lights shall show green (Figure 5-26). The first light in the exit centre line shall always show green, and the light nearest to the perimeter shall always show yellow.
- 5.3.17.8 Where it is necessary to denote the proximity to a runway, taxiway centre line lights should be fixed lights showing alternating green and yellow from the perimeter of the ILS/MLS critical/sensitive area or the lower edge of the inner transitional surface, whichever is farthest from the runway, to the runway and continue alternating green and yellow until:
- (a) their end point near the runway centre line; or
 - (b) in the case of the taxiway centre line lights crossing the runway, to the opposite perimeter of the ILS/MLS critical/sensitive area or the lower edge of the inner transitional surface, whichever is farthest from the runway.

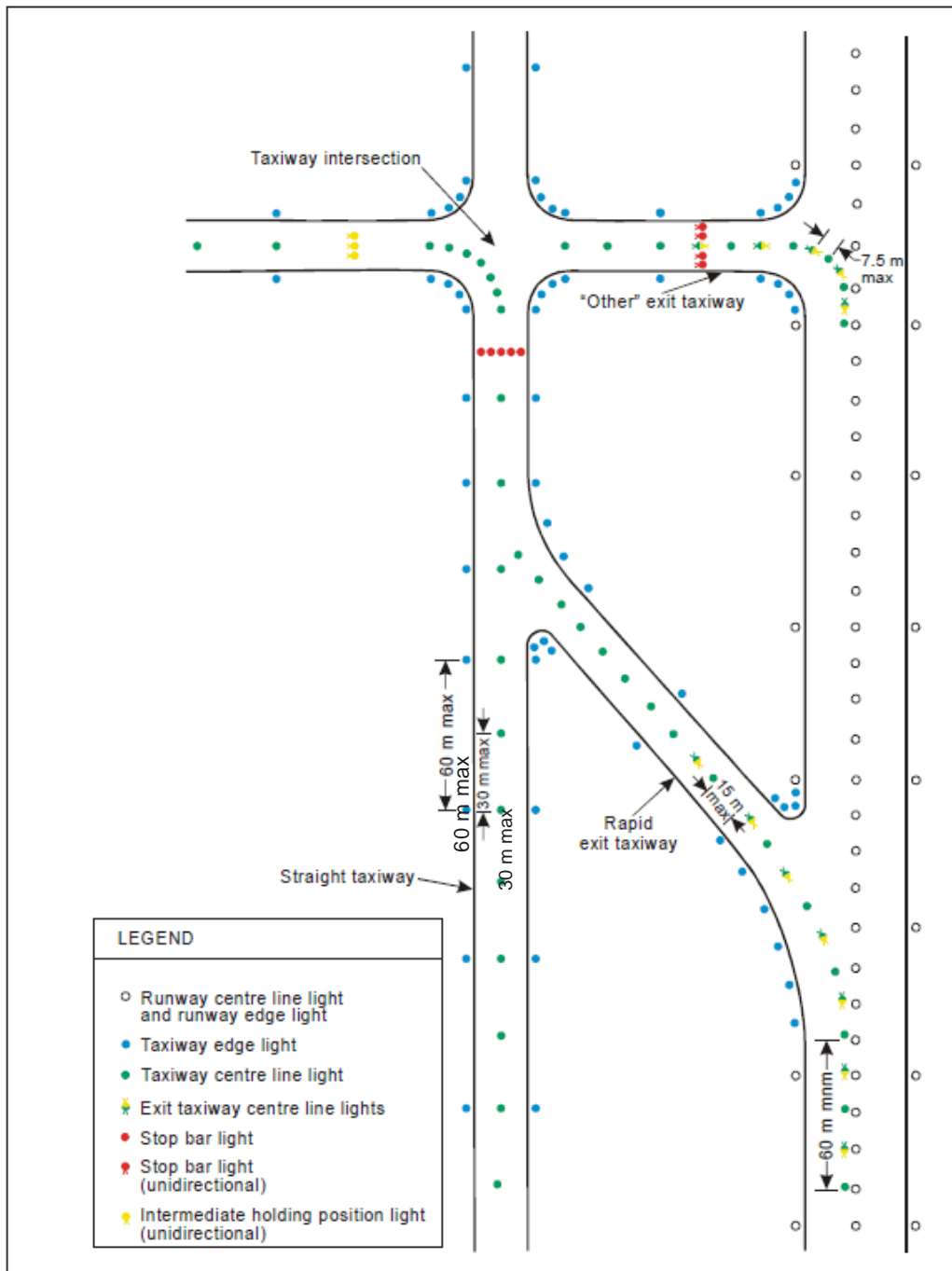

Figure 5-26. Taxiway lighting

5.3.17.9 Taxiway centre line lights shall be in accordance with the specifications of:

- (a) Appendix 2 to ICAO Annex 14, Volume 1, Figure A2-12, A2-13, or A2-14, for taxiways intended for use in runway visual range conditions of less than a value of 350 m; and
- (b) Appendix 2 to ICAO Annex 14, Volume 1, Figure A2-15 or A2-16, for other taxiways.

5.3.17.10 Where higher intensities are required, from an operational point of view, taxiway centre line lights on rapid exit taxiways intended for use in runway visual range conditions less than a value of 350 m should be in accordance with the specifications of Appendix 2 to ICAO Annex 14, Volume 1, Figure A2-12. The number of levels of brilliancy settings for these lights should be the same as that for the runway centre line lights.

5.3.17.11 Where taxiway centre line lights are specified as components of an advanced surface movement guidance and control system and where, from an operational point of view, higher intensities are required to maintain ground movements at a certain speed in very low visibilities or in bright daytime conditions, taxiway centre line lights should be in accordance with the specifications of Appendix 2 to ICAO Annex 14, Volume 1, Figure A2-17, A2-18 or A2-19.

Location

5.3.17.12 Taxiway centre line lights shall normally be located on the taxiway centre line marking, except that they may be offset by not more than 30 cm where it is not practicable to locate them on the marking.

Taxiway centre line lights on taxiways

Location

5.3.17.13 Taxiway centre line lights on a straight section of a taxiway shall be spaced at longitudinal intervals of not more than 30 m, except that:

- (a) larger intervals not exceeding 60 m may be used where, because of the prevailing meteorological conditions, adequate guidance is provided by such spacing;
- (b) intervals less than 30 m shall be provided on short straight sections; and
- (c) on a taxiway intended for use in RVR conditions of less than a value of 350 m, the longitudinal spacing should not exceed 15 m.

5.3.17.14 Taxiway centre line lights on a taxiway curve shall continue from the straight portion of the taxiway at a constant distance from the outside edge of the taxiway curve. The lights should be spaced at intervals such that a clear indication of the curve is provided.

5.3.17.15 On a taxiway intended for use in RVR conditions of less than a value of 350 m, the lights on a curve should not exceed a spacing of 15 m, and on a curve of less than 400 m radius the lights should be spaced at intervals of not greater than 7.5 m. This spacing should extend for 60 m before and after the curve.

Taxiway centre line lights on rapid exit taxiways

Location

5.3.17.16 Taxiway centre line lights on a rapid exit taxiway shall commence at a point at least 60 m before the beginning of the taxiway centre line curve and continue beyond the end of the curve to a point on the centre line of the taxiway where an aeroplane can be expected to reach normal taxiing speed. The lights on that portion parallel to the runway centre line should always be at least 60 cm from any row of runway centre line lights, as shown in Figure 5-27.

5.3.17.17 The lights shall be spaced at longitudinal intervals of not more than 15 m, except that, where runway centre line lights are not provided, a greater interval not exceeding 30 m may be used.

Taxiway centre line lights on other exit taxiways

Location

5.3.17.18 Taxiway centre line lights on exit taxiways other than rapid exit taxiways shall commence at the point where the taxiway centre line marking begins to curve from the runway centre line, and follow the curved taxiway centre line marking at least to the point where the marking leaves the runway. The first light should be at least 60 cm from any row of runway centre line lights, as shown in Figure 5-27.

5.3.17.19 The lights shall be spaced at longitudinal intervals of not more than 7.5 m.

Taxiway centre line lights on runways

Location

5.3.17.20 Taxiway centre line lights on a runway forming part of a standard taxi-route and intended for taxiing in runway visual range conditions less than a value of 350 m should be spaced at longitudinal intervals not exceeding 15 m.

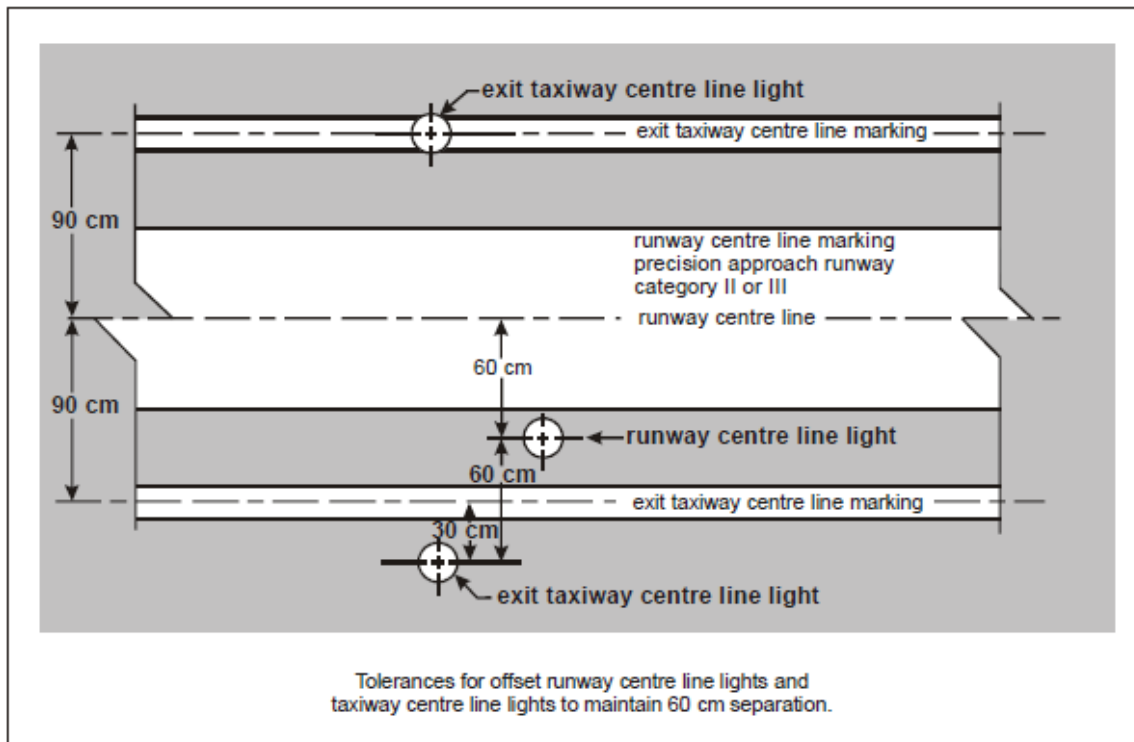

Figure 5-27. Offset runway and taxiway centre line lights

5.3.18 Taxiway edge lights

Application

5.3.18.1 Taxiway edge lights shall be provided at the edges of a runway turn pad, holding bay, apron, etc., intended for use at night and on a taxiway not provided with taxiway centre line lights and intended for use at night, except that taxiway edge lights need not be provided where, considering the nature of the operations, adequate guidance can be achieved by surface illumination or other means.

5.3.18.2 Taxiway edge lights shall be provided on a runway forming part of a standard taxi-route and intended for taxiing at night where the runway is not provided with taxiway centre line lights.

**Location**

- 5.3.18.3 Taxiway edge lights on a straight section of a taxiway and on a runway forming part of a standard taxi-route shall be spaced at uniform longitudinal intervals of not more than 60 m. The lights on a curve should be spaced at intervals less than 60 m so that a clear indication of the curve is provided.
- 5.3.18.4 Taxiway edge lights on a holding bay, apron, etc., should be spaced at uniform longitudinal intervals of not more than 60 m.
- 5.3.18.5 Taxiway edge lights on a runway turn pad shall be spaced at uniform longitudinal intervals of not more than 30 m.
- 5.3.18.6 The lights shall be located as near as practicable to the edges of the taxiway, runway turn pad, holding bay, apron or runway, etc., or outside the edges at a distance of not more than 3 m.

Characteristics

- 5.3.18.7 Taxiway edge lights shall be fixed lights showing blue. The lights shall show up to at least 75° above the horizontal and at all angles in azimuth necessary to provide guidance to a pilot taxiing in either direction. At an intersection, exit or curve the lights shall be shielded as far as practicable so that they cannot be seen in angles of azimuth in which they may be confused with other lights.
- 5.3.18.8 The intensity of taxiway edge lights shall be at least 2 cd from 0° to 6° vertical, and 0.2 cd at any vertical angles between 6° and 75°.

5.3.19 Runway turn pad lights**Application**

- 5.3.19.1 Runway turn pad lights shall be provided for continuous guidance on a runway turn pad intended for use in runway visual range conditions less than a value of 350 m, to enable an aeroplane to complete a 180-degree turn and align with the runway centre line.
- 5.3.19.2 Runway turn pad lights shall be provided on a runway turn pad intended for use at night.

Location

- 5.3.19.3 Runway turn pad lights shall normally be located on the runway turn pad marking, except that they may be offset by not more than 30 cm where it is not practicable to locate them on the marking.
- 5.3.19.4 Runway turn pad lights on a straight section of the runway turn pad marking shall be spaced at longitudinal intervals of not more than 15 m.
- 5.3.19.5 Runway turn pad lights on a curved section of the runway turn pad marking shall not exceed a spacing of 7.5 m.

Characteristics

- 5.3.19.6 Runway turn pad lights shall be unidirectional fixed lights showing green with beam dimensions such that the light is visible only from aeroplanes on or approaching the runway turn



pad.

5.3.19.7 Runway turn pad lights shall be in accordance with the specifications of Appendix 2 to ICAO Annex 14, Volume 1, Figure A2-13, A2-14 or A2-15, as appropriate.

5.3.20 Stop bars

Application

5.3.20.1 A stop bar shall be provided at every runway-holding position serving a runway when it is intended that the runway will be used in runway visual range conditions less than a value of 550 m, except where:

- (a) appropriate aids and procedures are available to assist in preventing inadvertent incursions of traffic onto the runway; or
- (b) operational procedures exist to limit, in runway visual range conditions less than a value of 550 m, the number of:
 - (1) aircraft on the manoeuvring area to one at a time; and
 - (2) vehicles on the manoeuvring area to the essential minimum.

5.3.20.2 Where there is more than one stop bar associated with a taxiway/runway intersection, only one shall be illuminated at any given time.

5.3.20.3 A stop bar shall be provided at an intermediate holding position when it is desired to supplement markings with lights and to provide traffic control by visual means.

Location

5.3.20.4 Stop bars shall be located across the taxiway at the point where it is desired that traffic stop. Where the additional lights specified in 5.3.20.7 are provided, these lights shall be located not less than 3 m from the taxiway edge.

Characteristics

5.3.20.5 Stop bars shall consist of lights spaced at uniform intervals of no more than 3 m across the taxiway, showing red in the intended direction(s) of approach to the intersection or runway-holding position.

5.3.20.6 A pair of elevated lights shall be added to each end of the stop bar where the in-pavement stop bar lights might be obscured from a pilot's view, for example, by rain, or where a pilot may be required to stop the aircraft in a position so close to the lights that they are blocked from view by the structure of the aircraft.

5.3.20.7 Stop bars installed at a runway-holding position shall be unidirectional and shall show red in the direction of approach to the runway.

5.3.20.8 Where the additional lights specified in 5.3.20.7 are provided, these lights shall have the same characteristics as the lights in the stop bar, but shall be visible to approaching aircraft up to the stop bar position.



- 5.3.20.9 The intensity in red light and beam spreads of stop bar lights shall be in accordance with the specifications in Appendix 2 to ICAO Annex 14, Volume 1, Figures A2-12 through A2-16, as appropriate.
- 5.3.20.10 Where stop bars are specified as components of an advanced surface movement guidance and control system and where, from an operational point of view, higher intensities are required to maintain ground movements at a certain speed in very low visibilities or in bright daytime conditions, the intensity in red light and beam spreads of stop bar lights should be in accordance with the specifications of Appendix 2 to ICAO Annex 14, Volume 1, Figure A2-17, A2-18 or A2-19.
- 5.3.20.11 Where a wide beam fixture is required, the intensity in red light and beam spreads of stop bar lights should be in accordance with the specifications of Appendix 2 to ICAO Annex 14, Volume 1, Figure A2-17 or A2-19.
- 5.3.20.12 The lighting circuit shall be designed so that:
- (a) stop bars located across entrance taxiways are selectively switchable;
 - (b) stop bars located across taxiways intended to be used only as exit taxiways are switchable selectively or in groups;
 - (c) when a stop bar is illuminated, any taxiway centre line lights installed beyond the stop bar shall be extinguished for a distance of at least 90 m; and
 - (d) stop bars are interlocked with the taxiway centre line lights so that when the centre line lights beyond the stop bar are illuminated the stop bar is extinguished and vice versa.

5.3.21 Intermediate holding position lights

Application

- 5.3.21.1 Except where a stop bar has been installed, intermediate holding position lights shall be provided at an intermediate holding position intended for use in runway visual range conditions less than a value of 350 m.
- 5.3.21.2 Intermediate holding position lights should be provided at an intermediate holding position where there is no need for stop-and-go signals as provided by a stop bar.

Location

- 5.3.21.3 Intermediate holding position lights shall be located along the intermediate holding position marking at a distance of 0.3 m prior to the marking.

Characteristics

- 5.3.21.4 Intermediate holding position lights shall consist of three fixed unidirectional lights showing yellow in the direction of approach to the intermediate holding position with a light distribution similar to taxiway centre line lights if provided. The lights shall be disposed symmetrically about and at right angle to the taxiway centre line, with individual lights spaced 1.5 m apart.

5.3.22 De-icing/anti-icing facility exit lights

Not applicable.

5.3.23 Runway guard lights

Application

5.3.23.1 Runway guard lights, Configuration A, shall be provided at each taxiway/runway intersection associated with a runway intended for use in:

- (a) runway visual range conditions less than a value of 550 m where a stop bar is not installed; and
- (b) runway visual range conditions of values between 550 m and 1 200 m where the traffic density is heavy.

5.3.23.2 As part of runway incursion prevention measures, runway guard lights, Configuration A or B, should be provided at each taxiway/runway intersection where runway incursion hot spots have been identified, and used under all weather conditions during day and night.

5.3.23.3 Configuration B runway guard lights shall not be collocated with a stop bar.

5.3.23.4 Where more than one runway-holding positions exist at a runway/taxiway intersection, only the set of runway guard lights associated with the operational runway-holding position shall be illuminated.

Location

5.3.23.5 Runway guard lights, Configuration A, shall be located at each side of the taxiway on the holding side of the runway-holding position marking.

5.3.23.6 Runway guard lights, Configuration B, shall be located across the taxiway on the holding side of the runway-holding position marking.

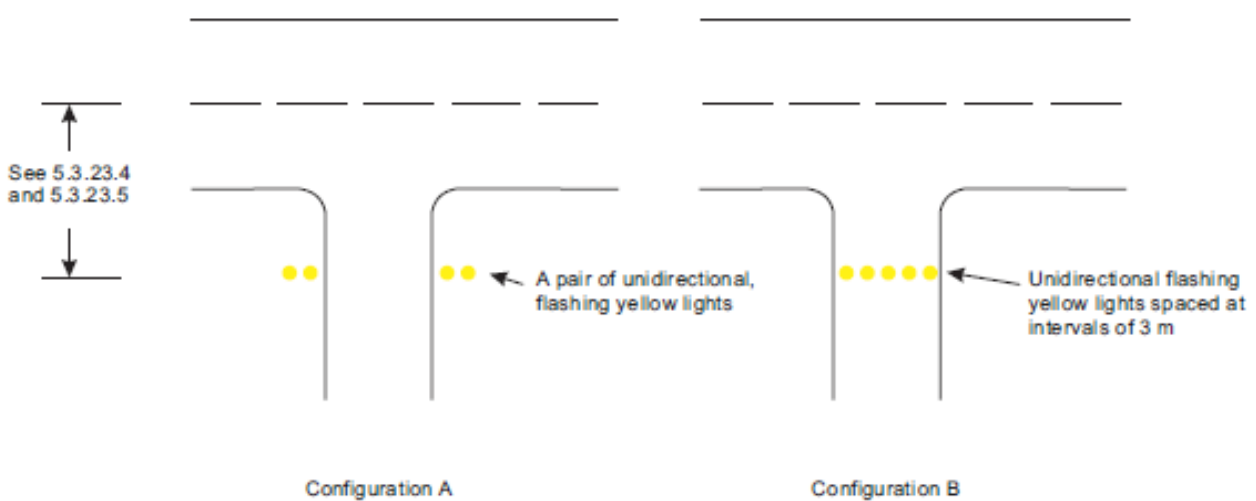

Figure 5-29. Runway guard lights



Characteristics

- 5.3.23.7 Runway guard lights, Configuration A, shall consist of two pairs of yellow lights.
- 5.3.23.8 Where there is a need to enhance the contrast between the on and off state of runway guard lights, Configuration A, intended for use during the day, a visor of sufficient size to prevent sunlight from entering the lens without interfering with the function of the fixture should be located above each lamp.
- 5.3.23.9 Runway guard lights, Configuration B, shall consist of yellow lights spaced at intervals of 3 m across the taxiway.
- 5.3.23.10 The light beam shall be unidirectional and shall show yellow in the direction of approach to the runway holding position.
- 5.3.23.11 The intensity in yellow light and beam spreads of lights of Configuration A shall be in accordance with the specifications in Appendix 2 to ICAO Annex 14, Volume 1, Figure A2-24.
- 5.3.23.12 Where runway guard lights are intended for use during the day, the intensity in yellow light and beam spreads of lights of Configuration A should be in accordance with the specifications in Appendix 2 to ICAO Annex 14, Volume 1, Figure A2-25.
- 5.3.23.13 Where runway guard lights are specified as components of an advanced surface movement guidance and control system where higher light intensities are required, the intensity in yellow light and beam spreads of lights of Configuration A shall be in accordance with the specifications in Appendix 2 to ICAO Annex 14, Volume 1, Figure A2-25.
- 5.3.23.14 The intensity in yellow light and beam spreads of lights of Configuration B should be in accordance with the specifications in Appendix 2 to ICAO Annex 14, Volume 1, Figure A2-12.
- 5.3.23.15 Where runway guard lights are intended for use during the day, the intensity in yellow light and beam spreads of lights of Configuration B shall be in accordance with the specifications in Appendix 2 to ICAO Annex 14, Volume 1, Figure A2-20.
- 5.3.23.16 Where runway guard lights are specified as components of an advanced surface movement guidance and control system where higher light intensities are required, the intensity in yellow light and beam spreads of lights of Configuration B shall be in accordance with the specifications in Appendix 2 to ICAO Annex 14, Volume 1, Figure A2-20.
- 5.3.23.17 The lights in each unit of Configuration A shall be illuminated alternately.
- 5.3.23.18 For Configuration B, adjacent lights shall be alternately illuminated and alternative lights shall be illuminated in unison.
- 5.3.23.19 The lights shall be illuminated between 30 and 60 cycles per minute and the light suppression and illumination periods shall be equal and opposite in each light.
- 5.3.24 Apron floodlighting
(see also 5.3.17.1 and 5.3.18.1)

Application

- 5.3.24.1 Apron floodlighting shall be provided on an apron and on a designated isolated aircraft

parking position intended to be used at night.

Location

5.3.24.2 Apron floodlights shall be located so as to provide adequate illumination on all apron service areas, with a minimum of glare to pilots of aircraft in flight and on the ground, aerodrome and apron controllers, and personnel on the apron. The arrangement and aiming of floodlights should be such that an aircraft stand receives light from two or more directions to minimize shadows.

Characteristics

5.3.24.3 The spectral distribution of apron floodlights shall be such that the colours used for aircraft marking connected with routine servicing, and for surface and obstacle marking, can be correctly identified.

5.3.24.4 The average illuminance should be at least the following:

Aircraft stand:

- horizontal illuminance — 20 lux with a uniformity ratio (average to minimum) of not more than 4 to 1; and
- vertical illuminance — 20 lux at a height of 2 m above the apron in relevant directions.

Other apron areas:

- horizontal illuminance — 50 per cent of the average illuminance on the aircraft stands with a uniformity ratio (average to minimum) of not more than 4 to 1.

5.3.25 Visual docking guidance system

Application

5.3.25.1 A visual docking guidance system shall be provided when it is intended to indicate, by a visual aid, the precise positioning of an aircraft on an aircraft stand and other alternative means, such as marshallers, are not practicable.

Characteristics

5.3.25.2 The system shall provide both azimuth and stopping guidance.

5.3.25.3 The azimuth guidance unit and the stopping position indicator shall be adequate for use in all weather, visibility, background lighting and pavement conditions for which the system is intended, both by day and night, but shall not dazzle the pilot.

5.3.25.4 The azimuth guidance unit and the stopping position indicator shall be of a design such that:

- (a) a clear indication of malfunction of either or both is available to the pilot; and
- (b) they can be turned off.

5.3.25.5 The azimuth guidance unit and the stopping position indicator shall be located in such a way that there is continuity of guidance between the aircraft stand markings, the aircraft stand



manoeuvring guidance lights, if present, and the visual docking guidance system.

5.3.25.6 The accuracy of the system shall be adequate for the type of loading bridge and fixed aircraft servicing installations with which it is to be used.

5.3.25.7 The system should be usable by all types of aircraft for which the aircraft stand is intended, preferably without selective operation.

5.3.25.8 If selective operation is required to prepare the system for use by a particular type of aircraft, then the system shall provide an identification of the selected aircraft type to both the pilot and the system operator as a means of ensuring that the system has been set properly.

Azimuth guidance unit

Location

5.3.25.9 The azimuth guidance unit shall be located on or close to the extension of the stand centre line ahead of the aircraft so that its signals are visible from the cockpit of an aircraft throughout the docking manoeuvre and aligned for use at least by the pilot occupying the left seat.

5.3.25.10 The azimuth guidance unit should be aligned for use by the pilots occupying both the left and right seats.

Characteristics

5.3.25.11 The azimuth guidance unit shall provide unambiguous left/right guidance which enables the pilot to acquire and maintain the lead-in line without over-controlling.

5.3.25.12 When azimuth guidance is indicated by colour change, green shall be used to identify the centre line and red for deviations from the centre line.

Stopping position indicator

Location

5.3.25.13 The stopping position indicator shall be located in conjunction with, or sufficiently close to, the azimuth guidance unit so that a pilot can observe both the azimuth and stop signals without turning the head.

5.3.25.14 The stopping position indicator shall be usable at least by the pilot occupying the left seat.

5.3.25.15 The stopping position indicator should be usable by the pilots occupying both the left and right seats.

Characteristics

5.3.25.16 The stopping position information provided by the indicator for a particular aircraft type shall account for the anticipated range of variations in pilot eye height and/or viewing angle.

5.3.25.17 The stopping position indicator shall show the stopping position for the aircraft for which guidance is being provided and shall provide closing rate information to enable the pilot to gradually decelerate the aircraft to a full stop at the intended stopping position.

- 5.3.25.18 The stopping position indicator should provide closing rate information over a distance of at least 10 m.
- 5.3.25.19 When stopping guidance is indicated by colour change, green shall be used to show that the aircraft can proceed and red to show that the stop point has been reached, except that for a short distance prior to the stop point a third colour may be used to warn that the stopping point is close.
- 5.3.26 Advanced visual docking guidance system

Application

- 5.3.26.1 An A-VDGS should be provided where it is operationally desirable to confirm the correct aircraft type for which guidance is being provided and/or to indicate the stand centre line in use, where more than one is provided for.
- 5.3.26.2 The A-VDGS shall be suitable for use by all types of aircraft for which the aircraft stand is intended.
- 5.3.26.3 The A-VDGS shall be used only in conditions in which its operational performance is specified.
- 5.3.26.4 The docking guidance information provided by an A-VDGS shall not conflict with that provided by a conventional visual docking guidance system on an aircraft stand if both types are provided and are in operational use. A method of indicating that the A-VDGS is not in operational use or is unserviceable shall be provided.

Location

- 5.3.26.5 The A-VDGS shall be located such that unobstructed and unambiguous guidance is provided to the person responsible for, and persons assisting, the docking of the aircraft throughout the docking manoeuvre.

Characteristics

- 5.3.26.6 The A-VDGS shall provide, at minimum, the following guidance information at the appropriate stage of the docking manoeuvre:
- (a) an emergency stop indication;
 - (b) the aircraft type and model for which the guidance is provided;
 - (c) an indication of the lateral displacement of the aircraft relative to the stand centre line;
 - (d) the direction of azimuth correction needed to correct a displacement from the stand centre line;
 - (e) an indication of the distance to the stop position;
 - (f) an indication when the aircraft has reached the correct stopping position; and
 - (g) a warning indication if the aircraft goes beyond the appropriate stop position.



- 5.3.26.7 The A-VDGS shall be capable of providing docking guidance information for all aircraft taxi speeds encountered during the docking manoeuvre.
- 5.3.26.8 The time taken from the determination of the lateral displacement to its display shall not result in a deviation of the aircraft, when operated in normal conditions, from the stand centre line greater than 1 m.
- 5.3.26.9 The information on displacement of the aircraft relative to the stand centre line and distance to the stopping position, when displayed, should be provided with the accuracy specified in Table 5-4.
- 5.3.26.10 Symbols and graphics used to depict guidance information shall be intuitively representative of the type of information provided.
- 5.3.26.11 Information on the lateral displacement of the aircraft relative to the stand centre line shall be provided at least 25 m prior to the stop position.
- 5.3.26.12 Continuous closure distance and closure rate shall be provided from at least 15 m prior to the stop position.
- 5.3.26.13 Where provided, closure distance displayed in numerals should be provided in metre integers to the stop position and displayed to 1 decimal place at least 3 m prior to the stop position.

Table 5-4. A-VDGS recommended displacement accuracy

Guidance information	Maximum deviation at stop position (stop area)	Maximum deviation at 9 m from stop position	Maximum deviation at 15 m from stop position	Maximum deviation at 25 m from stop position
Azimuth	±250 mm	±340 mm	±400 mm	±500 mm
Distance	±500 mm	±1 000 mm	±1 300 mm	Not specified

- 5.3.26.14 Throughout the docking manoeuvre, an appropriate means shall be provided on the A-VDGS to indicate the need to bring the aircraft to an immediate halt. In such an event, which includes a failure of the A-VDGS, no other information shall be displayed.
- 5.3.26.15 Provision to initiate an immediate halt to the docking procedure shall be made available to personnel responsible for the operational safety of the stand.
- 5.3.26.16 The word “stop” in red characters should be displayed when an immediate cessation of the docking manoeuvre is required.

5.3.27 Aircraft stand manoeuvring guidance lights

Application

- 5.3.27.1 Aircraft stand manoeuvring guidance lights shall be provided to facilitate the positioning of an aircraft on an aircraft stand on a paved apron intended for use in poor visibility conditions, unless adequate guidance is provided by other means.

Location

- 5.3.27.2 Aircraft stand manoeuvring guidance lights shall be collocated with the aircraft stand

markings.

Characteristics

- 5.3.27.3 Aircraft stand manoeuvring guidance lights, other than those indicating a stop position, shall be fixed yellow lights, visible throughout the segments within which they are intended to provide guidance.
- 5.3.27.4 The lights used to delineate lead-in, turning and lead-out lines should be spaced at intervals of not more than 7.5 m on curves and 15 m on straight sections.
- 5.3.27.5 The lights indicating a stop position shall be fixed unidirectional lights showing red.
- 5.3.27.6 The intensity of the lights should be adequate for the condition of visibility and ambient light in which the use of the aircraft stand is intended.
- 5.3.27.7 The lighting circuit should be designed so that the lights may be switched on to indicate that an aircraft stand is to be used and switched off to indicate that it is not to be used.
- 5.3.28 Road-holding position light

Application

- 5.3.28.1 A road-holding position light shall be provided at each road-holding position serving a runway when it is intended that the runway will be used in runway visual range conditions less than a value of 350 m.
- 5.3.28.2 A road-holding position light shall be provided at each road-holding position serving a runway when it is intended that the runway will be used in runway visual range conditions of values between 350 m and 550 m.

Location

- 5.3.28.3 A road-holding position light shall be located adjacent to the holding position marking 1.5 m (± 0.5 m) from one edge of the road, i.e. left or right as appropriate to the local traffic regulations.

Characteristics

- 5.3.28.4 The road-holding position light shall comprise:
- a controllable red (stop)/green (go) traffic light; or
 - a flashing-red light.
- 5.3.28.5 The road-holding position light beam shall be unidirectional and aligned so as to be visible to the driver of a vehicle approaching the holding position.
- 5.3.28.6 The intensity of the light beam shall be adequate for the conditions of visibility and ambient light in which the use of the holding position is intended, but shall not dazzle the driver.
- 5.3.28.7 The flash frequency of the flashing-red light shall be between 30 and 60 flashes per minute.



5.3.29 No-entry bar

Application

5.3.29.1 A no-entry bar shall be provided across a taxiway which is intended to be used as an exit only taxiway to assist in preventing inadvertent access of traffic to that taxiway.

Location

5.3.29.2 A no-entry bar shall be located across the taxiway at the end of an exit only taxiway where it is desired to prevent traffic from entering the taxiway in the wrong direction.

5.3.29.3 A no-entry bar should be co-located with a no-entry sign and/or no-entry marking.

Characteristics

5.3.29.4 A no-entry bar shall consist of unidirectional lights spaced at uniform intervals of no more than 3 m showing red in the intended direction(s) of approach to the runway.

5.3.29.5 A pair of elevated lights shall be added to each end of the no-entry bar where the in-pavement no entry bar lights might be obscured from a pilot's view, for example, by rain, or where a pilot may be required to stop the aircraft in a position so close to the lights that they are blocked from view by the structure of the aircraft.

5.3.29.6 The intensity in red light and beam spreads of no-entry bar lights shall be in accordance with the specifications in Appendix 2 to ICAO Annex 14, Volume 1, Figures A2-12 through A2-16, as appropriate.

5.3.29.7 Where no-entry bars are specified as components of an advanced surface movement guidance and control system and where, from an operational point of view, higher intensities are required to maintain ground movements at a certain speed in very low visibilities or in bright daytime conditions, the intensity in red light and beam spreads of no-entry bar lights should be in accordance with the specifications of Appendix 2 to ICAO Annex 14, Volume 1, Figure A2-17, A2-18 or A2-19.

5.3.29.8 Where a wide beam fixture is required, the intensity in red light and beam spreads of no-entry bar lights should be in accordance with the specifications of Appendix 2 to ICAO Annex 14, Volume 1, Figure A2-17 or A2-19.

5.3.29.9 Taxiway centre line lights installed beyond the no-entry bar, looking in the direction of the runway, shall not be visible when viewed from the taxiway.

5.3.30 Runway Status Lights

Location

5.3.30.1 Where provided, RELs shall be offset 0.6 m from the taxiway centre line on the opposite side to the taxiway centre line lights and begin 0.6 m before the runway-holding position extending to the edge of the runway. An additional single light shall be placed on the runway 0.6 m from the runway centre line and aligned with the last two taxiway RELs.



- 5.3.30.2 RELs shall consist of at least five light units and shall be spaced at a minimum of 3.8 m and a maximum of 15.2 m longitudinally, depending upon the taxiway length involved, except for a single light installed near the runway centre line.
- 5.3.30.3 Where provided, THLs shall be offset 1.8 m on each side of the runway centre line lights and extend, in pairs, starting at a point 115 m from the beginning of the runway and, thereafter, every 30 m for at least 450 m.

Characteristics

- 5.3.30.4 Where provided, RELs shall consist of a single line of fixed in pavement lights showing red in the direction of aircraft approaching the runway.
- 5.3.30.5 RELs shall illuminate as an array at each taxiway/runway intersection where they are installed less than 2 seconds after the system determines a warning is needed.
- 5.3.30.6 Intensity and beam spread of RELs shall be in accordance with the specifications of Appendix 2, Figures A2-12 and A2-14.
- 5.3.30.7 Where provided, THLs shall consist of two rows of fixed in pavement lights showing red facing the aircraft taking off.
- 5.3.30.8 THLs shall illuminate as an array on the runway less than 2 seconds after the system determines a warning is needed.
- 5.3.30.9 Intensity and beam spread of THLs shall be in accordance with the specifications of Appendix 2, Figure A2.
- 5.3.30.10 RELs and THLs should be automated to the extent that the only control over each system will be to disable one or both systems.

5.4 Signs

5.4.1 General

Application

- 5.4.1.1 Signs shall be provided to convey a mandatory instruction, information on a specific location or destination on a movement area or to provide other information to meet the requirements of 9.8.1.
- 5.4.1.2 A variable message sign shall be provided where:
- the instruction or information displayed on the sign is relevant only during a certain period of time; and/or
 - there is a need for variable predetermined information to be displayed on the sign to meet the requirements of 9.8.1.

Characteristics

- 5.4.1.3 Signs shall be frangible. Those located near a runway or taxiway shall be sufficiently low to preserve clearance for propellers and the engine pods of jet aircraft. The installed height of the sign shall not exceed the dimension shown in the appropriate column of Table 5-5.



5.4.1.4 Signs shall be rectangular, as shown in Figures 5-30 and 5-31 with the longer side horizontal.

5.4.1.5 The only signs on the movement area utilizing red shall be mandatory instruction signs.

5.4.1.6 The inscriptions on a sign shall be in accordance with the provisions of Appendix 4 to ICAO Annex 14, Volume 1.

Table 5-5. Location distances for taxiing guidance signs including runway exit signs

Sign height (mm)				Perpendicular distance from defined taxiway pavement edge to near side of sign	Perpendicular distance from defined runway pavement edge to near side of sign
Code number	Legend	Face (min.)	Installed (max.)		
1 or 2	200	300	700	5-11 m	3-10 m
1 or 2	300	450	900	5-11 m	3-10 m
3 or 4	300	450	900	11-21 m	8-15 m
3 or 4	400	600	1100	11-21 m	8-15 m



Runway designation of a runway extremity (Example)	25	Indicates a runway-holding position at a runway extremity
Runway designation of both extremities of a runway (Example)	25-07	Indicates a runway-holding position located at taxiway/runway intersection other than runway extremity
Category I hold position (Example)	25 CAT I	Indicates a category I runway-holding position at the threshold of runway 25
Category II hold position (Example)	25 CAT II	Indicates a category II runway-holding position at the threshold of runway 25
Category III hold position (Example)	25 CAT III	Indicates a category III runway-holding position at the threshold of runway 25
Category II and III hold position (Example)	25 CAT II/III	Indicates a joint category II and III runway-holding position at the threshold of runway 25
Category I, II and III hold position (Example)	25 CAT I/II/III	Indicates a joint category I, II and III runway-holding position at the threshold of runway 25
NO ENTRY	⊖	Indicates that entry to an area is prohibited
Runway-holding position (Example)	B2	Indicates a runway-holding position (in accordance with 3.12.3)

Figure 5-30. Mandatory instruction signs

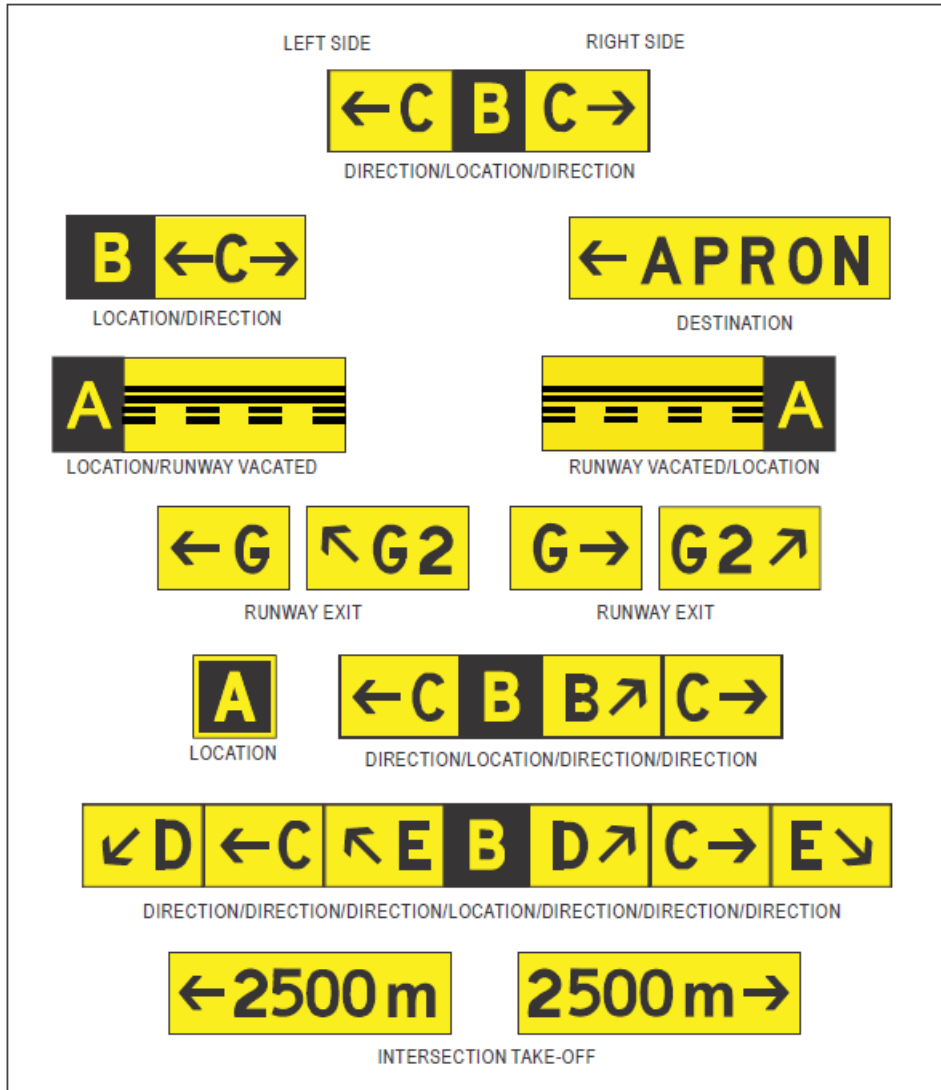

Figure 5-31. Information signs

5.4.1.7 Signs shall be illuminated in accordance with the provisions of Appendix 4 to ICAO Annex 14, Volume 1 when intended for use:

- (a) in runway visual range conditions less than a value of 800 m; or
- (b) at night in association with instrument runways; or
- (c) at night in association with non-instrument runways where the code number is 3 or 4.

5.4.1.8 Signs shall be retroreflective and/or illuminated in accordance with the provisions of Appendix 4 to ICAO Annex 14, Volume 1 when intended for use at night in association with non-instrument runways where the code number is 1 or 2.

5.4.1.9 A variable message sign shall show a blank face when not in use.

5.4.1.10 In case of failure, a variable message sign shall not provide information that could lead to unsafe action from a pilot or a vehicle driver.

5.4.1.11 The time interval to change from one message to another on a variable message sign should be as short as practicable and should not exceed 5 seconds.



5.4.2 Mandatory instruction signs

Application

5.4.2.1 A mandatory instruction sign shall be provided to identify a location beyond which an aircraft taxiing or vehicle shall not proceed unless authorized by the aerodrome control tower.

5.4.2.2 Mandatory instruction signs shall include runway designation signs, category I, II or III holding position signs, runway-holding position signs, road-holding position signs and NO ENTRY signs.

5.4.2.3 A pattern “A” runway-holding position marking shall be supplemented at a taxiway/runway intersection or a runway/runway intersection with a runway designation sign.

5.4.2.4 A pattern “B” runway-holding position marking shall be supplemented with a category I, II or III holding position sign.

5.4.2.5 A pattern “A” runway-holding position marking at a runway-holding position established in accordance with 3.12.3 shall be supplemented with a runway-holding position sign.

5.4.2.6 A runway designation sign at a taxiway/runway intersection should be supplemented with a location sign in the outboard (farthest from the taxiway) position, as appropriate.

Note.— See 5.4.3 for characteristics of location signs.

5.4.2.7 A NO ENTRY sign shall be provided when entry into an area is prohibited.

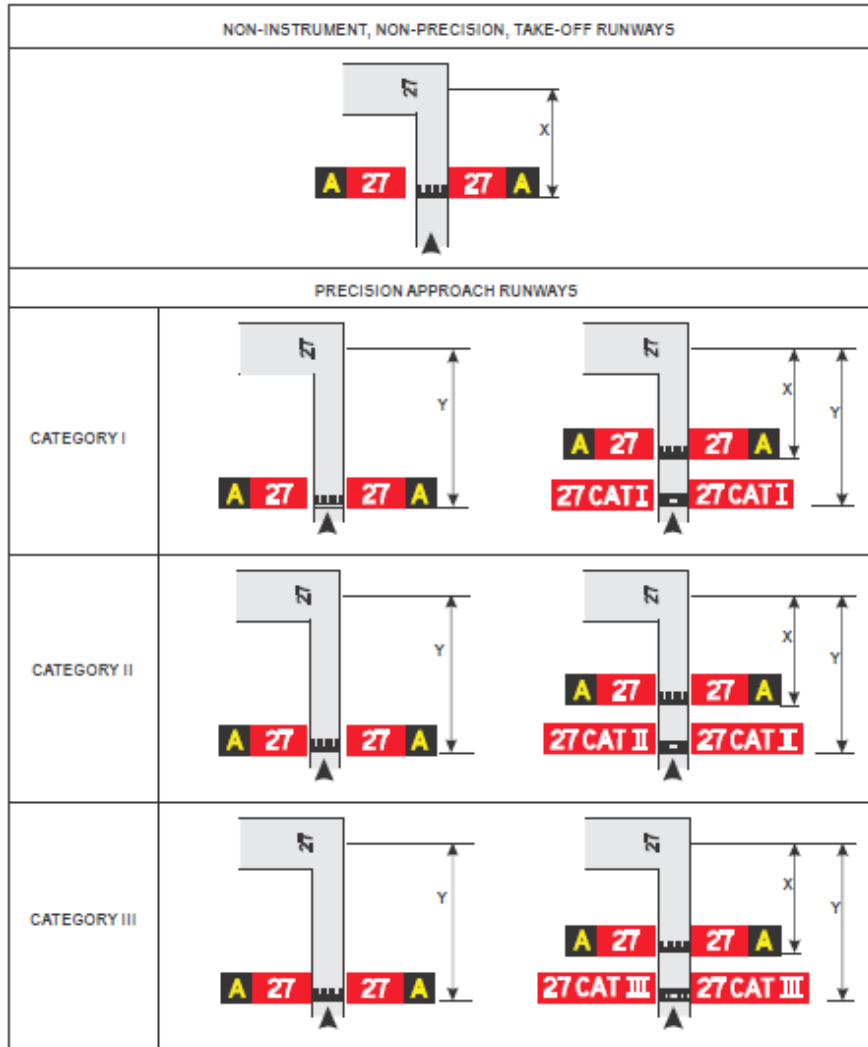

Note.— Distance X is established in accordance with Table 3-2. Distance Y is established at the edge of the ILS/MLS critical/sensitive area.

Figure 5-32. Examples of sign positions at taxiway/runway intersections

Location

- 5.4.2.8 A runway designation sign at a taxiway/runway intersection or a runway/runway intersection shall be located on each side of the runway-holding position marking facing the direction of approach to the runway.
- 5.4.2.9 A category I, II or III holding position sign shall be located on each side of the runway-holding position marking facing the direction of the approach to the critical area.
- 5.4.2.10 A NO ENTRY sign shall be located at the beginning of the area to which entrance is prohibited on each side of the taxiway as viewed by the pilot.
- 5.4.2.11 A runway-holding position sign shall be located on each side of the runway-holding position established in accordance with 3.12.3, facing the approach to the obstacle limitation surface or ILS/MLS critical/sensitive area, as appropriate.

Characteristics

- 5.4.2.12 A mandatory instruction sign shall consist of an inscription in white on a red background.



- 5.4.2.13 Where, owing to environmental or other factors, the conspicuity of the inscription on a mandatory instruction sign needs to be enhanced, the outside edge of the white inscription should be supplemented by a black outline measuring 10 mm in width for runway code numbers 1 and 2, and 20 mm in width for runway code numbers 3 and 4.
- 5.4.2.14 The inscription on a runway designation sign shall consist of the runway designations of the intersecting runway properly oriented with respect to the viewing position of the sign, except that a runway designation sign installed in the vicinity of a runway extremity may show the runway designation of the concerned runway extremity only.
- 5.4.2.15 The inscription on a category I, II, III, joint II/III or joint I/II/III holding position sign shall consist of the runway designator followed by CAT I, CAT II, CAT III, CAT II/III or CAT I/II/III, as appropriate.
- 5.4.2.16 The inscription on a NO ENTRY sign shall be in accordance with Figure 5-30.
- 5.4.2.17 The inscription on a runway-holding position sign at a runway-holding position established in accordance with 3.12.3 shall consist of the taxiway designation and a number.
- 5.4.2.18 Where installed, the inscriptions/symbol of Figure 5-30 shall be used:

5.4.3 Information signs

Application

- 5.4.3.1 An information sign shall be provided where there is an operational need to identify by a sign, a specific location, or routing (direction or destination) information.
- 5.4.3.2 Information signs shall include: direction signs, location signs, destination signs, runway exit signs, runway vacated signs and intersection take-off signs.
- 5.4.3.3 A runway exit sign shall be provided where there is an operational need to identify a runway exit.
- 5.4.3.4 A runway vacated sign shall be provided where the exit taxiway is not provided with taxiway centre line lights and there is a need to indicate to a pilot leaving a runway the perimeter of the ILS/MLS critical/sensitive area or the lower edge of the inner transitional surface, whichever is farther from the runway centre line.
- 5.4.3.5 An intersection take-off sign should be provided when there is an operational need to indicate the remaining take-off run available (TORA) for intersection take-offs.
- 5.4.3.6 Where necessary, a destination sign should be provided to indicate the direction to a specific destination on the aerodrome, such as cargo area, general aviation, etc.
- 5.4.3.7 A combined location and direction sign shall be provided when it is intended to indicate routing information prior to a taxiway intersection.
- 5.4.3.8 A direction sign shall be provided when there is an operational need to identify the designation and direction of taxiways at an intersection.
- 5.4.3.9 A location sign should be provided at an intermediate holding position.



- 5.4.3.10 A location sign shall be provided in conjunction with a runway designation sign except at a runway/runway intersection.
- 5.4.3.11 A location sign shall be provided in conjunction with a direction sign, except that it may be omitted where an aeronautical study indicates that it is not needed.
- 5.4.3.12 Where necessary, a location sign shall be provided to identify taxiways exiting an apron or taxiways beyond an intersection.
- 5.4.3.13 Where a taxiway ends at an intersection such as a “T” and it is necessary to identify this, a barricade, direction sign and/or other appropriate visual aid should be used.

Location

- 5.4.3.14 Except as specified in 5.4.3.16 and 5.4.3.24 information signs shall, wherever practicable, be located on the left-hand side of the taxiway in accordance with Table 5-5.
- 5.4.3.15 At a taxiway intersection, information signs shall be located prior to the intersection and in line with the intermediate holding position marking. Where there is no intermediate holding position marking, the signs shall be installed at least 60 m from the centre line of the intersecting taxiway where the code number is 3 or 4, and at least 40 m where the code number is 1 or 2.
- 5.4.3.16 A runway exit sign shall be located on the same side of the runway as the exit is located (i.e. left or right) and positioned in accordance with Table 5-5.
- 5.4.3.17 A runway exit sign shall be located prior to the runway exit point in line with a position at least 60 m prior to the point of tangency where the code number is 3 or 4, and at least 30 m where the code number is 1 or 2.
- 5.4.3.18 A runway vacated sign shall be located at least on one side of the taxiway. The distance between the sign and the centre line of a runway shall be not less than the greater of the following:
- (a) the distance between the centre line of the runway and the perimeter of the ILS/MLS critical/sensitive area; or
 - (b) the distance between the centre line of the runway and the lower edge of the inner transitional surface.
- 5.4.3.19 Where provided in conjunction with a runway vacated sign, the taxiway location sign shall be positioned outboard of the runway vacated sign.
- 5.4.3.20 An intersection take-off sign shall be located at the left-hand side of the entry taxiway. The distance between the sign and the centre line of the runway shall be not less than 60 m where the code number is 3 or 4, and not less than 45 m where the code number is 1 or 2.
- 5.4.3.21 A taxiway location sign installed in conjunction with a runway designation sign shall be positioned outboard of the runway designation sign.
- 5.4.3.22 A destination sign should not normally be collocated with a location or direction sign.
- 5.4.3.23 An information sign other than a location sign shall not be collocated with a mandatory instruction sign.



5.4.3.24 A direction sign, barricade and/or other appropriate visual aid used to identify a “T” intersection should be located on the opposite side of the intersection facing the taxiway.

Characteristics

5.4.3.25 An information sign other than a location sign shall consist of an inscription in black on a yellow background.

5.4.3.26 A location sign shall consist of an inscription in yellow on a black background and where it is a stand-alone sign shall have a yellow border.

5.4.3.27 The inscription on a runway exit sign shall consist of the designator of the exit taxiway and an arrow indicating the direction to follow.

5.4.3.28 The inscription on a runway vacated sign shall depict the pattern A runway-holding position marking as shown in Figure 5-31.

5.4.3.29 The inscription on an intersection take-off sign shall consist of a numerical message indicating the remaining take-off run available in metres plus an arrow, appropriately located and oriented, indicating the direction of the take-off as shown in Figure 5-31.

5.4.3.30 The inscription on a destination sign shall comprise an alpha, alphanumerical or numerical message identifying the destination plus an arrow indicating the direction to proceed as shown in Figure 5-31.

5.4.3.31 The inscription on a direction sign shall comprise an alpha or alphanumerical message identifying the taxiway(s) plus an arrow or arrows appropriately oriented as shown in Figure 5-31.

5.4.3.32 The inscription on a location sign shall comprise the designation of the location taxiway, runway or other pavement the aircraft is on or is entering and shall not contain arrows.

5.4.3.33 Where it is necessary to identify each of a series of intermediate holding positions on the same taxiway, the location sign should consist of the taxiway designation and a number.

5.4.3.34 Where a location sign and direction signs are used in combination:

- (a) all direction signs related to left turns shall be placed on the left side of the location sign, and all direction signs related to right turns shall be placed on the right side of the location sign, except that where the junction consists of one intersecting taxiway, the location sign may alternatively be placed on the left-hand side;
- (b) the direction signs shall be placed such that the direction of the arrows departs increasingly from the vertical with increasing deviation of the corresponding taxiway;
- (c) an appropriate direction sign shall be placed next to the location sign where the direction of the location taxiway changes significantly beyond the intersection; and
- (d) adjacent direction signs shall be delineated by a vertical black line as shown in Figure 5-31.

5.4.3.35 A taxiway shall be identified by a designator that is used only once on an aerodrome comprising a single letter, two letters or a combination of a letter or letters followed by a number.



- 5.4.3.36 When designating taxiways, the use of words such as inner and outer should be avoided wherever possible.
- 5.4.3.37 When designating taxiways, the use of the letters I,O or X shall not be used to avoid confusion with the numerals 1,0 and closed markings.
- 5.4.3.38 The use of numbers alone on the manoeuvring area shall be reserved for the designation of runways.
- 5.4.3.39 Apron stand designators shall not be the same as taxiway designators.
- 5.4.4 VOR aerodrome checkpoint sign

Application

- 5.4.4.1 When a VOR aerodrome checkpoint is established, it shall be indicated by a VOR aerodrome checkpoint marking and sign.

Location

- 5.4.4.2 A VOR aerodrome checkpoint sign shall be located as near as possible to the checkpoint and so that the inscriptions are visible from the cockpit of an aircraft properly positioned on the VOR aerodrome checkpoint marking.

Characteristics

- 5.4.4.3 A VOR aerodrome checkpoint sign shall consist of an inscription in black on a yellow background.
- 5.4.4.4 The inscriptions on a VOR checkpoint sign shall be in accordance with one of the alternatives shown in Figure 5-33 in which:

VOR is an abbreviation identifying this as a VOR checkpoint;

116.3 is an example of the radio frequency of the VOR concerned;

147° is an example of the VOR bearing, to the nearest degree, which shall be indicated at the VOR checkpoint; and

4.3 NM is an example of the distance in nautical miles to a DME collocated with the VOR concerned.

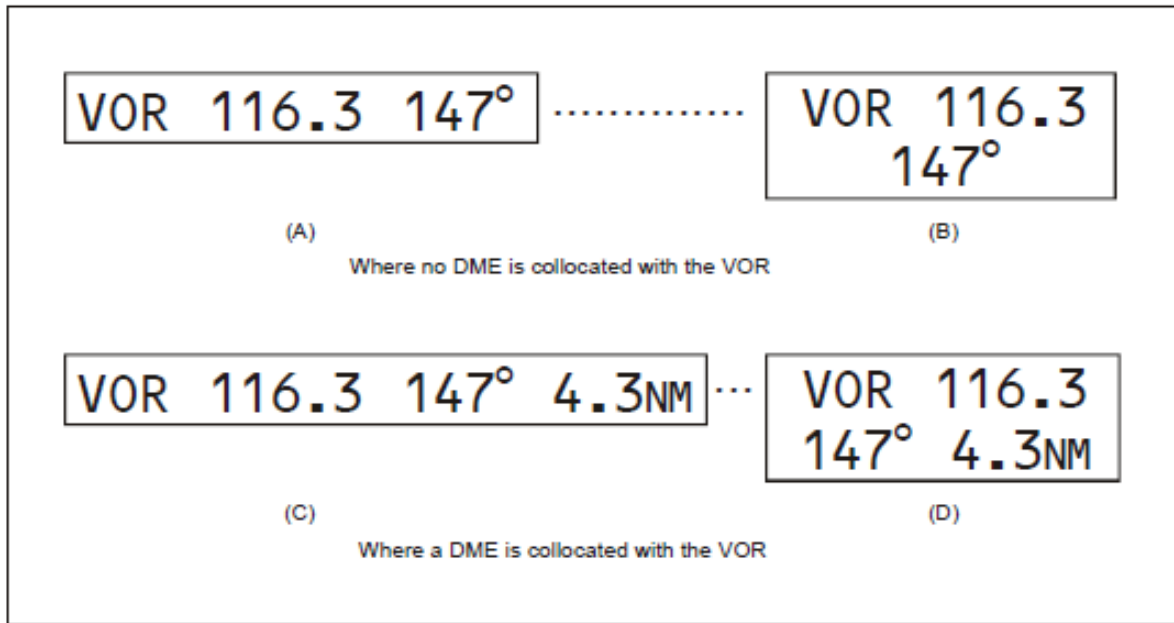

Figure 5-33. VOR aerodrome checkpoint sign

5.4.5 Aerodrome identification sign

Application

5.4.5.1 An aerodrome identification sign shall be provided at an aerodrome where there is insufficient alternative means of visual identification.

Location

5.4.5.2 The aerodrome identification sign shall be placed on the aerodrome so as to be legible, in so far as is practicable, at all angles above the horizontal.

Characteristics

5.4.5.3 The aerodrome identification sign shall consist of the name of the aerodrome.

5.4.5.4 The colour selected for the sign shall give adequate conspicuity when viewed against its background.

5.4.5.5 The characters shall have a height of not less than 3 m.

5.4.6 Aircraft stand identification signs

Application

5.4.6.1 An aircraft stand identification marking shall be supplemented with an aircraft stand identification sign where feasible.

Location

5.4.6.2 An aircraft stand identification sign shall be located so as to be clearly visible from the cockpit of an aircraft prior to entering the aircraft stand.



Characteristics

5.4.6.3 An aircraft stand identification sign shall consist of an inscription in black on a yellow background.

5.4.7 Road-holding position sign

5.4.7.1 A road-holding position sign shall be provided at all road entrances to a runway.

Location

5.4.7.2 The road-holding position sign shall be located 1.5 m from one edge of the road (left or right as appropriate to the local traffic regulations) at the holding position.

Characteristics

5.4.7.3 A road-holding position sign shall consist of an inscription in white on a red background.

5.4.7.4 The inscription on a road-holding position sign shall be in the national language, be in conformity with the local traffic regulations and include the following:

- (a) a requirement to stop; and
- (b) where appropriate:
 - (1) a requirement to obtain ATC clearance; and
 - (2) location designator.

5.4.7.5 A road-holding position sign intended for night use shall be retroreflective or illuminated.

5.5 Markers

5.5.1 General

Markers shall be frangible. Those located near a runway or taxiway shall be sufficiently low to preserve clearance for propellers and for the engine pods of jet aircraft.

5.5.2 Unpaved runway edge markers

Application

5.5.2.1 Markers shall be provided when the extent of an unpaved runway is not clearly indicated by the appearance of its surface compared with that of the surrounding ground.

Location

5.5.2.2 Where runway lights are provided, the markers shall be incorporated in the light fixtures. Where there are no lights, markers of flat rectangular or conical shape should be placed so as to delimit the runway clearly.

**Characteristics**

5.5.2.3 The flat rectangular markers shall have a minimum size of 1 m by 3 m and should be placed with their long dimension parallel to the runway centre line. The conical markers should have a height not exceeding 50 cm.

5.5.3 Stopway edge markers

Application

5.5.3.1 Stopway edge markers shall be provided when the extent of a stopway is not clearly indicated by its appearance compared with that of the surrounding ground.

Characteristics

5.5.3.2 The stopway edge markers shall be sufficiently different from any runway edge markers used to ensure that the two types of markers cannot be confused.

5.5.4 *Not applicable.*

5.5.5 Taxiway edge markers

Application

5.5.5.1 Taxiway edge markers shall be provided on a taxiway where the code number is 1 or 2 and taxiway centre line or edge lights or taxiway centre line markers are not provided.

Location

5.5.5.2 Taxiway edge markers shall be installed at least at the same locations as would the taxiway edge lights had they been used.

Characteristics

5.5.5.3 A taxiway edge marker shall be retroreflective blue.

5.5.5.4 The marked surface as viewed by the pilot should be a rectangle and shall have a minimum viewing area of 150 cm².

5.5.5.5 Taxiway edge markers shall be frangible. Their height shall be sufficiently low to preserve clearance for propellers and for the engine pods of jet aircraft.

5.5.6 Taxiway centre line markers

Application

5.5.6.1 Taxiway centre line markers shall be provided on a taxiway where the code number is 1 or 2 and taxiway centre line or edge lights or taxiway edge markers are not provided.

5.5.6.2 Taxiway centre line markers shall be provided on a taxiway where the code number is 3 or 4 and taxiway centre line lights are not provided if there is a need to improve the guidance provided by the taxiway centre line marking.

Location

5.5.6.3 Taxiway centre line markers shall be installed at least at the same location as would taxiway centre line lights had they been used.

5.5.6.4 Taxiway centre line markers shall normally be located on the taxiway centre line marking except that they may be offset by not more than 30 cm where it is not practicable to locate them on the marking.

Characteristics

5.5.6.5 A taxiway centre line marker shall be retroreflective green.

5.5.6.6 The marked surface as viewed by the pilot should be a rectangle and shall have a minimum viewing area of 20 cm².

5.5.6.7 Taxiway centre line markers shall be so designed and fitted as to withstand being run over by the wheels of an aircraft without damage either to the aircraft or to the markers themselves.

5.5.7 Unpaved taxiway edge markers

Application

5.5.7.1 Where the extent of an unpaved taxiway is not clearly indicated by its appearance compared with that of the surrounding ground, markers shall be provided.

Location

5.5.7.2 Where taxiway lights are provided, the markers shall be incorporated in the light fixtures. Where there are no lights, markers of conical shape should be placed so as to delimit the taxiway clearly.

5.5.8 Boundary markers

Application

5.5.8.1 Boundary markers shall be provided at an aerodrome where the landing area has no runway.

Location

5.5.8.2 Boundary markers shall be spaced along the boundary of the landing area at intervals of not more than 200 m, if the type shown in Figure 5-34 is used, or approximately 90 m, if the conical type is used with a marker at any corner.

Characteristics

5.5.8.3 Boundary markers shall be of a form similar to that shown in Figure 5-34, or in the form of a cone not less than 50 cm high and not less than 75 cm in diameter at the base. The markers should be coloured to contrast with the background against which they will be seen. A single colour, orange or red, or two contrasting colours, orange and white or alternatively red and white, shall be used, except where such colours merge with the background.

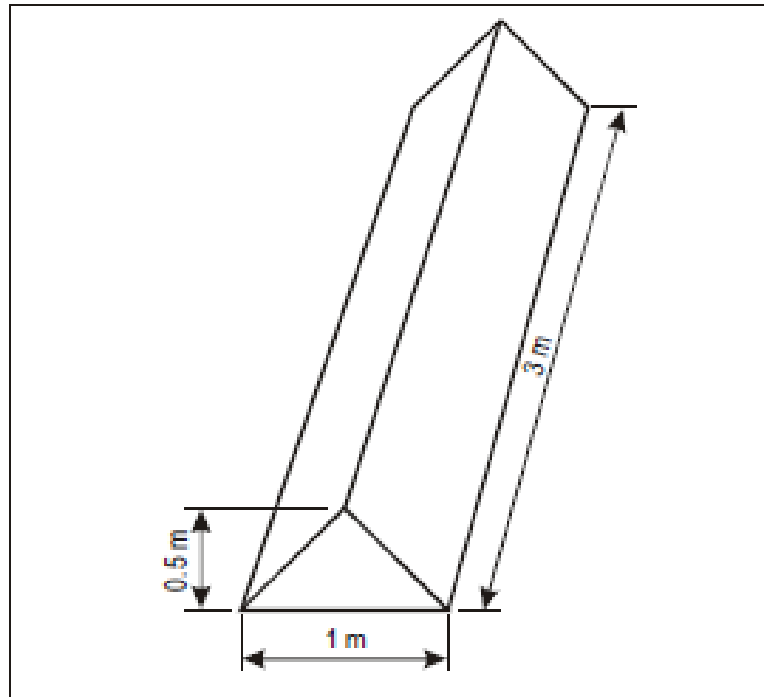

Figure 5-34. Boundary markers



CHAPTER 6

VISUAL AIDS FOR DENOTING OBSTACLES

6.1 Objects to be marked and/or lighted

6.1.1 Objects within the lateral boundaries of the obstacle limitation surfaces

6.1.1.1 Vehicles and other mobile objects, excluding aircraft, on the movement area of an aerodrome are obstacles and shall be marked and, if the vehicles and aerodrome are used at night or in conditions of low visibility, lighted, except that aircraft servicing equipment and vehicles used only on aprons may be exempt.

6.1.1.2 Elevated aeronautical ground lights within the movement area shall be marked so as to be conspicuous by day. Obstacle lights shall not be installed on elevated ground lights or signs in the movement area.

6.1.1.3 All obstacles within the distance specified in Table 3-1, column 11 or 12, from the centre line of a taxiway, an apron taxiway or aircraft stand taxi lane shall be marked and, if the taxiway, apron taxiway or aircraft stand taxi lane is used at night, lighted.

6.1.1.4 A fixed obstacle that extends above a take-off climb surface within 3 000 m of the inner edge of the take-off climb surface shall be marked and, if the runway is used at night, lighted, except that:

- (a) such marking and lighting may be omitted when the obstacle is shielded by another fixed obstacle;
- (b) the marking may be omitted when the obstacle is lighted by medium-intensity obstacle lights, Type A, by day and its height above the level of the surrounding ground does not exceed 150 m;
- (c) the marking may be omitted when the obstacle is lighted by high-intensity obstacle lights by day; and
- (d) the lighting may be omitted where the obstacle is a lighthouse and an aeronautical study indicates the lighthouse light to be sufficient.

6.1.1.5 A fixed object, other than an obstacle, adjacent to a take-off climb surface shall be marked and, if the runway is used at night, lighted, if such marking and lighting is considered necessary to ensure its avoidance, except that the marking may be omitted when:

- (a) the object is lighted by medium-intensity obstacle lights, Type A, by day and its height above the level of the surrounding ground does not exceed 150 m; or
- (b) the object is lighted by high-intensity obstacle lights by day.

6.1.1.6 A fixed obstacle that extends above an approach surface within 3 000 m of the inner edge or above a transitional surface shall be marked and, if the runway is used at night, lighted, except that:

- (a) such marking and lighting may be omitted when the obstacle is shielded by another fixed obstacle;
- (b) the marking may be omitted when the obstacle is lighted by medium-intensity obstacle

lights, Type A, by day and its height above the level of the surrounding ground does not exceed 150 m;

- (c) the marking may be omitted when the obstacle is lighted by high-intensity obstacle lights by day; and
- (d) the lighting may be omitted where the obstacle is a lighthouse and an aeronautical study indicates the lighthouse light to be sufficient.

6.1.1.7 A fixed obstacle that extends above a horizontal surface shall be marked and, if the aerodrome is used at night, lighted, except that:

- (a) such marking and lighting may be omitted when:
 - (1) the obstacle is shielded by another fixed obstacle; or
 - (2) for a circuit extensively obstructed by immovable objects or terrain, procedures have been established to ensure safe vertical clearance below prescribed flight paths; or
 - (3) an aeronautical study shows the obstacle not to be of operational significance;
- (b) the marking may be omitted when the obstacle is lighted by medium-intensity obstacle lights, Type A, by day and its height above the level of the surrounding ground does not exceed 150 m;
- (c) the marking may be omitted when the obstacle is lighted by high-intensity obstacle lights by day; and
- (d) the lighting may be omitted where the obstacle is a lighthouse and an aeronautical study indicates the lighthouse light to be sufficient.

6.1.1.8 A fixed object that extends above an obstacle protection surface shall be marked and, if the runway is used at night, lighted.

6.1.1.9 Other objects inside the obstacle limitation surfaces shall be marked and/or lighted if an aeronautical study indicates that the object could constitute a hazard to aircraft (this includes objects adjacent to visual routes e.g. waterway or highway).

6.1.1.10 Overhead wires, cables, etc., crossing a river, waterway, valley or highway shall be marked and their supporting towers marked and lighted if an aeronautical study indicates that the wires or cables could constitute a hazard to aircraft.

6.1.2 Objects outside the lateral boundaries of the obstacle limitation surfaces

6.1.2.1 Obstacles in accordance with 4.3.2 should be marked and lighted, except that the marking may be omitted when the obstacle is lighted by high-intensity obstacle lights by day.

6.1.2.2 Other objects outside the obstacle limitation surfaces shall be marked and/or lighted if an aeronautical study indicates that the object could constitute a hazard to aircraft (this includes objects adjacent to visual routes e.g. waterway, highway).

6.1.2.3 Overhead wires, cables, etc., crossing a river, waterway, valley or highway shall be marked and



their supporting towers marked and lighted if an aeronautical study indicates that the wires or cables could constitute a hazard to aircraft.

6.2 Marking and/or lighting of objects

6.2.1 General

6.2.1.1 The presence of objects which must be lighted, as specified in 6.1, shall be indicated by low-, medium- or high- intensity obstacle lights, or a combination of such lights.

6.2.1.2 Low-intensity obstacle lights, Types A B, C, D and E, medium-intensity obstacle lights, Types A, B and C, high- intensity obstacle lights Type A and B, shall be in accordance with the specifications in Table 6-1 and Appendix 1 to ICAO Annex 14, Volume 1.

6.2.1.3 The number and arrangement of low-, medium- or high-intensity obstacle lights at each level to be marked shall be such that the object is indicated from every angle in azimuth. Where a light is shielded in any direction by another part of the object, or by an adjacent object, additional lights shall be provided on that adjacent object or the part of the object that is shielding the light, in such a way as to retain the general definition of the object to be lighted. If the shielded light does not contribute to the definition of the object to be lighted, it may be omitted.

6.2.2 Mobile objects

Marking

6.2.2.1 All mobile objects to be marked shall be coloured or display flags.

Marking by colour

6.2.2.2 When mobile objects are marked by colour, a single conspicuous colour, preferably red or yellowish green for emergency vehicles and yellow for service vehicles, shall be used.

Marking by flags

6.2.2.3 Flags used to mark mobile objects shall be displayed around, on top of, or around the highest edge of the object. Flags shall not increase the hazard presented by the object they mark.

6.2.2.4 Flags used to mark mobile objects shall not be less than 0.9 m on each side and shall consist of a chequered pattern, each square having sides of not less than 0.3 m. The colours of the pattern shall contrast each with the other and with the background against which they will be seen. Orange and white or alternatively red and white shall be used, except where such colours merge with the background.



Table 6-1. Characteristics of obstacle lights

1 Light Type	2 Colour	3 Signal type/ (flash rate)	4 Peak intensity (cd) at given Background Luminance (b)			7 Light Distribution Table
			5 Day (Above 500 cd/m ²)	6 Twilight (30-500 cd/m ²)	6 Night (Below 50 cd/m ²)	
Low-intensity, Type A (fixed obstacle)	Red	Fixed	N/A	N/A	10	Table 6-2
Low-intensity, Type B (fixed obstacle)	Red	Fixed	N/A	N/A	32	Table 6-2
Low-intensity, Type C (mobile obstacle)	Yellow/Blue (a)	Flashing (60-90 fpm)	N/A	40	40	Table 6-2
Low-intensity, Type D (follow-me vehicle)	Yellow	Flashing (60-90 fpm)	N/A	200	200	Table 6-2
Low-intensity, Type E	Red	Flashing (c)	N/A	N/A	32	Table 6-2 (Type B)
Medium-intensity, Type A	White	Flashing (20-60 fpm)	20 000	20 000	2 000	Table 6-3
Medium-intensity, Type B	Red	Flashing (20-60 fpm)	N/A	N/A	2 000	Table 6-3
Medium-intensity, Type C	Red	Fixed	N/A	N/A	2 000	Table 6-3
High-intensity, Type A	White	Flashing (40-60 fpm)	200 000	20 000	2 000	Table 6-3
High-intensity, Type B	White	Flashing (40-60 fpm)	100 000	20 000	2 000	Table 6-3

- a) See 6.2.2.6
- b) For flashing lights, effective intensity as determined in accordance with the *Aerodrome Design Manual* (Doc 9157), Part 4.
- c) For wind turbine application, to flash at the same rate as the lighting on the nacelle.

Table 6-2. Light distribution for low-intensity obstacle lights

	Minimum intensity (a)	Maximum intensity (a)	Vertical beam spread (f)	
			Minimum beam spread	Intensity
Type A	10 cd (b)	N/A	10°	5 cd
Type B	32 cd (b)	N/A	10°	16 cd
Type C	40 cd (b)	400 cd	12° (d)	20 cd
Type D	200 cd (c)	400 cd	N/A (e)	N/A

Note: This table does not include recommended horizontal beam spreads. 6.2.1.3 requires 360° coverage around an obstacle. Therefore, the number of lights needed to meet this requirement will depend on the horizontal beam spreads of each light as well as the shape of the obstacle. Thus, with narrower beam spreads, more lights will be required.

- a) 360° horizontal. For flashing lights, the intensity is read into effective intensity, as determined in accordance with the *Aerodrome Design Manual* (Doc 9157), Part 4.
- b) Between 2 and 10° vertical. Elevation vertical angles are referenced to the horizontal when the light is levelled.
- c) Between 2 and 20° vertical. Elevation vertical angles are referenced to the horizontal when the light is levelled.
- d) Peak intensity should be located at approximately 2.5° vertical.
- e) Peak intensity should be located at approximately 17° vertical.
- f) Beam spread is defined as the angle between the horizontal plane and the directions for which the intensity exceeds that mentioned in the “intensity” column.



Table 6-3. Light distribution for medium- and high-intensity obstacle lights according to benchmark intensities of Table 6-1

Benchmark intensity	Minimum requirements					Recommendations				
	Vertical elevation angle (b)			Vertical beam spread (c)		Vertical elevation angle (b)			Vertical beam spread (c)	
	0°		-1°			0°	-1°	-10°		
	Minimum average intensity (a)	Minimum intensity (a)	Minimum intensity (a)	Minimum beam spread	Intensity (a)	Maximum intensity (a)	Maximum intensity (a)	Maximum intensity (a)	Maximum beam spread	Intensity (a)
200 000	200 000	150 000	75 000	3°	75 000	250 000	112 500	7 500	7°	75 000
100 000	100 000	75 000	37 500	3°	37 500	125 000	56 250	3 750	7°	37 500
20 000	20 000	15 000	7 500	3°	7 500	25 000	11 250	750	N/A	N/A
2 000	2 000	1 500	750	3°	750	2 500	1 125	75	N/A	N/A

Note: This table does not include recommended horizontal beam spreads. 6.2.1.3 requires 360° coverage around an obstacle. Therefore, the number of lights needed to meet this requirement will depend on the horizontal beam spreads of each light as well as the shape of the obstacle. Thus, with narrower beam spreads, more lights will be required.

- a) 360° horizontal. All intensities are expressed in Candela. For flashing lights, the intensity is read into effective intensity, as determined in accordance with the *Aerodrome Design Manual* (Doc 9157), Part 4.
- b) Elevation vertical angles are referenced to the horizontal when the light unit is levelled.
- c) Beam spread is defined as the angle between the horizontal plane and the directions for which the intensity exceeds that mentioned in the “intensity” column.

Note.— An extended beam spread may be necessary under specific configuration and justified by an aeronautical study.

Lighting

6.2.2.5 Low-intensity obstacle lights, Type C, shall be displayed on vehicles and other mobile objects excluding aircraft.

6.2.2.6 Low-intensity obstacle lights, Type C, displayed on vehicles associated with emergency or security shall be flashing-blue and those displayed on other vehicles shall be flashing-yellow.

6.2.2.7 Low-intensity obstacle lights, Type D, shall be displayed on follow-me vehicles.

6.2.2.8 Low-intensity obstacle lights on objects with limited mobility such as aerobridges shall be fixed-red, and as a minimum be in accordance with the specifications for low-intensity obstacle lights, Type A, in Table 6-1. The intensity of the lights shall be sufficient to ensure conspicuity considering the intensity of the adjacent lights and the general levels of illumination against which they would normally be viewed.

6.2.3 Fixed objects

Marking

6.2.3.1 All fixed objects to be marked shall, whenever practicable, be coloured, but if this is not practicable, markers or flags shall be displayed on or above them, except that objects that are sufficiently conspicuous by their shape, size or colour need not be otherwise marked.

Marking by colour

6.2.3.2 An object shall be coloured to show a chequered pattern if it has essentially unbroken surfaces and its projection on any vertical plane equals or exceeds 4.5 m in both dimensions. The pattern shall consist of rectangles of not less than 1.5 m and not more than 3 m on a side, the corners being of



the darker colour. The colours of the pattern shall contrast each with the other and with the background against which they will be seen. Orange and white or alternatively red and white should be used, except where such colours merge with the background. (See Figure 6-1.)

6.2.3.3 An object shall be coloured to show alternating contrasting bands if:

- (a) it has essentially unbroken surfaces and has one dimension, horizontal or vertical, greater than 1.5 m, and the other dimension, horizontal or vertical, less than 4.5 m; or
- (b) it is of skeletal type with either a vertical or a horizontal dimension greater than 1.5 m.

The bands shall be perpendicular to the longest dimension and have a width approximately 1/7 of the longest dimension or 30 m, whichever is less. The colours of the bands should contrast with the background against which they will be seen. Orange and white shall be used, except where such colours are not conspicuous when viewed against the background. The bands on the extremities of the object should be of the darker colour. (See Figures 6-1 and 6-2.)

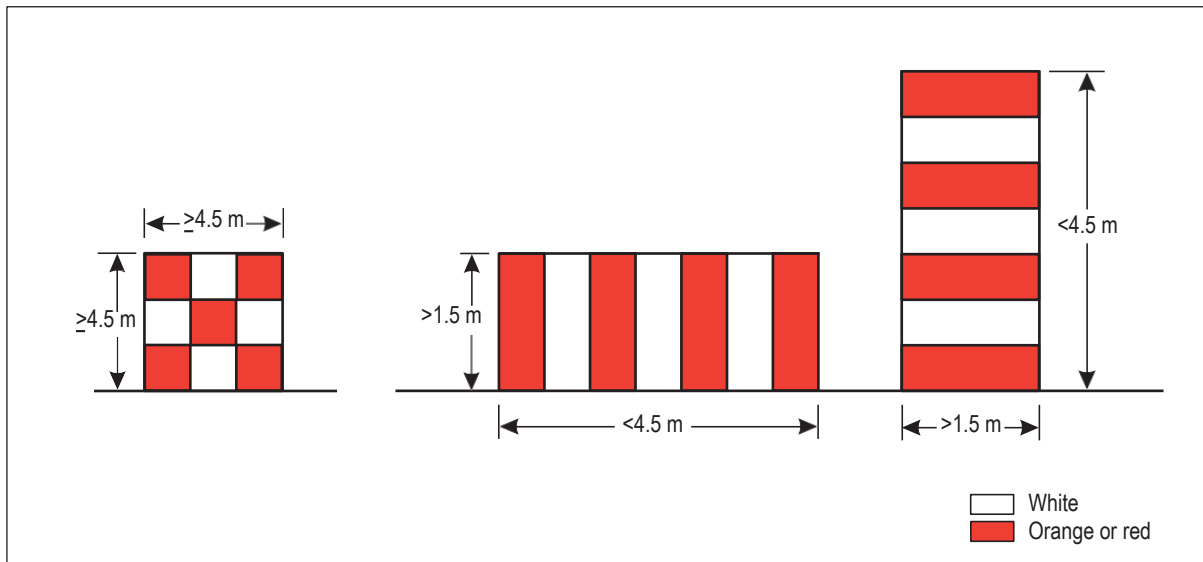

Figure 6-1. Basic marking patterns

Table 6-4. Marking band widths

Longest dimension		Band width
Greater than	Not exceeding	
1.5 m	210 m	1/7 of longest dimension
210 m	270 m	1/9 " " "
270 m	330 m	1/11 " " "
330 m	390 m	1/13 " " "
390 m	450 m	1/15 " " "
450 m	510 m	1/17 " " "
510 m	570 m	1/19 " " "
570 m	630 m	1/21 " " "

6.2.3.4 An object shall be coloured in a single conspicuous colour if its projection on any vertical plane has both dimensions less than 1.5 m. Orange or red should be used, except where such colours merge with the background.

Marking by flags

6.2.3.5 Flags used to mark fixed objects shall be displayed around, on top of, or around the highest edge of, the object. When flags are used to mark extensive objects or groups of closely spaced objects, they shall be displayed at least every 15 m. Flags shall not increase the hazard presented by the object they mark.

6.2.3.6 Flags used to mark fixed objects shall not be less than 0.6 m on each side

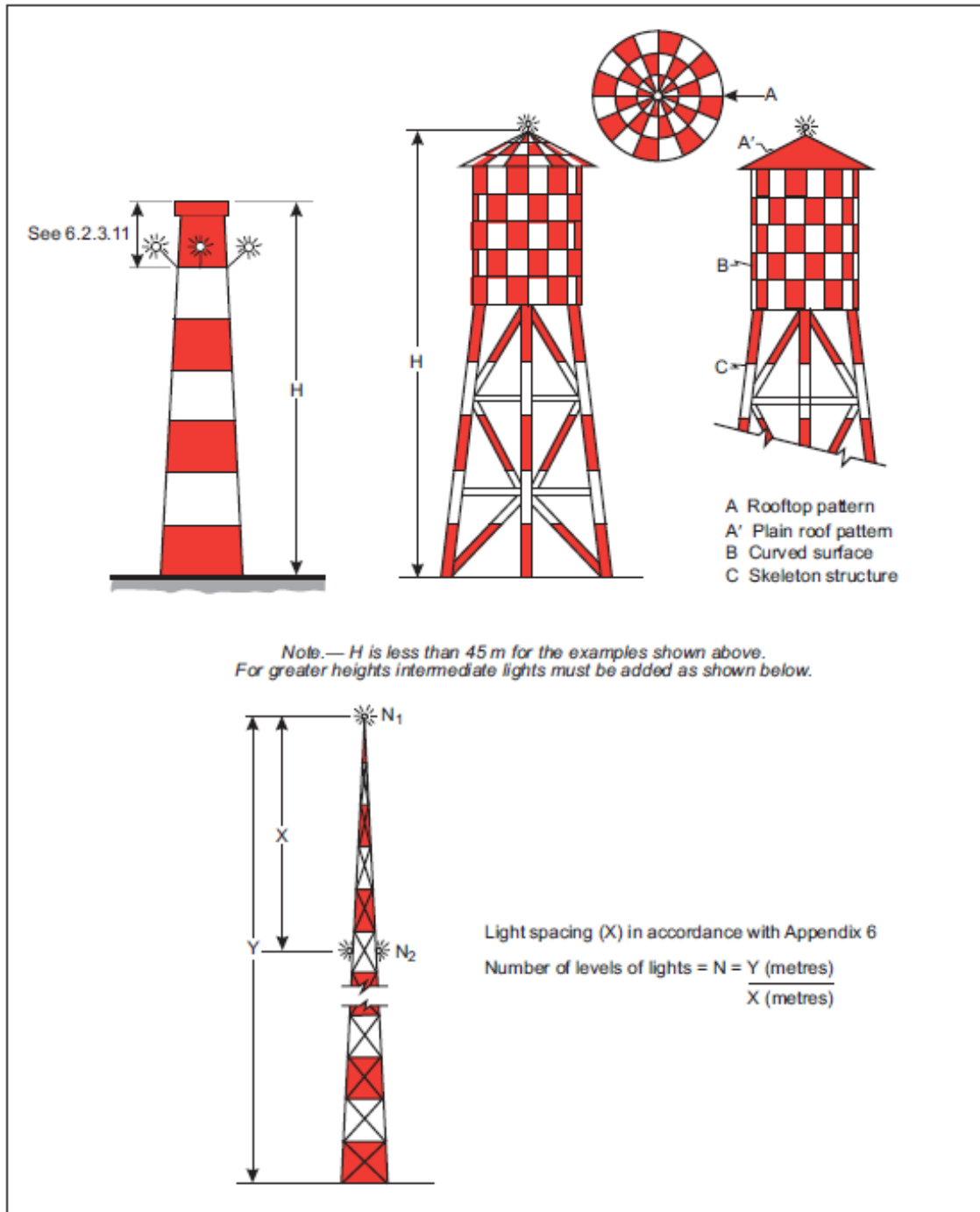

Figure 6-2. Examples of marking and lighting of tall structures

6.2.3.7 Flags used to mark fixed objects shall be orange in colour or a combination of two triangular sections, one orange and the other white, or one red and the other white, except that where such



colours merge with the background, other conspicuous colours should be used.

Marking by markers

6.2.3.8 Markers displayed on or adjacent to objects shall be located in conspicuous positions so as to retain the general definition of the object and shall be recognizable in clear weather from a distance of at least 1 000 m for an object to be viewed from the air and 300 m for an object to be viewed from the ground in all directions in which an aircraft is likely to approach the object. The shape of markers shall be distinctive to the extent necessary to ensure that they are not mistaken for markers employed to convey other information, and they shall be such that the hazard presented by the object they mark is not increased.

6.2.3.9 A marker shall be of one colour. When installed, white and red, or white and orange markers shall be displayed alternately. The colour selected shall contrast with the background against which it will be seen.

Lighting

6.2.3.10 In the case of an object to be lighted, one or more low-, medium- or high-intensity obstacle lights shall be located as close as practicable to the top of the object.

6.2.3.11 In the case of chimney or other structure of like function, the top lights shall be placed sufficiently below the top so as to minimize contamination by smoke, etc. (See Figure 6-2).

6.2.3.12 In the case of a tower or antenna structure indicated by high-intensity obstacle lights by day with an appurtenance, such as a rod or an antenna, greater than 12 m where it is not practicable to locate a high-intensity obstacle light on the top of the appurtenance, such a light shall be located at the highest practicable point and, if practicable, a medium-intensity obstacle light, Type A, mounted on the top.

6.2.3.13 In the case of an extensive object or of a group of closely spaced objects to be lighted that are:

- (a) penetrating a horizontal obstacle limitation surface (OLS) or located outside an OLS, the top lights shall be so arranged as to at least indicate the points or edges of the object highest in relation to the obstacle limitation surface or above the ground, and so as to indicate the general definition and the extent of the objects; and
- (b) penetrating a sloping OLS, the top lights shall be so arranged as to at least indicate the points or edges of the object highest in relation to the OLS, and so as to indicate the general definition and the extent of the objects. If two or more edges are of the same height, the edge nearest the landing area shall be marked.

6.2.3.14 When the obstacle limitation surface concerned is sloping and the highest point above the OLS is not the highest point of the object, additional obstacle lights shall be placed on the highest point of the object.

6.2.3.15 Where lights are applied to display the general definition of an extensive object or a group of closely spaced objects, and

- (a) low-intensity lights are used, they shall be spaced at longitudinal intervals not exceeding 45 m; and



- (b) medium-intensity lights are used, they shall be spaced at longitudinal intervals not exceeding 900 m.
- 6.2.3.16 High-intensity obstacle lights, Type A, and medium-intensity obstacle lights, Types A and B, located on an object shall flash simultaneously.
- 6.2.3.17 The installation setting angles for high-intensity obstacle lights, Type A, should be in accordance with Table 6-5.
- 6.2.3.18 Where, in the opinion of the appropriate authority, the use of high-intensity obstacle lights, Type A, or medium-intensity obstacle lights, Type A, at night may dazzle pilots in the vicinity of an aerodrome (within approximately 10 000 m radius) or cause significant environmental concerns, a dual obstacle lighting system should be provided. This system shall be composed of high-intensity obstacle lights, Type A, or medium-intensity obstacle lights, Type A, as appropriate, for daytime and twilight use and medium-intensity obstacle lights, Type B or C, for night-time use.

Lighting of objects with a height less than 45 m above ground level

- 6.2.3.19 Low-intensity obstacle lights, Type A or B, shall be used where the object is a less extensive one and its height above the surrounding ground is less than 45 m.
- 6.2.3.20 Where the use of low-intensity obstacle lights, Type A or B, would be inadequate or an early special warning is required, then medium- or high-intensity obstacle lights shall be used.
- 6.2.3.21 Low-intensity obstacle lights, Type B, should be used either alone or in combination with medium-intensity obstacle lights, Type B, in accordance with 6.2.3.22.
- 6.2.3.22 Medium-intensity obstacle lights, Type A, B or C, should be used where the object is an extensive one. Medium-intensity obstacle lights, Types A and C, shall be used alone, whereas medium-intensity obstacle lights, Type B, should be used either alone or in combination with low-intensity obstacle lights, Type B.

Lighting of objects with a height 45 m to a height less than 150 m above ground level

- 6.2.3.23 Medium-intensity obstacle lights, Type A, B or C, should be used. Medium-intensity obstacle lights, Types A and C, should be used alone, whereas medium-intensity obstacle lights, Type B, should be used either alone or in combination with low-intensity obstacle lights, Type B.
- 6.2.3.24 Where an object is indicated by medium-intensity obstacle lights, Type A, and the top of the object is more than 105 m above the level of the surrounding ground or the elevation of tops of nearby buildings (when the object to be marked is surrounded by buildings), additional lights shall be provided at intermediate levels. These additional intermediate lights shall be spaced as equally as practicable, between the top lights and ground level or the level of tops of nearby buildings, as appropriate, with the spacing not exceeding 105 m.
- 6.2.3.25 Where an object is indicated by medium-intensity obstacle lights, Type B, and the top of the object is more than 45 m above the level of the surrounding ground or the elevation of tops of nearby buildings (when the object to be marked is surrounded by buildings), additional lights shall be provided at intermediate levels. These additional intermediate lights shall be alternately low-intensity obstacle lights, Type B, and medium-intensity obstacle lights, Type B, and shall be spaced as equally as practicable between the top lights and ground level or the level of tops of nearby buildings, as appropriate, with the spacing not exceeding 52 m.



6.2.3.26 Where an object is indicated by medium-intensity obstacle lights, Type C, and the top of the object is more than 45 m above the level of the surrounding ground or the elevation of tops of nearby buildings (when the object to be marked is surrounded by buildings), additional lights shall be provided at intermediate levels. These additional intermediate lights shall be spaced as equally as practicable, between the top lights and ground level or the level of tops of nearby buildings, as appropriate, with the spacing not exceeding 52 m.

6.2.3.27 Where high-intensity obstacle lights, Type A, are used, they shall be spaced at uniform intervals not exceeding 105 m between the ground level and the top light(s) specified in 6.2.3.10, except that where an object to be marked is surrounded by buildings, the elevation of the tops of the buildings may be used as the equivalent of the ground level when determining the number of light levels.

Lighting of objects with a height 150 m or more above ground level

6.2.3.28 High-intensity obstacle lights, Type A, shall be used to indicate the presence of an object if its height above the level of the surrounding ground exceeds 150 m and an aeronautical study indicates such lights to be essential for the recognition of the object by day.

6.2.3.29 Where high-intensity obstacle lights, Type A, are used, they shall be spaced at uniform intervals not exceeding 105 m between the ground level and the top light(s) specified in 6.2.3.10, except that where an object to be marked is surrounded by buildings, the elevation of the tops of the buildings may be used as the equivalent of the ground level when determining the number of light levels.

6.2.3.30 Where, in the opinion of the appropriate authority, the use of high-intensity obstacle lights, Type A, at night may dazzle pilots in the vicinity of an aerodrome (within approximately 10 000 m radius) or cause significant environmental concerns, medium-intensity obstacle lights, Type C, shall be used alone, whereas medium-intensity obstacle lights, Type B, shall be used either alone or in combination with low-intensity obstacle lights, Type B.

6.2.3.31 Where an object is indicated by medium-intensity obstacle lights, Type A, additional lights shall be provided at intermediate levels. These additional intermediate lights shall be spaced as equally as practicable, between the top lights and ground level or the level of tops of nearby buildings, as appropriate, with the spacing not exceeding 105 m.

6.2.3.32 Where an object is indicated by medium-intensity obstacle lights, Type B, additional lights shall be provided at intermediate levels. These additional intermediate lights shall be alternately low-intensity obstacle lights, Type B, and medium-intensity obstacle lights, Type B, and shall be spaced as equally as practicable between the top lights and ground level or the level of tops of nearby buildings, as appropriate, with the spacing not exceeding 52 m.

6.2.3.33 Where an object is indicated by medium-intensity obstacle lights, Type C, additional lights shall be provided at intermediate levels. These additional intermediate lights shall be spaced as equally as practicable, between the top lights and ground level or the level of tops of nearby buildings, as appropriate, with the spacing not exceeding 52 m.

6.2.4 Wind turbines

6.2.4.1 A wind turbine shall be marked and/or lighted if it is determined to be an obstacle.



Markings

6.2.4.2 The rotor blades, nacelle and upper 2/3 of the supporting mast of wind turbines shall be painted white, unless otherwise indicated by an aeronautical study.

Lighting

6.2.4.3 When lighting is deemed necessary, in the case of a wind farm, i.e. a group of two or more wind turbines, the wind farm shall be regarded as an extensive object and the lights shall be installed:

- (a) to identify the perimeter of the wind farm;
- (b) respecting the maximum spacing, in accordance with 6.2.3.15, between the lights along the perimeter, unless a dedicated assessment shows that a greater spacing can be used;
- (c) so that, where flashing lights are used, they flash simultaneously; and
- (d) so that, within a wind farm, any wind turbines of significantly higher elevation are also identified wherever they are located; and
- (e) at locations prescribed in a), b) and d), respecting the following criteria:
 - (1) for wind turbines of less than 150 m in overall height (hub height plus vertical blade height), medium intensity lighting on the nacelle shall be provided;
 - (2) for wind turbines from 150 m to 315 m in overall height, in addition to the medium intensity light installed on the nacelle, a second light serving as an alternate should be provided in case of failure of the operating light. The lights should be installed to assure that the output of either light is not blocked by the other; and
 - (3) in addition, for wind turbines from 150 m to 315 m in overall height, an intermediate level at half the nacelle height of at least 3 low intensity Type E lights, as specified in 6.2.1.3 should be provided. If an aeronautical study shows that low intensity type E lights are not suitable, low-intensity type A or B lights may be used.

6.2.4.4 The obstacle lights shall be installed on the nacelle in such a manner as to provide an unobstructed view for aircraft approaching from any direction.

6.2.4.5 Where lighting is deemed necessary for a single wind turbine or short line of wind turbines, the installation shall be in accordance with 6.2.4.3(e) or as determined by an aeronautical study.

6.2.5 Overhead wires, cables, etc., and supporting towers

Marking

6.2.5.1 The wires, cables, etc., to be marked shall be equipped with markers; the supporting tower should be coloured.



Marking by colours

6.2.5.2 The supporting towers of overhead wires, cables, etc., that require marking shall be marked in accordance with 6.2.3.1 to 6.2.3.4, except that the marking of the supporting towers may be omitted when they are lighted by high-intensity obstacle lights by day.

Marking by markers

6.2.5.3 Markers displayed on or adjacent to objects shall be located in conspicuous positions so as to retain the general definition of the object and shall be recognizable in clear weather from a distance of at least 1 000 m for an object to be viewed from the air and 300 m for an object to be viewed from the ground in all directions in which an aircraft is likely to approach the object. The shape of markers shall be distinctive to the extent necessary to ensure that they are not mistaken for markers employed to convey other information, and they shall be such that the hazard presented by the object they mark is not increased.

6.2.5.4 A marker displayed on an overhead wire, cable, etc., shall be spherical and have a diameter of not less than 60 cm.

6.2.5.5 The spacing between two consecutive markers or between a marker and a supporting tower should be appropriate to the diameter of the marker, but in no case should the spacing exceed:

- (a) 30 m where the marker diameter is 60 cm progressively increasing with the diameter of the marker to
- (b) 35 m where the marker diameter is 80 cm and further progressively increasing to a maximum of
- (c) 40 m where the marker diameter is of at least 130 cm.

Where multiple wires, cables, etc., are involved, a marker shall be located not lower than the level of the highest wire at the point marked.

6.2.5.6 A marker shall be of one colour. When installed, white and red, or white and orange markers should be displayed alternately. The colour selected should contrast with the background against which it will be seen.

6.2.5.7 When it has been determined that an overhead wire, cable, etc., needs to be marked but it is not practicable to install markers on the wire, cable, etc., then high-intensity obstacle lights, Type B, shall be provided on their supporting towers.

Lighting

6.2.5.8 High-intensity obstacle lights, Type B, shall be used to indicate the presence of a tower supporting overhead wires, cables, etc., where:

- (a) an aeronautical study indicates such lights to be essential for the recognition of the presence of wires, cables, etc.; or
- (b) it has not been found practicable to install markers on the wires, cables, etc.

6.2.5.9 Where high-intensity obstacle lights, Type B, are used, they shall be located at three levels:



- at the top of the tower;
- at the lowest level of the catenary of the wires or cables; and
- at approximately midway between these two levels.

6.2.5.10 High-intensity obstacle lights, Type B, indicating the presence of a tower supporting overhead wires, cables, etc., shall flash sequentially; first the middle light, second the top light and last, the bottom light. The intervals between flashes of the lights shall approximate the following ratios:

Flash interval between	Ratio of cycle time
middle and top light	1/13
top and bottom light	2/13
bottom and middle light	10/13.

6.2.5.11 Where, in the opinion of the appropriate authority, the use of high-intensity obstacle lights, Type B, at night may dazzle pilots in the vicinity of an aerodrome (within approximately 10 000 m radius) or cause significant environmental concerns, a dual obstacle lighting system shall be provided. This system shall be composed of high-intensity obstacle lights, Type B, for daytime and twilight use and medium-intensity obstacle lights, Type B, for night-time use. Where medium-intensity lights are used they shall be installed at the same level as the high-intensity obstacle light Type B.

6.2.5.12 The installation setting angles for high-intensity obstacle lights, Type B, should be in accordance with Table 6-5.

Table 6-5. Installation setting angles for high-intensity obstacle lights

Height of light unit above terrain (AGL)		Angle of the peak of the beam above the horizontal
Greater than	Not exceeding	
151 m		0°
122 m	151 m	1°
92 m	122 m	2°
	92 m	3°



This Page Intentionally Left Blank

**CHAPTER 7****VISUAL AIDS FOR DENOTING RESTRICTED USE AREAS****7.1 Closed runways and taxiways, or parts thereof*****Application***

- 7.1.1 A closed marking shall be displayed on a runway or taxiway or portion thereof which is permanently closed to the use of all aircraft.
- 7.1.2 A closed marking shall be displayed on a temporarily closed runway or taxiway or portion thereof, except that such marking may be omitted when the closing is of short duration and adequate warning by air traffic services is provided.

Location

- 7.1.3 On a runway a closed marking shall be placed at each end of the runway, or portion thereof, declared closed, and additional markings shall be so placed that the maximum interval between markings does not exceed 300 m. On a taxiway a closed marking shall be placed at least at each end of the taxiway or portion thereof closed.

Characteristics

- 7.1.4 The closed marking shall be of the form and proportions as detailed in Figure 7-1, Illustration a), when displayed on a runway, and shall be of the form and proportions as detailed in Figure 7-1, Illustration b), when displayed on a taxiway. The marking shall be white when displayed on a runway and shall be yellow when displayed on a taxiway.
- 7.1.5 When a runway or taxiway or portion thereof is permanently closed, all normal runway and taxiway markings shall be obliterated.
- 7.1.6 Lighting on a closed runway or taxiway or portion thereof shall not be operated, except as required for maintenance purposes.
- 7.1.7 In addition to closed markings, when the runway or taxiway or portion thereof closed is intercepted by a usable runway or taxiway which is used at night, unserviceability lights shall be placed across the entrance to the closed area at intervals not exceeding 3 m (see 7.4.4).

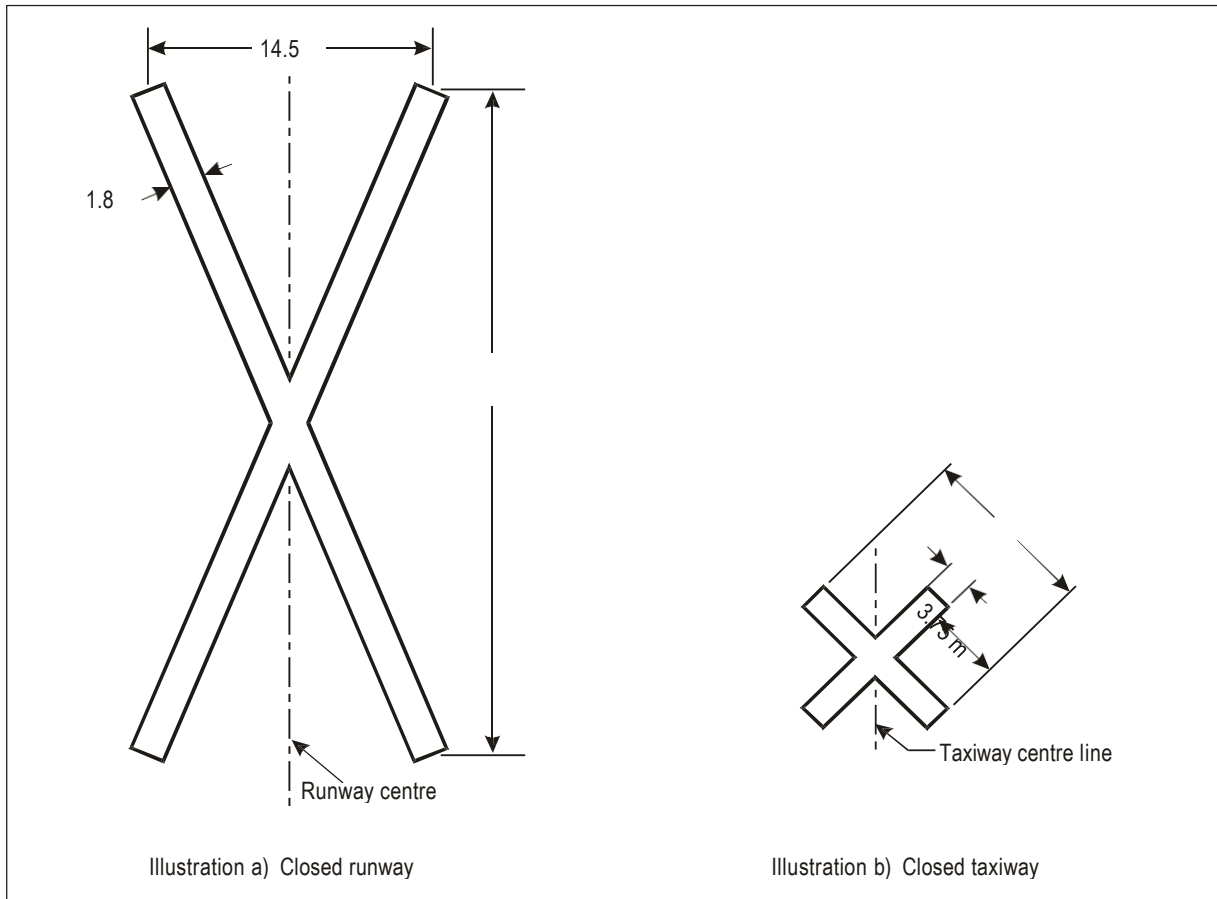

Figure 7-1. Closed runway and taxiway markings

7.2 Non-load-bearing surfaces

Application

7.2.1 Shoulders for taxiways, runway turn pads, holding bays and aprons and other non-load-bearing surfaces which cannot readily be distinguished from load-bearing surfaces and which, if used by aircraft, might result in damage to the aircraft shall have the boundary between such areas and the load-bearing surface marked by a taxi side stripe marking.

Location

7.2.2 A taxi side stripe marking shall be placed along the edge of the load-bearing pavement, with the outer edge of the marking approximately on the edge of the load-bearing pavement.

Characteristics

7.2.3 A taxi side stripe marking shall consist of a pair of solid lines, each 15 cm wide and spaced 15 cm apart and the same colour as the taxiway centre line marking.

7.3 Pre-threshold area

Application

7.3.1 When the surface before a threshold is paved and exceeds 60 m in length and is not suitable for normal use by aircraft, the entire length before the threshold shall be marked with a chevron marking.

Location

7.3.2 A chevron marking shall point in the direction of the runway and be placed as shown in Figure 7-2.

Characteristics

7.3.3 A chevron marking shall be of conspicuous colour and contrast with the colour used for the runway markings; it should preferably be yellow. It should have an overall width of at least 0.9 m.

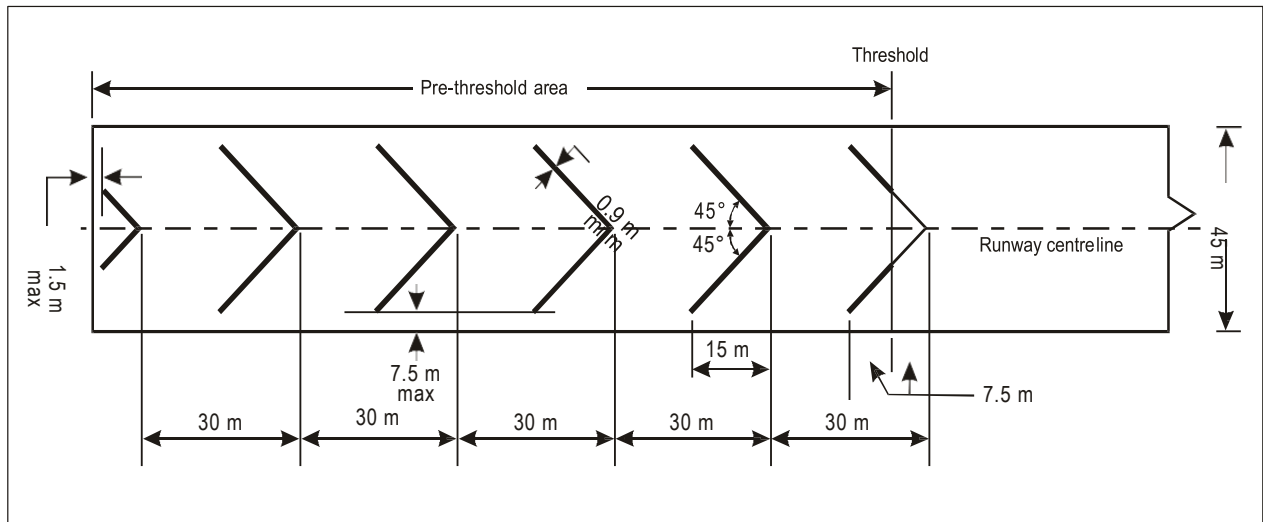

Figure 7-2. Pre-threshold marking

7.4 Unserviceable areas

Application

7.4.1 Unserviceability markers shall be displayed wherever any portion of a taxiway, apron or holding bay is unfit for the movement of aircraft but it is still possible for aircraft to bypass the area safely. On a movement area used at night, unserviceability lights shall be used.

Location

7.4.2 Unserviceability markers and lights shall be placed at intervals sufficiently close so as to delineate the unserviceable area.

Characteristics of unserviceability markers

7.4.3 Unserviceability markers shall consist of conspicuous upstanding devices such as flags, cones or marker boards.

Characteristics of unserviceability lights

7.4.4 An unserviceability light shall consist of a red fixed light. The light shall have an intensity sufficient to ensure conspicuity considering the intensity of the adjacent lights and the general level of illumination against which it would normally be viewed. In no case shall the intensity be less than 10 cd of red light.



Characteristics of unserviceability cones

7.4.5 An unserviceability cone shall be at least 0.5 m in height and red, orange or yellow or any one of these colours in combination with white.

Characteristics of unserviceability flags

7.4.6 An unserviceability flag shall be at least 0.5 m square and red, orange or yellow or any one of these colours in combination with white.

Characteristics of unserviceability marker boards

7.4.7 An unserviceability marker board shall be at least 0.5 m in height and 0.9 m in length, with alternate red and white or orange and white vertical stripes.

**CHAPTER 8****ELECTRICAL SYSTEMS****8.1 Electrical power supply systems for air navigation facilities**

- 8.1.1 Adequate primary power supply shall be available at aerodromes for the safe functioning of air navigation facilities.
- 8.1.2 The design and provision of electrical power systems for aerodrome visual and radio navigation aids shall be such that an equipment failure will not leave the pilot with inadequate visual and non-visual guidance or misleading information.
- 8.1.3 Electric power supply connections to those facilities for which secondary power is required shall be so arranged that the facilities are automatically connected to the secondary power supply on failure of the primary source of power.
- 8.1.4 The time interval between failure of the primary source of power and the complete restoration of the services required by 8.1.10 should be as short as practicable, except that for visual aids associated with non-precision, precision approach or take-off runways the requirements of Table 8-1 for maximum switch-over times should apply.
- 8.1.5 The provision of a definition of switch-over time shall not require the replacement of an existing secondary power supply before 1 January 2010. However, for a secondary power supply installed after 4 November 1999, the electric power supply connections to those facilities for which secondary power is required shall be so arranged that the facilities are capable of meeting the requirements of Table 8-1 for maximum switch-over times as defined in Chapter 1.

Visual aids***Application***

- 8.1.6 For a precision approach runway, a secondary power supply capable of meeting the requirements of Table 8-1 for the appropriate category of precision approach runway shall be provided. Electric power supply connections to those facilities for which secondary power is required shall be so arranged that the facilities are automatically connected to the secondary power supply on failure of the primary source of power.
- 8.1.7 For a runway meant for take-off in runway visual range conditions less than a value of 800 m, a secondary power supply capable of meeting the relevant requirements of Table 8-1 shall be provided.
- 8.1.8 At an aerodrome where the primary runway is a non-precision approach runway, a secondary power supply capable of meeting the requirements of Table 8-1 shall be provided except that a secondary power supply for visual aids need not be provided for more than one non-precision approach runway.
- 8.1.9 At an aerodrome where the primary runway is a non-instrument runway, a secondary power supply capable of meeting the requirements of 8.1.4 shall be provided, except that a secondary power supply for visual aids need not be provided when an emergency lighting system in accordance with the specification of 5.3.2 is provided and capable of being deployed in 15 minutes.



8.1.10 The following aerodrome facilities shall be provided with a secondary power supply capable of supplying power when there is a failure of the primary power supply:

- (a) the signalling lamp and the minimum lighting necessary to enable air traffic services personnel to carry out their duties;
- (b) all obstacle lights which, in the opinion of the appropriate authority, are essential to ensure the safe operation of aircraft;
- (c) approach, runway and taxiway lighting as specified in 8.1.6 to 8.1.9;
- (d) meteorological equipment;
- (e) essential security lighting, if provided in accordance with 9.11;
- (f) essential equipment and facilities for the aerodrome responding emergency agencies;
- (g) floodlighting on a designated isolated aircraft parking position if provided in accordance with 5.3.24.1; and
- (h) illumination of apron areas over which passengers may walk.

8.1.11 Requirements for a secondary power supply shall be met by either of the following:

- independent public power, which is a source of power supplying the aerodrome service from a substation other than the normal substation through a transmission line following a route different from the normal power supply route and such that the possibility of a simultaneous failure of the normal and independent public power supplies is extremely remote; or
- standby power unit(s), which are engine generators, batteries, etc., from which electric power can be obtained.



Table 8-1. Secondary power supply requirements
(see 8.1.4)

Runway	Lighting aids requiring power	Maximum switch-over time
Non-instrument	Visual approach slope indicators ^a	See
	Runway edge ^b	8.1.4 and
	Runway threshold ^b	8.1.9
	Runway end ^b	
	Obstacle ^a	
Non-precision approach	Approach lighting system	15 seconds
	Visual approach slope indicators ^{a, d}	15 seconds
	Runway edge ^d	15 seconds
	Runway threshold ^d	15 seconds
	Runway end	15 seconds
	Obstacle ^a	15 seconds
Precision approach category I	Approach lighting system	15 seconds
	Runway edge ^d	15 seconds
	Visual approach slope indicators ^{a, d}	15 seconds
	Runway threshold ^d	15 seconds
	Runway end	15 seconds
	Essential taxiway ^a	15 seconds
	Obstacle ^a	15 seconds
Precision approach category II/III	Inner 300 m of the approach lighting system	1 second
	Other parts of the approach lighting system	15 seconds
	Obstacle ^a	15 seconds
	Runway edge	15 seconds
	Runway threshold	1 second
	Runway end	1 second
	Runway centre line	1 second
	Runway touchdown zone	1 second
	All stop bars	1 second
	Essential taxiway	15 seconds
Runway meant for take-off in runway visual range conditions less than a value of 800 m	Runway edge	15 seconds ^c
	Runway end	1 second
	Runway centre line	1 second
	All stop bars	1 second
	Essential taxiway ^a	15 seconds
	Obstacle ^a	15 seconds

- a. Supplied with secondary power when their operation is essential to the safety of flight operation.
- b. See Chapter 5, 5.3.2, regarding the use of emergency lighting.
- c. One second where no runway centre line lights are provided.
- d. One second where approaches are over hazardous or precipitous terrain.

8.2 System design

- 8.2.1 For a runway meant for use in runway visual range conditions less than a value of 550 m, the electrical systems for the power supply, lighting and control of the lighting systems included in Table 8-1 shall be so designed that an equipment failure will not leave the pilot with inadequate visual guidance or misleading information.
- 8.2.2 Where the secondary power supply of an aerodrome is provided by the use of duplicate feeders, such supplies shall be physically and electrically separate so as to ensure the required level of availability and independence.
- 8.2.3 Where a runway forming part of a standard taxi-route is provided with runway lighting and taxiway lighting, the lighting systems shall be interlocked to preclude the possibility of simultaneous operation of both forms of lighting.



8.3 Monitoring

- 8.3.1 A system of monitoring shall be employed to indicate the operational status of the lighting systems.
- 8.3.2 Where lighting systems are used for aircraft control purposes, such systems shall be monitored automatically so as to provide an indication of any fault which may affect the control functions. This information shall be automatically relayed to the air traffic services unit.
- 8.3.3 Where a change in the operational status of lights has occurred, an indication shall be provided within two seconds for a stop bar at a runway-holding position and within five seconds for all other types of visual aids.
- 8.3.4 For a runway meant for use in runway visual range conditions less than a value of 550 m, the lighting systems detailed in Table 8-1 shall be monitored automatically so as to provide an indication when the serviceability level of any element falls below the minimum serviceability level specified in 10.5.7 to 10.5.11, as appropriate. This information shall be automatically relayed to the maintenance crew.
- 8.3.5 or a runway meant for use in runway visual range conditions less than a value of 550 m, the lighting systems detailed in Table 8-1 shall be monitored automatically to provide an indication when the serviceability level of any element falls below the minimum level specified by the appropriate authority below which operations should not continue. This information shall be automatically relayed to the air traffic services unit and displayed in a prominent position.



CHAPTER 9

AERODROME OPERATIONAL SERVICES, EQUIPMENT AND INSTALLATIONS

9.1 Aerodrome emergency planning

General

- 9.1.1 An aerodrome emergency plan shall be established at an aerodrome, commensurate with the aircraft operations and other activities conducted at the aerodrome.
- 9.1.2 The aerodrome emergency plan shall provide for the coordination of the actions to be taken in an emergency occurring at an aerodrome or in its vicinity.
- 9.1.3 The plan shall coordinate the response or participation of all existing agencies which, in the opinion of the appropriate authority, could be of assistance in responding to an emergency.

Note 1: Examples of agencies are:

- *on the aerodrome: air traffic control units, rescue and fire-fighting services, aerodrome administration, medical and ambulance services, aircraft operators, security services, and police;*
- *off the aerodrome: fire departments, police, health authorities (including medical, ambulance, hospital and public health services), military, and harbour patrol or coast guard.*

Note 2: Public health services include planning to minimize adverse effects to the community from health-related events and deal with population health issues rather than provision of health services to individuals.

- 9.1.4 The plan shall provide for cooperation and coordination with the rescue coordination centre, as necessary.
- 9.1.5 The aerodrome emergency plan document should include at least the following:
- (a) types of emergencies planned for;
 - (b) agencies involved in the plan;
 - (c) responsibility and role of each agency, the emergency operations centre and the command post, for each type of emergency;
 - (d) information on names and telephone numbers of offices or people to be contacted in the case of a particular emergency; and
 - (e) a grid map of the aerodrome and its immediate vicinity.
- 9.1.6 The plan shall observe Human Factors principles to ensure optimum response by all existing agencies participating in emergency operations.



Emergency operations centre and command post

- 9.1.7 A fixed emergency operations centre and a mobile command post shall be available for use during an emergency.
- 9.1.8 The emergency operations centre shall be a part of the aerodrome facilities and shall be responsible for the overall coordination and general direction of the response to an emergency.
- 9.1.9 The command post should be a facility capable of being moved rapidly to the site of an emergency, when required, and should undertake the local coordination of those agencies responding to the emergency.
- 9.1.10 A person shall be assigned to assume control of the emergency operations centre and, when appropriate, another person the command post.

Communication system

- 9.1.11 Adequate communication systems linking the command post and the emergency operations centre with each other and with the participating agencies shall be provided in accordance with the plan and consistent with the particular requirements of the aerodrome.

Aerodrome emergency exercise

- 9.1.12 The plan shall contain procedures for periodic testing of the adequacy of the plan and for reviewing the results in order to improve its effectiveness.
- 9.1.13 The plan shall be tested by conducting:
- (a) a full-scale aerodrome emergency exercise at intervals not exceeding two years and partial emergency exercises in the intervening year to ensure that any deficiencies found during the full-scale aerodrome emergency exercise have been corrected; or
 - (b) a series of modular tests commencing in the first year and concluding in a full-scale aerodrome emergency exercise at intervals not exceeding three years;

and reviewed thereafter, or after an actual emergency, so as to correct any deficiency found during such exercises or actual emergency.

Emergencies in difficult environments

- 9.1.14 The plan shall include the ready availability of, and coordination with, appropriate specialist rescue services to be able to respond to emergencies where an aerodrome is located close to water and/or swampy areas and where a significant portion of approach or departure operations takes place over these areas.
- 9.1.15 At those aerodromes located close to water and/or swampy areas, or difficult terrain, the aerodrome emergency plan should include the establishment, testing and assessment at regular intervals of a predetermined response for the specialist rescue services.
- 9.1.16 An assessment of the approach and departure areas within 1 000 m of the runway threshold shall be carried out to determine the options available for intervention.



9.2 Rescue and fire-fighting

General

Application

- 9.2.1 Rescue and fire-fighting equipment and services shall be provided at an aerodrome.
- 9.2.2 Where an aerodrome is located close to water/swampy areas, or difficult terrain, and where a significant portion of approach or departure operations takes place over these areas, specialist rescue services and fire-fighting equipment appropriate to the hazard and risk shall be available.

Level of protection to be provided

- 9.2.3 The level of protection provided at an aerodrome for rescue and fire-fighting shall be appropriate to the aerodrome category determined using the principles in 9.2.5 and 9.2.6, except that, where the number of movements of the aeroplanes in the highest category normally using the aerodrome is less than 700 in the busiest consecutive three months, the level of protection provided shall be not less than one category below the determined category.
- 9.2.4 The level of protection provided at an aerodrome for rescue and fire-fighting shall be equal to the aerodrome category determined using the principles in 9.2.5 and 9.2.6.
- 9.2.5 The aerodrome category shall be determined from Table 9-1 and shall be based on the longest aeroplanes normally using the aerodrome and their fuselage width.
- 9.2.6 If, after selecting the category appropriate to the longest aeroplane’s overall length, that aeroplane’s fuselage width is greater than the maximum width in Table 9-1, column 3, for that category, then the category for that aeroplane shall actually be one category higher.
- 9.2.7 During anticipated periods of reduced activity, the level of protection available shall be no less than that needed for the highest category of aeroplane planned to use the aerodrome during that time irrespective of the number of movements.

Table 9-1. Aerodrome category for rescue and fire-fighting

Aerodrome category (1)	Aeroplane overall length (2)	Maximum fuselage width (3)
1	0 m up to but not including 9 m	2 m
2	9 m up to but not including 12 m	2 m
3	12 m up to but not including 18 m	3 m
4	18 m up to but not including 24 m	4 m
5	24 m up to but not including 28 m	4 m
6	28 m up to but not including 39 m	5 m
7	39 m up to but not including 49 m	5 m
8	49 m up to but not including 61 m	7 m
9	61 m up to but not including 76 m	7 m
10	76 m up to but not including 90 m	8 m



Extinguishing agents

9.2.8 Both principal and complementary agents should normally be provided at an aerodrome.

9.2.9 The principal extinguishing agent should be:

- (a) a foam meeting the minimum performance level A; or
- (b) a foam meeting the minimum performance level B; or
- (c) a foam meeting the minimum performance level C; or
- (d) a combination of these agents;

except that the principal extinguishing agent for aerodromes in categories 1 to 3 should preferably meet a performance level B or C foam.

9.2.10 The complementary extinguishing agent shall be a dry chemical powder suitable for extinguishing hydrocarbon fires.

9.2.11 The amounts of water for foam production and the complementary agents to be provided on the rescue and fire-fighting vehicles shall be in accordance with the aerodrome category determined under 9.2.3, 9.2.4, 9.2.5, 9.2.6 and Table 9-2, except that for aerodrome categories 1 and 2 up to 100 per cent of the water may be substituted with complementary agent.

For the purpose of agent substitution, 1 kg of complementary agent shall be taken as equivalent to 1.0 L of water for production of a foam meeting performance level A.

9.2.12 At aerodromes where operations by aeroplanes larger than the average size in a given category are planned, the quantities of water should be recalculated and the amount of water for foam production and the discharge rates for foam solution should be increased accordingly.

9.2.13 From 1 January 2015, at aerodromes where operations by aeroplanes larger than the average size in a given category are planned, the quantities of water shall be recalculated and the amount of water for foam production and the discharge rates for foam solution shall be increased accordingly.

Table 9-2. Minimum usable amounts of extinguishing agents



Aerodrome category (1)	Foam meeting performance level A		Foam meeting performance level B		Foam meeting performance level C		Complementary agents	
	Water (L) (2)	Discharge rate foam solution/minute (L) (3)	Water (L) (4)	Discharge rate foam solution/minute (L) (5)	Water (L) (6)	Discharge rate foam solution/minute (L) (7)	Dry chemical powders (kg) (8)	Discharge Rate (kg/second) (9)
1	350	350	230	230	160	160	45	2.25
2	1 000	800	670	550	460	360	90	2.25
3	1 800	1 300	1 200	900	820	630	135	2.25
4	3 600	2 600	2 400	1 800	1 700	1 100	135	2.25
5	8 100	4 500	5 400	3 000	3 900	2 200	180	2.25
6	11 800	6 000	7 900	4 000	5 800	2 900	225	2.25
7	18 200	7 900	12 100	5 300	8 800	3 800	225	2.25
8	27 300	10 800	18 200	7 200	12 800	5 100	450	4.5
9	36 400	13 500	24 300	9 000	17 100	6 300	450	4.5
10	48 200	16 600	32 300	11 200	22 800	7 900	450	4.5

Note.— The quantities of water shown in columns 2, 4 and 6 are based on the average overall length of aeroplanes in a given category.

- 9.2.14 The quantity of foam concentrates separately provided on vehicles for foam production shall be in proportion to the quantity of water provided and the foam concentrate selected.
- 9.2.15 The amount of foam concentrate provided on a vehicle shall be sufficient to produce at least two loads of foam solution.
- 9.2.16 Supplementary water supplies, for the expeditious replenishment of rescue and fire-fighting vehicles at the scene of an aircraft accident, shall be provided.
- 9.2.17 When a combination of different performance level foams are provided at an aerodrome, the total amount of water to be provided for foam production should be calculated for each foam type and the distribution of these quantities shall be documented for each vehicle and applied to the overall rescue and fire-fighting requirement.
- 9.2.18 The discharge rate of the foam solution shall not be less than the rates shown in Table 9-2.
- 9.2.19 The complementary agents shall comply with the appropriate specifications of the International Organization for Standardization (ISO).*
- 9.2.20 The discharge rate of complementary agents shall be no less than the values shown in Table 9-2.
- 9.2.21 Dry chemical powders shall only be substituted with an agent that has equivalent or better fire-fighting capabilities for all types of fires where complementary agent is expected to be used.
- 9.2.22 A reserve supply of foam concentrate, equivalent to 200 per cent of the quantities identified in Table 9-2, shall be maintained on the aerodrome for vehicle replenishment purposes.
- 9.2.23 A reserve supply of complementary agent, equivalent to 100 per cent of the quantity identified in Table 9-2, shall be maintained on the aerodrome for vehicle replenishment purposes. Sufficient propellant gas shall be included to utilize this reserve complementary agent.
- 9.2.24 Category 1 and 2 aerodromes that have replaced up to 100 per cent of the water with complementary agent shall hold a reserve supply of complementary agent of 200 per cent.
- 9.2.25 Where a major delay in the replenishment of the supplies is anticipated, the amount of reserve supply in 9.2.22, 9.2.23 and 9.2.24 shall be increased as determined by a risk assessment.

Rescue equipment



9.2.26 Rescue equipment commensurate with the level of aircraft operations shall be provided on the rescue and fire-fighting vehicle(s).

Response time

9.2.27 The operational objective of the rescue and fire-fighting service shall be to achieve a response time not exceeding three minutes to any point of each operational runway, in optimum visibility and surface conditions.

9.2.28 The operational objective of the rescue and fire-fighting service shall be to achieve a response time not exceeding two minutes to any point of each operational runway, in optimum visibility and surface conditions.

9.2.29 The operational objective of the rescue and fire-fighting service shall be to achieve a response time not exceeding three minutes to any other part of the movement area, in optimum visibility and surface conditions.

9.2.30 To meet the operational objective as nearly as possible in less than optimum conditions of visibility, especially during low visibility operations, suitable guidance, equipment and/or procedures for rescue and fire-fighting services shall be provided.

9.2.31 Any vehicles, other than the first responding vehicle(s), required to deliver the amounts of extinguishing agents specified in Table 9-2 shall ensure continuous agent application and shall arrive no more than four minutes from the initial call.

9.2.32 Any vehicles, other than the first responding vehicles(s), required to deliver the amounts of extinguishing agents specified in Table 9-2 shall ensure continuous agent application and should arrive no more than three minutes from the initial call.

9.2.33 A system of preventive maintenance of rescue and fire-fighting vehicles shall be employed to ensure effectiveness of the equipment and compliance with the specified response time throughout the life of the vehicle.

Emergency access roads

9.2.34 Emergency access roads shall be provided on an aerodrome where terrain conditions permit their construction, so as to facilitate achieving minimum response times. Particular attention shall be given to the provision of ready access to approach areas up to 1 000 m from the threshold, or at least within the aerodrome boundary. Where a fence is provided, the need for convenient access to outside areas should be taken into account.

9.2.35 Emergency access roads shall be capable of supporting the heaviest vehicles which will use them, and be usable in all weather conditions. Roads within 90 m of a runway shall be surfaced to prevent surface erosion and the transfer of debris to the runway. Sufficient vertical clearance shall be provided from overhead obstructions for the largest vehicles.

9.2.36 When the surface of the road is indistinguishable from the surrounding area, edge markers shall be placed at intervals of about 10 m.

Fire stations



9.2.37 All rescue and fire-fighting vehicles shall normally be housed in a fire station. Satellite fire stations shall be provided whenever the response time cannot be achieved from a single fire station.

9.2.38 The fire station shall be located so that the access for rescue and fire-fighting vehicles into the runway area is direct and clear, requiring a minimum number of turns.

Communication and alerting systems

9.2.39 A discrete communication system shall be provided linking a fire station with the control tower, any other fire station on the aerodrome and the rescue and fire-fighting vehicles.

9.2.40 An alerting system for rescue and fire-fighting personnel, capable of being operated from that station, shall be provided at a fire station, any other fire station on the aerodrome and the aerodrome control tower.

Number of rescue and fire-fighting vehicles

9.2.41 The minimum number of rescue and fire-fighting vehicles provided at an aerodrome should be in accordance with the following tabulation:

Aerodrome category	Rescue and fire-fighting vehicles
1	1
2	1
3	1
4	1
5	1
6	2
7	2
8	3
9	3
10	3

Personnel

9.2.42 All rescue and fire-fighting personnel shall be properly trained to perform their duties in an efficient manner and shall participate in live fire drills commensurate with the types of aircraft and type of rescue and fire-fighting equipment in use at the aerodrome, including pressure-fed fuel fires.

9.2.43 The rescue and fire-fighting personnel training programme shall include training in human performance, including team coordination.

9.2.44 During flight operations, sufficient trained and competent personnel shall be designated to be readily available to ride the rescue and fire-fighting vehicles and to operate the equipment at maximum capacity. These personnel shall be deployed in a way that ensures that minimum response times can be achieved and that continuous agent application at the appropriate rate can be fully maintained. Consideration should also be given for personnel to use hand lines, ladders and other rescue and fire-fighting equipment normally associated with aircraft rescue and fire-fighting operations.

9.2.45 In determining the minimum number of rescue and fire-fighting personnel required, a task resource analysis shall be completed and the level of staffing documented in the Aerodrome Manual.



9.2.46 All responding rescue and fire-fighting personnel shall be provided with protective clothing and respiratory equipment to enable them to perform their duties in an effective manner.

9.3 Disabled aircraft removal

9.3.1 A plan for the removal of an aircraft disabled on, or adjacent to, the movement area shall be established for an aerodrome, and a coordinator designated to implement the plan, when necessary.

9.3.2 The disabled aircraft removal plan shall be based on the characteristics of the aircraft that may normally be expected to operate at the aerodrome, and include among other things:

- (a) a list of equipment and personnel on, or in the vicinity of, the aerodrome which would be available for such purpose; and
- (b) arrangements for the rapid receipt of aircraft recovery equipment kits available from other aerodromes.

9.4 Wildlife strike hazard reduction

9.4.1 The wildlife strike hazard on, or in the vicinity of, an aerodrome shall be assessed through:

- (a) the establishment of a national procedure for recording and reporting wildlife strikes to aircraft;
- (b) the collection of information from aircraft operators, aerodrome personnel and other sources on the presence of wildlife on or around the aerodrome constituting a potential hazard to aircraft operations; and
- (c) an ongoing evaluation of the wildlife hazard by competent personnel.

Note.— See ICAO Annex 15, Chapter 5.

9.4.2 Wildlife strike reports shall be collected and forwarded to ICAO for inclusion in the ICAO Bird Strike Information System (IBIS) database.

9.4.3 Action shall be taken to decrease the risk to aircraft operations by adopting measures to minimize the likelihood of collisions between wildlife and aircraft; including

- (a) published procedures on the management of wildlife hazards on and within the vicinity of aerodromes, including the establishment of a wildlife hazard management programme (WHMP), wildlife risk assessment, land-use management and personnel training; and
- (b) published procedures to follow in the event of conflicting interests between land use and aviation authorities, to ensure that aircraft safety is not compromised.

9.4.4 The Authority, in cooperation with the aerodrome operating authority, shall take action to eliminate or to prevent the establishment of garbage disposal dumps or any other source which may attract wildlife to the aerodrome, or its vicinity, unless an appropriate wildlife assessment indicates that they are unlikely to create conditions conducive to a wildlife hazard problem. Where the elimination of existing sites is not possible, the Authority shall ensure that any risk to aircraft posed by these sites is assessed and reduced to as low as reasonably practicable.

9.4.5 The Authority shall give due consideration to aviation safety concerns related to land



developments in the vicinity of the aerodrome that may attract wildlife.

9.5 Apron management service

9.5.1 When warranted by the volume of traffic and operating conditions, an appropriate apron management service shall be provided on an apron by an aerodrome ATS unit, by another aerodrome operating authority, or by a cooperative combination of these, in order to:

- (a) regulate movement with the objective of preventing collisions between aircraft, and between aircraft and obstacles;
- (b) regulate entry of aircraft into, and coordinate exit of aircraft from, the apron with the aerodrome control tower; and
- (c) ensure safe and expeditious movement of vehicles and appropriate regulation of other activities.

9.5.2 When the aerodrome control tower does not participate in the apron management service, procedures should be established to facilitate the orderly transition of aircraft between the apron management unit and the aerodrome control tower.

9.5.3 An apron management service shall be provided with radiotelephony communications facilities.

9.5.4 Where low visibility procedures are in effect, persons and vehicles operating on an apron shall be restricted to the essential minimum.

9.5.5 An emergency vehicle responding to an emergency shall be given priority over all other surface movement traffic.

9.5.6 A vehicle operating on an apron shall:

- (a) give way to an emergency vehicle; an aircraft taxiing, about to taxi, or being pushed or towed; and
- (b) give way to other vehicles in accordance with local regulations.

9.5.7 An aircraft stand shall be visually monitored to ensure that the recommended clearance distances are provided to an aircraft using the stand.

9.6 Ground servicing of aircraft

9.6.1 Fire extinguishing equipment suitable for at least initial intervention in the event of a fuel fire and personnel trained in its use shall be readily available during the ground servicing of an aircraft, and there shall be a means of quickly summoning the rescue and fire-fighting service in the event of a fire or major fuel spill.

9.6.2 When aircraft refuelling operations take place while passengers are embarking, on board or disembarking, ground equipment shall be positioned so as to allow:

- (a) the use of a sufficient number of exits for expeditious evacuation; and
- (b) a ready escape route from each of the exits to be used in an emergency.



9.7 Aerodrome vehicle operations

(See Appendix 3)

Note 1— Procedures on the establishment of an airside driver permit (ADP) scheme and vehicle/equipment safety requirements, including detailed personnel training, are specified in the PANS-Aerodromes (Doc 9981), Part II, Chapter 9.

Note 2.— Guidance on aerodrome vehicle operations is contained in the Manual of Surface Movement Guidance and Control Systems (SMGCS) (Doc 9476).

Note 3.— It is intended that roads located on the movement area be restricted to the exclusive use of aerodrome personnel and other authorized persons, and that access to the public buildings by an unauthorized person will not require use of such roads.

9.7.1 A vehicle shall be operated:

- (a) on a manoeuvring area only as authorized by the aerodrome control tower; and
- (b) on an apron only as authorized by the appropriate designated authority.

9.7.2 The driver of a vehicle on the movement area shall comply with all mandatory instructions conveyed by markings and signs unless otherwise authorized by:

- (a) the aerodrome control tower when on the manoeuvring area; or
- (b) the appropriate designated authority when on the apron.

9.7.3 The driver of a vehicle on the movement area shall comply with all mandatory instructions conveyed by lights.

9.7.4 The driver of a vehicle on the movement area shall be appropriately trained for the tasks to be performed and shall comply with the instructions issued by:

- (a) the aerodrome control tower, when on the manoeuvring area; and
- (b) the appropriate designated authority, when on the apron.

9.7.5 The driver of a radio-equipped vehicle shall establish satisfactory two-way radio communication with the aerodrome control tower before entering the manoeuvring area and with the appropriate designated authority before entering the apron. The driver shall maintain a continuous listening watch on the assigned frequency when on the movement area.

9.8 Surface movement guidance and control systems

Application

9.8.1 A surface movement guidance and control system (SMGCS) shall be provided at an aerodrome.

Characteristics

9.8.2 The design of an SMGCS shall take into account:

- (a) the density of air traffic;



- (b) the visibility conditions under which operations are intended;
 - (c) the need for pilot orientation;
 - (d) the complexity of the aerodrome layout; and
 - (e) movements of vehicles.
- 9.8.3 The visual aid components of an SMGCS, i.e. markings, lights and signs, shall be designed to conform with the relevant specifications in 5.2, 5.3 and 5.4, respectively.
- 9.8.4 An SMGCS should be designed to assist in the prevention of inadvertent incursions of aircraft and vehicles onto an active runway.
- 9.8.5 The system shall be designed to assist in the prevention of collisions between aircraft, and between aircraft and vehicles or objects, on any part of the movement area.
- 9.8.6 Where an SMGCS is provided by selective switching of stop bars and taxiway centre line lights, the following requirements shall be met:
- (a) taxiway routes which are indicated by illuminated taxiway centre line lights shall be capable of being terminated by an illuminated stop bar;
 - (b) the control circuits shall be so arranged that when a stop bar located ahead of an aircraft is illuminated, the appropriate section of taxiway centre line lights beyond it is suppressed; and
 - (c) the taxiway centre line lights are activated ahead of an aircraft when the stop bar is suppressed.
- Note — See Sections 5.3.17 and 5.3.20 for specifications on taxiway centre line lights and stop bars, respectively.*
- 9.8.7 Surface movement radar for the manoeuvring area shall be provided at an aerodrome intended for use in runway visual range conditions less than a value of 350 m.
- 9.8.8 Surface movement radar for the manoeuvring area should be provided at an aerodrome other than that in 9.8.7 when traffic density and operating conditions are such that regularity of traffic flow cannot be maintained by alternative procedures and facilities.

9.9 Siting of equipment and installations on operational areas

- 9.9.1 Unless its function requires it to be there for air navigation or for aircraft safety purposes, no equipment or installation shall be:
- (a) on a runway strip, a runway end safety area, a taxiway strip or within the distances specified in Table 3-1, column 11, if it would endanger an aircraft; or
 - (b) on a clearway if it would endanger an aircraft in the air.
- 9.9.2 Any equipment or installation required for air navigation or for aircraft safety purposes which must be located:



- (a) on that portion of a runway strip within:
 - (1) 75 m of the runway centre line where the code number is 3 or 4; or
 - (2) 45 m of the runway centre line where the code number is 1 or 2; or
- (b) on a runway end safety area, a taxiway strip or within the distances specified in Table 3-1; or
- (c) on a clearway and which would endanger an aircraft in the air; shall be frangible and mounted as low as possible.

9.9.3 Any equipment or installation required for air navigation or for aircraft safety purposes which must be located on the non-graded portion of a runway strip shall be regarded as an obstacle and shall be frangible and mounted as low as possible.

9.9.4 Unless its function requires it to be there for air navigation or for aircraft safety purposes, no equipment or installation shall be located within 240 m from the end of the strip and within:

- (a) 60 m of the extended centre line where the code number is 3 or 4; or
- (b) 45 m of the extended centre line where the code number is 1 or 2; of a precision approach runway category I, II or III.

9.9.5 Any equipment or installation required for air navigation or for aircraft safety purposes which must be located on or near a strip of a precision approach runway category I, II or III and which:

- (a) is situated within 240 m from the end of the strip and within:
 - (1) 60 m of the extended runway centre line where the code number is 3 or 4; or
 - (2) 45 m of the extended runway centre line where the code number is 1 or 2; or
- (b) penetrates the inner approach surface, the inner transitional surface or the balked landing surface; shall be frangible and mounted as low as possible.

9.9.6 Any equipment or installation required for air navigation or for aircraft safety purposes, which is an obstacle of operational significance in accordance with 4.2.4, 4.2.11, 4.2.20 or 4.2.27 should be frangible and mounted as low as possible.

9.10 Fencing

Application

9.10.1 A fence or other suitable barrier shall be provided on an aerodrome to prevent the entrance to the movement area of animals large enough to be a hazard to aircraft.

9.10.2 A fence or other suitable barrier shall be provided on an aerodrome to deter the inadvertent or premeditated access of an unauthorized person onto a non-public area of the aerodrome.

Note 1.— This is intended to include the barring of sewers, ducts, tunnels, etc., where necessary to



prevent access.

Note 2.— Special measures may be required to prevent the access of an unauthorized person to runways or taxiways which overpass public roads.

9.10.3 Suitable means of protection shall be provided to deter the inadvertent or premeditated access of unauthorized persons into ground installations and facilities essential for the safety of civil aviation located off the aerodrome.

Location

9.10.4 The fence or barrier shall be located so as to separate the movement area and other facilities or zones on the aerodrome vital to the safe operation of aircraft from areas open to public access.

9.10.5 When greater security is thought necessary, a cleared area should be provided on both sides of the fence or barrier to facilitate the work of patrols and to make trespassing more difficult. Consideration should be given to the provision of a perimeter road inside the aerodrome fencing for the use of both maintenance personnel and security patrols.

9.11 Security lighting

At an aerodrome where it is deemed desirable for security reasons, a fence or other barrier provided for the protection of international civil aviation and its facilities should be illuminated at a minimum essential level. Consideration should be given to locating lights so that the ground area on both sides of the fence or barrier, particularly at access points, is illuminated.

9.12 Autonomous runway incursion warning system

Characteristics

9.12.1 Where an ARIWS is installed at an aerodrome:

- (a) it shall provide autonomous detection of a potential incursion or of the occupancy of an active runway and a direct warning to a flight crew or vehicle operator;
- (b) it shall function and be controlled independently of any other visual system on the aerodrome;
- (c) its visual aid components, i.e. lights, shall be designed to conform with the relevant specifications in 5.3; and
- (d) failure of part or all of it shall not interfere with normal aerodrome operations. To this end, provision shall be made to allow the ATC unit to partially or entirely shut down the system.

9.12.2 Where an ARIWS is installed at an aerodrome, information on its characteristics and status shall be provided to the appropriate Aeronautical Information Services for promulgation in the AIP with the description of the aerodrome surface movement guidance and control system and markings as specified in Annex 15.



This Page Intentionally Left Blank



CHAPTER 10

AERODROME MAINTENANCE

10.1 General

10.1.1 A maintenance programme, including preventive maintenance where appropriate, shall be established at an aerodrome to maintain facilities in a condition which does not impair the safety, regularity or efficiency of air navigation.

Note 1.— Preventive maintenance is programmed maintenance work done in order to prevent a failure or degradation of facilities.

Note 2.— “Facilities” are intended to include such items as pavements, visual aids, fencing, drainage systems, electrical systems and buildings.

10.1.2 The design and application of the maintenance programme shall observe Human Factors principles.

10.2 Pavements

10.2.1 The surfaces of all movement areas including pavements (runways, taxiways and aprons) and adjacent areas shall be inspected and their conditions monitored regularly as part of an aerodrome preventive and corrective maintenance programme with the objective of avoiding and eliminating any foreign object debris (FOD) that might cause damage to aircraft or impair the operation of aircraft systems.

Note 1.— See 2.9.3 for inspections of movement areas.

Note 2.— Where the pavement is used by large aircraft or aircraft with tyre pressures in the upper categories referred to in 2.6.6 c), particular attention should be given to the integrity of light fittings in the pavement and pavement joints.

10.2.2 The surface of a runway shall be maintained in a condition such as to prevent formation of harmful irregularities.

Note.— See Attachment A, Section 5.

10.2.3 A paved runway shall be maintained in a condition so as to provide surface friction characteristics at or above the minimum friction level specified by the Authority.

10.2.4 Runway surface friction characteristics for maintenance purposes shall be periodically measured with a continuous friction measuring device using self-wetting features and documented. The frequency of these measurements shall be sufficient to determine the trend of the surface friction characteristics of the runway.

Note 1.— Guidance on evaluating the runway surface friction characteristics of a runway is provided in Attachment A, Section 7.

Note 2.— The objective of 10.2.3 to 10.2.8 is to ensure that the surface friction characteristics for the entire runway remain at or above a minimum friction level specified in Appendix 2.



Note 3.— Guidance for the determination of the required frequency is provided in Attachment A, Section 7 and in the Airport Services Manual (Doc 9137), Part 2, Appendix 5.

- 10.2.5 When runway surface friction measurements are made for maintenance purposes using a self-wetting continuous friction measuring device, the performance of the device shall meet the standard set or agreed by the Authority.
- 10.2.6 Personnel measuring runway surface friction required in 10.2.5 shall be trained to fulfil their duties.
- 10.2.7 Corrective maintenance action shall be taken to prevent the runway surface friction characteristics for either the entire runway or a portion thereof from falling below a minimum friction level specified by the Authority. (See Appendix 2)

Note.— A portion of runway in the order of 100 m long may be considered significant for maintenance or reporting action.

- 10.2.8 The runway surface shall be visually assessed, as necessary, under natural or simulated rain conditions for ponding or poor drainage and where required, corrective maintenance action taken.

10.3 Removal of contaminants

- 10.3.1 Standing water, mud, dust, sand, oil, rubber deposits and other contaminants shall be removed from the surface of runways in use as rapidly and completely as possible to minimize accumulation.

Note.— The above requirement does not imply that winter operations on compacted snow and ice are prohibited.

- 10.3.2 Taxiways should be kept clear of contaminants to the extent necessary to enable aircraft to be taxied to and from an operational runway.
- 10.3.3 Aprons should be kept free of contaminants to the extent necessary to enable aircraft to manoeuvre safely or, where appropriate, to be towed or pushed.
- 10.3.4 Whenever the clearance of contaminants from the various parts of the movement area cannot be carried out simultaneously, the order of priority after the runway(s) in use should be set in consultation with the affected parties such as rescue and fire-fighting service and documented in a snow plan.
- 10.3.5 Chemicals to remove or to prevent the formation of ice and frost on aerodrome pavements should be used when conditions indicate their use could be effective. Caution should be exercised in the application of the chemicals so as not to create a more slippery condition.
- 10.3.6 Chemicals which may have harmful effects on aircraft or pavements, or chemicals which may have toxic effects on the aerodrome environment, shall not be used.

10.4 Runway pavement overlays

Note.— The following specifications are intended for runway pavement overlay projects when the runway is to be returned temporarily to an operational status before resurfacing is complete. This may necessitate a temporary ramp between the new and old runway surfaces.



- 10.4.1 The longitudinal slope of the temporary ramp, measured with reference to the existing runway surface or previous overlay course, shall be:
- (a) 0.5 to 1.0 per cent for overlays up to and including 5 cm in thickness; and
 - (b) not more than 0.5 per cent for overlays more than 5 cm in thickness.
- 10.4.2 Overlaying shall proceed from one end of the runway toward the other end so that based on runway utilization most aircraft operations will experience a down ramp.
- 10.4.3 The entire width of the runway shall be overlaid during each work session.
- 10.4.4 Before a runway being overlaid is returned to a temporary operational status, a runway centre line marking conforming to the specifications in Section 5.2.3 shall be provided. Additionally, the location of any temporary threshold shall be identified by a 3.6 m wide transverse stripe.
- 10.4.5 The overlay shall be constructed and maintained above the minimum friction level specified in 10.2.3.

10.5 Visual aids

Note 1.— These specifications are intended to define the maintenance performance level objectives. They are not intended to define whether the lighting system is operationally out of service.

Note 2.— The energy savings of light emitting diodes (LEDs) are due in large part to the fact that they do not produce the infra-red heat signature of incandescent lamps. Aerodrome operators who have come to expect the melting of ice and snow by this heat signature may wish to evaluate whether or not a modified maintenance schedule is required during such conditions, or evaluate the possible operational value of installing LED fixtures with heating elements.

Note 3.— Enhanced vision systems (EVS) technology relies on the infra-red heat signature provided by incandescent lighting. Annex 15 protocols provide an appropriate means of notifying aerodrome users of EVS when lighting systems are converted to LED.

- 10.5.1 A light shall be deemed to be unserviceable when the main beam average intensity is less than 50 per cent of the value specified in the appropriate figure in Appendix 2 to ICAO Annex 14, Volume 1. For light units where the designed main beam average intensity is above the value shown in Appendix 2 to ICAO Annex 14, Volume 1, the 50 per cent value shall be related to that design value.
- 10.5.2 A system of preventive maintenance of visual aids shall be employed to ensure lighting and marking system reliability.
- 10.5.3 The system of preventive maintenance employed for a precision approach runway category II or III should include at least the following checks:
- (a) visual inspection and in-field measurement of the intensity, beam spread and orientation of lights included in the approach and runway lighting systems;
 - (b) control and measurement of the electrical characteristics of each circuitry included in the approach and runway lighting systems; and



- (c) control of the correct functioning of light intensity settings used by air traffic control.
- 10.5.4 In-field measurement of intensity, beam spread and orientation of lights included in approach and runway lighting systems for a precision approach runway category II or III shall be undertaken by measuring all lights, as far as practicable, to ensure conformance with the applicable specification of Appendix 2 to ICAO Annex 14, Volume 1.
- 10.5.5 Measurement of intensity, beam spread and orientation of lights included in approach and runway lighting systems for a precision approach runway category II or III shall be undertaken using a mobile measuring unit of sufficient accuracy to analyse the characteristics of the individual lights.
- 10.5.6 The frequency of measurement of lights for a precision approach runway category II or III should be based on traffic density, the local pollution level, the reliability of the installed lighting equipment and the continuous assessment of the results of the in-field measurements but, in any event, should not be less than twice a year for in-pavement lights and not less than once a year for other lights.
- 10.5.7 The system of preventive maintenance employed for a precision approach runway category II or III shall have as its objective that, during any period of category II or III operations, all approach and runway lights are serviceable and that, in any event, at least:
- (a) 95 per cent of the lights are serviceable in each of the following particular significant elements:
 - (1) precision approach category II and III lighting system, the inner 450 m;
 - (2) runway centre line lights;
 - (3) runway threshold lights; and
 - (4) runway edge lights;
 - (b) 90 per cent of the lights are serviceable in the touchdown zone lights;
 - (c) 85 per cent of the lights are serviceable in the approach lighting system beyond 450 m; and
 - (d) 75 per cent of the lights are serviceable in the runway end lights.

In order to provide continuity of guidance, the allowable percentage of unserviceable lights shall not be permitted in such a way as to alter the basic pattern of the lighting system. Additionally, an unserviceable light shall not be permitted adjacent to another unserviceable light, except in a barrette or a crossbar where two adjacent unserviceable lights may be permitted.

Note.— With respect to barrettes, crossbars and runway edge lights, lights are considered to be adjacent if located consecutively and:

- laterally: in the same barrette or crossbar; or
- longitudinally: in the same row of edge lights or barrettes.

- 10.5.8 The system of preventive maintenance employed for a stop bar provided at a runway-holding position used in conjunction with a runway intended for operations in runway visual range conditions less than a value of 350 m shall have the following objectives:



- (a) no more than two lights will remain unserviceable; and
- (b) two adjacent lights will not remain unserviceable unless the light spacing is significantly less than that specified.

10.5.9 The system of preventive maintenance employed for a taxiway intended for use in runway visual range conditions less than a value of 350 m shall have as its objective that no two adjacent taxiway centre line lights be unserviceable.

10.5.10 The system of preventive maintenance employed for a precision approach runway category I shall have as its objective that, during any period of category I operations, all approach and runway lights are serviceable and that, in any event, at least 85 per cent of the lights are serviceable in each of the following:

- (a) precision approach category I lighting system;
- (b) runway threshold lights;
- (c) runway edge lights; and
- (d) runway end lights.

In order to provide continuity of guidance an unserviceable light shall not be permitted adjacent to another unserviceable light unless the light spacing is significantly less than that specified.

Note.— In barrettes and crossbars, guidance is not lost by having two adjacent unserviceable lights.

10.5.11 The system of preventive maintenance employed for a runway meant for take-off in runway visual range conditions less than a value of 550 m shall have as its objective that, during any period of operations, all runway lights are serviceable and that in any event:

- (a) at least 95 per cent of the lights are serviceable in the runway centre line lights (where provided) and in the runway edge lights; and
- (b) at least 75 per cent of the lights are serviceable in the runway end lights.

In order to provide continuity of guidance, an unserviceable light shall not be permitted adjacent to another unserviceable light.

10.5.12 The system of preventive maintenance employed for a runway meant for take-off in runway visual range conditions of a value of 550 m or greater shall have as its objective that, during any period of operations, all runway lights are serviceable and that, in any event, at least 85 per cent of the lights are serviceable in the runway edge lights and runway end lights. In order to provide continuity of guidance, an unserviceable light shall not be permitted adjacent to another unserviceable light.

10.5.13 During low visibility procedures the appropriate authority shall restrict construction or maintenance activities in the proximity of aerodrome electrical systems.



This Page Intentionally Left Blank

**CHAPTER 11****CERTIFICATION PROCESS****11.1 General requirements for certification**

(See AC 11.1)

11.1.1 An aerodrome operator shall apply to the Authority at least 90 days prior to proposed commencement of aircraft operations.

11.1.2 The aerodrome operator must satisfy the Authority that;

- (a) its organisation and management are suitable and properly matched to the scale and scope of the operation; and
- (b) procedures for the supervision of operations have been defined

11.1.3 An aerodrome operator shall not provide any aerodrome related service otherwise than under, and in accordance with, the terms and conditions of an aerodrome certificate from the Authority.

11.1.4 An applicant for an aerodrome certificate, or variation of an aerodrome certificate, shall allow the Authority to examine all safety aspects of the proposed service.

11.1.5 An applicant for an aerodrome certificate, or revalidation of the aerodrome certificate; shall

- (a) have his principal place of business and, if any, his registered office located in The Bahamas;
- (b) satisfy the Authority that he is able to conduct safe services.

11.1.6 The aerodrome certificate shall engage and/or employ the services of;
(See AC 11.1.6)

- (a) an Accountable Manager who has the authority within the organisation to ensure that each of the ATS units can be financed and properly organised, equipped and trained to meet the requirements of these regulations;
- (b) Head of each department;
- (c) A Safety Management Manager responsible for the provision of an effective safety management system acceptable to the Authority
- (d) A Quality Manager responsible for the provision of a quality management system acceptable to the Authority; and
- (e) Sufficient personnel to manage, supervise, provide and support the aerodrome and any associated training or assessment processes agreed with and approved by the Authority

11.1.7 The persons listed in 2.1.6 shall be shall be responsible to the Accountable Manager and approved by the Authority.

11.1.8 An applicant for an aerodrome certificate shall establish a safety management system, which is;



- (a) in accordance with the framework elements contained CAR SMS;
- (b) commensurate with the size of the service provided and the complexity of its aviation products or services; and
- (c) be made acceptable to the Authority as being responsible for the aerodrome's certification.

11.2 Grant of an aerodrome certificate

(See AC 11.2)

11.2.1 The Authority shall issue the aerodrome certificate provided:

- (a) The applicant has satisfactorily completed the technical certification process;
- (b) The applicant and his staff have demonstrated the necessary competence and experience to operate and maintain the aerodrome safely;
- (c) The aerodrome operating manual submitted by the applicant for approval contains all the relevant information corresponding to the aerodrome site, facilities, services, equipment, operating procedures, organisation and management as stated in this regulation;
- (d) The aerodrome facilities, services and equipment are in accordance with the relevant CAR;
- (e) The aerodrome operating procedures make satisfactory provision for the safety of aircraft; and
- (f) The applicant has implemented an acceptable SMS.

11.2.2 Any conditions or limitations stated on the aerodrome certificate shall be complied with.

11.3 Duration of an Aerodrome certificate

11.3.1 An aerodrome certificate issued under CAR AGA 1 shall remain in force from the date of issue until it is suspended, transferred or cancelled by the Authority or, alternatively, until the validity period has expired.

11.3.2 An aerodrome certificate shall be valid for a maximum period of 5 years.

11.3.3 Any renewals of the aerodrome certificate shall be subject to approval by the Authority.

11.3.4 The Authority may revoke an aerodrome certificate if during the surveillance process the aerodrome operator does not demonstrate that it maintains the necessary competencies or if it incurs in recurring failures in the resolution of any non-conformities found.

11.4 Transfer of an aerodrome certificate

11.4.1 The Authority may give its consent to and issue an instrument of transfer of an aerodrome certificate to a transferee when:

- (a) The current holder of the aerodrome certificate notifies the Authority, in writing, at least three months before ceasing to operate the aerodrome as of the date specified in the notice, including the name of the transferee or aerodrome operator.



- (b) The transferee applies to the Authority, in writing, within two months before the current holder of the aerodrome certificate ceases to operate the aerodrome for the aerodrome certificate to be transferred to the transferee.

11.4.2 If there are no changes in the original terms of the certificate, only the holder transfer shall be recorded and the certificate amended. If there are changes, the Authority shall evaluate the situation and communicate, in writing, to the transferee the actions to be taken. These actions may go from a partial re-certification process or less, up to the application of the full certification process.

11.4.3 If the Authority does not consent to the transfer of an aerodrome certificate, it shall notify the transferee, in writing, of its reasons no later than 15 business days after making that decision.

11.5 Amendment of an aerodrome certificate

11.5.1 The Authority may amend an aerodrome certificate when:

- (a) there is a change in the ownership;
- (b) there is a change in the use;
- (c) there is a change in the boundaries of the aerodrome; or
- (d) the holder of the aerodrome certificate requests an amendment by requirement of the Authority.

11.6 Surrender of an Aerodrome certificate

11.6.1 An aerodrome certificate holder must give the Authority not less than 60 days' written notice of the date on which the certificate is to be surrendered in order that suitable promulgation action can be taken.

11.6.2 The Authority shall cancel the aerodrome certificate after the notice period is closed.



This Page Intentionally Left Blank

**CHAPTER 12****AERODROME OPERATIONS MANUAL****12.1 Requirement of the Aerodrome Operations Manual**

(See Appendix 1)

(See AC 12.1)

12.1.1 To be a holder of an aerodrome certificate, the applicant shall have an aerodrome operations manual approved by the Authority, containing relevant information for the aerodrome maintenance and operation in accordance with its policies and procedures. This manual is called the Aerodrome Operations Manual – AOM.

12.1.2 An amendment to the AOM shall be approved by the Authority prior to becoming effective.

12.2 Preparation of the Aerodrome Operations Manual (AOM)

12.2.1 The aerodrome operations manual shall:

- (a) Be typewritten and printed in English;
- (b) Be in a format that is easy to revise and use;
- (c) Have a system for logging revisions;
- (d) Have the initial approval date and the list of effective pages duly signed to support the revision approvals.
- (e) Have a guarantee from the aerodrome operator, that the AOM and its revisions do not infringe any standards of this regulation.
- (f) Include all revisions and amendments required by the Authority, aimed at ensuring aircraft safety.
- (g) Be organised in a manner that will facilitate the preparation, review and acceptance/approval process by the Authority. It may be structured in one or multiple volumes, whichever is more convenient.
- (h) Some regulatory requirements, such as;
 - (1) SMS Manual;
 - (2) Aerodrome Emergency Plan;
 - (3) Rescue and Firefighting Manual,
 - (4) Training Manual;
 - (5) Preventive and Corrective Maintenance Plan; or
 - (6) Wildlife Hazard Management Plan



may be submitted separately but shall be referenced within the AOM and form part of the AOM.

- (7) The AOM shall comprise all policies and procedures including information and instructions necessary for the Accountable Manager to carry out their duties.

12.3 Contents of the aerodrome operations manual

(See AC 12.3)

12.3.1 The AOM required by this CAR shall contain all the relevant information concerning the aerodrome site, services, operating procedures, equipment, facilities, organisation and management including the SMS.

12.3.2 If a requirement is not included in the AOM because it is not applicable to the aerodrome, the reason shall be indicated in the manual.

Note: Refer to Appendix 1 for guidance on the content of the AOM.

12.4 Amendment and location of the aerodrome operations manual

12.4.1 An aerodrome operator shall:

- (a) Ensure that the AOM is amended so that its instructions and information are current.
- (b) Ensure that the administrative personnel, as well as the Operations, Maintenance and SMS personnel and any person or entity responsible for a manual, receive the approved revisions in a timely manner.
- (c) Keep at least one complete and current copy of the AOM at each Operations, Maintenance and SMS Department.
- (d) Provide the applicable parts or portions of the AOM, or a complete copy, to the aerodrome personnel in charge of its implementation.
- (e) Keep master control of all existing manuals.
- (f) Ensure any holder of the AOM, or any of its parts, is responsible for keeping this document up to date with the amendments provided by the aerodrome operator.

12.5 Aerodrome Operations Manual Review

12.5.1 The Authority may review the AOM:

- (a) At the aerodrome operator's request, who may require to include modifications to the conditions initially approved, related to the aerodrome site, services, operating procedures, equipment, facilities, organisation, aerodrome management or the SMS.
- (b) If a revision is determined to be needed in the interest of safety.

12.5.2 An AOM revision request shall be submitted at least 30 business days prior to the date set for entry into force, unless the Authority approves a shorter period upon request of the applicant.



- 12.5.3 In case of revisions originated by the Authority, the aerodrome operator shall be notified of the reasons for revision and the pages with the proposed revisions shall be included. The aerodrome operator has seven business days to submit in writing his/her viewpoints and arguments on the revision. After evaluating the information, the Authority shall decide whether or not to adopt the revision. The revision shall be effective 30 business days after the aerodrome operator receives it.
- 12.5.4 If the Authority determines the presence of an emergency condition requiring immediate safety action that prevents the implementation of the procedures provided in paragraph 3.5.3, a revision shall be carried out and it shall be effective since the aerodrome operator receives it. The Authority shall briefly describe the emergency in the letter of formal amendment notice. Once the emergency is solved, the aerodrome operator may request the Authority a reevaluation of the elements causing the emergency and the revision required.

12.6 Approval of the Aerodrome Operations Manual

- 12.6.1 For the purposes of AOM approval, or the volumes comprising it, the aerodrome operator shall submit two copies of each to the Authority.
- 12.6.2 The Authority shall approve the AOM or the volumes comprising it, and any revision provided that CAR requirements are met.
- 12.6.3 Once the AOM, or the volumes comprising it, are approved, the Authority shall return a copy to the aerodrome operator and keep a copy of each one in the aerodrome certification file.



This Page Intentionally Left Blank

**CHAPTER 13****OBLIGATIONS OF THE AERODROME OPERATOR****13.1 General**

(See AC 13.1)

13.1.1 The aerodrome operator shall manage, operate and maintain the aerodrome in accordance with the policies and procedures set out in the AOM.

13.1.2 The aerodrome operator shall establish a preventive and corrective maintenance programme that meets the human factors principles to grant that pavement, fencing, drainage systems, buildings and other facilities are kept in such conditions that do not affect safety, regularity or efficiency of air navigation.

13.2 Records

13.2.1 The aerodrome operator shall establish a recording system including at least the following:

- (a) Aerodrome certification records;
- (b) Personnel training records;
- (c) Emergency training records;
- (d) Training records on fuel and hazardous material handling;
- (e) Audit and inspection records;
- (f) People accessing the movement area;
- (g) SMS records;
- (h) Wildlife strike records;
- (i) Records on aerodrome conditions;
- (j) Records on tool and equipment calibration; and
- (k) Incident/accident records.

13.2.2 The records in paragraph 13.2.1 above shall be kept permanently unless the specified regulation establishes a holding period.

13.3 Personnel competence and requirements

(See AC 13.3)

13.3.1 The aerodrome operator shall employ and maintain an adequate number of qualified and skilled personnel to perform all critical activities for aerodrome management, operations, maintenance, aviation security and safety.



- 13.3.2 The aerodrome operator shall submit to the Authority, for its approval, an initial and recurrent training programme in order to maintain the technical competence of personnel responsible for the management, operation and maintenance of the aerodrome, as provided in paragraph 13.3.1 above. The programme shall be included in the AOM.
- 13.3.3 The aerodrome operator shall submit to the Authority, for its approval, key operations and maintenance personnel of the aerodrome:-
- 13.3.4 Any change in the approved management personnel shall be submitted to the Authority for approval.



APPENDIX 1

CONTENTS OF THE AERODROME OPERATIONS MANUAL (AOM)

The AOM shall include the following information applicable to the size, category and complexity of its operations shall be included.

Part 1: General Information

- (a) Purpose and scope of the AOM;
- (b) Legal requirement stating that the AOM and the airport operator comply with all applicable regulations as prescribed in the provisions and conditions of the aerodrome certificate;
- (c) A statement that the AOM includes operating instructions to be met by relevant personnel;
- (d) A statement to indicate that the aerodrome shall at all times, when it is available for the take-off and landing of aircraft, be so available to all persons on equal terms and conditions;
- (e) The system for recording aircraft movement; and
- (f) The available aeronautical information system and procedures for its promulgation and/or notification to the Aeronautical Information Service (AIS);

1.2 Explanations and definitions of terms and words needed to use the AOM.

1.3 Amendment and review system

- (a) A statement of who is responsible for the issuance and disclosure of amendments and revisions.
- (b) A record of amendments and revisions with their corresponding entry and effective dates.
- (c) A statement that no handwritten amendments or revisions are allowed except in situations requiring an immediate amendment or revision in the interest of operational safety.
- (d) A list of effective pages.
- (e) A description of the distribution system of the AOM, amendments and revisions.

Part 2: Organisation

- 2.1 An aerodrome organisational chart showing the names and positions of management personnel.
- 2.2 Functions and responsibilities of management personnel.
- 2.3 Airport committees, including Safety and Facilitation, Fauna, Emergency, and any other committee established by the aerodrome operator to ensure aerodrome safety and operation.

Part 3: Particulars of the Aerodrome Site

General information, including the following:



- (a) A plan of the aerodrome showing the main aerodrome facilities for the operation of the aerodrome including, particularly, the location of each wind direction indicator; lights, markings, signs, access to the aerodrome, perimeter roads, fuel storage, rescue and firefighting installations, ATC facilities and location or road-holding position for rescue and firefighting vehicles in case of emergency and an isolated parking position for an aircraft which is believed to be the subject of unlawful interference.
- (b) A plan of the aerodrome showing the aerodrome boundaries;
- (c) A plan showing the distance of the aerodrome from the nearest city, town or other populous area, and the location of any aerodrome facilities and equipment outside the boundaries of the aerodrome covering a diameter of at least 8 km ;
- (d) Particulars of the title (cadastral plan) of the aerodrome site. If the boundaries of the aerodrome are not defined in the document particulars of the title to, or interest in, the property on which the aerodrome is located and a plan showing the boundaries and position of the aerodrome.

Part 4: Particulars of the aerodrome required to be reported to the Aeronautical Information Service (AIS)

4.1 General information

- (a) The name of the aerodrome;
- (b) The location of the aerodrome;
- (c) The geographical coordinates of the aerodrome reference point determined in terms of the World Geodetic System (WGS-84). The aerodrome reference point shall be located near the initial or planned geometric centre and shall be measured in degrees, minutes and seconds.
- (d) The aerodrome elevation and geoid undulation, with an accuracy rounded to the nearest one-half metre;
- (e) The elevation of each threshold and geoid undulation, the elevation of the runway end and any significant high and low points along the runway, and the highest elevation of the touchdown zone of a precision approach runway shall be measured to the accuracy of one-quarter metre and one-half metre for non-precision approaches.
- (f) The aerodrome reference temperature in degrees Celsius, which shall correspond to the monthly mean of the daily maximum temperatures for the hottest month of the year.
- (g) The details of the aerodrome beacon; and
- (h) The name of the aerodrome operator, address, telephone numbers and e-mail address at which the aerodrome operator may be contacted at all times.

4.2 Aerodrome dimensions and related information.

General information, including the following:

- (a) Runway – true bearing rounded to the nearest hundredth of a degree, designation number, length, width and displaced threshold location to the nearest metre, slope, surface type, type of runway and, for a precision approach runway Category I, the existence of an obstacle free zone:



- (b) Length, width rounded to the nearest metre and surface type of strip, runway end safety areas, stopways;
- (c) Length, width and surface type of taxiways;
- (d) Apron surface type and aircraft stands;
- (e) Clearway length and ground profile;
- (f) Visual aids for approach procedures, marking and lighting of runways, taxiways, and aprons; other visual guidance and control aids on taxiways (including runway holding positions, intermediate holding positions and stop bars) and aprons, location and type of visual docking guidance system; availability of standby power for lighting;
- (g) The location and radio frequency of VOR aerodrome checkpoints;
- (h) The location and designation of standard taxi routes;
- (i) The geographical coordinates of each threshold in degrees, minutes, seconds and hundredths of a second.
- (j) The geographical coordinates of appropriate taxiway centre line points in degrees, minutes, seconds and hundredths of a second.
- (k) The geographical coordinates of each aircraft stand in degrees, minutes, seconds and hundredths of a second.
- (l) The geographical coordinates in degrees, minutes, seconds and hundredths of a second and the top elevation of significant obstacles in the approach and take-off areas, in the circling area and in the vicinity of the aerodrome.

Note: This information may be best shown in the form of charts such as those required for the preparation of aeronautical information publications,

- (m) The pavement surface type and bearing strength in accordance with the standardised procedures of the Aircraft Classification Number – Pavement Classification Number (ACN-PCN) method, noting the following information:
 - (1) the Pavement Classification Number (PCN);
 - (2) pavement type for ACN-PCN determination;
 - (3) subgrade strength category;
 - (4) maximum allowable tyre pressure category or maximum allowable tire pressure value; and
 - (5) evaluation method.
- (n) One or more pre-flight altimeter check locations established on an apron and their average elevation rounded to the nearest metre or foot.
- (o) The following declared distances rounded to the nearest metre:



- (1) take-off run available (TORA);
 - (2) take-off distance available (TODA);
 - (3) accelerate-stop distance available (ASDA); and
 - (4) landing distance available (LDA)
- (p) The condition of the movement area and the operational status of related facilities shall be monitored and reports on matters of operational significance or affecting aircraft performance given, particularly in respect of the following:
- (1) construction or maintenance work;
 - (2) rough or broken surfaces on a runway, a taxiway or an apron;
 - (3) water on a runway, a taxiway or an apron;
 - (4) chemicals or other contaminants on a runway, taxiway or apron;
 - (5) other temporary hazards, including parked aircraft;
 - (6) failure or irregular operation of part or all of the aerodrome visual aids; and
 - (7) failure of the normal or secondary power supply.
- (q) The disabled aircraft removal plan: the telephone/ telex/facsimile numbers and e-mail address of the aerodrome operator for the removal of a disabled aircraft on or adjacent to the movement area, information on the capability to remove a disabled aircraft, expressed in terms of the largest type of aircraft which the aerodrome is equipped to remove;
- (r) The Rescue and firefighting: the level of protection provided, expressed in terms of the category, which shall be in accordance with the type and amounts of extinguishing agents normally available at the aerodrome. Moreover, significant changes to the level of protection, level restoration and in terms of a new category, resulting from variations in availability of extinguishing agents, vehicles, personnel or any other requirement affecting the level of protection.
- (s) The following information concerning a visual approach slope indicator system installation shall be made available:
- (1) associated runway designation number;
 - (2) type of system and, for an AT-VASIS, PAPI or APAPI installation, the side of the runway on which the lights are installed, i.e. left or right, shall be given;
 - (3) where the axis of the system is not parallel to the runway centre line, the angle of displacement and the direction of displacement, i.e. left or right, shall be indicated;
 - (4) nominal approach slope angle(s). For a T-VASIS or an AT-VASIS this shall be angle Θ according to the formula in Figure 5-18 and for a PAPI and an APAPI this shall be angle $(B + C) \div 2$ and $(A + B) \div 2$, respectively as in Figure 5-20; and



- (5) minimum eye height(s) over the threshold of the on-slope signal(s). For a T-VASIS or an AT-VASIS this shall be the lowest height at which only the wing bar(s) are visible; however, the additional heights at which the wing bar(s) plus one, two or three fly-down light units come into view may also be reported if such information would be of benefit to aircraft using the approach. For a PAPI this shall be the setting angle of the third unit from the runway minus 2', i.e. angle B minus 2', and for an APAPI this shall be the setting angle of the unit farther from the runway minus 2', i.e. angle A minus 2'.
- (t) Limitations, by aircraft type, in terms of resistance, runways, taxiways and turns.

Note: The accuracy of the information previously indicated is critical to aircraft safety. Information requiring engineering survey and assessment shall be gathered or verified by qualified technical persons.

Part 5: Particulars of the Aerodrome Operating Procedures and Safety Measures.

5.1 Aerodrome reporting

Particulars of the procedures for reporting any changes to the aerodrome information set out in the AIP and procedures for requesting the issue of NOTAMs, including the following:

- (a) Arrangements for reporting any changes to the Authority and recording the reporting of changes during and outside the normal hours of aerodrome operations;
- (b) The names and roles of persons responsible for notifying the changes, and their telephone numbers during and outside the normal hours of aerodrome operations; and
- (c) The address and telephone numbers, as provided by the Authority, of the place where changes are to be reported to the AIS base stations.

5.2 Access to the aerodrome movement area

Particulars of the procedures that have been developed and are to be followed in coordination with the competent authorities for preventing unauthorised entry of persons, vehicles, equipment, animals or other things into the movement area, including the following:

- (a) The role of the aerodrome operator, the aircraft operator, aerodrome fixed-based operators, the aerodrome security entity, the Authority and other government departments, as applicable;
- (b) The names and roles of the personnel responsible for controlling access to the aerodrome, and the telephone numbers for contacting them during and after working hours;
- (c) Procedures to access the movement area, including: Issue and format of identification cards as well as the training plan, evaluation and consequences of non-compliance.
- (d) Responsibilities, procedures and means for communicating emerging problems of the pilot and the aircraft operator.

5.3 Aerodrome Emergency Plan.

Particulars of the Aerodrome Emergency Plan, including the following:



- (a) Plans for dealing with emergencies occurring at the aerodrome or in its vicinity, including the malfunction of aircraft in flight or on the ground; structural fires, sabotage, including bomb threats (aircraft or structure); unlawful seizure of aircraft or facilities; and accidents or incidents on the airport covering “during the emergency” and “after the emergency” considerations;
- (b) Details of tests for aerodrome facilities and equipment to be used in emergencies, including the frequency of those tests; it shall not exceed two years.
- (c) Details of exercises to test emergency plans, including the frequency of those exercises; it shall not exceed two years.
- (d) A list of organisations, agencies and persons of authority, both on- and off airport, for site roles; their telephone and facsimile numbers, e-mail and SITA addresses and the radio frequencies of their offices as well as any other communication system;
- (e) The establishment of an aerodrome emergency planning committee or similar agreement to organise training and other preparations for dealing with emergencies; and
- (f) The appointment of an on-scene commander to supervise the overall emergency operations.

5.4 Rescue and Firefighting Service

Facilities, equipment, personnel and procedures data to meet the rescue and firefighting requirements; including the names and roles of the persons responsible for dealing with the rescue and firefighting services at the aerodrome, training, exercises and response time demonstration.

Note: This subject shall also be covered in appropriate detail in the aerodrome emergency plan.

5.5 Inspection of the aerodrome movement area and obstacle limitation surface by the aerodrome operator

Particulars of the procedures for the inspection of the aerodrome movement area and obstacle limitation surfaces, including the following:

- (a) Arrangements for carrying out inspections, including runway friction and water-depth measurements on runways and taxiways, during and outside the normal hours of aerodrome operations;
- (b) Arrangements and means of communicating with air traffic control during an inspection;
- (c) Arrangements for keeping an inspection logbook, and the location of the logbook;
- (d) Details of inspection intervals and times;
- (e) Inspection guides and checklists;
- (f) Arrangements for recording and reporting the results of inspections and for taking prompt follow-up actions to ensure correction of unsafe conditions; and
- (g) The names and roles of persons responsible for carrying out inspections, and their telephone numbers during and after working hours.



5.6 Visual aids and aerodrome electrical systems

Particulars of the procedures for the inspection and maintenance of aeronautical lights (including obstacle lighting), signs, markers and aerodrome electrical systems, including the following:

- (a) Arrangements for carrying out inspections during and outside the normal hours of aerodrome operation, and the checklist for such inspections;
- (b) Arrangements for recording the result of inspections and for taking follow-up action to correct deficiencies;
- (c) Arrangements for carrying out routine maintenance and emergency maintenance;
- (d) Arrangements for secondary power supplies, if any, and, if applicable, the particulars or any other method of dealing with partial or total system failure; and
- (e) The names and roles of the persons responsible for the inspection and maintenance of the lighting, and the telephone numbers for contacting those persons during and after working hours.
- (f) Monthly verification of PAPI/VASI light angles and photo cell operation, by the responsible unit.

5.7 Maintenance of the movement area

Particulars of the facilities and procedures for the maintenance of the movement area, including;

- (a) Arrangements for maintaining the paved areas;
- (b) Arrangements for maintaining the unpaved runways and taxiways;
- (c) Arrangements for maintaining the runway and taxiway strips; and
- (d) Arrangements for the maintenance of aerodrome drainage.

5.8 Aerodrome works – Safety

Particulars of the procedures for planning and carrying out construction and maintenance work safely (including work that may have to be carried out at short notice) on or in the vicinity of the movement area which may extend above an obstacle limitation surface, including the following:

- (a) Arrangements for communicating with air traffic control during the progress of such work;
- (b) The names, telephone numbers and role of persons or organisations responsible for planning and carrying out the work, and arrangements for contacting those persons and organisations at all times;
- (c) The names, telephone numbers, during and after working hours, of the aerodrome fixed-base operators, ground handling agents and aircraft operators who are to be notified of the work;
- (d) A distribution list for work plans, if required; and
- (e) Arrangements, procedures and recovery time of major damage to the runway pavement.



5.9 Apron management

Particulars of the apron management procedures, including the following:

- (a) Arrangements between air traffic control and the apron management unit;
- (b) Arrangements for allocating aircraft parking positions;
- (c) Arrangements for initiating engine start and ensuring clearance of aircraft push-back;
- (d) Marshalling service; and
- (e) Leader (van) service.
- (f) Arrangements and procedures on movement/non movement areas, to determine when the control is to be taken by ATS, the aerodrome operator or the aircraft operator in push back operation and taxiing and when it corresponds to the air operator in push back operations and taxiing.

5.10 Apron safety management.

Procedures to ensure apron safety, including:

- (a) Protection from jet blasts;
- (b) Enforcement of safety precautions during aircraft refuelling operations;
- (c) Apron sweeping;
- (d) Apron cleaning;
- (e) Arrangements for reporting incidents and accidents of an apron; and
- (f) Arrangements for auditing the safety compliance of all personnel working on the apron.

5.11 Airside vehicle control

Particulars of the procedures for the control of surface vehicles operating on or in the vicinity of the movement area, including:

- (a) Details of the applicable traffic rules (including speed limits and the means of enforcing the rules);
- (b) The method of issuing driving permits for operating vehicles in the movement area;
- (c) Identification (signalling) procedures and safety equipment; and
- (d) Compliance with the procedures for the total annual vehicle technical inspection and when in doubt, with the operating conditions of vehicles.

5.12 Wildlife hazard management

Particulars of the procedures to deal with the danger posed to aircraft operations by the presence of bird or other animals in the aerodrome flight pattern or movement area, including the following:



- (a) Arrangements for assessing wildlife hazards;
- (b) Arrangements for implementing wildlife control programmes; and
- (c) The names and roles of the persons responsible for dealing with wildlife hazards, and their telephone numbers during and after working hours.

5.13 Obstacle control

Particulars setting out the procedures for:

- (a) Monitoring the obstacle limitation surfaces and Type A Chart for obstacles in the take-off surface;
- (b) Controlling obstacles within the authority of the aerodrome operator;
- (c) Monitoring the height of buildings or structures within the boundaries of the obstacle limitation surfaces;
- (d) Controlling new developments in the vicinity of aerodromes;
- (e) Notifying the Authority of the nature and the location of obstacles and any subsequent addition or removal of obstacles for action as necessary, including amendment of the AIS publication; and
- (f) Evaluating and updating the obstacle letter.

5.14 Removal of disabled aircraft

Particular of the procedures for removing a disabled aircraft on or adjacent to the movement area, including the following:

- (a) The roles of the aerodrome operator and the holder of the aircraft certificate of registration;
- (b) Arrangements for notifying the holder of the certificate of registration;
- (c) Arrangements for liaising with the air traffic control unit;
- (d) Arrangements for obtaining equipment and personnel to remove the disabled aircraft; and
- (e) The names, role and telephone numbers of persons responsible for arranging for the removal of disabled aircraft.

5.15 Handling of hazardous materials

Particulars of the procedures for the safe handling and storage of hazardous materials on the aerodrome, including the following:

- (a) arrangements for special areas on the aerodrome to be set up for the storage of inflammable liquids (including aviation fuels) and any other hazardous materials; and
- (b) the method to be followed for the delivery, storage, dispensing and handling of hazardous materials, including areas for temporary storage of containers and packing with spills.



Note: Hazardous materials include inflammable liquids and solids, explosives, solvents, corrosive liquids, compressed gases and magnetised or radioactive materials. Arrangements for dealing with the accidental spillage of hazardous materials shall be included in the aerodrome emergency plan.

5.16 Reduced-visibility operations

Particulars of procedures to be introduced for low-visibility operations, including the measurement and reporting of runway visual range as and when required, and the names and telephone numbers, during and after working hours, of the persons responsible for measuring the runway visual range.

5.17 Protection of sites for radar and navigational aids

Particulars of the procedures for the protection of sites for radar and radio navigational aids located on the aerodrome to ensure that their performance will not be degraded, including the following:

- (a) arrangements for the control of activities in the vicinity of radar and navigational aids installations;
- (b) arrangements for ground maintenance in the vicinity of these installations; and
- (c) arrangements for the supply and installation of signs, warnings of hazardous microwave radiation.

Note 1: In writing the procedures for each category, clear and precise information shall be included on:

- *When, or in what circumstances, an operating procedure is to be activated;*
- *how an operating procedure is to be activated;*
- *actions to be taken;*
- *the persons who are to carry out the actions; and*
- *the equipment necessary for carrying out the actions, and access to such equipment.*

Note 2: If any of the procedures specified above are not relevant or applicable, the reason shall be given.

Part 6: Aerodrome Safety Management System

- (a) General description of the SMS established for ensuring compliance with all safety requirements provided in CAR SMS;
- (b) The safety policy, insofar as applicable, on the safety management process and its relation to the operational and maintenance process;
- (c) the structure or organisation of the SMS, including staffing and the assignment of individual and group responsibilities for safety issues;
- (d) SMS strategy and planning, such as setting safety performance targets, allocating priorities for implementing safety initiatives and providing a framework for controlling the risks to as low a level as is reasonably practicable keeping always in view the requirements of CAR's, as well as the applicable local regulations, standards, rules or technical guides;



- (e) SMS implementation, including facilities, methods and procedures for the effective communication of safety messages and the enforcement of safety requirements;
- (f) a system for the implementation of, and action on, critical safety areas which require a higher level of safety management integrity (safety measures programme);
- (g) measures for safety promotion and accident prevention and a system for risk control involving analysis and handling of accidents, incidents, complaints, defects, faults, discrepancies and failures, and continuing safety monitoring;
- (h) A system of voluntary notification of events, events or hazards that affect or may affect aeronautical safety
- (i) the internal safety audit and review system detailing the systems and programmes for quality control of safety;
- (j) the system for documenting all safety-related airport facilities as well as airport operational and maintenance records, including information on the design and construction of aircraft pavements and aerodrome lighting. The system shall enable easy retrieval of records including charts;
- (k) staff training and competency, including the review and evaluation of the adequacy of training provided to staff on safety-related duties and of the certification system for testing their competency; and
- (l) The incorporation and enforcement of safety-related clauses in the contracts for construction work at the aerodrome.



This Page Intentionally Left Blank



APPENDIX 2

PAVED AREAS

The following table establishes the minimum friction levels and their correlation with different friction measuring devices.

Friction level classification

	65 kph			95 kph		
	Minimum	Maintenance Planning	New Pavement	Minimum	Maintenance Planning	New Pavement
Mu Meter	.42	.52	.72	.26	.38	.66
Dynatest Consulting, Inc. Runway Friction Tester	.50	.60	.82	.41	.54	.72
Airport Equipment Co. Skiddometer	.50	.60	.82	.34	.47	.74
Airport Surface Friction Tester	.50	.60	.82	.34	.47	.74
Airport Technology USA Safe gate Friction Tester	.50	.60	.82	.34	.47	.74
Findlay, Irvine, Ltd. Griptester Friction Meter	.43	.53	.74	.24	.36	.64
Tatra Friction Tester	.48	.57	.76	.42	.52	.67
Norse meter RUNAR (operated at fixed 16% slip)	.45	.52	.69	.32	.42	.63



This Page Intentionally Left Blank

**APPENDIX 3****VEHICLE OPERATION**

Minimum training and assessment requirements for people who apply for a credential or permit to operate vehicles at the aerodrome.

- (a) Plan contents. The authorities responsible for the operation of vehicles on the movement area shall ensure that the operators are properly qualified. This may include, as appropriate to the driver's function, knowledge of:
- (1) Identification of runways, taxiways, parking areas and NAVAIDs.
 - (2) Distinction between movement areas and non-movement areas.
 - (3) Airport rules and procedures.
 - (4) Identification of aerodrome signs and markings.
 - (5) Identification of lights.
 - (6) Description and location of NAVAIDs critical areas.
 - (7) Regulations of Air Traffic Services in regards to ground operations and authorisations.
 - (8) Identification and sources of rules governing the operation of vehicles.
 - (9) Basic communication system.
 - (10) Aeronautical terms and phrases.
 - (11) Communication procedures (radiotelephony).
 - (12) Use of ICAO spelling alphabet.
 - (13) Description of communication procedures when radio fails.
 - (14) Description of consequences for non-compliance with operational requirements.
- (b) Practical assessment for applicants:
- The operator shall be able to demonstrate competency, as appropriate, in:
- (1) the operation or use of vehicle transmit/receive equipment;
 - (2) understanding and complying with air traffic control;
 - (3) vehicle navigation on the aerodrome;
 - (4) special skills required for the particular function; and
- (c) As required for any specialist function, the operator shall be the holder of a Bahamas driving licence.



This Page Intentionally Left Blank



SECTION 2

ADVISORY CIRCULARS (AC)

1. General

This section 2 contains Advisory Circulars (AC), which is additional text related to the CAR requirements to clarify and provide guidance for its application. It contains explanations, interpretations and/or acceptable means of compliance.

Where a particular paragraph does not have AC, it means that such paragraph does not require it.

2. Presentation

The numbering proceeded by the acronym AC indicates the paragraph number of CAR AGA 1 they refer to.



This Page Intentionally Left Blank



CHAPTER 1

GENERAL

AC 1.1 Applicability

(See AGA 1 para 1.1)

When Certificate is granted to an aerodrome, for aircraft operators and other organisations operating on it, it means that at the time of certification of the aerodrome complied with the standards relating to the facilities and their operation and the operator has in agreement with the Authority, the ability to continue to meet those specifications during the validity of the certificate.

The certification process also establishes the benchmark for continuous monitoring of compliance with specifications.

It is necessary to provide to the Aeronautical Information Services, relevant information on the status of certification of aerodromes to be promulgated in the Aeronautical Information Publication (AIP). See CAR AIS.

AC 1.5.3(c) Runway Safety Team

(See AGA 1 para 1.5.3(c))

Runway Safety Programme

The aerodrome operator shall establish a safety plan on the runway for the prevention of incursions, excursions and any other safety related event. Through this programme a Runway Safety Team (RST) must be established at each of the international airports. The programme must take into account the following participants:

- a) The Airport Operator
- b) Air traffic services
- c) Aircraft Operators SMS representative
- d) State SSP representative
- e) Pilots
- f) Any other group involved in the operations of the aerodrome

Functions of the Runway Safety Team

The main functions of the RST shall be:

- Develop action plans for runway safety
- Identify the potential hazards of runway incursions and excursions
- Recommend strategies to eliminate hazards and mitigate individual risks
- Any other safety hazards considered to be hazardous.

Frequency of RST meetings

The work team shall meet regularly at least every three months

AC 1.5.4 Service Level Agreements

(See AGA 1 para 1.5.4)

This AC is an alternative means of compliance on how Service Level Agreements may be established.

Memorandum of Understanding between the Airport Operator ----- and -----.



APPLICABILITY

An aeronautical study may be conducted when the aerodrome standards may not be complied with, as a result of development or expansion. Such study is often conducted during the planning process of a new aerodrome or during the certificate of an existing one.

Note: Aeronautical studies may not be conducted in case of deviations with respect to the standards if there are reasonably practicable solutions.

DEFINITION

An aeronautical study is an investigation of an aviation problem aimed at identifying possible solutions and selecting the most acceptable one so that it does not affect flight safety.

TECHNICAL ANALYSIS

The technical analysis shall provide justification for a deviation on the basis that an equivalent level of safety may be achieved by other means. It is generally applied in situations where the cost of correcting a problem that infringes standard results excessive, but where the unsafe effects of the problem may be overcome by any procedural means offering practical and reasonable solutions.

In technical analysis, inspectors shall apply their field experience and expertise. They may also consult other specialists in relevant areas. When considering alternative procedures in the deviation approval process, it is essential to take into account the safety purpose of the aerodrome certification regulations and the applicable standards so that the purpose of the regulations is maintained.

DEVIATION ACCEPTANCE

In some cases, the only reasonable means of providing an equivalent level of safety is to adopt adequate procedures and demand, as a condition for certification, that caution notices be published in appropriate AIS publications.

The decision of demanding caution notices shall depend mainly on two considerations:

- a) The pilots' need of being aware of the possible dangerous conditions; and
- b) The responsibility of the Authority to publish deviations with respect to the standards, which otherwise are assumed to be met under the aerodrome certification.

STRUCTURE OF THE AERONAUTICAL STUDY

The minimum contents required in an aeronautical study shall be the following:

Section 1. General

- a) Title page of the study
- b) Name and signature of the person in charge of the study
- c) General index
- d) Objective
- e) Scope

Section 2. Risk analysis

- a) Description of the deviation by indicating the difference with respect to the standards specified in the CAR AGA 1.



Section 3. Identification of unwanted events

a) Estimate the probability of an incident or an accident related to deviations similar to those under analysis. The probability shall be classified as:	b) Description of the consequences magnitude of incidents or accidents occurrence. The magnitude of the consequences is classified as:
•Frequent	•Catastrophic
•Occasional	•Dangerous
•Remote	•Major
•Unlikely	•Minor
•Extremely unlikely	•Insignificant

Section 4. Mitigation measures

- a) Description of the mitigation measures applied to eliminate or reduce as much as possible the detected risks.

Section 5. Results

- a) Description of the results derived from the implementation of mitigation measures, including the necessary documentation to support such results.
- b) Comparison of results obtained with respect to standards specified in CAR AGA 1.
- c) Conclusions.

Section 6. Annexes

All documents (procedures, analysis, reports, records, photographs, maps, tables, graphics, etc.) and any supporting information needed for the aeronautical study shall be included.



CHAPTER 11

CERTIFICATION PROCESS

AC 11.1 Certification Process

(See AGA 1 para 11.1)

To obtain an aerodrome certificate, the applicant must undergo a certification process, which is formally recorded in an aerodrome certification file by the Authority. This process consists of the following stages:

Stage 1 - Pre-application

This is the process where the applicant expresses an interest in obtaining an aerodrome certificate and obtains the information required relating to the granting of an aerodrome certificate. During this stage, the first meeting between the applicant and the Authority takes place, where there is an information exchange on service and guidance in regards to the regulations, standards, procedures, responsibilities and privileges of the service that the applicant intends to provide, and the technical documentation to be submitted.

Stage 2 - Formal Application

The applicant shall submit the a formal application to the Authority attaching the schedule of events for the certification process, the Aerodrome Operations Manual (AOM) required by Chapter 12, the Aerodrome Security Programme required by CAR SEC and the SMS of the aerodrome required by CAR SMS.

Stage 3 – Evaluation

The Authority conducts a thorough review of the documentation submitted and informs the applicant of any discrepancies found; otherwise, provisional approval/acceptance is issued.

Stage 4 - Technical Evaluation

The applicant is subjected to a technical demonstration and evaluation to determine compliance with the facilities with respect to signals, lighting, markings, pavements, obstacles, rescue and firefighting services, equipment, personnel, procedures, SMS, apron management, wildlife strike hazard and training.

Stage 5 – Certification

Once stages 1 to 4 have been successfully completed, the Authority shall grant the aerodrome certificate with any conditions established for promulgation in the Bahamas AIP.

AC 11.1.6 Key Personnel

(See AGA 1 para 11.1.6)

The Aerodrome Operator must make all reasonable attempts to employ qualified, experienced personnel into the key roles. If this is not practicable, then with the acceptance of the Authority, the Aerodrome Operator may recruit non-qualified suitable personnel with a view to implementing a training and development programme to get the individual to an acceptable level of competence.

The aerodrome operator must submit to the Authority, for its approval, key operations and maintenance personnel of the aerodrome-

a) Operations:

- 1) Higher education in engineering or aerodrome administration, or an aviation technician licence or any other career related to aerodrome operations.
- 2) A minimum of five years of experience in aerodrome management.

b) Maintenance:

- 1) Higher education in civil, mechanical, or electric engineering, construction or architecture or a qualified technician with proven experience subjected to Authority approval.



- 2) Aerodrome specialised courses.
 - 3) Three years of proven experience in positions related to supervision and inspection of the movement area or two years subject to a training plan proposed by the aerodrome operator and approved by the Authority.
- c) Safety Management
- 1) Qualified technician with proven knowledge and experience in SMS.
 - 2) A minimum of three years of proven experience in quality systems or aerodrome SMS.

Any change in the authorised key personnel payroll, must be submitted to the Authority for approval.

AC 11.2 Grant of an aerodrome certificate

(See AGA 1 Para 11.2)

Contents of an aerodrome manual, including procedures for its submission and approval/acceptance, verification of compliance and granting of an aerodrome certificate, are available in the PANS-Aerodromes (Doc 9981).

The intent of a safety management system is to have in place an organised and orderly approach in the management of aerodrome safety by the aerodrome operator. CAR SMS Safety Management Systems contains the safety management provisions applicable to certified aerodromes.

Guidance on a harmonized safety management system is given in the Safety Management Manual (SMM) (Doc 9859) and in the Manual on Certification of Aerodromes (Doc 9774). Procedures on the management of change, conduct of safety assessment, reporting and analyses of safety occurrences at aerodromes and continuous monitoring to enforce compliance with applicable specifications so that identified risks are mitigated can be found in the PANS-Aerodromes (Doc 9981).



CHAPTER 12

AIRPORT OPERATIONS MANUAL (AOM)

AC 12.1 Preparation of the Aerodrome Operations Manual (AOM)

(See AGA 1 para 3.1)

One of the most important reasons for the existence of the AOM is that it serves as an extension of the regulations. CAR AGA 1 provides information in broad terms to cover all aerodromes and it may not appear in a specific level for each airport. The AOM becomes a bridge between the requirements and the individual application for an aerodrome taking into account size, activities and configuration.

In the development of the AOM, two fundamental principles shall be observed:

- a) **Be comprehensive.** It shall include all requirements applicable to the aerodrome, so that personnel operating in the aerodrome have the necessary information to comply with the regulations. Even quotes or references to regulations, may be included.
- b) **Be moderate.** It shall be created with the level of detail necessary to show how to achieve compliance with regulations in the aerodrome. Excessive details that may restrict the flexibility to meet unforeseen circumstances or the creation of commitments not stated in regulations in terms of responsibility, authority and procedures shall be avoided.

There are two relevant levels of approval in the regulations: the approval or compliance statement by the aerodrome operator or the applicant of an aerodrome certificate before submitting it to the Authority, and Authority's approval.

The highest authority within the structure of the Airport Operator, on behalf of the company it represents, shall establish a statement or approval that the manual complies and that the operator shall meet all applicable rules as well as the provisions and conditions of the aerodrome certificate in a note or letter. The note or representation letter shall identify the aerodrome, the person signing the document and the date. This approval may be issued in the front page or the first page of the manual.

Once the AOM is approved, it becomes an authorised document. Therefore, the Authority shall issue an initial approval note of the Airport Operations Manual (AOM) and also indicate its approval with the full name, date and signature of the designated inspector, at the end of each sheet of the effective pages of the manual.

To comply with regulatory requirements, the airport operator shall foresee that the policies and procedures of the AOM respond to these questions. A realistic and objective AOM is the one that provides guidelines and instructions necessary for another person to develop its activities while the airport operator is absent. When the person is reading the instructions, these shall indicate who is performing the tasks, what they consist of, how they shall be conducted and the schedules or periods to perform them.

Two aspects require debate. There is a person who normally operates far away under a relative autonomy, not beyond the authority, but with some physical or functional distance. This is called *independent* person for convenience. The key element is that this person can make decisions to deal with abrupt changes in situations without direct supervision, even if the airport operator is located anywhere in the aerodrome. The other person is the *substitute*, who intervenes and performs certain tasks to meet the regulations when the usual chain of authority and responsibility has been temporarily interrupted. This person is essentially an aid and may or may not be completely familiarised with the normal routine. The AOM shall provide enough guidance to perform functions as well as the course and instructions to request support when problems arise.

As it was previously indicated, this person is not entirely independent on authority or action, but certain relevant actions may be carried out without the participation of the airport operator or the normal procedure of application and approval. Therefore, the airport operator must be sure that the person knows what is required from the regulation point of view, how to apply his/her knowledge in adverse situations as well as to conduct routine work, which may be accomplished by firm and clear instructions in the AOM. Rescue and firefighting services represent a good example. In the rescue and firefighting station, events requiring immediate attention may arise and they may have consequences somewhere else or for other people. For example, if a piece of equipment is not working, administrative action must be taken to restrict air operations or, at least, notify the airport operators. In case of an emergency, it is necessary to decide whether to activate the emergency plan or just part of it. Do the rescue and firefighting personnel know how to make these decisions? Do they have clear and concise information for the correct approach? Of course, it must be clear who the person in charge of giving instructions is.



It is important to keep in mind who may take action if the airport operator or the nominated person is absent. Taking daily inspections as an example, if a person knows the airport operations, but he/she does not know the specific regulations, it may be unnecessary to give instructions from scratch. However, the person usually does not perform those functions. Therefore, the AOM shall be specific enough on critical aspects of the operation, so that the aerodrome takes its normal course.

Nevertheless, if the airport operator is not in the facilities, there shall be another person to perform the tasks instead of the appointed person. If the person in charge of checking the lighting system is off, the substitute must know how to check the system and where the switches are. In other words, an instruction in the AOM stating, "The lighting system must be checked to meet the requirements" is not enough.

The instructions in the AOM shall detail what tasks must be conducted and how they shall be carried out by people responsible for its compliance. Unless every person designated for a task is completely familiar with the regulation requirements, the AOM must be structured so that it provides the appropriate guidance. For example, it may be confusing if the AOM states, "*The security areas must be kept according to the regulations*". Unless the personnel knows the regulations, a better description shall provide details identifying the physical limits, the revision periods and how to keep the surfaces of the safety and security areas.

The best instructions will not produce satisfactory results if they do not indicate when they shall be put into practice. Is the instruction "*The personnel shall conduct refuelling inspections every day*" specific enough? Can a person take action if the AOM indicates "*When the weather conditions allow it*"? Closely related questions like who, what, how and when may arise from these indications and the AOM instructions shall provide enough information to answer them.

AC 12.3 Airport Operations Manual (AOM) Compliance Letter
(See AGA 1 para 12.3)

The Airport Operator shows that it fully complies with the standards established in these regulations through a compliance letter. There shall be a policy or procedure for each standard in the Manual system taking into account the complexity and size of the operations.



CHAPTER 13

OBLIGATIONS OF THE AERODROME OPERATOR

AC 13.1 General

(See AGA 1 para 13.1)

- a) Preventive maintenance is programmed maintenance work done in order to prevent a failure or degradation of facilities.
- b) "Facilities" are intended to include such items as pavements, visual aids, fencing, drainage systems, electrical systems and buildings.
- c) Guidance material on Human Factors principles can be found in the Human Factors Training Manual (Doc 9683) and in the Airport Services Manual (Doc 9137), Part 8.

AC 13.3 Personnel competence

(See AGA 1 para 13.3)

Personnel responsible of the administration, operations and maintenance of the aerodrome shall be trained to a level according to the tasks to be performed; therefore, the programme contents of the initial and recurring training of the airport operator shall be based on the policy and procedures stated and approved by the Authority in the Airport Operations Manual (AOM). These shall include at least the following:

a) Initial training

- (1) Training in airport operations.
- (2) Training in standards and security of fuel storage and handling in the aerodrome.
- (3) Training in the inspection system including familiarisation with the aerodrome, emergency plan, NOTAMs, vehicle operation and discrepancy report system.
- (4) Rescue and firefighting training
- (5) Training in regulations, standards and AOM
- (6) Introduction to the investigation of aviation accidents and incidents
- (7) Maintenance of visual and electronic aids and pavements
- (8) Human factors in civil aviation (ICAO Doc. 9683)
- (9) Dangerous goods training, based on CAR DG
- (10) Bird and other animals control (ICAO IBIS Doc 9332)
- (11) Operational Security Management System
- (12) Quality System

b) Recurring training

- 1) Every two years, (a) (2), (4), (5) and (9) courses shall be given to the appropriate personnel.
- 2) Every year, the training indicated in (a) (3) shall be conducted for the inspection personnel.
- 3) Instruction not indicated in the previous paragraphs shall be given in periods not exceeding 5 years.

c) Training files

Training files of the Airport Operator shall indicate the amount of formal training, on the job training (OJT) and the experience that each employee has accumulated over the years.

**d) Planning and design**

The planning and design stage establishes the basis to define the instruction specifications such as the intermediate and final objectives, expected results, group to be trained, training course contents and specifications, which allow the further development of a training programme.

This stage includes:

- planning and design actions that require to be executed to fill the gap between the current competence and the required competence, and
- definition of the criteria to establish the job performance standards and the performance requirements as well as the evaluation criteria of the instruction process and the subsequent objectives for each course.

The training programme shall be created taking into account the human factors for its implementation. Moreover, it shall consider the depth of each course or subject depending on the responsibilities of the personnel to be trained.

Usually, human resources management is in charge of the administration of resources needed for the correct compliance with the different instruction methods, required teaching materials, activity design, hiring of external instructors, training for internal instructors and their availability, transport to contracted training centres/factories or providers of the different products and services.

However, the highest authority within the Airport Operator is responsible for the approval of any method used for instruction (regardless of whether the instruction is contracted from a third party), as well as for the contents of the training programmes. This may require that contents and evaluation systems of the different courses are audited.

This audit or revision of the training programme by the operator shall be conducted in order to detect non-compliance problems, and eventually, corrective actions.

Data collection shall be performed continuously to provide the basis for the instructional process validation and offer the necessary recommendations to improve it.

The Director General, in exercise of the powers conferred by Section 17(1) of the Civil Aviation Authority Bahamas Act, 2021 (*No. 2 of 2021*) hereby issues the forgoing regulation.

Issued the 25th day of March 2021

A handwritten signature in blue ink, consisting of a stylized 'A' followed by a long horizontal stroke.

**DIRECTOR GENERAL
CIVIL AVIATION AUTHORITY BAHAMAS**