



Cardale Garage Door Range Price List and Technical Information 2017/v2

Welcome to Cardale Garage Doors

Welcome to our 2017/18 garage door price list, containing an inspirational range of high quality doors.

Cardale is British owned and we have been manufacturing garage doors for over fifty years. We are sure you'll find exactly the right door for your home amongst Cardale's range - no one offers more choice!

These doors represent the best, not only in looks, but also in terms of safety, security and durability. We at Cardale have no doubt that, in years to come, you will still be as happy with your Cardale door as the day it is installed.

Factory finished steel fixing frame

Cardale Up & Over garage doors are supplied with an optional pre-hung factory finished steel fixing frame, which makes installation simple and eliminates the need for a timber frame.

Frames are supplied as standard in white, colour matched frames are also available.

The Rosewood chassis frame is supplied in Cherry, Golden Oak chassis frame is RAL8003.

Where to buy

visit www.cardale.co.uk

Cardale doors are available through a network of garage door specialists who will be able to provide full details and prices for our range.

Visit www.cardale.co.uk or call 01582 563777 for details of your nearest distributor.

Contents

Steel up and over doors	4-8
Secured by Design doors.....	9
Golden Oak and Rosewood doors	10-13
Timber Futura doors	14-17
Timber Heritage doors	18-21
Side Hinged doors.....	22-25
GRP doors	26-27
GRP side hinged doors	28
ABS doors	29
Personnel doors	30
Steeline roller doors	30
Thermaglide roller doors	31
Sectional doors	32-35
Technical information	36-42
Warranty and maintenance	43

General information

Information for all doors

All products are sold subject to our standard conditions of sale, which are available on request and include the following:

Prices

All orders are accepted on the understanding that the goods will be subject to the prices ruling at the time of delivery, unless other terms are specifically agreed. All prices are in £ sterling and exclude carriage and VAT.

Panel Configurations

The proportions of the door's panel configurations may vary according to the actual size specified.

Lock Handle Position

Lock handle position varies according to the design and the lifting gear type. Lock holes are supplied as standard on up & over, side hinged and Steeline Roller doors unless specified at the time of order.

Timber doors

The Company accepts no liability for natural variations in colour, warping, swelling or shrinkage due to ordinary natural processes of ageing, fading or the effects of weather or climate or shrinkage, warping or swelling which could have been prevented by carrying out finishing and maintenance as recommended by the Company.

All doors in the Futura and Heritage ranges are supplied with a two coat factory base coat stain treatment. These doors should be finished with a micro-porous stain, front and back, in accordance with the stain manufacturer's instructions immediately after fitting.

GRP doors

GRP by definition, is manufactured from translucent strands of glass. This characteristic may occasionally show itself in translucency of the panel under bright external conditions when viewed from inside with the door closed, but this does not represent a defect in the construction or strength of the door.

Side hinged doors and Personnel doors

All doors will be supplied with locking and lock holes unless specified otherwise on order.

Thermaglide roller doors

Due to manufacturing processes the bottom lath and guides may vary in colour from the rest of the door. Your door will be Made to Measure to suit the dimensions given.

Care and maintenance, all doors

Periodically clean the door panel using warm water and a soft cloth or sponge before allowing to dry naturally. Never use detergent, abrasive, caustic or solvent based cleaners as they may damage the door surface.

Bespoke made to order doors

Steel door prices in bold shown on pages 4 and 5 are stock doors on a standard lead time in white. All other sizes are made to measure.

Delivery charges, all doors

Delivery charges per door: 1 Door = £58.00 NETT. 2 Doors = £48.00 (each door) NETT. 3 Doors + = *free of charge Mainland England, Scotland and Wales only*. Northern Ireland, Channel Islands, Isle of Man, and export delivery - charges on application. Carriage charges and VAT to be added to all prices. *Additional charges may be applied to remote rural locations - please contact for details.

Product appearance

Garage doors should be inspected upon delivery and viewed in natural daylight (not direct sunlight) from a standard distance of 3 metres to view their overall appearance. From this distance the door panel should appear free from visible marks or distortion, stains, blemishes, indentations or scuffs.

Made to measure doors

Doors can be ordered in 1/2" increments.

Door diagrams

Single door diagrams shown depict 7'0" x 7'0" doors. Double door diagrams shown depict 14'0" x 7'0" doors

Specification

The Company reserves the right to make any alterations in design or manufacture without notification as is deemed necessary to ensure continual product development.

Prior to fitting they must not be stored in direct sunlight or exposed to splashes or rain as colour fading and staining may occur respectively. Fully finished timber doors should be re-stained approximately every four years, regular inspections should be carried out and this period reduced as necessary.

Please note that timber is a beautiful material with naturally occurring colour and grain variations. Please tell us if you require matching pairs as we will do our best to match both doors.

Please note that our GRP doors are handcrafted. This may result in shade variations. Please tell us if you require doors to match and we will do our best to achieve as close a door match as possible.

Bird droppings should be removed immediately as these can be particularly caustic.

All doors should be operated and maintained in line with manufacturer's instructions - see operating and maintenance instructions supplied with your door. For further copies visit www.cardale.com.

The designs & sizes detailed in this brochure are an indication of price for the design & size required. Your right to cancel is not available on non-standard made to order doors.



Storage

Garage doors should be stored in their original packaging stood upright on flat ground. Avoid placing on stony or uneven surfaces. Doors should always be lifted and not dragged into place. Do not rest doors against each other without first placing protective packaging in between. Install as soon as possible once the goods have arrived on site.

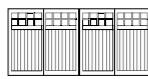
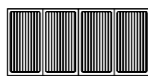
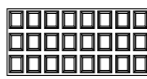
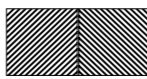

Powder coated pre-finished steel doors

double doors

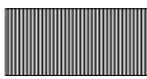
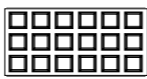
Double doors Pre-finished white							
Size mm (ft/in) Width by Height	Bedford R	Berkeley Vertical R	Brompton R	Chevron R	Europa II R	Gemini R	Georgian R
3200 x 1981 [10'6" x 6'6"]	1529	1285	1454	-	1296	1359	1529
3200 x 2134 [10'6" x 7'0"]	1553	1242	1478	-	1312	1378	1553
3353 x 1981 [11'0" x 6'6"]	1577	1262	1502	-	1324	1390	1577
3353 x 2134 [11'0" x 7'0"]	1604	1284	1525	-	1343	1409	1604
3505 x 1981 [11'6" x 6'6"]	1627	1302	1550	-	1366	1434	1627
3505 x 2134 [11'6" x 7'0"]	1653	1322	1573	-	1384	1453	1653
3658 x 1981 [12'0" x 6'6"]	1678	1342	1596	-	1401	1468	1678
3658 x 2134 [12'0" x 7'0"]	1702	1362	1620	-	1420	1488	1702
3810 x 1981 [12'6" x 6'6"]	1728	1382	1645	-	1437	1508	1728
3810 x 2134 [12'6" x 7'0"]	1752	1401	1667	-	1456	1527	1752
3962 x 1981 [13'0" x 6'6"]	-	1643	1804	-	1473	1545	1873
3962 x 2134 [13'0" x 7'0"]	-	1643	1825	-	1491	1565	1897
4115 x 1981 [13'6" x 6'6"]	-	1643	1804	-	1509	1583	1873
4115 x 2134 [13'6" x 7'0"]	-	1643	1825	-	1527	1603	1897
4267 x 1981 [14'0" x 6'6"]	2053	1643	1597	2150	1371	1371	1753
4267 x 2134 [14'0" x 7'0"]	2053	1643	1597	2150	1401	1401	1753
4420 x 1981 [14'6" x 6'6"]	2156	1929	1734	-	1556	1633	1909
4420 x 2134 [14'6" x 7'0"]	2156	1929	1734	-	1574	1651	1935
4572 x 1981 [15'0" x 6'6"]	2259	1978	1935	-	1592	1670	1935
4572 x 2134 [15'0" x 7'0"]	2259	1978	1959	-	1610	1690	1959
4877 x 1981 [16'0" x 6'6"]	2465	2059	2237	-	1627	1708	2237
4877 x 2134 [16'0" x 7'0"]	2465	2059	2261	-	1646	1727	2261

R = Retractable gear.

Steel up and over double doors - options

Flush lock handle (Gemini and Europa only)	add £42
Standard frame (Pre-finished or white painted)	add £167
Coloured frame	add £313 (Coloured paint)
Cardale DC650T operator	add £444
Cardale DC800T operator	add £575
Glazing (Bedford)	add £279 (Stippled) Black mock glazing standard
Glazing (Brompton)	add £584
Glazing (Georgian)	add £584
Painted door	add £110 (White) add £162 (Colours)

Frames ordered with a double door will be supplied as a separate knocked down item.

All steel double doors are bespoke and made to order.



Colours available:

RAL9016	White
RAL7038	Ageta Grey
RAL7016	Anthracite Grey
RAL6005	Balmoral Green
RAL8017	Conker Brown
RAL9011	Graphite Black
RAL9004	Signal Black
RAL9005	Ebony Black
RAL7035	Light Grey
RAL5013	Oxford Blue
RAL5011	Midnight Blue
RAL3003	Monarch Red
RAL3009	Oxide Red
RAL8003	Signal Brown
RAL7004	Signal Grey
RAL5024	Pastel Blue
RAL6009	Fir Green
RAL6013	Reed Green
BS4800-14C35	Chartwell Green
BS4800-12B17	Willow Green
BS381-420	Dark Camouflage Desert Sand
BS381-389	Camouflage Beige
Cherry	

Powder coated pre-finished steel doors

double doors

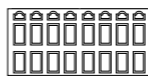
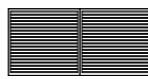
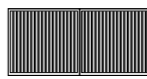
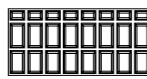
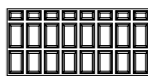
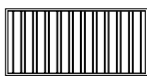
Double doors Pre-finished white						
Size mm (ft/in) Width by Height	Olympian R	Orion Horizontal R	Orion Vertical R	Sheraton II R	Sheraton II glazed R	Vogue R
3200 x 1981 [10'6" x 6'6"]	1734	1529	1576	1529	1964	1572
3200 x 2134 [10'6" x 7'0"]	1766	1553	1601	1553	1989	1604
3353 x 1981 [11'0" x 6'6"]	1800	1577	1625	1577	2013	1752
3353 x 2134 [11'0" x 7'0"]	1832	1604	1651	1604	2039	1784
3505 x 1981 [11'6" x 6'6"]	1882	1627	1671	1627	2063	1796
3505 x 2134 [11'6" x 7'0"]	1913	1653	1700	1653	2088	1827
3658 x 1981 [12'0" x 6'6"]	1964	1678	1726	1678	2114	1840
3658 x 2134 [12'0" x 7'0"]	1995	1702	1750	1702	2138	1872
3810 x 1981 [12'6" x 6'6"]	2074	1728	1776	1728	2163	1897
3810 x 2134 [12'6" x 7'0"]	2105	1752	1800	1752	2188	1927
3962 x 1981 [13'0" x 6'6"]	2184	1873	1921	1873	2309	1955
3962 x 2134 [13'0" x 7'0"]	2214	1897	1945	1897	2333	1986
4115 x 1981 [13'6" x 6'6"]	2254	1873	1921	1873	2309	2069
4115 x 2134 [13'6" x 7'0"]	2284	1897	1945	1897	2333	2100
4267 x 1981 [14'0" x 6'6"]	2141	2053	2053	1597	2033	1794
4267 x 2134 [14'0" x 7'0"]	2172	2053	2053	1597	2033	1825
4420 x 1981 [14'6" x 6'6"]	2439	1734	1782	1734	2170	2185
4420 x 2134 [14'6" x 7'0"]	2470	1734	1782	1734	2170	2215
4572 x 1981 [15'0" x 6'6"]	2592	1935	1982	1935	2370	2233
4572 x 2134 [15'0" x 7'0"]	2622	1959	2007	1959	2395	2265
4877 x 1981 [16'0" x 6'6"]	2745	2237	2285	2237	2673	2465
4877 x 2134 [16'0" x 7'0"]	2776	2261	2309	2261	2697	2495

Optional extras for operators

Extra handsets	add £67 (2 channel) add £73 (4 channel)
Wireless key pad	add £183
External manual override	add £42
Keypad	add £45

Steel doors including windows.







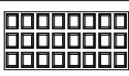

The standard colour window frame for white coloured doors is white. For non-white coloured doors and for Rosewood and Golden Oak laminated doors the window frame colour will be black. Colour matched window frames are available but must be specified at time of order.

Colour matched window frames (except Bedford)	add £30 per window
Colour matched window frames for Bedford	add £234 per door

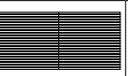
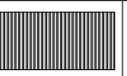
Frames ordered with a double door will be supplied as a separate knocked down item.

Powder coated pre-finished steel doors

made to measure double doors

Made to measure double doors Pre-finished white									
	Brompton	Berkeley Vertical	Europa II	Gemini	Georgian	Olympian	Sheraton II	Sheraton II glazed	Vogue
Width (up to) mm [ft/in] Width by Height	R	R	R	R	R	R	R	R	R
3200 [10'6"]	1888	1975	1590	1550	1888	1888	1888	2324	1734
3353 [11'0"]	1953	2030	1666	1578	1953	1953	1953	2388	1906
3505 [11'6"]	2030	2095	1734	1620	2030	2030	2030	2466	1947
3658 [12'0"]	2108	2162	1802	1656	2108	2108	2108	2544	1991
3810 [12'6"]	2212	2250	1852	1692	2212	2212	2212	2648	2045
3962 [13'0"]	2317	2340	1902	1728	2317	2317	2317	2753	2098
4267 [14'0"]	2465	2466	1953	1815	2465	2465	2465	2900	1945
4572 [15'0"]	2705	2670	2161	1845	2705	2705	2705	3141	2364
4877 [16'0"]	2852	2794	2161	1882	2852	2852	2852	3288	2584

Size availability (mm)

Minimum width	2439	2439	2439	2439	2439	2439	2439	2439	2439
Maximum width	4877	4877	4267	4877	4877	4877	4877	4877	4877
Minimum height	1880	1880	1880	1880	1930	1880	1880	1880	1880
Maximum height	2286	2286	2286	2286	2134	2134	2134	2134	2286

R = Retractable gear.

Steel up and over double doors - options

Flush lock handle (Gemini and Europa only)	add £42
Standard frame (Pre-finished or white painted)	add £169
Coloured frame	add £313 (Coloured paint)
Cardale DC650T operator	add £444
Cardale DC800T operator	add £575
Glazing (Bedford)	add £279 (Stippled) Black mock glazing standard
Glazing (Brompton)	add £584
Glazing (Georgian)	add £584
Painted door	add £110 (White) add £162 (Colours)

All steel double doors are bespoke and made to order.

NEW Colours

Colours available:

RAL9016	White
RAL7038	Ageta Grey
RAL7016	Anthracite Grey
RAL6005	Balmoral Green
RAL8017	Conker Brown
RAL9011	Graphite Black
RAL9004	Signal Black
RAL9005	Ebony Black
RAL7035	Light Grey
RAL5013	Oxford Blue
RAL5011	Midnight Blue
RAL3003	Monarch Red
RAL3009	Oxide Red
RAL8003	Signal Brown
RAL7004	Signal Grey
RAL5024	Pastel Blue
RAL6009	Fir Green
RAL6013	Reed Green
BS4800-14C35	Chartwell Green
BS4800-12B17	Willow Green
BS381-420	Dark Camouflage Desert Sand
BS381-389	Camouflage Beige
Cherry	

Optional extras for operators

Extra handsets	add £67 (2 channel) add £73 (4 channel)
Wireless key pad	add £183
External manual override	add £42
Keyswitch	add £45

Steel doors including windows.









The standard colour window frame for white coloured doors is white. For non-white coloured doors and for Rosewood and Golden Oak laminated doors the window frame colour will be black. Colour matched window frames are available but must be specified at time of order.

Colour matched window frames (except Bedford)	add £30 per window
Colour matched window frames for Bedford	add £234 per door

Frames ordered with a double door will be supplied as a separate knocked down item.

Secured by Design doors

single doors

Single doors Pre-finished white	Steel doors					Timber Futura doors			
									
Size mm [ft/in] Width by Height	R	R	R	R	R	R	R	R	
1984 x 1830 6'6" x 6'0"	1004	1059	-	-	-	2486	2431	2380	
1984 x 1905 6'6" x 6'3"	1004	1059	-	-	-	2486	2431	2380	
1984 x 1930 6'6" x 6'4"	1004	1059	1213	1430	-	2486	2431	2380	
1981 x 1981 6'6" x 6'6"	974	1028	1181	1398	-	2486	2431	2380	
2085 x 1930 6'10" x 6'4"	986	1028	1181	1398	-	2486	2431	2380	
2085 x 1981 6'10" x 6'6"	1000	1028	1181	1398	-	2486	2431	2380	
2085 x 2134 6'10" x 7'0"	1019	1040	1191	1409	-	2486	2431	2380	
2083 x 2210 6'10" x 7'3"	1171	1196	1372	1589	-	2486	2431	2380	
2083 x 2286 6'10" x 7'6"	1265	1375	1481	1698	-	2486	2431	2380	
2134 x 1830 7'0" x 6'0"	1020	1075	1227	1445	1418	2486	2431	2380	
2134 x 1905 7'0" x 6'3"	1020	1075	1227	1445	1418	2486	2431	2380	
2134 x 1930 7'0" x 6'4"	991	1030	1183	1400	1418	2486	2431	2380	
2134 x 1981 7'0" x 6'6"	928	1000	1164	1381	1418	2486	2431	2380	
2134 x 2134 7'0" x 7'0"	1001	1026	1187	1405	1428	2499	2435	2391	
2134 x 2210 7'0" x 7'3"	1152	1180	1365	1583	1642	2499	2435	2391	
2134 x 2286 7'0" x 7'6"	1244	1274	1476	1693	1773	2662	2825	2555	
2225 x 1930 7'3" x 6'4"	1041	1058	1212	1429	1454	2662	2825	2555	
2225 x 1981 7'3" x 6'6"	1044	1058	1215	1432	1454	2662	2825	2555	
2225 x 2134 7'3" x 7'0"	1053	1058	1221	1438	1454	2662	2825	2555	
2210 x 2210 7'3" x 7'3"	1211	1217	1405	1622	1674	2662	2825	2555	
2210 x 2286 7'3" x 7'6"	1307	1313	1516	1733	1807	2662	2825	2555	
2260 x 1930 7'5" x 6'4"	1073	1093	1244	1462	1454	2662	2825	2555	
2260 x 1981 7'5" x 6'6"	1041	1066	1218	1435	1454	2662	2825	2555	
2260 x 2134 7'5" x 7'0"	1105	1127	1296	1514	1466	2662	2825	2555	
2261 x 2210 7'5" x 7'3"	1270	1295	1490	1708	1685	2662	2825	2555	
2261 x 2286 7'5" x 7'6"	1372	1398	1610	1827	1820	2662	2825	2555	
2285 x 1930 7'6" x 6'4"	1040	1081	1233	1450	1454	2662	2825	2555	
2285 x 1981 7'6" x 6'6"	1040	1081	1233	1450	1454	2662	2490	2559	
2285 x 2134 7'6" x 7'0"	1126	1144	1296	1514	1466	2662	2541	2578	
2286 x 2210 7'6" x 7'3"	1294	1315	1490	1708	1685	2662	2541	2578	
2286 x 2286 7'6" x 7'6"	1397	1421	1610	1827	1820	2741	2704	2741	
2438 x 1930 8'0" x 6'4"	1207	1203	1354	1571	1518	2741	2704	2741	
2438 x 1981 8'0" x 6'6"	1292	1203	1354	1571	1518	2741	2558	2665	
2438 x 2134 8'0" x 7'0"	1322	1203	1379	1596	1529	2741	2613	2669	
2438 x 2210 8'0" x 7'3"	1520	1383	1584	1801	1757	2832	2613	2669	
2438 x 2286 8'0" x 7'6"	1642	1494	1711	1928	1898	2832	2776	2832	

Cardale Secured by Design garage doors have spring assisted retractable action for smooth running.

Factory fitted steel frames as standard 70mm wide. Cardale Secured by Design Up & Over garage doors can only be supplied in a pre-hung factory finished steel fixing frame, which makes installation simple and eliminates the need for a timber frame. These frames are supplied as standard in white, however colour matched frames are also available. Supplied with our black "D" handle.

Secured by Design doors are bespoke and made to order.

Secured by Design doors - options

Matching coloured frame	add £149
Painted door panel	add £104 (Colours)
Cardale DC650T operator	add £444
Cardale DC800T operator	add £575

Steel doors including windows.

The standard colour window frame for white coloured doors is white. For non-white coloured doors the window frame colour will be black. Colour matched window frames are available but must be specified at time of order. Colour matched window frames (except Bedford) add £30 per window. Colour matched window frames for Bedford add £122 per door.

Secured by Design



Official Police Security Initiative

Cardale Secured by Design doors are certified to CS 5051 STS202 which is approved by ACPO Association Of Chief Police Officers.

NEW Colours

Colours available:

RAL9016	White
RAL7038	Ageta Grey
RAL7016	Anthracite Grey
RAL6005	Balmoral Green
RAL8017	Conker Brown
RAL9011	Graphite Black
RAL9004	Signal Black
RAL9005	Ebony Black
RAL7035	Light Grey
RAL5013	Oxford Blue
RAL5011	Midnight Blue
RAL3003	Monarch Red
RAL3009	Oxide Red
RAL8003	Signal Brown
RAL7004	Signal Grey
RAL5024	Pastel Blue
RAL6009	Fir Green
RAL6013	Reed Green
BS4800-14C35	Chartwell Green
BS4800-12B17	Willow Green
BS381-420	Dark Camouflage Desert Sand
BS381-389	Camouflage Beige
Cherry	

Optional extras for operators

Extra handsets	add £67 (2 channel) add £73 (4 channel)
Wireless key pad	add £183
External manual override	add £42
Keyswitch	add £45

R = Retractable gear.

Timber sizes highlighted in grey



Golden Oak and Rosewood finished steel doors

single doors

Single doors Golden Oak & Rosewood	Bedford		Berkeley Vertical		Europa II		Gatcombe		Gemini		Georgian		Haven		Sheraton II		Sheraton II glazed		Vogue	
	C	R	C	R	C	R	C	R	C	R	C	R	C	R	C	R	C	R	C	R
1981 x 1981 (6'6" x 6'6")	-	-	997	1052	694	748	997	1052	767	822	936	990	990	1044	1098	1153	1165	1276	879	933
1981 x 2134 (6'6" x 7'0")	-	-	997	1052	702	756	997	1052	769	823	952	1006	783	837	869	923	921	975	880	935
2083 x 1905 (6'10" x 6'3")	-	-	997	1052	709	764	997	1052	783	837	952	1006	797	852	885	940	939	993	897	951
2083 x 1930 (6'10" x 6'4")	-	-	997	1052	713	769	997	1052	777	831	911	965	797	852	885	940	939	993	897	951
2083 x 1956 (6'10" x 6'5")	-	-	997	1052	721	775	997	1052	794	849	911	965	809	852	898	952	952	1006	907	961
2083 x 1981 (6'10" x 6'6")	-	-	997	1052	730	784	997	1052	794	849	911	965	809	852	898	952	952	1006	907	961
2108 x 1981 (6'11" x 6'6")	1193	1248	997	1052	730	784	997	1052	794	849	911	965	809	852	898	952	952	1006	907	961
2108 x 2134 (6'11" x 7'0")	1193	1248	997	1052	730	784	997	1052	794	849	911	965	809	852	898	952	952	1006	907	961
2134 x 1828 (7'0" x 6'0")	1193	1248	997	1052	730	784	997	1052	798	853	911	965	813	867	902	956	956	1010	911	965
2134 x 1880 (7'0" x 6'2")	1193	1248	997	1052	730	784	997	1052	798	853	911	965	813	867	902	956	956	1010	911	965
2134 x 1905 (7'0" x 6'3")	1193	1248	997	1052	730	784	997	1052	798	853	-	-	813	867	902	956	956	1010	911	965
2134 x 1930 (7'0" x 6'4")	1193	1248	997	1052	730	784	997	1052	798	853	911	965	813	867	902	956	956	1010	911	965
2134 x 1981 (7'0" x 6'6")	1191	1247	1191	1247	677	731	1191	1301	764	818	908	962	735	789	815	869	864	918	882	937
2134 x 2134 (7'0" x 7'0")	1199	1253	1199	1253	722	776	1199	1199	782	836	951	1005	802	858	891	946	944	999	906	960
2210 x 1930 (7'3" x 6'4")	1235	1290	1101	1156	749	805	1101	1101	828	882	999	1053	840	895	932	987	988	1042	941	995
2261 x 1981 (7'5" x 6'6")	1235	1290	1101	1156	767	822	1101	1156	842	897	1028	1082	819	873	909	964	964	1018	935	989
2261 x 2134 (7'5" x 7'0")	1235	1290	1101	1156	844	899	1101	1156	913	967	1186	1241	905	959	1005	1059	1066	1120	997	1052
2286 x 1828 (7'6" x 6'0")	1235	1290	1101	1156	753	808	1101	1156	823	877	1186	1241	834	888	926	981	983	1037	935	989
2286 x 1905 (7'6" x 6'3")	1235	1290	1101	1156	753	808	1101	1156	823	877	-	-	834	888	926	981	956	1010	935	989
2286 x 1981 (7'6" x 6'6")	1230	1285	1230	1285	752	807	1230	1230	822	876	1005	1059	820	875	911	965	965	1019	997	1052
2286 x 2134 (7'6" x 7'0")	1234	1289	1234	1289	837	899	1234	1234	885	940	1148	1203	900	954	999	1053	1058	1113	997	1052
2438 x 1905 (8'0" x 6'3")	1309	1363	1158	1212	815	869	1158	1158	917	971	-	-	924	979	1027	1081	1089	1143	1029	1083
2438 x 1930 (8'0" x 6'4")	1309	1363	1158	1212	844	899	1158	1158	940	994	1171	1225	944	999	1048	1102	1112	1166	1050	1105
2438 x 1981 (8'0" x 6'6")	1309	1363	1295	1349	844	899	1295	1295	940	994	1186	1241	944	999	1048	1102	1112	1166	1050	1105
2438 x 2134 (8'0" x 7'0")	1312	1366	1296	1350	833	887	1296	1296	972	1027	1186	1241	976	1031	1084	1138	1149	1204	1084	1138
2743 x 1981 (9'0" x 6'6")	-	-	-	1559	-	1198	-	-	-	1198	-	1296	-	-	-	1877	-	2028	-	1565
2743 x 2134 (9'0" x 7'0")	-	-	-	1559	-	1227	-	-	-	1227	-	1319	-	-	-	1905	-	2056	-	1588
2896 x 1981 (9'6" x 6'6")	-	-	-	1559	-	1338	-	-	-	1338	-	1343	-	-	-	1936	-	2089	-	1612
2896 x 2134 (9'6" x 7'0")	-	-	-	1559	-	1365	-	-	-	1365	-	1366	-	-	-	1973	-	2131	-	1644
3048 x 1981 (10'0" x 6'6")	-	-	-	1559	-	1387	-	-	-	1387	-	1631	-	-	-	2000	-	2160	-	1666
3048 x 2134 (10'0" x 7'0")	-	-	-	1559	-	1415	-	-	-	1415	-	1661	-	-	-	2038	-	2202	-	1698

Golden Oak and Rosewood finished steel doors

made to measure single doors

Made to measure doors Pre-finished white or ABS or Golden Oak & Rosewood	Bedford		Berkeley Vertical		Europa II		Gatcombe		Gemini		Georgian		Haven		Sheraton II		Sheraton II glazed		Vogue	
	C	R	C	R	C	R	C	R	C	R	C	R	C	R	C	R	C	R	C	R
1981 (6'6")	-	-	1246	1300	779	833	1247	1301	843	898	1015	1071	902	956	1001	1055	1060	1115	949	1003
2134 (7'0")	1304	1358	1246	1300	798	853	1247	1301	856	911	1013	1068	914	968	1014	1070	1076	1130	961	1015
2286 (7'6")	1349	1403	1246	1300	908	962	1377	1431	953	1007	1202	1256	1011	1066	1123	1177	1189	1244	1058	1113
2438 (8'0")	1429	1483	1377	1431	928	983	1445	1500	1035	1089	1288	1342	1094	1148	1215	1269	1288	1342	1141	1196
2591 (8'6")	-	-	-	-	-	1589	-	-	-	1582	-	1608	-	-	-	1608	-	1677	-	1460
2743 (9'0")	-	-	-	-	-	1589	-	-	-	1582	-	1608	-	-	-	1608	-	1677	-	1460
2896 (9'6")	-	-	-	-	-	1727	-	-	-	1768	-	1683	-	-	-	1683	-	1818	-	1512
3048 (10'0")	-	-	-	-	-	1863	-	-	-	1822	-	1992	-	-	-	1992	-	2152	-	1564

Size availability (mm)

Minimum width	2083	2083	1829	1829	1829	1829	1829	1829	1829	1930	1930	1829	1829	1930	1930	1829	1829	1829	1829	
Maximum width	2438	2438	2438	2438	2438	3048	2438	2438	2438	3048	2438	3048	2438	2438	2438	3048	2438	3048	2438	3048
Minimum height	1829	1860	1829	1860	1829	1918*	1829	1860	1829	1860	1905	1905	1829	1860	1829	1860	1829	1918	1829	1860
Maximum height	2134	2286	2134	2286	2134	2286	2134	2286	2134	2286	2134	2134	2134	2286	2134	2134	2134	2134	2134	2286

C = Canopy gear, R = Retractable gear.

Golden Oak & Rosewood single doors - options

Flush lock handle (Gemini and Europa only)	add £43
Standard frame (Pre-finished or white painted)	add £116
Coloured frame	add £159 (Coloured paint)
Cardale DC650T operator	add £444
Cardale DC800T operator	add £575
Glazing (Bedford)	add £139 (Stippled) Black mock glazing standard
Glazing (Brompton)	add £294
Glazing (Georgian)	add £294
Glazing (Sheraton II)	Plain black, Stippled, Transparent, Diamond lattice, Queen Anne lattice, Square lattice (Sheraton II only at no extra cost)

Optional extras for operators

Extra handsets	add £67 (2 channel) add £73 (4 channel)
Wireless key pad	add £184
External manual override	add £42
Keypad	add £45

Steel doors including windows.

The standard colour window frame for non-white coloured doors and for Rosewood and Golden Oak laminated doors the window frame colour will be black. Colour matched window frames are available but must be specified at time of order.

Colour matched window frames (except Bedford)	add £30 per window
Colour matched window frames for Bedford	add £122 per door



Both the door chassis and steel fixing frames are supplied in these 2 standard colours.

Colour match for Golden Oak is Clay Brown RAL8003
Colour match for Rosewood is Cherry

All Golden Oak and Rosewood doors are bespoke and made to order. Please see page 25 for side hinged doors & options

Golden Oak and Rosewood finished steel doors

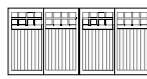
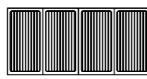
double doors

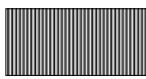
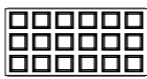
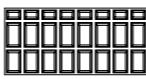
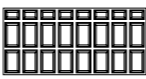
Double doors Golden Oak & Rosewood							
	Bedford	Berkeley Vertical	Europa II	Gemini	Georgian	Sheraton II	Sheraton II glazed
Size mm (ft/in) Width by Height	R	R	R	R	R	R	R
3200 x 1981 [10'6" x 6'6"]	1834	1559	1615	1556	2178	2233	2350
3200 x 2134 [10'6" x 7'0"]	1863	1584	1645	1574	1742	2251	2432
3353 x 1981 [11'0" x 6'6"]	1893	1609	1692	1587	1765	2432	2626
3353 x 2134 [11'0" x 7'0"]	1924	1636	1723	1605	1788	2470	2667
3505 x 1981 [11'6" x 6'6"]	-	1660	1759	1627	1813	2484	2683
3505 x 2134 [11'6" x 7'0"]	-	1685	1788	1646	1836	2491	2690
3658 x 1981 [12'0" x 6'6"]	-	1711	1826	1663	1860	2538	2741
3658 x 2134 [12'0" x 7'0"]	-	1736	1857	1681	1884	2576	2783
3810 x 1981 [12'6" x 6'6"]	-	1763	1876	1699	1907	2576	2783
3810 x 2134 [12'6" x 7'0"]	-	1788	1906	1715	1931	2605	2814
3962 x 1981 [13'0" x 6'6"]	-	2053	1926	1734	1942	2674	2887
3962 x 2134 [13'0" x 7'0"]	-	2053	1956	1751	1951	2710	2928
4115 x 1981 [13'6" x 6'6"]	2465	2053	2046	1770	1961	2811	3036
4115 x 2134 [13'6" x 7'0"]	2465	2053	2074	1787	1971	2849	3077
4267 x 1981 [14'0" x 6'6"]	2465	2096	1830	1568	1959	2481	2677
4267 x 2134 [14'0" x 7'0"]	2465	2096	1860	1596	1989	2519	2720
4420 x 1981 [14'6" x 6'6"]	2587	2282	2248	1818	1980	2951	3186
4420 x 2134 [14'6" x 7'0"]	2587	2380	2278	1835	1997	2987	3226
4572 x 1981 [15'0" x 6'6"]	2710	2380	2366	1854	2010	3007	2161
4572 x 2134 [15'0" x 7'0"]	2710	2380	2380	1870	2028	3045	3289
4877 x 1981 [16'0" x 6'6"]	2957	2380	2380	1888	2072	3287	3550
4877 x 2134 [16'0" x 7'0"]	2957	2380	2380	1906	2090	3325	3591

Made to measure Golden Oak and Rosewood finished steel double doors

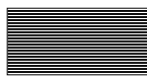
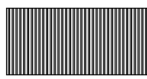
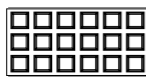
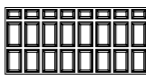
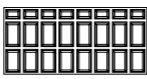
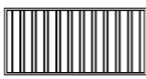
Made to measure double doors Golden Oak & Rosewood						
	Europa II	Gemini	Georgian	Sheraton II	Sheraton II glazed	Vogue
Width (up to) mm (ft/in) Width by Height	R	R	R	R	R	R
3200 [10'6"]	1944	1902	2077	2077	2243	1734
3353 [11'0"]	2025	1932	2126	2126	2297	1906
3505 [11'6"]	2095	1976	2175	2175	2350	1947
3658 [12'0"]	2166	2012	2226	2226	2404	1991
3810 [12'6"]	2218	2050	2276	2276	2459	2045
3962 [13'0"]	2271	2087	2297	2297	2480	2098
4267 [14'0"]	2170	1924	2335	2335	2522	1945
4572 [15'0"]	2183	2212	2377	2377	2921	2364
4877 [16'0"]	2228	2249	2442	2442	2638	2584

All Golden Oak and Rosewood doors are bespoke and made to order.

Frames ordered with a double door will be supplied as a separate knocked down item.

Golden Oak and Rosewood finished steel doors

double doors

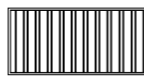
Double doors Golden Oak & Rosewood	
	Vogue
Size mm (ft/in) Width by Height	R
3200 x 1981 [10'6" x 6'6"]	-
3200 x 2134 [10'6" x 7'0"]	1876
3353 x 1981 [11'0" x 6'6"]	2027
3353 x 2134 [11'0" x 7'0"]	2057
3505 x 1981 [11'6" x 6'6"]	2070
3505 x 2134 [11'6" x 7'0"]	2077
3658 x 1981 [12'0" x 6'6"]	2116
3658 x 2134 [12'0" x 7'0"]	2147
3810 x 1981 [12'6" x 6'6"]	2171
3810 x 2134 [12'6" x 7'0"]	2203
3962 x 1981 [13'0" x 6'6"]	2228
3962 x 2134 [13'0" x 7'0"]	2259
4115 x 1981 [13'6" x 6'6"]	2343
4115 x 2134 [13'6" x 7'0"]	2374
4267 x 1981 [14'0" x 6'6"]	2068
4267 x 2134 [14'0" x 7'0"]	2099
4420 x 1981 [14'6" x 6'6"]	2459
4420 x 2134 [14'6" x 7'0"]	2489
4572 x 1981 [15'0" x 6'6"]	2507
4572 x 2134 [15'0" x 7'0"]	2538
4877 x 1981 [16'0" x 6'6"]	2739
4877 x 2134 [16'0" x 7'0"]	2771

C = Canopy gear, R = Retractable gear.

Golden Oak & Rosewood double doors - options

Standard frame (Pre-finished or white painted)	add £207
Coloured frame	add £314 (Coloured paint)
Cardale DC650T operator	add £444
Cardale DC800T operator	add £575
Glazing (Bedford)	add £280 (Stippled) Black mock glazing standard
Glazing (Brompton)	add £581 (Stippled or plain)
Glazing (Georgian)	add £581 (Stippled or plain)
Glazing (Sheraton II)	Plain black, Stippled, Transparent, Diamond lattice, Queen Anne lattice, Square lattice (Sheraton II only at no extra cost)

Optional extras for operators

Extra handsets	add £67 (2 channel) add £73 (4 channel)
Wireless key pad	add £184
External manual override	add £42
Keyswitch	add £45

Steel doors including windows.

The standard colour window frame for Rosewood and Golden Oak laminated doors will be black. Colour matched window frames are available but must be specified at time of order.

Colour matched window frames (except Bedford)	add £30 per window
Colour matched window frames for Bedford	add £234 per door









Both the door chassis and steel fixing frames are supplied in these 2 standard colours.

Size availability (mm)

	2500	2500	2500	2500	2500	2500
Minimum width	2500	2500	2500	2500	2500	2500
Maximum width	4374	4999	4999	4999	4999	4999
Minimum height	1927	1927	1953	1927	1927	1927
Maximum height	2343	2343	2187	2187	2187	2343

All Golden Oak and Rosewood doors are bespoke and made to order.

Frames ordered with a double door will be supplied as a separate knocked down item.

Single doors Timber Futura																
	C	R	C	R	C	R	C	R	C	R	C	R	C	R	C	R
2134 x 1981 (7'0" x 6'6")	1802	1857	1603	1657	1566	1620	1651	1706	1675	1729	1532	1587	1898	1953	1424	1478
2134 x 2134 (7'0" x 7'0")	1833	1887	1611	1665	1569	1623	1715	1770	1683	1737	1539	1594	1985	2039	1424	1478
2134 x 2286 (7'0" x 7'6")	-	1996	-	1774	-	1883	-	1878	-	1845	-	1702	-	2148	-	1587
2134 x 2438 (7'0" x 8'0")	-	2104	-	1883	-	2046	-	1988	-	1932	-	1812	-	2257	-	1695
2286 x 1981 (7'6" x 6'6")	1916	1971	1651	1706	1606	1660	1737	1788	1724	1778	1651	1706	2126	2180	1468	1522
2286 x 2134 (7'6" x 7'0")	1930	1985	1664	1719	1640	1694	1812	1866	1773	1827	1664	1719	2136	2190	1516	1570
2286 x 2286 (7'6" x 7'6")	-	2094	-	1827	-	1802	-	1974	-	1937	-	1827	-	2299	-	1679
2286 x 2438 (7'6" x 8'0")	-	2080	-	1883	-	1991	-	2083	-	2045	-	1937	-	2407	-	1787
2438 x 1981 (8'0" x 6'6")	1964	2018	1723	1777	1650	1704	1944	1998	1816	1859	1723	1777	2207	2261	1566	1620
2438 x 2134 (8'0" x 7'0")	1964	2018	1726	1780	1688	1742	2006	2060	1844	1900	1726	1780	2265	2319	1596	1650
2438 x 2286 (8'0" x 7'6")	-	2127	-	1888	-	1851	-	2169	-	2008	-	1888	-	2428	-	1759
2438 x 2438 (8'0" x 8'0")	-	2236	-	1997	-	1959	-	2277	-	2117	-	1997	-	2537	-	1868
2743 x 1981 (9'0" x 6'6")	-	-	-	2192	-	2047	-	-	-	2192	-	2049	-	-	-	-
2743 x 2134 (9'0" x 7'0")	-	-	-	2218	-	2073	-	-	-	2290	-	2083	-	-	-	-
2743 x 2438 (9'0" x 8'0")	-	-	-	2461	-	2260	-	-	-	2532	-	2255	-	-	-	-
3048 x 1981 (10'0" x 6'6")	-	-	-	2251	-	2142	-	-	-	2372	-	2128	-	-	-	-
3048 x 2134 (10'0" x 7'0")	-	-	-	2336	-	2155	-	-	-	2549	-	2149	-	-	-	-

Size availability (mm)

Minimum width	1778	1778	1778	1778	1778	1778	1778	1778	1778	1778	1778	1778	1778	1778	1778	1778
Maximum width	2438	2438	2438	3048	2438	3048	2438	2438	2438	3048	2438	3048	2438	2438	2438	2438
Minimum height	1778	1829	1778	1829	1778	1829	1778	1829	1778	1829	1778	1829	1778	1829	1778	1829
Maximum height	2134	2438	2134	2438	2134	2438	2134	2438	2134	2438	2134	2438	2134	2438	2134	2438

For made to measure sizes go to the next standard size.

C = Canopy gear, R = Retractable gear.

Timber up and over single doors - options





Standard frame	add £116 (Brown RAL8017)
Coloured frame 54mm/68mm	add £159 (Coloured paint)
Cardale DC650T operator	add £444
Cardale DC800T operator	add £575
Glazing (Bedford)	Stippled as standard
Glazing (Cotswold)	Plain black, Stippled, Transparent, Diamond lattice, Queen Anne lattice, Square lattice (Cotswold only at no extra cost)
Glazing (Ibstock & Strathmore)	Stippled as standard

Optional extras for operators

Extra handsets	add £67 (2 channel) add £73 (4 channel)
Wireless key pad	add £1184
External manual override	add £42
Keyswitch	add £45

All Timber doors are bespoke and made to order.

Please see page 26 for side hinged doors & options

Single doors Timber Futura								
	C	R	C	R	C	R	C	R
2134 x 1981 (7'0" x 6'6")	1953	2007	1898	1953	1983	2037	1411	1466
2134 x 2134 (7'0" x 7'0")	1983	2037	1985	2039	1999	2053	1411	1466
2134 x 2286 (7'0" x 7'6")	-	2144	-	2147	-	2162	-	1573
2134 x 2438 (7'0" x 8'0")	-	2254	-	2256	-	2271	-	1682
2286 x 1981 (7'6" x 6'6")	2067	2121	2126	2180	2221	2275	1456	1511
2286 x 2134 (7'6" x 7'0")	2384	2438	2136	2190	2258	2312	1504	1558
2286 x 2286 (7'6" x 7'6")	-	2547	-	2624	-	2475	-	1665
2286 x 2438 (7'6" x 8'0")	-	2655	-	2733	-	2583	-	1774
2438 x 1981 (8'0" x 6'6")	2075	2130	2207	2261	2582	2637	1554	1608
2438 x 2134 (8'0" x 7'0")	2115	2169	2265	2319	2625	2680	1584	1639
2438 x 2286 (8'0" x 7'6")	-	2277	-	2428	-	2788	-	1747
2438 x 2438 (8'0" x 8'0")	-	2386	-	2537	-	2897	-	1856
2743 x 1981 (9'0" x 6'6")	-	2707	-	2640	-	-	-	2079
2743 x 2134 (9'0" x 7'0")	-	2753	-	2717	-	-	-	2127
2743 x 2438 (9'0" x 8'0")	-	2830	-	3041	-	-	-	2171
3048 x 1981 (10'0" x 6'6")	-	2874	-	2874	-	-	-	2066
3048 x 2134 (10'0" x 7'0")	-	3071	-	3071	-	-	-	2131

Size availability (mm)

Minimum width	1778	1778	1778	1778	1778	1778	1778	1778
Maximum width	2438	3048	2438	3048	2438	2438	2438	3048
Minimum height	1829	1860	1829	1860	1829	1860	1829	1860
Maximum height	2134	2438	2134	2438	2134	2438	2134	2438

For made to measure sizes go to the next standard size.



Timber door fully finished options

Cardale fully finished option is a factory finish process, the Sikkens product used is available in six attractive colours as illustrated. For south facing situations exposed to strong sunlight the dark colours are not recommended, as they can store excessive heat and dry out. Timber doors are supplied with a basecoat stain as standard. They MUST be finished immediately after installation.

Fully finished single timber doors Add £145

Factory Finishes available:

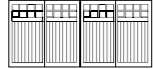
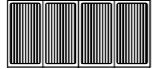
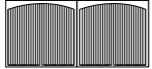
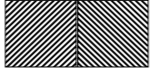
- Light oak
- Burnt Oak
- Rosewood
- Walnut
- Mahogany
- Ebony

Double doors Timber Futura	 Bedford	 Berkeley Vertical	 Burley	 Chevron	 Cotswold	 Gatcombe
Size mm (ft/in) Width by Height	R	R	R	R	R	R
3048 x 2438 [10'0" x 8'0"]	-	2478	2383	3034	2608	2449
3658 x 1981 [12'0" x 6'6"]	-	2625	2684	3069	3016	2689
3658 x 2134 [12'0" x 7'0"]	-	2671	2707	3112	3089	2715
3658 x 2438 [12'0" x 8'0"]	-	2814	2965	3306	3175	2950
3962 x 1981 [13'0" x 6'6"]	-	2631	2814	3212	3297	2813
3962 x 2134 [13'0" x 7'0"]	-	2657	2839	3249	3376	2850
3962 x 2438 [13'0" x 8'0"]	-	2868	3099	3490	3440	3085
4267 x 1981 [14'0" x 6'6"]	3797	2900	3226	3675	3578	3220
4267 x 2134 [14'0" x 7'0"]	3827	2910	3256	3712	3621	3269
4267 x 2438 [14'0" x 8'0"]	3928	3210	3544	4022	3820	3528
4572 x 1981 [15'0" x 6'6"]	3902	3091	3482	3865	3862	3491
4572 x 2134 [15'0" x 7'0"]	3956	3114	3535	3899	3960	3538
4572 x 2438 [15'0" x 8'0"]	4308	3345	3810	4186	4085	3805
4877 x 1981 [16'0" x 6'6"]	4507	3591	4086	4442	4132	4112
4877 x 2134 [16'0" x 7'0"]	4546	3632	4169	4475	4176	4163
4877 x 2438 [16'0" x 8'0"]	4625	3814	4456	4772	4623	4464

Size availability (mm)

Minimum width	2438	2438	2438	2438	2438	2438
Maximum width	4877	4877	4877	4877	4877	4877
Minimum height	1880	1880	1880	1880	1880	1880
Maximum height	2438	2438	2438	2438	2438	2438

For made to measure sizes go to the next standard size.

C = Canopy gear, R = Retractable gear.

Timber up and over double doors - options

Standard frame	add £207 (Brown RAL8017)
Coloured frame 54mm/68mm	add £276 (Coloured paint)
Cardale DC650T operator	add £444
Cardale DC800T operator	add £575
Glazing (Bedford)	Stippled as standard
Glazing (Cotswold)	Plain black, Stippled, Transparent, Diamond lattice, Queen Anne lattice, Square lattice (Cotswold only at no extra cost)
Glazing (Ibstock & Strathmore)	Stippled as standard



Optional extras for operators

Extra handsets	add £69 (2 channel) add £73 (4 channel)
Wireless key pad	add £184
External manual override	add £42
Keyswitch	add £45

All Timber doors are bespoke and made to order.

Please see page 26 for side hinged doors & options

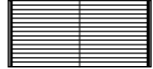
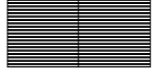
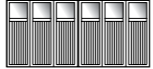
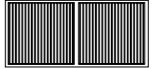
Frames ordered with a double door will be supplied as a separate knocked down item.

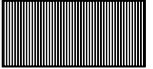
Double doors Timber Futura	 Hampshire	 Horizontal	 Ibstock	 Kent Wide	 Strathmore	 Vertical
Size mm (ft/in) Width by Height	R	R	R	R	R	R
3048 x 2438 [10'0" x 8'0"]	2949	2193	3151	3151	-	2211
3658 x 1981 [12'0" x 6'6"]	3040	2222	3578	3221	-	2728
3658 x 2134 [12'0" x 7'0"]	3148	2222	3591	3591	-	2774
3658 x 2438 [12'0" x 8'0"]	3257	2439	3674	3674	-	2874
3962 x 1981 [13'0" x 6'6"]	-	-	3745	3575	-	2680
3962 x 2134 [13'0" x 7'0"]	-	-	3763	3763	-	2711
3962 x 2438 [13'0" x 8'0"]	-	-	3852	3852	-	2880
4267 x 1981 [14'0" x 6'6"]	3258	2439	4289	4289	4210	2899
4267 x 2134 [14'0" x 7'0"]	3258	2439	4311	4311	3924	2920
4267 x 2438 [14'0" x 8'0"]	3476	2656	4415	4415	4489	3176
4572 x 1981 [15'0" x 6'6"]	-	-	4415	4415	4238	3018
4572 x 2134 [15'0" x 7'0"]	-	-	4447	4447	4560	3043
4572 x 2438 [15'0" x 8'0"]	-	-	4532	4532	4677	3272
4877 x 1981 [16'0" x 6'6"]	3441	2874	4983	4983	4691	3441
4877 x 2134 [16'0" x 7'0"]	3550	2874	5029	5029	4967	3472
4877 x 2438 [16'0" x 8'0"]	3767	3091	5103	5103	5332	3697

Size availability (mm)

Minimum width	2438	2438	2438	2438	2438	2438
Maximum width	4877	4877	4877	4877	4877	4877
Minimum height	1880	1880	1880	1880	1880	1880
Maximum height	2438	2438	2438	2438	2438	2438

For made to measure sizes go to the next standard size.

Timber door fully finished options









Cardale fully finished option is a factory finish process, the Sikkens product used is available in six attractive colours as illustrated. For south facing situations exposed to strong sunlight the dark colours are not recommended, as they can store excessive heat and dry out. Timber doors are supplied with a basecoat stain as standard. They MUST be finished immediately after installation.

Fully finished double timber doors Add £238

Factory Finishes available:

- Light oak
- Burnt Oak
- Rosewood
- Walnut
- Mahogany
- Ebony

Frames ordered with a double door will be supplied as a separate knocked down item.

Single doors Timber Heritage																
	C	R	C	R	C	R	C	R	C	R	C	R	C	R	C	R
2134 x 1981 (7'0" x 6'6")	1473	1527	1383	1437	1383	1437	1383	1437	1473	1527	1720	1807	1720	1774	1473	1527
2134 x 2134 (7'0" x 7'0")	1497	1552	1419	1473	1419	1473	1419	1473	1497	1552	1773	1827	1773	1827	1497	1552
2134 x 2286 (7'0" x 7'6")	-	1573	-	1539	-	1539	-	1539	-	1573	-	1931	-	1931	-	1573
2134 x 2438 (7'0" x 8'0")	-	-	-	-	-	-	-	-	-	-	-	-	-	-	-	-
2286 x 1981 (7'6" x 6'6")	1553	1607	1421	1476	1421	1476	1421	1476	1553	1607	1992	2046	1992	2046	1553	1607
2286 x 2134 (7'6" x 7'0")	1584	1639	1451	1506	1451	1506	1451	1506	1584	1639	2029	2083	2029	2083	1584	1640
2286 x 2286 (7'6" x 7'6")	-	1672	-	1641	-	1641	-	1641	-	1672	-	2127	-	2127	-	1672
2286 x 2438 (7'6" x 8'0")	-	-	-	-	-	-	-	-	-	-	-	-	-	-	-	-
2438 x 1981 (8'0" x 6'6")	1736	1790	1520	1574	1520	1574	1520	1574	1700	1754	2185	2240	2185	2240	1700	1754
2438 x 2134 (8'0" x 7'0")	1790	1844	1559	1613	1559	1613	1559	1613	1727	1781	2222	2276	2222	2276	1727	1781
2438 x 2286 (8'0" x 7'6")	-	1954	-	1723	-	1723	-	1723	-	1889	-	2385	-	2385	-	1889
2438 x 2438 (8'0" x 8'0")	-	2062	-	1831	-	1831	-	1831	-	1998	-	2493	-	2493	-	1998
2743 x 1981 (9'0" x 6'6")	-	2159	-	1923	-	1923	-	1923	-	2159	-	-	-	2576	-	2159
2743 x 2134 (9'0" x 7'0")	-	2203	-	1961	-	1961	-	1961	-	2203	-	-	-	2598	-	2203
2743 x 2438 (9'0" x 8'0")	-	2287	-	2050	-	2050	-	2050	-	2287	-	-	-	2669	-	2287
3048 x 1981 (10'0" x 6'6")	-	2423	-	2063	-	2063	-	2063	-	2423	-	-	-	2860	-	2423
3048 x 2134 (10'0" x 7'0")	-	2459	-	2117	-	2117	-	2117	-	2459	-	-	-	2912	-	2459

Size availability (mm)

Minimum width	1778	1778	1778	1778	1778	1778	1778	1778	1778	1778	1778	1778	1778	1778	1778	1778
Maximum width	2438	3048	2438	3048	2438	3048	2438	3048	2438	3048	2438	2438	2438	3048	2438	3048
Minimum height	1829	1860	1829	1860	1829	1860	1829	1860	1829	1860	1829	1860	1829	1860	1829	1860
Maximum height	2134	2286	2134	2286	2134	2286	2134	2286	2134	2286	2134	2286	2134	2286	2134	2286

For made to measure sizes go to the next standard size.

C = Canopy gear, R = Retractable gear.

Timber up and over single doors - options





Standard frame	add £116 (Brown RAL8017)
Coloured frame 54mm/68mm	add £159 (Coloured paint)
Cardale DC650T operator	add £444
Cardale DC800T operator	add £575
Glazing (Bromley, Shropshire, Guildford)	add £226 (Stippled as standard)

Optional extras for operators

Extra handsets	add £67 (2 channel) add £73 (4 channel)
Wireless key pad	add £184
External manual override	add £42
Keyswitch	add £45

All Timber doors are bespoke and made to order.

Please see page 27 for side hinged doors & options

Single doors Timber Heritage										
	C	R	C	R	C	R	C	R	C	R
2134 x 1981 (7'0" x 6'6")	1512	1566	1311	1365	1720	1774	1378	1432	1264	1318
2134 x 2134 (7'0" x 7'0")	1538	1593	1345	1399	1773	1827	1413	1467	1388	1442
2134 x 2286 (7'0" x 7'6")	-	1624	-	1424	1877	1931	-	-	-	1511
2134 x 2438 (7'0" x 8'0")	-	-	-	1548	1926	1981	-	1625	-	1606
2286 x 1981 (7'6" x 6'6")	1658	1712	1384	1438	1992	2046	1453	1508	1284	1338
2286 x 2134 (7'6" x 7'0")	1631	1685	1403	1459	2029	2083	1474	1529	1285	1339
2286 x 2286 (7'6" x 7'6")	-	1710	-	1544	-	2127	-	-	-	1411
2286 x 2438 (7'6" x 8'0")	-	-	-	1609	-	2181	-	1690	-	1486
2438 x 1981 (8'0" x 6'6")	1737	1791	1419	1473	2185	2240	1490	1548	1297	1352
2438 x 2134 (8'0" x 7'0")	1763	1817	1470	1524	2222	2276	1543	1597	1299	1353
2438 x 2286 (8'0" x 7'6")	-	1925	-	1633	-	2385	-	1706	-	1462
2438 x 2438 (8'0" x 8'0")	-	2034	-	1742	-	2493	-	1815	-	1570
2743 x 1981 (9'0" x 6'6")	-	2246	-	1839	-	2159	-	1923	-	1923
2743 x 2134 (9'0" x 7'0")	-	2290	-	1862	-	2203	-	1961	-	1961
2743 x 2438 (9'0" x 8'0")	-	2374	-	1954	-	2287	-	2050	-	2050
3048 x 1981 (10'0" x 6'6")	-	2510	-	1964	-	2423	-	2063	-	2063
3048 x 2134 (10'0" x 7'0")	-	2546	-	2033	-	2459	-	2117	-	2117

Size availability (mm)

Minimum width	1778	1778	1778	1778	1778	1778	1778	1778	1778	1778
Maximum width	2438	3048	2438	3048	2438	3048	2438	3048	2438	3048
Minimum height	1829	1860	1829	1860	1829	1860	1829	1860	1829	1860
Maximum height	2134	2286	2134	2438	2134	2438	2134	2438	2134	2438

For made to measure sizes go to the next standard size.



Timber door fully finished options

Cardale fully finished option is a factory finish process, the Sikkens product used is available in six attractive colours as illustrated. For south facing situations exposed to strong sunlight the dark colours are not recommended, as they can store excessive heat and dry out. Timber doors are supplied with a basecoat stain as standard. They MUST be finished immediately after installation.

Fully finished single timber doors Add £145

Factory Finishes available:

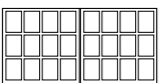
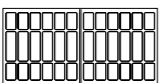
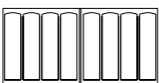
- Light oak
- Burnt Oak
- Rosewood
- Walnut
- Mahogany
- Ebony

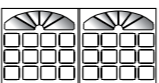
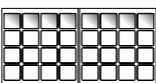
Double doors Timber Heritage							
	Bromley	Cardinal	Chiltern	Countryman	Guildford	Hampstead	Hathaway
Size mm (ft/in) Width by Height	R	R	R	R	R	R	R
3048 x 2438 [10'0" x 8'0"]	2598	2359	2359	2359	2598	-	3151
3658 x 1981 [12'0" x 6'6"]	2974	2539	2539	2539	2974	-	3066
3658 x 2134 [12'0" x 7'0"]	3041	2562	2562	2562	3041	-	3092
3658 x 2438 [12'0" x 8'0"]	3210	2731	2731	2731	3210	-	3317
4267 x 1981 [14'0" x 6'6"]	3435	2961	2961	2961	3435	4157	3821
4267 x 2134 [14'0" x 7'0"]	3473	2978	2978	2978	3473	4191	3856
4267 x 2438 [14'0" x 8'0"]	2433	3155	3155	3155	4469	4468	4133
4877 x 1981 [16'0" x 6'6"]	3784	3664	3664	3664	3784	4611	4275
4877 x 2134 [16'0" x 7'0"]	3868	3749	3749	3749	3868	4660	4325
4877 x 2438 [16'0" x 8'0"]	4018	3902	3902	3902	4018	4978	4642

Size availability (mm)

Minimum width	2438	2438	2438	2438	2438	2438	2438
Maximum width	4877	4877	4877	4877	4877	4877	4877
Minimum height	1880	1880	1880	1880	1880	1880	1880
Maximum height	2438	2438	2438	2438	2438	2438	2438

For made to measure sizes go to the next standard size.

C = Canopy gear, R = Retractable gear.

Timber up and over double doors - options

Standard frame	add £207 (Brown RAL8017)
Coloured frame 54mm/68mm	add £273 (Coloured paint)
Cardale DC650T operator	add £444
Cardale DC800T operator	add £575
Glazing (Bromley, Shropshire, Guildford)	add £452 (Stippled as standard)



Optional extras for operators

Extra handsets	add £67 (2 channel)
	add £73 (4 channel)
Wireless key pad	add £184
External manual override	add £42
Keyswitch	add £45

All Timber doors are bespoke and made to order.

Please see page 27 for side hinged doors & options

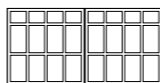
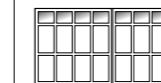
Frames ordered with a double door will be supplied as a separate knocked down item.

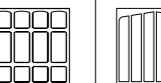
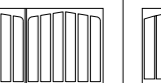
Double doors Timber Heritage						
	Shropshire	Shropshire glazed	Stuart	Thornley	Tudor	Windsor
Size mm (ft/in) Width by Height	R	R	R	R	R	R
3048 x 2438 [10'0" x 8'0"]	2598	2685	2190	2598	2359	2359
3658 x 1981 [12'0" x 6'6"]	2974	3061	2433	2974	2539	2539
3658 x 2134 [12'0" x 7'0"]	3041	3128	2477	3041	2562	2562
3658 x 2438 [12'0" x 8'0"]	3210	3297	2622	3210	2731	2731
4267 x 1981 [14'0" x 6'6"]	3435	3522	2515	3435	2961	2961
4267 x 2134 [14'0" x 7'0"]	3473	3559	2528	3473	2978	2978
4267 x 2438 [14'0" x 8'0"]	3633	3720	2814	3632	3155	3155
4877 x 1981 [16'0" x 6'6"]	3784	3871	3580	3784	3664	3664
4877 x 2134 [16'0" x 7'0"]	3868	3955	3679	3868	3749	3749
4877 x 2438 [16'0" x 8'0"]	4018	4105	3833	4018	3902	3902

Size availability (mm)

Minimum width	2438	2438	2438	2438	2438	2438
Maximum width	4877	4877	4877	4877	4877	4877
Minimum height	1880	1880	1880	1880	1880	1880
Maximum height	2438	2438	2438	2438	2438	2438

For made to measure sizes go to the next standard size.

Timber door fully finished options

Cardale fully finished option is a factory finish process, the Sikkens product used is available in six attractive colours as illustrated. For south facing situations exposed to strong sunlight the dark colours are not recommended, as they can store excessive heat and dry out. Timber doors are supplied with a basecoat stain as standard. They MUST be finished immediately after installation.











Fully finished double timber doors Add £238











Factory Finishes available:

- Light oak
- Burnt Oak
- Rosewood
- Walnut
- Mahogany
- Ebony

Frames ordered with a double door will be supplied as a separate knocked down item.

Powder coated pre-finished side hinged steel doors

Side hinged doors Pre-finished white											
Size mm (ft/in) Width by Height	Bedford (1/2 - 1/2)	Berkeley Horizontal (1/2 - 1/2)	Berkeley Vertical (1/2 - 1/2)	Brompton (1/2 - 1/2)	Gatcombe (1/2 - 1/2)	Gemini (2/3 - 1/3) (1/2 - 1/2)	Georgian (2/3 - 1/3)	Olympian (1/2 - 1/2)	Sheraton II (1/2 - 1/2)	Sheraton II glazed (1/2 - 1/2)	Vogue (1/2 - 1/2)
1981 x 1981 (6'6" x 6'6")	-	1380	-	1187	1380	1098	1187	1397	1432	1595	1399
1981 x 2134 (6'6" x 7'0")	-	1380	-	1201	1380	1111	1187	1397	1462	1624	1414
2134 x 1981 (7'0" x 6'6")	1501	1380	1937	1201	1380	1075	1201	1397	1414	1576	1371
2134 x 2134 (7'0" x 7'0")	1538	1417	1947	1239	1296	1135	1239	1432	1494	1657	1444
2286 x 1981 (7'6" x 6'6")	1596	1476	1997	1296	1355	1164	1296	1496	1519	1682	1478
2286 x 2134 (7'6" x 7'0")	1691	1570	2034	1392	1448	1227	1392	1600	1522	1773	1565
2438 x 1981 (8'0" x 6'6")	1727	1606	2135	1427	1485	1243	1427	1640	1531	1694	1573
2438 x 2134 (8'0" x 7'0")	1799	1679	2186	1460	1518	1259	1460	1689	1551	1713	1593

Made to measure Side hinged doors Pre-finished white											
Size mm (ft/in) Width by Height	Bedford (1/2 - 1/2)	Berkeley Horizontal (1/2 - 1/2)	Berkeley Vertical (1/2 - 1/2)	Brompton (1/2 - 1/2)	Gatcombe (1/2 - 1/2)	Gemini (2/3 - 1/3) (1/2 - 1/2)	Georgian (2/3 - 1/3)	Olympian (1/2 - 1/2)	Sheraton II (1/2 - 1/2)	Sheraton II glazed (1/2 - 1/2)	Vogue (1/2 - 1/2)
1981 x 1981 (6'6" x 6'6")	-	1505	1972	1234	1505	1222	1234	1521	1497	1632	1523
1981 x 2134 (6'6" x 7'0")	-	1505	-	1265	1505	1234	1265	1521	1511	1664	1538
1981 x 2286 (6'6" x 7'6")	-	1505	-	1222	1420	1164	1222	1435	-	-	-
2134 x 1981 (7'0" x 6'6")	1625	1505	1984	1326	1505	1200	1326	1521	1465	1628	1495
2134 x 2134 (7'0" x 7'0")	1662	1541	2007	1362	1541	1260	1362	1556	1516	1707	1569
2134 x 2286 (7'0" x 7'6")	1700	1579	2047	1362	1579	1260	1362	1592	-	-	1642
2286 x 1981 (7'6" x 6'6")	1721	1600	2056	1421	1600	1288	1421	1620	1550	1737	1603
2286 x 2134 (7'6" x 7'0")	1816	1694	2094	1517	1694	1352	1517	1725	1576	1821	1690
2286 x 2286 (7'6" x 7'6")	1909	1788	2171	1517	1788	1352	1517	1829	-	-	1777
2438 x 1981 (8'0" x 6'6")	1852	1731	2195	1552	1731	1367	1552	1765	1583	1734	1698
2438 x 2134 (8'0" x 7'0")	1924	1802	2246	1584	1802	1383	1584	1813	1596	1742	1717
2438 x 2286 (8'0" x 7'6")	1997	1875	2311	1584	1875	1383	1584	1861	-	-	1736

Size availability (mm)

Minimum width	2134	1750	1750	1829	1750	1750	1920	2012	2012	2012	1750
Maximum width	2438	2438	2438	2438	2438	2438	2438	2438	2438	2438	2438
Minimum height	1775	1775	1775	1850	1775	1775	1929	1850	1850	1850	1775
Maximum height	2286	2286	2286	2286	2286	2286	2134	2134	2134	2134	2286

Steel side hinged doors - options

Unframed	deduct £38
Painted frame	add £25
Glazing (Bedford)	add £121 (Stippled) Black mock glazing standard
Glazing (Brompton & Georgian)	add £293 (Stippled, Diamond Lattice, Square Lattice and Plain)
Painted door	add £116
Left hand opening	add £68

Side hinged doors supplied with pre-finished white 50mm frame as standard. Doors supplied as standard right hand opening when viewed from outside. All side hinged doors are only available opening outwards.









NEW Colours









Colours available:

RAL9016	White	RAL7004	Signal Grey
RAL7038	Ageta Grey	RAL5024	Pastel Blue
RAL7016	Anthracite Grey	RAL6009	Fir Green
RAL6005	Balmoral Green	RAL6013	Reed Green
RAL8017	Conker Brown	BS4800-14C35	Chartwell Green
RAL9011	Graphite Black	BS4800-12B17	Willow Green
RAL9004	Signal Black	BS381-420	Dark Camouflage
RAL9005	Ebony Black	Desert Sand	
RAL7035	Light Grey	BS381-389	Camouflage Beige
RAL5013	Oxford Blue	Cherry	
RAL5011	Midnight Blue		
RAL3003	Monarch Red		
RAL3009	Oxide Red		
RAL8003	Signal Brown		

All side hinged doors complete with door stay. All side hinged doors are bespoke and made to order.

Golden Oak and Rosewood pre-finished side hinged steel doors

Side hinged doors Golden Oak & Rosewood									
Size mm (ft/in) Width by Height	Bedford (1/2 - 1/2)	Berkeley Horizontal (1/2 - 1/2)	Berkeley Vertical (1/2 - 1/2)	Gatcombe (1/2 - 1/2)	Gemini (2/3 - 1/3) (1/2 - 1/2)	Georgian (2/3 - 1/3)	Sheraton II (1/2 - 1/2)	Sheraton II glazed (1/2 - 1/2)	Vogue (1/2 - 1/2)
1981 x 1981 (6'6" x 6'6")	-	1545	1545	1425	1545	1323	1425	1691	1588
1981 x 2134 (6'6" x 7'0")	-	1545	1545	1425	1545	1335	1425	1691	1602
2134 x 1981 (7'0" x 6'6")	1666	1545	1545	1425	1545	1299	1425	1691	1559
2134 x 2134 (7'0" x 7'0")	1703	1583	1583	1463	1583	1360	1463	1728	1633
2286 x 1981 (7'6" x 6'6")	1764	1642	1642	1521	1642	1388	1521	1787	1663
2286 x 2134 (7'6" x 7'0")	1860	1738	1738	1618	1738	1451	1618	1884	1742
2438 x 1981 (8'0" x 6'6")	1894	1773	1773	1651	1773	1467	1651	1918	1763
2438 x 2134 (8'0" x 7'0")	1926	1806	1806	1684	1773	1484	1684	1950	1780

Made to measure Side hinged doors Golden Oak & Rosewood									
Size mm (ft/in) Width by Height	Bedford (1/2 - 1/2)	Berkeley Horizontal (1/2 - 1/2)	Berkeley Vertical (1/2 - 1/2)	Gatcombe (1/2 - 1/2)	Gemini (2/3 - 1/3) (1/2 - 1/2)	Georgian (2/3 - 1/3)	Sheraton II (1/2 - 1/2)	Sheraton II glazed (1/2 - 1/2)	Vogue (1/2 - 1/2)
1981 x 1981 (6'6" x 6'6")	-	1625	1625	1505	1625	1424	1505	1770	1736
1981 x 2134 (6'6" x 7'0")	-	1625	1625	1505	1625	1424	1505	1770	1750
1981 x 2286 (6'6" x 7'6")	-	1625	1625	1505	1625	1424	1505	1770	1750
2134 x 1981 (7'0" x 6'6")	1746	1625	1625	1505	1625	1424	1505	1770	1708
2134 x 2134 (7'0" x 7'0")	1829	1708	1708	1587	1708	1485	1587	1853	1783
2134 x 2286 (7'0" x 7'6")	1829	1708	1708	1587	1708	1485	1587	1853	1783
2286 x 1981 (7'6" x 6'6")	1887	1767	1767	1646	1767	1512	1646	1912	1815
2286 x 2134 (7'6" x 7'0")	1982	1861	1861	1741	1861	1575	1741	2006	1892
2286 x 2286 (7'6" x 7'6")	1982	1861	1861	1741	1861	1575	1741	2006	1892
2438 x 1981 (8'0" x 6'6")	2018	1897	1897	1777	1897	1592	1777	2043	1909
2438 x 2134 (8'0" x 7'0")	2051	1929	1929	1809	1929	1608	1809	2075	1929
2438 x 2286 (8'0" x 7'6")	2051	1929	1929	1797	-	1608	1809	2075	1929

Size availability (mm)

Minimum width	2134	1750	1750	1750	1750	1920	2012	2012	1750
Maximum width	2438	2438	2438	2438	2438	2438	2438	2438	2438
Minimum height	1775	1775	1775	1775	1775	1929	1850	1850	1775
Maximum height	2286	2286	2286	2286	2286	2134	2134	2134	2286

* Only 1981 & 2134 heights

Golden Oak & Rosewood side hinged doors - options









Unframed	deduct £388
Painted frame	add £25
Glazing (Bedford)	add £121 (Stippled) Black mock glazing standard
Glazing (Georgian)	add £293 (Stippled, Diamond Lattice, Square Lattice and Plain)
Left hand opening	add £68









Side hinged doors supplied with pre-finished white 50mm frame as standard. Doors supplied as standard right hand opening when viewed from outside. All side hinged doors are only available opening outwards.

All side hinged doors come complete with door stay.

All side hinged doors are bespoke and made to order.

Timber side hinged doors Futura range

Side hinged doors Timber									
Size mm (ft/in) Width by Height	Bedford (1/2 - 1/2)	Berkeley Vertical (1/2 - 1/2)	Chevron (1/2 - 1/2)	Garage Light (1/2 - 1/2)	Gatcombe (1/2 - 1/2)	Hampshire (1/2 - 1/2)	Ibstock (2/3 - 1/3)	Kent (1/2 - 1/2)	Vertical (1/2 - 1/2)
2134 x 1981 (7'0" x 6'6")	2103	1937	1947	2103	1937	2192	2234	2192	1826
2134 x 2134 (7'0" x 7'0")	2138	1947	1966	2138	1947	2216	2260	2216	1848
2286 x 1981 (7'6" x 6'6")	2256	1997	2073	2256	1997	2253	2388	2253	1877
2286 x 2134 (7'6" x 7'0")	2333	2034	2128	2333	2034	2296	2454	2296	1914
2438 x 1981 (8'0" x 6'6")	2410	2135	2222	2410	2135	2418	2549	2418	2014
2438 x 2134 (8'0" x 7'0")	2450	2186	2269	2450	2186	2479	2581	2479	2067

Made to measure Side hinged doors Timber									
Size mm (ft/in) Width by Height	Bedford (1/2 - 1/2)	Berkeley Vertical (1/2 - 1/2)	Chevron (1/2 - 1/2)	Garage Light (1/2 - 1/2)	Gatcombe (1/2 - 1/2)	Hampshire (1/2 - 1/2)	Ibstock (2/3 - 1/3)	Kent (1/2 - 1/2)	Vertical (1/2 - 1/2)
1981 x 1981 (6'6" x 6'6")	2139	1972	1983	2139	1972	2200	2271	2234	1862
2134 x 1981 (7'0" x 6'6")	2163	1984	2007	2163	1984	2264	2295	2264	1886
2134 x 2134 (7'0" x 7'0")	2198	2007	2027	2198	2007	2289	2320	2289	1907
2134 x 2286 (7'0" x 7'6")	2255	2047	2067	2255	2047	2375	2371	2375	1980
2286 x 1981 (7'6" x 6'6")	2315	2056	2134	2315	2056	2324	2449	2324	1938
2286 x 2134 (7'6" x 7'0")	2392	2094	2181	2392	2094	2369	2514	2369	1974
2286 x 2286 (7'6" x 7'6")	2463	2171	2247	2463	2171	2458	2595	2458	2048
2438 x 1981 (8'0" x 6'6")	2471	2195	2279	2471	2195	2489	2609	2489	2075
2438 x 2134 (8'0" x 7'0")	2510	2246	2330	2510	2246	2768	2642	2768	2126
2438 x 2286 (8'0" x 7'6")	2557	2311	2395	2557	2311	2628	2691	2628	2190

Size availability (mm)

Minimum width	1778	1778	1778	1778	1778	1778	1778	1778	1778
Maximum width	2438	2438	2438	2438	2438	2438	2438	2438	2438
Minimum height	1775	1775	1775	1775	1775	1775	1775	1775	1775
Maximum height	2286	2286	2286	2286	2286	2286	2286	2286	2286

Timber side hinged doors - options

Fully finished	add £144
Unframed	deduct £38
Painted frame	add £25
Left hand opening	add £73
Glazing (Bedford, Garage Light, Ibstock)	Stippled as standard
Glazing (Milton)	add £123 (Stippled, as standard)

Side hinged doors supplied with pre-finished conker brown 50mm frame as standard.
Doors supplied as standard right hand opening when viewed from outside.
All side hinged doors open outwards.

Chassis and fixing frames are supplied in Brown RAL8017.

All side hinged doors come complete with door stay.

All side hinged doors are bespoke and made to order.

Timber door fully finished options

Cardale fully finished option is a factory finish process, the Sikkens product used is available in six attractive colours as illustrated. For south facing situations exposed to strong sunlight the dark colours are not recommended, as they can store excessive heat and dry out. Timber doors are supplied with a basecoat stain as standard. They MUST be finished immediately after installation.





Fully finished double timber doors Add £238





Factory Finishes available:

Light oak
Burnt Oak
Rosewood
Walnut
Mahogany
Ebony

Frames ordered with a double door will be supplied as a separate knocked down item.









Timber side hinged doors Heritage range

Side hinged doors Timber				
Size mm (ft/in) Width by Height	Malvern (1/2 - 1/2)	Milton (1/2 - 1/2)	Rutland (1/2 - 1/2)	Shakespeare (1/2 - 1/2)
2134 x 1981 (7'0" x 6'6")	1797	1802	1713	1713
2134 x 2134 (7'0" x 7'0")	1830	1835	1745	1745
2286 x 1981 (7'6" x 6'6")	1855	1860	1770	1770
2286 x 2134 (7'6" x 7'0")	1879	1885	1796	1796
2438 x 1981 (8'0" x 6'6")	1998	2003	1914	1914
2438 x 2134 (8'0" x 7'0")	2055	2061	1972	1972

Made to measure Side hinged doors Timber				
Size mm (ft/in) Width by Height	Malvern (1/2 - 1/2)	Milton (1/2 - 1/2)	Rutland (1/2 - 1/2)	Shakespeare (1/2 - 1/2)
1981 x 1981 (6'6" x 6'6")	1892	1897	1800	1800
2134 x 1981 (7'0" x 6'6")	1916	1923	1833	1833
2134 x 2134 (7'0" x 7'0")	1949	1955	1866	1866
2134 x 2286 (7'0" x 7'6")	1982	1988	1897	1897
2286 x 1981 (7'6" x 6'6")	1974	1980	1891	1891
2286 x 2134 (7'6" x 7'0")	1999	2006	1915	1915
2286 x 2286 (7'6" x 7'6")	2025	2031	1941	1941
2438 x 1981 (8'0" x 6'6")	2118	2124	2034	2034
2438 x 2134 (8'0" x 7'0")	2176	2181	2091	2091
2438 x 2286 (8'0" x 7'6")	2234	2240	2149	2149

Size availability (mm)

Minimum width	1778	1778	1778	1778
Maximum width	2438	2438	2438	2438
Minimum height	1775	1775	1775	1775
Maximum height	2286	2286	2286	2286

Single doors GRP									
	Chelsea II glasswhite C R	Georgian II glasswhite C R	Hambleton II glasswood C R	Lyndhurst II glasswood C R	Nelson glasswood C R	Sutherland glasswood C R	Virginia glasswood C R	Winchester glasswood C R	Kingston C R
2134 x 1981 (7'0" x 6'6")	1635 1691	1414 1470	1601 1658	1601 1658	1601 1658	1901 1958	1601 1658	1601 1658	1601 1658
2134 x 2134 (7'0" x 7'0")	1635 1691	1414 1470	1601 1658	1601 1658	1601 1658	1901 1958	1601 1658	1601 1658	1601 1658
2286 x 1981 (7'5" x 6'6")	1796 1853	1497 1554	1842 1900	1842 1900	1842 1900	1945 2002	1842 1900	1842 1900	1842 1900
2286 x 2134 (7'5" x 7'0")	1796 1853	1497 1554	1842 1900	1842 1900	1842 1900	1945 2002	1842 1900	1842 1900	1842 1900
2286 x 1981 (7'6" x 6'6")	1796 1853	1497 1554	1842 1900	1842 1900	1842 1900	1945 2002	1842 1900	1842 1900	1842 1900
2286 x 2134 (7'6" x 7'0")	1796 1853	1497 1554	1842 1900	1842 1900	1842 1900	1945 2002	1842 1900	1842 1900	1842 1900
2438 x 1981 (8'0" x 6'6")	1857 1914	1557 1614	1903 1960	1903 1960	1903 1960	2003 2060	1903 1960	1903 1960	1903 1960
2438 x 2134 (8'0" x 7'0")	1857 1914	1557 1614	1903 1960	1903 1960	1903 1960	2003 2060	1903 1960	1903 1960	1903 1960

Made to measure - Take next size up for price

Size availability (mm)

Minimum width	2032 2032	2032 2032	2032 2032	2032 2032	1981 1981	2134 2134	1524 1524	1829 1829	2134 2134
Maximum width	2438 2438	2540 2540	2438 2438	2438 2438	2380 2380	2438 2438	2438 2438	2286 2286	2540 2540
Minimum height	1880 1880	1880 1880	1880 1880	1880 1880	1981 1981	1931 1931	1829 1829	1829 1829	1981 2032
Maximum height	2134 2134	2286 2286	2134 2134	2286 2286	2134 2134	2134 2134	2286 2286	2438 2438	2286 2286

C = Canopy gear, R = Retractable gear.

GRP single doors - options

Draught strip	£37
Standard frame	£116 (Pre-finished or white painted)
Coloured frame	£158 (Coloured paint)
Glazing (Lyndhurst II)	£165 (Stippled) Black mock glazing standard
Glazing (Sutherland)	£254 (Stippled or plain) Black mock glazing standard
Glazing (Georgian II)	Plain black, Stippled, Transparent, Diamond lattice, Queen Anne lattice, Square lattice (add £258)
Glazing (Chelsea II)	£270

Woodgrain colour options standard as price list

White, Magnolia, Bleached Oak, Red Mahogany, Light Oak, Dark Oak, Honey Beech, Teak, Rosewood, Dark Mahogany Golden Brown, Ebony, Irish Oak, Anthracite Grey







Woodgrain colour options at additional cost

Blue, Red, Green	£223
RAL colour of your choice	£278

High Gloss colour options standard as price list

Gloss White and Gloss Magnolia

All GRP doors are bespoke and made to order.

Double doors GRP							
	Chelsea II glasswhite R	Georgian II glasswhite R	Hambleton II glasswood R	Lyndhurst II glasswood R	Nelson glasswood R	Sutherland glasswood R	Virginia glasswood R
2743 x 1981 (9'0" x 6'6")	-	2079	-	2255	-	-	2255
2743 x 2134 (9'0" x 7'0")	-	2079	-	2255	-	-	2255
3048 x 1981 (10'0" x 6'6")	-	2274	-	2451	-	-	2451
3048 x 2134 (10'0" x 7'0")	-	2274	-	2451	-	-	2451
3353 x 1981 (11'0" x 6'6")	-	2541	-	2688	-	-	2688
3353 x 2134 (11'0" x 7'0")	-	2541	-	2688	-	-	2688
3658 x 1981 (12'0" x 6'6")	-	2738	-	3004	-	-	3004
3658 x 2134 (12'0" x 7'0")	-	2738	-	3004	-	-	3004
3962 x 1981 (13'0" x 6'6")	-	2789	-	3106	-	-	3106
3962 x 2134 (13'0" x 7'0")	-	2789	-	3106	-	-	3106
4267 x 1981 (14'0" x 6'6")	3011	2733	3138	3138	3138	3177	3138
4267 x 2134 (14'0" x 7'0")	3011	2733	3138	3138	3138	3177	3138
4572 x 1981 (15'0" x 6'6")	3511	3235	3591	3591	3591	-	3591
4572 x 2134 (15'0" x 7'0")	3511	3235	3591	3591	3591	-	3591
4877 x 1981 (16'0" x 6'6")	-	3712	3949	3949	3949	-	3949
4877 x 2134 (16'0" x 7'0")	-	3712	3949	3949	3949	-	3949

Size availability (mm)

Minimum width	4115	2743	4115	2743	4115	4267	2438
Maximum width	4572	4877	4724	4877	4267	4724	4877
Minimum height	1880	1880	1880	1880	1981	1931	1829
Maximum height	2134	2286	2134	2134	2134	2134	2286

R = Retractable gear.

GRP double doors - options

Draught strip	£37
Standard frame	£313 (Pre-finished or white painted)
Coloured frame	£288 (Coloured paint)
Glazing (Lyndhurst II)	£165 (Stippled) Black mock glazing standard
Glazing (Sutherland)	£254 (Stippled or plain) Black mock glazing standard
Glazing (Georgian II)	Plain black, Stippled, Transparent, Diamond lattice, Queen Anne lattice, Square lattice (add £258)
Glazing (Chelsea II)	£270

Woodgrain colour options standard as price list

White, Magnolia, Bleached Oak, Red Mahogany, Light Oak, Dark Oak, Honey Beech, Teak, Rosewood, Dark Mahogany Golden Brown, Ebony, Irish Oak, Anthracite Grey

Woodgrain colour options at additional cost

Blue, Red, Green	add £223
RAL colour of your choice	add £278





High Gloss colour options standard as price list

Gloss White and Gloss Magnolia

All GRP doors are bespoke and made to order.

Frames ordered with a double door will be supplied as a separate knocked down item.

GRP side hinged doors

Side hinged doors GRP	 Sutherland* glasswood (1/2 - 1/2)	 Lyndhurst* glasswood (1/2 - 1/2)	 Virginia glasswood (1/2 - 1/2)	 Georgian II glasswhite* (1/2 - 1/2)
For available sizes see below	1950	1800	1800	1800

NEW Doors

Size availability (mm)

	2134	2134	1830	2134
Minimum width	2134	2134	1830	2134
Maximum width	2438	2438	2438	2438
Minimum height	1930	1930	1830	1930
Maximum height	2134	2134	2134	2134

All side hinged doors come complete with door stay.

All side hinged doors are bespoke and made to order.

GRP side hinged doors - options

Unframed	deduct £38
Painted frame	add £25
Glazing (Sutherland)	add £121 (Stippled) Black mock glazing standard
Glazing (Lyndhurst)	add £293 (Stippled, Diamond Lattice, Square Lattice and Plain)
Glazing (Georgian Glasswhite)	add £293 (Stippled, Diamond Lattice, Square Lattice and Plain)
Painted door	add £116
Left hand opening	add £68

Side hinged doors supplied with pre-finished white 50mm frame as standard.
Doors supplied as standard right hand opening when viewed from outside.
All side hinged doors are only available opening outwards.

GRP personnel door

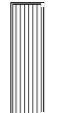
Personnel door GRP	 Virginia glasswood
For available sizes see below	1100

NEW Door

Size availability (mm)

	720
Minimum width	720
Maximum width	1220
Minimum height	1930
Maximum height	2134

Personnel door - options

Unframed	deduct £17
Painted frame	£24
Painted door	£109

50mm frame available at no extra cost







Personnel doors are supplied with pre-finished white frame as standard







Made to measure - take next size up and add £58

All Personnel doors are bespoke and made to order.

ABS doors

single doors & made to measure single doors

Single doors ABS	 Bedford		 Jacobean		 President		 Regal		 Senator		 Vertical	
	C	R	C	R	C	R	C	R	C	R	C	R
2134 x 1981 (7'0" x 6'6")	1037	1091	943	997	1037	1091	898	952	943	997	695	749
2134 x 2134 (7'0" x 7'0")	1037	1091	943	997	1037	1091	898	952	943	997	695	749
2286 x 1981 (7'6" x 6'6")	1128	1182	1130	1184	1130	1184	993	1047	1037	1091	777	831
2286 x 2134 (7'6" x 7'0")	1130	1184	1130	1184	1130	1184	993	1047	1037	1091	777	831
2438 x 1981 (8'0" x 6'6")	1223	1277	1130	1184	1223	1277	1087	1141	1130	1184	861	915
2438 x 2134 (8'0" x 7'0")	1223	1277	1130	1184	1223	1277	1087	1141	1130	1184	861	915

Made to measure doors Pre-finished white or ABS or Golden Oak & Rosewood	 Bedford		 Jacobean		 President		 Regal		 Senator		 Vertical	
	C	R	C	R	C	R	C	R	C	R	C	R
1981 (6'6")	1173	1227	1083	1137	1173	1227	1037	1091	1083	1137	820	875
2134 (7'0")	1173	1227	1083	1137	1173	1227	1037	1091	1083	1137	820	875
2286 (7'6")	1269	1323	1173	1227	1269	1323	1130	1184	1173	1227	904	958
2438 (8'0")	1363	1418	1269	1323	1363	1418	1223	1277	1231	1286	984	1038

Size availability (mm)

				3 panel	4 panel	
Minimum width	2032	1991	1959	1981	2016	1780
Maximum width	2500	2500	2500	2500	2500	2500
Minimum height	1860	1860	1981	1981	1860	1860
Maximum height	2185	2185	2185	2185	2185	2286

For made to measure sizes go to the next standard size.

C = Canopy gear, R = Retractable gear.

ABS single doors - options

Standard frame	add £116 (Pre-finished or white painted)
Coloured frame	add £159 (Coloured paint)
Cardale DC650T operator	add £444
Cardale DC800T operator	add £575
Glazing (Bedford)	add £151 (Stippled) Black mock glazing standard
Glazing (President)	add £232 (Stippled or plain) Black mock glazing standard
Glazing (Senator)	Plain black, Stippled, Transparent, Diamond lattice, Queen Anne lattice, Square lattice (add £246)

Optional extras for operators

Extra handsets	add £67 (2 channel) add £73 (4 channel)
Wireless key pad	add £184
External manual override	add £42
Keyswitch	add £45

Steel chassis and fixing frames are supplied in RAL9016 white.

All ABS doors are bespoke and made to order.

Please check availability of minimum and maximum sizes on the table above before you order.

Personnel doors

Personnel doors	Pre-finished steel			Golden Oak & Rosewood			ABS	
	Size mm (ft/in)	Door opening size	Brompton	Europa II	Gemini	Brompton	Europa II	Gemini
762 x 1981 [2'6" x 6'6"]	892 x 2049 [2'11¼" x 6'8¾"]	585	576	576	749	741	741	826
762 x 2134 [2'6" x 7'0"]	892 x 2202 [2'11¼" x 7'2¾"]	585	576	576	749	741	741	826
914 x 1981 [3'0" x 6'6"]	1044 x 2049 [3'4½" x 6'8¾"]	716	705	705	881	870	870	-
914 x 2134 [3'0" x 7'0"]	1044 x 2202 [3'4½" x 7'2¾"]	716	705	705	881	870	870	-
1219 x 1981 [4'0" x 6'6"]	1349 x 2049 [4'4½" x 6'8¾"]	875	795	795	1040	960	960	-
1219 x 2134 [4'0" x 7'0"]	1349 x 2202 [4'4½" x 7'2¾"]	875	795	795	1040	960	960	-

Size availability (mm)

Minimum width	756	419	419	756	419	419	580
Maximum width	1067	1219	1219	1067	1219	1219	800
Minimum height	1829	1829	1829	1829	1829	1829	1981
Maximum height	2134	2286	2286	2134	2286	2286	2210

Personnel doors - options

Unframed	deduct £17
Painted frame	£24
Painted door	£109
Security & draught fur pack	£143
Glazing (Brompton)	£106 (Stippled or Plain)
Glazing (Regal)	£106 (Stippled, Plain, Diamond Lattice, Square Lattice)

50mm frame available at no extra cost

Personnel doors are supplied with pre-finished white frame as standard

Made to measure - take next size up and add £58

All Personnel doors are bespoke and made to order.

Steele roller doors

Height mm (ft/in)	Curtain width 'A' Series Opening +50mm (2in) minimum						Curtain width 'AA' Series Opening +100mm (4in) minimum								
	2185 7'2"	2337 7'8"	2489 8'2"	2642 8'8"	2794 9'2"	2946 9'8"	3099 10'2"	3251 10'8"	3404 11'2"	3556 11'8"	3758 12'4"	4063 13'4"	4368 14'4"	4673 15'4"	4978 16'4"
2134 (7'0")	915	939	942	1037	1070	1205	1248	1373	1474	1668	1782	1933	2048	2248	2424
2438 (8'0")	1025	1049	1032	1124	1170	1248	1335	1462	1560	1824	1950	2162	2372	2505	2640
2743 (9'0")	1148	1180	1185	1272	1317	1370	1490	1665	1818	2015	2171	2400	2527	-	-
3048 (10'0")	1297	1375	1352	1429	1460	1511	1641	1860	2072	2292	2477	2621	2899	-	-

Ordering notes

Steel-line doors are designed to fit behind the brickwork opening, allowing clear drive-through width*. Please therefore order by the curtain size, ensuring that the curtain width is greater than the opening by:

Series	Curtain width
'A' Series	Opening + 50mm (2") minimum

'AA' Series (solid areas) Opening + 100mm (4") minimum * The drive-through height is 80mm less than the nominal opening height

Mini Steeline roller doors

fits in 9" headroom - available in all Cardale colours

Height mm (ft/in)	Curtain width mm (ft/in)					
	2185 7'2"	2337 7'8"	2489 8'2"	2642 8'8"	2794 9'2"	3099 10'2"
2134 (7'0")	956	982	991	1077	1122	1266

Textured Golden Oak or Rosewood - add 20% , Mahogany Woodgrain - add 7%. Doors are designed to fit behind the reveal. Doors are supplied with a lock hole unless specified otherwise.

Sizes listed are the ordering sizes. These are the curtain sizes.

All Steeline roller doors are bespoke and made to order.

Steele roller door options

Slimline slimdrive operator	£566
Complete lock replacement	£60
Replacement key	£15
Touch up paint	£21
Odd width cut down (applicable to doors under 4' wide)	£94
Non standard brackets	£69
Brush seal for header (3m length)	£195

Standard colours

White, Anthracite, Vandyke Brown, Black, Goosewing Grey, Merlin Grey, Olive Green, Juniper Green, Burgundy, Mushroom, Honesty Cream, Heritage Green, Solent Blue, Golden Oak, Rosewood

Thermaglide roller doors

Thermaglide 77mm insulated roller doors

Coloured

Guide height mm (ft/in)	Over guide width up to mm (ft/in)						
	1981 (6'6")	2500 (8'2¾")	3000 (9'10½")	3500 (11'5¼")	4000 (13'1½")	4600 (15'1½")	5000 (16'4")
1981 (6'6")	1348	1447	1588	1705	1931	2069	2373
2134 (7'0")	1368	1463	1602	1713	1946	2160	2439
2286 (7'6")	1405	1513	1648	1749	2105	2275	2536
2438 (8'0")	1444	1535	1738	1771	2090	2346	2526
2591 (8'6")	1533	1708	1805	1895	2280	2435	2795
2743 (9'0")	1595	1735	1849	1918	2352	2740	2930

Woodgrain

Guide height mm (ft/in)	Over guide width up to mm (ft/in)						
	1981 (6'6")	2500 (8'2¾")	3000 (9'10½")	3500 (11'5¼")	4000 (13'1½")	4600 (15'1½")	5000 (16'4")
1981 (6'6")	1610	1783	1972	2146	2445	2710	3000
2134 (7'0")	1741	1777	1967	2134	2479	2740	3078
2286 (7'6")	1805	1858	2047	2200	2506	2837	3168
2438 (8'0")	1860	1899	2165	2316	2604	3022	3281
2591 (8'6")	2075	2165	2345	2582	2886	3266	3493
2743 (9'0")	2253	2345	2386	2527	3033	3213	4080

Door widthmm (ft/in)	1981 (6'6")	2500 (8'2¾")	3000 (9'10½")	3500 (11'5¼")	4000 (13'1½")	4600 (15'1½")	5000 (16'4")
Half box	130	142	155	168	187	200	220
Full box	207	213	240	271	298	336	369

Thermaglide 77 doors are supplied with colour matched guide rails as standard. Up to 3 metre - 70mm guide rails. Over 3 metre - 90mm guide rails.

Boxes are supplied white as standard. All Thermaglide77 doors are supplied as standard with 270mm steel headplates that are not suitable for half or full box. Half or full boxes are supplied with 300mm steel headplates.

Thermaglide 55mm insulated roller doors

Coloured

Guide height mm (ft/in)	Over guide width up to mm (ft/in)		
	1981 (6'6")	2500 (8'2¾")	2896 (9'5")
1981 (6'6")	1464	1539	1613
2134 (7'0")	1488	1514	1684
2286 (7'6")	1559	1654	1794
2438 (8'0")	1755	1802	1929

Woodgrain

Guide height mm (ft/in)	Over guide width up to mm (ft/in)		
	1981 (6'6")	2500 (8'2¾")	2896 (9'5")
1981 (6'6")	1738	1847	2148
2134 (7'0")	1738	1873	2236
2286 (7'6")	1972	1914	2272
2438 (8'0")	1990	2043	2261

Thermaglide 55 doors are supplied with 65mm colour matched guide rails and full box as standard.

Boxes are supplied white as standard.

All Thermaglide roller doors are bespoke and made to order.

Thermaglide roller door - options

Emergency manual override	£155	Wireless key pad	£190
Handset 1 button	£56	40Db alarm*	£105
Handset 4 button	£74	Wired key switch	£56
Wired push button	£14	Vision lath	£35/m
Coloured matched box	£46/m	Vented lath	£31/m
Wireless push button	£83		

Thermaglide 77 low maintenance powdercoat finishes

White RAL 9016, Mocca RAL 8019, Black RAL 9011, Burgundy RAL 3004, Racing Green RAL 6009, Blue RAL 5011, Beige RAL1019, Chartwell Green RAL 6021, Anthracite Grey RAL 7016, Rosewood, Golden Oak

Thermaglide 77 high grade woodgrain laminate finishes

Black, Anthracite Grey, Golden Oak, Rosewood, Moss Green, Mahogany, Steel Blue

Thermaglide 55 low maintenance powdercoat finishes

White RAL 9016, Mocca RAL 8019, Black RAL 9011, Burgundy RAL 3004, Racing Green RAL 6009, Blue RAL 5011, Anthracite Grey RAL 7016, Golden Oak

Thermaglide 55 weathergrain wood laminate finishes

Rosewood, Golden Oak

Sectional iso45 Overhead Garage Doors

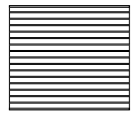

Horizontal Rib
Woodgrain only

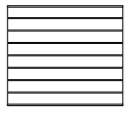

Large Rib



Flush

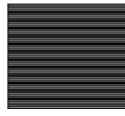

Microline

Not available on heights between 2135mm and 2199mm.

iso45 ribbed

Intermediate height or width combination Next size +£125
standard heights

standard widths

		2084	2134	2235	2286	2388	2438	2591	2743	3048	3353	3658	3962	4216	4267	4420	4572	4877	5182	5500
		6'10"	7'0"	7'4"	7'6"	7'10"	8'0"	8'6"	9'0"	10'0"	11'0"	12'0"	13'0"	13'10"	14'0"	14'6"	15'0"	16'0"	17'0"	18'0"
1875 6'2"	White-Woodgrain/Smooth	923	958	971	971	971	1018	1009	1100	1142	1301	1523	1578	1640	1646	1646	1725	1798	2422	2645
1925 6'4"	Super Colour-Woodgrain/Smooth	1173	1173	1189	1189	1266	1277	1304	1350	1429	1805	1879	1945	1926	1926	2086	2184	2271	2723	2965
2050 6'9"	Rustic wood effect Golden Oak/Rosewood	1258	1261	1267	1270	1349	1352	1331	1434	1520	1805	1981	2100	1974	1974	1985	2184	2237	2723	2965
2075 6'10"	RAL-Woodgrain/Smooth/Satin Grey	1383	1390	1400	1407	1492	1498	1580	1598	1703	2006	2211	2338	2133	2138	2157	2459	2529	2905	3154
2125 7'0"	Flush Satin White/Satin Brown/ Satin Dark Grey Microline Satin White/Satin Grey	1383	1390	1400	1407	1492	1498	1580	1598	1703	2006	2211	2338	2133	2138	2157	2459	2529	2905	3154
2250 7'4"	Rustic wood effect Winchester/Moor Oak/Black Oak/Dark Oak	1432	1438	1449	1456	1541	1548	1630	1647	1752	2052	2260	2387	2181	2187	2206	2508	2578	2954	3202

2375 7'9"	White Woodgrain/Smooth	1574	1574	1609	1609	1655	1655	1877	1877	2215	2215	2453	2453	2647	2647	2647	2841	3060	3226	3483
	Super Colour Woodgrain/Smooth	1738	1743	1784	1788	1842	1848	2082	2095	2457	2480	2738	2766	2980	2984	2996	3201	3445	3638	3814
	Rustic wood effect Golden Oak/Rosewood	1738	1743	1784	1788	1842	1848	2082	2095	2457	2480	2738	2766	2980	2984	2996	3201	-	-	-
	RAL Painted Woodgrain/Smooth	1825	1833	1882	1889	1949	1957	2193	2218	2587	2635	2909	2956	3180	3187	3212	3421	3678	3883	4177
	Flush Satin White/Satin Brown/ Satin Dark Grey Microline Satin White/Satin Grey	1825	1833	1882	1889	1949	1957	2193	2218	2587	2635	2909	2956	3180	3187	3212	3421	3678	3883	-
2500 8'2"	Rustic wood effect Winchester/Moor Oak/Black Oak/Dark Oak	1874	1882	1930	1939	1998	2006	2243	2266	2636	2684	2957	3005	3229	3236	3261	3469	3727	3932	4226

2750 9'0"	White Woodgrain/Smooth	1962	1962	1962	2026	2082	2082	2291	2291	2551	2721	2774	3035	3261	3257	3257	3462	3650	3748	3998
	Super Colour Woodgrain/Smooth	2189	2205	2257	2261	2396	2400	2583	2686	2913	3141	3219	3352	3588	3591	3783	3834	4085	4204	4437
	Rustic wood effect Golden Oak/Rosewood	2189	2205	2257	2261	2396	2400	2583	2686	2913	3141	3219	3352	3588	3591	3783	3834	-	-	-
	RAL Painted Woodgrain/Smooth	2378	2385	2445	2454	2598	2607	2804	2918	3172	3426	3530	3688	3944	3953	3978	4222	4344	4607	4791
	Flush Satin White/Satin Brown/ Satin Dark Grey Microline Satin White/Satin Grey	2378	2385	2445	2454	2598	2607	2804	2918	3172	3426	3530	3688	3944	3953	3978	4222	4344	4607	-
3000 9'9"	Rustic wood effect Winchester/Moor Oak/Black Oak/Dark Oak	2426	2434	2494	2504	2647	2655	2852	2967	3220	3475	3579	3737	3993	4002	4027	4271	4393	4656	4873

Dark Oak is available in Large Rib Smooth and Flush Smooth and Panelled Woodgrain.
iso 45 sectional doors up to 2125mm 4 panels high, up to 2500mm 5 panels high, up to 3000mm 6 panels high.
iso 45 sectional doors have an insulation value of k= 0.5 W/mK

Optional extras - Sectional iso20/45 Overhead Garage Doors



V1
Plain
clear / crystal



V2
Rhombus
clear / crystal



V3
Cross
clear / crystal



V4d
Diamond leaded
clear / crystal



V4s
Square leaded
clear / crystal

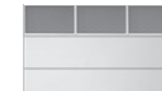

V7 - Light Strip



V8 - Portholes



V8 - Square

African Okoume option for timber overhead sectional doors. Per m² **Add £89**
Wicket Doors - iso 45 for horizontal rib, large rib and flush (woodgrain white and smooth finish) size exceptions occur, check when ordering. **Add £1067**

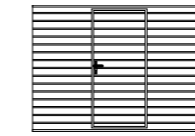

Wicket Door - Horizontal Rib

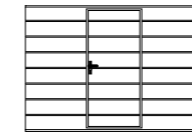

Wicket Door - Large Rib

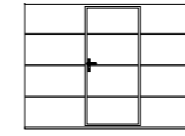

Wicket Door - Flush

Manual Locking with Black 'D' handle

Add £48

Metallic 'D' handles
(White, Brass, Silver and Antique Bronze effect)

Add £105

Metallic lever door handles
(White, Brass, Silver and Antique bronze effect)

Add £162

Low head rear mount kit for iso 45 doors where required.

Add £112



Aluminium Renovation Profile

For all types of Cardale sectional overhead doors.
Allows the door to be fitted at the front of the opening and overlapping onto outer brickwork structure (conceals poor brickwork).

Add £428

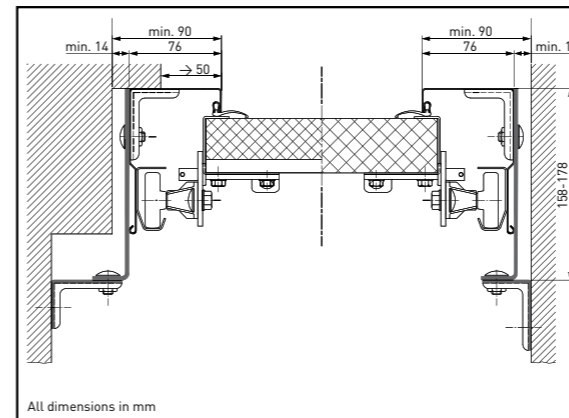

All dimensions in mm

Between fix frame brackets (rear mount doors only) Use when fitting between aperture or limited sideroom. Bridges bricks or insulation cavity.

Pack of ten **Add £62**

Ventilation grill
to suit iso45

Add £34

Sunrise Pattern Glazing -

iso45 panelled doors, standard sizes Available in white RAL9016 or brown RAL8014

Co-ord. width 2,000 - 2,600 mm



Add £330

Co-ord. width 2,601 - 3,500 mm



Add £438

Co-ord. width 3,501 - 4,000 mm*



Add £548

Co-ord. width 4,001 - 4,500 mm



Add £656

Co-ord. width 4,501 - 5,500 mm*



Add £711

Delivery for Sunrise glazing 2-3 weeks (items marked * delivery 6 weeks).

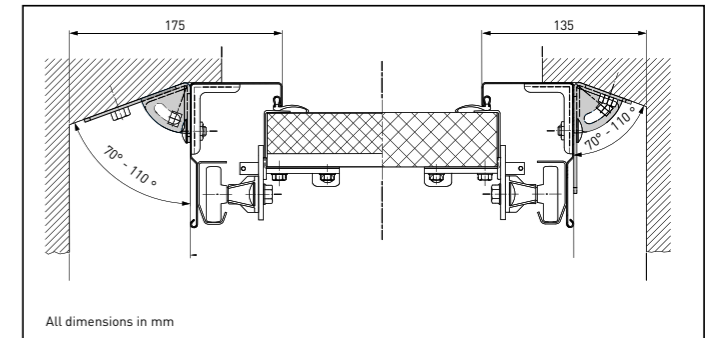

All dimensions in mm

3 dimensional fitting brackets

Perfect fixing brackets for door frames in case of slanted side walls, often used for pre-fabricated concrete garages. Fixing bracket adjustable from 70 - 110°.

Pack of ten **Add £62**

Technical information

Up and over garage doors. Canopy gear type

Door height			=H1+50	=H1-20	=H1-90				
imp	mm	H1	H2	H3	H4	H5	H6	R	C
6'4"	1931	1931	1981	1911	1841	1300	57	675	625
6'6"	1981	1981	2031	1961	1891	1300	57	725	657
6'10"	2085	2085	2135	2065	1995	1300	57	825	775
7'0"	2134	2134	2184	2114	2044	1300	57	880	825

H1 = Internal Frame Height

H2 = Minimum Height from floor to underside of ceiling

H3 = Minimum Brickwork Opening Height

H4 = Clear Drive Through Height (Internal Hand le is the lowest point)

H5 = How far the door extends into the garage from the back of the brickwork opening

H6 = Kick Up (The height above the Internal Frame Height the door panel rises during the opening cycle)

R = The Arc of travel of the bottom edge of the door

C = The canopy (How far the door protrudes from the frame front)

Note:- The Kick up is greater than the frame Lintel Height and peaks above the Lintel at 1100mm into the garage from the frame front

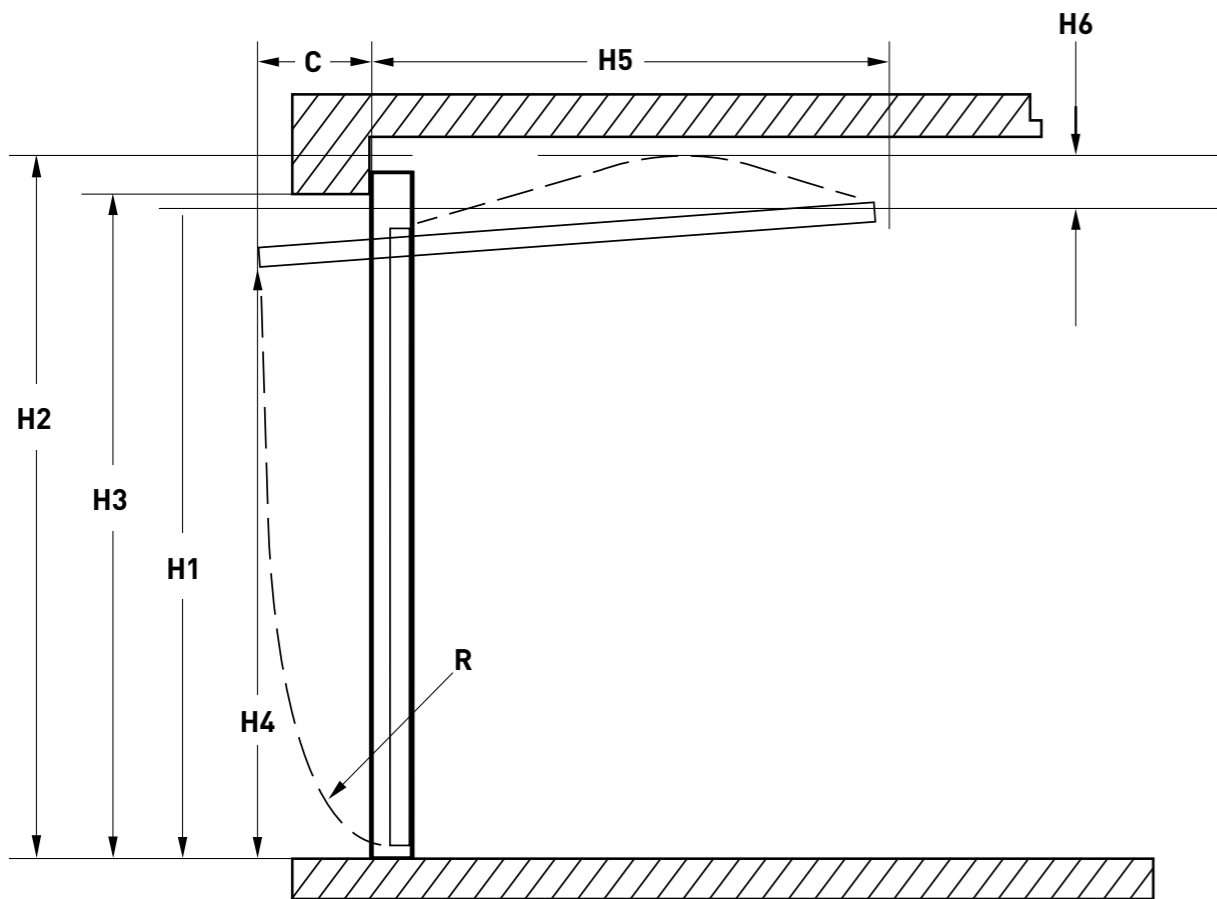

Technical information

Up and over garage doors. Canopy gear type

Door width		Common dimensions			54mm wide frame	70mm wide frame
imp	mm	W1	W2	W3	W4	W4
6'10"	2085	2085	2193	2109	2199	2231
7'0"	2134	2125	2233	2149	2239	2271
7'3"	2210	2210	2318	2234	2324	2356
7'5"	2261	2261	2369	2285	2375	2407
7'6"	2286	2286	2394	2310	2400	2432
8'0"	2438	2440	2548	2548	2554	2586

W1 = Internal Frame Width

W2 = Overall Frame Size Width

W3 = Minimum Brickwork Opening (fitting behind)

W4 = Recommended Brickwork Opening Width

Fitting behind the opening

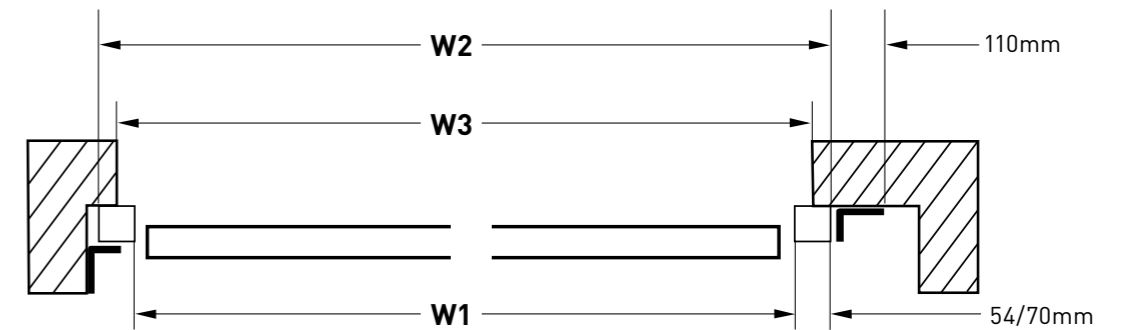

Fitting within the opening

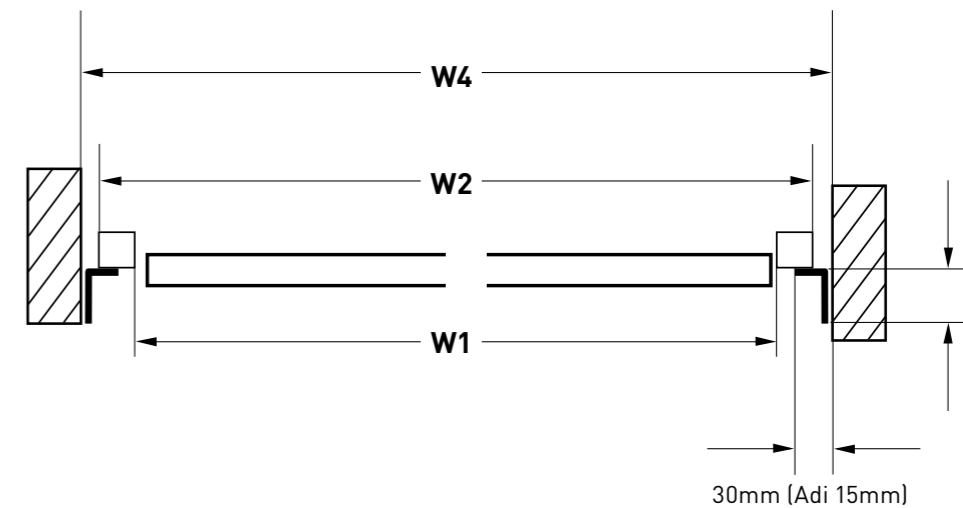

Technical information

Up and over garage doors. Single retractable gear type

Door height			=H1+45	=H1-20	=H1-90			
imp	mm	H1	H2	H3	H4	H5	R	C
6'6"	1981	1981	2025	1961	1860	1735	750	225
7'0"	2134	2134	2180	2114	2010	1890	870	265

H1 = Internal Frame Height

H2 = External Frame Height

H3 = Minimum Brickwork Opening Height

H4 = Clear Drive Through Height (internal handle is the lowest point)

H5 = How far the door extends into the garage

R = The arc of travel of the bottom edge of the door

C = The canopy (how far the door protrudes from the frame front)

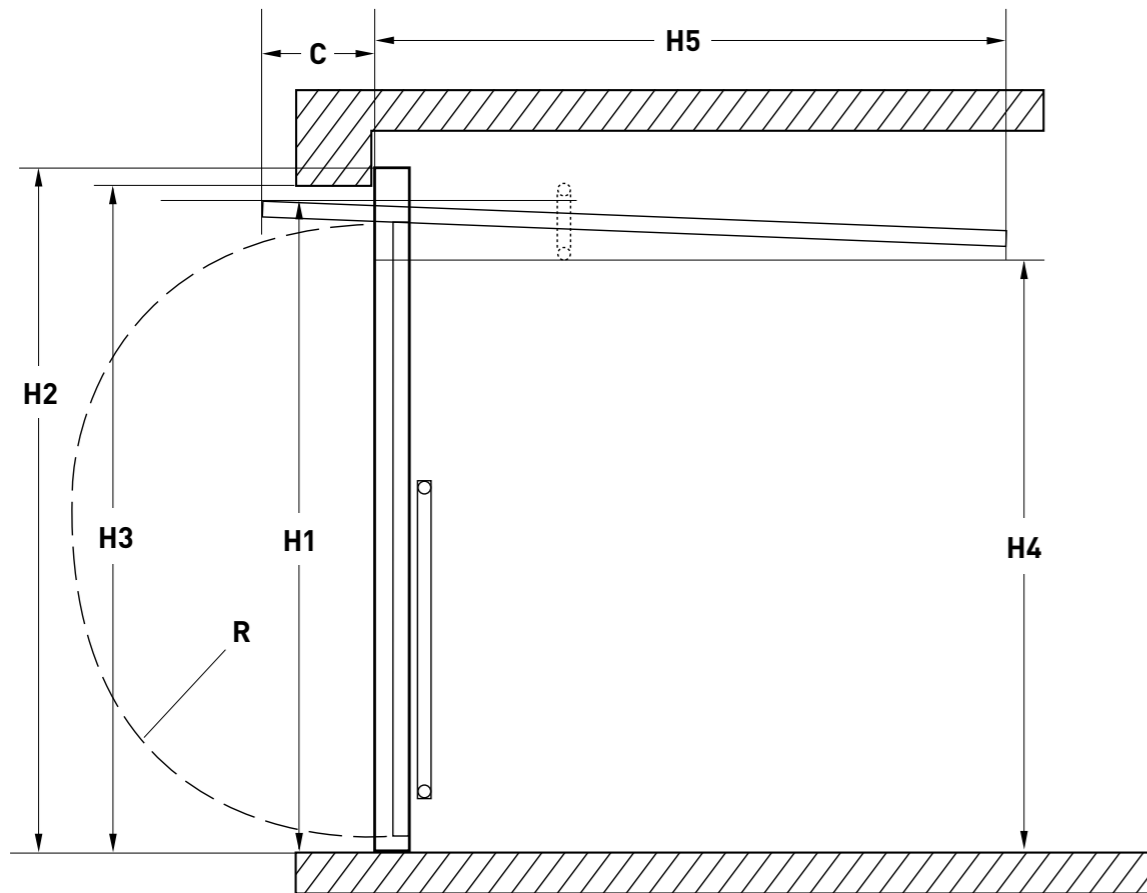

Technical information

Up and over garage doors. Single retractable gear type

Door width		common dimensions				70mm wide frame	
imp	mm	W1	W2	W3A	W3B	W4	W5
6'10"	2085	2085	2109	1985	2049	2225	2245
7'0"	2134	2134	2158	2034	2098	2274	2294
7'3"	2210	2210	2234	2110	2174	2350	2370
7'5"	2261	2261	2285	2161	2225	2381	2421
7'6"	2286	2286	2310	2186	2250	2426	2446
8'0"	2438	2438	2462	2338	2402	2580	2598

W1 = Internal Frame Width

W2 = Minimum Brickwork Opening (fitting behind)

W3A = Clear Drive through Width – Above the Crank of the Pivot Arm

W3B = Clear Drive through Width – Below the Crank of the Pivot Arm

W4 = External Frame Width

W5 = Recommended Brickwork Opening Width (fitting between)

NOTE – The crank in the pivot arm is

1000mm from the floor on a 1981mm high door

1100mm from the floor on a 2134mm high door

Fitting behind the opening

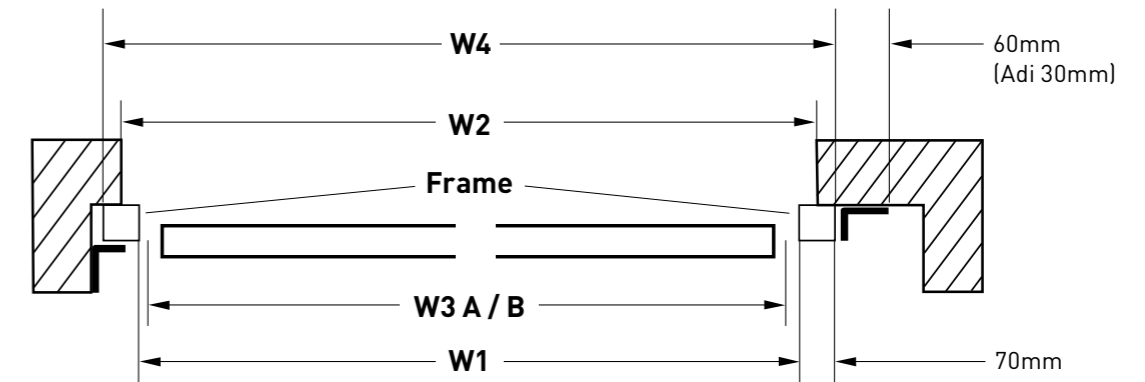

Fitting within the opening

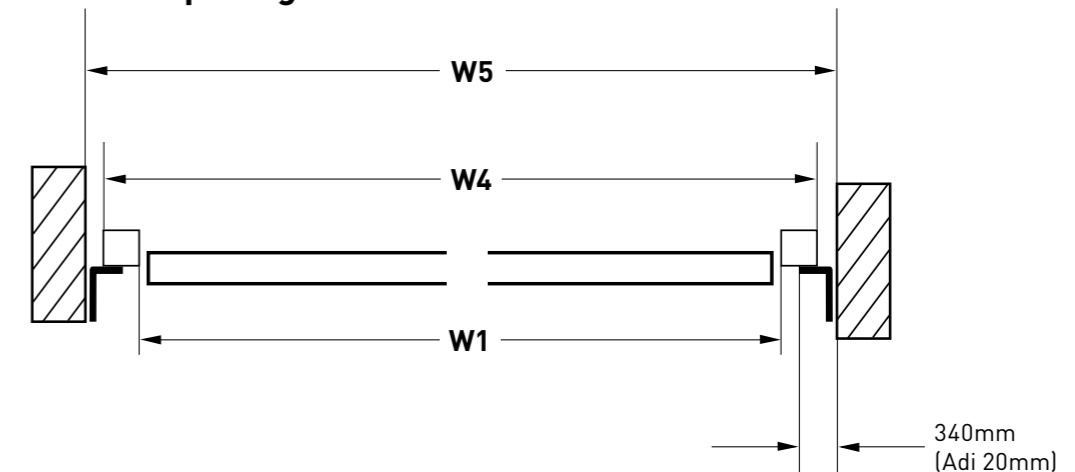

Technical information

iso20 Overhead Sectional garage doors

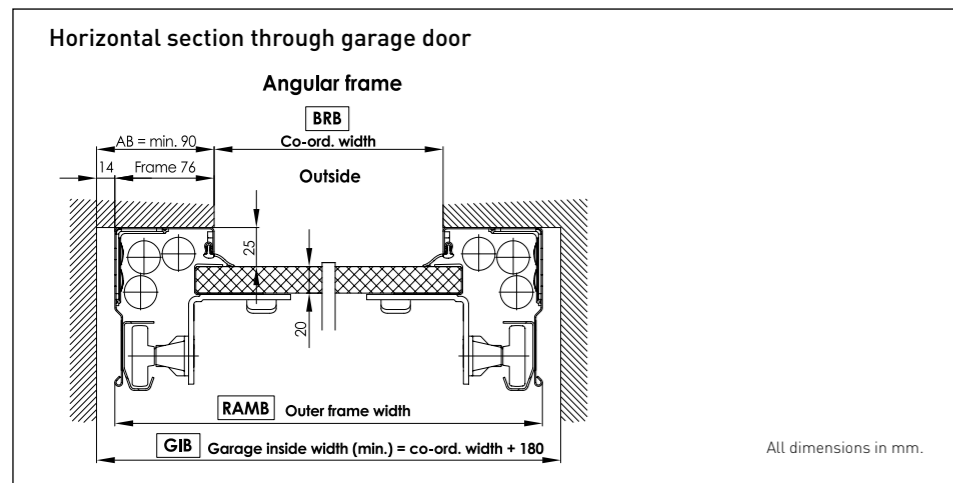
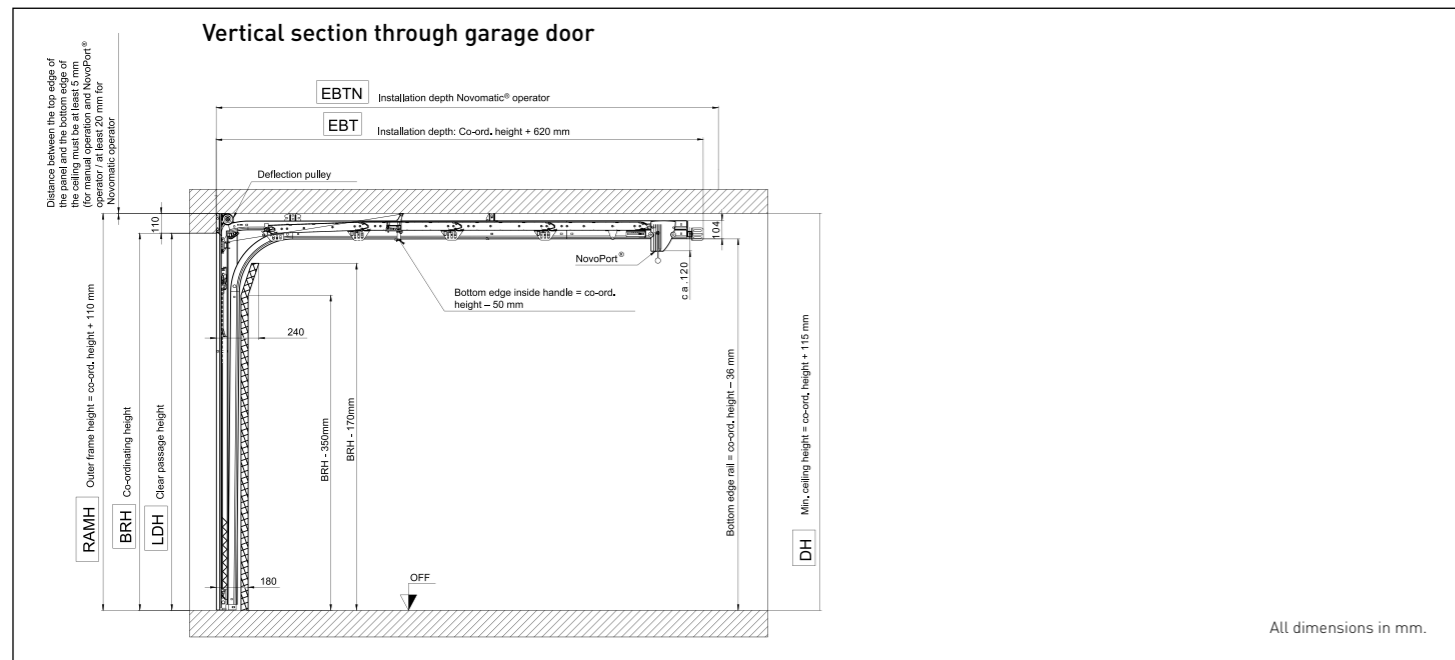
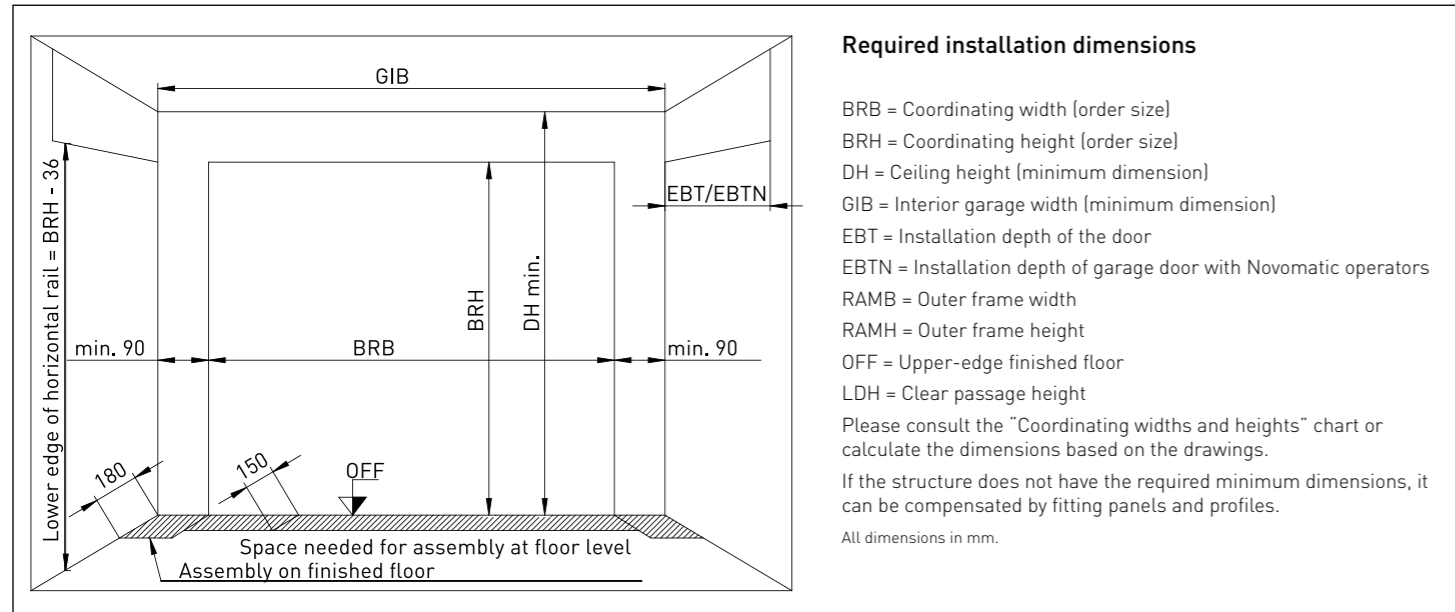

Ordering information

To calculate the correct door order size to fit within a structural opening, deduct 180mm from the width and 120mm (rear mount) or 215mm (front mount) from the height. For behind the reveal fit calculate from drawings (using required headroom for front/rear mount).

Technical information

iso45 Overhead Sectional garage doors (over 3000mm wide x 2500mm high)

Rear mounted torsion spring shaft

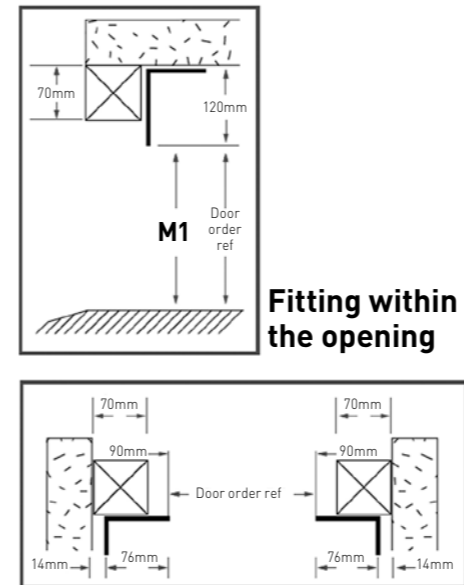

Order ref height	Standard size heights			
	M1	M2	M3	M4
6'4"	1925	2045	2050	2690
6'6"	2000	2120	2125	2765
6'10"	2075	2195	2200	2840
7'0"	2125	2245	2250	2890

Front mounted torsion spring shaft

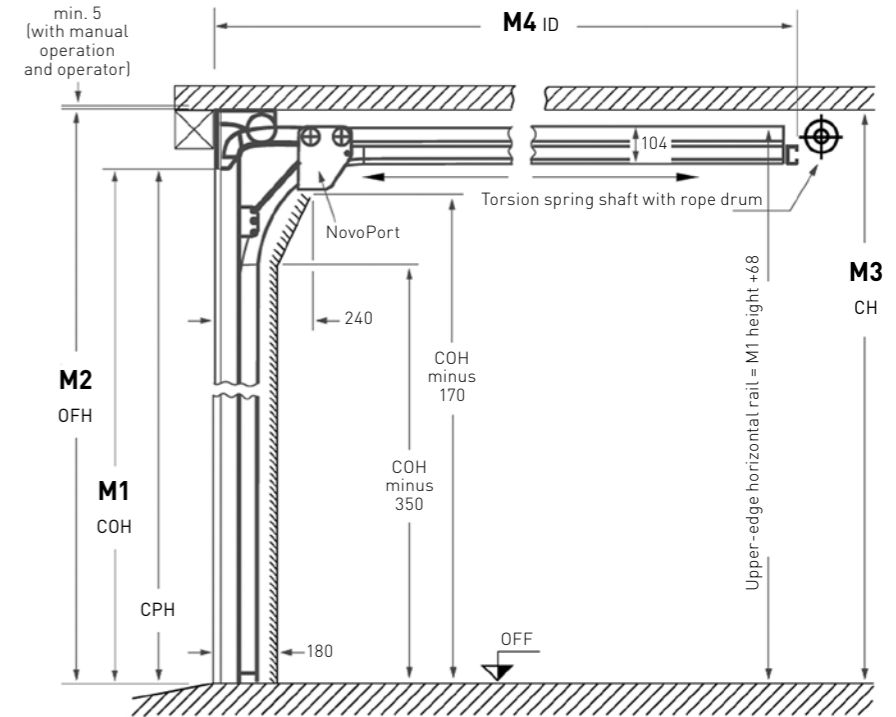
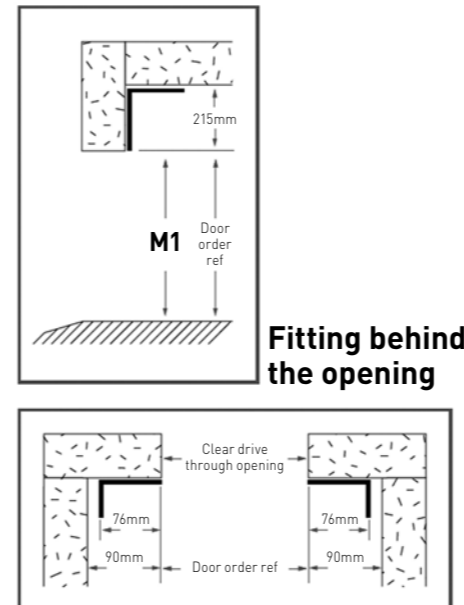

CPH Clear Passage Height (with NovoPort)
 COH (M1) Co-ord Height
 OFH (M2) Outer Frame Height
 CH (M3) min. Ceiling Height
 ID (M4) min. Installation Depth

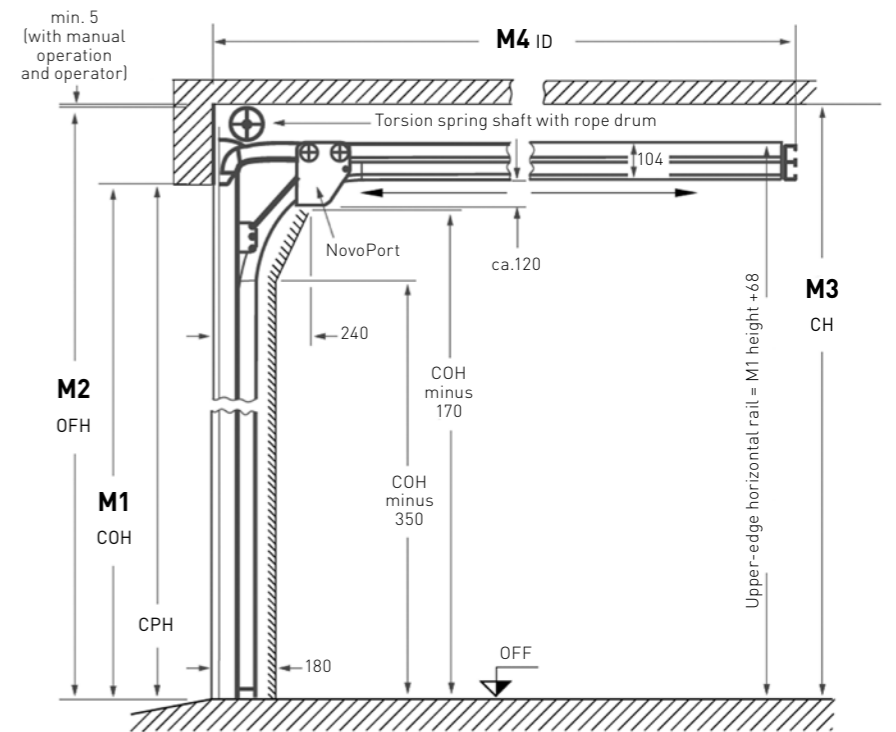

Order ref height	Standard size heights			
	M1	M2	M3	M4
6'4"	1925	2140	2145	2505
6'6"	2000	2215	2220	2580
6'10"	2075	2290	2295	2655
7'0"	2125	2340	2345	2705

CPH Clear Passage Height (with NovoPort)
 COH (M1) Co-ord Height
 OFH (M2) Outer Frame Height
 CH (M3) min. Ceiling Height
 ID (M4) min. Installation Depth

Technical information

Insulated Roller garage doors

Fitting within the aperture

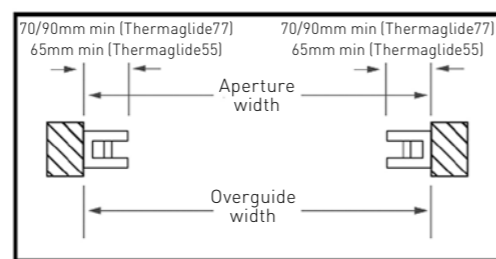
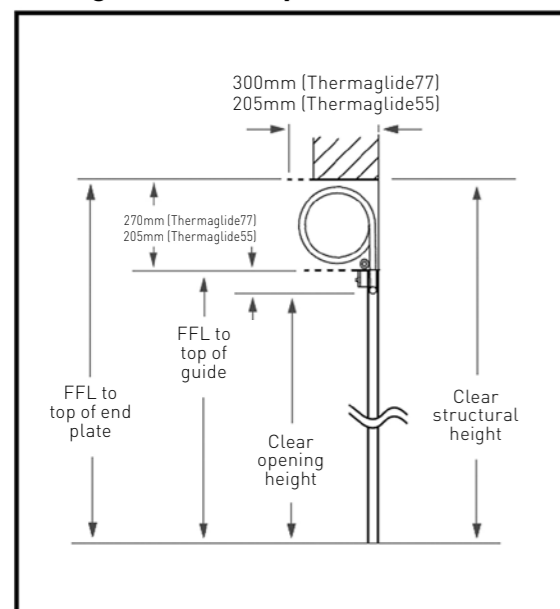

Fixing options

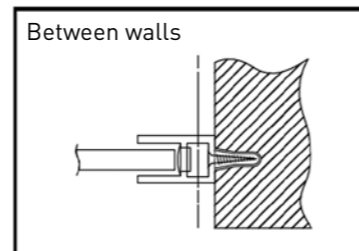
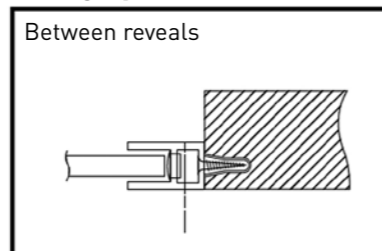

Fitting onto the aperture

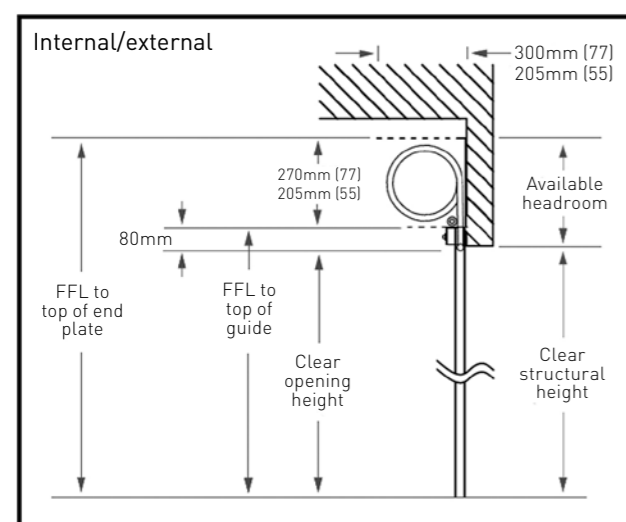

SIDE CLEARANCE: 70/90mm (65mm) is required only if the guides are to be fully concealed. A minimum of 40mm (30mm) is required to give sufficient room for fixing but a portion of the guide tracks (white as standard) will be visible.

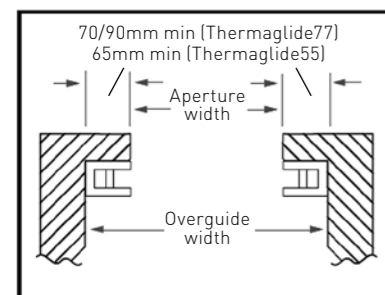

Fixing options

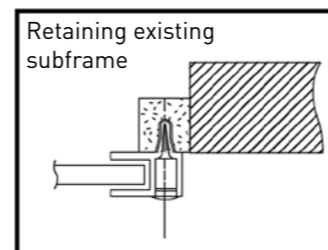
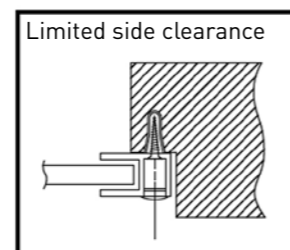
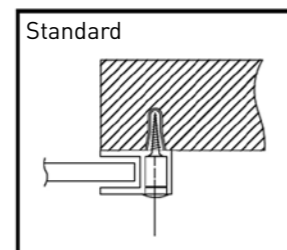

Warranty & maintenance

Up & Over Garage Door Systems

The purchaser is granted a warranty covering the safe and reliable operation of the Cardale garage door for a period of 10 years from the date of purchase. This warranty is conditional on the regular inspection and maintenance of the product in accordance with the installation manual supplied with the door. During the guarantee period the manufacturer undertakes to repair, without charge, any product which has suffered a proven failure of its safe and reliable operation provided that the springs, tracks and guide rollers have been inspected regularly (at least once a year) and maintained correctly, including replacement of wear items when required. All Cardale garage doors offer a 10 year warranty against the integrity of the door panel, as well as 2 years on rollers and springs for normal use, up to 25 open and close cycles a day. All retractable garage doors offer a 10 year manufacturer's guarantee (2 years for canopy doors) on material and manufacturing faults of all immovable frame parts, if it can be proved that they are inoperative, or their use is impaired. In the case of Novoferm steel doors, these are supplied factory prefinished in polyester based white. They are not immune to damage which can occur at any stage of the handling of the product from factory to site. Minor surface damage can be easily repaired using touch-up sprays or sticks without invalidating warranties. The corrosion of swarf filings or other air borne particles, rusting or staining of the panel is not considered as panel rust. Cardale timber doors use organically grown Cedar from replenishable sources, with natural colour and grain variations - this is a feature of Cedar. We make every effort to harmonise the effect, where possible, by hand matching the component parts used in construction. Please note that a uniform grain pattern cannot be guaranteed. Timber doors must be finished in accordance with the installation instructions, supplied with the door and the technical specification. Cardale timber doors are supplied with a temporary finish. As soon as the door is unwrapped one coat of a good quality basecoat primer must be applied to both sides of the door. Immediately after installation your timber doors require two further coats of a good quality exterior wood finish on both sides. Initial application and periodic treatment should be carried out strictly in accordance with the wood stain manufacturer's instructions. Failure to follow these instructions will result in early deterioration of the timber panel. Please note that protective finishes on all Timber doors must be applied to validate warranty.

Sectional Garage Door Systems

The purchaser is granted a warranty covering the safe and reliable operation of the Cardale garage door for a period of 10 years from the date of purchase. This warranty is conditional on the regular inspection and maintenance of the product, in accordance with the installation manual supplied with the door. During the guarantee period the manufacturer undertakes to repair, without charge, any product which has suffered a proven failure of its safe and reliable operation provided that the springs, wire cables, tracks, guide rollers and hinges have been inspected regularly (at least once a year) and maintained correctly, including replacement of wear items when required. All Cardale garage doors offer a 10 year warranty against the integrity of the door panels, as well as 2 years on rollers, springs, pulleys and cables for normal use, up to 25 open and close cycles a day. All Novoferm garage doors offer a 10 year manufacturer's guarantee on floor seals, central seals, side seals and header seals against perishing. All Cardale garage doors offer a 10 year manufacturer's guarantee on material and manufacturing faults of all immovable frame parts, if it can be proved that they are inoperative, or their use is impaired. Furthermore, Cardale fully finished steel doors (i.e. factory finish painted, Golden Oak, Rosewood) come with a 10 year panel corrosion guarantee relating to rust through inside or outside. If a panel rusts through, then the affected panel only will be replaced. Due to weathering, the new panel may not exactly match the colour of the old. In this instance the door should be repainted by the customer with a proprietary paint system, following the paint manufacturers' instructions. All steel parts are not covered by the corrosion warranty if situated within 3 miles of the coastline. In areas of high corrosion, (e.g. if exposed to sea air), the door panels should be painted with a proprietary paint system, following the paint manufacturers' instructions and that the door should be regularly cleaned. The corrosion of swarf filings or other air borne particles, rusting or staining of the panel is not considered as panel rust. The surface finish of Rosewood and Golden Oak foil finished sectional door panels is guaranteed from serious degradation for a period of 5 years, provided that regular maintenance including cleaning from salt is carried out in accordance with our instructions. During this period the colour of the door panels may change due to weathering (e.g. Intense UV radiation and coastal conditions etc). This is normal and is not covered by the warranty. In the case of Cardale pre-finished steel doors, these are supplied with polyester based primer paint finish. They are not immune to damage which can occur at any stage of the handling of the product, from factory to site. Minor surface damage can be easily repaired using touch-up sprays or sticks without invalidating warranties. Cardale timber sectional doors are supplied unfinished, please ensure that a full specification of finishing coats are applied immediately before or after installation to all exposed surfaces - inside and out, with a Sikkens or similar finishing coat system. Please note that protective finishes on all Timber doors must be applied to validate warranty.

Cardale Insulated Roller Garage Door Systems

The purchaser is granted a warranty covering the safe and reliable operation of the garage door for a period of 10 years from the date of purchase. This warranty is conditional on the regular inspection and maintenance of the product, in accordance with the installation manual supplied with the door. During the guarantee period the manufacturer undertakes to repair, without charge, any product which has suffered a proven failure of its safe and reliable operation, provided that the door has been inspected regularly (at least once a year) and maintained correctly, including replacement of wear items when required. Cardale Insulated Roller Garage Doors are guaranteed against any form of manufacturing defects for a period of 2 years from the date of purchase. The finish of white powder coated doors is guaranteed for a period of 2 years. In the case of textured woodgrain finished doors, the exterior finish is guaranteed to provide an effective weatherproof membrane which will resist perforation of the door from the weather-side due to corrosion for 10 years. Furthermore, colour change or fade to the exterior surface will be limited and uniform for the full 10 year period. Some marking may occur at the top of the internal side of the door curtain, this is unavoidable and is due to prolonged contact with autolock system

Cardale Garage Door Automation

For garage door operators: DC650 and DC800 we grant the following warranty, in case of supplying us with the original invoice: 5 years for mechanical parts of the operator motor and the control unit; 2 years for remote control parts and accessory parts. A 2 year warranty is also granted for remote control parts and accessory parts. No warranty claims will be accepted for wear and tear parts and consumable parts (e.g. light bulbs, batteries, fuses). Cardale Insulated Roller Garage Door electric operators are guaranteed against any form of manufacturing defect for a period of 5 years for mechanical elements, motors and transformers. The motor control unit is guaranteed for 3 years. Remote control accessories and parts are guaranteed for a period of 2 years. No warranty claims will be accepted for wear and tear parts and consumable parts (e.g. light bulbs and batteries and remote control handsets).

Door Maintenance

If in doubt about any maintenance procedures, please consult a Cardale specialist. Cardale has a nationwide network of installers who can offer you regular maintenance service on your garage door. Please call Cardale on 01582 563777 or check our website for details of your nearest installer. Immediately after the door is fitted and after every 5,000 operations of the door, or at least once a year, oil all pivot points and check tightness of screws and clamped connections. Keep running tracks clean (do not grease them), check all parts and replace any worn components. The springs should be replaced by an experienced door fitter after approximately 25,000 operations (see fitting and operating instructions). You should not oil the lock cylinder. If it is sticking, lubricate it with graphite dust. If you have a canopy door, check the cable every 6 months of normal usage (8 operations per day). If you find any wear, you should have the cables replaced by an expert installer.

Terms and conditions

Warranty

In the unlikely event of a warranty claim becoming necessary please contact the dealer or distributor who supplied the door.

To enable your claim to be processed without delay you should provide the following information:

- Your name, address and contact telephone number
- The original invoice and date of purchase
- A description of the door, the door type and the product number
- A description of the reason for the claim

Your dealer will then supply details of your claim, together with a copy of the warranty card supplied with the door and proof of purchase, to the warranty department at Cardale. An assessment of the claim will be made. This may mean Cardale will need to come and inspect your door at your premises. In the event that there is no legitimate claim under the terms of the warranty you may be liable for the costs of this visit. It is essential that you take note of the care and usage instructions provided with your door and you follow these instructions throughout the lifetime of your door.

The warranty does not cover:

- Improper installation
- Normal wear and tear
- Priming and other surface protection treatments
- Negligent or wanton destruction
- Incorrect or too late applied surface protection treatments
- Repair by a non-qualified installer
- Use of non-Cardale parts without the approval of Cardale
- Damage or removal of the product number or making it unidentifiable
- Improper operation
- External influences, such as fire, salts, water, acids, alkaline solutions, abnormal environmental influences
- Mechanical damage caused by improper transport or installation

All dark colours which are exposed to direct sunlight should be avoided. Dark coloured doors may undergo expansion due to heat absorption. Such instances are not covered by the guarantee, however normal performance will revert when the door has cooled down if the heat absorption has affected the door's performance.

All colour samples depicted in this brochure are as close to the original manufacturer's colours as possible. Garage doors supplied may vary in colour from the brochure representation.

Your Cardale Stockist

Prices

All orders are accepted on the understanding that the goods will be subject to the prices ruling at the time of delivery, unless other terms are specifically agreed. All prices are in £ sterling and exclude VAT. UK mainland delivery is included to the buyer's trading address - delivery to site £54.00 (subject to access). A 25% handling charge applies to all unwanted items on standard stock items only. Items must be returned unopened and in an unused condition. All returns are subject to acceptance by Cardale Garage Doors. All doors are bespoke and made to order. Your right to cancel is not available on non-standard made to order doors.

Specification

Due to the progressive outlook of Cardale we reserve the right to alter specifications to design and manufacture without notification. All specifications and details are correct at the time of publication, errors and omissions excepted.

All Doors

Colour match pairs of doors should be ordered together to obtain the best colour match, bearing in mind the limitations of the materials used in the construction. Timber garage doors cannot be ordered as matching sets.

Size variations

As the size of a door changes in height and/or width, the panel frequency and profile can change, therefore doors of the same style but of different sizes can be significantly different in appearance.

Clearances

All doors require operating clearances, i.e. the gap between the door panel and frame opening, these are inbuilt during manufacture and should not be reduced by means of infills, or draught proofing.

Deflection

When in the open position, all doors will display a level of vertical deflection or 'sag' across the width of the panel. Individual manufacturers' specifications should be consulted for exact tolerances.

Cardale reserves the right to alter specifications to design and manufacture without notification. All specifications are correct at time of publication, errors and omissions excepted.



Cardale Garage Doors
Unit 5-9 Luton North Industrial Estate, Sedgwick Road, Luton LU4 9DT
t: 01582 563777 f: 01582 568801
www.cardale.co.uk
Opening times: Mon-Fri 8.30am - 5.00pm

