

Carlson Library Pedestrian Bridge

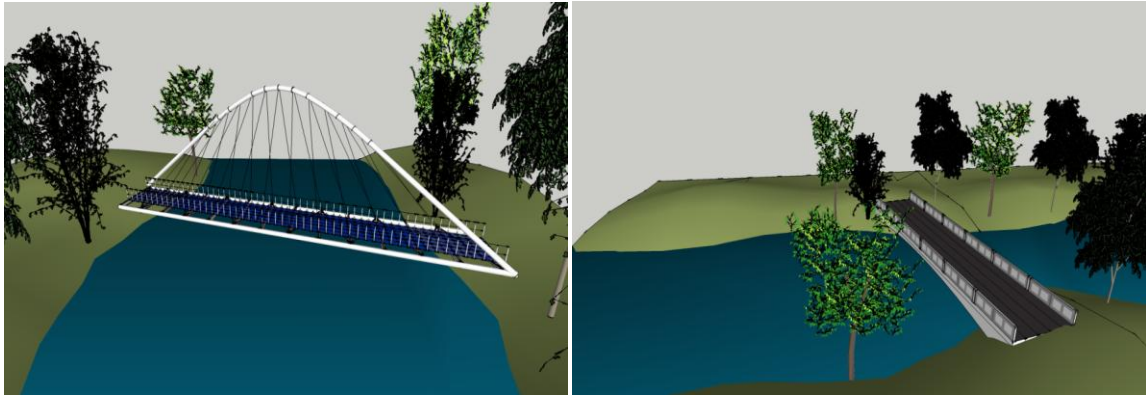

CIVE 4750 Research Report



COLLEGE of ENGINEERING

THE UNIVERSITY OF TOLEDO

The University of Toledo
Department of Civil Engineering
Senior Design Project
Spring 2011

Carlson Library Pedestrian Bridge

Erin Davis, Jonathan Lidgard, Micah Shumway, Shuo Xu

May 6th, 2011

Advisor:
Douglas Nims

Prepared as student work for CIVE 4750 Capstone Senior Design

Disclaimer

The contents of this report reflect the view of the authors who are responsible for the facts and the accuracy of the data presented herein. Not to be used for construction. All opinions are those of the authors and are not necessarily endorsed by the Department of Civil Engineering or the University of Toledo.

Acknowledgements

Faculty Mentor:

Douglas Nims, Ph.D., P.E. Associate Professor
Douglas.Nims@utoledo.edu 419.530.8122

Ottawa River Corridor Mentor:

Patrick Lawrence Ph.D. Associate Professor Department Chair
patrick.lawrence@utoledo.edu 419.530.4128

Pricing

Randy Wilson
Select Thin Brick LLC

Ed O'Connell
UPI Pre-stress

John Stricher
Atlas Paving

Ted Hazledine
Benchmark Steel

Chris Barry
Pilkington Inc.

Judy Liu
Purdue University

Bradley Touchstone
Touchstone Architecture

Midwest Steel Inc.

Dlubak Glass Corp.

Table of Contents

Title Page	i
Disclaimer	ii
Acknowledgements.....	iii
Table of Contents	iv
Abstract	1
Introduction.....	2
Background.....	2
Constraints	3
Objectives	3
Description of work	4
Table 1: Constraints of Bridges	4
Figure 1: Central Park Bridge, New York City.....	5
Figure 2: Girder Cross-Section	6
Figure 3: Concrete Deck and Parapet	6
Figure 4: Parapet design 1.....	7
Figure 5: Parapet design 2.....	7
Figure 6: Zubizuri Bridge in Bilbao Spain.....	8
Figure 7: Deck Dimensions and Orientation.....	9
Figure 8: Current Bridge Orientation.....	9
Figure 9: Deck Dimensions.....	10
Figure 10: Arch and Cable Dimensions.....	10
Figure 11: Arch Design Methodology	11
Figure 12: Glass Deck Design	11
Figure 13: Reaction Forces	12
Classical Bridge	13
Table 2: Cost of Classical Bridge	13
Signature Bridge	14
Table 3: Signature Bridge Cost Comparison	14
Results.....	15

Classical Bridge	15
Figure 14: 3D View	15
Figure 15: End View	15
Figure 16: Side View	15
Signature Bridge	16
Figure 17: 3D View	16
Figure 18: Side View	16
Figure 19: End View	16
Implementation plan	17
Conclusions	17
Table 4: Cost Comparison.....	17
Bibliography	18
Appendix.....	19
Qualifications	19
Team Members	19
Initial Design Considerations.....	21
ODOT Concrete Girder Specifications for Classical Bridge	23
Summary of Meeting with River Corridor.....	29
Cost Estimate for Classical Bridge	29
Cost estimate for Steel Bridge	32
Cost estimate for glass deck.....	33
Cost estimate for steel structural support under glass deck	35
Steel Bridge Connection Drawings.....	36

Abstract

The Carlson Library Pedestrian Bridge was constructed in 1964 and has had little to no upkeep since its construction. When the bridge was first constructed it was built for convenience for the walkers and the aesthetics was not taken into consideration. Now with the University growing, the current bridge is too narrow for the amount of daily traffic. Also, the aesthetics are becoming an important issue with the look and feel of the campus. The design for this new bridge needs to accommodate the increased traffic demand and be aesthetically pleasing without impeding the flow of the river underneath.

The objective of this project was to provide two alternative bridge design to the university along with cost estimates. The concepts for these designs were approved by Dr. Lawrence before beginning. The first was a prestressed concrete bridge with a classical look and feel that blends in well with the universities current gothic architecture. The second was a more modern signature steel arch suspension bridge with a glass walkway.

Both bridge concepts proved to be feasible to build and within the maximum allowable budget as set by Dr. Lawrence. Alternative materials were suggested for both bridges to reduce the cost if desirable. The classical bridge is wider and less expensive and has an array of possible aesthetic option to meet the universities desires. The signature steel bridge is more expensive and was thus made narrower so that it would not exceed the budget. It is 33 feet tall and would stand out more in the area which may or may not be desired by the university.

The final results of the two designs were presented to Dr. Lawrence and the River Commission. Along with the designs a budget was included for the individual bridges along with alternative prices in materials. The design was not completely construction ready but thorough enough to provide accurate price estimates. It is up to the university to decide which bridge best suits there purposes and pursue the appropriate implementatino plan if they choose to build one of the bridges.

Introduction

The Carlson Library Pedestrian Bridge is a high traffic pedestrian bridge that is outdated and in need of replacement. The bridge was designed too narrow for the amount of traffic that goes over it every day. Since the bridge's construction in 1964, it has had very little inspection or restoration. This neglect has started to show in how it is wearing. As the growth of the University has increased, the area around the Carlson Library has become an aesthetic focal point. However, the current bridge was not designed for aesthetics. The University of Toledo has requested that the new bridge designs be generated to enhance the look and feel of the region around Carlson Library. They also would continue their efforts of enhancing the Ottawa River Corridor.

The main objective of our project was to design a replacement for the Carlson Library Pedestrian Bridge. Two different types of bridges were designed as possible replacements. One design was a concrete pre-stressed bridge. The other was a steel arch bridge.

Another objective in this project is to enhance the scenery of the Ottawa River. In the aesthetic concept the orientation of the bridge was considered. This was due to the close proximity of the Carlson Library entrance. Currently, pedestrians are forced to turn left or right after walking across the bridge and thus are directed away from the library's entrance. The new designs will increase the accessibility of the library's entrance making the area more harmonious.

Finally, a cost analysis was done. As with all construction designs, cost was important in helping decide which bridge design to choose. In the cost analysis the main area of concern were labor, materials, equipment and maintenance.

Background

The University of Toledo has a gothic architectural theme with Indiana Limestone across the majority of campus. Unfortunately, the current Carlson Library Pedestrian Bridge does not reflect the current architectural theme. Part of the aim in designing a replacement bridge is to harmonize the bridge with the rest of the university. The new bridge location was also designed to fit with the overall Ottawa River corridor. Other considerations to the new bridge designs were the electric lines, the water flow of the Ottawa River, the trees along the riverbed and the number of pedestrians that can cross the bridge. These issues would affect design and construction of a new bridge.

Constraints

The three main constraints that each bridge had to follow were; the American Association of State Highway and Transportation Officials (AASHTO) guidelines, water flow clearance, and budget. The AASHTO guidelines specified a truck load, pedestrian load and wind load that were applied in the analysis. It specified how these loads were applied in relation to one another. It also specified the maximum permissible deflection of the bridge.

The water flow is a big issue in this area due to the river flooding its banks in heavy rainfall. In the last couple of years there has been significant flooding. With the flooding occurring annually the bridge prototypes needed to have nothing underneath them that would obstruct the water way.

The last constraint is the budget of the bridges. There was not a set budget for this project because money would be raised to build one of the bridges if its design was chosen. However, a guideline was given that \$500,000 would be a reasonable price and \$1,000,000 would be the maximum feasible. With this constraint in mind alternative methods were explored to decrease the cost of either bridge. The decreased cost either came from the material or how the bridge is constructed.

Objectives

There were three main objectives in this project: to design a new pedestrian bridge, consider aesthetics and functionality of the bridge and give a cost estimate. The design was meant to be an aesthetic concept and include structural analysis thorough enough to provide a reasonable cost estimate. It was not meant to be completely ready to be constructed. If the design were implemented it would need to be checked and completed by a professional engineer.

The aesthetics and functionality of the bridge was the most fundamental objective. The area around Carlson Library and the Ottawa River is in need of aesthetic improvements. The university would like to implement a number of aesthetic improvements including seating areas near the river and the Carlson library. The bridge needs to be an aesthetic addition to the area. It should appeal to the students walking across it and those sitting in the area nearby. Also, the bridge that is their right now is too narrow. The students that walk across the bridge don't always have enough room to walk and sometimes need to stop and let others pass.

Once an aesthetic concept and structural design were completed a thorough cost estimate would be completed as well. For this step, the help of construction companies and engineers was sought out to get as accurate an estimate as practical.

Description of work

This section presents an overview of the design process. The detailed structural calculations are included in an electronic format. Initially there were fourteen design alternatives considered. The images of these bridges can be seen in *initial design considerations* section of the appendix. These alternatives were presented to Dr. Lawrence and two options were chosen from the fourteen. The selected options can be seen in Figure 1 and Figure 6 in the pages to follow.

The first step for the project was to look at the current bridge and determine the issues and constraints with the site, which can be seen in Table 1. This helped to give an idea of what kind of designs are feasible for the site. After the site visit was completed, research begun into the different kinds of bridges that could be implemented and which styles would give the best options for the University. Once the styles were determined, several samples of what could be feasible were presented to the clients and two bridge concepts were chosen for the project.

Table 1: Constraints of Bridges

Structural Design Criteria		
Soil Bearing Capacity	245	psi
Foundation Concrete Strength	4000	psi
Floor Live Load		
Pedestrian	90	psf
Truck, H10		
Rear tire (each)	8	kip
Front tire (each)	2	kip
Wind Loads		
Maximum Wind Speed	70	mph
Influence Factor	1.15	
Horizontal Pressure	12.5	psf
Wind Uplift Line Load	0.02	kip/ft
Dead Load		
Signature Bridge		
Concrete Deck	100	psf
Classical Bridge		
Girders	807	lb/ft
Parapet	167	lb/ft

Once the two concepts were determined, the next step was to come up with a working design for each bridge. The first concept was a classical pre-stressed concrete bridge and the second concept was a signature steel arch bridge. Over the next 10 weeks both bridges were developed and designs were finalized in order to allow for cost estimated and visual renderings to be completed. The two bridges are discussed further in the report.

After the development and final calculations for each bridge were completed, the next step was to design the foundation. To simplify the work, it was decided that the largest force from either bridge that needed to be supported by the foundation was used. The design chosen for the foundation was a shallow foundation which means that it is as wide as it is deep into the soil. This was determined by the simplicity of shallow foundations compared to deep foundations that would require caissons or piles and deep drilling to support the force.

The strength of the soil on site was determined through the use of a boring log that was taken when the David Root Traffic Bridge was built over the Ottawa River in the 1980's. This bridge is located roughly 1000 feet down river so it was assumed the soil would not vary much between sites. With the use of the boring log, the friction angle for the soil was determined for each depth and this was used to help determine the overall strength of the soil. This was then compared to the strength required with a factor of safety of 4 to ensure that the soil should hold. It is recommended though that there be a soil sample taken for the site before construction to ensure that the soil can hold a foundation of this design. The calculations for the foundation can be found in the appendix.

Finally, the overall site plan was taken under consideration with the idea that if either bridge was implemented, there is room for enhancement for the areas directly adjacent to the bridge entrances. These entrances could be enhanced by adding landscaping, student sculptures, or seating. This can help to direct traffic more efficiently as well as create a better overall feel of the area.

Classical Bridge

When starting this project the team found pictures of existing bridges that would become our inspiration for the duration of the project. For the Classical Bridge the inspiration came from New York City, Central Park. This inspirational picture can be seen in Figure 1.



Figure 1: Central Park Bridge, New York City

The Classical Bridge started with determining if reinforced concrete would be an economical material to make the slab. With later calculations the thickness of the slab would be almost 60 inches thick. This option was unusable; I then proceed to do a girder line analysis with pre-stress concrete.

The Girder line Analysis pertained to known factors of the pre-stress concrete that was given by Ed O’Connell, which can be seen in the appendix, which were placed into a MathCAD calculation sheet that was obtained from Dr. Nims. The known values were placed in the sheet and the amount of strands and the thickness that would be needed for each girder were solved. The girder line analysis also had distribution factors, deflections, moments, and shears of one girder. This girder line analysis can be seen in the electronic copy of the report.

The final results from the girder line analysis can be seen in Figure 2.

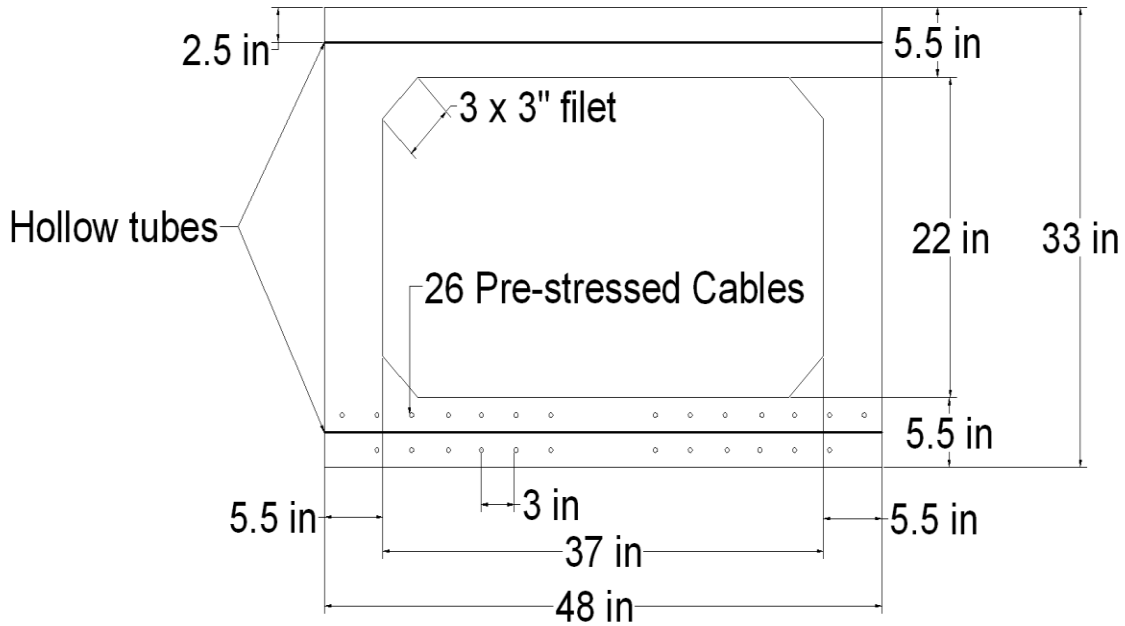

Figure 2: Girder Cross-Section

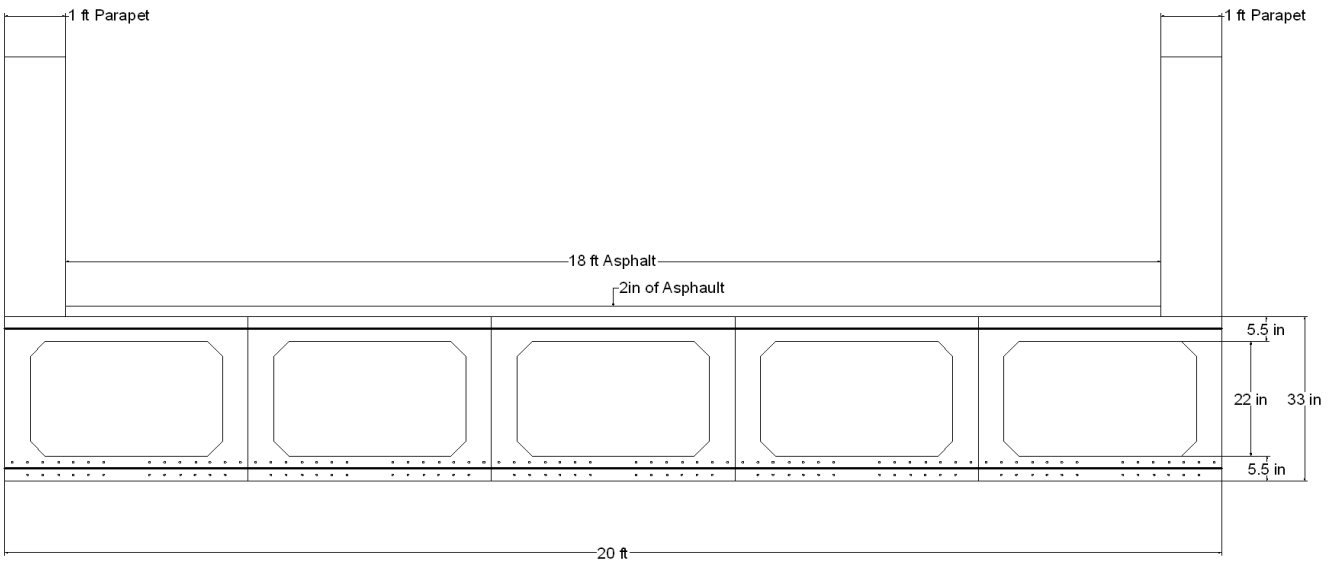

Figure 3: Concrete Deck and Parapet

The concrete bridge's deck can be seen in Figure 3 and will be designed with five 4' x 100' x 33" girders. A closer view of one of the girders is seen in Figure 2. The girders are to be formed with a tube at the top and bottom to reduce the wear that has to be applied on top. These hollow tubes are to be spaced every 10' on the girder both at top and bottom as shown in Figure 3.

Pre-stressed cables are to go through all four of the 4' girders as seen in Figure 3 at the top and bottom of the girder. Then the cables then will be tightened. Asphalt, just a wear course, was chosen to help to secure the girders to stay together.

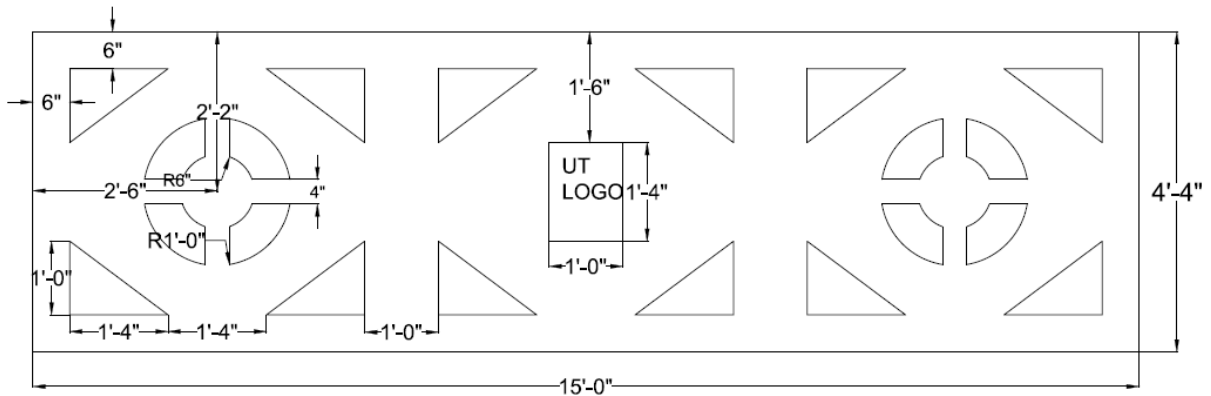

Figure 4: Parapet design 1

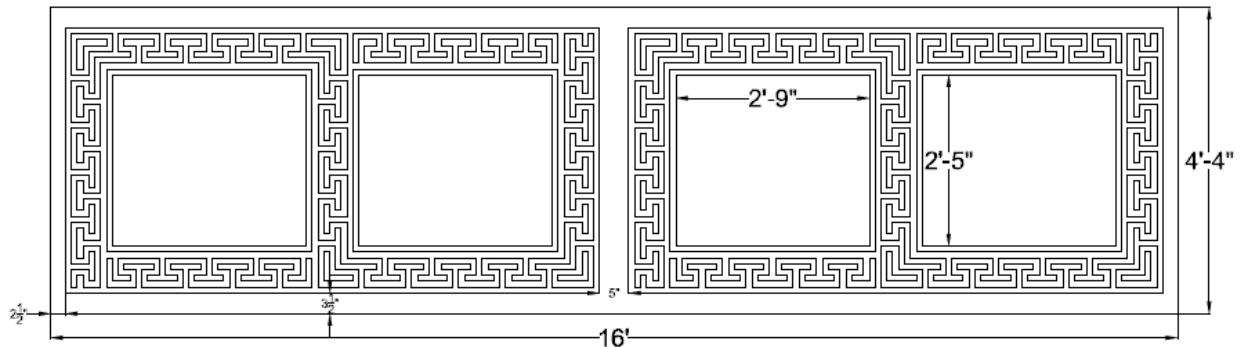

Figure 5: Parapet design 2

For the parapet we came up with two designs that can be seen in Figure 4 and 5. Both of these designs could be made out of polymer concrete but the design in Figure 5 would be difficult to create in the traditional concrete, based off of conversations with Randy Wilson, "Polymer concrete can give you more details than traditional precast." The difference between polymer concrete and traditional concrete is discussed in the Cost Analysis for the Classical Bridge.

Signature Bridge

Another option that was considered was a signature bridge. A signature bridge is a bridge that becomes the focal point of an area. It will enhance the feel and aesthetics of the area and utilizes the latest technologies to create the modern feel that is desired.

The inspiration behind the design of this signature bridge was from the Zubizuri Bridge in Bilbao Spain, which can be seen in Figure 6. This bridge uses a large steel arch and cable supports to hold a deck below the arch. The design concept for the Carlson Library Pedestrian Bridge was based off of that design. The design was to use a large steel arch to span the river. Then attach steel cables to the arch that connect to the deck below. The arch will span diagonally from one corner of the deck to the opposite corner as it crosses over the river.

The Zubizuri bridge has a glass deck which has a more modern and unique aesthetic appeal but would not be able to hold a vehicle driving across the bridge. Since the AASHTO code requires that the bridge be designed to hold a vehicle, it was necessary to make the steel structure able to hold the weight of a concrete deck and the vehicle. However, the design and cost analysis were still completed for a glass deck which would be recommended if the funds are available and the university is willing to let the bridge handle strictly pedestrian traffic.



Figure 6: Zubizuri Bridge in Bilbao Spain

The first step in the design process of this bridge was to develop a geometric design that met all the necessary constraints. These constraints included head clearance under the cables, adequate usable deck width, and efficient structural support. After several ideas and trials the final geometry was determined and is shown in the following figures.

The orientation of the bridge was taken into consideration and it was determined that it could be turned 20 degrees toward the Carlson Library entrance. The orientation is shown in figure 7 below. The 97' long area is the original bridge which is 10' wide. The angled area is the proposed bridge and at the top of the diagram is the Carlson Library side of the river. Figure 8, a photo taken from the library, shows roughly where the bridge would be on the near side of the river after it starts from the same point as the existing bridge.

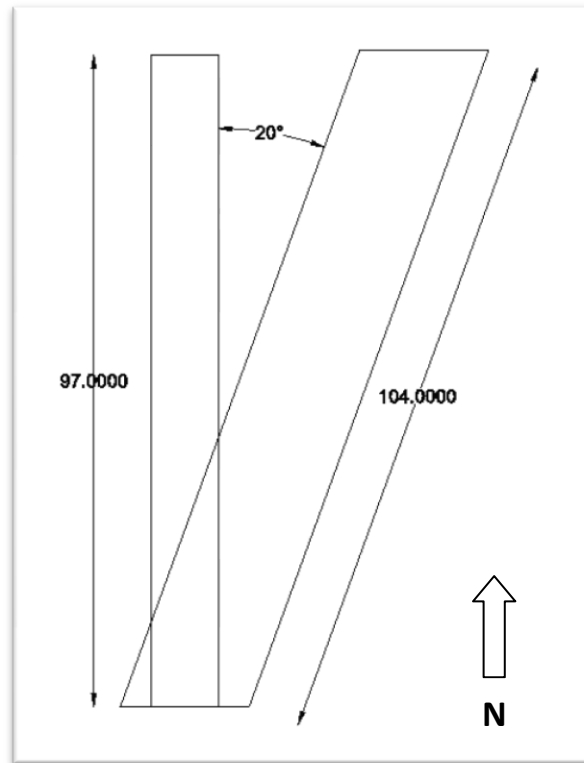

Figure 7: Deck Dimensions and Orientation



Figure 8: Current Bridge Orientation

The width of the bridge is 18 feet to the center of the round side members. The W14x34 I-shaped beams were set at an angle as shown for a unique aesthetic feel. The WT6x9.5 T-shaped members are not used to hold up the deck. They are used to stabilize the superstructure by handling tension and compression within the structure itself. The deck design and dimensions are shown in figure 9.

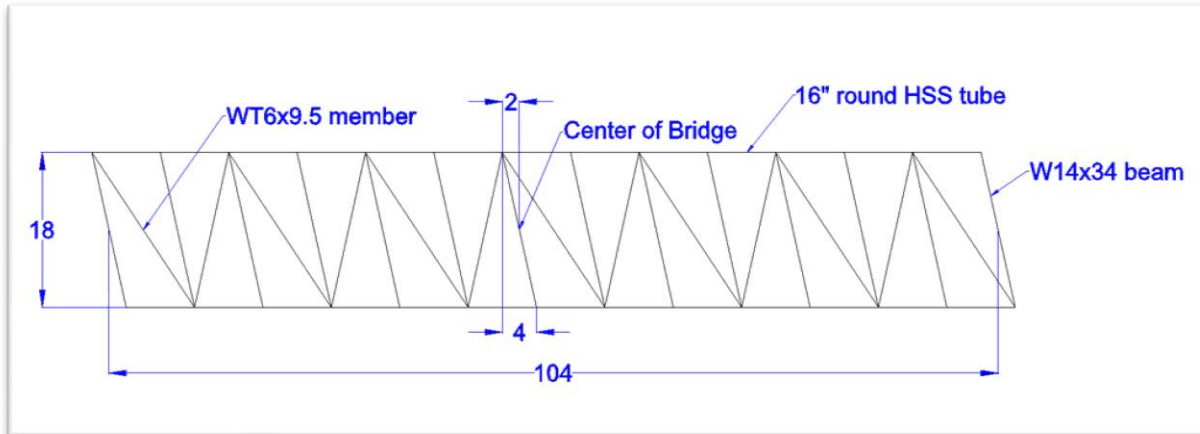

Figure 9: Deck Dimensions

The arch was redesigned several times. Originally it was simply a segment of a circle beginning at the corners of the bridge with a height of 30 feet. This did not provide enough stability so it was determined that the arch member should be straight from the corner of the bridge until where the first cable intersects the arch. The height of the first cable intersecting was determined to be 22 feet in order to make head clearance work. The longitudinal distance of the cable connections in the arch were chosen to be 4 feet for aesthetic and structural simplicity. The final dimensions can be seen in figure 10 below.

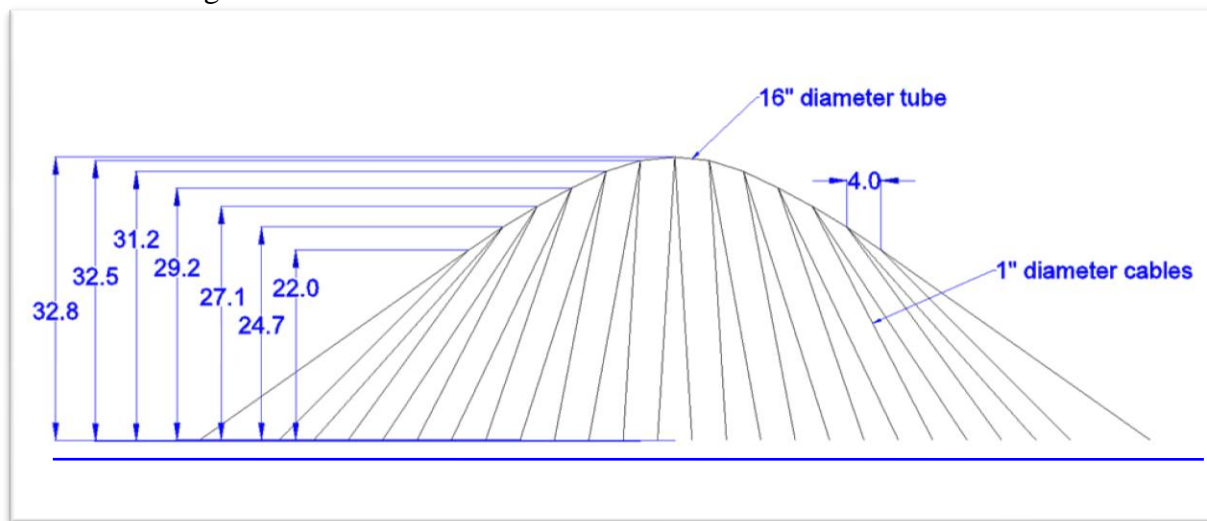

Figure 10: Arch and Cable Dimensions

Before this final design was achieved there were a couple steps of trial and improvement. First, a simple circle segment was used beginning at the intersection of the first cable. This did not provide enough stability in the center of the bridge. Finally, a functional design was achieved by

using a line centered between the original circle segment and the tangent lines but increasing the curvature at the very top. This can be seen in figure 11 below. A segment of a circle was constructed as shown and the final arch follows the centerlines between the arch tangent and original circle segment and then between the two circle segments near the top.

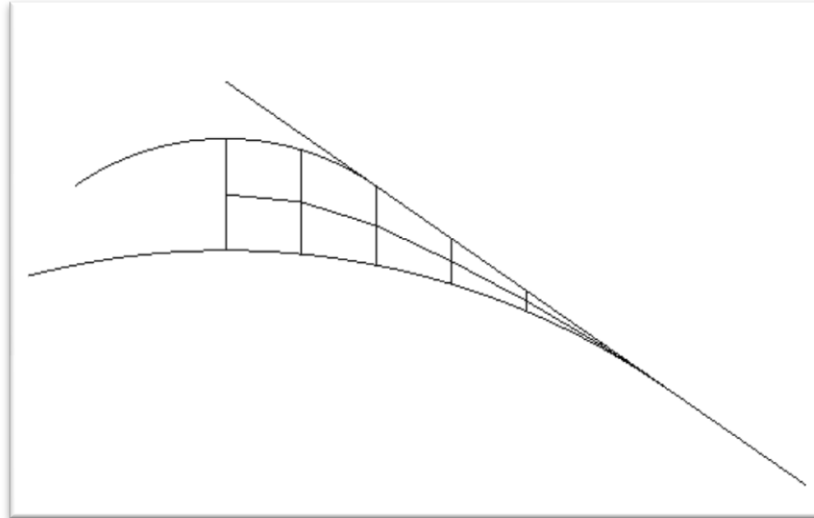

Figure 11: Arch Design Methodology

The glass deck is made up of a grid of 2'x2' pieces supported by WT2x6.5 T-shaped members. It is 12 feet wide as determined earlier. The 2'x2' glass pieces were chosen for structural integrity and geometric ease. The grid is then 6 pieces wide extending the length of the bridge. It was oriented at a slight angle to make head clearance easier at the ends of the bridge and for aesthetic uniqueness. The layout of the glass deck is shown below in figure 12.

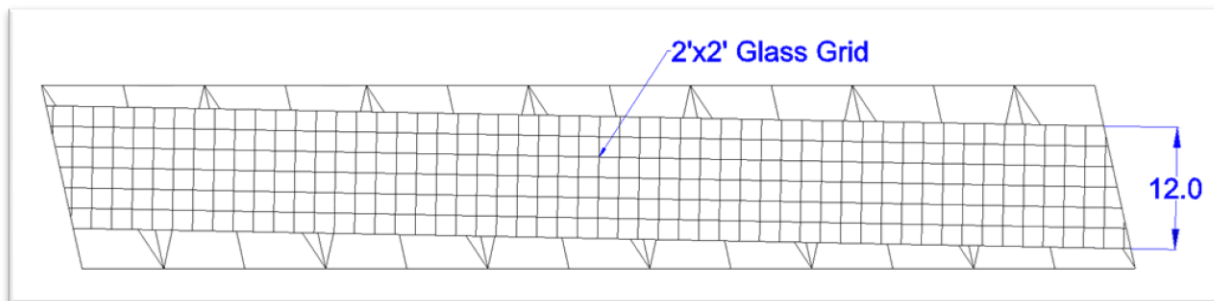

Figure 12: Glass Deck Design

The biggest challenge faced in designing the members for the bridge was to ensure that the steel members could hold the loads that were applied to them. These loads are the weight of the bridge itself, the pedestrian loads, the concrete deck, and the weight of a truck if it were to be driven over the bridge. There are several different regulations and factors that needed to be addressed before the design process could begin. First of all, AASHTO has a set of guidelines that specify the weight assumptions for both the pedestrian load, and the truck load. These guidelines set the assumed weight to be 90 pounds per square foot for the pedestrian load, and for the truck load it was set as 8,000 pounds per rear truck tire and 2,000 pounds per front truck

tire. There are two types of loads that were considered. The first was the dead load, which is any weight on the bridge that is stationary and continuously applied to the bridge. This includes the weight of the members, the weight of the deck, and any other weight that is attached to the structure itself. The second type of load is a live load, which is any load that is applied to the structure that changes, such as pedestrians walking over the bridge or the truck load at any given moment as it cross over the bridge. These loads are then scaled to increase the load to ensure the bridge members can hold the assumed weight. The dead load was multiplied by a factor of 1.2 and the live load was multiplied by a factor of 1.6. These loads were then added together to give the maximum total load possible on any given deck member.

After the loads were determined the next step was to construct a three dimensional model into the structural analysis software SAP. This is a structural analysis program that uses finite element method to determine the forces on the bridge itself and how the loads are transferred throughout the structure. After examining the loading and what was estimated to be the resulting forces in each member, a rough over estimation on beam size was determined to see how the bridge would behave and hold up under the forces. After examining the deflections and bending moments in each member, the size was then changed to try and find the most economical members possible.

After the optimum members are found, it is important to check the reactions and deflections at each corner point of the bridge to ensure that there is not an unacceptably large force being applied to the ground or any tension force needed from the foundation. Foundations do not support tension forces very well and would cause a very large problem for the design of the bridge if there was any tension force needed from the foundations. The bridge was designed so that after the gravity loads were applied, there would be only four point were the loads were being transferred to the foundations. These four points are at the corners of the bridge and are designed to be set onto the foundation. Analytically, the bridge and the foundation are almost independent of each other, only one point was supported in all directions, the rest of the corners are to be restrained in only two directions, vertically and laterally. This is due to the design of the deck itself and how it handles the forces. Figure 13 shows the reactions at each corner of the bridge that will be transferred to the foundation.

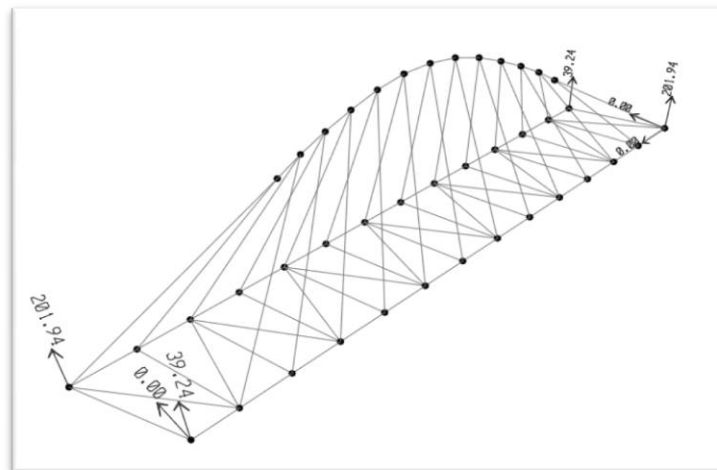

Figure 13: Reaction Forces

Cost Analysis

Classical Bridge

Table 2: Cost of Classical Bridge

	Option A	Option B
Asphalt	\$4,200	\$4,200
Girder	\$117,500	\$117,500
Parapet	\$208,000	\$176,000
Cranes	\$103,000	\$103,000
Excavation	\$527	\$527
Retaining Walls	\$8,813	\$8,813
Concrete	\$151,200	\$151,200
Bridge	\$432,700	\$400,700
Foundation	\$160,540	\$160,540
Total	\$593,240	\$561,240

Table 2 shows the individual items along with the total cost of the concrete bridge. The girder, parapet and asphalt were costs that were giving by contractors in their respective fields. The major difference between Option A and Option B is that the parapet in option A is \$32,000 more that option B’s parapet. All cost estimates given by the contractors can be seen in the appendix.

The difference between these two options is Option A is an Architectural Polymer Panels that is “impervious to water, salts and the environment. It is less than 1% water absorption. Polymer allows more aesthetic flexibility; it can be formed in shapes and colors that are not possible in the conventional concrete. The polymer concrete is more expensive but will require less maintenance in the long run. The University can clean with a power wash yearly and it does not require any waterproofing. Polymer concrete’s light weight will reduce the structure, reduce the number of stainless steel connections in the structure and will require small pieces of equipment to install/ deconstruct. Along with renewable material choices, recycled content and biodegradable products.” says Randy Wilson of Select Thin Brick, LLC. The only downside of the Architectural Polymer panels is that they run between \$850-900 per linear foot and the installation is \$1,000 per piece.

Option B is a Traditional Precast Concrete panel which “is susceptible to erosion due to salts and weather.” says Randy Wilson of Select Thin Brick, LLC. In comparison the Traditional Precast Concrete is between \$550-600 per linear foot and to install is \$2,000 per piece.

Signature Bridge

Table 3: Signature Bridge Cost Comparison

	Glass Deck	Concrete Deck
Steel Cost	\$450,000	\$450,000
Decking Cost	\$180,000	\$0
Foundation	\$160,540	\$160,540
Miscellaneous	\$25,000	\$25,000
Total	\$815,540	\$635,540

From Table 3 above, it is clear that the glass deck option will cost significantly more due to the added cost of the glass and its installation. The decking cost for the concrete deck is included in the cost of the steel for that option. The miscellaneous costs are the costs for the removal of the current bridge, the cost of tree trimming or removal, and other site preparations that are need.

The cost of steel was given Ted Hazledine of Benchmark Steel with assistance from Midwest Steel. This is the cost of both materials and erection of the bridge; which means that labor and welding are included in these costs.

The glass that was chosen for the deck was four half inch laminated glass sheets that have a PVB vinyl 0.045 millimeter interlayer. This interlayer is used to help with strength and makes the glass shatter resistant. The top plate of glass is heat treated and has a skid resistant finish to ensure that no pedestrians will slip when the bridge is wet and meets ADA guidelines.

Also to add to the overall aesthetics of the bridge, the glass is to be frosted or tinted blue. This will allow for the addition of lights under the deck which will help to tie the bridge in to both Savage Arena on campus, and the Veteran Memorial Skyway Bridge on I-280 over the Maumee River. This lighting can be used in place of the current light poles that are on the bridge, which would interfere with the cables and arch.

If there is a concern for ice buildup the bridge deck or arch, there is a possibility to add heating to the deck and to the arch tube. If this is to be done, an analysis of how this would affect the strength of the materials must be done before implementing these ideas onto the bridge.

Results

Classical Bridge

The final results of the Classical Bridge can be seen in Figure 14-16. These drawing were provided by Google SketchUp. With Google SketchUp drawings it is possible to provide an idea of the aesthetic feel of how it would look over the Ottawa River corridor. Overall with this final design the bridge increased in width by 10ft. With the increased width there is now 18 feet of clear space for pedestrians to walk on. The orientation of the bridge was not considered for this design but, could be implemented as shown by the Signature Bridge.



Figure 14: 3D View



Figure 15: End View



Figure 16: Side View

Signature Bridge

The signature bridge was able to meet the determined constraints given by the client. The bridge does not restrict the flow of the river, it increases the width of the bridge to allow a greater traffic flow, and it was oriented 20° to allow for a more direct path into the Carlson Library. The price on this bridge does exceed the ideal budget, but with the proper fund raising and donors, it is very feasible to construct. Below in figures 17-19 are Google SketchUp renderings of the bridge as it crosses over the Ottawa River.

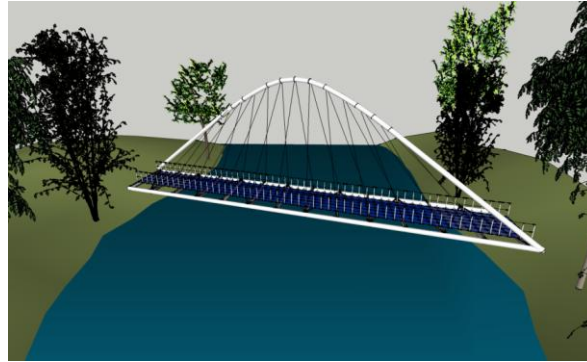

Figure 17: 3D View

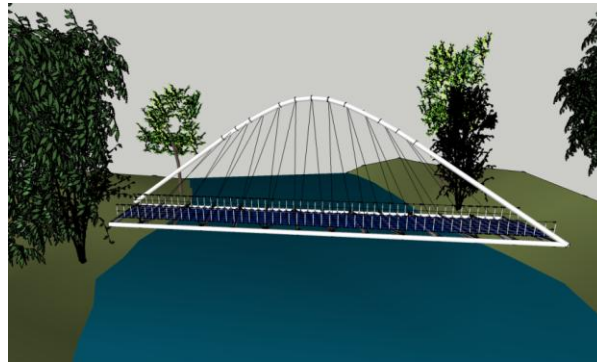

Figure 18: Side View

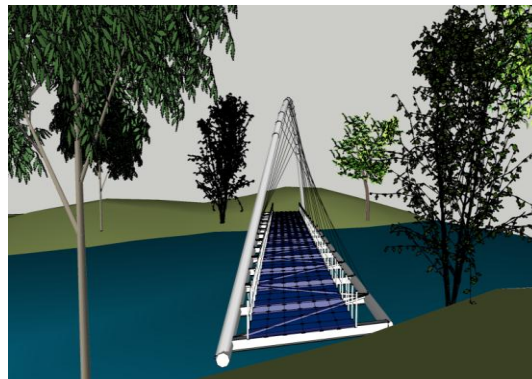

Figure 19: End View

Implementation plan

This preliminary design was for concept and cost. The next steps after this proposal would have a refine design, complete calculations and design all details. Then, a PE would verify the values and sign off on the bridge. After these steps were completed, design drawing would need to be developed and put the project out for bids. Meeting with the contractors would give a better understanding of how their products would collaborate with each others. Once the products are verified then detailed drawings would be made to limit the amount of errors that could occur and increase the cost of the bridge. Once the design is settled then an updated cost estimate would be performed from multiple contractors to insure the cheapest cost possible. Lastly, bid the project to a contractor and build the bridge.

Conclusions

After analyzing both bridges, it was determined that both the classical, and signature bridges are feasible options to replace the existing pedestrian bridge. Each bridge has its advantages and disadvantages but they both meet the AASHTO guidelines and are structurally sound. They could also both be redesigned and reoriented slightly at very little cost difference. Depending on the aesthetic feel the university would prefer either one could be built. The classical bridge has more potential for achieving a gothic feel similar to the university's current architecture. The signature bridge would stand out more as a showpiece of modern design.

Since the river flow clearance was given as a constraint both designs were kept as high in the river bed as possible. But concrete structures are inherently larger than steel structures. In choosing which design the university prefers it should be taken into consideration that the signature bridge will be 18-20 inches deep from the surface of the approaching walkway and the classical bridge will be 35 inches deep. Also it should be considered that the classical bridge has an 18 foot wide walkway but the signature bridge only has 12 feet. If 18 feet were deemed excessive, the classical bridge could be redesigned and the cost reduced. Finally the cost of each bridge, as summarized in the table 4 below, should be considered.

Table 4: Cost Comparison

	Classical Bridge		Signature Bridge	
	Polymer Concrete	Traditional Concrete	Steel Glass Deck	Steel Concrete Deck
Total Cost	\$593,240	\$561,240	\$815,540	\$635,540

Bibliography

Das, Braja M. *Fundamentals of Geotechnical Engineering*. 3rd ed. Stamford, CT.: Cengage Learning, 2008. Print.

Roark, Raymond J., and Warren C. Young. *Formulas for Stress and Strain*. 5th ed. New York: McGraw-Hill, 1975. Print.

LRFD Guide Specifications for the Design of Pedestrian Bridges. Washington, DC: American Association of State Highway and Transportation Officials, 2009. Print.

Segui, William T., and William T. Segui. *Steel Design*. 4th ed. U.S.: Cengage Learning, 2007. Print.

Specifications: American Institute of Steel Construction. 13th ed. New York: Selbstverl., 1929. Print.

Appendix

Qualifications

The design team is comprised of four senior civil engineering students at the University of Toledo. Each member has had course work in structural steel design, reinforced concrete design, fluid dynamics, and other structural and hydraulic related courses. These classes have given the group a very strong background into the necessary topics of this project. Each team member has done 3 co-operative learning terms with various companies or institutions which also will give them further background on what is needed for this project.

Team Members

Erin Davis



Erin Davis did three co-ops with Danis Construction Company. While on these co-op's she worked two semesters as an estimator and one semester on-site. The two semesters that she worked in estimating the work varied from providing quantitative take-offs on On-Screen, organized and updated drawings, participate in Pre-Bid meetings and dropped off the bids on bid day. When she was on-site she worked in Chillicothe, Ohio at Adena Hospital. This job was a 32 million dollar expansion and renovation project. While working at the Hospital she performed humidity testing on-site, conducted progress meetings with the subcontractors. Provided progress reports to the owners and subcontractors did 3-week look-a-head planner for the job site. She also filled request for information forms, and reviewed and submitted submittals and transmittals. In September she plans on starting a full-time position at Danis working as a Project Engineer.

Micah Shumway



Micah Shumway is pursuing a Bachelor of Science in Civil Engineering at the University of Toledo. He will graduate in May 2011. He has successfully completed all coursework required for the degree except the Senior Design Projects course. He has completed two co-ops with Diamond Z Engineering in Parma, Ohio where he helped update Piping and Instrumentation Diagrams (P&ID's) for BP oil terminals. This involved site visits to verify and update existing P&ID's by field inspection and working in the office to create P&ID drawings in AutoCAD as per field inspection. He also worked for the University of Toledo as a research assistant to Dr. Eddie Chou in transportation research. This involved collecting and analyzing data on current street conditions, developing a plan for the City of Toledo to repair residential streets in 2010-11. Before beginning his education in civil engineering he worked as a finished carpenter for Kustom Krafters of Toledo, Ohio for whom he built, finished and installed cabinets and other woodwork. Here he also helped build additions on several homes.

Jonathan Lidgard



Jonathan Lidgard is a student at the University of Toledo and is perusing a Bachelor of Science Degree in Civil Engineering. He has worked for 3 years as an AutoCAD technician for the University of Toledo. In his work with the University he has developed an in depth knowledge of AutoCAD as well having access to the University's archive library. He has worked on several projects for the University that includes the renovation of Savage Arena and the Stranahan Hall North addition. He has completed courses in steel design, reinforced concrete, foundation design, fluid mechanics, and structural analysis. He also has a working relationship with many of the project managers and maintenance workers for the University of Toledo in which he can gather knowledge that can become useful when designing this bridge. He also has worked with computer programs such as Microsoft Office Suite 2007, Windows 95- Windows 7, as well as SAP structural design software and C++ programming.

Shuo Xu



Shuo Xu is pursuing a Bachelor of Science in Civil Engineering at the University of Toledo. He will graduate in December 2011. He has successfully completed most of the coursework required for the degree. His computer skills include AutoCAD, Microsoft Windows XP/Vista/7, Microsoft Word, Excel and PowerPoint, SAP Structural Analysis software. He has completed one co-op with Dr. Youngwoo Seo in Civil Engineering at the University of Toledo where he works as a research assistant in Fabrication and Characterization of Chloramine Microelectrode for In-Situ Monitoring of chloramine in Water Distribution Systems. This involved collecting and analyzing data on two kinds of chemical solution and making the micro sensors.

Initial Design Considerations

Signature – Modern



Signature – Gothic



Mid-Range



Basic



ODOT Concrete Girder Specifications for Classical Bridge

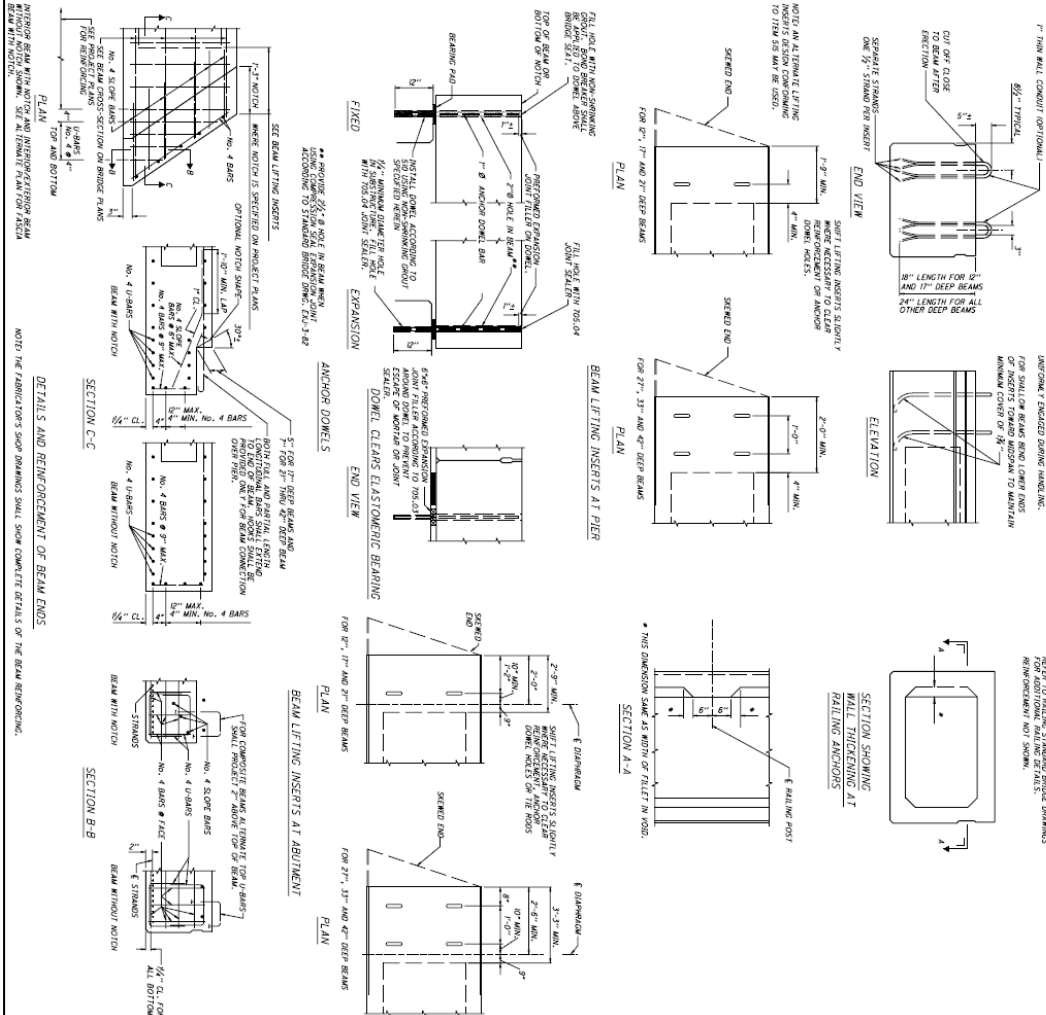

GENERAL NOTES:

1. THE DESIGNER SHALL SPECIFY THE STRENGTH AND MATERIAL PROPERTIES OF ALL MATERIALS TO BE USED IN THE STRUCTURE.
2. THE DESIGNER SHALL SPECIFY THE STRENGTH AND MATERIAL PROPERTIES OF ALL MATERIALS TO BE USED IN THE STRUCTURE.
3. THE DESIGNER SHALL SPECIFY THE STRENGTH AND MATERIAL PROPERTIES OF ALL MATERIALS TO BE USED IN THE STRUCTURE.
4. THE DESIGNER SHALL SPECIFY THE STRENGTH AND MATERIAL PROPERTIES OF ALL MATERIALS TO BE USED IN THE STRUCTURE.
5. THE DESIGNER SHALL SPECIFY THE STRENGTH AND MATERIAL PROPERTIES OF ALL MATERIALS TO BE USED IN THE STRUCTURE.
6. THE DESIGNER SHALL SPECIFY THE STRENGTH AND MATERIAL PROPERTIES OF ALL MATERIALS TO BE USED IN THE STRUCTURE.
7. THE DESIGNER SHALL SPECIFY THE STRENGTH AND MATERIAL PROPERTIES OF ALL MATERIALS TO BE USED IN THE STRUCTURE.
8. THE DESIGNER SHALL SPECIFY THE STRENGTH AND MATERIAL PROPERTIES OF ALL MATERIALS TO BE USED IN THE STRUCTURE.
9. THE DESIGNER SHALL SPECIFY THE STRENGTH AND MATERIAL PROPERTIES OF ALL MATERIALS TO BE USED IN THE STRUCTURE.
10. THE DESIGNER SHALL SPECIFY THE STRENGTH AND MATERIAL PROPERTIES OF ALL MATERIALS TO BE USED IN THE STRUCTURE.

SECTION A-A
SECTION B-B
SECTION C-C
END VIEW

DETAILS AND REINFORCEMENT OF BEAM ENDS

FIXED JOINT
EXPANSION JOINT

ANCHOR DOMESLS

BEAM LIFTING INSERTS AT ABUTMENT

BEAM LIFTING INSERTS AT PIER

SECTION SHOWING WALL THICKENING AT PILING ANCHORS

PLAN-FASCIA BEAM WITH NOTCH

DESIGN NOTES:

1. THE DESIGNER SHALL SPECIFY THE STRENGTH AND MATERIAL PROPERTIES OF ALL MATERIALS TO BE USED IN THE STRUCTURE.

2. THE DESIGNER SHALL SPECIFY THE STRENGTH AND MATERIAL PROPERTIES OF ALL MATERIALS TO BE USED IN THE STRUCTURE.

3. THE DESIGNER SHALL SPECIFY THE STRENGTH AND MATERIAL PROPERTIES OF ALL MATERIALS TO BE USED IN THE STRUCTURE.

4. THE DESIGNER SHALL SPECIFY THE STRENGTH AND MATERIAL PROPERTIES OF ALL MATERIALS TO BE USED IN THE STRUCTURE.

5. THE DESIGNER SHALL SPECIFY THE STRENGTH AND MATERIAL PROPERTIES OF ALL MATERIALS TO BE USED IN THE STRUCTURE.

6. THE DESIGNER SHALL SPECIFY THE STRENGTH AND MATERIAL PROPERTIES OF ALL MATERIALS TO BE USED IN THE STRUCTURE.

7. THE DESIGNER SHALL SPECIFY THE STRENGTH AND MATERIAL PROPERTIES OF ALL MATERIALS TO BE USED IN THE STRUCTURE.

8. THE DESIGNER SHALL SPECIFY THE STRENGTH AND MATERIAL PROPERTIES OF ALL MATERIALS TO BE USED IN THE STRUCTURE.

9. THE DESIGNER SHALL SPECIFY THE STRENGTH AND MATERIAL PROPERTIES OF ALL MATERIALS TO BE USED IN THE STRUCTURE.

10. THE DESIGNER SHALL SPECIFY THE STRENGTH AND MATERIAL PROPERTIES OF ALL MATERIALS TO BE USED IN THE STRUCTURE.

11. THE DESIGNER SHALL SPECIFY THE STRENGTH AND MATERIAL PROPERTIES OF ALL MATERIALS TO BE USED IN THE STRUCTURE.

12. THE DESIGNER SHALL SPECIFY THE STRENGTH AND MATERIAL PROPERTIES OF ALL MATERIALS TO BE USED IN THE STRUCTURE.

13. THE DESIGNER SHALL SPECIFY THE STRENGTH AND MATERIAL PROPERTIES OF ALL MATERIALS TO BE USED IN THE STRUCTURE.

14. THE DESIGNER SHALL SPECIFY THE STRENGTH AND MATERIAL PROPERTIES OF ALL MATERIALS TO BE USED IN THE STRUCTURE.

15. THE DESIGNER SHALL SPECIFY THE STRENGTH AND MATERIAL PROPERTIES OF ALL MATERIALS TO BE USED IN THE STRUCTURE.

16. THE DESIGNER SHALL SPECIFY THE STRENGTH AND MATERIAL PROPERTIES OF ALL MATERIALS TO BE USED IN THE STRUCTURE.

17. THE DESIGNER SHALL SPECIFY THE STRENGTH AND MATERIAL PROPERTIES OF ALL MATERIALS TO BE USED IN THE STRUCTURE.

18. THE DESIGNER SHALL SPECIFY THE STRENGTH AND MATERIAL PROPERTIES OF ALL MATERIALS TO BE USED IN THE STRUCTURE.

19. THE DESIGNER SHALL SPECIFY THE STRENGTH AND MATERIAL PROPERTIES OF ALL MATERIALS TO BE USED IN THE STRUCTURE.

20. THE DESIGNER SHALL SPECIFY THE STRENGTH AND MATERIAL PROPERTIES OF ALL MATERIALS TO BE USED IN THE STRUCTURE.

Summary of Meeting with River Corridor

The meeting with the River Corridor Committee was on Friday, April 29, 2011 at 8am. During this meeting Jon Lidgard and Erin Davis presented the findings of the report to the River Corridor Committee. Once the presentation was completed thirty minutes of questions were asked. These questions varied from the material chosen to how it would be installed.

Cost Estimate for Classical Bridge

Parapets- Randy Wilson of Select Thin Brick LLC

Architectural Polymer Panels with steel stud backing for support, approx. \$850.00 to \$900.00 per linear foot of pedestrian wall assembly.

- 1) This price is for 2 – 2” thick panels with 4” metal stud backup. Panels are to be installed back to back with a polymer concrete cap.
- 2) Total wall assembly will weigh approx. 50 to 60 pounds per linear foot.
- 3) FOB Toledo, OH.
- 4) This price excludes the installation portion of the project. We predict the installation portion will be approx. \$1,000 per piece.
- 5) This price includes 1 custom panel form of 15’ length and one form change to make the 10’ long pieces.
- 6) This price includes one custom wall cap form 7’-6” in length with one form change to accommodate the design.
- 7) We reserve the right to modify the price based on final construction drawings.

The above price gives you some flexibility in design. We rarely break out alternative features such as white/grey cement, architectural features, etc. The goal is to give you a price range of the material and help you understand the material. In order to gain the most value from any material, the designer should learn about the material properties, understand the manufacturing process, and design the project using these understandings. Most often once you have visited the mfg plant, you will be inspired to improve the design elements, both architecturally and structurally.

Traditional Precast Concrete Panels, approx. \$550.00 to \$600.00 per linear foot of pedestrian wall assembly.

- 1) This price includes 2 – 6” thick concrete panels installed back to back with a precast concrete cap piece.
- 2) Total wall assembly will weigh approx. 500 pounds per linear foot.
- 3) FOB Toledo, OH.
- 4) This price excludes the installation portion of the project. We predict the installation portion will be approx. \$2,000 per piece.
 - a. The weight of the panels may require a very large crane to reach the center of the bridge.

- b. This larger crane may increase this installation price considerably.
- 5) This price includes 1 custom panel form of 15' length and one form change to make the 10' long pieces.
 - 6) This price includes one custom wall cap form 7'-6" in length with one form change to accommodate the design.
 - 7) We reserve the right to modify the price based on final construction drawings.

The pros and cons are as follows:

- Polymer concrete is impervious to water, salts and the environment. It is less than 1% water absorption. Precast concrete is susceptible to erosion due to salts and weather. You will need to use all stainless steel connections for either option. The lighter weight polymer concrete will require fewer and less substantial connections.
- Polymer concrete is more expensive but will require less maintenance (cost savings). The university can clean with a power wash yearly and it does not require any waterproofing. By contrast, precast concrete as a pedestrian bridge, is recommended to be water proofed yearly due to high traffic and salts.
- Polymer concrete can give you more details than traditional precast.
- Polymer concrete's light weight will reduce the structure (cost savings), reduce the number of stainless steel connections in the structure (cost savings) and will require smaller pieces of equipment to install/deconstruct the material (cost savings).
- Most materials that claim to be environmentally friendly do not discuss deconstruction/disposal requirement. We focus more on renewable material choices, recycled content and biodegradable products. Polymer concrete is a forever material. We must give more credence to materials that can be produced once and are either maintenance free or can be deconstructed for other uses. In your case, these polymer concrete panels can be deconstructed and used for other projects (fences, screen walls, etc.)

Girders- Ed O'Connell UPI Pre-stress

Beams delivered at \$90,000.00 Lump Sum.

Erections at \$27,500.00 please note this will be very dependent on a contractor having access to both sides of the structure for crane service. If a single crane pick is mandated by site conditions there will be additional cost to erect depending on where the crane can be set up.

Asphalt- John Streicher Atlas Paving LLC



QUOTE 11103-000

Atlas Paving LLC

DATE: APRIL 15, 2011

2955 Gradwohl Rd., Toledo, OH 43617

expiration date MAY 30, 2011

Phone 419-841-5814 Fax 419-843-3152

john.streicher@atlaspaving.com

TO University of Toledo

2801 W. Bancroft Toledo, Ohio 43606

Contact Name: **Erin Davis**

Phone Number: **513-675-0869**

SALESPERSON	JOB	PAYMENT TERMS	DUE DATE
John Streicher	2" asphalt overlay pedestrian bridge	Due on receipt	

QTY	DESCRIPTION	UNIT PRICE	LINE TOTAL
2000 SF	Sweep existing surface, apply tack coat and pave with 2" of 448 Type 1 asphalt.	\$4200.00	\$4200.000
SUBTOTAL			

Cost estimate for Steel Bridge

It appears that your looking at an fabricated & erected cost of about \$450,000 for the steel frame, cables and deck. No handrail, footings, foundation or other related work is included. I've assumed a grating deck for pedestrian traffic.

We have also assumed that the worksite is open & clear and accessible. Laydown area must also be available at site.

We never received 3D model or any other construction info beyond original email.

Hope this is helpful.

Ted Hazledine



Terms and Conditions

1. All quotes are valid for 60 days from the date of issue and are subject to revision after that date.
2. Surcharges levied on Dlubak Corp. by suppliers or freight carriers will be added to the quote as a separate line item. These charges typically change on a quarterly basis; the current surcharge in place at time of invoice will apply.
3. Quotations are based on sizes, quantities, and specifications as submitted by the customer and included in our document. Any deviations such as glass type, thickness or size etc. will result in a revised quotation.
4. Estimated lead-times are based on factory workloads at the time of quotation. Actual conditions at the time of order may differ from those quoted. Dlubak Corp. will not be liable for loss or damage to any party for deliveries outside of those quoted or requested on Purchase order documents.
5. Flat glass quotations are based on a square foot basis unless otherwise noted on the document. The price will be calculated and invoiced at the next even inch. Bent Glass and Metal quotes will be based on the number of items and their make-up listed on the quotation document.
6. Dlubak Corp. cannot be responsible for taking information off of blue prints or other documents provided by our clients. We will, from time to time as a convenience, offer a non-binding budget price based on these types of documents. However it is the responsibility of the customer to supply final specifications and a complete take-off for a firm quotation.
7. All flat glass quotations are based on a 3 square foot minimum unless otherwise noted.
8. Crating estimates will be based on 2500-pound (more or less) boxes unless otherwise specified.
9. The customer must determine product compliance to all applicable building codes.
10. The customer must determine the suitability of the product for the intended use. Dlubak Corp. does not warrant its products for merchantability or fitness of use.
11. Dlubak Corp. glass products will comply with one or more of the following specifications; ASTM-C1036 (Flat glass), C-1048 (Heated Treated glass), C-1172 (Laminated glass), C-1349 (Glass Clad Polycarbonate) C-1464 (Bent glass), C-1376-03 (Pyrolytic and Vacuum coated glass) and C-1422 (Chemically Strengthened glass). In the absence of an appropriate standard specification, Dlubak Corp. will be the final arbiter as to the acceptability of the product.
12. A maximum of (2) two samples shall be provided upon request. Dlubak recommends a full size mock-up when the makeup is questionable.
13. Dlubak Corp. does not recommend the use of spandrel glass when backlighting is present.
14. Dlubak Corp. will provide a limited warranty of its products upon request. Dlubak Corporation's liability for non-conformance to a customers purchase order is limited to supplying a replacement product or refunding the value of the replacement piece. Dlubak Corp. expressly disclaims any implied warranty of fitness or merchantability of any of its products for any particular use. Under no circumstance will Dlubak Corporation be liable for any remedial action beyond that which is stated in the limited warranty document. Dlubak Corporation will not be liable for incidental or consequential damages. Warranties apply to 50 sq.ft. of product or less.
15. Glass breakage including spontaneous breakage of tempered glass is not warranted.
16. Dlubak Corp. ships its finished products via common carrier fob point of origin, unless otherwise arranged. Dlubak Corp. strongly suggests that the contents of the packages, racks or crates be inspected immediately upon receipt and in the event of damage, mark the bill of lading accordingly and file a claim with the carrier within (5) five working days to minimize the risk of rejection.
17. Dlubak Corp. incorporates a variety of compatible components from reputable sources. Dlubak will not be held responsible for non-compatibility with other glazing materials.
18. Dlubak Corporation's Accounting Department will be responsible to develop acceptable terms of payment. At times, such as with bent glass orders and specialty flat orders, deposits may be required.
19. Invoicing for pattern cuts will be based on block sizes. Invoicing for polished edges will be rounded to the next higher even inch.
20. Replacement orders will be based on low volume pricing, plus boxing and freight.

072810

Cost estimate for steel structural support under glass deck



ALRO STEEL CORPORATION

3003 AIRPORT HIGHWAY
TOLEDO, OHIO 43609 419 720-5300
DUNS: 15-764-2773

QUOTATION

ALRO QUOTE: 045987994
DATE: 4/25/11
CUST ORD:
CUST REL:

ATTN : MICAH SHUMWAY
ACCT# : 50010572
COMPANY : **University of Toledo**
ADDRESS : Dept of Physics & Astro
Toledo, OH 43606
419 530-2623

SHIP TO: UNIVERSITY OF TOLEDO
DEPT OF PHYSICS & ASTRO
TOLEDO, OH 43606

FROM: TAMMY LINNEBUR
LOCATION: TOLEDO
FAX#: 419-720-5301

FOB: YOUR PLANT
SHIP VIA: T2 TRUCK

WWW.ALRO.COM HAS A FRESH NEW LOOK!

LINE	ORD	QTY	UNIT	PART#	ITEM DESCRIPTION	WEIGHT	PRICE	EXT.PRICE	DELIVERY DATE
1		90.00	PC	05100199	4" 13# A992/A57250 WF BEAM 8 FT 4.160 X 4.060 .280 WEB Cut Tolerance: +1/8 / -0 SPLIT TO 180 PCS. 2" x 6.5# TEES		118.4000 PC	10656.00	2011/04/27

TOTAL LINES: 1 QTY: 90.00 WEIGHT: FUEL SURCHARGE: 9.95 TAX: TOTAL PRICE: 10665.95

PO# _____ SIGNED _____ FAX QUOTE ACCEPTANCE TO: 419-720-5301

DUE DATE _____ DATE _____

- * POUNDS SHOWN ARE BASED ON MATERIAL REQUIRED TO PRODUCE AND FILL YOUR ORDER AND ARE BASED ON CALCULATED WEIGHTS WITHIN NORMAL MILL TOLERANCES AND MAY VARY FROM ACTUAL WEIGHT SHIPPED.
- * THE ABOVE QUOTE IS FOR YOUR INTERNAL USE ONLY AND SHOULD NOT BE SHARED WITH ANY THIRD PARTY IN ANY FORM.
- * AVAILABILITY SUBJECT TO PRIOR SALE(S).
- * ALL AMOUNTS ARE STATED IN U.S.DOLLARS & MUST BE PAID IN U.S.DOLLARS.
- * PRICES QUOTED WILL BE HONORED IF ORDERED AND SHIPPED WITHIN 48 HOURS OF THIS QUOTE.
- * PRICES ARE PREDICATED ON RECEIVING THE TOTAL ORDER.
- * ALL OTHER ORDERS WILL BE PRICED AT PRICING LEVELS AT TIME OF DELIVERY.
- * PRICES INCLUDE RAW MATERIAL SURCHARGES WHERE APPLICABLE.
- * ALRO'S STANDARD PAYMENT TERMS ARE 1/2% 10 DAYS, NET 30 DAYS.

Steel Bridge Connection Drawings

Connection #1

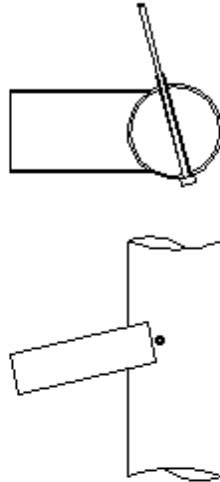

Connection #2

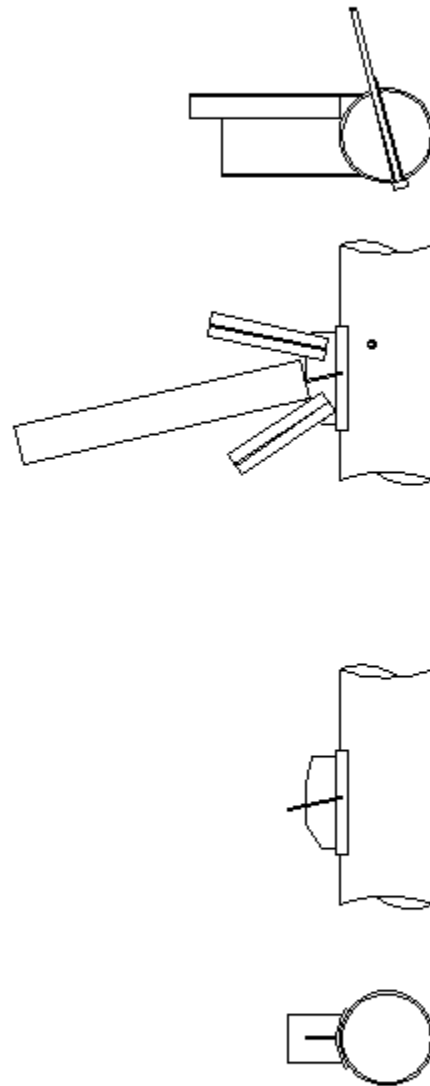

Connection #3

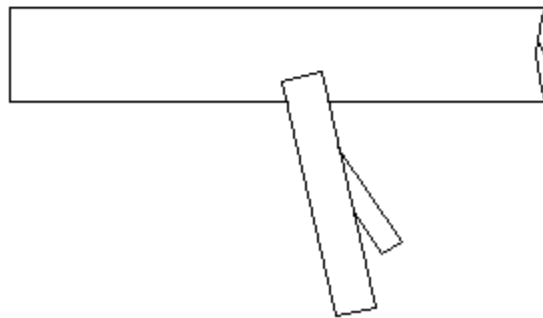
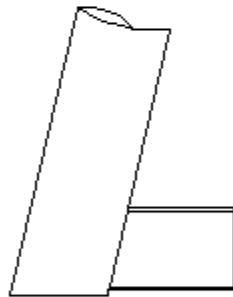
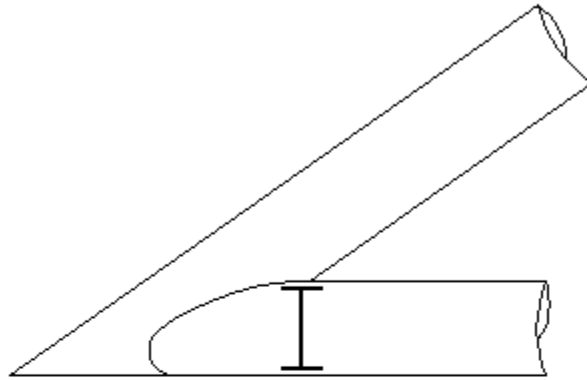

Connection #4

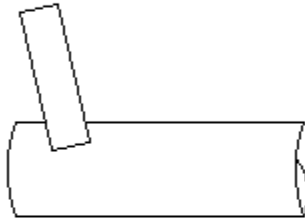

Connection #5

