



aerospace  
climate control  
electromechanical  
filtration  
fluid & gas handling  
hydraulics  
pneumatics  
process control  
sealing & shielding



## CAT 4200-M-2

Parflex Division - Multitube<sup>®</sup>

Instrument and Heat Trace Tubing Products



ENGINEERING YOUR SUCCESS.

Extra care is taken in the preparation of this literature but Parker is not responsible for any inadvertent typographical errors or omissions. Information subject to change without notice. The information in this catalog is only accurate as of the date of publication. For a more current information base, please consult the Parflex® Division web site at [www.parker.com/pfd](http://www.parker.com/pfd).



**FAILURE OR IMPROPER SELECTION OR IMPROPER USE OF THE PRODUCTS AND/OR SYSTEMS DESCRIBED HEREIN OR RELATED ITEMS CAN CAUSE DEATH, PERSONAL INJURY AND PROPERTY DAMAGE.**

This document and other information from Parker Hannifin Corporation, its subsidiaries and authorized distributors provide product and/or system options for further investigation by users having technical expertise. It is important that you analyze all aspects of your application and review the information concerning the product or system in the current product catalog. Due to the variety of operating conditions and applications for these products or systems, the user, through its own analysis and testing, is solely responsible for making the final selection of the products and systems and assuring that all performance, safety and warning requirements of the application are met.

The products described herein, including without limitation, product features, specifications, designs, availability and pricing, are subject to change by Parker Hannifin Corporation and its subsidiaries at any time without notice.

#### Offer of Sale

The items described in this document are hereby offered for sale by Parker Hannifin Corporation, its subsidiaries or its authorized distributors. This offer and its acceptance are governed by the provisions stated in the "Offer of Sale".

# Welcome to The Parflex® Division



## Our Charter

To be the global leader in engineered polymer-based products while providing system solutions for the conveyance and control of fluids

As part of the Fluid Connectors Group, the Parflex® Division is responsible for the design and manufacture of hoses and tubing to handle extreme applications. Products include thermoplastic and fluopolymer hose and tubing, hose bundles, instrumentation tubing, harnesses and accessories.











The Parflex® Division includes the Ravenna division headquarters in Ohio, and manufacturing facilities in:









- Manitowoc, WI
- Fort Worth, TX
- Stafford, TX
- Randleman, NC
- Monterrey, Mexico

<b>Section 1 — Chemical Processing &amp; Refineries</b> .....	1
- Temptube®—Single Tube Insulated.....	1
- Steam Trace—LT Series Light Trace.....	5
- Steam Trace—HT Series Heavy Trace.....	9
- Electric Trace—Self-Regulating.....	16
<b>Section 2 — Power Generation</b> .....	34
- Intermittent High Temperature Steam Purge- Freeze Protection.....	34
- Continuous High Temperature Steam Purge- Freeze Protection .....	37
<b>Section 3 — Process Control and Environmental Monitoring Systems</b> ..	40
- Analyzer Bundles.....	56
- Probe Support .....	56
- Constant Watt - Low Temperature Maintenance.....	40
- Constant Watt - High Temperature Maintenance .....	45
- Mineral Insulated - High Temperature Maintenance.....	50
<b>Section 4 — Industrial Plant - Robotics - Laboratory</b> .....	58
- Metal & Plastic tube Bundles.....	58
- Metal Tubing Bundles .....	59
- Plastic Tubing Bundles .....	62
<b>Section 5 — General Technical Data</b> .....	64
- Plastic Tubing Pressure and Chemical Compatibility Chart.....	64
- Metal Tubing Pressure and Chemical Compatibility Chart.....	67
- Jacket Material Selection Chart .....	70
- Seamless Tubing Length Chart and Physical Data .....	71
- Safety Guide .....	75

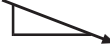
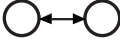

Accessories	
- RTV End Sealant..... 13	- Heat Shrink Boots..... 32
- Enclosure Feed Through..... 32	- End Seal Boot .....
- Splice Kits .....	- Self-Regulating Power Kit..... 29
- Temperature Controllers..... 31	- Constant Watt Power Kit .....

SYMBOL	DEFINITION
	Armor O.D
	Heat Loss
	Heat Gain
	Horizontal/Vertical Support Centers
	Insulation Thickness
	Jacket Thickness
	Maximum Circuit Length
	Maximum Pulling Tension
	Minimum Bend Radius
	Mounting Thread Size
	Nominal Product O.D.

SYMBOL	DEFINITION
	Nominal Throat Diameter
	Number of Tubes
	R-Factor
	Part Number
	Process Tube O.D.
	Product Weight
	Shipping Weight
	Slope
	Spacing
	Tracer Tube O.D.



## Section 1

## Temptube® Preinsulated Tubing

**Introduction:**

Parflex Temptube® Preinsulated tubing is thermally insulated with a non-hygroscopic inorganic fiberglass material and protected with a flexible, black, flame-resistant PVC jacket.

**Performance Data:**

Parflex standard Temptube® is thermally insulated for transfer of fluids or gases up to 400°F (204°C) while maintaining an outer jacket surface temperature of 140°F (60°C), meeting NEC Personnel Protection Code 427.12.

Insulated bundles rated up to 1200°F (649°C) are available upon request. Contact Parker Hannifin for more details.

Tubing is available in many alloys and sizes, including metric size. See “How to Order” on page 3 for specifying part numbers to meet your application.

**General:**

Parflex Temptube® is designed to provide an economical and highly efficient method of conveying steam or other hot materials through a plant and is intended to replace hard piping and field-installed insulation.

**Applications:**

The Temptube® products are typically used in steam supply lines, condensate return lines, cooling water lines, lubrication lines, refrigeration lines, and liquid nitrogen lines.

**Tubing:**

Type 122 DHP Seamless Copper and 316/316L Welded and Seamless Stainless Steel are standard. Additional materials and wall thicknesses are available upon request. For material specification of metal tubing, see technical data section of the catalog. Consult Division for details.

**Insulation:**

Air-spaced, cross wrapped applied non-hygroscopic fiberglass thermal insulation provides minimum heat loss. Optional insulation thicknesses are available; such as, 0.36”, 0.72” and 0.96” insulation used in Cryogenic, Liquid CO<sub>2</sub> and Liquid Nitrogen applications, see Performance Chart for heat gain rates. For other thicknesses, consult factory.

**Jacket:**

The tough, black, 105°C-rated, flame-resistant PVC (FR-PVC) jacket protects the tubing against corrosive atmospheres, water, oils, acids, alkalies and most chemicals. Additional jacket materials are available upon request. For jacket material specifications, see the Technical Data section of the catalog. Consult Division for additional details.

**Testing:**

Each tube in every length of Parflex Temptube® is pressure tested prior to shipment to assure the instrument engineer a high-quality, reliable, trouble-free product. For Testing Specifications, see Technical Data Section of the catalog.

**Accessories:**

Accessories are available for connecting multiple lengths of Temptube® bundles and sealing bundle ends.

**NOTE:** It is absolutely necessary to seal the ends against contamination from moisture and/or corrosive liquids. Parker Hannifin cannot assume any liability for product damage caused by moisture from unsealed ends.

## How To Specify & Order

### TT— Temptube<sup>®</sup>, Single Tube Preinsulated Bundle

Maximum Internal Exposure up to 400°F (204°C)

**TT - 2 08 35 - V B**

<b>TT</b>	<b>Bundle Type</b>	<b>2</b>	<b>Process Tube Material</b>	<b>08</b>	<b>Process Tube Size</b>	<b>35</b>	<b>Process Tube Size</b>
	TT= Temptube Single Tube Insulated and Jacketed		1= Smls Copper Type DHP Alloy No 122. ASTM B68/B75 2= Welded Stainless Steel Type 316/316L ASTM A269 3= Welded Stainless Steel Type 304 ASTM A269 B= Smls 316/316L ASTM A269 C= Smls 304 ASTM A269 D= Smls Monel Type 400 E= Smls Hastelloy C22 H= Smls 316H ASTM A213 I = Smls Incoloy 825 L= Electropolish Smls 316/316L ASTM A 269 (10Ra Max) M= Smls 316/316L ASTM A213 S= Silco Smls 316/316L ASTM A269 P= PFA Fluoropolymer F= FEP Fluoropolymer T= TFE Fluoropolymer 7= Parflex 919 PTFE SS Braided Hose 9= Customer Specified Tube Material		<b>O.D.</b> See Selection Charts Imperial 02=1/8" 03=3/16" 04=1/4" 05=5/16" 06=3/8" 07=7/16" 08=1/2" 10=5/8" 12=3/4" 16=1" Metric MA=2mm MB=4mm MC=6mm MD=8mm ME=10mm MF=12mm MG=14mm MH=16mm		<b>Wall Thickness</b> See Selection Charts Imperial 16=.016" 20=.020" 28=.028" 30=.030 31=.031" 32=.032" 35=.035" 40=.040" 47=.047" 49=.049" 50=.050" 62=.062" 65=.065" 83=.083" Metric 89=.89mm 10=1.0mm 15=1.5mm 20=2.0mm 25=2.5mm

<b>V</b>	<b>Jacket Material</b>	<b>B</b>	<b>Jacket Color</b>
	V=FR-PVC T=FR-TPE U=FR-PUR P=PUR R=TPR E=FRPE L=LDPE F=PVDF		N=Black, B=Blue G=Green O=Orange Y=Yellow P=Purple R=Red W=White
	Note: Parflex standard jacket material is FR-PVC		Note: Parflex standard color jacket is black

Note: For standard black FR-PVC jacketed products the -VN may be dropped.

## Physical Data\*

#	Tubing			Insulation Thickness (in.)***	Jacket Thickness (in.)	Nominal Product O.D. (in.)	Minimum Bending Radius (in.)	Maximum Pulling Tension (lbs.)	Product Weight (lbs/100ft)	Horizontal/ Vertical Support Centers (ft.)
	Size (in.)									
	Material	O.D.	Wall							
TT-10430	Copper	1/4	0.030	0.20	.08	.81	8	150	21.6	5
TT-10632	Copper	3/8	0.032	0.24	.08	1.01	10	250	31.7	6
TT-10835	Copper	1/2	0.035	0.24	.08	1.14	12	350	40.8	8
TT-10649	Copper	3/8	0.049	0.24	.08	1.01	10	250	37.8	6
TT-10849	Copper	1/2	0.049	0.24	.08	1.14	12	350	47.9	8
TT-20435	Welded Stainless Steel	1/4	0.035	0.20	.08	.81	8	250	21.7	6
TT-20635	Welded Stainless Steel	3/8	0.035	0.24	.08	1.01	10	400	31.1	7
TT-20835	Welded Stainless Steel	1/2	0.035	0.24	.08	1.14	12	550	38.5	8
TT-20849	Welded Stainless Steel	1/2	0.049	0.24	.08	1.14	12	550	44.8	8
TT-B0435	Seamless Stainless Steel	1/4	0.035	0.20	.08	.81	8	250	21.7	6
TT-B0635	Seamless Stainless Steel	3/8	0.035	0.24	.08	1.01	10	400	31.1	7
TT-B0835	Seamless Stainless Steel	1/2	0.035	0.24	.08	1.14	12	550	38.5	8
TT-B0849	Seamless Stainless Steel	1/2	0.049	0.24	.08	1.14	12	550	44.8	8

\*All values are nominal. Dimensional data to be used as reference only.

\*\*Available with .049" wall copper tubing.

\*\*\*Optional insulation thicknesses are available. For other thicknesses, consult factory.

## Performance Characteristics

Steam Pressure and Temperature			50 PSIG @ 298°F	80 PSIG @ 329°F	100 PSIG @ 338°F	120 PSIG @ 350°F	150 PSIG @ 366°F	230 PSIG @ 400°F						
Ambient Temperature			80°F	80°F	80°F	80°F	80°F	80°F						
Tube O.D. (in.)	Nominal Product O.D. (in.)	Insul. Thick (in.)	Heat Loss*	Jacket temp**	Heat Loss*	Jacket temp**	Heat Loss*	Jacket temp**	Heat Loss*	Jacket temp**	Heat Loss*	Jacket temp**	Heat Loss*	Jacket temp**
1/4	.81	.20	28.5	120	31.9	125	33.7	128	35.3	130	37.4	133	41.8	139
3/8	1.015	.24	33.6	118	37.6	122	39.8	125	41.6	127	44.1	130	49.3	136
1/2	1.14	.24	40.4	121	45.3	125	47.8	128	50.1	130	53.0	133	59.3	140

\*Heat loss is measured in Btu/Hr., per linear foot of tubing

\*\*Jacket temperature measured at the surface in °F.

NOTE: The performance figures presented above have been calculated to be used as a guide only. Actual performance may vary with individual plant conditions.



## Performance Characteristics

Part Number  #	Tubing		Insulation Thickness (in.)*	Jacket Thickness (in.)	Nominal Product O.D. (in.)	Heat Gain/Loss Rates & R-factors at 70° F ambient					
	Size (in.)					Process, LN2 = -320°F		Process, Liquid CO2 = -70°F		Process, Steam = 400°F	
	O.D.	Wall				Heat Gain Rate, (BTU/hr) ft	R=factor, °F/ (BTU/hr) ft	Heat Gain Rate, (BTU/hr) ft	R=factor, °F/ (BTU/hr) ft	Heat Loss Rate, (BTU/hr) ft	R=factor, °F/ (BTU/hr) ft
TT-10430-VN-I	1/4	.030	.36	.08	1.13	18.3	21.3	10.7	13.0	30.9	10.7
TT-10632-VN-I	3/8	.032	.36	.08	1.26	23.0	17.0	13.4	10.4	38.5	8.6
TT-10835-VN-I	1/2	.035	.36	.08	1.38	27.5	14.2	16.0	8.8	45.7	7.2
TT-20435-VN-I	1/4	.035	.36	.08	1.13	18.3	21.3	10.7	13.0	30.9	10.7
TT-20635-VN-I	3/8	.035	.36	.08	1.26	23.0	17.0	13.4	10.4	38.5	8.6
TT-20835-VN-I	1/2	.035	.36	.08	1.38	27.5	14.2	16.0	8.8	45.7	7.2
TT-10430-VN-R	1/4	.030	.72	.08	1.85	13.5	29.0	8.1	17.3	23.5	14.0
TT-10632-VN-R	3/8	.032	.72	.08	1.98	16.3	24.0	9.7	14.4	28.3	11.7
TT-10835-VN-R	1/2	.035	.72	.08	2.10	18.9	20.7	11.3	12.4	32.8	10.1
TT-20435-VN-R	1/4	.035	.72	.08	1.85	13.5	29.0	8.1	17.3	23.5	14.0
TT-20635-VN-R	3/8	.035	.72	.08	1.98	16.3	24.0	9.7	14.4	28.3	11.7
TT-20835-VN-R	1/2	.035	.72	.08	2.10	18.9	20.7	11.3	12.4	32.8	10.1
TT-10430-VN-X	1/4	.030	.96	.08	2.33	12.0	32.5	7.2	19.3	21.2	15.6
TT-10632-VN-X	3/8	.032	.96	.08	2.46	14.3	27.3	8.6	16.3	25.1	13.1
TT-10835-VN-X	1/2	.035	.96	.08	2.58	16.4	23.8	9.9	14.2	28.8	11.5
TT-20435-VN-X	1/4	.035	.96	.08	2.33	12.0	32.5	7.2	19.3	21.2	15.6
TT-20635-VN-X	3/8	.035	.96	.08	2.46	14.3	27.3	8.6	16.3	25.1	13.1
TT-20835-VN-X	1/2	.035	.96	.08	2.85	16.4	23.8	9.9	14.2	28.8	11.5

\*Optional insulation thicknesses are available. For other thicknesses, consult factory.

NOTE: The performance figures presented above have been calculated to be used as a guide only. Actual performance may vary with individual plant conditions.



## LT— Light Steam Trace

Maximum Internal Exposure Temperature Rating up to 400°F (204°F)



### General

Parker LT Temptrace® Light Steam Trace Tubing consists of single or multiple process tubes insulated from a single tracer with non-hygroscopic glass fiber insulation and overall non-hygroscopic glass fiber insulation and black, 105°C rated, flame-resistant PVC (FR PVC) jacket.

The LT Series Temptrace® is designed to utilize saturated steam pressures to 230 PSIG (15.8 BAR) and 400°F (204.4°C) without generating a process tube temperature in excess of 200°F (93°C) or a jacket surface temperature greater than 140°F (60°C) at 80°F (26.6°C) ambient. Standard product has a Maximum Temperature Rating (MTR\*) of 400°F (204.4°C). Higher temperature rated designs are available. Consult Division for details.

\*Maximum Temperature Rating is the maximum allowable temperature of the tracing fluid. Temperatures in excess of this may damage the product or alter its performance.

### Applications

The LT Temptrace® permits use of higher pressure steam to heat trace instrument lines carrying water, light oil, paraffin, paraffin-based fluids and temperature-sensitive chemicals. Parker LT Temptrace® is ideal for simple instrument line freeze protection and viscosity maintenance applications.

### Tubing

Type 122 DHP Seamless Copper and 316/316L Welded Stainless Steel are standard. Additional materials, wall thicknesses and seamless stainless steel are available upon request. For Material Specifications of metal tubing, see *Technical Data* section of the catalog. Consult Division for details.

### Insulation

Air-spaced, cross wrapped applied non-hygroscopic fiberglass thermal insulation for minimum heat loss. The insulated tracer provides a more constant process tube temperature over long tubing runs.

### Jacket

The tough, black, 105°C rated, flame-resistant PVC (FR PVC) jacket protects the tubing against corrosive atmospheres, water, oils, acids, alkalies and most chemicals. Additional jacket materials are available upon request. For Material Specifications of jackets, see *Technical Data* section of the catalog. Consult Division for additional details.

### Testing

Each tube in every length of Parker Temptrace® is pressure tested prior to shipment to assure the instrument engineer a high quality, reliable, trouble-free product. For Testing Specifications, see *Technical Data* section of the catalog.

### Accessories

Accessories are available for connecting multiple lengths of steam trace bundles and sealing bundle ends.

**NOTE:** It is absolutely necessary to seal the ends against contamination from moisture and/or corrosive liquids. Parker Hannifin cannot assume any liability for product damage caused by moisture from unsealed ends.

# How to Specify & Order

## LT – Light Steam Trace Bundles

Maximum Internal Exposure up to 400°F (204°C)

**LT - 2 08 35 B - 2 06 35 - V B**

LT	Bundle Type	2	Process Tube Material	08	Process Tube Size	35	Process Tube Size	B	Number of Process Tubes
	LT= Light Trace Temptrace™		1= Smls Copper Type DHP Alloy No 122. ASTM B68/B75 2= Welded Stainless Steel Type 316/316L ASTM A269 3= Welded Stainless Steel Type 304 ASTM A269 B= Smls 316/316L ASTM A269 C= Smls 304 ASTM A269 D= Smls Monel Type 400 E= Smls Hastelloy C22 H= Smls 316H ASTM A213 I = Smls Incoloy 825 L= Electropolish Smls 316/316L ASTM A269 (10Ra Max) M=Smls 316/316L ASTM A213 S= Silco Smls 316/316L Stainless ASTM A269 P= PFA Fluoropolymer F= FEP Fluoropolymer T= TFE Fluoropolymer 7= Parflex 919 PTFE SS Braided Hose 9= Customer Specified Tube Material		<b>O.D.</b> See Selection Charts Imperial 02=1/8" 03=3/16" 04=1/4" 05=5/16" 06=3/8" 07=7/16" 08=1/2" 10=5/8" 12=3/4" 16=1" Metric MA=2mm MB=4mm MC=6mm MD=8mm ME=10mm MF=12mm MG=14mm MH=16mm		<b>Wall Thickness</b> See Selection Charts Imperial 16=.016" 20=.020" 28=.028" 30=.030 31=.031" 32=.032" 35=.035" 40=.040" 47=.047" 49=.049" 50=.050" 62=.062" 65=.065" 83=.083" Metric 89=.89mm 10=1.0mm 15=1.5mm 20=2.0mm 25=2.5mm		A= 1 Tube B= 2 Tubes C= 3 Tubes etc.

2	Tracer Tube Material	06	Tracer Tube Size	35	Tracer Tube Size	V	Jacket Material	B	Jacket Color
	1= Smls Copper Type DHP Alloy No 122. ASTM B68-B75 2= Welded Stainless Steel Type 316/316L ASTM A269 3= Welded Stainless Steel Type 304 ASTM A269 B= Smls 316/316L ASTM A269 C= Smls 304 ASTM A269 D= Smls Monel Type 400 E= Smls Hastelloy C22 H= Smls 316H ASTM A213 I = Smls Incoloy 825 L= Electropolish Smls 316/316L ASTM A269 (10Ra Max) M=Smls 316/316L ASTM A213 S= Silco Smls 316/316L Stainless ASTM A269 P= PFA Fluoropolymer F= FEP Fluoropolymer T= TFE Fluoropolymer 7= Parflex 919 PTFE SS Braided Hose 9= Customer Specified Tube Material		<b>O.D.</b> See Selection Charts Imperial 02=1/8" 03=3/16" 04=1/4" 05=5/16" 06=3/8" 07=7/16" 08=1/2" 10=5/8" 12=3/4" 16=1" Metric MA=2mm MB=4mm MC=6mm MD=8mm ME=10mm MF=12mm MG=14mm MH=16mm		<b>Wall Thickness</b> See Selection Charts Imperial 16=.016" 20=.020" 28=.028" 30=.030 31=.031" 32=.032" 35=.035" 40=.040" 47=.047" 49=.049" 50=.050" 62=.062" 65=.065" 83=.083" Metric 89=.89mm 10=1.0mm 15=1.5mm 20=2.0mm 25=2.5mm		V=FR-PVC T=FR-TPE U=FR-PUR P=PUR R=TPR E=FRPE L=LDPE F=PVDF Note: Parflex standard jacket material is FR-PVC		N=Black B=Blue G=Green O=Orange Y=Yellow P=Purple R=Red W=White Note: Parflex standard color jacket is black Note: For standard black FR-PVC products the -VN may be dropped.



## Performance Data

### Light Steam Trace Tubing— Single Process Tube

These performance graphs are based on a 1/4" process tube and a 1/4" tracer tube. Apply run length and temperature correction factors for other process and tracer tube sizes.

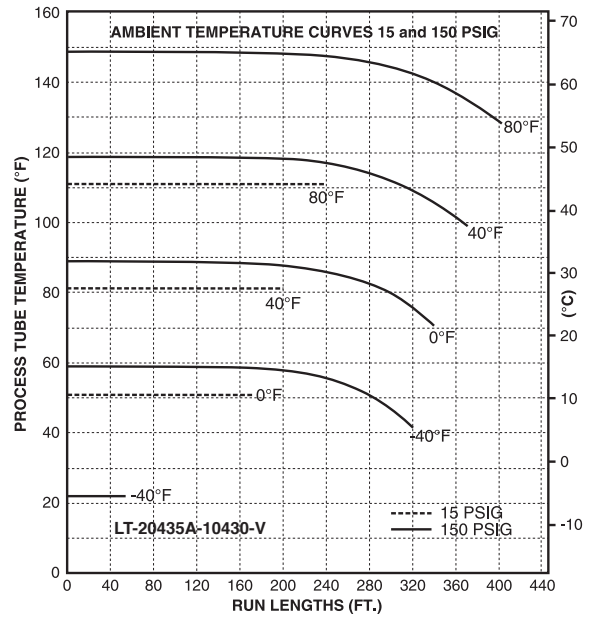
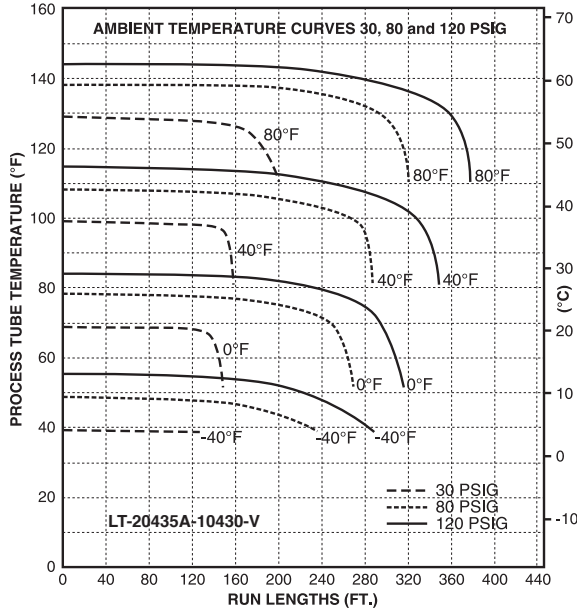



## Performance Data

### Light Steam Trace Tubing— Multiple Process Tubes

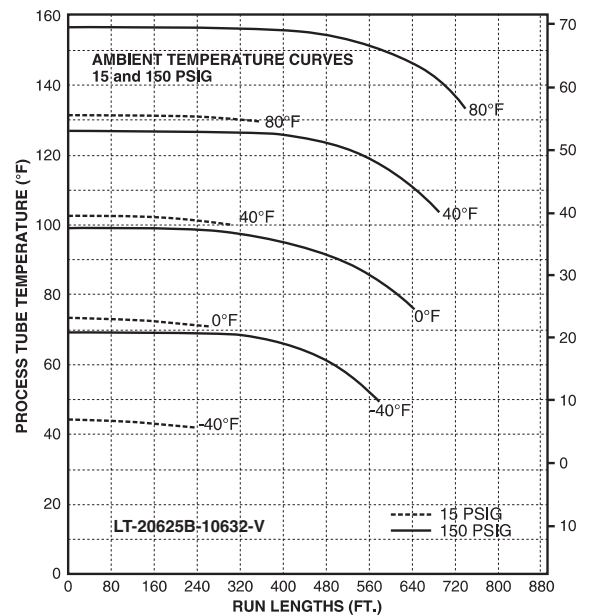
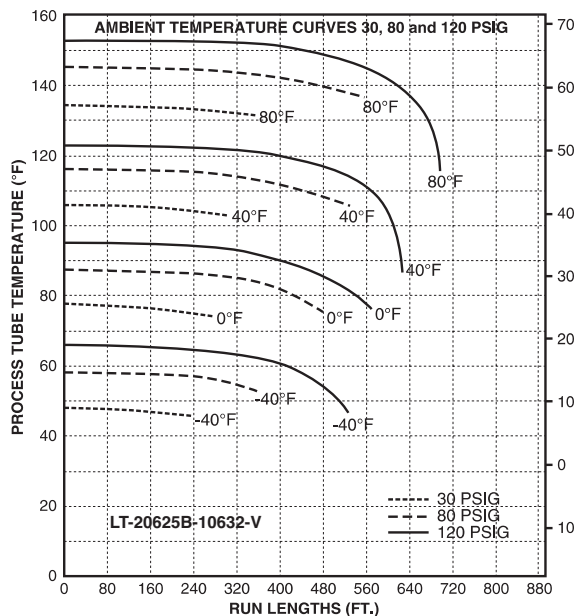
These performance graphs are based on 3/8" process tubes and a 3/8" tracer tube. Apply run length and temperature correction factors for other process and tracer tube sizes.









## Light Steam Trace Performance Chart

Part Number #	Process Tube O.D. (in.)	Tracer Tube O.D. (in.)	Heat Loss (BTU/hr ft-°F) (DT = 100°F)	Temperature	Run Length (ft.)
				Correction Factors	
<b>Light Trace – Single Process Tube</b>					
LT-20435A-10430	1/4	1/4	10.9	1	1
LT-20635A-10430	3/8	1/4	10.9	0.97	0.9
LT-20835A-10430	1/2	1/4	10.9	0.95	0.8
LT-20635A-10632	3/8	3/8	13.7	–	–
LT-20835A-10632	1/2	3/8	13.7	1.07	1.44
<b>Light Trace – Dual Process Tube</b>					
LT-20435B-10430	(2) 1/4	1/4	10.9	–	–
LT-20635B-10430	(2) 3/8	1/4	10.9	–	–
LT-20835B-10430	(2) 1/2	1/4	10.9	–	–
LT-20635B-10632	(2) 3/8	3/8	13.7	1	1
LT-20835B-10632	(2) 1/2	3/8	13.7	0.98	0.9

LT—Light Steam Trace performance graphs are based upon a 1/4” process tube and a 1/4” tracer tube. Temperature and run length correction factors for other sizes can be determined using the chart provided.

## Installation Guide— Light Steam Trace

Part Number #	Process Tube O.D. (in.)	Tracer Tube O.D.(in.)	Nominal Product O.D. (in.)	Product Weight (lbs./ft.)	Minimum Bend Radius (in.)	Horizontal/ Vertical Support Centers (ft.)	Slope
	 Welded Stainless*	 Copper					
<b>Light Trace-Single Process Tube</b>							
LT-20435A-10430	1/4	1/4	1.3	.385	10	5-6' 10-15'	1" in 8'
LT-20635A-10430	3/8	1/4	1.4	.453	12	5-6' 10-15'	1" in 6'
LT-20835A-10430	1/2	1/4	1.5	.519	14	5-6' 10-15'	1" in 3'
LT-20635A-10632	3/8	3/8	1.5	.531	12	5-6' 10-15'	1" in 7'
LT-20835A-10632	1/2	3/8	1.6	.598	14	5-6' 10-15'	1" in 6'
<b>Light Trace-Dual Process Tube</b>							
LT-20435B-10430	(2) 1/4	1/4	1.3	.473	14	5-6' 10-15'	1" in 8'
LT-20635B-10430	(2) 3/8	1/4	1.5	.599	15	5-6' 10-15'	1" in 6'
LT-20835B-10430	(2) 1/2	1/4	1.6	.778	16	5-6' 10-15'	1" in 3'
LT-20635B-10632	(2) 3/8	3/8	1.6	.675	16	5-6' 10-15'	1" in 7'
LT-20835B-10632	(2) 1/2	3/8	1.7	.803	18	5-6' 10-15'	1" in 6'

\*Available in seamless stainless steel and other alloys



## HT— Heavy Steam Trace

Maximum Internal Exposure Temperature up to 400°F (204°C)



### General

Parflex HT—Heavy Steam Trace Tubing consists of a single process tube and tracer, non-hygroscopic glass fiber insulation and a black, 105°C-rated, flame-resistant PVC (FR-PVC) jacket.

HT—Heavy Steam Trace Tubing is designed to be used with steam pressures of 15 PSIG (1 BAR) to 230 PSIG (15.8 BAR) and maintain process tube temperatures from 200°F (93°C), at -40°F (-40°C) ambient, to 355°F (179°C), at 80°F (26.6°C) ambient, with product surface temperatures of less than 140°F (60°C) at 80°F (26.6°C) ambient. Standard product has a Maximum Temperature Rating (MTR\*) of 400°F (204.4°C). Higher temperature rated designs are available; consult Division for details.

\*Maximum Temperature Rating is the maximum allowable temperature of the tracing fluid. Temperatures in excess of this may damage the product or alter its performance.

### Applications

HT—Heavy Steam Trace Tubing is used with high temperature steam to heat trace instrument size lines when elevated temperatures are required. Such applications as pressure transmission and analyzer sample lines carrying heavy oils or distillates, gases or vapors are ideal service for the HT—Heavy Steam Trace Tubing products. The direct tracer to process tube contact produces higher process tube temperatures than the light trace product.

### Tubing

Type 122 DHP Seamless Copper and 316/316L Welded Stainless Steel are standard. Additional materials, wall thicknesses and seamless stainless steel are available upon request. For Material Specifications of metal tubing, see *Technical Data* section of the catalog. Consult Division for details.

### Tubing Identification

When the process tube and tracer tube are the same size and material, each individual tube is printed with a tube number at two-inch intervals.

### Insulation

Air-spaced, cross wrapped applied non-hygroscopic fiberglass thermal insulation provides minimum heat loss.

### Jacket

The tough, black, 105°C-rated, flame-resistant PVC (FR-PVC) jacket protects the tubing against corrosive atmospheres, water, oils, acids, alkalies and most chemicals. Additional jacket materials are available upon request. For Material Specifications of jackets, see *Technical Data* section of the catalog. Consult Division for additional details.

### Testing

Each tube in every length of Parflex Temptrace™ is pressure tested prior to shipment to assure the instrument engineer a high-quality, reliable, trouble-free product. For Testing Specifications, see *Technical Data* Section of the catalog.

### Accessories

Accessories are available for connecting multiple lengths of steam trace bundles and sealing bundle ends.

**NOTE:** It is absolutely necessary to seal the ends against contamination from moisture and/or corrosive liquids. Parker Hannifin cannot assume any liability for product damage caused by moisture from unsealed ends.



## How To Specify & Order

### HT – Heavy Steam Trace Bundles

Maximum Internal Exposure up to 400°F (204°C)

**HT - 2 08 35 B - 2 06 35 - V B**

HT	Bundle Type	2	Process Tube Material	08	Process Tube Size	35	Process Tube Size	B	Number of Process Tubes
	HT= Heavy Trace Temptrace		1= Smls Copper Type DHP Alloy No 122. ASTM B68/B75 2= Welded Stainless Steel Type 316/316L ASTM A269 3= Welded Stainless Steel Type 304 ASTM A269 B= Smls 316/316L ASTM A269 C= Smls 304 ASTM A269 D= Smls Monel Type 400 E= Smls Hastelloy C22 H= Smls 316H ASTM A213 I = Smls Incoloy 825 L= Electropolish Smls 316/316L ASTM A269 (10Ra Max) M=Smls 316/316L ASTM A213 S= Silco Smls 316/316L ASTM A269 P= PFA Fluoropolymer F= FEP Fluoropolymer T= TFE Fluoropolymer 7= Parflex 919 PTFE SS Braided Hose 9= Customer Specified Tube Material		<b>O.D.</b> See Selection Charts Imperial 02=1/8" 03=3/16" 04=1/4" 05=5/16" 06=3/8" 07=7/16" 08=1/2" 10=5/8" 12=3/4" 16=1" Metric MA=2mm MB=4mm MC=6mm MD=8mm ME=10mm MF=12mm MG=14mm MH=16mm		<b>Wall Thickness</b> See Selection Charts Imperial 16=.016" 20=.020" 28=.028" 30=.030" 31=.031" 32=.032" 35=.035" 40=.040" 47=.047" 49=.049" 50=.050" 62=.062" 65=.065" 83=.083" Metric 89=.89mm 10=1.0mm 15=1.5mm 20=2.0mm 25=2.5mm		A= 1 Tube B= 2 Tubes C= 3 Tubes etc.

2	Tracer Tube Material	06	Tracer Tube Size	35	Tracer Tube Size	V	Jacket Material	B	Jacket Color
	1= Smls Copper Type DHP Alloy No 122. ASTM B68/B75 2= Welded Stainless Steel Type 316/316L ASTM A269 3= Welded Stainless Steel Type 304 ASTM A269 B= Smls 316/316L ASTM A269 C= Smls 304 ASTM A269 D= Smls Monel Type 400 E= Smls Hastelloy C22 H= Smls 316H ASTM A213 I = Smls Incoloy 825 L= Electropolish Smls 316/316L ASTM A269 (10Ra Max) M=Smls 316/316L ASTM A213 S= Silco Smls 316/316L ASTM A269 P= PFA Fluoropolymer F= FEP Fluoropolymer T= TFE Fluoropolymer 7= Parflex 919 PTFE SS Braided Hose 9= Customer Specified Tube Material		<b>O.D.</b> See Selection Charts Imperial 02=1/8" 03=3/16" 04=1/4" 05=5/16" 06=3/8" 07=7/16" 08=1/2" 10=5/8" 12=3/4" 16=1" Metric MA=2mm MB=4mm MC=6mm MD=8mm ME=10mm MF=12mm MG=14mm MH=16mm		<b>Wall Thickness</b> See Selection Charts Imperial 16=.016" 20=.020" 28=.028" 30=.030" 31=.031" 32=.032" 35=.035" 40=.040" 47=.047" 49=.049" 50=.050" 62=.062" 65=.065" 83=.083" Metric 89=.89mm 10=1.0mm 15=1.5mm 20=2.0mm 25=2.5mm		V=FR-PVC T=FR-TPE U=FR-PUR P=PUR R=TPR E=FRPE L=LDPE F=PVDF Note: Parflex standard jacket material is FR-PVC		N=Black B=Blue G=Green O=Orange Y=Yellow P=Purple R=Red W=White Note: Parflex standard color jacket is black Note: For standard black FR-PVC jacketed products the -VN may be dropped.

## Performance Data

### HT – Heavy Steam Trace Tubing – Single Process Tubes

These performance graphs are based on a 1/4" process tube and a 1/4" tracer tube. Apply run length and temperature correction factors for other process and tracer tube sizes.

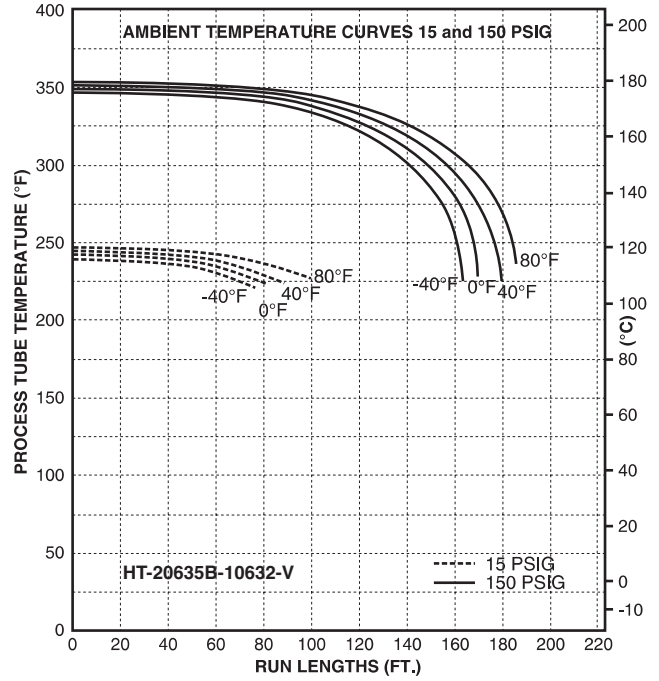
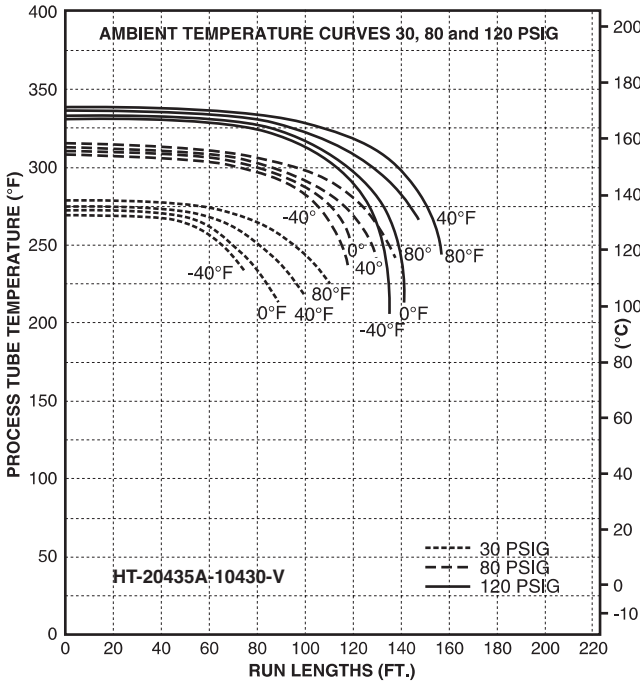



## Performance Data

### HT – Heavy Steam Trace Tubing – Multiple Process Tubes

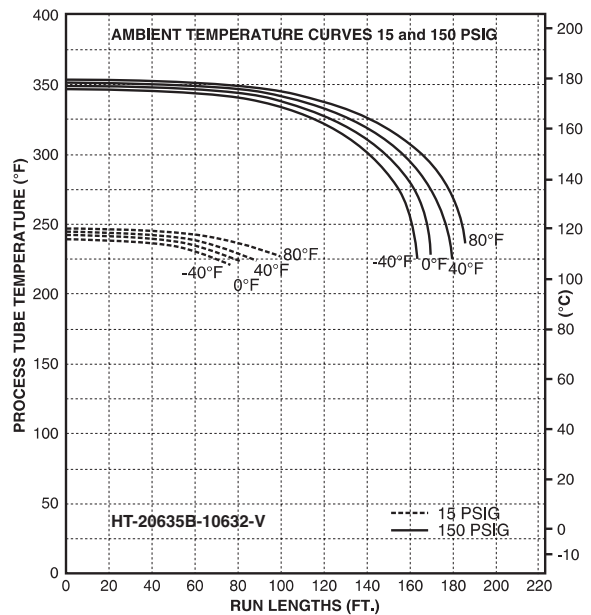
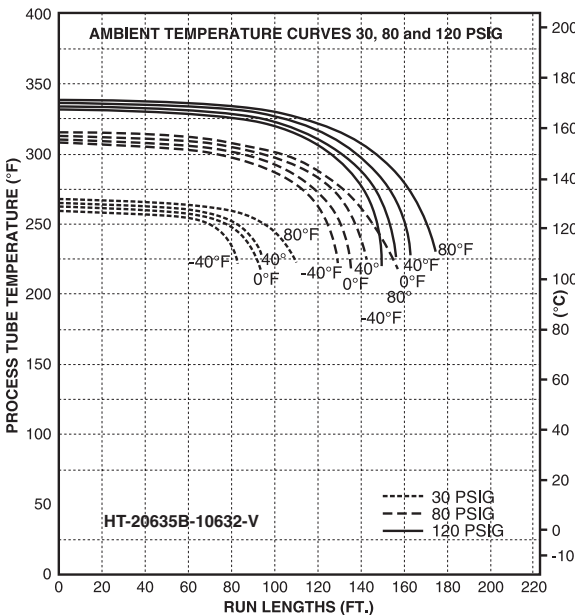
These performance graphs are based on 3/8" process tubes and a 3/8" tracer tube. Apply run length and temperature correction factors for other process and tracer tube sizes.









## Heavy Steam Trace Performance Chart

Part Number #	Process Tube O.D.	Tracer Tube O.D.	Heat Loss (BTU/hr ft-°F) (DT = 100°F)	Temperature	Run Length (ft.)
				Correction Factor	
<b>Heavy Trace-Single Process Tube</b>					
HT-20435A-10430	1/4	1/4	15.3	1	1
HT-20635A-10430	3/8	1/4	18.3	0.995	0.85
HT-20835A-10430	1/2	1/4	20.7	0.99	0.76
HT-20635A-10632	3/8	3/8	19.9	1.06	2.09
HT-20835A-10632	1/2	3/8	23.1	1.04	2.05
<b>Heavy Trace-Dual Process Tube</b>					
HT-20435B-10430	(2) 1/4	1/4	18	--	--
HT-20635B-10430	(2) 3/8	1/4	21.9	--	--
HT-20835B-10430	(2) 1/2	1/4	25.8	--	--
HT-20635B-10632	(2) 3/8	3/8	25.8	1	1
HT-20835B-10632	(2) 1/2	3/8	27.7	0.996	0.90

HT—Heavy Steam Trace performance graphs are based upon a 1/4" process tube and a 1/4" tracer tube. Temperature and run length correction factors for other sizes can be determined using the chart provided

## Installation Guide— Heavy Steam Trace

Part Number #	Process Tube O.D. (in.)	Tracer Tube O.D. (in.)	Nominal Product O.D. (in.)	Product Weight (lbs./ft.)	Minimum Bend Radius (in.)	Horizontal/Vertical Support Centers (ft.)	Slope
							
<b>Heavy Trace – Single Process Tube</b>							
HT-20435A-10430	1/4	1/4	1.1	.376	8	5-6' 10-15'	1" in 8'
HT-20635A-10430	3/8	1/4	1.3	.446	10	5-6' 10-15'	1" in 6'
HT-20835A-10430	1/2	1/4	1.4	.520	12	5-6' 10-15'	1" in 3'
HT-20635A-10632	3/8	3/8	1.3	.526	12	5-6' 10-15'	1" in 7'
HT-20835A-10632	1/2	3/8	1.5	.594	14	5-6' 10-15'	1" in 6'
<b>Heavy Trace – Dual Process Tube</b>							
HT-20435B-10430	(2) 1/4	1/4	1.2	.479	12	5-6' 10-15'	1" in 8'
HT-20635B-10430	(2) 3/8	1/4	1.4	.608	13	5-6' 10-15'	1" in 6'
HT-20835B-10430	(2) 1/2	1/4	1.6	.743	13	5-6' 10-15'	1" in 3'
HT-20635B-10632	(2) 3/8	3/8	1.5	.682	13	5-6' 10-15'	1" in 7'
HT-20835B-10632	(2) 1/2	3/8	1.7	.812	14	5-6' 10-15'	1" in 6'

## Steam Trace Accessory Selections

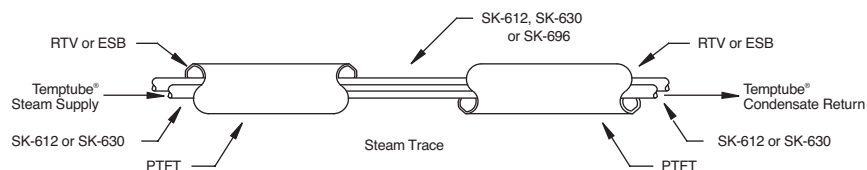

### End Sealant

Parflex end sealant is a paste material which becomes a tough, rubbery seal upon exposure to air. Total curing takes about 24 hours, at which time it has excellent resistance to weather, ozone, oil, many chemicals and extreme temperatures “-75°F (-60°C) to +400°F (204.4°C). High temperature sealant to 500°F (260°C) available.

**To order:** Specify Parflex room temperature vulcanizing (RTV) end sealant part numbers:

**Important:** All Parflex steam products must have sealed ends to prevent contamination of insulation. Parflex product ends are sealed at the factory and it is important that these seals be maintained during storage and that they are sealed upon installation. We will not assume liability for any corrosion or damage to the product caused by such contamination.



**RTV-103BLK**  
– 2.8 oz. tube, 400°F (204.4°C) rated



**RTV-103BLK10.3**  
– 10.3 oz. cartridge, 400°F (204.4°C) rated



**RTV-106RED** – 2.8 oz. tube, high temperature 500°F (260°C)

### Heat Shrinkable Boots (HSBs)

Parflex heat shrink boots (HSB) are designed to prevent moisture from entering the ends of Parflex Temptrace™ bundles. The dash number represents the number of breakouts in each boot. The boots can be used on 1/4", 3/8", or 1/2" tubes, or as a seal for the heating cable.



**HSB-2**



**HSB-1**

### PTFT Feed-Through Seal Kits

Selected specifically for use with Parflex Temptube® and Temptrace™ bundles. PTFT kits provide an excellent method in which to install Parflex Temptube® and Temptrace™ bundles in instrument enclosures and cabinets.



**PTFT – 1.50**



**PTFT – 2.00**

### End Seal Boot (ESB) Kit

Parflex end seal boot (ESB) kits are designed to prevent moisture from entering the ends of Parflex Temptrace™ bundles. Each boot allows up to three tube breakouts. These breakouts have marks to specify where to cut for either a 1/4", 3/8" and 1/2" tube.

**Each Kit contains:**

- (2) End Seal Boots
- (6) Stainless Steel Hose Clamps
- (2) Plastic Hose Clamps (1.47" - 1.72")
- (2) Plastic Hose Clamps (1.73"-2.02")
- (2) Mastic Sealant (3/4" wide x 9" long)

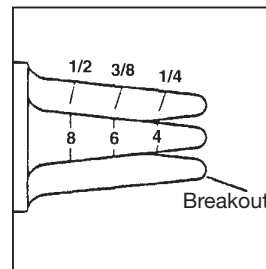

### Temptube® End Seal Kit (ESK)

Parflex End Seal Kits (ESK) are designed to prevent moisture from entering the ends of Parflex Temptube® bundles. Kits come in different sizes for 1/4", 3/8" and 1/2" tubes. Each kit contains enough components to seal ten ends.

**Each kit contains:**

- (10) Silicone Grommets
- (10) Plastic Hose Clamps



### Splice Kit SK-612

The SK-612 has been designed to provide long life, weatherproof thermal insulation and jacket over a tube fitting or instrument connection.

There is sufficient material in each SK-612 Splice Kit to insulate two (2) splices or bundle ends.

**Each Kit contains:**

- (2) 8"x 8" self-sealing rubber sheets with a 6" x 12" fiberglass pad.
- (1) Roll waterproof sealing tape.



### Splice Kit SK-630

The SK-630 has been designed to provide long life, weatherproof thermal insulation and jacket over a tube fitting or instrument connection.

There is sufficient material in each SK-612 Splice Kit to insulate two (2) splices or bundle ends.

**Each Kit contains:**

- (2) 8"x 30" self-sealing rubber sheets with a 6" x 30" fiberglass pad.
- (1) Roll waterproof sealing tape.



### Splice Kit SK-696

The SK-696 has been designed to provide long life, weatherproof thermal insulation and jacket for longer lengths up to 96" (8ft.) of bundles or multiple connections.

**Each Kit contains:**

- (1) Roll 8"x 96" self-sealing rubber sheet.
- (1) Roll 6" x 96" fiberglass pad.
- (1) Roll waterproof sealing tape.



Fax Inquiry To: Sales Office  
330-296-1829

## Parker Steam Trace Design Criteria Quote Request

Date: \_\_\_\_\_ Customer Name: \_\_\_\_\_

Bundle Type: Light Trace  (Low Temperature Maintenance and Freeze Protection)  
Heavy Trace  (High Temperature Maintenance)

Total Quantity: \_\_\_\_\_ Feet   
Meters

Specified Lengths: \_\_\_\_\_  
\_\_\_\_\_

Part Number: \_\_\_\_\_ (See How-to-Order in catalog.)

-----  
*If not sure of part number, complete the following criteria:*

Maximum Steam Pressure: \_\_\_\_\_

Maximum Steam Temperature: \_\_\_\_\_

**Process Tubes:**

How many process tubes: \_\_\_\_\_

Size: (O.D. and wall thickness): \_\_\_\_\_ Inches   
mm

Tube Material: \_\_\_\_\_

**Trace Tube:**

Size: (O.D. and wall thickness): \_\_\_\_\_ Inches   
mm

Tube Material: \_\_\_\_\_

**Outer Jacket Type: (Note: Black FR-PVC is Standard)**

FR-PVC  TPR

FR-TPE  FRPE

FR-PUR  LDPE

PUR  PVDF



## SL – Self-Regulating Low Temperature Maintenance Bundles

Maintain Temperatures up to 150°F (65°C) and withstands  
Maximum Internal Exposure to 185°F (85°C)



### General

Parflex Temprace™ tubing is thermally insulated with a non-hygroscopic inorganic fiberglass material and protected with a flexible, black, flame-resistant PVC jacket.

Parflex standard Temprace™ is thermally insulated for transfer of fluids or gases up to 185°F (85°C) while maintaining an outer jacket surface temperature of 140°F (60°C), meeting NEC Personnel Protection Code 427.12.

SL-Temprace™ is designed to provide freeze protection and low-temperature maintenance for gases, liquids or other viscous materials. With outdoor temperatures of -40°F (-40°C), SL-Temprace™ will maintain a process fluid or gas at 40°F (4.4°C).

SL- Temprace™ can maintain process tube temperatures up to 140°F (60°C), depending upon ambient conditions.

### Heating Cables

Cables are available in 120V and 208-277 volt, with Heat outputs of 3, 5, 8 and 10 watt/ft.

SL-Temprace™ is rated per NEC standards. Cables with heat outputs of 3, 5 and watts/ft have a T3 rating. Cables with heat outputs of 10, 15 and 20 watts/ft have a T2D rating.

Parflex standard SL designs come with an internal tinned copper braid on the heating cable for grounding purposes and a TPR jacket over the heating cable to provide additional protection against many inorganic chemical solutions.

### Common Tube Materials and Sizes

Temprace™ is readily available in 1/4", 3/8" and 1/2" sizes as well as metric sizes (6 mm, 8mm, 10mm and 12mm). The most common stock alloys are Seamless Copper Type 122 DHP ASTM B68-B75, as well as seamless and welded stainless steel tubing, Type 316/316L ASTM A269. Many other alloys, ASTM standards and sizes are available upon request. (See *Technical Data* Section)

### Testing

All Temprace™ products are pressure tested prior to shipment. Third party testing and witnessing is available upon request, including DNV, ABS and Lloyd's Register. Contact factory for complete details.

### Jacketing Materials

Black, UV-resistant, FR-PVC is our standard material, however, other jacketing materials are available upon request, including non-halogenated FR-TPE and Urethanes. (See *Technical Data* Section)

**NOTE:** It is absolutely necessary to seal the ends against contamination from moisture and/or corrosive liquids. Parker Hannifin cannot assume any liability for product damage caused by moisture from unsealed ends.





## How to Specify & Order SL-Self-Regulating Low Temperature Maintenance Electric Trace Bundles: MTR\* 185°F (85°C)

Maintain Temperatures up to 150°F (65°C) with a \*Maximum Internal Exposure up to 185°F (85°C)

**SL - 3 1 2 - B 08 35 B - V B**

<b>SL</b>	<b>Bundle Type</b>	<b>3</b>	<b>Heating Cable (Watts/ft)</b>	<b>1</b>	<b>Heating Cable Voltage</b>	<b>2</b>	<b>Area Classification</b>	<b>B</b>	<b>Process Tube Material</b>
	SL= Self-Regulating Low Temperature		See Selection Chart  3= 3watt 5= 5watt 8= 8watt 1= 10 watt		1= 120V 2= 240V  * 240 volt cables can be powered at 208, 240 or 277 volts		1= Class 1, Div. 1 Areas  2= General Purpose & Class I, Div. 2 Areas		1= Smls Copper Type DHP Alloy No 122. ASTM B68-B75 2= Welded Stainless Steel Type 316/316L ASTM A269 3= Welded Stainless Steel Type 304 ASTM A269 B= Smls 316/316L ASTM A269 C= Smls 304 ASTM A269 D= Smls Monel Type 400 E= Smls Hastelloy C22 H= Smls 316H ASTM A213 I= Smls Incoloy 825 L= Electropolish Smls 316/316L ASTM A269 (10Ra Max) M= Smls 316/316L ASTM A213 S= Silco Smls 316/316L ASTM A269 P= PFA Fluoropolymer F= FEP Fluoropolymer T= TFE Fluoropolymer 7= Parflex 919 PTFE SS Braided Hose 9= Customer Specified Tube Material

<b>08</b>	<b>Process Tube Size</b>	<b>35</b>	<b>Process Tube Size</b>	<b>B</b>	<b>Number of Process Tubes</b>	<b>V</b>	<b>Jacket Material</b>	<b>B</b>	<b>Jacket Color</b>
	<b>O.D.</b> See Selection Charts  Imperial  02=1/8" 03=3/16" 04=1/4" 05=5/16" 06=3/8" 07=7/16" 08=1/2" 10=5/8" 12=3/4" 16=1"  Metric  MA=2mm MB=4mm MC=6mm MD=8mm ME=10mm MF=12mm MG=14mm MH=16mm		<b>Wall Thickness</b> See Selection Charts  Imperial  16=.016" 20=.020" 28=.028" 30=.030 31=.031" 32=.032" 35=.035" 40=.040" 47=.047" 49=.049" 50=.050" 62=.062" 65=.065" 83=.083"  Metric  89=.89mm 10=1.0mm 15=1.5mm 20=2.0mm 25=2.5mm		A= 1 Tube B= 2 Tubes C= 3 Tubes etc.   P= 2 Tube Parallel Design		V=FR-PVC T=FR-TPE U=FR-PUR P=PUR R=TPR E=FRPE L=LDPE F=PVDF  Note: Parflex standard jacket material is FR-PVC		N=Black B=Blue G=Green O=Orange Y=Yellow P=Purple R=Red W=White  Note: Parflex standard color jacket is black  Note: For standard black FR-PVC jacketed products the -VN may be dropped.

Part Number  #	Process Tube O.D. (in.)	Wall Thickness (in.)	Nominal Product O.D. (in.)	Product Weight (lbs./ft.)	Minimum Bend Radius (in.)	Watt Density per foot / Voltage**	Circuit Length Ft @ 50°F Start-up / Breaker (amps)	Performance At Various Ambient Conditions	
	Smls Stainless*					Watt/Ft		At -40°F (-40°C) will maintain at least***	At 80°F (23.9°C) will maintain at least***
<b>SL – Single Process Tube – Maximum Internal Exposure Temperature, Power off 185°F (85°C)</b>									
SL512-B0435A	1/4	0.035	1.21	0.33	7	5 watt / 120V	270ft / 25A	40°F [4°C]	120°F [49°C]
SL512-B0635A	3/8	0.035	1.31	0.39	8	5 watt / 120V	270ft / 25A	40°F [4°C]	115°F [46°C]
SL512-B0835A	1/2	0.035	1.41	0.46	8	5 watt / 120V	270ft / 25A	40°F [4°C]	115°F [46°C]
SL812-B1249A	3/4	0.049	1.64	0.68	10	8 watt / 120V	215ft / 25A	40°F [4°C]	125°F [52°C]
<b>SL – Dual Process Tubes – Maximum Internal Exposure Temperature, Power off 185°F (85°C)</b>									
SL512-B0435B	(2) 1/4	0.035	1.28	0.42	8	5 watt / 120V	270ft / 25A	40°F [4°C]	115°F [46°C]
SL512-B0635B	(2) 3/8	0.035	1.43	0.54	9	5 watt / 120V	270ft / 25A	40°F [4°C]	115°F [46°C]
SL812-B0835B	(2) 1/2	0.035	1.61	0.66	10	8 watt / 120V	215ft / 25A	40°F [4°C]	125°F [52°C]
SL812-B1239B	(2) 3/4	0.049	1.99	1.11	12	8 watt / 120V	215ft / 25A	40°F [4°C]	120°F [49°C]

\*Many other alloys available in addition to seamless stainless steel tubing.

\*\*Product is also available in 208, 240 and 277V

\*\*\*In some cases, without use of a controller, this design could maintain higher temperatures at the ambient temperature shown. The temperature maintained is based upon the watt density heater shown, higher watt density heaters could be used to achieve a greater maintenance temperatures.

### FM – Factory Mutual

General Purpose - Ordinary Locations  
Hazardous Locations, when installed with Parflex accessories.

- Class I, Div. 2, Groups B, C and D (gases, vapors)
- Class II, Div.2, Group F, G (Combustible dust)
- Class III, Div.2, (ignitable fibers and filings)

#### T-Temperature Ratings

- 3 watt rated T6 temperature class
- 5 and 8 watt rated T5 temperature class
- 10 watt rated T4A temperature class

### CSA – Canadian Standards Association

CSA Certified for ordinary locations  
For certified hazardous locations contact Parflex

**ATEX** - Certified cables & accessories available

### Electrical Specifications:

Operating Voltage: 120 V or 240V  
Bus Wire Voltage Rating: 600 Volts  
Bus Wire Size: 16 AWG

## Maximum Circuit Length (ft) at Start-up °F

Low-Temp Cable Rating	50°F (10°C) Circuit Length In Feet				0°F (-18°C) Circuit Length In Feet				-20°F (-29°C) Circuit Length In Feet			
	10	20	25	30	10	20	25	30	10	20	25	30
Circuit Breaker Size (Amps)	10	20	25	30	10	20	25	30	10	20	25	30
3 watt / 120V	205	360	NR	NR	135	270	330	360	120	245	300	360
3 watt / 240V	400	660	NR	NR	275	555	660	NR	245	495	600	660
5 watt / 120V	125	250	270	NR	90	180	225	270	80	160	205	245
5 watt / 240V	250	505	540	NR	180	360	450	540	160	325	405	490
8 watt / 120V	100	200	215	NR	70	145	180	215	65	235	300	350
8 watt / 240V	185	375	420	NR	135	265	335	395	120	325	300	350
10 watt / 120V	60	130	160	180	50	105	130	155	45	95	120	140
10 watt / 240V	100	210	260	315	80	170	210	255	75	160	195	240

## Performance Data—Single Process Tube

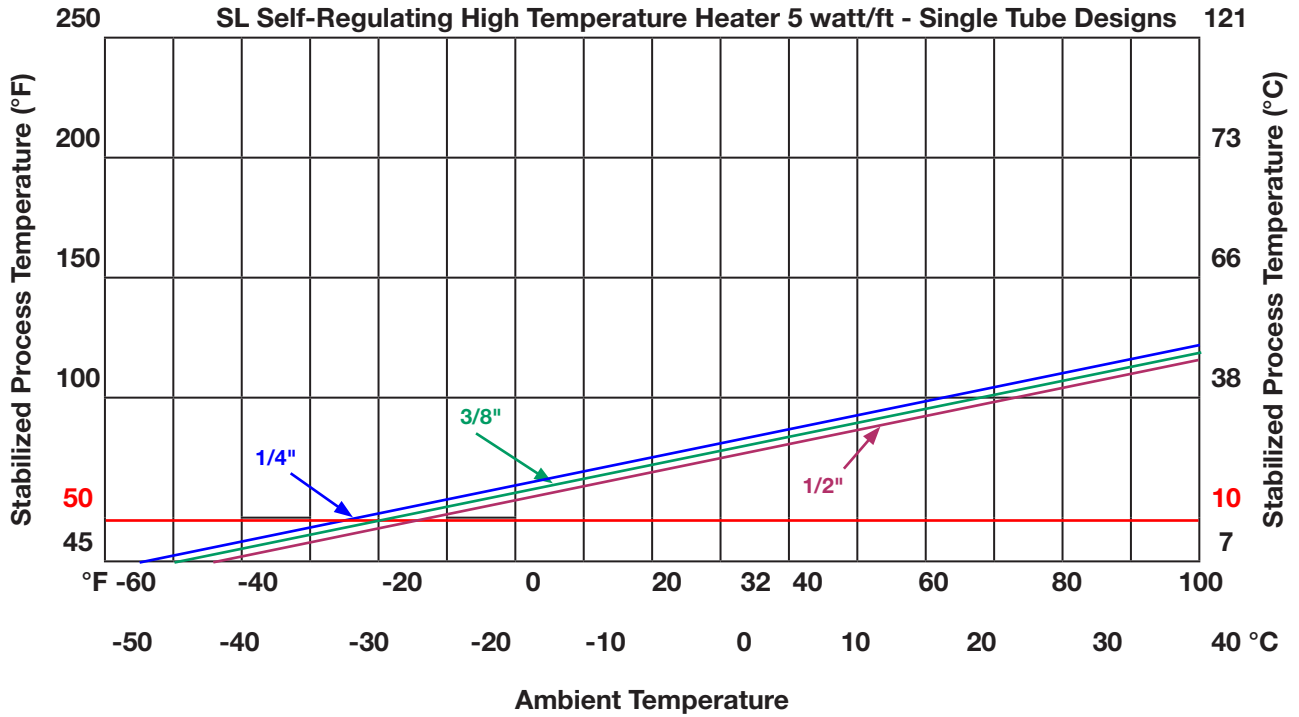

## Performance Data—Dual Process Tube

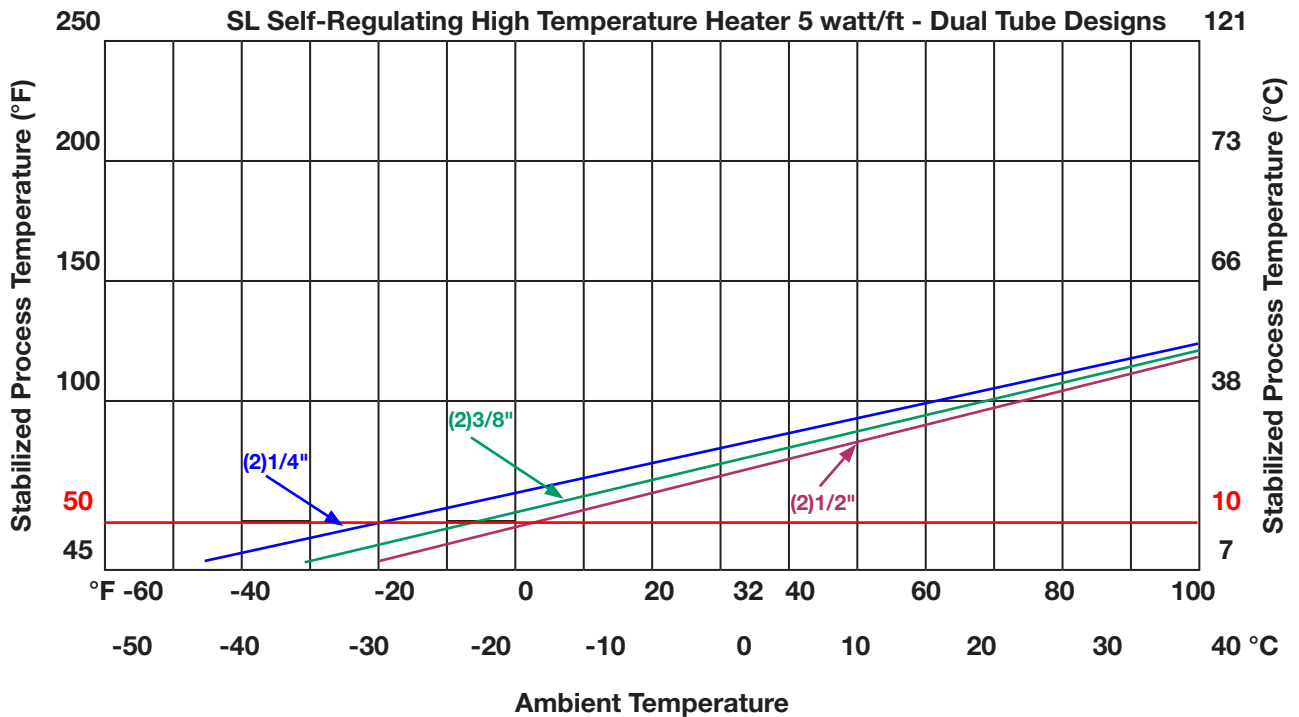

<b>SL Series Self-Regulating Bundles</b> <b>Maximum Exposure 185°F (85°C)</b> <b>Process Tubes 1/4" to 1/2" O.D. ( 6mm to 12mm)</b> <b>Single or Dual Tube Designs</b>					
<b>Minimum Process Temperature to Maintain**</b>	<b>Standard Insulation Package*</b>				
	<b>Environments Average High / Low Ambient Conditions</b>				
	Extreme Cold	Cold	Moderate Cold	Moderate	Warm
	-65°F Low 80°F High	-40°F Low 80°F High	-10°F Low 95°F High	0°F Low 105°F High	10°F Low 115°F High
<b>120 Volts</b>	-54°C Low 26°C High	-40°C Low 26°C High	-24°C Low 35°C High	-18°C Low 40°C High	-13°C Low 46°C High
40°F (4°C)	8 Watt / Ft	8 Watt / Ft	5 Watt / Ft	3 Watt / Ft	3 Watt / Ft
50°F (10°C)	10 Watt / Ft	8 Watt / Ft	5 Watt / Ft	5 Watt / Ft	3 Watt / Ft
75°F (24°C)	/		8 Watt / Ft	8 Watt / Ft	8 Watt / Ft
<b>208 Volts</b>	/				
40°F (4°C)	10 Watt / Ft	8 Watt / Ft	5 Watt / Ft	5 Watt / Ft	3 Watt / Ft
50°F (10°C)	/		8 Watt / Ft	8 Watt / Ft	5 Watt / Ft
75°F (24°C)	/		/		8 Watt / Ft
<b>240 Volts</b>	/				
40°F (4°C)	8 Watt / Ft	8 Watt / Ft	5 Watt / Ft	3 Watt / Ft	3 Watt / Ft
50°F (10°C)	10 Watt / Ft	8 Watt / Ft	5 Watt / Ft	5 Watt / Ft	3 Watt / Ft
75°F (24°C)	/		8 Watt / Ft	8 Watt / Ft	8 Watt / Ft

\* The above heater cable selection is based upon our standard insulation package, other insulation packages are available to maintain higher temperatures.

\*\* The maintenance temperature could actually be higher depending upon the size and number of tubes required. For precise temperature control, it is recommended that a thermal sensor be used. Contact the factory for more exact product thermal properties based upon your application conditions.

**How to Use:**

- 1) Check to be sure you are using the correct chart.
- 2) Choose your operating voltage.
- 3) Choose the minimum process temperature you want to maintain. Note: If temperature is not shown, pick the next higher option.
- 4) Follow chart across to the ambient Condition that best match your area.
- 5) Use the watt-density shown for your part number derivation.

**Note:**

The watt-density selected will maintain the temperature indicated at a minimum. Depending upon actual ambient fluctuations, process tubes size and number of tubes, the maintenance temperature could be higher.

**SL Series Self-Regulating Bundles**  
**Maximum Exposure 185°F (85° C)**  
**Process Tubes 3/4" to 1" O.D. ( 19mm to 25mm)**  
**Single Tube Designs (consult factory for multiple tubes)**

Minimum Process Temperature to Maintain**	Standard Insulation Package *				
	Environments Average High / Low Ambient Conditions				
	Extreme Cold	Cold	Moderate Cold	Moderate	Warm
	-65°F Low 80°F High	-40°F Low 80°F High	-10°F Low 95°F High	0°F Low 105°F High	10°F Low 115°F High
<b>120 Volts</b>	-54°C Low 26°C High	-40°C Low 26°C High	-24°C Low 35°C High	-18°C Low 40°C High	-13°C Low 46°C High
40°F (4°C)	10 Watt / Ft	8 Watt / Ft	5 Watt / Ft	5 Watt / Ft	3 Watt / Ft
50°F (10°C)		10 Watt / Ft	8 Watt / Ft	5 Watt / Ft	5 Watt / Ft
75°F (24°C)			10 Watt / Ft	10 Watt / Ft	8 Watt / Ft
<b>208 Volts</b>					
40°F (4°C)		10 Watt / Ft	8 Watt / Ft	5 Watt / Ft	5 Watt / Ft
50°F (10°C)		10 Watt / Ft	8 Watt / Ft	8 Watt / Ft	5 Watt / Ft
75°F (24°C)					10 Watt / Ft
<b>240 Volts</b>					
40°F (4°C)	10 Watt / Ft	8 Watt / Ft	5 Watt / Ft	5 Watt / Ft	3 Watt / Ft
50°F (10°C)		10 Watt / Ft	8 Watt / Ft	5 Watt / Ft	5 Watt / Ft
75°F (24°C)			10 Watt / Ft	10 Watt / Ft	8 Watt / Ft

\* The above heater cable selection is based upon our standard insulation package, other insulation packages are available to maintain higher temperatures.

\*\* The maintenance temperature could actually be higher depending upon the size and number of tubes required. For precise temperature control, it is recommended that a thermal sensor be used. Contact the factory for more exact product thermal properties based upon your application conditions.

**How to Use:**

- 1) Check to be sure you are using the correct chart.
- 2) Choose your operating voltage.
- 3) Choose the minimum process temperature you want to maintain. Note: If temperature is not shown, pick the next higher option.
- 4) Follow chart across to the ambient Condition that best match your area.
- 5) Use the watt-density shown for your part number derivation.

**Note:**

The watt-density selected will maintain the temperature indicated at a minimum. Depending upon actual ambient fluctuations, process tubes size and number of tubes, the maintenance temperature could be higher.



## SH – Self-Regulating High Temperature Maintenance Bundles

Maintain Temperatures up to 250°F (121°C) and withstands an Internal Exposure Temperature of 400°F (204°C)



### General

Parflex Temprace™ tubing is thermally insulated with a non-hygroscopic, inorganic fiberglass material and protected with a flexible, black, flame-resistant PVC jacket.

Parflex standard Temprace™ is thermally insulated for transfer of fluids or gases up to 400°F (204°C) while maintaining an outer jacket surface temperature of 140°F (60°C), meeting NEC Personnel Protection Code 427.12.

SH- Temprace™ is designed to provide temperature maintenance for gases, liquids or other process materials. The high temperature self-regulating product has a maximum temperature rating of 250°F (121.1°C), when power to the heating cable is on, and can be steam cleaned at 400°F (204°C), when power to the heating cable is off.

SH- Temprace™ can maintain process tube temperatures up to 250°F (121.1°C), depending upon ambient conditions.

### Heating Cables

Cables are available in 120V and 208-277 volt, with Heat outputs of 5, 10, 15 and 20 watt/ft.

SH-Temprace™ is rated per NEC standards. Cables with heat outputs of 3, 5 and 8 watts/ft have a T3 rating. Cables with heat outputs of 10, 15 and 20 watts/ft have a T2D rating.

Parflex standard SH designs come with an internal tinned copper braid on the heating cable for grounding purposes and a Fluoropolymer jacket over the heating cable to provide additional protection against many harsh environments.

### Common Tube Materials and Sizes

Temprace™ is readily available in 1/4", 3/8" and 1/2" sizes as well as metric sizes. (6 mm, 8mm, 10mm and 12mm) The most common stock alloys are Seamless Copper Type #122 DHP ASTM B68-B75, as well as, seamless and welded stainless steel tubing Type 316/316L ASTM A269. Many other alloys, ASTM standards and sizes are available upon request. (See *Technical Data Section*)

### Testing

All Temprace™ products are pressure tested prior to shipment. Third party testing and witnessing is available upon request, including DNV, ABS and Lloyd's Register. Contact factory for complete details.

### Jacketing Materials

Black, UV-resistant, FR-PVC is our standard material; however, other jacketing materials are available upon request, including non-halogenated FR-TPE and Urethanes. (See *Technical Data Section*)

**NOTE:** It is absolutely necessary to seal the ends against contamination from moisture and/or corrosive liquids. Parker Hannifin cannot assume any liability for product damage caused by moisture from unsealed ends.

## How to Specify & Order





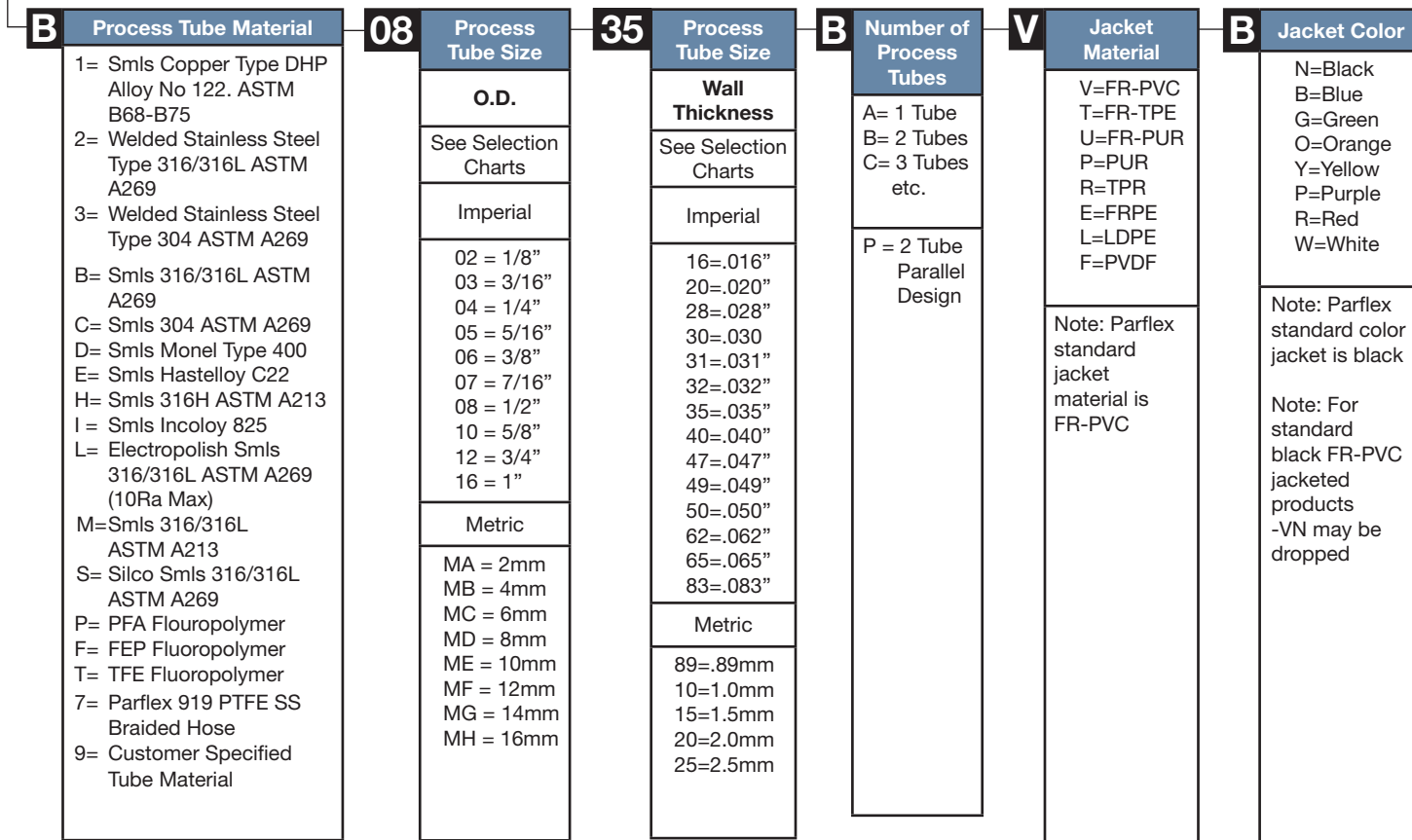
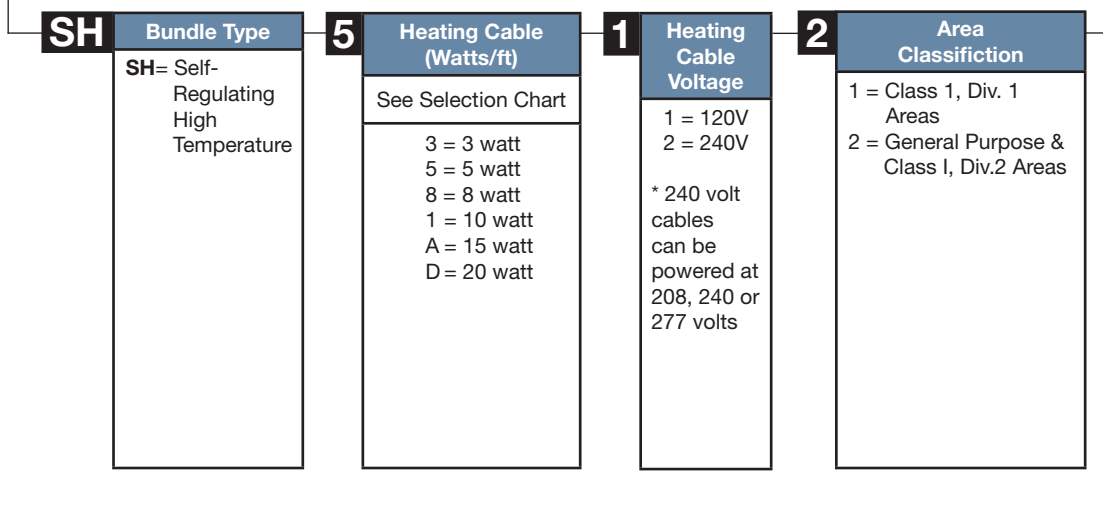

### SH- Self-Regulating High Temperature Maintenance Electric Trace Bundles: MTR = 400°F (204°C)

Maintain Temperatures up to 250°F (121°C) with a \*Maximum Internal Exposure up to 400°F (204°C)

**SH - 5 1 2 - B 08 35 B - V B**



\*Maximum Temperatures are Subject to Ambient Conditions (See Heater Selection Chart)

Part Number  #	Process Tube O.D. (in.) 	Wall Thickness (in.) 	Nominal Product O.D. (in.) 	Product Weight (lbs./ft.) 	Minimum Bend Radius (in.) 	Watt Density per foot / Voltage**	Circuit Length Ft @ 50°F Start-up / Breaker (amps) 	Performance At Various Ambient Conditions	
						Watt/Ft		At -40°F (-40°C) will maintain at least***	At 80°F (23.9°C) will maintain at least***
<b>SH- Single Process Tube - Seamless Stainless Tubing* - Maximum Internal Exposure Temperature, Power off 400°F (204°C)</b>									
SH512-B0435A	1/4	0.035	1.21	0.33	7	5 watt / 120V	360ft / 30A	40°F (4°C)	145°F (63°C)
SH512-B0635A	3/8	0.035	1.31	0.39	8	5 watt / 120V	360ft / 30A	40°F (4°C)	140°F (60°C)
SH512-B0835A	1/2	0.035	1.41	0.46	8	5 watt / 120V	360ft / 30A	40°F (4°C)	135°F (57°C)
SH812-B1249A	3/4	0.049	1.64	0.68	10	8 watt / 120V	285ft / 30A	40°F (4°C)	150°F (65°C)
<b>SH- Dual Process Tube - Seamless Stainless Tubing* - Maximum Internal Exposure Temperature, Power off 400°F (204°C)</b>									
SH512-B0435B	(2) 1/4	0.035	1.28	0.42	8	5 watt / 120V	360ft / 30A	40°F (4°C)	145°F (63°C)
SH512-B0635B	(2) 3/8	0.035	1.43	0.54	9	5 watt / 120V	360ft / 30A	40°F (4°C)	135°F (57°C)
SH812-B0835B	(2) 1/2	0.035	1.61	0.66	10	8 watt / 120V	285ft / 30A	40°F (4°C)	150°F (65°C)
SH812-B1239B	(2) 3/4	0.049	1.99	1.11	12	8 watt / 120V	285ft / 30A	40°F (4°C)	140°F (60°C)

\*Many other alloys available, as well as seamless stainless steel tubing.

\*\*Product is also available in 208, 240 and 277V

\*\*\* In some cases, without use of a controller, this design could maintain higher temperatures at the ambient temperature shown. The temperature maintained is based upon the watt density heater shown. Higher watt density heaters could be used to achieve a greater maintenance temperatures.

**FM – Factory Mutual**

General Purpose - Ordinary Locations  
Hazardous Locations, when installed with Parflex accessories.

- Class I, Div. 2, Groups B, C and D (gases, vapors)
- Class II, Div.2, Group F, G (Combustible dust)
- Class III, Div.2, (Ignitable fibers and filings)

**T-Temperature Ratings**

- 3, 5 and 8 watt rated T3 temperature class
- 10, 15 and 20 watt rated T2D temperature class

**CSA – Canadian Standards Association**

CSA Certified for ordinary locations  
for certified hazardous locations contact Parflex

**ATEX – Certified Cables & accessories available**

**Electrical Specifications:**

Operating Voltage: 120 V or 240V  
Bus Wire Voltage Rating: 600 Volts  
Bus Wire Size: 16 AWG

**Maximum Circuit Length (ft) at Start-up °F**

High-Temp Cable Rating	50°F (10°C) Circuit Length In Feet				0°F (-18°C) Circuit Length In Feet				-20°F (-29°C) Circuit Length In Feet			
	15	20	30	40	15	20	30	40	15	20	30	40
Circuit Breaker Size (Amps)	15	20	30	40	15	20	30	40	15	20	30	40
5 watt / 120V	180	240	360	375	165	220	330	375	155	210	310	375
5 watt / 240V	360	480	720	750	325	430	645	750	310	415	620	750
10 watt / 120V	95	125	190	250	90	110	175	250	85	100	170	245
10 watt / 240V	190	255	385	490	165	225	345	490	155	215	330	470
15 watt / 120V	70	95	145	190	65	85	125	165	60	80	120	150
15 watt / 240V	145	190	290	385	120	175	270	360	115	165	260	340
20 watt / 120V	60	75	115	155	50	65	105	140	45	65	100	135
20 watt / 240V	115	155	230	305	100	135	200	270	90	130	195	255

## Performance Data—Single Process Tube

250 SH Self-Regulating High Temperature Heater 10 watt/ft - Single Tube Designs 121

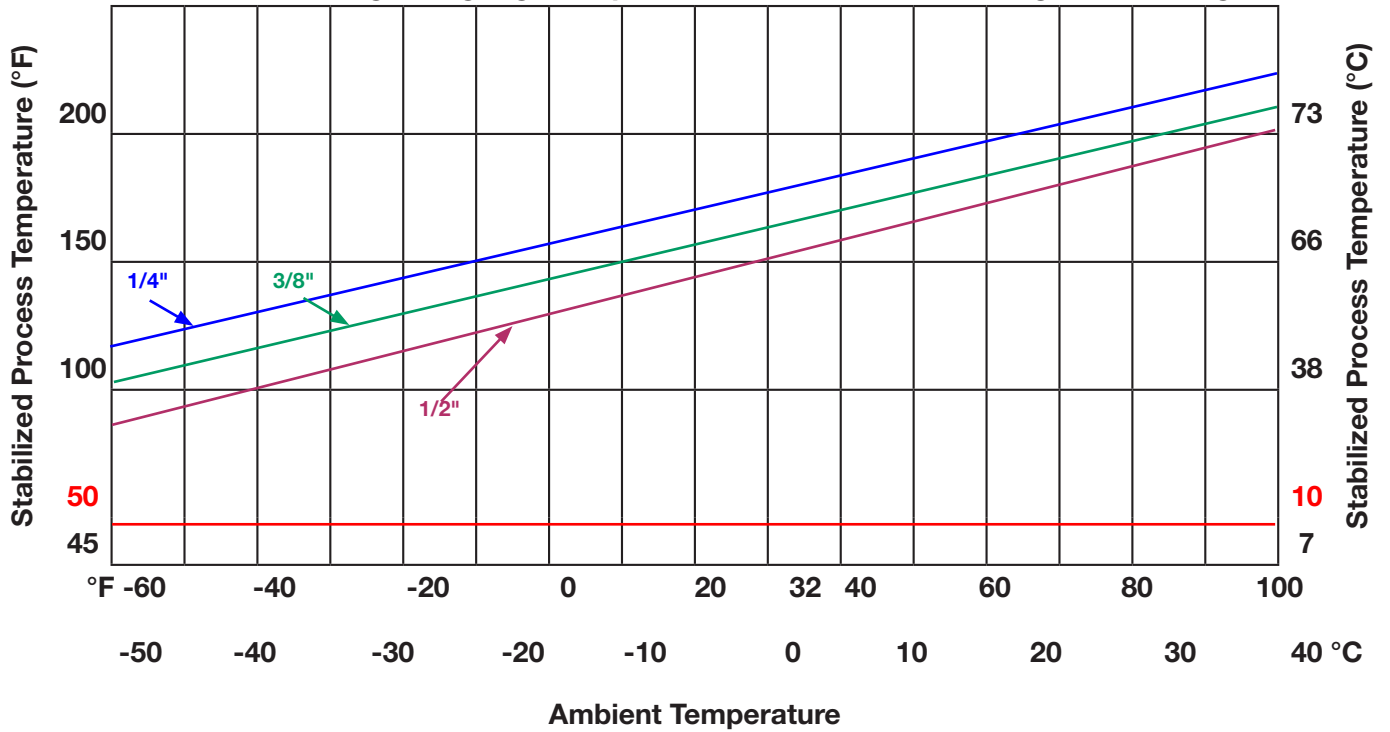

## Performance Data—Dual Process Tube

250 SH Self-Regulating High Temperature Heater 10 watt/ft - Dual Tube Designs 121

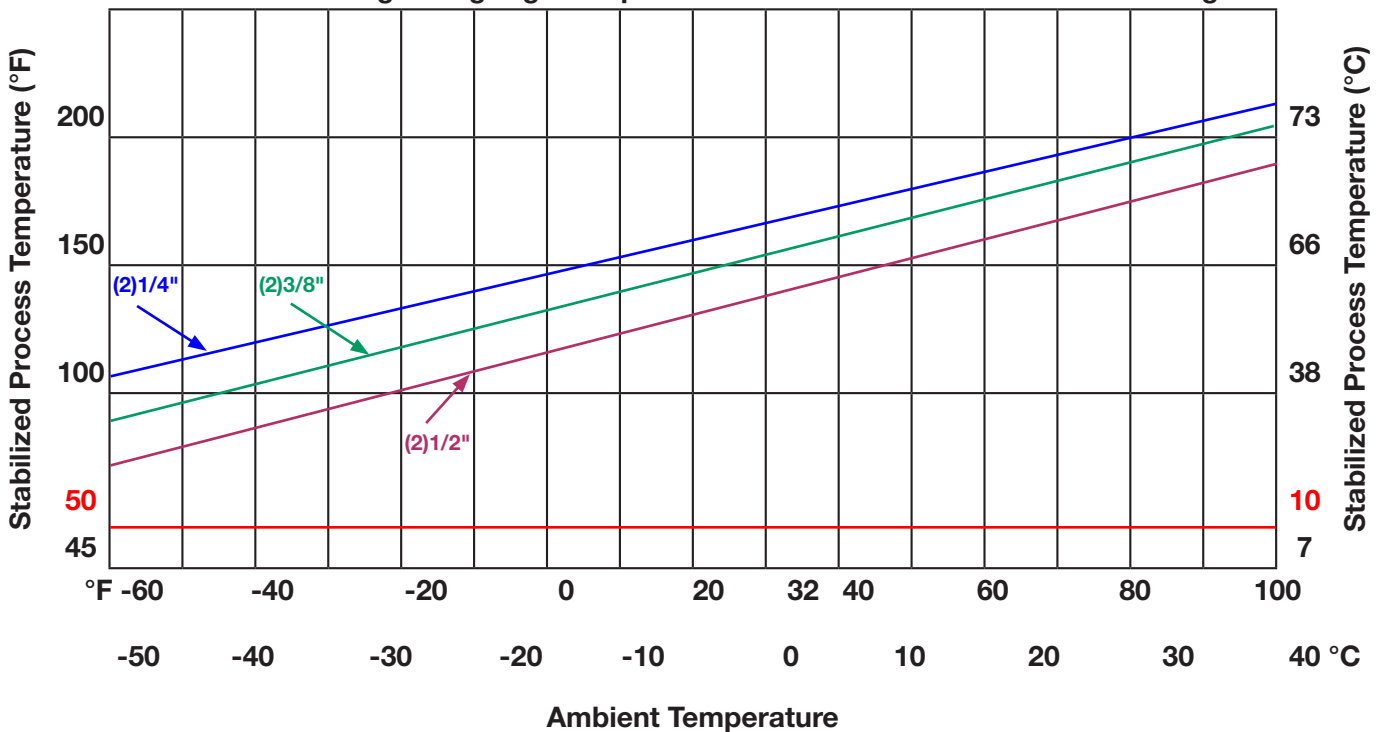

<b>SH Series Self-Regulating Bundles</b> <b>Maximum Exposure 400°F (204°C)</b> <b>Process Tubes 1/4" to 1/2" O.D. (6mm to 12mm)</b> <b>Single or Dual Tube Designs</b>					
<b>Minimum Process Temperature to Maintain**</b>	<b>Standard Insulation Package*</b>				
	<b>Environments Average High / Low Ambient Conditions</b>				
	Extreme Cold	Cold	Moderate Cold	Moderate	Warm
	-65°F Low 80°F High	-40°F Low 80°F High	-10°F Low 95°F High	0°F Low 105°F High	10°F Low 115°F High
120 Volts	-54°C Low 26°C High	-40°C Low 26°C High	-24°C Low 35°C High	-18°C Low 40°C High	-13°C Low 46°C High
40°F (4°C)	8 Watt / Ft	8 Watt / Ft	5 Watt / Ft	3 Watt / Ft	3 Watt / Ft
50°F (10°C)	10 Watt / Ft	8 Watt / Ft	5 Watt / Ft	5 Watt / Ft	5 Watt / Ft
75°F (24°C)	15 Watt / Ft	10 Watt / Ft	8 Watt / Ft	8 Watt / Ft	8 Watt / Ft
100°F (38°C)	15 Watt / Ft	15 Watt / Ft	10 Watt / Ft	10 Watt / Ft	10 Watt / Ft
125°F (52°C)	20 Watt / Ft	20 Watt / Ft	15 Watt / Ft	15 Watt / Ft	15 Watt / Ft
150°F (66°C)	/		20 Watt / Ft	20 Watt / Ft	20 Watt / Ft
175°F (79°C)	/		/		20 Watt / Ft
<b>208 Volts</b>					
40°F (4°C)	10 Watt / Ft	8 Watt / Ft	5 Watt / Ft	5 Watt / Ft	3 Watt / Ft
50°F (10°C)	15 Watt / Ft	10 Watt / Ft	8 Watt / Ft	5 Watt / Ft	5 Watt / Ft
75°F (24°C)	15 Watt / Ft	15 Watt / Ft	10 Watt / Ft	8 Watt / Ft	8 Watt / Ft
100°F (38°C)	20 Watt / Ft	20 Watt / Ft	15 Watt / Ft	10 Watt / Ft	10 Watt / Ft
125°F (52°C)	/		20 Watt / Ft	15 Watt / Ft	15 Watt / Ft
150°F (66°C)	/		/		20 Watt / Ft
175°F (79°C)	/		/		20 Watt / Ft
<b>240 Volts</b>					
40°F (4°C)	8 Watt / Ft	8 Watt / Ft	5 Watt / Ft	3 Watt / Ft	3 Watt / Ft
50°F (10°C)	10 Watt / Ft	8 Watt / Ft	5 Watt / Ft	5 Watt / Ft	5 Watt / Ft
75°F (24°C)	15 Watt / Ft	10 Watt / Ft	8 Watt / Ft	8 Watt / Ft	8 Watt / Ft
100°F (38°C)	15 Watt / Ft	15 Watt / Ft	10 Watt / Ft	10 Watt / Ft	10 Watt / Ft
125°F (52°C)	20 Watt / Ft	20 Watt / Ft	15 Watt / Ft	15 Watt / Ft	15 Watt / Ft
150°F (66°C)	/		20 Watt / Ft	20 Watt / Ft	20 Watt / Ft
175°F (79°C)	/		/		20 Watt / Ft

\*The above heater cable selection is based upon our standard insulation package. Other insulation packages are available to maintain higher temperatures.

\*\*The maintenance temperature could actually be higher depending upon the size and number of tubes required. It is recommended that for precise temperature control a thermal sensor be used. Contact the factory for more exact product thermal properties based upon your application conditions.

**How to Use:**

- 1) Check to be sure you are using the correct chart.
- 2) Choose your operating voltage.
- 3) Choose the minimum process temperature you want to maintain. Note: If temperature is not shown, pick the next higher option.
- 4) Follow chart across to the ambient Condition that best match your area.
- 5) Use the watt-density shown for your part number derivation.

**Note:**

The watt-density selected will maintain the temperature indicated at a minimum. Depending upon actual ambient fluctuations, process tubes size and number of tubes, the maintenance temperature could be higher.

**SH Series Self-Regulating Bundles**  
**Maximum Exposure 400°F (204°C)**  
**Process Tubes 3/4" to 1" O.D. (19mm to 25mm)**  
**Single Tube Designs (Contact Factory for Multiple Tubes)**

Minimum Process Temperature to Maintain**	Standard Insulation Package*				
	Environments Average High / Low Ambient Conditions				
	Extreme Cold	Cold	Moderate Cold	Moderate	Warm
	-65°F Low 80°F High	-40°F Low 80°F High	-10°F Low 95°F High	0°F Low 105°F High	10°F Low 115°F High
<b>120 Volts</b>	-54°C Low 26°C High	-40°C Low 26°C High	-24°C Low 35°C High	-18°C Low 40°C High	-13°C Low 46°C High
40°F (4°C)	10 Watt / Ft	8 Watt / Ft	5 Watt / Ft	5 Watt / Ft	3 Watt / Ft
50°F (10°C)	15 Watt / Ft	10 Watt / Ft	8 Watt / Ft	5 Watt / Ft	5 Watt / Ft
75°F (24°C)	15 Watt / Ft	15 Watt / Ft	10 Watt / Ft	8 Watt / Ft	8 Watt / Ft
100°F (38°C)	20 Watt / Ft	15 Watt / Ft	15 Watt / Ft	15 Watt / Ft	10 Watt / Ft
125°F (52°C)		20 Watt / Ft	20 Watt / Ft	15 Watt / Ft	15 Watt / Ft
150°F (66°C)				20 Watt / Ft	20 Watt / Ft
<b>208 Volts</b>					
40°F (4°C)	15 Watt / Ft	10 Watt / Ft	8 Watt / Ft	5 Watt / Ft	5 Watt / Ft
50°F (10°C)	15 Watt / Ft	10 Watt / Ft	8 Watt / Ft	8 Watt / Ft	5 Watt / Ft
75°F (24°C)	20 Watt / Ft	15 Watt / Ft	15 Watt / Ft	10 Watt / Ft	10 Watt / Ft
100°F (38°C)		20 Watt / Ft	15 Watt / Ft	15 Watt / Ft	15 Watt / Ft
125°F (52°C)			20 Watt / Ft	20 Watt / Ft	20 Watt / Ft
<b>240 Volts</b>					
40°F (4°C)	10 Watt / Ft	8 Watt / Ft	5 Watt / Ft	5 Watt / Ft	3 Watt / Ft
50°F (10°C)	15 Watt / Ft	10 Watt / Ft	8 Watt / Ft	5 Watt / Ft	5 Watt / Ft
75°F (24°C)	15 Watt / Ft	15 Watt / Ft	10 Watt / Ft	8 Watt / Ft	8 Watt / Ft
100°F (38°C)	20 Watt / Ft	15 Watt / Ft	15 Watt / Ft	15 Watt / Ft	10 Watt / Ft
125°F (52°C)		20 Watt / Ft	20 Watt / Ft	15 Watt / Ft	15 Watt / Ft
150°F (66°C)				20 Watt / Ft	20 Watt / Ft

\*The above heater cable selection is based upon our standard insulation package. Other insulation packages are available to maintain higher temperatures.

\*\* The maintenance temperature could actually be higher depending upon the size and number of tubes required. It is recommended that for precise temperature control a thermal sensor be used. Contact the factory for more exact product thermal properties based upon your application conditions.

**How to Use:**

- 1) Check to be sure you are using the correct chart.
- 2) Choose your operating voltage.
- 3) Choose the minimum process temperature you want to maintain. Note: If temperature is not shown, pick the next higher option.
- 4) Follow chart across to the ambient Condition that best match your area.
- 5) Use the watt-density shown for your part number derivation.

**Note:**

The watt-density selected will maintain the temperature indicated at a minimum. Depending upon actual ambient fluctuations, process tubes size and number of tubes, the maintenance temperature could be higher.



## 4041-2101 Temptrace™ Power Connection Kit with Junction Box

4041-2101 Temptrace™ Electric Power Connection Kit for SL and SH Series Self-Regulating Bundles



The Temptrace™ Power Connection Kit with Junction Box can be used to make an easily installed combination power connection and waterproof seals for single and double tube bundles.

### Power Connection Kit Contains:

- 1 Molded junction box consisting of : Base - Box - Lid - Hardware
- 4 Heater grommets (grommet used based upon heater type)
- 1 Pipe strap 1" – 3-1/2"
- 1 RTV-103BLK
- 1 Three position terminal block
- 1 Mounting screw for terminal block
- 1 Caution label

**Caution:** The heater will come in contact with the power feed wires in the junction box. Make sure that the temperature rating of the power feed wire insulation is adequate for the heater used.

### Ground Fault Equipment Protection Devices (GFEPDs):

The IEEE standard (515-1989) for heating cables requires the use of GFEPDs with a nominal 30 milliampere trip level for "piping systems in classified areas, those areas requiring a high degree of maintenance, or which may be exposed to physical abuse or corrosive atmospheres."

### Approvals:

FM – Factory Mutual Approved  
Ordinary Locations  
UL Listed  
Hazardous (Classified) Locations

Class I, Division 2, Groups B, C and D  
Class II, Division 2, Groups F and G  
Class III, Division 2

CSA Certified for use in ordinary areas

ATEX Approved Kits Available

## 4041-5300 Temptrace™ Universal Kit for Self-Regulating Bundles

4041-5300 Temptrace™ Electric Splice or Tee Connection Kit for SL and SH Series Self-Regulating Bundles

Kit can be used to create an easily installed combination power splice and tee for self-regulating bundles. The kit contains enough components to make one input power connection or one input power splice connection or one splice/tee connection, as well as, two end terminations. It also includes RTV for bundle end seal.



### Connection Kit Contains:

- |   |                          |
|---|--------------------------|
| (1) 3/4" Pipe Stand                                   | (3) Ring Terminals       |
| (1) Sealing Grommet                                   | (2) Cable Entry Fittings |
| (4) Stainless Steel Pipe Straps<br>(2-large, 2-small) | (1) 3/4" Pipe Plug       |
| (1) 3 Hub Box   | (1) Grounding Screw      |
| (1) Box Cover   | (2) RTV-103BLK           |
| (6) Wire Nuts   | (1) SS Label             |
| (2) Butt Splice Connectors                            | (2) Reducing Bushings    |
| (1) SK-612 (Seal Patch Kit)                           | (3) 1" Heat Shrink Tubes |
|   | (3) 3" Heat Shrink Tubes |

**Caution:** The heater will come in contact with the power feed wires in the junction box. Make sure that the temperature rating of the power feed wire insulation is adequate for the heater used.

### Ground Fault Equipment Protection Devices (GFEPDs):

The IEEE standard (515-1989) for heating cables requires the use of GFEPDs with a nominal 30 milliampere trip level for "piping systems in classified areas, those areas requiring a high degree of maintenance, or which may be exposed to physical abuse or corrosive atmospheres."

## 4041-6101 Electrical End Termination Kit for Self-Regulating Bundles

Parflex Multitube® electrical end termination kits are designed to provide a method of terminating the non-powered end of the heating cable in Self-Regulating Temptrace™ bundles.

### 4041-6101 for use with Single Tube Bundle

Kit includes:

- (1) HSB-1 (single-leg heat shrink boot)
- (1) ESHS-1 (1" adhesive-lined, semi-rigid polyolefin tube)
- (1) ESHS-3 (3" adhesive-lined, semi-rigid polyolefin tube)

### 4041-6102 for use with Two Tube Bundle

Kit includes:

- (1) HSB-2 (two legged heat shrink boot)
- (1) ESHS-1 (1" adhesive-lined, semi-rigid polyolefin tube)
- (1) ESHS-3 (3" adhesive-lined, semi-rigid polyolefin tube)



## 4041-8200 Electrical End Termination Kit for SL and SH Self-Regulating Bundles

Parflex Multitube® electrical end termination kits are designed to provide a method of terminating the non-powered end of the heating cable in Self-Regulating Temptrace™ bundles.

Also in kit but not shown:

- (1) Two-part mounting block
- (1) Silicone end cap
- (2) Screws
- (1) Caution label
- (1) Roll glass tape
- (3) Additional heat grommets



### Approvals:

FM – Factory Mutual Approved  
 Ordinary Locations  
 UL Listed  
 Hazardous (Classified) Locations

Class I, Division 2, Groups B, C and D  
 Class II, Division 2, Groups F and G  
 Class III, Division 2

CSA Certified for use in ordinary areas and:  
 Class I, Division 2, Groups A, B, C and D  
 Class II, Division 2, Groups F and G



## Thermostats/Temperature Controllers

Thermostats are used to monitor the temperature of the process tubes or monitor the ambient temperature. Each thermostat is a mechanically actuated on/off temperature switch that controls the power to an electric tracer to achieve the desired process tube temperature. The high and low temperatures are pre-set at the factory, but are field-adjustable.

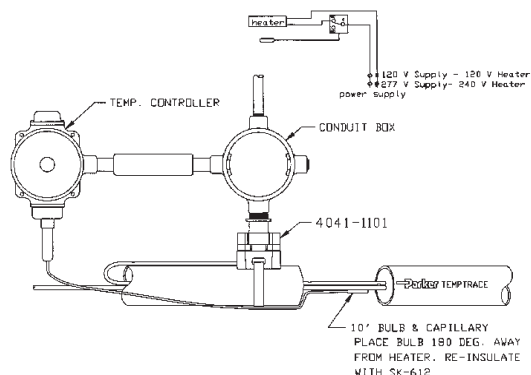

### 4012-01145 NEMA 4 Thermostat/ Temperature Controller



**Specifications:**

Temperature .....Field Adjustable, Tamper proof +25 to +325°F (-3 to +162°C)  
 Switch.....125/250/480 VAC – 22 amp SPDT Snap Acting  
 Accuracy ..... ±1% of full scale, approximately 3°F (1.6°C)  
 Capillary.....a10 Ft. type 304 S.S.  
 Bulb .....1/8" O.D. x 5/8" long type 304 S.S.  
 Size..... NEMA 4 x 4-1/4"H x 3-7/16W x 3-3/16D

Note: For further information and callout references, contact the Division.

### 4012-05145 NEMA 4x Thermostat/ Temperature Controller



**Specifications:**

Temperature ..... Field Adjustable, Tamper proof -125 to +500°F (-85 to +265°C)  
 Switch.....120/240 VAC – 20 amp SPDT Snap Acting  
 Accuracy ..... ±1% of full scale, approximately 3°F (1.6°C)  
 Capillary.....6 Ft. type 304 S.S.  
 Bulb .....3/8" O.D. x 2-1/4" long type 304 S.S.  
 Size..... NEMA 4 x 4-1/4"H x 3-7/16W x 3-3/16D

Note: For further information and callout references, contact the Division.

### 4012-01147 NEMA 7 Thermostat/ Temperature Controller



**Specifications:**

Temperature .....Field Adjustable, Tamper proof +25 to 325°F (-3 to +162°C)  
 Switch.....125/250/480 VAC – 22 amp SPDT Snap Acting  
 Accuracy ..... ±1% of full scale, approximately 3°F (1.6°C)  
 Capillary.....10 Ft. type 304 S.S.  
 Bulb .....1/8" O.D. x 5/8" long type 304 S.S.  
 Size..... NEMA 7 5-1/16H x 5-1/8W x 5-1/4D

Note: For further information and callout references, contact the Division.

### 4012-06105 NEMA 4x Thermostat/ Temperature Controller



**Specifications:**

Temperature .....Field Adjustable, Tamper proof +15 to +140°F (-9 to +60°C)  
 Switch.....125/250/480 VAC – 22 amp SPDT Snap Acting  
 Accuracy ..... ±1% of full scale, approximately 3°F (1.6°C)  
 Bulb ..... Fluid filled stem  
 NEMA Rating.....NEMA 4 x

Note: For further information and callout references, contact the Division.

## Parker Temptrace™ Feed Through (PTFT) Kit

Parflex PTFT kits provide a water tight seal where the heat trace tubing bundle enters into a junction box or instrument enclosure.

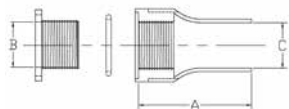

Molded Feed Through Part Number	Bundle O.D. Min-Max	"A" Length Nominal	Cabinet Wall Thickness Max	Drill Hole Size	"B" Feed Through I.D.	"C" Minimum Expanded I.D.
PTFT 1.50	0.75 - 1.50" (19 - 38 mm)	4.5" (11.4 cm)	0.375" (9.5 mm)	2" (5.1 cm)	1.60" (4.1 cm)	1.70" (4.3 cm)
PTFT 2.00	0.75 - 2.0" (19 - 51 mm)	7.0" (17.8 cm)	0.375" (9.5 mm)	2.36" (6.0 cm)	2.10" (5.1 cm)	2.75" (7.0 cm)
PTFT 2.75	1.43 - 2.75" (19 - 70 mm)	7.0" (17.8 cm)	1.0" (25.4 mm)	3.50" (8.9 cm)	2.75" (7.0 cm)	2.75" (7.0 cm)

PVC Pipe Fitting Style Part Number	"C" Bundle O.D. Min-Max	"A" Length Nominal	Cabinet Wall Thickness Max	Drill Hole Size	"B" Feed Through I.D.
PTFT 3.25	1.50 - 3.25" (38 - 83 mm)	10" (25.4 cm)	1.125" (28.6 mm)	4.50" (11.4 cm)	3.50" (8.9 cm)
PTFT 4.50	2.00 - 4.50" (51 - 114 mm)	10" (25.4 cm)	1.25" (28.6 mm)	5.00" (12.0 cm)	4.50" (11.4 cm)
PTFT 5.0	2.00 - 5.00" (51 - 114 mm)	12" (30.5 cm)	1.125" (28.6 mm)	5.50" (13.2 cm)	5.00" (12.0 cm)

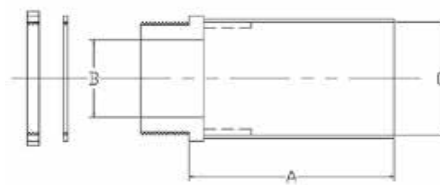

## Heat Shrinkable Boots (HSBs)

Parflex heat shrink boots (HSB) are designed to prevent moisture from entering the ends of Parflex Temptrace™ bundles. The dash number represents the number of breakouts in each boot. The boots can be used on 1/4", 3/8", or 1/2" tubes, or as a seal for the heating cable



HSB-1



HSB-2

Part Number	Before Heat Shrinking		After Heat Shrinking					
	Body I.D.	Leg(s) I.D.	Body			Leg(s)		
			I.D.	Thick	Length	I.D.*	Thick	Length
HSB-1	1.50	-	0.23	0.16	6.00	No Legs		
HSB-2	3.40	1.50	0.90	0.16	3.00	0.30	0.12	1.20
HSB-3	2.40	1.00	0.90	0.16	2.30	0.30	0.12	1.20
HSB-4	2.30	1.00	0.98	0.16	3.00	0.28	0.12	1.20
HSB-5	3.70	1.40	1.27	0.16	4.70	0.58	0.12	2.00
HSB-6	5.20	2.00	1.75	0.16	6.00	0.60	0.12	2.00

Grommet Selection Chart	
Part Number	Tube Size O.D. (inches)
GESKO-2	1/8
GESKO-4	1/4
GESKO-6	3/8
GESKO-8	1/2

\*Where "After Shrinking" Leg I.D. is larger than the tube size in the bundle, a silicone grommet or RTV should be used in conjunction with the boot to ensure a complete seal. (See grommet selection list to the right or RTV data listed on pg 14.)

## Parker Electric Trace Design Criteria Quote Request

Fax Inquiry To: Sales Office  
330-296-6747

Date: \_\_\_\_\_ Customer Name: \_\_\_\_\_

Bundle Type: **SL-Temptrace™**  Low Temperature Maintenance up to 150°F (65°C) and Freeze Protection and maximum internal exposure of 185°F power off.)

**SH Temptrace™**  (High Temperature Maintenance up to 250° F (121° C) and maximum internal exposure of 400°F power off.)

Total Quantity: \_\_\_\_\_ Feet   
Meters

Specified Lengths: \_\_\_\_\_  
\_\_\_\_\_

Part Number: \_\_\_\_\_ (See How-to-Order in applicable product section.)

*If not sure of part number, complete the following criteria:*

Maximum Temperature to be maintained: \_\_\_\_\_

Lowest ambient temperature: \_\_\_\_\_

Highest ambient temperature: \_\_\_\_\_

What is the highest internal process tube or steam purge temperature? \_\_\_\_\_

**Process Tubes:**

How many process tubes: \_\_\_\_\_

Size: (O.D. and wall thickness): \_\_\_\_\_ Inches   
mm

Tube Material: \_\_\_\_\_

**Trace Tube:**

Size: (O.D. and wall thickness): \_\_\_\_\_ Inches   
mm

Tube Material: \_\_\_\_\_

Outer Jacket Type: (Note: Black FR-PVC is Standard)

- |                                 |                                      |
|---------------------------------|--------------------------------------|
| FR-PVC <input type="checkbox"/> | <b>TPR</b> <input type="checkbox"/>  |
| FR-TPE <input type="checkbox"/> | <b>FRPE</b> <input type="checkbox"/> |
| FR-PUR <input type="checkbox"/> | <b>LDPE</b> <input type="checkbox"/> |
| PUR <input type="checkbox"/>    | <b>PVDF</b> <input type="checkbox"/> |

Area Classification

- General Purpose   
Class 1, Division 2   
Class 1, Division 1

Approval Agency

- FM  CSA  ATEX





## Section 2 —

## IS – Intermittent Steam Purge Bundles for Freeze Protection

Freeze Protection Bundles Designed for **Intermittent\*** High-Temperature Steam Purge



### General Design

Parflex IS-Intermittent Steam purge bundles are thermally insulated with a composite layer of fiberglass that allows for occasional, high-temperature steam purge up to 1100°F (593°C) while ensuring freeze protection during winter through the use of self-regulating heating cables.

Parflex IS-Intermittent Steam purge bundles are properly insulated to ensure that the outer surface area of the bundle remains at or below 140°F (60°C) during steam purge conditions at the highest specified ambient temperature, meeting NEC Personnel Protection Code 427.12

IS- Intermittent Steam purge bundles are designed to provide a freeze protection temperature of 40°F (4.4°C) at the lowest specified ambient temperature.

Parflex IS-Intermittent Steam products are readily available in single and double tube designs. The most common tube sizes requested are 3/8" and 1/2" Seamless Stainless Steel 316/316L/316H alloys in either an average wall specification, ASTM A269, or minimum wall specification, ASTM A213. Other alloys and standards are available.

We also have many other sizes available; including metric sizes 6 mm, 8mm, 10mm and 12mm. (See How to Specify & Order for details.)

### Testing

All IS-Intermittent Steam products are pressure tested prior to shipment. Third party testing and witnessing is available upon request, including DNV, ABS and Lloyd's Register. Contact factory for complete details.

### Jacketing Materials

Black, UV-resistant FR-PVC is our standard material; however, other jacketing materials are available upon request, including non-halogenated FR-TPE and Urethanes. Colored jackets are also available upon request. (See How to Specify and Order for details.)

### Heating Cables

Cables are available in 120V and 208-277 volt, with Heat outputs of 5, 10, 15 and 20 watt/ft.

Parflex standard IS designs come with an internal tinned copper braid on the heating cable for grounding purposes and a Fluoropolymer jacket over the heater to provide additional protection against harsh environments.

### \*Intermittent Design

Bundles can be steam purged for a period of 5 minutes once a day. During steam purge, the outer jacket surface temperature will not exceed 140°F (60°C).

# How To Specify & Order







## IS-Intermittent Steam Purge Bundles

Freeze Protection Bundles Designed For **Intermittent** High-Temperature Steam Purge

**IS - B 08 49 B - 5 1 2 C - V 4 B**

<b>IS</b> Product Family	<b>B</b> Process Tube Material	<b>08</b> Process Tube Size	<b>49</b> Process Tube Size	<b>B</b> Number of Process Tubes	<b>5</b> Maximum Steam Purge Temperature
<p><b>IS=</b> Intermittent High Temperature Steam</p> <p>** Intermittent is defined as steam purge for 5 minutes or less</p>	<p>1= Smls Copper Type DHP Alloy No 122. ASTM B68-B75</p> <p>2= Welded Stainless Steel Type 316/316L ASTM A269</p> <p>3= Welded Stainless Steel Type 304 ASTM A269</p> <p>B= Smls 316/316L ASTM A269</p> <p>C= Smls 304 ASTM A269</p> <p>D= Smls Monel Type 400</p> <p>E= Smls Hastelloy C22</p> <p>H= Smls 316H ASTM A213</p> <p>I = Smls Incoloy 825</p> <p>L= Electropolish Smls 316/316L ASTM A269 (10Ra Max)</p> <p>M=Smls 316/316L ASTM A213</p> <p>S= Silco Smls 316/316L ASTM A269</p> <p>P= PFA Fluoropolymer</p> <p>F= FEP Fluoropolymer</p> <p>T= TFE Fluoropolymer</p> <p>7= Parflex 919 PTFE SS Braided Hose</p> <p>9= Customer Specified Tube Material</p>	<p><b>O.D.</b></p> <p>See Selection Charts</p> <p>Imperial</p> <p>02=1/8" 03=3/16" 04=1/4" 05=5/16" 06=3/8" 07=7/16" 08=1/2" 10=5/8" 12=3/4" 16=1"</p> <p>Metric</p> <p>MA=2mm MB=4mm MC=6mm MD=8mm ME=10mm MF=12mm MG=14mm MH=16mm</p>	<p><b>Wall Thickness</b></p> <p>See Selection Charts</p> <p>Imperial</p> <p>16=.016" 20=.020" 28=.028" 30=.030 31=.031" 32=.032" 35=.035" 40=.040" 47=.047" 49=.049" 50=.050" 62=.062" 65=.065" 83=.083"</p> <p>Metric</p> <p>89=.89mm 10=1.0mm 15=1.5mm 20=2.0mm 25=2.5mm</p>	<p><b>Number of Process Tubes</b></p> <p>A= 1 Tube B= 2 Tubes C= 3 Tubes etc.</p> <p>P= 2 Tube Parallel Design</p>	<p><b>Maximum Steam Purge Temperature</b></p> <p>1= 1,000°F 5= 550°F (288°C) 6= 650°F (343°C) 7= 750°F (399°C) 8= 850°F (454°C) 9= other D= 1100°F (593°C)</p> <p>Note: For steam purges 400°F or less use Parker SL or SH Bundle Series. For temperatures above 1100°F contact factory.</p>

<b>1</b> Heating Cable Voltage	<b>2</b> Area Classification	<b>C</b> Average Environment Ambient Condition Range	<b>V</b> Jacket Material	<b>4</b> *Maximum Jacket Surface Temperature Design	<b>B</b> Jacket Color
<p>1= 120VAC 2= 240VAC</p> <p>* 240 volt cables can be powered at 208, 240 or 277 volts</p>	<p>1= Class I, Division 1 Areas</p> <p>2= General Purpose/Class I, Division 2 Areas</p>	<p>Low/High</p> <p>A= -40°F/80°F B= -20°F/95°F C= 0°F/105°F D= 10°F/115°F</p>	<p>V = FR-PVC T = FR-TPE U = FR-PUR P = PUR R = TPR E = FRPE L = LDPE F = PVDF</p> <p>Note: Parflex standard jacket material is FR-PVC</p>	<p>4=140°F Jacket</p> <p>140°F meets NEC 427.12 for personnel protection</p>	<p>N=Black B=Blue G=Green O=Orange Y=Yellow P=Purple R=Red W=White</p> <p>Note: Parflex standard color jacket is black</p>

Part Number #	Process Tube O.D. (in.) 	Wall Thickness (in.) 	Nominal Product O.D. (in.) 	Product Weight (lbs./ft.) 	Min. Bend Radius (in.) 	Watt Density per foot / Voltage	Circuit Length Ft @ 50°F Start-up / Breaker (amps), 120V	Performance At Low Ambient Conditions	Maximum Allowable Intermittent Steam Purge	Maximum Jacket Surface Temperature during Steam Purge & High Ambient 80°F (26.6°C)
						Watt/FT 	@120V** 	At -40°F (-40°C) will maintain at least freeze protection***	Intermittent is 5 minutes steam purge per day.	
<b>IS- Single Process Tube - Seamless Stainless Steel*, ASTM A269</b>										
IS-B0849A-612A-V4	(1) 1/2"	0.049"	1.93	0.59	12	10	250 Ft / 40 Amp	40°F (4.4°C)	650°F (343°C)	140°F (60°C)
IS-B0849A-712A-V4	(1) 1/2"	0.049"	2.01	0.61	12	10	250 Ft / 40 Amp	40°F (4.4°C)	750°F (399°C)	140°F (60°C)
IS-B0849A-812A-V4	(1) 1/2"	0.049"	2.09	0.62	13	15	190 Ft / 40 Amp	40°F (4.4°C)	850°F (454°C)	140°F (60°C)
IS-B0849A-912A-V4	(1) 1/2"	0.049"	2.09	0.62	13	15	190 Ft / 40 Amp	40°F (4.4°C)	950°F (510°C)	140°F (60°C)
<b>IS- Dual Process Tube - Seamless Stainless Steel*, ASTM A269</b>										
IS-B0849B-612A-V4	(2) 1/2"	0.049"	2.25	0.88	13	10	250 Ft / 40 Amp	40°F (4.4°C)	650°F (343°C)	140°F (60°C)
IS-B0849B-712A-V4	(2) 1/2"	0.049"	2.33	0.89	14	10	250 Ft / 40 Amp	40°F (4.4°C)	750°F (399°C)	140°F (60°C)
IS-B0849B-812A-V4	(2) 1/2"	0.049"	2.33	0.89	14	15	190 Ft / 40 Amp	40°F (4.4°C)	850°F (454°C)	140°F (60°C)
IS-B0849B-912A-V4	(2) 1/2"	0.049"	2.41	0.90	14	15	190 Ft / 40 Amp	40°F (4.4°C)	950°F (510°C)	140°F (60°C)

\*Many other alloys available in addition to seamless stainless steel tubing.

\*\*Product is also available in 208, 240 and 277V

\*\*\*As ambient conditions go above -40°F (-40°C), without use of a controller, the product could maintain higher temperatures.



**FM – Factory Mutual**

General Purpose - Ordinary Locations  
Hazardous Locations, when installed with Parflex accessories.

- Class I, Div. 2, Groups B, C and D (gases, vapors)
- Class II, Div.2, Group F, G (Combustible dust)
- Class III, Div.2, (ignitable fibers and filings)

**T-Temperature Ratings**

- 3, 5 and 8 watt rated T3 temperature class
- 10, 15 and 20 watt rated T2D temperature class

**CSA – Canadian Standards Association**

CSA Certified for ordinary locations  
For certified hazardous locations contact Parflex

**ATEX - Certified cables & accessories available**

**Electrical Specifications:**

Operating Voltage: 120 V or 240V  
Bus Wire Voltage Rating: 600 Volts  
Bus Wire Size: 14 AWG

## CS – Continuous Steam Purge Bundles for Freeze Protection

Freeze Protection Bundles Designed For **Continuous** High-Temperature Steam Purge Exposure



### General Design

Parflex CS-Continuous Steam purge bundles are thermally insulated with a composite layer of fiberglass that allows for continuous, high-temperature steam purge up to 1100°F (593°C) while ensuring freeze protection during winter through the use of self-regulating heating cables.

Parflex CS-Continuous Steam purge bundles are properly insulated to meet customer specified jacket surface temperature requirements, during the highest steam purge conditions and maximum ambient temperature requested. (See How to Specify & Order for details.)

CS-Continuous Steam purge bundles are designed to provide a freeze protection temperature of 40°F (4.4°C) at the lowest specified ambient temperature.

### Heating Cables

Cables are available in 120V and 208-277 volt, with heat outputs of 5, 10, 15 and 20 watt/ft.

Parflex standard CS designs come with an internal tinned copper braid on the heating cable for grounding purposes and a Fluoropolymer jacket over the heating cable to provide additional protection against many harsh environments.

### Continuous Steam Purge

Internal bundle tubes can be steam purged for any duration required without effecting performance to the heating element. The outer jacket surface temperature can vary depending upon customer design specifications. (See How to Specify & Order for details.)

### Common Tube Materials and Sizes

Parflex CS-Continuous Steam products are readily available in single and double tube designs. The most common tube sizes requested are 3/8" and 1/2" Seamless Stainless Steel 316/316L/316H alloys in either an average wall specification, ASTM A269, or minimum wall specification, ASTM A213. Other alloys and standards are available.

We also have available many other sizes; including metric sizes 6 mm, 8mm, 10mm and 12mm. (See How to Specify & Order for details.)

### Testing

All CS-Intermittent Steam products are pressure tested prior to shipment. Third party testing and witnessing is available upon request, including DNV, ABS and Lloyd's Register. Contact factory for complete details.

### Jacketing Materials

Black, UV-resistant FR-PVC is our standard material; however, other jacketing materials are available upon request, including non-halogenated FR-TPE and Urethanes. Colored jackets are also available upon request. (See How to Specify & Order for details.)

# How to Specify & Order

## CS-Continuous High Temperature Steam Purge Bundles







Freeze Protection Bundles Designed For **Continuous** High-Temperature Steam Purge Exposure

**CS - B 08 49 B - 5 1 2 C - V 4 B**

<b>CS</b> Product Family	<b>B</b> Process Tube Material	<b>08</b> Process Tube Size	<b>49</b> Process Tube Size	<b>B</b> Number of Process Tubes	<b>5</b> Maximum Steam Purge Temperature
<p><b>CS</b>= Continuous High Temperature Steam Purge</p>	<p>1= Smls Copper Type DHP Alloy No 122. ASTM B68-B75                  2= Welded Stainless Steel Type 316/316L ASTM A269                  3= Welded Stainless Steel Type 304 ASTM A269</p> <p>B= Smls 316/316L ASTM A269                  C= Smls 304 ASTM A269                  D= Smls Monei Type 400                  E= Smls Hastelloy C22                  H= Smls 316H ASTM A213                  I= Smls Incoloy 825                  L= Electropolish Smls 316/316L ASTM A269 (10Ra Max)                  M= Smls 316/316L ASTM A213                  S= Silco Smls 316/316L ASTM A269                  P= PFA Flouropolymer                  F= FEP Fluoropolymer                  T= TFE Fluoropolymer</p> <p>7= Parflex 919 PTFE SS Braided Hose                  9= Customer Specified Tube Material</p>	<p><b>O.D.</b></p> <p>See Selection Charts</p> <p>Imperial</p> <p>02=1/8"                  03=3/16"                  04=1/4"                  05=5/16"                  06=3/8"                  07=7/16"                  08=1/2"                  10=5/8"                  12=3/4"                  16=1"</p> <p>Metric</p> <p>MA=2mm                  MB=4mm                  MC=6mm                  MD=8mm                  ME=10mm                  MF=12mm                  MG=14mm                  MH=16mm</p>	<p><b>Wall Thickness</b></p> <p>See Selection Charts</p> <p>Imperial</p> <p>16=.016"                  20=.020"                  28=.028"                  30=.030"                  31=.031"                  32=.032"                  35=.035"                  40=.040"                  47=.047"                  49=.049"                  50=.050"                  62=.062"                  65=.065"                  83=.083"</p> <p>Metric</p> <p>89=.89mm                  10=1.0mm                  15=1.5mm                  20=2.0mm                  25=2.5mm</p>	<p>A= 1Tube                  B= 2Tubes                  C= 3 Tubes etc.</p> <p>P= 2 Tube Parallel Design</p>	<p>1= 1,000°F                  5= 550°F (288°C)                  6= 650°F (343°C)                  7= 750°F (399°C)                  8= 850°F (454°C)                  9= other                  D= 1100°F (593°C)</p> <p>Note: For steam purges 400°F or less use Parker SL or SH Bundle Series. For temperatures above 1100°F contact factory.</p>

<b>1</b> Heating Cable Voltage	<b>2</b> Area Classification	<b>C</b> Average Environment Ambient Condition Range	<b>V</b> Jacket Material	<b>4</b> Jacket Surface Temperature Design	<b>B</b> Jacket Color
<p>1= 120VAC                  2= 240VAC</p> <p>* 240 volt cables can be powered at 208, 240 or 277 volts</p>	<p>1= Class I, Division 1 Areas</p> <p>2= General Purpose/Class I, Division 2 Areas</p>	<p>Low/High</p> <p>A= -40°F/80°F                  B= -20°F/95°F                  C= 0°F/105°F                  D= 10°F/115°F</p>	<p>V=FR-PVC                  T=FR-TPE                  U=FR-PUR                  P=PUR                  R=TPR                  E=FRPE                  L=LDPE                  F=PVDF</p> <p>Note: Parflex standard jacket material is FR-PVC</p>	<p>4=140°F Jacket                  6=160°F Jacket                  8= 180°F Jacket</p> <p>* Jacket surface temperature will not exceed this maximum when the bundle is operated at the designed steam purge temperature at the highest ambient design condition</p>	<p>N=Black                  B=Blue                  G=Green                  O=Orange                  Y=Yellow                  P=Purple                  R=Red                  W=White</p> <p>Note: Parflex standard color jacket is black</p>



Part Number  #	Process Tube O.D. (in.) 	Wall Thickness (in.) 	Nominal Product O.D. (in.) 	Product Weight (lbs./ft.) 	Min. Bend Radius (in.) 	Watt Density per foot/Voltage	Circuit Length Ft @ 50°F Start-up / Breaker (amps), 120V	Performance At Low Ambient Conditions	Maximum Allowable Continuous Steam Purge	Max. Jacket Surface Temp. during Steam Purge & High Ambient 80°F (26.6°C)
						Watt/FT	 @ 120V**	At -40°F (-40°C) will maintain at least freeze protection***	Continuous Steam Purge	

**CS – Continuous Steam Purge – Single Process Tube Seamless Stainless Steel\*, ASTM A269**

CS-B0849A-612A-V8N	(1) 1/2"	0.049"	1.61	0.55	10	10	250 Ft. / 40 Amp	40°F (4.4°C)	650°F (343°C)	180°F (82°C)
CS-B0849A-712A-V8N	(1) 1/2"	0.049"	1.85	0.59	11	10	250 Ft. / 40 Amp	40°F (4.4°C)	750°F (399°C)	180°F (82°C)
CS-B0849A-812A-V8N	(1) 1/2"	0.049"	2.01	0.61	12	15	190 Ft. / 40 Amp	40°F (4.4°C)	850°F (454°C)	180°F (82°C)
CS-B0849A-912A-V8N	(1) 1/2"	0.049"	2.17	0.63	13	15	190 Ft. / 40 Amp	40°F (4.4°C)	950°F (510°C)	180°F (82°C)

**CS – Continuous Steam Purge – Dual Process Tube Seamless Stainless Steel\*, ASTM A269**

CS-B0849B-612A-V8N	(2) 1/2"	0.049"	2.09	0.86	13	10	250 Ft. / 40 Amp	40°F (4.4°C)	650°F (343°C)	180°F (82°C)
CS-B0849B-712A-V8N	(2) 1/2"	0.049"	2.25	0.88	13	10	250 Ft. / 40 Amp	40°F (4.4°C)	750°F (399°C)	180°F (82°C)
CS-B0849B-812A-V8N	(2) 1/2"	0.049"	2.49	0.92	15	15	190 Ft. / 40 Amp	40°F (4.4°C)	850°F (454°C)	180°F (82°C)
CS-B0849B-912A-V8N	(2) 1/2"	0.049"	2.69	1.04	16	15	190 Ft. / 40 Amp	40°F (4.4°C)	950°F (510°C)	180°F (82°C)

\*Many other alloys available, as well as seamless stainless steel tubing.

\*\*Product is also available in 208, 240 and 277V

\*\*\*As ambient conditions go above -40°F (-40°C) , without use of a controller the product could maintain higher temperatures.



**FM – Factory Mutual**

General Purpose - Ordinary Locations  
Hazardous Locations, when installed with Parflex accessories.

- Class I, Div. 2, Groups B, C and D (gases, vapors)
- Class II, Div.2, Group F, G (Combustible dust)
- Class III, Div.2, (ignitable fibers and filings)

**T-Temperature Ratings**

- 3, 5 and 8 watt rated T3 temperature class
- 10, 15 and 20 watt rated T2D temperature class

**CSA – Canadian Standards Association**

CSA Certified for ordinary locations  
For certified hazardous locations contact Parflex

**ATEX - Certified Cables & accessories available**

**Electrical Specifications:**

Operating Voltage: 120 V or 240V  
Bus Wire Voltage Rating: 600 Volts  
Bus Wire Size: 14 AWG



## Section 3 —

## CL— Constant Wattage Electric Trace Tubing for Low Temperature Maintenance

Maintain Temperatures up to 250°F (121°C) and withstand Maximum Internal Exposure up to 400°F (204°C)



### General

Parflex CL Constant Wattage Temptrace™ electric trace tubing consists of a process tube traced with a constant wattage heating cable, a heat transfer foil wrap, nonhygroscopic glass fiber insulation and a black, 105°C-rated, flame-resistant PVC (FR-PVC) jacket.

Parflex CL-Temptrace™ is designed for various temperature ranges including:

- Freeze protection and viscosity maintenance of 50°F (10°C) at ambient temperatures of -40°F (-40°C)
- Low process temperature maintenance from 160°F (71.1°C) to 250°F (121.1°C) at -40°F (-40°C) to 80°F (26.7°C) ambient conditions.

Standard product has a Maximum Temperature Rating (MTR\*) of 400°F (204.4°C) when power to the heating cable is off, and 250°F (121.1°C) when power to the heating cable is on. See CH-Constant Wattage design for higher temperature ranges.

\*Maximum Temperature Rating is the maximum allowable temperature of the tracing fluid. Temperatures in excess of this may damage the product or alter its performance.

### Applications

CL-Temptrace™ is ideal for analyzer, impulse and instrument lines; small diameter process lines; stack gas sampling lines; and utility lines.

### Tubing

Type 122 DHP Seamless Copper, 316/316L Welded and Seamless Stainless Steel, PFA, FEP and PTFE are standard. Wall thicknesses are available upon request. For Material Specifications of metal tubing, see *Technical Data* in Section of the catalog. Consult Division for details.

### Heat Transfer Foil

An aluminum heat transfer foil allows for even heat distribution for precise temperature control.

### Insulation

Air-spaced, cross wrapped applied non-hygroscopic fiberglass thermal insulation provides minimum heat loss.

### Jacket

The tough, black, 105°C-rated, flame-resistant PVC (FR-PVC) jacket protects the tubing against corrosive atmospheres, water, oils, acids, alkalies and most chemicals. Additional jacket materials are available upon request. For Material Specifications of jackets, see *Technical Data* in Section of the catalog. Consult Division for additional details.

### Testing

Each tube in every length of Parflex Temptrace™ is pressure tested prior to shipment to assure the instrument engineer a high-quality, reliable, trouble-free product. For Testing Specifications, see *Technical Data* in Section of the catalog.

### Accessories

Accessories are available for electrical connections, bundle splicing and end terminations. Accessories for constant wattage bundles are identified in this section.

### Ordering

See the following page for information about how to specify and order.

**NOTE:** It is absolutely necessary to seal the ends against contamination from moisture and/or corrosive liquids. Parker Hannifin cannot assume any liability for product damage caused by moisture from unsealed ends.

## How to Specify & Order

### CL-Constant Watt Low Temperature Maintenance Electric Trace Bundles

Maintain Temperatures up to 250°F (121°C) with a Maximum Internal Exposure up to 400°F (204°C)

**CL - 4 1 2 - B 08 35 B - V B**

CL	Bundle Type	4	Heating Cable (Watt/ft)	1	Heating Cable Voltage	2	Area Classification	B	Process Tube Material
	CL= Constant Watt Low Temperature		See Selection Chart  4= 4 watt 8= 8 watt 2= 12 watt ?= 16 watt C= 18 watt		1= 120VAC 2= 240VAC 8= 208VAC		2= General Purpose & FM Class I, Division 2 Areas		1= Smls Copper Type DHP Alloy No 122. ASTM B68-B75 2= Welded Stainless Steel Type 316/316L ASTM A269 3= Welded Stainless Steel Type 304 ASTM A269 B= Smls 316/316L ASTM A269 C= Smls 304 ASTM A269 D= Smls Monel Type 400 E= Smls Hastelloy C22 H= Smls 316H ASTM A213 I = Smls Incoloy 825 L= Electropolish Smls 316/316L ASTM A269 (10Ra) M= Smls 316/316L ASTM A213 S= Silco Smls 316/316L ASTM A269 P= PFA Fluoropolymer F= FEP Fluoropolymer T= TFE Fluoropolymer 7= Parflex 919 PTFE SS Braided Hose 9= Customer Specified Tube Material

08	Process Tube Size	35	Process Tube Size	B	Number of Process Tubes	V	Jacket Material	B	Jacket Color
	<b>O.D.</b>  See Selection Charts  Imperial  02=1/8" 03=3/16" 04=1/4" 05=5/16" 06=3/8" 07=7/16" 08=1/2" 10=5/8" 12=3/4" 16=1"  Metric  MA=2mm MB=4mm MC=6mm MD=8mm ME=10mm MF=12mm MG=14mm MH=16mm		<b>Wall Thickness</b>  See Selection Charts  Imperial  16=.016" 20=.020" 28=.028" 30=.030 31=.031" 32=.032" 35=.035" 40=.040" 47=.047"  49=.049" 50=.050" 62=.062" 65=.065" 83=.083"  Metric  89=.89mm 10=1.0mm 15=1.5mm 20=2.0mm 25=2.5mm		A= 1Tube B=2 Tubes C=3 Tubes etc.  P= 2 Tube Parallel Design		V = FR-PVC T = FR-TPE U = FR-PUR P = PUR R = TPR E = FRPE L = LDPE F = PVDF  Note: Parflex standard jacket material is FR-PVC		N=Black B=Blue G=Green O=Orange Y=Yellow P=Purple R=Red W=White  Note: Parflex standard color jacket is black  Note: For standard black FR-PVC jacketed product -VN may be dropped

**Electrical Specifications:**

Heater type	4 W./ft.	11.4W./ft.
Insulation	PFA Teflon® 600 V rated	PFA Teflon® 600V rated
Bus wire size	12 AWG	12 AWG
Heating zone length**	18" (45.7 cm) and 24" (61 cm)	

Part Number Series	Power Consumption W/ft (W/m)	Voltage	Maximum Circuit Length* ft (m) 	Current A/ft (A/m)
CL	4 (13.1)	120	340 (103.6)	0.033 (0.108)
		240	680 (207.3)	0.017 (0.55)
CL	11.4 (37.4)	120	200 (61)	0.095 (0.312)
		240	400 (122)	0.0485 (0.156)

**\*\*Installation Note:**

**Caution:** Cutting beyond heating zone indentation will result in an unheated section of the heater wire for the balance of the heating zone length. The bus wires **MUST NOT** be connected together on the termination end!

For recommended temperature controller, see 4012-01145 (G.P. areas) and 4012-01147 (Hazardous locations) on page 31.

**Approvals:**

Ordinary Locations

FM – Factory Mutual Approved  
 Hazardous (Classified) Locations  
 FM – Factory Mutual Approved

Class I, Division 2, Groups B, C and D  
 Class II, Division 2, Groups F and G  
 Class III, Division 1 and 2

**Ground Fault Equipment Protection Devices (GFEPDs):**

The IEEE standard (515-1989) for heating cables requires the use of GFEPDs with a nominal 30 milliampere trip level for “piping systems in classified areas, those areas requiring a high degree of maintenance, or which may be exposed to physical abuse or corrosive atmospheres.”

**For performance characteristics see next page.**

## Performance Data—Single Process Tube

CL Constant Watt Low Temperature Heater 4 watt/ft - Single Tube Designs

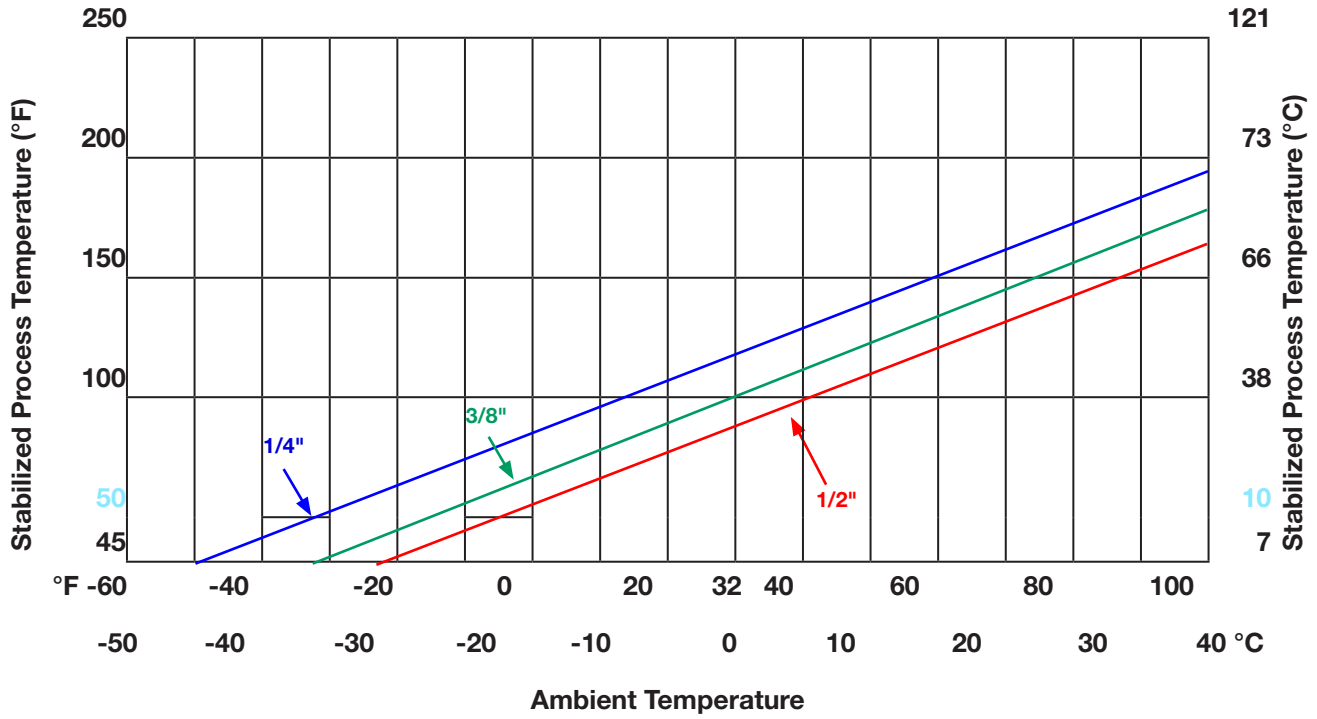

## Performance Data—Dual Process Tube

CL Constant Watt Low Temperature Heater 4 watt/ft - Dual Tube Designs

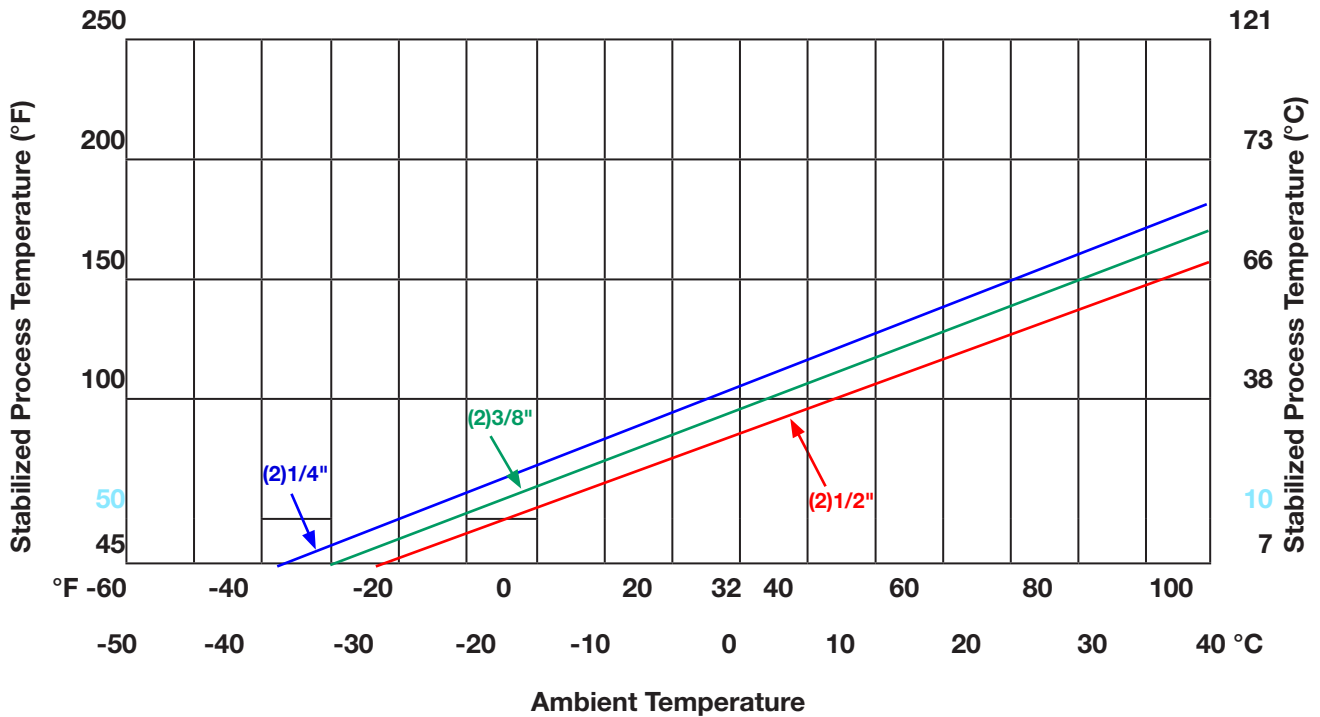

**CL Series Constant Watt Bundles**  
**Maximum Exposure 400°F (204°C)**  
**Process Tubes 1/4" to 1/2" O.D. (6mm to 12mm)**  
**Single or Dual Tube Designs**

Minimum Process Temperature to Maintain	Standard Insulation Package *				
	Environments Average High / Low Ambient Conditions				
	Extreme Cold	Cold	Moderate Cold	Moderate	Warm
	-65°F Low 80°F High	-40°F Low 80°F High	-10°F Low 95°F High	0°F Low 105°F High	10°F Low 115°F High
<b>120 Volts</b>	-54°C Low 26°C High	-40°C Low 26°C High	-24°C Low 35°C High	-18°C Low 40°C High	-13°C Low 46°C High
40°F (4°C)	8 Watt / Ft	8 Watt / Ft	4 Watt / Ft	4 Watt / Ft	4 Watt / Ft
50°F (10°C)	11.4 Watt / Ft	8 Watt / Ft	8 Watt / Ft	4 Watt / Ft	4 Watt / Ft
75°F (24°C)	11.4 Watt / Ft	11.4 Watt / Ft	8 Watt / Ft	8 Watt / Ft	8 Watt / Ft
100°F (38°C)	18 Watt / Ft	11.4 Watt / Ft	11.4 Watt / Ft	8 Watt / Ft	8 Watt / Ft
125°F (52°C)	18 Watt / Ft	18 Watt / Ft	11.4 Watt / Ft	11.4 Watt / Ft	11.4 Watt / Ft
150°F (66°C)	18 Watt / Ft	18 Watt / Ft	18 Watt / Ft	18 Watt / Ft	11.4 Watt / Ft
175°F (79°C)		18 Watt / Ft	18 Watt / Ft	18 Watt / Ft	18 Watt / Ft
200°F (93°C)			18 Watt / Ft	18 Watt / Ft	18 Watt / Ft
225°F (107°C)			18 Watt / Ft	18 Watt / Ft	18 Watt / Ft
<b>208 Volts</b>					
40°F (4°C)	8 Watt / Ft	8 Watt / Ft	8 Watt / Ft	4 Watt / Ft	4 Watt / Ft
50°F (10°C)	11.4 Watt / Ft	8 Watt / Ft	8 Watt / Ft	4 Watt / Ft	4 Watt / Ft
75°F (24°C)	11.4 Watt / Ft	11.4 Watt / Ft	15 Watt / Ft	8 Watt / Ft	8 Watt / Ft
100°F (38°C)	18 Watt / Ft	11.4 Watt / Ft	15 Watt / Ft	8 Watt / Ft	8 Watt / Ft
125°F (52°C)		18 Watt / Ft	20 Watt / Ft	11.4 Watt / Ft	11.4 Watt / Ft
150°F (66°C)			18 Watt / Ft	11.4 Watt / Ft	11.4 Watt / Ft
175°F (79°C)				18 Watt / Ft	18 Watt / Ft
<b>240 Volts</b>					
40°F (4°C)	8 Watt / Ft	8 Watt / Ft	4 Watt / Ft	4 Watt / Ft	4 Watt / Ft
50°F (10°C)	11.4 Watt / Ft	8 Watt / Ft	8 Watt / Ft	4 Watt / Ft	4 Watt / Ft
75°F (24°C)	11.4 Watt / Ft	11.4 Watt / Ft	8 Watt / Ft	8 Watt / Ft	8 Watt / Ft
100°F (38°C)	18 Watt / Ft	11.4 Watt / Ft	11.4 Watt / Ft	8 Watt / Ft	8 Watt / Ft
125°F (52°C)	18 Watt / Ft	18 Watt / Ft	11.4 Watt / Ft	11.4 Watt / Ft	11.4 Watt / Ft
150°F (66°C)	18 Watt / Ft	18 Watt / Ft	18 Watt / Ft	18 Watt / Ft	11.4 Watt / Ft
175°F (79°C)		18 Watt / Ft	18 Watt / Ft	18 Watt / Ft	18 Watt / Ft
200°F (93°C)			18 Watt / Ft	18 Watt / Ft	18 Watt / Ft
225°F (107°C)			18 Watt / Ft	18 Watt / Ft	18 Watt / Ft

\* The above heater cable selection is based upon our standard insulation package. Other insulation packages are available to maintain higher temperatures.

**How to Use:**

- 1) Check to be sure you are using the correct chart.
- 2) Choose your operating voltage.
- 3) Choose the minimum process temperature you want to maintain.  
 Note: If temperature is not shown, pick the next higher option.
- 4) Follow chart across to the ambient Condition that best match your area.
- 5) Use the watt-density shown for your part number derivation.

**Note:**

The watt-density selected will maintain the temperature indicated at a minimum. Depending upon actual ambient fluctuations, process tubes size and number of tubes, the maintenance temperature could be higher.

## CH— Constant Wattage Electric Trace Tubing for High Temperature Maintenance

Maintain Temperatures up to 400°F (204°C) and withstands Maximum Internal Exposure to 400°F (204°C)



### General

Parflex CH Constant Wattage Temptrace™ electric trace tubing consists of a process tube, or tubes, traced with a constant wattage heating cable, a heat transfer foil wrap, nonhygroscopic glass fiber insulation and a black, 105°C-rated, flame-resistant PVC (FR-PVC) jacket.

Parflex CH-Temptrace™ is designed for process temperature maintenance from 160°F (71°C), at -40°F (-40°C) ambient temperatures, to 400°F (204°C), at 80°F (26.7°C) ambient. Contact the factory for complete design capabilities for your application.

Standard product has a Maximum Temperature Rating\* (MTR) of 400°F (204.4°C) when power to the heating cable is on. Consult Division for details.

\*Maximum Temperature Rating is the maximum allowable temperature of the tracing fluid. Temperatures in excess of this may damage the product or alter its performance.

### Applications

CH-Temptrace™ is ideal for analyzer, impulse and instrument lines; small diameter process lines; stack gas sampling lines; and utility lines.

### Tubing

Type 122 DHP Seamless Copper, 316/316L Welded and Seamless Stainless Steel, FEP, PFA and PTFE are standard. Special wall thicknesses are available upon request. For Material Specifications of metal tubing, see *Technical Data* Section.

### Tubing Identification

When process tubes are the same size and material, each individual tube is printed with a tube number at two-inch intervals or tubes are color coded.

### Heat Transfer Foil

An aluminum heat transfer foil allows for even heat distribution for precise temperature control.

### Insulation

Air-spaced, cross wrapped applied non-hygroscopic fiberglass thermal insulation provides minimum heat loss.

### Jacket

The tough, black, 105°C-rated, flame-resistant PVC (FR-PVC) jacket protects the tubing against corrosive atmospheres, water, oils, acids, alkalies and most chemicals. Additional jacket materials are available upon request. For Material Specifications of jackets, see *Technical Data* Section of the catalog.

### Testing

Each tube in every length of Parflex Temptrace™ is pressure tested prior to shipment to assure the instrument engineer a high quality, reliable, trouble-free product. For Testing Specifications, see *Technical Data* Section of the catalog.

### Accessories

Accessories are available for electrical connections, bundle splicing and end terminations. Accessories for constant wattage bundles are identified in this section.

### Ordering

See the following page for information about how to specify and order.

**NOTE:** It is absolutely necessary to seal the ends against contamination from moisture and/or corrosive liquids. Parker Hannifin cannot assume any liability for product damage caused by moisture from unsealed ends.



## How to Specify & Order

### CH-Constant Watt High Temperature Maintenance Electric Trace Bundles

Maintain Temperatures up to 400°F (204°C) with a Maximum Internal Exposure up to 400°F (204°C)

**CH - 4 1 2 - B 08 35 B - V B**

CH	Bundle Type	4	Heating Cable (Watt/ft)	1	Heating Cable Voltage	2	Area Classification	B	Process Tube Material
	CH= Constant Watt High Temperature		See Selection Chart  4= 4 watt 2= 12 watt C= 18 watt 8= 8 watt		1= 120VAC 2= 240VAC 8= 208VAC		2= General Purpose & FM Class I, Division 2 Areas		1= Smis Copper Type DHP Alloy No 122. ASTM B68-B75 2= Welded Stainless Steel Type 316/316L ASTM A269 3= Welded Stainless Steel Type 304 ASTM A269 B= Smis 316/316L ASTM A269 C= Smis 304 ASTM A269 D= Smis Monel Type 400 E= Smis Hastelloy C22 H= Smis 316H ASTM A213 I = Smis Incoloy 825 L= Electropolish Smis 316/316L ASTM A269 (10Ra) M= Smis 316/316L ASTM A213 S= Silco Smis 316/316L ASTM A269 P= PFA Fluoropolymer F= FEP Fluoropolymer T= TFE Fluoropolymer  7= Parflex 919 PTFE SS Braided Hose  9= Customer Specified Tube Material

08	Process Tube Size	35	Process Tube Size	B	Number of Process Tubes	V	Jacket Material	B	Jacket Color
	O.D.		Wall Thickness		A= 1 Tube B= 2 Tubes C= 3 Tubes etc.		V=FR-PVC T=FR-TPE U=FR-PUR P=PUR R=TPR E=FRPE L=LDPE F=PVDF		N=Black B=Blue G=Green O=Orange Y=Yellow P=Purple R=Red W=White
	See Selection Charts		See Selection Charts		P= 2 Tube Parallel Design		Note: Parflex standard jacket material is FR-PVC		Note: Parflex standard color jacket is black
	Imperial		Imperial						Note: For standard black FR-PVC jacketed product -VN may be dropped
	02=1/8" 03=3/16" 04=1/4" 05=5/16" 06=3/8" 07=7/16" 08=1/2" 10=5/8" 12=3/4" 16=1"		16=.016" 20=.020" 28=.028" 30=.030 31=.031" 32=.032" 35=.035" 40=.040" 47=.047" 49=.049" 50=.050" 62=.062" 65=.065" 83=.083"						
	Metric		Metric						
	MA=2mm MB=4mm MC=6mm MD=8mm ME=10mm MF=12mm MG=14mm MH=16mm		89=.89mm 10=1.0mm 15=1.5mm 20=2.0mm 25=2.5mm						

## Electrical Specifications:

Heater type	12 W./ft.	18 W./ft.
Insulation	Kapton®	Kapton®
Bus wire size	12 AWG	12 AWG
Heating zone length**	Average 48" (121.9 cm) for high temperature Kapton® insulated heater wires	

Part Number Series	Power Consumption W/ft (W/m)	Voltage	Maximum Circuit Length* ft (m)	Current A/ft (A/m)
CH	12 (39.3)	120	180 (54.9)	0.100 (0.3281)
		240	360 (109.7)	0.050 (0.164)
CH	18.0 (58.95)	120	147 (44.8)	0.150 (0.49)
		240	294 (89.6)	0.075 (0.246)

\*Based on 10% power drop

**\*\*Installation Note:**

**Caution:** Cutting beyond heating zone indentation will result in an unheated section of the heater wire for the balance of the heating zone length. The bus wires **MUST NOT** be connected together on the termination end!

For recommended temperature controller, see 4012-01145 (G.P. areas) and 4012-01147 (Hazardous locations) on page 31.

### Approvals:

Ordinary Locations

FM – Factory Mutual Approved

Hazardous (Classified) Locations

FM – Factory Mutual Approved

Class I, Division 2, Groups B, C and D

Class II, Division 2, Groups F and G

Class III, Division 1 and 2

### Ground Fault Equipment Protection Devices (GFEPDs):

The IEEE standard (515-1989) for heating cables requires the use of GFEPDs with a nominal 30 milliampere trip level for “piping systems in classified areas, those areas requiring a high degree of maintenance, or which may be exposed to physical abuse or corrosive atmospheres.”

## Performance Data—Single Process Tube

### CH Constant Watt Low Temperature Heater 8 watt/ft - Single Tube Designs

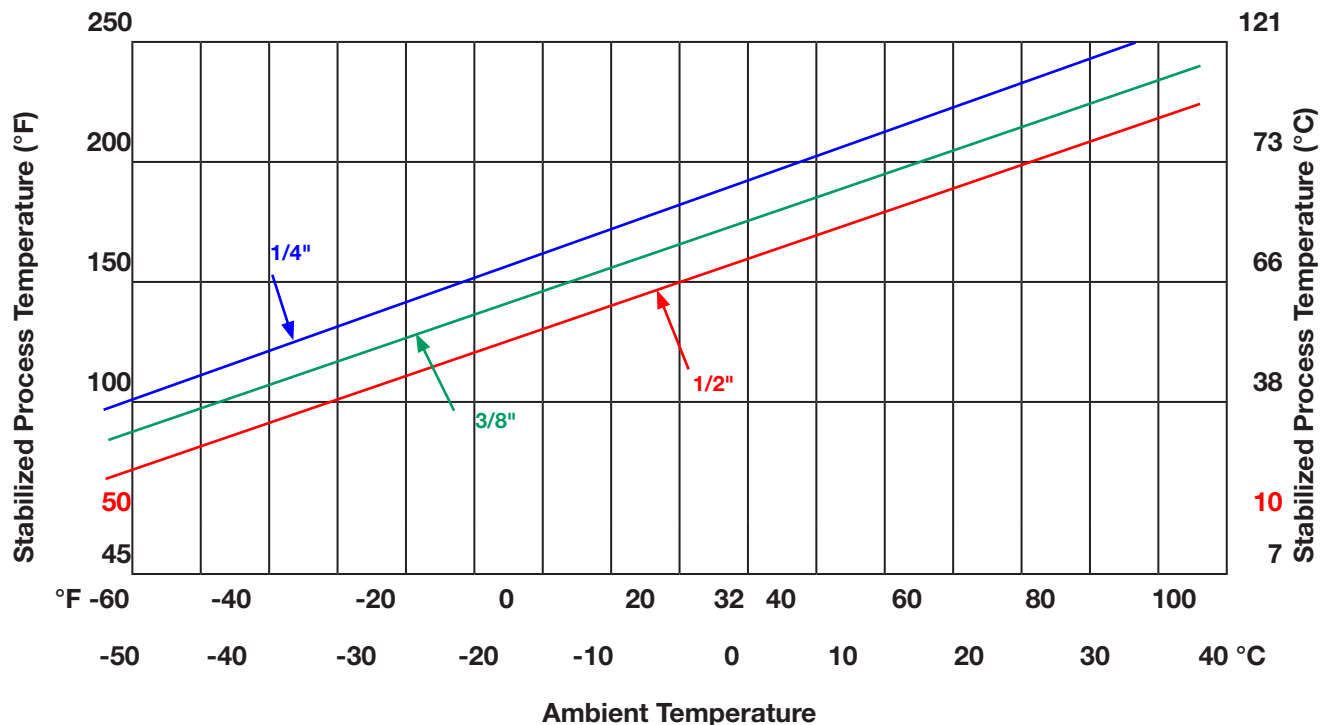

## Performance Data—Dual Process Tube

### CH Constant Watt High Temperature Heater 8 watt/ft - Dual Tube Designs

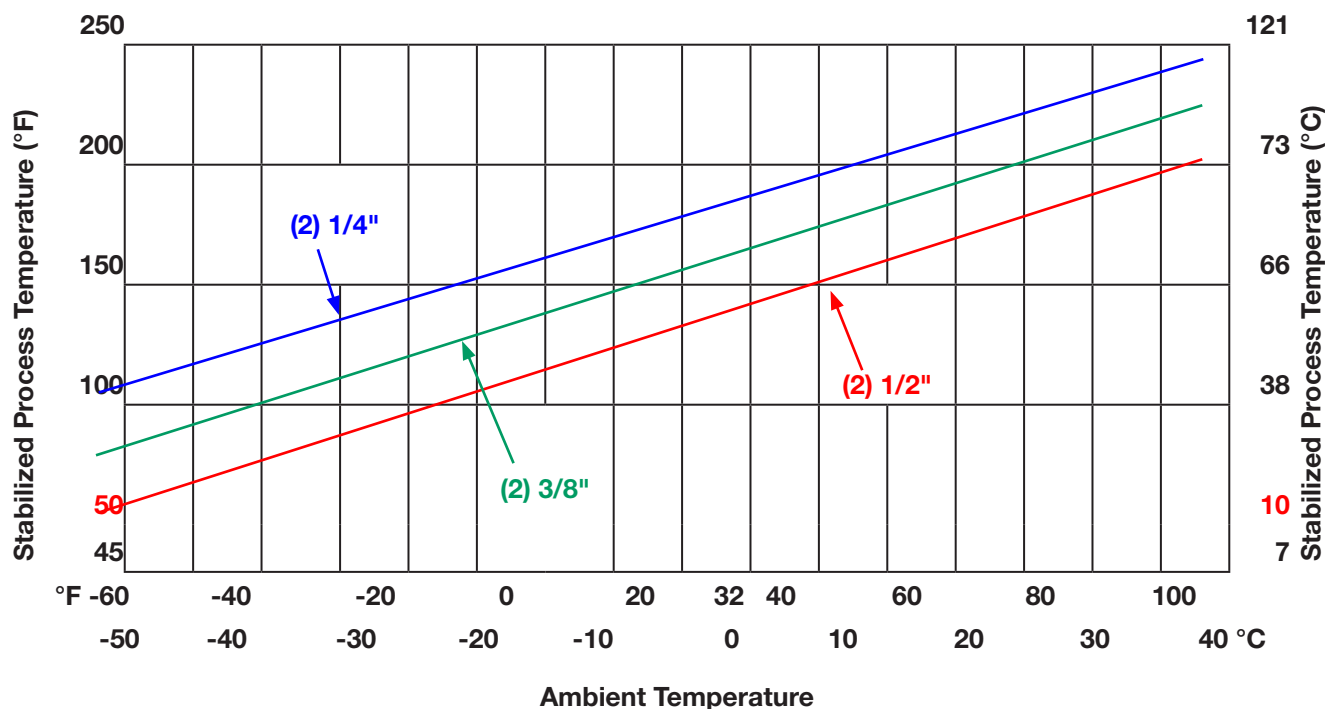

**CH Series Constant Watt Bundles**  
**Maximum Exposure 400°F (200°C)**  
**Process Tubes 1/4" to 1/2" O.D. (6mm to 12mm)**  
**Single or Dual Tube Designs**

Minimum Process Temperature to Maintain	Standard Insulation Package*				
	Environments Average High / Low Ambient Conditions				
	Extreme Cold	Cold	Moderate Cold	Moderate	Warm
	-65°F Low 80°F High	-40°F Low 80°F High	-10°F Low 95°F High	0°F Low 105°F High	10°F Low 115°F High
<b>120 Volts</b>	-54°C Low 26°C High	-40°C Low 26°C High	-24°C Low 35°C High	-18°C Low 40°C High	-13°C Low 46°C High
250°F (4°C)	18 Watt / Ft	18 Watt / Ft	18 Watt / Ft	12 Watt / Ft	12 Watt / Ft
275°F (10°C)	18 Watt / Ft	18 Watt / Ft	18 Watt / Ft	18 Watt / Ft	12 Watt / Ft
300°F (24°C)	18 Watt / Ft	18 Watt / Ft	18 Watt / Ft	18 Watt / Ft	18 Watt / Ft
325°F (38°C)	18 Watt / Ft	18 Watt / Ft	18 Watt / Ft	18 Watt / Ft	18 Watt / Ft
350°F (52°C)		18 Watt / Ft	18 Watt / Ft	18 Watt / Ft	18 Watt / Ft
375°F (66°C)			18 Watt / Ft	18 Watt / Ft	18 Watt / Ft
400°F (79°C)				18 Watt / Ft	18 Watt / Ft
<b>208 Volts</b>					
250°F (4°C)	18 Watt / Ft	18 Watt / Ft	12 Watt / Ft	12 Watt / Ft	12 Watt / Ft
275°F (10°C)	18 Watt / Ft	18 Watt / Ft	18 Watt / Ft	18 Watt / Ft	12 Watt / Ft
300°F (24°C)	18 Watt / Ft	18 Watt / Ft	18 Watt / Ft	18 Watt / Ft	18 Watt / Ft
325°F (38°C)	18 Watt / Ft	18 Watt / Ft	18 Watt / Ft	18 Watt / Ft	18 Watt / Ft
350°F (52°C)		18 Watt / Ft	18 Watt / Ft	18 Watt / Ft	18 Watt / Ft
375°F (66°C)			18 Watt / Ft	18 Watt / Ft	18 Watt / Ft
400°F (79°C)				18 Watt / Ft	18 Watt / Ft
<b>240 Volts</b>					
250°F (4°C)	18 Watt / Ft	18 Watt / Ft	12 Watt / Ft	12 Watt / Ft	12 Watt / Ft
275°F (10°C)	18 Watt / Ft	18 Watt / Ft	18 Watt / Ft	18 Watt / Ft	12 Watt / Ft
300°F (24°C)	18 Watt / Ft	18 Watt / Ft	18 Watt / Ft	18 Watt / Ft	18 Watt / Ft
325°F (38°C)	18 Watt / Ft	18 Watt / Ft	18 Watt / Ft	18 Watt / Ft	18 Watt / Ft
350°F (52°C)		18 Watt / Ft	18 Watt / Ft	18 Watt / Ft	18 Watt / Ft
375°F (66°C)			18 Watt / Ft	18 Watt / Ft	18 Watt / Ft
400°F (79°C)				18 Watt / Ft	18 Watt / Ft

\*The above heater selection is based upon our standard insulation package. Other insulation packages are available upon request. All CH series products should be installed with temperature sensor and over temperature protection devices to prevent overheating.

**How to Use:**

- 1) Check to be sure you are using the correct chart.
- 2) Choose your operating voltage.
- 3) Choose the minimum process temperature you want to maintain.  
 Note: If temperature is not shown, pick the next higher option.
- 4) Follow chart across to the ambient Condition that best match your area.
- 5) Use the watt-density shown for your part number derivation.

**Note:**

The watt-density selected will maintain the temperature indicated at a minimum. Depending upon actual ambient fluctuations, process tubes size and number of tubes, the maintenance temperature could be higher.

## MI - Mineral Insulated Electric Trace Tubing for High Temperature Maintenance

Maintain Temperatures up to 900°F (482°C) and withstand Maximum Internal Exposure of 1000°F (538°C)



### General

Parflex MI-Mineral Insulated electric trace tubing consists of a single process tube electrically traced with a series resistance, mineral-insulated heating cable; a heat transfer foil wrap; nonhygroscopic glass fiber insulation; and a black, 105°C-rated, flame-resistant PVC (FR-PVC) jacket.

Parflex Mineral Insulated tubing is designed for various temperature ranges including:

- Freeze protection and viscosity maintenance from 40°F (4.4°C) to 80°F (26.7°C) at ambient temperatures down to -60°F (-51.1°C)
- Process temperature maintenance from 120°F (48.9°C) to 170°F (76.7°C) at -60°F (-51.1°C)
- Process temperature maintenance from 260°F (126.7°C) to 310°F (154.4°C) at 80°F (26.7°C).

Standard product has a Maximum Temperature Rating (MTR\*) of 400°F (204.4°C). Higher temperature rated designs are available (up to 900°F). Consult the Division for details.

\*Maximum Temperature Rating is the maximum allowable temperature of the tracing fluid. Temperatures in excess of this may damage the product or alter its performance.

Parflex Multitube® Mineral Insulated electric trace tubing is a made-to-length product and should not be cut in the field.

### Applications

Analyzer, impulse and instrument lines; small diameter process lines; stack gas sampling lines; and utility lines.

### Tubing

Type 122 DHP Seamless Copper and 316/316L Welded and Seamless Stainless Steel are standard. Additional materials and wall thicknesses are available upon request. For Material Specifications of metal tubing, see *Technical Data* section of the catalog. Consult Division for details.

### Heat Transfer Foil

An aluminum heat transfer foil allows for even heat distribution for precise temperature control.

### Insulation

Air-spaced, cross wrapped applied non-hygroscopic fiberglass thermal insulation or a high temperature composite dual insulation system provides minimum heat loss.

### Jacket

The tough, black, 105°C-rated, flame-resistant PVC (FR-PVC) jacket protects the tubing against corrosive atmospheres, water, oils, acids, alkalies and most chemicals. Additional jacket materials are available upon request. For Material Specifications of jackets, see *Technical Data* section of the catalog. Consult Division for additional details.

### Testing

Each tube in every length of Parflex Mineral Insulated electric trace tubing is pressure tested prior to shipment to assure the instrument engineer a high-quality, reliable, trouble-free product. For Testing Specifications, see *Technical Data* section of the catalog.

### Accessories

Accessories are available for electrical connections, bundle splicing and end terminations. Consult the factory for accessories for mineral insulated bundles.

**Ordering:** See the following page for information about how to specify and order.

**NOTE:** It is absolutely necessary to seal the ends against contamination from moisture and/or corrosive liquids. Parker Hannifin cannot assume any liability for product damage caused by moisture from unsealed ends.

Electrical Specifications	
Heater Type	Series resistance, order to length
Operating Voltage	120/208/240 VAC
MI Cable Construction	Alloy 825 outer sheath, nickel clad copper bus wires, magnesium oxide insulation and nichrome heating element

Maximum Exposure Temperature (heater cable only)	
Power Off	1200°F (650°C)
Power On	1000°F (538°C)

30 watts/ft load

For recommended temperature controller, see 4012-01145 (G.P. areas) and 4012-01147 (Hazardous locations)

### Area Classification

General purpose, Class I, Division 2, Groups A, B, C and D.

### Ground Fault Equipment Protection Devices (GFEPDs):

The IEEE standard (515-1989) for heating cables requires the use of GFEPDs with a nominal 30 milliampere trip level for “piping systems in classified areas, those areas requiring a high degree of maintenance, or which may be exposed to physical abuse or corrosive atmospheres.”

### Approvals:

FM – Factory Mutual Approved  
 Ordinary Locations  
 Hazardous (Classified) Locations

Class I, Division 2, Groups B, C and D  
 Class II, Division 2, Groups F and G  
 Class III, Division 1 and 2

## How to Specify & Order

### M—Mineral Insulated Electric Trace Bundles

Maintain Temperatures up to 900°F (482°C) with High Temperature Exposure up to 1000°F (538°C)

**M - 30 1 2 - B 08 49 B - V B - 125**

<b>M</b>	<b>Bundle Type</b>	<b>30</b>	<b>Heating Cable (Watts/ft)</b>	<b>1</b>	<b>Heating Cable Voltage</b>	<b>2</b>	<b>Area Classification</b>	<b>B</b>	<b>Process Tube Material</b>
	M= Mineral Insulated		Mfg. to determine watts based upon customer supplied criteria		1= 120VAC 2= 240VAC 8= 208VAC 7= 277VAC		2= General Purpose & FM Class I, Div.2 Areas		1= Smls Copper Type DHP Alloy No 122. ASTM B68/B75 2= Welded Stainless Steel Type 316/316L ASTM A269 3= Welded Stainless Steel Type 304 ASTM A269 B= Smls 316/316L ASTM A269 C= Smls 304 ASTM A269 D= Smls Monel Type 400 E= Smls Hastelloy C22 H= Smls 316H ASTM A213 I = Smls Incoloy 825 L= Electropolish Smls 316/316L ASTM A269 (10Ra) M= Smls 316/316L ASTM A213 S= Silco Smls 316/316L ASTM A269 P= PFA Fluoropolymer F= FEP Fluoropolymer T= TFE Fluoropolymer 7= Parflex 919 PTFE SS Braided Hose 9= Customer Specified Tube Material
			The Design Criteria Required is:						
			Maintain Temperature						
			Ambient Conditions (Low/High)						
			Max. Bundle Internal Exposure Temperature						

<b>08</b>	<b>Process Tube Size</b>	<b>49</b>	<b>Process Tube Size</b>	<b>B</b>	<b>Number of Process Tubes</b>	<b>V</b>	<b>Jacket Material</b>	<b>B</b>	<b>Jacket Color</b>	<b>125</b>	<b>Installed Run Length Required</b>
	O.D.		Wall Thickness		A= 1 Tube B= 2 Tubes C= 3 Tubes etc.		V = FR-PVC T = FR-TPE U = FR-PUR P = PUR R = TPR E = FRPE L = LDPE F = PVDF		N=Black B=Blue G=Green O=Orange Y=Yellow P=Purple R=Red W=White		=-XXX (Length in feet)
	See Selection Charts		See Selection Charts		P= 2 Tube Parallel Design		Note: Parflex standard jacket material is FR-PVC		Note: Parflex standard color jacket is black		
	Imperial		Imperial								
	02=1/8" 03=3/16" 04=1/4" 05=5/16" 06=3/8" 07=7/16" 08=1/2" 10=5/8" 12=3/4" 16=1"		16=.016" 20=.020" 28=.028" 30=.030 31=.031" 32=.032" 35=.035" 40=.040" 47=.047" 49=.049" 50=.050" 62=.062" 65=.065" 83=.083"								
	Metric		Metric								
	MA=2mm MB=4mm MC=6mm MD=8mm ME=10mm MF=12mm MG=14mm MH=16mm		89=.89mm 10=1.0mm 15=1.5mm 20=2.0mm 25=2.5mm								



## 4031-0001 Electrical Connection Kit for CL and 4031-0001B Electrical Connection Kit for CH Series Constant Wattage Temptrace™



### Each Kit contains:

- |                                    |   |
|------------------------------------|---|
| 1 Connection Box                   | 1 Bracket Assembly                      |
| 1 Connection Box Gasket            | 2 Connector unions                      |
| 1 Connection Box Cover             | 2 Heating cable grommets                |
| 1 Mounting Bracket                 | 2 Plastic cable ties                    |
| 1 3/4" Locknut                     | 2 Non-insulated butt splice (12-10 AWG) |
| 1 3/4" Pipe Plug                   | 3 Non-insulated butt splice (16-14 AWG) |
| 1 "Electric Trace" caution sticker | 2 Heater termination boots              |
| 1 2.8 oz Black RTV Sealant         | 1 Roll 3/4" wide temperature tape       |

**Description:** Parker electrical connection kits are universal, all-in-one connection kits for making the electrical connections (input power, splice, input power splice, and termination) for Parflex electric trace tubing bundles. The kits contain all the necessary components and hardware to make one input connection, one splice connection or one input power splice connection, as well as, two termination connections. The connection kits are designed for use in ordinary locations and Class I, Division 2, Groups B, C, and D; Class II, Division 2, Groups F and G; Class III, Divisions 1 and 2 hazardous locations.

### Approvals:

FM – Factory Mutual Approved  
Ordinary Locations  
Hazardous (Classified) Locations

Class I, Division 2, Groups B, C and D  
Class II, Division 2, Groups F and G  
Class III, Division 1 and 2

### Ground Fault Equipment Protection Devices (GFEPDs):

The IEEE standard (515-1989) for heating cables requires the use of GFEPDs with a nominal 30 milliampere trip level for “piping systems in classified areas, those areas requiring a high degree of maintenance, or which may be exposed to physical abuse or corrosive atmospheres.”



**Assembled Input Power and Splice Connection Kit**



**Assembled Input Power Connection Kit**



**Assembled Termination Connection Kit**

## Constant Wattage Products Accessory Selections

Product Family	Series	Accessory P/N	Description
Constant Wattage Temptrace™	CL & CH	4031-0001	Electrical Input Power / End Termination Kit
		4031-0001B	Electrical Input Power / End Termination Kit
		4012-01145	Line sensing general purpose area NEMA 4X temperature controller
		4012-01147	Line sensing hazardous location NEMA 7 temperature controller
		RTV-103BLK	End Sealant, 2.8 oz. tube, 400°F
		RTV-103BLK10.3	End Sealant, 10.1 oz. cartridge, 400°F
		RTV-106RED	End Sealant, 2.8 oz. tube, 500°F
		ESB	End Seal Boot, 400°F molded silicone
		SK-612	Splice or fitting / valve end termination kit (Insulation dimensions - 6" x 12")
		SK-630	Splice or fitting / valve end termination kit (Insulation dimensions - 6" x 30")
		SK-696	Splice or fitting / valve end termination kit (Insulation dimensions - 6" x 96")
		PTFT1.45	Parflex Temptrace™ Feed Through seal kit (.79" - 1.45")
		PTFT2.42	Parflex Temptrace™ Feed Through seal kit (1.45" - 2.42")

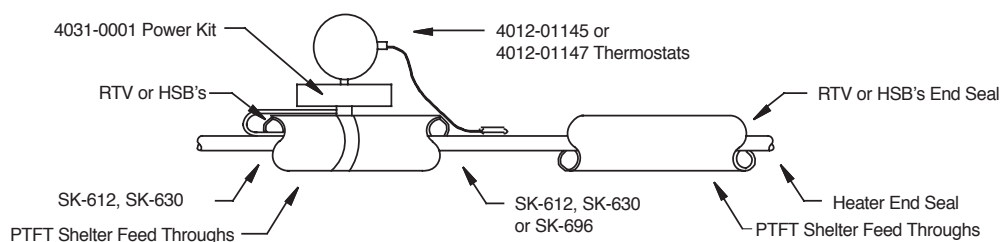

Constant Wattage Electric CL and CH Series

## Specifications Conformance

### Electric Trace Tubing Products

Parflex Multitube® Temptrace™ electric trace products conform to *Articles 427 and 500 of the National Electric Code*. Article 427 is entitled, "Fixed Electric Heating Equipment for Pipelines and Vessels." Article 500 is entitled, "Hazardous (classified) Locations," and contains definitions of specific occupancies by Class, Division and Group Location.

Parflex Multitube® Temptrace™ electric trace products also conform to IEEE Standard 515 entitled, "IEEE Recommended Practice for the Testing, Design, Installation and Maintenance of Electrical Resistance Heat Tracing for Industrial Applications."

### Ground Fault Equipment Protection Devices (GFEPDs):

The IEEE standard (515-1989) for heating cables requires the use of GFEPDs with a nominal 30 milliamper trip level for "piping systems in classified areas, those areas requiring a high degree of maintenance, or which may be exposed to physical abuse or corrosive atmospheres."

## Parflex Electric Trace Design Criteria Quote Request

Fax Inquiry To: Sales Office  
330-296-6747

Date: \_\_\_\_\_ Customer Name: \_\_\_\_\_

Bundle Type: CL Temptrace™  (Low Temperature Maintenance up to 250° F (121°C))  
 CH Temptrace™  (High Temperature Maintenance up to 400° F (204° C))  
 MI Temptrace™  (High Temperature Maintenance over 1000° F (538° C))

Total Quantity: \_\_\_\_\_ Feet   
 \_\_\_\_\_ Meters

Specified Lengths: \_\_\_\_\_  
 \_\_\_\_\_

Part Number: \_\_\_\_\_ (See How-to-Order in applicable product section.)

*If not sure of part number, complete the following criteria:*

Maximum Temperature to be maintained: \_\_\_\_\_° ( )

Lowest ambient temperature: \_\_\_\_\_° ( )

Highest ambient temperature: \_\_\_\_\_° ( )

What is the maximum internal process tube or steam purge temperature? \_\_\_\_\_° ( )

**Process Tubes:**

How many process tubes: \_\_\_\_\_  
 Size: (O.D. and wall thickness): \_\_\_\_\_ Inches   
 \_\_\_\_\_ mm   
 Tube Material: \_\_\_\_\_

**Trace Tube:**

Size: (O.D. and wall thickness): \_\_\_\_\_ Inches   
 \_\_\_\_\_ mm   
 Tube Material: \_\_\_\_\_

Outer Jacket Type: (Note: Black FR-PVC is Standard)

FR-PVC  TPR   
 FR-TPE  FRPE   
 FR-PUR  LDPE   
 PUR  PVDF

Area Classification

General Purpose   
 Class 1, Division 2   
 Class 1, Division 1

Approval Agency

FM  CSA  ATEX



## Analyzer Bundles for Process Monitoring and Probe Control

### General Heated Bundle Design

Heated CEMS products normally consist of two sections within the umbilical: the heated core and the unheated probe support section.

In some cases, customers will choose to have these two sections broken down into separate umbilicals; however, to reduce installation cost and time, all components can be included in one control umbilical.

#### Heated Core:

Typically, the heated core consists of two or three tubes: sample tubes, calibration tubes and possibly a spare. These tubes can be color coded for ease of identification.

Within the heated core, a heating element will be positioned to ensure the most consistent and uniform heat transfer between all lines. The product can also be designed to include a temperature sensor device. The most common devices used are 100 Ohm RTD's or Thermocouples.

Temperature sensors are placed at points along the heated core that allow for uniform heat control under various ambient and process conditions.

#### Unheated Core Probe Support Section:

The unheated section of the umbilical is at a temperature interface outside the heated core that allows for placement of probe support wires and unheated air lines and calibration lines.

Electrical probe support wires and fiber-optic cables can be included within the unheated area to offer a completed assembly.

Products are designed to customer application specifications and can include any number and combination of tubing materials and electrical wire controls.

We have outlined a special design questionnaire specifically tailored to assist you with designing a product that will meet your needs. (See Page 57)

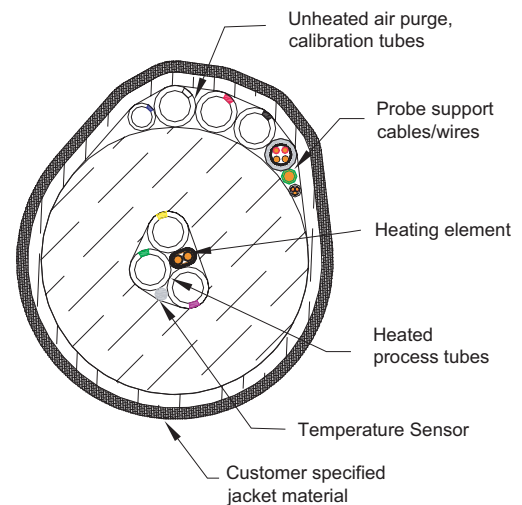

### General Probe Support Bundle Design

Parflex Division is also a leading manufacturer of probe support umbilicals. These Multitube® bundles are made to the customers design requirements, with unheated tubes, electrical wires and probe temperature sensor wires, such as thermocouple extension cables.

Probe support umbilicals can consist of any combination of tubes and sizes. The tubes will be uniquely identified for quick and accurate field connection. In many cases, probe support bundles will not see extreme heat, therefore more economical electrical wire material can be used, such as THHN cables or conductors.

Any of Parflex Division's umbilicals can be jacketed with the customer's specified material, including FR-TPE, FR-PVC and Urethane materials. (See the technical data section for jacket selection)

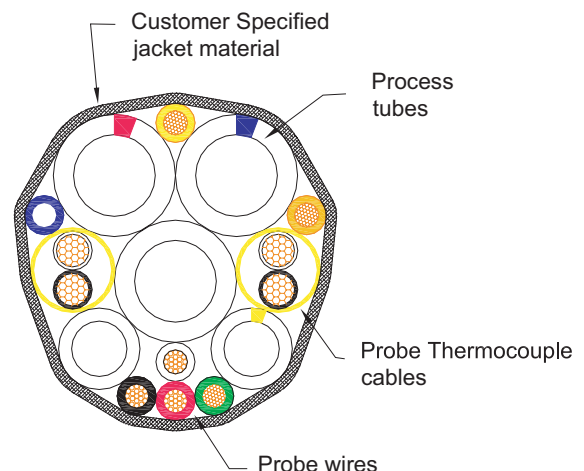

## Analyzer & Process Control Umbilical Design Form

Individual Run Length:		Total Quantity Required:
_____ft	_____ft	_____ft
_____ft	_____ft	_____ft
_____ft	_____ft	_____ft

- Application (Check )      Non-Heated:
- Freeze Protection:  (Default: Maintain 40°F at -40°F)
- Temperature Maintenance:

- 1) If heated, what temperature is to be maintained within heated core? \_\_\_\_\_ °F °C
- 2) What is the minimum ambient temperature? \_\_\_\_\_ °F °C
- 3) What is the maximum exposure temperature of the heated core? \_\_\_\_\_ °F °C
- 4) What operating voltage is being used? \_\_\_\_\_ VAC
- 5) What breaker size is being used? \_\_\_\_\_ Amp
- 6) Do you have a heater preference? (SR, Constant Watt, VPL or MI) \_\_\_\_\_  
 If not, Parker can recommend a heater based upon design criteria
- 7) Area Classification: Ordinary C1D2 Zone 2 Required T Rating \_\_\_\_\_
- 8) Approval Agency: FM CSA CE ATEX

**Heated Tube** -- Core Questions

- 1) Provide the number of **heated** tubes, size and material required.  
 Number of Tubes: \_\_\_\_\_ Size \_\_\_\_\_ Material \_\_\_\_\_ Colors \_\_\_\_\_  
 Number of Tubes: \_\_\_\_\_ Size \_\_\_\_\_ Material \_\_\_\_\_ Colors \_\_\_\_\_  
 Number of Tubes: \_\_\_\_\_ Size \_\_\_\_\_ Material \_\_\_\_\_ Colors \_\_\_\_\_
- 2) What type sensor do you want in the umbilical? RTD or Thermocouple  
 Where is sensor to be positioned? \_\_\_\_\_ feet from: Analyzer End or Probe End

**Unheated Layer** -- Material Questions

- 1) What is the maximum exposure temperature of unheated elements? \_\_\_\_\_ °F °C
- 2) Provide the number of **unheated** tubes, size and material required.  
 Number of Tubes: \_\_\_\_\_ Size \_\_\_\_\_ Material \_\_\_\_\_ Colors \_\_\_\_\_  
 Number of Tubes: \_\_\_\_\_ Size \_\_\_\_\_ Material \_\_\_\_\_ Colors \_\_\_\_\_  
 Number of Tubes: \_\_\_\_\_ Size \_\_\_\_\_ Material \_\_\_\_\_ Colors \_\_\_\_\_
- 3) Do you need probe support or other electrical wires in umbilical?  
 Number of Wires: \_\_\_\_\_ Size \_\_\_\_\_ Material \_\_\_\_\_ Colors \_\_\_\_\_  
 Number of Wires: \_\_\_\_\_ Size \_\_\_\_\_ Material \_\_\_\_\_ Colors \_\_\_\_\_
- 4) What type of outer jacket is requested? (Black FR-PVC is standard) \_\_\_\_\_



## Section 4

## Metal and Plastic Multitube® Bundles

**General Design:**

Parflex Division Multitube® Instrumentation tubing bundles are available in a variety of metal and plastic tubing materials.

Bundled tubing is an ideal alternative for applications where multiple lengths of tubing are currently being installed independently. Bundled tubing typically will save space within cabled trays, reduce the overall installation cost and offer protection to the individual tubes while being routed throughout a plant.

Multitube® bundles can be manufactured with or without protective, galvanized steel armor and a protective outer jacket.

Galvanized steel armor offers supreme mechanical protection for the tubes in areas of the plant where crush resistance is needed, as well as for direct burial applications.

**Tubing Identification:**

Plastic and metal tubes are uniquely identified using a number code printed along the entire length of each tube. Each tube is uniquely numbered, making connections fast and accurate during installation.

Color-coding of tubes is also available upon special request.

**Jacket Material:**

Our standard jacketing material is a black, 105°C-rated, flame-resistant PVC. FR-PVC offers tough protection against corrosive environments, water, oils, acids and alkaline chemicals. Other jacketing materials are available upon request.

**Testing:**

Each tube in every length of bundle is pressure tested prior to shipment.

Metal tubes are pressure tested using dry N2 at 250psi for 5 minutes prior to shipment.

Plastic tubes are pressure tested using dry N2 at 125psi for 5 minutes.

Other testing and third party certifications are available upon request. Including ABS (American Bureau of Shipbuilding), DNV (Det Norske Veritas) and Lloyds. Contact the factory for details.

## How to Specify & Order Metal Tubing Bundles

4 MJ - 1 04 30 - U B

<b>4</b>	<b>MJ</b>	<b>1</b>
<b>No. of Tubes</b>	<b>Product Design</b>	<b>Tube Material</b>
1 = 1 Tube 2 = 2 Tube 3 = 3 Tube 4 = 4 Tube Etc...	MJ = Metal, Jacketed MA = Metal, Armored MAJ = Metal, Armor, Jacketed MJR = Metal, Jacketed, Round Cross-Section	1= Smls Copper Type DHP Alloy No 122. ASTM B68-B75 2= Welded Stainless Steel Type 316/316L ASTM A269 3= Welded Stainless Steel Type 304 ASTM A269 B= Smls 316/316L ASTM A269 C= Smls 304 ASTM A269 D= Monel Type 400 E= Hastelloy C22 H= Smls 316H ASTM A213 M= Smls 316/316L ASTM A213 9= Customer Specified Tube Material  All metal tubes are number coded along the length of the tube for identification

<b>04</b>	<b>30</b>	<b>U</b>	<b>B</b>
<b>Tube Size (O.D.)</b>	<b>Tube Size (Wall Thickness)</b>	<b>Jacket Material</b>	<b>Jacket Color</b>
02= 1/8" 03= 3/16" 04= 1/4" 05= 5/16" 06 = 3/8" 07 = 7/16" 08 = 1/2" 10 = 5/8" 12 = 3/4" 16 = 1  Metric MA = 2mm MB = 4mm MC = 6mm MD = 8mm ME = 10mm MF = 12mm	16=.016" 20=.020" 28=.028" 30=.030 31=.031" 32=.032" 35=.035" 40=.040" 47=.047" 49=.049" 50=.050" 62=.062" 65=.065" 83=.083"  Metric 89=.89mm 10=1.0mm 15=1.5mm 20=2.0mm 25=2.5mm	V = FR-PVC T = FR-TPE U = FR-PUR P = PUR R = TPR E = FRPE L = LDPE K = PVDF  Note: Parflex standard jacket material is FR-PVC  For standard FR-PVC black, the -VN may be dropped	N = Black B = Blue G = Green O = Orange Y = Yellow P = Purple R = Red W = White  Note: Parflex standard jacket color is black



**Pressure Ratings-Metal Tubes\***

Tubing Type	Tube Size (in.)		Tubing Pressure Rating (PSI) Versus Temperature											
			100°F		200°F		300°F		400°F		500°F		600°F	
	O.D.	Wall	Burst	Opr.	Burst	Opr.	Burst	Opr.	Burst	Opr.	Burst	Opr.	Burst	Opr.
Copper Type DHP, Alloy No. 122, Soft Annealed Bright Seamless ASTM B68 and B75	1/4	.030	7230	1450	6630	1330	5730	1150	3620	730	-	-	-	-
	3/8	.032	5040	1010	4620	930	3990	800	2520	510	-	-	-	-
	1/2	.035	4050	810	3710	750	3200	640	2020	410	-	-	-	-
	1/2	.049	5900	1180	5400	1080	4700	940	2950	590	-	-	-	-
Stainless Steel, Type 316 Welded per ASTM A-269	1/4	.035	20100	5025	20100	5025	18200	4550	16900	4225	16300	4075	15900	3975
	3/8	.035	12800	3200	12800	3200	11600	2900	10800	2700	10400	2600	10200	2550
	1/2	.035	9400	2350	9400	2350	8500	2125	7900	1975	7600	1900	7500	1875
	1/2	.049	13500	3375	13500	3375	12300	3075	11400	2850	10900	2725	10700	2675
Stainless Steel, Type 316 Seamless per ASTM A-269	1/4	.035	23650	5910	23645	5910	23300	5825	19880	4970	19180	4795	18700	4675
	3/8	.035	15060	3765	15060	3765	13640	3410	12700	3175	12240	3060	12000	3000
	1/2	.035	11060	2765	11060	2765	10000	2500	9300	2325	8940	2235	8820	2205
	1/2	.049	15880	3970	15880	3970	14480	3620	13420	3355	12820	3205	12580	3145

\*All values are nominal, Pressure data is taken from American National Standards Code: ANSI B31.1 B30-1993A Edition

**Single Metal Tubing Jacketed**

Product Series	Description	Part Number	Nominal Product O.D. (in.)	Standard Length (ft.)	Type of Package	Shipping Weight (lbs./100 ft.)	Minimum Bend Radius (in.)	Product Weight (lbs./100 ft.)
MJ - Metal Tube Jacketed	Copper Tubes: 1/4" O.D. x 0.030" Wall	1MJ-10430-50	0.32	50	Coil	5.4	2	9.7
		1MJ-10430-100		100	Coil	10.3		
		1MJ-10430-500		500	Coil	10.0		
		1MJ-10430-1000		1000	Coil	10.0		
	3/8" O.D. x 0.032" Wall	1MJ-10632-50	0.44	50	Coil	5.8	3	15.8
		1MJ-10632-100		100	Coil	16.8		
		1MJ-10632-500		500	Coil	16.3		
	1/2" O.D. x 0.035" Wall	1MJ-10835-50	0.57	50	Coil	6.3	4	23.0
		1MJ-10835-100		100	Coil	24.5		
		1MJ-10835-500		500	Reel	23.9		
		1MJ-10835-1000		1000	Reel	25.1		
	Welded Stainless Steel Tube 1/4" O.D. x 0.035" Wall	1MJ-20435-50	0.32	50	Coil	5.4	2	19.9
1MJ-20435-100		100		Coil	20.4			
1MJ-20435-500		500		Coil	20.2			
1MJ-20435-1000		1000		Coil	20.1			
3/8" O.D. x 0.035" Wall	1MJ-20635-50	0.44	50	Coil	5.8	3	24.5	
	1MJ-20635-100		100	Coil	25.4			
	1MJ-20635-500		500	Coil	24.9			
	1MJ-20635-1000		1000	Reel	24.9			
1/2" O.D. x 0.035" Wall	1MJ-20835-50	0.57	50	Coil	6.3	7	53.4	
	1MJ-20835-100		100	Coil	54.8			
	1MJ-20835-500		500	Reel	54.3			
	1MJ-0835-1000		1000	Reel	55.4			

**Multiple Metal Tube Bundles**

Product Series	Description	Part Number	Nominal Product O.D. (in.)	Jacket Thickness (in.)	Maximum Pulling Tension (lbs.)	Product Weight (lbs./100 ft.)	Minimum Bend Radius (in.)	Horizontal/ Vertical Support Centers (ft.)	
 <p><b>MJ - Metal Tube Jacketed</b></p>	Copper Tubes:	2MJ-10430	.64	.063	300	25	2.5	8	
		4MJ-10430	.74	.063	600	43	2.5	8	
	1/4" O.D. x 0.030" Wall	7MJ-10430	.89	.063	1050	70	3.5	12	
		8MJ-10430	.97	.063	1200	81	3.5	12	
		10MJ-10430	1.15	.063	1500	98	5.0	12	
		3/8" O.D. x 0.032" Wall	2MJ-10632	.89	.063	500	40	5.5	8
	4MJ-10632	1.05	.063	1000	70	6.5	8		
		2MJ-10835	1.15	.063	700	58	10.0	8	
	1/2" O.D. x 0.035" Wall	3MJ-10835	1.26	.080	1050	84	11.0	8	
		4MJ-10835	1.36	.080	1400	106	12.0	8	
	Welded Stainless Steel Tubes:	1/4" O.D. x .035" Wall	2MJ-20435	0.64	.063	500	23.2	3.8	8
			3MJ-20435	0.68	.063	750	31.8	4.0	8
			4MJ-20435	0.74	.063	1000	40.4	4.2	8
			5MJ-20435	0.82	.063	1250	49.5	4.5	8
			7MJ-20435	0.89	.063	1750	66.5	5.3	12
8MJ-20435			0.97	.063	2000	75.6	6.0	12	
10MJ-20435			1.15	.063	2500	93.9	7.5	12	
12MJ-20435	1.22	.080	3000	110.8	9.0	12			
 <p><b>MA - Metal Tube Armored</b></p>	Copper Tubes:	1MA-10430	.49	Not Applicable	150	23	2.5	8	
		1/4" O.D. x .030" Wall	2MA-10430		.74	300	44	2.5	8
			4MA-10430		.84	600	66	2.5	8
			7MA-10430		.99	1050	97	3.5	12
			8MA-10430		1.07	1200	111	3.5	12
	10MA-10430		1.25		1500	134	5.0	12	
	3/8" O.D. x .032" Wall	1MA-10632	.61		250	33	5.5	8	
		2MA-10632	.99		500	66	5.5	8	
		4MA-10632	1.15		1000	102	6.5	8	
		7MA-10632	1.37		1750	153	8.5	12	
		8MA-10632	1.49		2000	177	9.0	12	
	10MA-10632	1.75	2500		212	12.0	12		
	Welded Stainless Steel Tubes	1/4" O.D. x .035" Wall	1MA-20435		.49	250	22.7	6.0	8
			2MA-20435		.74	500	40.7	5.2	8
			4MA-20435		.84	1000	61.1	5.9	8
			7MA-20435		.99	1750	91.9	7.0	12
			8MA-20435		1.07	2000	103.5	7.5	12
	10MA-20435	1.25	2500		127.5	8.8	12		
 <p><b>MAJ - Metal Tube Armored &amp; Jacketed</b></p>	Copper Tubes:	1MAJ-10430	.56	.063	150	25	6.8	8	
		1/4" O.D. x .030" Wall	2MAJ-10430	.87	.063	300	55	2.5	8
			4MAJ-10430	.97	.063	600	78	2.5	8
			7MAJ-10430	1.12	.063	1050	111	3.5	12
			8MAJ-10430	1.20	.063	1200	126	3.5	12
	10MAJ-10430		1.37	.063	1500	151	5.0	12	
	3/8" O.D. x .032" Wall	1MAJ-10632	.67	.063	250	35.9	8.0	8	
		2MAJ-10632	1.12	.063	500	81	5.5	8	
		4MAJ-10632	1.28	.063	1000	119	6.5	8	
		7MAJ-10632	1.53	.078	1750	179	8.5	12	
		8MAJ-10632	1.65	.078	2000	202	9.0	12	
	10MAJ-10632	1.91	.078	2500	244	12.0	12		
	Welded Stainless Steel Tubes	1/4" O.D. x .035" Wall	1MAJ-20435	.56	.032	250	25.2	6.8	8
			2MAJ-20435	.87	.063	500	50.4	5.2	8
			4MAJ-20435	.97	.063	1000	72.0	5.9	8
			7MAJ-20435	1.12	.063	1750	104.7	7.0	12
			8MAJ-20435	1.20	.063	2000	117.0	7.5	12
	10MAJ-20435	1.37	.063	2500	143.5	8.8	12		

## How to Specify & Order Plastic Tubing Bundles



**4 PJ - E 04 40 - U B**

<b>4</b>	No. of Tubes	<b>PJ</b>	Product Design	<b>E</b>	Tube Material
	1 = 1 Tube 2 = 2 Tube 3 = 3 Tube 4 = 4 Tube Etc...		PJ = Polymer, Jacketed  PA = Polymer, Armored  PAJ = Polymer, Armor, Jacketed  PJH = Polymer, Jacketed Heavy 3/16"		E = Polyethylene H = High Density Polyethylene  R = FR-PE N = Nylon U = Urethane P = PFA Fluoropolymer F = FEP Fluoropolymer T = TFE Fluoropolymer  9 = Customer Specified Tube Material.  All Tubes are black and number coded, except Fluoropolymer tubes which are all natural.  Colored tubes are available upon special request

<b>04</b>	Tube Size (O.D.)	<b>40</b>	Tube Size (Wall Thickness)	<b>U</b>	Jacket Material	<b>B</b>	Jacket Color
	02 = 1/8" 03 = 3/16" 04 = 1/4" 05 = 5/16" 06 = 3/8" 07 = 7/16" 08 = 1/2" 10 = 5/8" 12 = 3/4" 16 = 1"  Metric  MA = 2mm MB = 4mm MC = 6mm MD = 8mm ME = 10mm MF = 12mm		16 = .016" 20 = .020" 28 = .028" 30 = .030" 31 = .031" 32 = .032" 35 = .035" 40 = .040" 47 = .047" 49 = .049" 50 = .050" 62 = .062" 65 = .065" 83 = .083"  Metric  89 = .89mm 10 = 1.0mm 15 = 1.5mm 20 = 2.0mm 25 = 2.5mm		V = FR-PVC T = FR-TPE U = FR-PUR P = PUR R = TPR E = FRPE L = LDPE K = PVDF  Note: Parflex standard jacket material is FR-PVC		N = Black B = Blue G = Green O = Orange Y = Yellow P = Purple R = Red W = White  Note: Parflex standard jacket color is black  For standard FR-PVC black -VN may be dropped

**Multiple Plastic Tube Bundles**

Product Series	Description	Part Number	Number of Tubes	Jacket Thickness (in.)	Nominal Product O.D. (in.)	Minimum Bend Radius (in.)	Maximum Pulling Tension (lbs.)	Product Weight (lbs./100 ft.)
PJ - Plastic Tube Jacketed 	Polyethylene Tubes: 1/4" O.D. x .040" Wall	2PJ-E0440	2	.045	.59	1.5	90	8.6
		3PJ-E0440	3	.045	.60	1.5	110	11.4
		4PJ-E0440	4	.063	.74	2.0	140	12.8
		5PJ-E0440	5	.063	.88	2.0	170	15.1
		7PJ-E0440	7	.063	.89	2.5	195	17.5
		8PJ-E0440	8	.063	.97	2.5	235	19.5
		10PJ-E0440	10	.063	1.14	3.0	260	22.8
		12PJ-E0440	12	.063	1.14	3.5	300	25.4
		14PJ-E0440	14	.063	1.25	4.0	340	28.8
		19PJ-E0440	19	.080	1.40	5.0	425	36.8
	37PJ-E0440	37	.080	1.96	9.0	880	74.5	
	Polyethylene Tubes: 3/8" O.D. x .062" Wall	2PJ-E0662	2	.063	.89	2.0	160	13.9
		3PJ-E0662	3	.063	.89	2.0	195	17.9
		4PJ-E0662	4	.063	1.05	2.5	265	21.1
		5PJ-E0662	5	.063	1.16	3.0	295	24.6
		7PJ-E0662	7	.080	1.31	4.0	365	29.7
		10PJ-E0662	10	.080	1.72	5.0	515	44.2
		12PJ-E0662	12	.080	1.80	6.0	685	60.8
		19PJ-E0662	19	.080	2.13	10.0	900	85.5

Product Series	Description	Part Number	Number of Tubes	Nominal Product O.D. (in.)	Minimum Bend Radius (in.)	Maximum Pulling Tension (lbs.)	Product Weight (lbs./100 ft.)	Horizontal/ Vertical Support Centers		
PA - Plastic Tube Armored 	Polyethylene Tubes: 1/4" O.D. x .040" Wall	2PA-E0440	2	.74	2.5	90	29	4		
		3PA-E0440	3	.78	2.5	110	32	4		
		7PA-E0440	7	.99	3.5	195	45	6		
		10PA-E0440	10	1.25	5.0	260	60	6		
		12PA-E0440	12	1.28	6.0	300	67	6		
		19PA-E0440	19	1.50	8.0	425	84	6		
		37PA-E0440	37	2.00	11.0	880	127	6		
	Polyethylene Tubes: 3/8" O.D. x .062" Wall	2PA-E0662	2	.99	5.5	160	43	4		
		3PA-E0662	3	1.05	6.0	195	48	4		
		10PA-E0662	10	1.75	12.0	515	101	6		
		12PA-E0662	12	1.81	12.5	685	109	6		
		19PA-E0662	19	2.13	15.0	900	141	6		
		PAJ - Plastic Tube Armored and Jacketed 	Polyethylene Tubes: 1/4" O.D. x .040" Wall	2PAJ-E0440	2	.87	2.5	90	39	4
				3PAJ-E0440	3	.90	2.5	110	42	4
7PAJ-E0440	7			1.12	3.5	195	58	6		
10PAJ-E0440	10			1.37	5.0	260	76	6		
12PAJ-E0440	12			1.44	6.0	300	88	6		
19PAJ-E0440	19		1.65	8.0	425	108	6			
37PAJ-E0440	37		2.16	11.0	880	159	6			
Polyethylene Tubes: 3/8" O.D. x .062" Wall	2PAJ-E0662		2	1.12	5.5	160	56	4		
	3PAJ-E0662	3	1.18	6.0	195	62	4			
	10PAJ-E0662	7	1.53	8.5	365	98	6			
12PAJ-E0662	10	1.91	12.0	515	129	6				
19PAJ-E0662	12	1.96	12.5	685	138	6				

Section 5

Parflex Multitube® Instrumentation Tubing Products  
Compatibility Chart

Ratings Code:

- G** – Good to excellent. Little or no swelling, tensile or surface changes. Preferred choice.
- L** – Marginal or conditional. Noticeable effects but not necessarily indicating lack of serviceability. Further testing suggested for specific application. Very long-term effects such as stiffening or potential for crazing should be evaluated.
- P** – Poor or unsatisfactory. Not recommended without extensive and realistic testing.
- – Indicates that this was not tested.

Materials Code for Parflex Multitube® Instrumentation Tubing Products

- E** Low Density Polyethylene
- HDPE** High Density Polyethylene
- N** Polymeric Flexible Nylon
- FRPE** Flame Resistant Polyethylene

Chemical	LDPE	HDPE	N	FRPE
Acetone	P	L	G	L
Acetyl Bromide	L	L	P	-
Acetyl Chloride	L	L	P	-
Air	G	G	G	G
Alcohols	G	G	G	G
Aluminum Salts	G	G	G	G
Ammonia	G	G	G	L
Amyl Acetate	G	G	G	-
Aniline	L	G	P	-
Animal Oils (3)	P	L	G	-
Arsenic Salts	G	G	G	G
Aromatic Hydrocarbons	P	L	G	P
Barium Salts	G	G	G	G
Benzaldehyde	P	L	L	P
Benzene	P	L	G	P
Benzyl Alcohol	P	G	L	P
Bleaching Liquors	G	L	L	-
Boric Acid Solutions	G	G	G	G
Bromine	L	L	P	-
Butane (1)	L	G	G	-
Butanol	G	G	G	G
Butyl Acetate	G	G	G	G
Calcium Hypochlorite	L	L	P	L
Calcium Salts	G	G	G	G
Carbon Dioxide	G	G	G	G
Carbon Disulfide	L	L	L	-
Carbon Tetrachloride	P	P	L	P
Caustic Potash	G	G	G	-
Caustic Soda	G	G	G	-
Chloroacetic Acid	L	G	L	-
Chlorine (Dry)	L	L	P	-
Chlorine (Wet)	L	L	P	-
Chlorobenzene				
Chloroform	P	L	P	P
Chromic Acid	L	L	P	-
Copper Salts	G	G	G	G
Cresol	P	L	P	P
Cyclohexanone	L	L	L	-
Ethers	L	L	G	-
Ethyl Acetate	G	G	G	-
Ethyl Alcohol	G	G	L	G
Ethylamine	L	G	L	-
Ethyl Bromide	P	L	L	P
Ethyl Chloride	P	L	L	P
Fatty Acids	L	L	G	P
Ferric Salts	G	G	G	-
Formaldehyde	G	G	L	-
Formic Acid	G	G	P	G
Freon	L	L	G	-
Gasoline (1)	P	G	G	P
Glucose	G	G	G	G

Chemical	LDPE	HDPE	N	FRPE
Glycerin	G	G	G	G
Hydriodic Acid	L	G	P	-
Hydrochloric Acid. (Conc.)	L	G	L	-
Hydrochloric Acid. (Med. Conc.)	L	G	L	-
Hydrofluoric Acid	L	L	P	-
Hydrogen Peroxide (Conc)	L	G	L	-
Hydrogen Peroxide (Dil.)	L	G	G	-
Hydrogen Sulfide	G	G	G	-
Iodine	L	G	G	-
Kerosene (1)	L	L	G	-
Ketones	G	G	G	-
Lacquer Solvents	L	L	G	-
Lactic Acid	G	G	G	-
lead Acetate	G	G	G	-
Linseed Oil	L	G	G	-
Magnesium Salts	G	G	G	-
Naphtha	L	L	G	G
Natural Gas	L	L	G	-
Nickel Salts	G	G	G	-
Nitric Acid (Conc.)	P	L	P	G
Nitric Acid (Dil.)	P	G	L	P
Nitrobenzene	P	L	L	P
Nitrogen Oxides	L	L	L	-
Nitrous Acid	L	L	L	-
Oils (Animal and Mineral)	L	L	G	-
Oils (Vegetable)	L	L	G	-
Oxygen (2) (3)	G	G	G	G
Perchloric Acid	P	G	P	P
Phenols	P	G	P	P
Potassium Salts	G	G	G	G
Pyridine	L	L	L	-
Silver Nitrate	G	G	G	G
Soap Solutions	G	G	G	G
Sodium Salts	G	G	G	G
Stearic Acid	L	L	G	-
Sulfur Chloride	L	L	L	-
Sulfuric Acid (Conc.)	P	G	P	P
Sulfuric Acid (Dil.)	P	G	L	P
Sulfurous Acid	P	G	L	P
Tannic Acid	G	G	G	-
Tanning Extracts	G	G	G	-
Titanium Salts	G	G	G	G
Toluene	P	L	G	P
Trichloroacetic Acid	L	L	P	-
Trichloroethylene	P	L	L	P
Turpentine	P	P	G	-
Urea	G	G	G	-
Uric Acid	G	G	G	-
Water (3)	G	G	G	G
Xylene	P	L	G	P
Zinc Chloride	G	G	G	-

**Footnotes for Fluid Compatibility Guides:** The Fluid Compatibility Guides are simplified rating tabulations based on immersion tests at 75° F. Higher temperatures tend to reduce ratings. **Since final selection depends on pressure, fluid and ambient temperature and other factors not known to Parker Hannifin Co., no performance guarantee is expressed or implied.** Ratings do not imply compliance with specialized codes such as FDA, NSF, AGA or UL and do not cover possible fluid discoloration, taste or odor effects. For conveying foodstuffs use FDA sanctioned materials, and for potable water use NSF listed materials. For chemicals not listed, or for advice on particular applications, please consult Product Engineering, Parflex Div., Ravenna, Ohio. (1) Applications for these fluids must take into account legal and insurance regulations. This **does not** imply AGA or UL compliance. (2) Chemical compatibility does not imply low permeation rates. Consult the Parker factory for a recommendation for your specific requirement. (3) Does not imply NSF or FDA compliance.



## Polyethylene Tubing

### Series E: Instrument Grade—FDA, NSF Listed

#### Series EB: Ultraviolet Light Resistant

- Chemical Resistant
- Flexible
- Choice of Reel Lengths
- Low Cost
- Five Tube Sizes
- Ten Colors

Parflex Division flexible polyethylene thermoplastic tubing is extruded from high molecular weight resin for increased dimensional stability, uniformity and long-term strength. Its resistance to environmental stress cracking greatly exceeds that of ordinary polyethylene tubing as measured by ASTM D-1693 (10% IGEPAL).

Parflex E series polyethylene tubing is available in black, as well as nine coding colors, as recommended by the Instrument Society of America. Black (EB) tubing contains an ultraviolet inhibitor which is recommended for use in sunlit areas and in close proximity to high ultraviolet light sources. Ingredients of E series natural and colored tubing (except EB series) meet FDA and NSF 51/61 requirements for food contact applications. Black polyethylene FDA and NSF 51/61 tubing is available upon special request. All tubing conforms to ASTM D-1248, Type I, Class A, Category 4, Grade E5. Suggested operating temperature range is -80°F (-62°C) to +150°F (+66°C).

## Polyethylene Tubing (cont)

### Series FRPE: Flame-Resistant

Flame-resistant polyethylene is manufactured from a distinctively formulated compound which meets the UL94 V-2 flame classification. It also meets the flame spread, fuel contribution and smoke density requirements of the ASTM E84-81a tunnel test. Parflex Series FRPE tubing is the preferred product for pneumatic control applications in the heating, ventilating, air conditioning, energy conservation industry. It is also suitable for use in petrochemical plants, petroleum refineries, pulp and paper mills, mines, steel mills and other industries where protection against intermittent flame and hot sparks is necessary.

Suggested operating temperature range is -85°F (-65°C) to +150°F (+66°C).

### Series HDPE: High Density

Parflex Division Series HDPE is manufactured from high strength, high density polyethylene. This semirigid tubing is inherently resistant to most chemicals, less easily cut or damaged and has a higher burst pressure rating than series E tubing. Suggested operating temperature range is -80°F (-62°C) to +175°F (+80°C).

## Nylon Tubing

### Series N: Flexible

Parflex Division flexible nylon tubing is carefully made from high-grade, abrasion resistant, heat and light stabilized nylon. Resistance to stress cracking greatly exceeds that of ordinary nylon tubing. Parflex nylon also exhibits extremely low level water absorption.

Chemical-resistant Parflex nylon tubing has the additional benefits of better flexibility, lighter weight and resistance to flexural fatigue. NN and NB tubing meets UL94HB flame resistance ratings in wall thicknesses of .033" and greater. Operating temperatures, depending upon conditions, are -65°F (-54°C) to +200°F (+93°C) continuous.

Available in natural (NN), red (RED), green (GRN), blue (BLU), yellow (YEL), and black (NB). Black tubing is recommended for use outdoors and in sunlit areas.

### Burst Pressure/Temperature Charts

#### Polyethylene Tubing

Laboratory Grade E Series  
1/4 through 5/8 O. D. inches

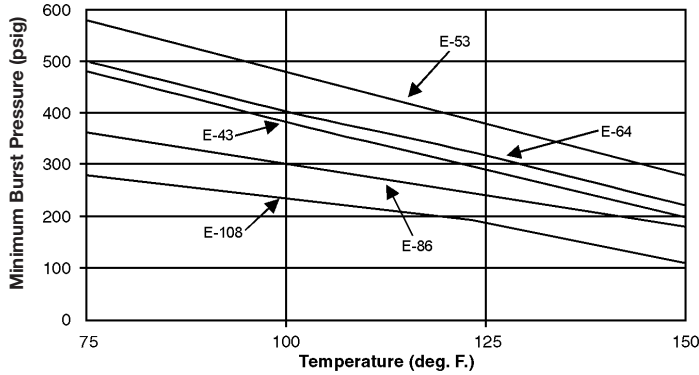

#### Nylon Flexible Tubing

N Series (NN, NB)  
1/8 through 1/2 O. D. inches

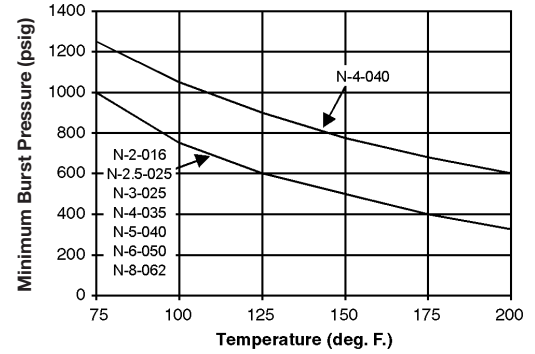

#### Polyethylene Tubing

High Density HDPE Series  
1/4 through 5/8 O. D. inches

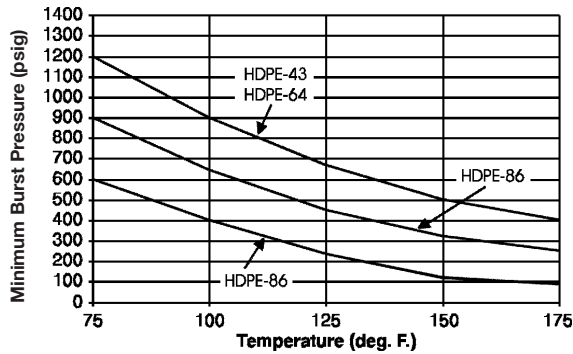

#### Nylon Flexible Tubing

N Series  
1/8 through 1/2 O. D. inches

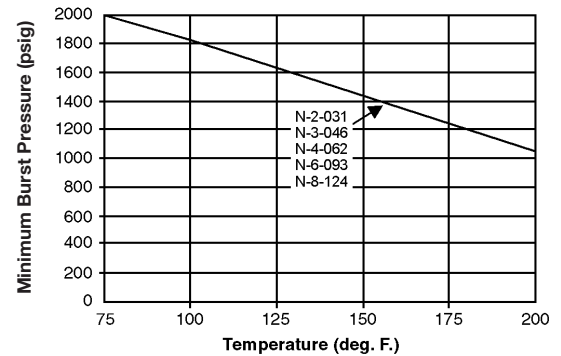

#### Polyethylene Tubing

Flame Resistant FRPE Series  
5/32 through 1/2 O. D. inches

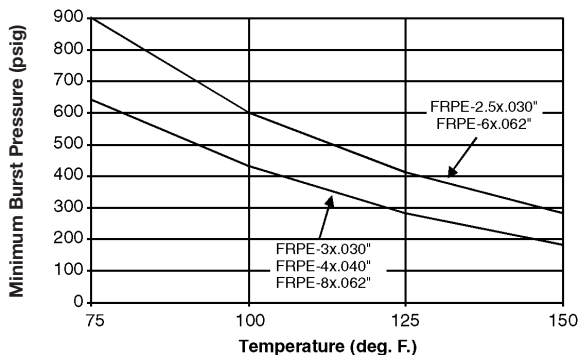

Suggested working pressures of nylon are 1/4 of burst pressure at system operating temperature.

Suggested working pressures of polyethylene are 1/4 of burst pressure at system operating temperature.



## Parflex Multitube® Instrumentation Tubing Products Compatibility Chart

### Ratings Code:

- G** – Good to excellent. Little or no swelling, tensile or surface changes. Preferred choice.
- L** – Marginal or conditional. Noticeable effects but not necessarily indicating lack of serviceability. Further testing suggested for specific application. Very long-term effects such as stiffening or potential for crazing should be evaluated.
- P** – Poor or unsatisfactory. Not recommended without extensive and realistic testing.
- – Indicates that this was not tested.

### Materials Code for Parflex Multitube® Instrumentation Tubing Products

Copper	Copper Type DHP, Alloy No. 122, Soft Annealed Bright Seamless ATM B68 and B75
316SS	Stainless Steel, Type 316 Welded and Seamless per ASTM A-269
Hastelloy	Type C-22 per ASTM 3622 and B626
Monel	Type 400 per ASTM B165

Chemical	Copper	316SS	Hastelloy C	Monel
Acetone	G	G	G	G
Acetylene	P	G	G	G
Acetyl Chloride	P	G	G	L
Air	A	A	A	A
Alcohols	L	G	G	L
Aluminum Salts	-	-	-	-
Ammonia Aqueous	P	G	L	G
Amyl Acetate	P	G	G	G
Aniline	P	L	L	L
Arsenic Acid	L	L	L	P
Barium Carbonate	G	L	L	L
Benzaldehyde	L	L	G	L
Benzene	G	L	L	L
Benzyl Alcohol	-	G	G	G
Bleach 5% Active	-	G	G	G
Boric Acid 5%	L	L	G	L
Bromine Moist Gas	P	P	G	P
Butane (1)	L	G	G	G
Butyl Acetate	G	G	G	G
Calcium Hypochlorite 2% Boiling	P	L	L	L
Calcium Chloride Saturated	P	G	L	L
Carbon Dioxide	L	G	G	G
Carbon Disulfide	P	L	L	L
Carbon Monoxide	L	G	G	G
Caustic Potash	P	P	L	L
Caustic Soda	P	L	L	L
Chloracetic Acid	P	P	L	L
Chlorine (Dry)	P	P	P	P
Chlorine (Wet)	P	P	P	L
Chloroform	L	L	L	L
Chromic Acid Dilute	P	L	G	P
Copper Cyanide	P	L	L	L
Cresol	-	G	L	G
Cyclohexanone	-	G	G	-
Ethers	L	L	L	L
Ethyl Acetate	L	L	G	G
Ethyl Chloride Wet	L	G	L	L
Ethylamine	L	L	L	L
Ethyl Benzene	-	L	G	-
Ethyl Ether	L	L	L	L
Fatty Acids	P	G	G	L
Ferric Sulfate	P	G	L	P
Formaldehyde	L	L	L	L
Formic Acid	P	L	G	P
Freon Dry	G	G	G	L
Gasoline (1)	P	G	G	L
Glucose	G	G	-	G
Glycerin	G	G	G	G

Hydrochloric Acid. (Conc.) 40%	L	L	G	L
Hydrochloric Acid. (Conc.) 50%	L	L	G	L
Hydrofluoric Acid Boiling	P	G	P	L
Hydrogen Peroxide	L	L	G	P
Hydrogen Peroxide (Dil.)	L	G	L	G
Hydrogen Sulfide	L	G	L	L
Iodine	P	P	G	-
Kerosene (1)	G	G	G	G
Ketones	-	L	G	G
Lacquer Solvents	G	G	G	G
Lactic Acid	L	L	L	P
lead Acetate	L	L	L	L
Linseed Oil	L	G	G	G
Magnesium Carbonate	G	G	L	G
Naphtha	L	G	L	G
Natural Gas	G	G	G	G
Nickel Sulfate	P	L	L	L
Nitric Acid	P	L	P	P
Nitric Acid Fuming>10%	P	P	P	P
Nitrobenzene	-	G	L	G
Nitrous Oxide	G	L	L	P
Nitrous Acid	P	L	G	P
Oils Animal	-	G	G	L
Oils Mineral	L	G	G	G
Oils (Vegetable)	L	G	G	G
Oxygen (2) (3)	G	G	G	G
Perchloric Acid	-	P	L	P
Phenols	-	L	G	L
Potassium Acetate	-	L	-	-
Pyridine	L	G	L	G
Silver Nitrate	P	L	L	P
Soap Solutions	L	G	G	G
Sodium Aluminate	-	G	L	L
Stearic Acid	L	G	L	L
Sulfur Chloride	P	P	G	P
Sulfur Dioxide Gas Dry	L	G	L	L
Sulfuris Trioxide	-	L	L	L
Sulfurous Acid	P	P	L	P
Tannic Acid	L	G	L	P
Tanning Liquor (Alum Solution)	-	G	L	-
Titanium Tetrachloride	L	L	L	L
Toluene	G	G	G	G
Trichloroacetic Acid	P	P	G	L
Trichloroethylene	P	L	L	L
Turpentine	L	G	L	L
Urea	-	L	L	-
Uric Acid	G	L	L	L
Water, Distilled	L	G	G	G
Xylene	G	G	G	G
Zinc Chloride	L	P	G	L

**Footnotes for Fluid Compatibility Guides:** The Fluid Compatibility Guides are simplified rating tabulations based on immersion tests at 75° F. Higher temperatures tend to reduce ratings. **Since final selection depends on pressure, fluid and ambient temperature and other factors not known to Parker Hannifin Co., no performance guarantee is expressed or implied.** Ratings do not imply compliance with specialized codes such as FDA, NSF, AGA or UL and do not cover possible fluid discoloration, taste or odor effects. For conveying foodstuffs use FDA sanctioned materials, and for potable water use NSF listed materials. For chemicals not listed, or for advice on particular applications, please consult Product Engineering, Parflex Div., Ravenna, Ohio. (1) Applications for these fluids must take into account legal and insurance regulations. This **does not** imply AGA or UL compliance. (2) Chemical compatibility does not imply low permeation rates. Consult the Parker factory for a recommendation for your specific requirement. (3) Does not imply NSF or FDA compliance.



**Material Specifications for Metal Tubing**

Tubing Pressure Rating\*

Tubing Type	Tube Size (in.)		Tubing Pressure Rating (PSI) Versus Temperature**											
	O.D.	Wall	100°F		200°F		300°F		400°F		500°F		600°F	
			Burst	Opr.	Burst	Opr.	Burst	Opr.	Burst	Opr.	Burst	Opr.	Burst	Opr.
Copper Type DHP, Alloy No. 122, Soft Annealed Bright Seamless ASTM B68 and B75	1/4	.030	7230	1450	6630	1330	5730	1150	3620	730	-	-	-	-
	3/8	.032	5040	1010	4620	930	3990	800	2520	510	-	-	-	-
	1/2	.035	4050	810	3710	750	3200	640	2020	410	-	-	-	-
	1/2	.049	5900	1180	5400	1080	4700	940	2950	590	-	-	-	-
Stainless Steel, Type 316 Welded per ASTM A-269	1/4	.035	20100	5025	20100	5025	18200	4550	16900	4225	16300	4075	15900	3975
	3/8	.035	12800	3200	12800	3200	11600	2900	10800	2700	10400	2600	10200	2550
	1/2	.035	9400	2350	9400	2350	8500	2125	7900	1975	7600	1900	7500	1875
	1/2	.049	13500	3375	13500	3375	12300	3075	11400	2850	10900	2725	10700	2675
Stainless Steel, Type 316 Seamless per ASTM A-269	1/4	.035	23650	5910	23645	5910	23300	5825	19880	4970	19180	4795	18700	4675
	3/8	.035	15060	3765	15060	3765	13640	3410	12700	3175	12240	3060	12000	3000
	1/2	.035	11060	2765	11060	2765	10000	2500	9300	2325	8940	2235	8820	2205
	1/2	.049	15880	3970	15880	3970	14480	3620	13420	3355	12820	3205	12580	3145

\*All values are nominal.  
 \*\*Notes regarding pressure data are on the following page.

**Reference:** Pressure data for metal tubing is taken from American National Standard Code for Pressure Piping, "Power Piping, ANSI B31.1 – B30-1993A Edition." The values stated for operating (opr.) pressure are the maximum internal service pressure determined using the calculated burst pressure and an associated design factor. The equations and stress values were extracted from the above listed document.

Pressure data for Parker stainless steel tubing is derived from the relation shown to the right.

$$\text{Burst Pressure} = K \frac{2st}{D-0.8t}$$

where K = efficiency of weld (0.85);  
 (K = 1 for seamless)  
 s = tensile strength of stainless steel (psi)  
 D = tube O.D., in inches  
 t = tube wall thickness in inches

The operating pressure is taken to be 25% of the burst pressure, which is a 4 to 1 design factor.

## Notes:

### Copper and Stainless Tube

\*\*Pressure data for temperatures above 200°F are included for reference only.

Plastic coated tubing should not be used at temperatures exceeding approximately 80°C due to the PVC (or PE) jacket employed.

### Copper - Armored Tubing

\*\*Pressure data for temperatures above 200°F are included primarily for where the tubing must withstand higher ambient temperatures.

The assembly should not be used at temperatures exceeding approximately 80°C (176°F) due to the PVC tapes and jackets employed. Consult the Division if higher temperatures will be encountered.

### Copper - Jacketed Tubing

\*\*Pressure data for temperatures above 200°F are included primarily for where single runs must withstand higher ambient temperatures than the Multitube® bundle.

The Multitube® bundle should not be used at temperatures exceeding approximately 105°C due to the PVC jacket employed. Consult the Division if higher temperatures will be encountered.

### Stainless Steel - Jacketed Tubing

\*\*Pressure data for temperatures above 200°F are included primarily for where single runs must withstand higher ambient temperatures than the Multitube® bundle.

The Multitube® bundle should not be used at temperatures exceeding approximately 105°C due to the PVC jacket employed. Consult the Division if higher temperatures will be encountered.

## Testing Specifications for Metal Tubing:

All metal tubes used in the manufacture of Multitube® bundles are subject to stringent magnetic analysis using a special eddy current tester. Each tube, after eddy current analysis, is pressure tested at not less than 250 psi for 15 minutes without any sign of leakage.

When Multitube® assemblies have completed the manufacturing process, each tube is tested again with dry N<sub>2</sub> at 250 psi for 5 minutes prior to shipment.

## Testing Specifications for Plastic Tubing:

All plastic used in the manufacture of Multitube® bundles are subject to rigorous Q.A. inspection and testing prior to shipment. Each tube is pressure tested at not less than 150 psi for 15 minutes without any sign of leakage.

When Multitube® assemblies have completed the manufacturing process, each tube is tested again with dry N<sub>2</sub> at 125 psi for 5 minutes prior to shipment.

### Material Specifications for Jackets:

**Flame-Resistant Polyvinyl Chloride (FR PVC) Jacket:**

Black, 105°C-rated, flame-resistant, corrosion-resistant thermoplastic compound with excellent low-temperature flexibility properties. Meets or exceeds ASTM D-1047, IPCEA S-19-81, and IPCEA S-61-401.

**Thermoplastic Rubber (TPR) Jacket:** Black, corrosion- and weather-resistant thermoplastic rubber material.

**Flame-Resistant Thermoplastic Elastomer (FR-TPE) Jacket:**

Black, flame-retarding thermoplastic elastomer compound. UL94-V-0 flame classification. Passes IEEE vertical flame test. Meets ASTM D-2671 copper mirror corrosion test standards.

**Polyurethane (PUR) Jacket:** Black, abrasion- and corrosion-resistant compound with excellent hydrolytic stability.

**Flame-Resistant Polyurethane (FR PUR) Jacket:**

Black, flame-retarding, abrasion- and corrosion-resistant compound which exhibits excellent low-temperature properties, hydrolysis resistance, and fungus resistance which has a UL94 flame test rating of V-0.

**Low Density Polyethylene (LDPE) Jacket:** Black, weather-resistant grade, high molecular weight, low-density compound which meets the requirements of ASTM D-1248-72 as follows: Type I, Class A, Category 4, Grade E5.

**Flame-Resistant Polyethylene (FRPE) Jacket:**

Black, weather-resistant, high molecular weight, flame-resistant polyethylene compound which meets the UL94 V-2 flame classification.

### Selecting a Jacket Material

Parflex Multitube® Instrument and Heat Trace Tubing Products are currently offered with a choice of several jacket materials. The purpose of this report is to present the main properties of the standard thermoplastics and to discuss selection factors for various Multitube® products.

The following table provides a summary of the main properties of the standard jacket materials. Additional details can be provided upon request to the factory.

#### Current Jacket Materials for Multitube® Products

	105°C FR-PVC	TPR	FR-TPE	PUR	FR-PUR	LDPE	FRPE
Hardness, Shore A	72	92	87	90	75	50D	90
Abrasion resistance	G	G	G	E	E	G	G
Mechanical resistance	G	F	G	E	E	G	G
Max. continuous service °F	221	248	266	250	180	150	150
Low temp. brittleness °F	-41	-55	-69	-40	-90	-80	-80
Rec. min. installation °F	-35	-50	-60	-20	-70	-50	-60
<b>Environmental Resistance</b>							
Aliphatic hydrocarbons	F	P	G	G	G	G	G
Aromatic hydrocarbons	U	P	F	G	G	G	F
Halogenated solvents	U	P	P	P	P	F-P	P
Acids	F	G	E	F	F	G	G
Alkalies	F	G	E	G	G	G	E
Oils	G	F	E	G	G	E	G
Water	G	E	E	G	G	E	E
Weathering	G*	F*	E*	E*	E*	G*	G*
<b>Flamability</b>							
Oxygen index	24	NFR	24.7	NFR	26	NFR	25
UL94 vertical flame test	V-2	—	V-0	—	V-0	—	V-2
IEEE vertical tray flame test	Pass	—	Pass	—	Pass	—	Pass
Water absorption, 24 hours, %	.1	1.5	.3	1.0	1.5	.01	0.3

E = Excellent G = Good F = Fair P = Poor U = Unsatisfactory NFR = Not flame resistant

Note: Bundles may also be armored with galvanized steel, arch-shaped, spiral wound sheet metal designed for greater crush protection and pull-apart resistance.

Please refer to product bulletins in the Instrument Tubing and Pre-Insulated Tubing section of the Multitube® catalog for data on standard Multitube® products utilizing the jacket materials described in this engineering report.

\*Requires carbon black for ultraviolet (U.V.) resistance.

## SEAMLESS TUBING MATERIAL PRODUCTION LIST

Corrosion Resistant Alloys	
304	Monel 400
304L	Monel K500
316	Inconel 625
316L	Incoloy 825
317L	C22
347	C276

Heat Resistant Alloys
321
310
Alloy 718

316/L COIL LENGTHS* IMPERIAL SIZE TUBING					
Nominal Outer Diameter	Wall	Coil Length			
(in)	(in)	(ft)	(m)	lbs/ft	kg/m
0.125	0.028	6260	1908	0.030	0.045
0.125	0.035	5370	1636	0.035	0.052
0.250	0.028	2760	841	0.068	0.101
0.250	0.035	2260	688	0.083	0.124
0.250	0.049	1740	530	0.108	0.161
0.375	0.035	1410	429	0.131	0.195
0.375	0.049	1050	320	0.175	0.260
0.375	0.065	830	252	0.221	0.329
0.500	0.035	1010	307	0.178	0.265
0.500	0.049	740	225	0.242	0.360
0.500	0.065	580	176	0.310	0.461
0.625	0.035	790	240	0.226	0.336
0.625	0.049	580	176	0.309	0.460
0.625	0.065	450	137	0.398	0.592
0.750	0.049	470	143	0.376	0.560
0.750	0.065	360	109	0.487	0.725
1.000	0.065	270	82	0.665	0.990
1.000	0.083	210	64	0.832	1.238

316/L COIL LENGTHS* METRIC SIZE TUBING					
Nominal Outer Diameter	Wall	Average Coil Length			
(in)	(in)	(ft)	(m)	lbs/ft	kg/m
6.00	1.00	2230	679	0.084	0.125
6.00	1.50	1630	496	0.115	0.171
8.00	1.00	1590	484	0.118	0.176
8.00	1.50	1130	344	0.166	0.247
10.00	1.00	1210	368	0.152	0.226
10.00	1.50	850	259	0.217	0.323
12.00	1.00	1000	304	0.185	0.275
12.00	1.50	690	210	0.267	0.397
14.00	1.00	820	249	0.219	0.326
14.00	1.50	560	170	0.318	0.473
18.00	1.00	420	128	0.419	0.624
18.00	2.50	270	82	0.654	0.973
20.00	1.25	450	137	0.396	0.589
20.00	1.50	380	115	0.470	0.699

\* Contact factory for other alloy coil length packages.



**TUBE WORKING, YIELD AND BURST PRESSURE FOR SEAMLESS TUBING**  
**Type 316L at -20° to +100°F (-29°C to 37.8°C)**

Imperial Size							
OD (in.)	Wall (in)	Nominal ID (in)	Yield Strength	Tensile Strength	Ratio	Boardmanz Yield	Boardmanz Burst
0.125	0.028	0.069	25,000	70,000	0.224	11991	56812
0.125	0.035	0.055	25,000	70,000	0.280	15202	89091
0.250	0.028	0.194	25,000	70,000	0.112	6204	21445
0.250	0.035	0.180	25,000	70,000	0.140	8540	29519
0.250	0.049	0.152	25,000	70,000	0.196	10355	45132
0.375	0.035	0.305	25,000	70,000	0.093	4872	16839
0.375	0.049	0.277	25,000	70,000	0.131	7710	26652
0.375	0.065	0.245	25,000	70,000	0.173	9039	37143
0.500	0.035	0.430	25,000	70,000	0.070	3408	11779
0.500	0.049	0.402	25,000	70,000	0.098	5190	17940
0.500	0.065	0.370	25,000	70,000	0.130	7653	26454
0.625	0.035	0.555	25,000	70,000	0.056	2621	9058
0.625	0.049	0.527	25,000	70,000	0.078	3912	13520
0.625	0.065	0.495	25,000	70,000	0.104	5614	19403
0.750	0.049	0.652	25,000	70,000	0.065	3139	10848
0.750	0.065	0.620	25,000	70,000	0.087	4432	15320
1.000	0.065	0.870	25,000	70,000	0.065	3120	10782
1.000	0.083	0.834	25,000	70,000	0.083	4198	14511

Metric Size							
OD (mm)	Wall (mm)	Nominal ID (mm)	Yield Strength	Tensile Strength	Ratio	Boardmanz Yield	Boardmanz Burst
6.00	1.00	4.01	25,000	70,000	0.165	11092	38343
6.00	1.50	3.00	25,000	70,000	0.250	13500	70000
8.00	1.00	6.02	25,000	70,000	0.124	7135	24662
8.00	1.50	5.00	25,000	70,000	0.187	9849	41929
10.00	1.00	8.03	25,000	70,000	0.099	5258	18176
10.00	1.50	7.01	25,000	70,000	0.150	9468	32726
12.00	1.00	10.01	25,000	70,000	0.083	4175	14430
12.00	1.50	8.99	25,000	70,000	0.125	7233	25000
14.00	1.00	12.01	25,000	70,000	0.071	3454	11938
14.00	1.50	11.00	25,000	70,000	0.107	5837	20176
18.00	1.00	14.99	25,000	70,000	0.083	4219	14584
18.00	2.50	13.00	25,000	70,000	0.138	8395	29019
20.00	1.25	17.50	25,000	70,000	0.062	2965	10248
20.00	1.50	16.99	25,000	70,000	0.075	3703	12799

For other alloys and temperatures, multiply the pressure shown by the following factor:

Alloy	Temperature			
	Room Temperature	300° F (148°C)	500° F (260°C)	700° F (371°C)
304L	1.00	1.00	0.89	0.81
316L	1.00	1.00	0.86	0.77
Monel 400	1.12	0.92	0.89	—
Inconel 625	2.40	2.40	2.33	2.24
Inconel 825	1.22	1.17	1.04	0.96
C-276	1.50	1.50	1.43	1.38

**SEAMLESS TUBE ANALYSES - ASTM STANDARD GRADES AVAILABLE**

Analysis	304	304L	316	316L	317L	321	347
Application	General good corrosion resistance grade	Lower carbon of 304 with good weldability	Better corrosion resistance than 304 in chloride	As for 316. Good weldability	As for 316 with increased pitting corrosion resistance	General where good weldability required with possible weld decay attack & improved high temperature properties	As for 321 but uses niobium as stabilizing element
C	.08 Max	.04 Max	.08 Max	.04 Max	.04 Max	.08 Max	.10 Max
Mn	2.00 Max	2.00 Max	2.00 Max	2.00 Max	2.00 Max	2.00 Max	2.00 Max
P	.040 Max	.040 Max	.040 Max	.040 Max	0.04 Max	.040 Max	.040 Max
S	.030 Max	.030 Max	.030 Max	.030 Max	0.03 Max	.030 Max	.030 Max
Si	.75 Max	.75 Max	.75 Max	.75 Max	.75 Max	.75 Max	.75 Max
Cr	18.0/20.0	18.0/20.0	16.0/18.0	16.0/18.0	18.0/20.0	17.0/20.0	17.0/19.0
Ni	8.0/10.5	8.0/12.0	11.0/14.0	10.0/14.0	11.0/15.0	9.0/12.0	9.0/13.0
Other	N: .10 Mo: .50 Max	N: .10 Mo: .50 Max	N: .10 Mo: 2.0/3.0	N: .10 Mo: 2.0/3.0	Mo: 3.0/4.0	N: .10 Ti: 5xC Min 0.70 Max	Cb+Ta: 10xC Min 1.0 Max

Analysis	Monel 400	Monel 500	Alloy 625	Alloy 718	Alloy 825	C276	C22
Application	General purpose alloy with good combination of strength, ductility & corrosion resistance	High strength, precipitation hardenable, good corrosion resistance	Very good resistance to corrosion, pitting crevice & stress corrosion.	Age hardenable, high strength up to 1300F (700C) corrosion resistance & weldability	Good resistance to stress corrosion in sulphuric/ phosphoric acid. Good general resistance.	Very good resistance to chloride sulphuric acid	
C	.30 Max	.25 Max	.10 Max	.08 Max	.05 Max	.01 Max	.015 Max
Mn	2.0 Max	1.5 Max	.50 Max	.35 Max	1.0 Max	1.00 Max	.50 Max
S	.024 Max	.01 Max	.015 Max	.015 Max	.03 Max	.03 Max	.010 Max
Si	.50 Max	.50 Max	.50 Max	.35 Max	.50 Max	.08 Max	.08 Max
Ni+Co	63.0 Max	63.0/70.0	Balance	50.0/55.0	38.0/46.0	Balance	Balance
Cr	-	-	20.0/23.0	17.0/21.0	19.5/23.5	14.5/16.5	20.0/22.5
Ti	-	.35/.85	.40 Max	.65/1.15	.60/1.2	-	-
Cb+Ta	-	-	3.15/4.15	4.75/5.50	-	-	-
Al	-	2.3/3.15	.40 Max	.20/.80	0.2	-	-
Fe	2.5 Max	2.00 Max	5.0 Max	Balance	22.0 Min	4.0/7.0	2.0/6.0
Mo	-	-	8.0/10.0	2.8/3.30	2.5/3.5	15.0/17.0	12.5/14.5
Cu	28.0/34.0	Balance	-	.30 Max	1.5/3.0	-	-
Other	-	-	P: .015 Max	-	-	Co: 2.5 Max P: .04 Max V: .35 Max W: 3.0/4.5	Co: 2.5 Max P: .025 Max V: .35 Max W: 2.5/3.5



**MECHANICAL PROPERTIES OF SEAMLESS TUBING**

**Mechanical Properties-  
Stainless Steel\*  
(Normal Diameter and Wall)**

Alloy	Temper	Tensile Strength (ksi)	Yield Strength (ksi)	Min. Elong. in 2 inches	Rockwell Hardness
304	1	100 Max	30	35	B90 Max
	1/8 Hard	105-140	75-110	20	-
	2	125-150	85-125	15	C30 Max
	3	150 Min.	115-160	7	C40 Max
304L	1	100 Max	25	35	B90 Max
	1/8 Hard	105-140	75-110	20	-
	2	110-140	75-110	15	C25 Max
	3	140 Min.	110-150	7	C38 Max
310	1	100 Max	35	35	B95 Max
	2	115-135	70-115	15	C26 Max
	3	145 Min.	110-160	5	C38 Max
316	1	100 Max	30	35	B95 Max
	2	115-135	70-110	15	C26 Max
	3	145 Min.	105-150	6	C38 Max
316L	1	100 Max	25	35	B95 Max
	2	115-135	70-110	15	C26 Max
	3	145 Min.	105-150	6	C38 Max
321	1	105 Max	30	35	B92 Max
	2	110-135	80-115	15	C26 Max
	3	140 Min.	125-160	6	C38 Max
347	1	105 Max	30	35	B92 Max
	2	110-135	80-115	12	C26 Max
	3	140 Min.	125-160	6	C38 Max

**Mechanical Properties-  
Nickel & Nickel Base Alloys\*\*  
(Normal Diameter and Wall)**

Alloy	Temper	Tensile Strength (ksi)	Yield Strength (ksi)	Min. Elong. in 2 inches	Rockwell Hardness
Alloy 400	1	85 Max	28	32	B80 Max
	2	90-105	55-80	12	B97 Max
	3	110 Min.	90-120	3	C27 Max
Alloy 500	1	110 Max	40	28	B95 Max
	2	110-130	65-95	10	C23 Max
	3	130 Min.	90-110	4	C26 Max
Alloy 625	1	85-115	35 Min	30	B90 Max
Alloy 825	1	120 Max	60 Max	30	-
Alloy C22	1	100 Min	41 Min	40	-
Alloy C276	1	100 Min	45 Min	45	-

Note:  
 Temper - #1 Annealed; #2 Half Hard; #3 Full Hard  
 \*Properties shown above are for sizes larger than .125" and heavier than .015" wall.  
 \*\*Properties shown are for larger than .188" O.D. heavier than .020" wall.  
 In cases of dispute, tensile strength will be considered referee.

# Parker Safety Guide

## Parker Safety Guide for Selecting and Using Hose, Tubing, Fittings, Connectors, Conductors, Valves and Related Accessories



**Parker Safety Guide for Selecting and Using Hose, Tubing, Fittings and Related Accessories**  
**Publication No. 4400-B.1**  
**Revised: September 2015**

**WARNING:** Failure or improper selection or improper use of hose, tubing, fittings, assemblies, valves, connectors, conductors or related accessories ("Products") can cause death, personal injury and property damage. Possible consequences of failure or improper selection or improper use of these Products include, but are not limited to:

- Fittings thrown off at high speed.
- High velocity fluid discharge.
- Explosion or burning of the conveyed fluid.
- Electrocutation from high voltage electric powerlines.
- Contact with suddenly moving or falling objects that are controlled by the conveyed fluid.
- Injections by high-pressure fluid discharge.

- Dangerously whipping Hose.
- Tube or pipe burst.
- Weld joint fracture.
- Contact with conveyed fluids that may be hot, cold, toxic or otherwise injurious.
- Sparking or explosion caused by static electricity buildup or other sources of electricity.
- Sparking or explosion while spraying paint or flammable liquids.
- Injuries resulting from inhalation, ingestion or exposure to fluids.

Before selecting or using any of these Products, it is important that you read and follow the instructions below. No product from any division in Fluid Connector Group is approved for in-flight aerospace applications. For hoses and fittings used in in-flight aerospace applications, please contact Parker Aerospace Group.

### 1.0 GENERAL INSTRUCTIONS

1.0 Scope: This safety guide provides instructions for selecting and using (including assembling, installing, and maintaining) these Products. For convenience, all rubber and/or thermoplastic products commonly called "hose" or "tubing" are called "Hose" in this safety guide. Metallic tube or pipe are called "tube". All assemblies made with Hose are called "Hose Assemblies". All assemblies made with Tube are called "Tube Assemblies". All products commonly called "fittings", "couplings" or "adapters" are called "Fittings". Valves are fluid system components that control the passage of fluid. Related accessories are ancillary devices that enhance or monitor performance including crimping, flaring, flanging, presetting, bending, cutting, deburring, swaging machines, sensors, tags, lockout handles, spring guards and associated tooling. This safety guide is a supplement to and is to be used with the specific Parker publications for the specific Hose, Fittings and Related Accessories that are being considered for use. Parker publications are available at [www.parker.com](http://www.parker.com). SAE J1273 ([www.sae.org](http://www.sae.org)) and ISO 17165-2 ([www.ansi.org](http://www.ansi.org)) also provide recommended practices for hydraulic Hose Assemblies, and should be followed.

1.1 Fail-Safe: Hose, Hose Assemblies, Tube, Tube Assemblies and Fittings can and do fail without warning for many reasons. Design all systems and equipment in a fail-safe mode, so that failure of the Hose, Hose Assembly, Tube, Tube Assembly or Fitting will not endanger persons or property.

1.2 Distribution: Provide a copy of this safety guide to each person responsible for selecting or using Hose, Tube and Fitting products. Do not select or use Parker Hose, Tube or Fittings without thoroughly reading and understanding this safety guide as well as the specific Parker publications for the Products.

1.3 User Responsibility: Due to the wide variety of operating conditions and applications for Hose, Tube and Fittings. Parker does not represent or warrant that any particular Hose, Tube or Fitting is suitable for any specific end use system. This safety guide does not analyze all technical parameters that must be considered in selecting a product. The user, through its own analysis and testing, is solely responsible for:

- Making the final selection of the Products.
- Assuring that the user's requirements are met and that the application presents no health or safety hazards.
- Following the safety guide for Related Accessories and being trained to operate Related Accessories.
- Providing all appropriate health and safety warnings on the equipment on which the Products are used.
- Assuring compliance with all applicable government and industry standards.

1.4 Additional Questions: Call the appropriate Parker technical service department if you have any questions or require any additional information. See the Parker publication for the Products being considered or used, or call 1-800-CPARKER, or go to [www.parker.com](http://www.parker.com), for telephone numbers of the appropriate technical service department.

### 2.0 HOSE, TUBE & FITTINGS SELECTION INSTRUCTIONS

2.1 Electrical Conductivity: Certain applications require that the Hose be nonconductive to prevent electrical current flow. Other applications require the Hose and the Fittings and the Hose/Fitting interface to be sufficiently conductive to drain off static electricity. Extreme care must be exercised when selecting Hose, Tube and Fittings for these or any other applications in which electrical conductivity or nonconductivity is a factor. The electrical conductivity or nonconductivity of Hose, Tube and Fittings is dependent upon many factors and may be susceptible to change. These factors include but are not limited to the various materials used to make the Hose and the Fittings, Fitting finish (some Fitting finishes are electrically conductive while others are nonconductive), manufacturing methods (including moisture control), how the Fittings contact the Hose, age and amount of deterioration or damage or other changes, moisture content of the Hose at any particular time, and other factors. The following are considerations for electrically nonconductive and conductive Hose. For other applications consult the individual catalog pages and the appropriate industry or regulatory standards for proper selection.

2.1.1 Electrically Nonconductive Hose: Certain applications require that the Hose be nonconductive to prevent electrical current flow or to maintain electrical isolation. For applications that require Hose to be electrically nonconductive, including but not limited to applications near high voltage electric lines, only special nonconductive Hose can be used. The manufacturer of the equipment in which the nonconductive Hose is to be used must be consulted to be certain that the Hose, Tube and Fittings that are selected are proper for the application. Do not use any Parker Hose or Fittings for any such application requiring nonconductive Hose, including but not limited to applications near high voltage electric lines or dense magnetic fields, unless (i) the application is expressly approved in the Parker technical publication for the product, (ii) the Hose is marked "nonconductive", and (iii) the manufacturer of the equipment on which the Hose is to be used specifically approves the particular Parker Hose, Tube and Fittings for such use.

2.1.2 Electrically Conductive Hose: Parker manufactures special Hose for certain applications that require electrically conductive Hose. Parker manufactures special Hose for conveying paint in airless paint spraying applications. This Hose is labeled "Electrically Conductive Airless Paint Spray Hose" on its layline and packaging. This Hose must be properly connected to the appropriate Parker Fittings and properly grounded in order to dissipate dangerous static charge buildup, which occurs in all airless paint spraying applications. Do not use any other Hose for airless paint spraying, even if electrically conductive. Use of any other Hose or failure to properly connect the Hose can cause a fire or an explosion resulting in death, personal injury, and property damage. All hoses that convey fuels must be grounded.

Parker manufactures a special Hose for certain compressed natural gas ("CNG") applications where static electricity buildup may occur. Parker CNG Hose assemblies comply with the requirements of ANSI/AS NGV 4.2; CSA 12.52, "Hoses for Natural Gas Vehicles and Dispensing Systems" ([www.ansi.org](http://www.ansi.org)). This Hose is labeled "Electrically Conductive for CNG Use" on its layline and packaging. This Hose must be properly connected to the appropriate Parker Fittings and properly grounded in order to dissipate

dangerous static charge buildup, which occurs in, for example, high velocity CNG dispensing or transfer. Do not use any other Hose for CNG applications where static charge buildup may occur, even if electrically conductive. Use of other Hoses in CNG applications or failure to properly connect or ground this Hose can cause a fire or an explosion resulting in death, personal injury, and property damage. Care must also be taken to protect against CNG permeation through the Hose wall. See section 2.6, Permeation, for more information. Parker CNG Hose is intended for dispenser and vehicle use within the specified temperature range. Parker CNG Hose should not be used in confined spaces or unventilated areas or areas exceeding the specified temperature range. Final assemblies must be tested for leaks. CNG Hose Assemblies should be tested on a monthly basis for conductivity per ANSI/IAS NGV 4.2; CSA 12.52.

Parker manufactures special Hose for aerospace in-flight applications. Aerospace in-flight applications employing Hose to transmit fuel, lubricating fluids and hydraulic fluids require a special Hose with a conductive inner tube. This Hose for in-flight applications is available only from Parker's Stratoflex Products Division. Do not use any other Parker Hose for in-flight applications, even if electrically conductive. Use of other Hoses for in-flight applications or failure to properly connect or ground this Hose can cause a fire or an explosion resulting in death, personal injury and property damage. These Hose assemblies for in-flight applications must meet all applicable aerospace industry, aircraft engine and aircraft requirements.

**2.2 Pressure:** Hose, Tube and Fitting selection must be made so that the published maximum working pressure of the Hose, Tube and Fittings are equal to or greater than the maximum system pressure. The maximum working pressure of a Hose, or Tube Assembly is the lower of the respective published maximum working pressures of the Hose, Tube and the Fittings used. Surge pressures or peak transient pressures in the system must be below the published maximum working pressure for the Hose, Tube and Fitting. Surge pressures and peak pressures can usually only be determined by sensitive electrical instrumentation that measures and indicates pressures at millisecond intervals. Mechanical pressure gauges indicate only average pressures and cannot be used to determine surge pressures or peak transient pressures. Published burst pressure ratings for Hose is for manufacturing test purposes only and is no indication that the Product can be used in applications at the burst pressure or otherwise above the published maximum recommended working pressure.

**2.3 Suction:** Hoses used for suction applications must be selected to insure that the Hose will withstand the vacuum and pressure of the system. Improperly selected Hose may collapse in suction application.

**2.4 Temperature:** Be certain that fluid and ambient temperatures, both steady and transient, do not exceed the limitations of the Hose, Tube, Fitting and Seals. Temperatures below and above the recommended limit can degrade Hose, Tube, Fittings and Seals to a point where a failure may occur and release fluid. Tube and Fittings performances are normally degraded at elevated temperature. Material compatibility can also change at temperatures outside of the rated range. Properly insulate and protect the Hose Assembly when routing near hot objects (e.g. manifolds). Do not use any Hose in any application where failure of the Hose could result in the conveyed fluids (or vapors or mist from the conveyed fluids) contacting any open flame, molten metal, or other potential fire ignition source that could cause burning or explosion of the conveyed fluids or vapors.

**2.5 Fluid Compatibility:** Hose, and Tube Assembly selection must assure compatibility of the Hose tube, cover, reinforcement, Tube, Plating and Seals with the fluid media used. See the fluid compatibility chart in the Parker publication for the product being considered or used. This information is offered only as a guide. Actual service life can only be determined by the end user by testing under all extreme conditions and other analysis. Hose, and Tube that is chemically compatible with a particular fluid must be assembled using Fittings and adapters containing likewise compatible seals. Flange or flare processes can change Tube material properties that may not be compatible with certain requirements such as NACE.

**2.6 Permeation:** Permeation (that is, seepage through the Hose or Seal) will occur from inside the Hose or Fitting to outside when Hose or Fitting is used with gases, liquid and gas fuels, and refrigerants (including but not limited to such materials as helium, diesel fuel, gasoline, natural gas, or LPG). This permeation may result in high concentrations of vapors which are potentially flammable, explosive, or toxic, and in loss of fluid. Dangerous explosions, fires, and other hazards can result when using the wrong Hose for such applications. The system designer must take into account the fact that this permeation will take place and must not use Hose or Fitting if this permeation could be hazardous. The system designer must take into account all legal, government, insurance, or any other special regulations which govern the use of fuels and refrigerants. Never use a

Hose or Fitting even though the fluid compatibility is acceptable without considering the potential hazardous effects that can result from permeation through the Hose or Tube Assembly. Permeation of moisture from outside the Hose or Fitting to inside the Hose or Fitting will also occur in Hose or Tube assemblies, regardless of internal pressure. If this moisture permeation would have detrimental effects (particularly, but not limited to refrigeration and air conditioning systems), incorporation of sufficient drying capacity in the system or other appropriate system safeguards should be selected and used. The sudden pressure release of highly pressurized gas could also result in Explosive Decompression failure of permeated Seals and Hoses.

**2.7 Size:** Transmission of power by means of pressurized fluid varies with pressure and rate of flow. The size of the components must be adequate to keep pressure losses to a minimum and avoid damage due to heat generation or excessive fluid velocity.

**2.8 Routing:** Attention must be given to optimum routing to minimize inherent problems (kinking or flow restriction due to Hose collapse, twisting of the Hose, proximity to hot objects or heat sources). For additional routing recommendations see SAE J1273 and ISO 17165-2. Hose Assemblies have a finite life and should be installed in a manner that allows for ease of inspection and future replacement. Hose because of its relative short life, should not be used in residential and commercial buildings inside of inaccessible walls or floors, unless specifically allowed in the product literature. Always review all product literature for proper installation and routing instructions.

**2.9 Environment:** Care must be taken to insure that the Hose, Tube and Fittings are either compatible with or protected from the environment (that is, surrounding conditions) to which they are exposed. Environmental conditions including but not limited to ultraviolet radiation, sunlight, heat, ozone, moisture, water, salt water, chemicals and air pollutants can cause degradation and premature failure.

**2.10 Mechanical Loads:** External forces can significantly reduce Hose, Tube and Fitting life or cause failure. Mechanical loads which must be considered include excessive flexing, twist, kinking, tensile or side loads, bend radius, and vibration. Use of swivel type Fittings or adapters may be required to insure no twist is put into the Hose. Use of proper Hose or Tube clamps may also be required to reduce external mechanical loads. Unusual applications may require special testing prior to Hose selection.

**2.11 Physical Damage:** Care must be taken to protect Hose from wear, snagging, kinking, bending smaller than minimum bend radius and cutting, any of which can cause premature Hose failure. Any Hose that has been kinked or bent to a radius smaller than the minimum bend radius, and any Hose that has been cut or is cracked or is otherwise damaged should be removed and discarded. Fittings with damages such as scratches on sealing surfaces and deformation should be replaced.

**2.12 Proper End Fitting:** See instructions 3.2 through 3.5. These recommendations may be substantiated by testing to industry standards such as SAE J517 for hydraulic applications, or MIL-A-5070, AS1339, or AS3517 for Hoses from Parker's Stratoflex Products Division for aerospace applications.

**2.13 Length:** When determining the proper Hose or Tube length of an assembly take into consideration. The Hose length change due to pressure. The Tube length change due to thermal expansion or contraction, and the Hose or Tube machine tolerances and movements. When routing short hose assemblies, it is recommended that the minimum free hose length is always used. Consult the hose manufacturer for their minimum free hose length recommendations. Hose assemblies should be installed in such a way that any motion or flexing occurs within the same plane.

**2.14 Specifications and Standards:** When selecting Hose, Tube and Fittings, government, industry, and Parker specifications and recommendations must be reviewed and followed as applicable.

**2.15 Hose Cleanliness:** Hose and Tube components may vary in cleanliness levels. Care must be taken to ensure that the Hose and Tube Assembly selected has an adequate level of cleanliness for the application.

**2.16 Fire Resistant Fluids:** Some fire resistant fluids that are to be conveyed by Hose or Tube require use of the same type of Hose or Tube as used with petroleum base fluids. Some such fluids require a special Hose, Tube, Fitting and Seal, while a few fluids will not work with any Hose at all. See instructions 2.5 and 1.5. The wrong Hose, Tube, Fitting or Seal may fail after a very short service. In addition, all liquids but pure water may burn fiercely under certain conditions, and even pure water leakage may be hazardous.

**2.17 Radiant Heat:** Hose and Seals can be heated to destruction without contact by such nearby items as hot manifolds or molten metal. The same heat source may then initiate a fire. This can occur despite the presence of cool air around the Hose or Seal. Performance of Tube and Fitting subjected to the heat could be degraded.

**2.18 Welding or Brazing:** When using a torch or arc welder in close

proximity to hydraulic lines, the hydraulic lines should be removed or shielded with appropriate fire resistant materials. Flame or weld spatter could burn through the Hose or Seal and possibly ignite escaping fluid resulting in a catastrophic failure. Heating of plated parts, including Hose Fittings and adapters, above 450°F (232°C) such as during welding, brazing or soldering may emit deadly gases. Any elastomer seal on fittings shall be removed prior to welding or brazing, any metallic surfaces shall be protected after brazing or welding when necessary. Welding and brazing filler material shall be compatible with the Tube and Fitting that are joined.

2.19 Atomic Radiation: Atomic radiation affects all materials used in Hose and Tube assemblies. Since the long-term effects may be unknown, do not expose Hose or Tube assemblies to atomic radiation. Nuclear applications may require special Tube and Fittings.

2.20 Aerospace Applications: The only Hose, Tube and Fittings that may be used for in-flight aerospace applications are those available from Parker's Stratoflex Products Division. Do not use any other Hose or Fittings for in-flight applications. Do not use any Hose or Fittings from Parker's Stratoflex Products division with any other Hose or Fittings, unless expressly approved in writing by the engineering manager or chief engineer of Stratoflex Products Division with any other Hose or Fittings, unless expressly approved in writing by the engineering manager or chief engineer of Stratoflex Products Division and verified by the user's own testing and inspection to aerospace industry standards.

2.21 Unlocking Couplings: Ball locking couplings or other Fittings with quick disconnect ability can unintentionally disconnect if they are dragged over obstructions, or if the sleeve or other disconnect member, is bumped or moved enough to cause disconnect. Threaded Fittings should be considered where there is a potential for accidental uncoupling.

### 3.0 HOSE AND FITTINGS ASSEMBLY AND INSTALLATION INSTRUCTIONS

3.1 Component Inspection: Prior to assembly, a careful examination of the Hose and Fittings must be performed. All components must be checked for correct style, size, catalog number, and length. The Hose must be examined for cleanliness, obstructions, blisters, cover looseness, kinks, cracks, cuts or any other visible defects. Inspect the Fitting and sealing surfaces for burrs, nicks, corrosion or other imperfections. Do NOT use any component that displays any signs of nonconformance.

3.2 Hose and Fitting Assembly: Do not assemble a Parker Fitting on a Parker Hose that is not specifically listed by Parker for that Fitting, unless authorized in writing by the engineering manager or chief engineer of the appropriate Parker division. Do not assemble a Parker Fitting on another manufacturer's Hose or a Parker Hose on another manufacturer's Fitting unless (i) the engineering manager or chief engineer of the appropriate Parker division approves the Assembly in writing or that combination is expressly approved in the appropriate Parker literature for the specific Parker product, and (ii) the user verifies the Assembly and the application through analysis and testing. For Parker Hose that does not specify a Parker Fitting, the user is solely responsible for the selection of the proper Fitting and Hose Assembly procedures. See instruction 1.4.

To prevent the possibility of problems such as leakage at the Fitting or system contamination, it is important to completely remove all debris from the cutting operation before installation of the Fittings. The Parker published instructions must be followed for assembling the Fittings on the Hose. These instructions are provided in the Parker Fitting catalog for the specific Parker Fitting being used, or by calling 1-800-CPARKER, or at [www.parker.com](http://www.parker.com).

3.3 Related Accessories: Do not crimp or swage any Parker Hose or Fitting with anything but the listed swage or crimp machine and dies in accordance with Parker published instructions. Do not crimp or swage another manufacturer's Fitting with a Parker crimp or swage die unless authorized in writing by the engineering manager or chief engineer of the appropriate Parker division.

3.4 Parts: Do not use any Parker Fitting part (including but not limited to socket, shell, nipple, or insert) except with the correct Parker mating parts, in accordance with Parker published instructions, unless authorized in writing by the engineering manager or chief engineer of the appropriate Parker division.

3.5 Field Attachable/Permanent: Do not reuse any field attachable Hose Fitting that has blown or pulled off a Hose. Do not reuse a Parker permanent Hose Fitting (crimped or swaged) or any part thereof. Complete Hose Assemblies may only be reused after proper inspection under section 4.0. Do not assemble Fittings to any previously used hydraulic Hose that was in service, for use in a fluid power application.

3.6 Pre-Installation Inspection: Prior to installation, a careful examination of the Hose Assembly must be performed. Inspect the Hose

Assembly for any damage or defects. DO NOT use any Hose Assembly that displays any signs of nonconformance.

3.7 Minimum Bend Radius: Installation of a Hose at less than the minimum listed bend radius may significantly reduce the Hose life. Particular attention must be given to preclude sharp bending at the Hose to Fitting juncture. Any bending during installation at less than the minimum bend radius must be avoided. If any Hose is kinked during installation, the Hose must be discarded.

3.8 Twist Angle and Orientation: Hose Assembly installation must be such that relative motion of machine components does not produce twisting.

3.9 Securement: In many applications, it may be necessary to restrain, protect, or guide the Hose to protect it from damage by unnecessary flexing, pressure surges, and contact with other mechanical components. Care must be taken to insure such restraints do not introduce additional stress or wear points.

3.10 Proper Connection of Ports: Proper physical installation of the Hose Assembly requires a correctly installed port connection insuring that no twist or torque is transferred to the Hose when the Fittings are being tightened or otherwise during use.

3.11 External Damage: Proper installation is not complete without insuring that tensile loads, side loads, kinking, flattening, potential abrasion, thread damage or damage to sealing surfaces are corrected or eliminated. See instruction 2.10.

3.12 System Checkout: All air entrapment must be eliminated and the system pressurized to the maximum system pressure (at or below the Hose maximum working pressure) and checked for proper function and freedom from leaks. Personnel must stay out of potential hazardous areas while testing and using.

3.13 Routing: The Hose Assembly should be routed in such a manner so if a failure does occur, the escaping media will not cause personal injury or property damage. In addition, if fluid media comes in contact with hot surfaces, open flame or sparks, a fire or explosion may occur. See section 2.4.

3.14 Ground Fault Equipment Protection Devices (GFEEDs): **WARNING!** Fire and Shock Hazard. To minimize the danger of fire if the heating cable of a Multitube bundle is damaged or improperly installed, use a Ground Fault Equipment Protection Device. Electrical fault currents may be insufficient to trip a conventional circuit breaker. For ground fault protection, the IEEE 515: ([www.ansi.org](http://www.ansi.org)) standard for heating cables recommends the use of GFEEDs with a nominal 30 milliampere trip level for "piping systems in classified areas, those areas requiring a high degree of maintenance, or which may be exposed to physical abuse or corrosive atmospheres".

### 4.0 TUBE AND FITTINGS ASSEMBLY AND INSTALLATION INSTRUCTIONS

4.1 Component Inspection: Prior to assembly, a careful examination of the Tube and Fittings must be performed. All components must be checked for correct style, size, material, seal, and length. Inspect the Fitting and sealing surfaces for burrs, nicks, corrosion, missing seal or other imperfections. Do NOT use any component that displays any signs of nonconformance.

4.2 Tube and Fitting Assembly: Do not assemble a Parker Fitting with a Tube that is not specifically listed by Parker for that Fitting, unless authorized in writing by the engineering manager or chief engineer of the appropriate Parker division. The Tube must meet the requirements specified to the Fitting.

The Parker published instructions must be followed for assembling the Fittings to a Tube. These instructions are provided in the Parker Fitting catalog for the specific Parker Fitting being used, or by calling 1-800-CPARKER, or at [www.parker.com](http://www.parker.com).

4.3 Related Accessories: Do not preset or flange Parker Fitting components using another manufacturer's equipment or procedures unless authorized in writing by the engineering manager or chief engineer of the appropriate Parker division. Tube, Fitting component and tooling must be checked for correct style, size and material. Operation and maintenance of Related Accessories must be in accordance with the operation manual for the designated Accessory.

4.4 Securement: In many applications, it may be necessary to restrain, protect, or guide the Tube to protect it from damage by unnecessary flexing, pressure surges, vibration, and contact with other mechanical components. Care must be taken to insure such restraints do not introduce additional stress or wear points.

4.5 Proper Connection of Ports: Proper physical installation of the Tube Assembly requires a correctly installed port connection insuring that no torque is transferred to the Tube when the Fittings are being tightened or otherwise during use.

4.6 External Damage: Proper installation is not complete without insuring that tensile loads, side loads, flattening, potential abrasion,



thread damage or damage to sealing surfaces are corrected or eliminated. See instruction 2.10.

4.7 System Checkout: All air entrapment must be eliminated and the system pressurized to the maximum system pressure (at or below the Tube Assembly maximum working pressure) and checked for proper function and freedom from leaks. Personnel must stay out of potential hazardous areas while testing and using.

4.8 Routing: The Tube Assembly should be routed in such a manner so if a failure does occur, the escaping media will not cause personal injury or property damage. In addition, if fluid media comes in contact with hot surfaces, open flame or sparks, a fire or explosion may occur. See section 2.4.

## 5.0 HOSE AND FITTING MAINTENANCE AND REPLACEMENT INSTRUCTIONS

5.1 Even with proper selection and installation, Hose life may be significantly reduced without a continuing maintenance program. The severity of the application, risk potential from a possible Hose failure, and experience with any Hose failures in the application or in similar applications should determine the frequency of the inspection and the replacement for the Products so that Products are replaced before any failure occurs. Certain products require maintenance and inspection per industry requirements. Failure to adhere to these requirements may lead to premature failure. A maintenance program must be established and followed by the user and, at minimum, must include instructions 5.2 through 5.7

5.2 Visual Inspection Hose/Fitting: Any of the following conditions require immediate shut down and replacement of the Hose Assembly:

- Fitting slippage on Hose;
- Damaged, cracked, cut or abraded cover (any reinforcement exposed);
- Hard, stiff, heat cracked, or charred Hose;
- Cracked, damaged, or badly corroded Fittings;
- Leaks at Fitting or in Hose;
- Kinked, crushed, flattened or twisted Hose; and
- Blistered, soft, degraded, or loose cover.

5.3 Visual Inspection All Other: The following items must be tightened, repaired, corrected or replaced as required:

- Leaking port conditions;
- Excess dirt buildup;
- Worn clamps, guards or shields; and
- System fluid level, fluid type, and any air entrapment.

5.4 Functional Test: Operate the system at maximum operating pressure and check for possible malfunctions and leaks. Personnel must avoid potential hazardous areas while testing and using the system. See section 2.2.

5.5 Replacement Intervals: Hose assemblies and elastomeric seals used on Hose Fittings and adapters will eventually age, harden, wear and deteriorate under thermal cycling and compression set. Hose Assemblies and elastomeric seals should be inspected and replaced at specific replacement intervals, based on previous service life, government or industry recommendations, or when failures could result in unacceptable downtime, damage, or injury risk. See section 1.2. Hose and Fittings may be subjected to internal mechanical and/or chemical wear from the conveying fluid and may fail without warning. The user must determine the product life under such circumstances by testing. Also see section 2.5.

5.6 Hose Inspection and Failure: Hydraulic power is accomplished by utilizing high pressure fluids to transfer energy and do work. Hoses, Fittings and Hose Assemblies all contribute to this by transmitting fluids at high pressures. Fluids under pressure can be dangerous and potentially lethal and, therefore, extreme caution must be exercised when working with fluids under pressure and handling the Hoses transporting the fluids. From time to time, Hose Assemblies will fail if they are not replaced at proper time intervals. Usually these failures are the result of some form of misapplication, abuse, wear or failure to perform proper maintenance. When Hoses fail, generally the high pressure fluids inside escape in a stream which may or may not be visible to the user. Under no circumstances should the user attempt to locate the leak by "feeling" with their hands or any other part of their body. High pressure fluids can and will penetrate the skin and cause severe tissue damage and possibly loss of limb. Even seemingly minor hydraulic fluid injection injuries must be treated immediately by a physician with knowledge of the tissue damaging properties of hydraulic fluid.

If a Hose failure occurs, immediately shut down the equipment and leave the area until pressure has been completely released from the Hose Assembly. Simply shutting down the hydraulic pump may or may not eliminate the pressure in the Hose Assembly. Many times check

valves, etc., are employed in a system and can cause pressure to remain in a Hose Assembly even when pumps or equipment are not operating. Tiny holes in the Hose, commonly known as pinholes, can eject small, dangerously powerful but hard to see streams of hydraulic fluid. It may take several minutes or even hours for the pressure to be relieved so that the Hose Assembly may be examined safely. Once the pressure has been reduced to zero, the Hose Assembly may be taken off the equipment and examined. It must always be replaced if a failure has occurred. Never attempt to patch or repair a Hose Assembly that has failed. Consult the nearest Parker distributor or the appropriate Parker division for Hose Assembly replacement information. Never touch or examine a failed Hose Assembly unless it is obvious that the Hose no longer contains fluid under pressure. The high pressure fluid is extremely dangerous and can cause serious and potentially fatal injury.

5.7 Elastomeric seals: Elastomeric seals will eventually age, harden, wear and deteriorate under thermal cycling and compression set. Elastomeric seals should be inspected and replaced.

5.8 Refrigerant gases: Special care should be taken when working with refrigeration systems. Sudden escape of refrigerant gases can cause blindness if the escaping gases contact the eye and can cause freezing or other severe injuries if it contacts any other portion of the body.

5.9 Compressed natural gas (CNG): Parker CNG Hose Assemblies should be tested after installation and before use, and at least on a monthly basis per instructions provided on the Hose Assembly tag. The recommended procedure is to pressurize the Hose and check for leaks and to visually inspect the Hose for damage and to perform an electrical resistance test. Caution: Matches, candles, open flame or other sources of ignition shall not be used for Hose inspection. Leak check solutions should be rinsed off after use.

## 6.0 HOSE STORAGE

6.1 Age Control: Hose and Hose Assemblies must be stored in a manner that facilitates age control and first-in and first-out usage based on manufacturing date of the Hose and Hose Assemblies. Unless otherwise specified by the manufacturer or defined by local laws and regulations:

6.1.1 The shelf life of rubber hose in bulk form or hose made from two or more materials is 28 quarters (7 years) from the date of manufacture, with an extension of 12 quarters (3 years), if stored in accordance with ISO 2230.

6.1.2 The shelf life of thermoplastic and polytetrafluoroethylene hose is considered to be unlimited;

6.1.3 Hose assemblies that pass visual inspection and proof test shall not be stored for longer than 2 years.

6.1.4 Storage: Stored Hose and Hose Assemblies must not be subjected to damage that could reduce their expected service life and must be placed in a cool, dark and dry area with the ends capped. Stored Hose and Hose Assemblies must not be exposed to temperature extremes, ozone, oils, corrosive liquids or fumes, solvents, high humidity, rodents, insects, ultraviolet light, electromagnetic fields or radioactive materials.

# ENERPAC Warranty Policy

**For those ENERPAC items sold as part of the Parker Parflex Division product offering, the following warranty applies.**

ENERPAC products are warranted to be free of defects in materials and workmanship under normal use for as long as they are owned by the original purchaser, subject to the exclusions and limitations described below. This warranty does not cover ordinary wear and tear, overloading, alterations, (including repairs or attempted repairs by parties other than ENERPAC or its authorized service representatives), improper fluid, use in a manner for which they are not intended or use which is contrary to instructions for the products.

THIS WARRANTY IS LIMITED TO NEW PRODUCTS SOLD THROUGH ENERPAC AUTHORIZED DISTRIBUTORS, ORIGINAL EQUIPMENT MANUFACTURERS OR OTHER DESIGNATED CHANNELS OF DISTRIBUTION. NO AGENT, EMPLOYEE, OR OTHER REPRESENTATIVE OF ENERPAC HAS THE AUTHORITY TO IN ANY WAY CHANGE OR AMEND THIS WARRANTY.

Electronic products and components are warranted against defects in material and workmanship for a period of two years from the date of purchase.

The following items supplied with ENERPAC products are excluded from this warranty:

Components not manufactured by ENERPAC, including air motors, electric motors, gasoline engines, and diesel engines. Such items are warranted to the extent of the warranty provided by the manufacturers of such items.

If the customer believes a product is defective, the product must be delivered, or shipped freight prepaid, to the nearest ENERPAC Authorized Service Center. The customer should contact ENERPAC to locate and Authorized Service Center in the customer's area.

Products that do not conform to this warranty will be returned by ground transportation, freight prepaid.

THE FOREGOING WARRANT IS EXCLUSIVE AND IS IN LIEU OF ALL OTHER EXPRESS AND IMPLIED WARRANTIES, INCLUDING BUT NOT LIMITED TO THE IMPLIED WARRANTIES OF MERCHANTABILITY AND FITNESS FOR A PARTICULAR PURPOSE.

The remedy of repair, replacement or refund is customer's exclusive remedy in the event of breach of this warranty.

SELLER SHALL NOT BE SUBJECT TO AND DISCLAIMS:

- (a) ANY OTHER OBLIGATIONS OR LIABILITIES ARISING OUT OF BREACH OF CONTRACT OR OF WARRANTY,
- (b) ANY OBLIGATIONS WHATSOEVER ARISING FROM TORT CLAIMS (INCLUDING NEGLIGENCE AND STRICT LIABILITY) OR ARISING UNDER THEORIES OR LAW WITH RESPECT TO PRODUCTS SOLD OR SERVICES RENDERED BY SELLER OR ANY UNDERTAKINGS, ACTS OR OMISSIONS RELATING THERETO, AND
- (c) ALL CONSEQUENTIAL, INCIDENTAL AND CONTINGENT DAMAGES WHATSOEVER.

ENERPAC's liability in all cases is limited to, and shall not exceed, the purchase price paid.

For the nearest authorized ENERPAC SERVICE CENTER, please call ENERPAC at 1-800-558-0530 or visit the ENERPAC web site at [www.Enerpac.com](http://www.Enerpac.com).

# Offer of Sale

**The items described in this document and other documents or descriptions provided by Parker Hannifin Corporation, as subsidiaries and its authorized distributors are hereby offered for sale at prices to be established by Parker Hannifin Corporation, its subsidiaries and its authorized distributors. This offer and its acceptance by any customer ("Buyer") shall be governed by all of the following Terms and Conditions. Buyer's order for any such item, when communicated to Parker Hannifin Corporation, its subsidiary or an authorized distributor ("Seller") verbally or in writing, shall constitute acceptance of this offer.**

1. Terms and Conditions of Sale: All descriptions, quotations, proposals, offers, acknowledgments, acceptances and sales of Seller's products are subject to and shall be governed exclusively by the terms and conditions stated herein. Buyer's acceptance of any offer to sell is limited to these terms and conditions. Any terms or conditions in addition to, or inconsistent with those stated herein, proposed by Buyer in any acceptance of an offer by Seller, are hereby objected to. No such additional, different or inconsistent terms and conditions shall become part of the contract between Buyer and Seller unless expressly accepted in writing by Seller. Seller's acceptance of any offer to purchase by Buyer is expressly conditional upon Buyer's assent to all the terms and conditions stated herein, including any terms in addition to, or inconsistent with those contained in Buyer's offer. Acceptance of Seller's products shall in all events constitute such assent.
2. Payment: Payment shall be made by Buyer net 30 days from the date of delivery of the items purchased hereunder. Any claims by Buyer for omissions or shortages in a shipment shall be waived unless Seller receives notice thereof within 30 days after Buyer's receipt of the shipment.
3. Delivery: Unless otherwise provided on the face hereof, delivery shall be made F.O.B. Seller's plant. Regardless of the method of delivery, however, risk of loss shall pass to Buyer upon Seller's delivery to a carrier. Any delivery dates shown are approximate only and Seller shall have no liability for any delays in delivery.
4. Warranty: Seller warrants that the items sold thereunder shall be free from defects in material or workmanship for a period of 365 days from the date of shipment to Buyer, or 2,000 hours of use, whichever expires first. THIS WARRANTY COMPRISES THE SOLE AND ENTIRE WARRANTY PERTAINING TO ITEMS PROVIDED HEREUNDER. SELLER MAKES NO OTHER WARRANTY, GAURANTEE, OR REPRESENTATION OF ANY KIND WHATSOEVER. ALL OTHER WARRANTIES, INCLUDING BUT NOT LIMITED TO, MERCHANTABILITY AND FITNESS FOR PURPOSE, WHETHER EXPRESS, IMPLIED, OR ARISING BY OPERATION OF LAW, TRADE USAGE, OR COURSE OF DEALING ARE HEREBY DISCLAIMED. NOTWITHSTANDING THE FOREGOING, THERE ARE NO WARRANTIES WHATSOEVER ON ITEMS BUILT OR ACQUIRED WHOLELY OR PARTIALLY, TO BUYER'S DESIGNS OR SPECIFICATIONS.
5. Limitation Of Remedy: SELLER'S LIABILITY ARISING FROM OR IN ANY WAY CONNECTED WITH THE ITEMS SOLD OR THIS CONTRACT SHALL BE LIMITED EXCLUSIVELY TO REPAIR OR REPLACEMENT OF THE ITEMS SOLD OR REFUND OF THE PURCHASE PRICE PAID BY BUYER, AT SELLER'S SOLE OPTION. IN NO EVENT SHALL SELLER BE LIABLE FOR ANY INCIDENTAL, CONSEQUENTIAL OR SPECIAL DAMAGES OF ANY KIND OR NATURE WHATSOEVER, INCLUDING BUT NOT LIMITED TO LOST PROFITS ARISING FROM OR IN ANY WAY CONNECTED WITH THIS AGREEMENT OR ITEMS SOLD HEREUNDER, WHETHER ALLEGED TO ARISE FROM BREACH OF CONTRACT, EXPRESS OR IMPLIED WARRANTY, OR IN TORT, INCLUDING WITHOUT LIMITATION, NEGLIGENCE, FAILURE TO WARN OR STRICT LIABILITY.
6. Changes, Reschedules and Cancellations: Buyer may request to modify the designs or specifications for the items sold herunder as well as the quantities and delivery dates thereof, or may request to cancel all or part of this order, however, no such requested modification or cancellation shall become part of the contract between Buyer and Seller unless accepted by Seller in a written amendment to this Agreement. Acceptance of any such requested modification or cancellation shall be at Seller's discretion, and shall be upon such terms and conditions as Seller may require.
7. Special Tooling: A tooling charge may be imposed for any special tooling, including without limitation, dies, fixtures, molds and patterns, acquired to manufacture items sold pursuant to this contract. Such special tooling shall be and remain Seller's property notwithstanding payment of any charges by Buyer. In no event will Buyer acquire any interest in apparatus belonging to Seller which is utilized in the manufacture of the items sold hereunder, even if such apparatus has been specially converted or adapted for such manufacture and notwithstanding any charges paid by Buyer. Unless otherwise agreed, Seller shall have the right to alter, discard or otherwise dispose of any special tooling or other property in its sole discretion at any time.
8. Buyer's Property: Any designs, tools, patterns, materials, drawings, confidential information or equipment furnished by Buyer or any other items which become Buyer's property, may be considered obsolete and may be destroyed by Seller after two (2) consecutive years have elapsed without Buyer placing an order for the items which are manufactured using such property. Seller shall not be responsible for any loss or damage to such property while it is in Seller's possession or control.
9. Taxes: Unless otherwise indicated on the face hereof, all prices and charges are exclusive of excise, sales, use, property, occupational or like taxes which may be imposed by any taxing authority upon the manufacture, sale or delivery of the items sold hereunder. If any such taxes must be paid by Seller of if Seller is liable for the collection of such tax, the amount thereof shall be in addition to the amounts for the items sold. Buyer agrees to pay all such taxes or to reimburse Seller therefore upon receipt of its invoice. If Buyer claims exemption from any sales, use or other tax imposed by any taxing authority, Buyer shall save Seller harmless from and against any such tax, together with any interest or penalties thereon which may be assessed if the items are held to be taxable.
10. Indemnity For Infringement of Intellectual Property Rights: Seller shall have no liability for infringement of any patents, trademarks, copyrights, trade dress, trade secrets or similar rights except as provided in this Part 10. Seller will defend and indemnify Buyer against allegations of infringement of U.S. patents, U.S. trademarks, copyrights, trade dress and trade secrets (hereinafter "Intellectual Property Rights"). Seller will defend at its expense and will pay the cost of any settlement or damages awarded in an action brought against Buyer based on an allegation that an item sold pursuant to this contract infringes in the Intellectual Property Rights of a third party. Seller's obligation to defend and indemnify Buyer is contingent on Buyer notifying Seller within ten (10) days after Buyer becomes aware of such allegations of infringement, and Seller having sole control over the defense of any allegations or actions including all negotiations for settlement or compromise. If an item sold hereunder is subject to a claim that it infringes the Intellectual Property Rights of a third party, Seller may, at its sole expense and options, procure for Buyer the right to continue using said item, replace or modify said item so as to make it noninfringing, or offer to accept return of said item and return the purchase price less a reasonable allowance for depreciation. Notwithstanding the foregoing, Seller shall have no liability for claims of infringement based on information provided by Buyer, or directed to items delivered hereunder for which the designs are specified in whole or part by Buyer, or infringements resulting from the modification, combination or use in a system of any item sold hereunder. The foregoing provisions of this Part 10 shall constitute Seller's sole and exclusive liability and Buyer's sole and exclusive remedy for infringement of Intellectual Property Rights. If a claim is based on information provided by Buyer or if the design for an item delivered hereunder is specified in whole or in part by Buyer, Buyer shall defend and indemnify Seller for all costs, expenses or judgments resulting from any claim that such item infringes any patent, trademark, copyright, trade dress, trade secret or any similar right.
11. Force Majeure: Seller does not assume the risk of and shall not be liable for delay or failure to perform any of Seller's obligations by reason of circumstances beyond the reasonable control of Seller (hereinafter "Events of Force Majeure"). Events of Force Majeure shall include without limitation, accidents, acts of God, strikes or labor disputes, acts, laws, rules or regulations of any government or government agency, fires, floods, delays or failures in delivery of carriers or suppliers, shortages of materials and any other cause beyond Seller's control.
12. Entire Agreement/Governing Law: The terms and conditions set forth herein, together with any amendments, modifications and any different terms or conditions expressly accepted by Seller in writing, shall constitute the entire Agreement concerning the items sold, and there are no oral or other representations or agreements which pertain thereto. This Agreement shall be governed in all respects by the law of the State of Ohio. No actions arising out of the sale of the items sold hereunder or this Agreement may be brought by either party more than two (2) years after the cause of action accrues.







# Parker's Motion & Control Technologies

At Parker, we're guided by a relentless drive to help our customers become more productive and achieve higher levels of profitability by engineering the best systems for their requirements. It means looking at customer applications from many angles to find new ways to create value. Whatever the motion and control technology need, Parker has the experience, breadth of product and global reach to consistently deliver. No company knows more about motion and control technology than Parker. For further info call 1 800 C-Parker (1 800 272 7537)



## Aerospace

### Key Markets

Aftermarket services  
Commercial transports  
Engines  
General & business aviation  
Helicopters  
Launch vehicles  
Military aircraft  
Missiles  
Power generation  
Regional transports  
Unmanned aerial vehicles

### Key Products

Control systems & actuation products  
Engine systems & components  
Fluid conveyance systems & components  
Fluid metering, delivery & atomization devices  
Fuel systems & components  
Fuel tank inerting systems  
Hydraulic systems & components  
Thermal management  
Wheels & brakes



## Climate Control

### Key Markets

Agriculture  
Air conditioning  
Construction Machinery  
Food & beverage  
Industrial machinery  
Life sciences  
Oil & gas  
Precision cooling  
Process  
Refrigeration  
Transportation

### Key Products

Accumulators  
Advanced actuators  
CO<sub>2</sub> controls  
Electronic controllers  
Filter driers  
Hand shut-off valves  
Heat exchangers  
Hose & fittings  
Pressure regulating valves  
Refrigerant distributors  
Safety relief valves  
Smart pumps  
Solenoid valves  
Thermostatic expansion valves



## Electromechanical

### Key Markets

Aerospace  
Factory automation  
Life science & medical  
Machine tools  
Packaging machinery  
Paper machinery  
Plastics machinery & converting  
Primary metals  
Semiconductor & electronics  
Textile  
Wire & cable

### Key Products

AC/DC drives & systems  
Electric actuators, gantry robots & slides  
Electrohydraulic actuation systems  
Electromechanical actuation systems  
Human machine interface  
Linear motors  
Stepper motors, servo motors, drives & controls  
Structural extrusions



## Filtration

### Key Markets

Aerospace  
Food & beverage  
Industrial plant & equipment  
Life sciences  
Marine  
Mobile equipment  
Oil & gas  
Power generation & renewable energy  
Process  
Transportation  
Water Purification

### Key Products

Analytical gas generators  
Compressed air filters & dryers  
Engine air, coolant, fuel & oil filtration systems  
Fluid condition monitoring systems  
Hydraulic & lubrication filters  
Hydrogen, nitrogen & zero air generators  
Instrumentation filters  
Membrane & fiber filters  
Microfiltration  
Sterile air filtration  
Water desalination & purification filters & systems



## Fluid & Gas Handling

### Key Markets

Aerial lift  
Agriculture  
Bulk chemical handling  
Construction machinery  
Food & beverage  
Fuel & gas delivery  
Industrial machinery  
Life sciences  
Marine  
Mining  
Mobile  
Oil & gas  
Renewable energy  
Transportation

### Key Products

Check valves  
Connectors for low pressure fluid conveyance  
Deep sea umbilicals  
Diagnostic equipment  
Hose couplings  
Industrial hose  
Mooring systems & power cables  
PTFE hose & tubing  
Quick couplings  
Rubber & thermoplastic hose  
Tube fittings & adapters  
Tubing & plastic fittings



## Hydraulics

### Key Markets

Aerial lift  
Agriculture  
Alternative energy  
Construction machinery  
Forestry  
Industrial machinery  
Machine tools  
Marine  
Material handling  
Mining  
Oil & gas  
Power generation  
Refuse vehicles  
Renewable energy  
Truck hydraulics  
Turf equipment

### Key Products

Accumulators  
Cartridge valves  
Electrohydraulic actuators  
Human machine interfaces  
Hybrid drives  
Hydraulic cylinders  
Hydraulic motors & pumps  
Hydraulic systems  
Hydraulic valves & controls  
Hydrostatic steering  
Integrated hydraulic circuits  
Power take-offs  
Power units  
Rotary actuators  
Sensors



## Pneumatics

### Key Markets

Aerospace  
Conveyor & material handling  
Factory automation  
Life science & medical  
Machine tools  
Packaging machinery  
Transportation & automotive

### Key Products

Air preparation  
Brass fittings & valves  
Manifolds  
Pneumatic accessories  
Pneumatic actuators & grippers  
Pneumatic valves & controls  
Quick disconnects  
Rotary actuators  
Rubber & thermoplastic hose & couplings  
Structural extrusions  
Thermoplastic tubing & fittings  
Vacuum generators, cups & sensors



## Process Control

### Key Markets

Alternative fuels  
Biopharmaceuticals  
Chemical & refining  
Food & beverage  
Marine & shipbuilding  
Medical & dental  
Microelectronics  
Nuclear Power  
Offshore oil exploration  
Oil & gas  
Pharmaceuticals  
Power generation  
Pulp & paper  
Steel  
Water/wastewater

### Key Products

Analytical Instruments  
Analytical sample conditioning products & systems  
Chemical injection fittings & valves  
Fluoropolymer chemical delivery fittings, valves & pumps  
High purity gas delivery fittings, valves, regulators & digital flow controllers  
Industrial mass flow meters/controllers  
Permanent no-weld tube fittings  
Precision industrial regulators & flow controllers  
Process control double block & bleeds  
Process control fittings, valves, regulators & manifold valves



## Sealing & Shielding

### Key Markets

Aerospace  
Chemical processing  
Consumer  
Fluid power  
General industrial  
Information technology  
Life sciences  
Microelectronics  
Military  
Oil & gas  
Power generation  
Renewable energy  
Telecommunications  
Transportation

### Key Products

Dynamic seals  
Elastomeric o-rings  
Electro-medical instrument design & assembly  
EMI shielding  
Extruded & precision-cut, fabricated elastomeric seals  
High temperature metal seals  
Homogeneous & inserted elastomeric shapes  
Medical device fabrication & assembly  
Metal & plastic retained composite seals  
Shielded optical windows  
Silicone tubing & extrusions  
Thermal management  
Vibration dampening

ENGINEERING YOUR SUCCESS.

# Parker Fluid Connectors Group

## North American Divisions & Distribution Service Centers

**Your complete source** for quality tube fittings, hose & hose fittings, brass & composite fittings, quick-disconnect couplings, valves and assembly tools, locally available from a worldwide network of authorized distributors.

### **Fittings:**

Available in inch and metric sizes covering SAE, BSP, DIN, GAZ, JIS and ISO thread configurations, manufactured from steel, stainless steel, brass, aluminum, nylon and thermoplastic.

### **Hose, Tubing and Bundles:**

Available in a wide variety of sizes and materials including rubber, wire-reinforced, thermoplastic, hybrid and custom compounds.

### **Worldwide Availability:**

Parker operates Fluid Connectors manufacturing locations and sales offices throughout North America, South America, Europe and Asia-Pacific.

**For information,** call toll free...

**1-800-C-PARKER**  
**(1-800-272-7537)**

## **North American Divisions**

### **Fluid System Connectors Division**

Otsego, MI  
phone 269 694 9411  
fax 269 694 4614

### **Hose Products Division**

Wickliffe, OH  
phone 440 943 5700  
fax 440 943 3129

### **Industrial Hose Division**

Wickliffe, OH  
phone 440 833 2120  
fax 440 833 2230

### **Parflex Division**

Ravenna, OH  
phone 330 296 2871  
fax 330 296 8433

### **Quick Coupling Division**

Minneapolis, MN  
phone 763 544 7781  
fax 763 544 3418

### **Tube Fittings Division**

Columbus, OH  
phone 614 279 7070  
fax 614 279 7685

## **Distribution Service Centers**

### **Buena Park, CA**

phone 714 522 8840  
fax 714 994 1183

### **Conyers, GA**

phone 770 929 0330  
fax 770 929 0230

### **Louisville, KY**

phone 502 937 1322  
fax 502 937 4180

### **Portland, OR**

phone 503 283 1020  
fax 503 283 2201

### **Toledo, OH**

phone 419 878 7000  
fax 419 878 7001  
fax 419 878 7420  
(FCG Kit Operations)

### **Canada**

#### **Grimsby, ONT**

phone 905 945 2274  
fax 905 945 3945  
(Contact Grimsby for other Service Center locations.)

